

Pompe acqua, Water pumps, Wasserpumpen,  
Pompes à eau, Bombas de agua,  
Bombas de água, Αντλίες νερού, Pompy wody,  
Водяные насосы, Su pompalari



**MAGNETI  
MARELLI**

**checkstar**  
SERVICE NETWORK

*Indice*  
*Contents*  
*Inhaltsverzeichnis*  
*Sommaire*  
*Indice*  
*Indice*  
*Περιεχόμενα*  
*Spis treści*  
*Содержание*  
*Общие характеристики*

Legenda  
 Legend  
 Erläuterung  
 Légende  
 Leyenda  
 Legenda  
 Ευρετήριο  
 Legenda  
 Легенда  
 Gösterge

2

Applicazione per marca e veicolo  
 Vehicle application guide  
 Zuordnung nach Marke und Fahrzeug  
 Affectations par marques et véhicules  
 Aplicación por marca y vehículo  
 Aplicação por marca e veículo  
 Εφαρμογή ανα μοντέλο  
 Zastosowanie dla marki i pojazdu  
 Применение  
 Marka ve otomobile göre uygulama

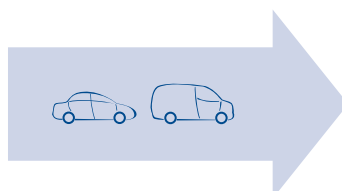

9

Applicazione per codice  
 Buyers guide  
 Zuordnung nach Bestellnummer  
 Affectations par références  
 Aplicación por código  
 Aplicação por código  
 Εφαρμογες ανα κώδικο  
 Zastosowanie dla kodu  
 Применение для кода  
 Şifreye göre uygulama

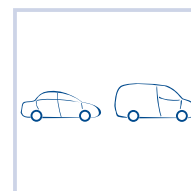

223

Tavole di comparazione  
 Cross reference guide  
 Gegenüberstellung  
 Table de correspondance OE  
 Tabla de equivalencias  
 Tabela de equivalências  
 Πίνακας αντιστοιχιών  
 Tabela porównawcza  
 Кросс-таблица  
 Karşılaştırma



411

*Legenda*  
*Legend*  
*Erläuterung*  
*Légende*  
*Leyenda*  
*Legenda*  
*Ευρετήριο*  
*Legenda*  
*Легенда*  
*Gösterge*



Costruttore e modello  
 Make and model  
 Hersteller und Modell  
 Constructeur et modèle  
 Constructor y modelo  
 Montadora e modelo  
 Μάρκα και οντέλο  
 Producent i model  
 Сделано и моделировано  
 Üretici ve model

**kW**  
 Potenza kw  
 Output kw  
 Leistung kw  
 Puissance kw  
 Potencia kw  
 Potência kw  
 Απόδοση kw  
 Мοc kw  
 Мощность kb  
 Güç



Anno di produzione  
 Manufacturing year  
 Baujahr  
 Date de fabrication  
 Año de fabricación  
 Ano de fabricação  
 Έτος εφαρμογής  
 Rok produkcji  
 Год производства  
 Üretim yılı

**Cap. Cm<sup>3</sup>**  
 Cilindrata cm<sup>3</sup>  
 Capacity cm<sup>3</sup>  
 Hubraum cm<sup>3</sup>  
 Cylindrée en cm<sup>3</sup>  
 Cilindrada cm<sup>3</sup>  
 Cilindrada cm<sup>3</sup>  
 Χωριτικήτητα cm<sup>3</sup>  
 Pojemność w cm<sup>3</sup>  
 Объем (cm<sup>3</sup>)  
 Kapasite cm<sup>3</sup>

**Fuel**  
 Tipo di carburante  
 Fuel supply  
 Kraftstoffversorgung  
 Type de carburant  
 Tipo de combustible  
 Tipo de combustível  
 Τύπο καυσίμου  
 Rodzaj paliwa  
 Тип топлива  
 Yakıt tipi

**Gear**  
 Tipo di cambio  
 Type of gear  
 Art des schaltgetriebes  
 Type de boîte de vitesse  
 Tipo de cambio  
 Tipo de caixa de velocidades  
 Τύπος ταχυτήτων  
 Typ skrzyni biegów  
 Тип коробки передач  
 Vites tipi

**BF** Benzina - Petrol - Benzin -  
 Essence - Gasolina

**B** Bi-fuel - Bi-fuel - Bi-fuel -  
 Bi-fuel - Bi-fuel

**D** Diesel - Diesel - Diesel - Diesel -  
 Gaz natural

**M** Manuale - Manual - Manuell  
 Manuel - Manuale

**A** Automatico - Automatic - Automatisch  
 Automatique - Automático

**A/M** Manuale/Automatico - Manual/Automatic  
 Manuell/Automatisch - Manuel/Automatique  
 Manuale/Automático

**No. of cyl.**  
 Numero cilindri  
 Number of cylinders  
 Anzahl der zylinder  
 Nombre de cylindres  
 Numero de cilindros  
 Número de cilindros  
 Αριθμός κυλινδρών  
 Liczba cylindrów  
 Количество цилиндров  
 SİLİNDİR SAYISI

**No. of valves**  
 N. Valvole  
 No. Of valves  
 Anzahl ventile  
 Nombre de soupapes  
 Nº válvulas  
 Nº de válvulas  
 Αριθμός βαλβίδων  
 Liczba zaworów  
 Количество лопастей  
 Valf sayisi

<p><b>Motor code</b></p>	<p>Codice motore Engine code Motor code Code moteur Código motor Código motor Κωδικός κινητήρα Kod silnika Номер двигателя Motor numarası</p>	<p><i>i</i></p>	<p>Note Note Anmerkungen Notes Notas Notas Σημείωση Uwagi отметки Not</p>
	<p>Codice Magneti Marelli Magneti Marelli references Magneti Marelli Nr. Référence Magneti Marelli Código Magneti Marelli Código Magneti Marelli Κωδικός Magneti Marelli Kod Magneti Marelli Коды Magneti Marelli Magneti Marelli Şifreleri</p>	<p><b>O.E.</b></p>	<p>Codice costruttore O.E. Reference Herstellernummer Référence origine Código constructor Código montadora Κωδικός κατασκευαστή Kod O.E. Оригинальные коды Üretici şifresi</p>
<p><b>+ COP</b></p>	<p>con coperchio with backhousing mit Anbaugehäuse avec carter arriere con tapa sim tapa</p>	<p><b>- COP</b></p>	<p>senza coperchio without backhousing ohne Anbaugehäuse sans carter arriere sin tapa sem tapa</p>
<p><b>AC</b></p>	<p>Aria Condizionata Air conditioning Klimaanlage Air conditionné Aire acondicionado ar condicionado</p>	<p><b>C</b></p>	<p>Cambio n° Gear no. getriebe no. boîte de vitesse nr. Cambio n. Câmbio n.</p>
<p><b>CG</b></p>	<p>contagiri rev counter drehzahlmesser compte-tours cuentarrevoluciones conta-rotações</p>	<p><b>CGE</b></p>	<p>contagiri elettronico electronic rev counter elektronischer drehzahlmessere compte-tours électronique cuentarrevoluciones electrónico Tacômetro eletrônicos</p>
<p><b>CGM</b></p>	<p>contagiri meccanico mechanical rev counter mechanischer drehzahlmessere compte-tours mécanique cuentarrevoluciones mecánico Tacômetro mecânico eletrônico</p>	<p><b>CR</b></p>	<p>Cuscinetto rinforzato reinforced bearing verstärktes kugellager roulment renforcé rodamiento reforzada rolamento reforçado</p>
<p><b>M</b></p>	<p>Motore n° engine No. motor nr. moteur n. motor n. n.º motor</p>	<p><b>MAT AI</b></p>	<p>Materiale: Alluminio material: aluminium material: aluminium matériel: aluminium material: aluminio Material de aluminio</p>

**MAT Gh**

Materiale: Ghisa  
Material: cast iron  
Material: roheisen  
Matériel: fonte  
material arrabio  
material fundido

**OEM**

Originale n°  
Original  
Erstausrüstung No.  
première monte No.  
origen No.  
Primeira instalação No.

**SS**

Servosterzo  
power-steering  
servolenkung  
direction assistée  
servo direccion  
Direção hidráulica

**T**

Telaio n°  
chassis no.  
fahrzeugestell nr  
chassis n.  
bastidor n.  
Número do chassi

**VA**

Ventilatore Automatico  
automatic ventilator  
automatischer ventilator  
ventilateur automatique  
ventilador automático  
ventilador automático

**VF**

Ventilatore Fisso  
fixed ventilator  
fixierter ventilator  
ventilateur fixe  
ventilador fijo  
controlo do ventilador

Magneti Marelli After Market Parts and Services S.p.A. ha curato con particolare attenzione la stesura del presente catalogo; declina comunque ogni responsabilità per eventuali errori od omissioni relativi a schemi, disegni, corrispondenze con i codici O.E. ecc. e si riserva il diritto di apportare modifiche al contenuto senza l'obbligo di darne preventiva comunicazione. Sono particolarmente graditi, da parte degli utenti, commenti, segnalazioni di inesattezze e qualsiasi altro suggerimento atto a rendere più efficace la prossima edizione del catalogo.

Magneti Marelli After Market Parts and Services S.p.A. has devoted its best attention to the editing of this catalogue; it nevertheless declines any responsibility for possible mistakes or omissions regarding figures, drawings, correspondence with O.E. codes etc. and it reserves the right to modify the contents without prior notice. Users' comments, reports of inaccuracies or any other suggestions which may in any way improve the next edition of this catalogue are warmly welcomed.

Magneti Marelli After Market Parts and Services S.p.A. hat diesen Katalog sorgfältig verfasst. Die Firma enthebt sich jeglicher Verantwortung für eventuelle Fehler oder Auslassungen hinsichtlich Schemen, Zeichnungen, Übereinstimmungen mit O.E. Codes usw. und behält sich das Recht vor, ohne Ankündigung, am Inhalt Veränderungen vorzunehmen. Anmerkungen, Fehlerhinweise und weitere Anregungen seitens der Kunden werden gerne entgegengenommen, um die nächste Ausgabe des Katalogs effizienter zu gestalten.

Magneti Marelli After Market Parts and Services S.p.A. a soigné avec une attention particulière la rédaction de ce catalogue; elle décline cependant toute responsabilité pour toute erreur ou omission éventuelle dans les schémas, les dessins, les correspondances avec les codes O.E., etc. et se réserve le droit d'en modifier le contenu sans obligation de communication préalable. Les commentaires, les signalisations d'inexactitudes et toute autre suggestion des utilisateurs susceptibles de rendre la prochaine rédaction du catalogue plus efficace seront particulièrement appréciés.

Magneti Marelli After Market Parts and Services S.p.A. ha cuidado con especial atención la redacción del presente catálogo; de todas maneras declina toda responsabilidad por eventuales errores o omisiones relativos a esquemas, diseños, correspondencia con los códigos O.E., etc., y se reserva el derecho de aportar modificaciones al contenido sin la obligación de previo aviso. Se agradecen especialmente los comentarios, las indicaciones de inexactitudes y cualquier otra sugerencia por parte de los usuarios que sean útiles para hacer más eficaz la próxima edición del catálogo.

Magneti Marelli After Market Parts and Services S.p.A. cuidou com particular atenção a redação do presente catálogo; como quer que seja, rejeita qualquer responsabilidade face a eventuais erros o omissões relacionados aos esquemas, desenhos, correspondências aos códigos O.E. etc. e reserva-se o direito de introduzir alterações ao seu conteúdo sem a obrigação de comunicação prévia das mesmas. São particularmente bem aceitos, comentários, sinalizações de inexatidões e qualquer outra sugestão idônea a tornar mais eficaz a próxima edição do catálogo.

Η Magneti Marelli After Market Parts and Services S.p.A. φροντισε με καθε λεπτομερεια την ορθοτητα των στοιχειων αυτου του καταλογου, δεν φερει ομως καμια ευθυνη για τυχον λαθη ή παραληψεις που σχετιζονται με σχηματα, σχεδια, αντιστοιχιες με γνησια νουμερα κτλ. και επιφυλασσειται του δικαιωματος να αλλαξει το περιεχομενο του καταλογου οποιαδηποτε στιγμη χωρις προτερη ενημερωση. Οποιαδηποτε σχολια η παρατηρησεις, με στοχο την βελτιωση του καταλογου, ειναι ευπροσδεκτα.

Firma Magneti Marelli After Market Parts and Services S.p.A. dołożyła szczególnych starań przy opracowywaniu niniejszego katalogu. Nie ponosi ona jednak żadnej odpowiedzialności za ewentualne błędy lub braki dotyczące schematów, rysunków, zgodności z kodami O.E., itp. u. Firma Magneti Marelli After Market Parts and Services S.p.A. zastrzega sobie prawo do wprowadzania zmian bez obowiązku uprzedniego powiadomienia o tym. Szczególnie mile widziane są komentarze i sygnały dotyczące nieprawidłowości oraz jakiegokolwiek inne sugestie zgłaszane przez klientów, mające na celu udoskonalenie następnych edycji katalogu.

Magneti Marelli After Market Parts and Services S.p.A. уделило много времени и внимания редактированию этого каталога; Magneti Marelli After Market Parts and Services S.p.A. не несёт ответственности за возможные ошибки или упущения относительно фигур, рисунков, сочетания с кодами O.E. и т.д. и резервирует право изменить содержание без предшествующего уведомления. Комментарии пользователей, сообщения погрешностей или любые другие предложения, которые, возможно, никогда не улучшают следующий выпуск этого каталога, тепло приветствуются.

Magneti Marelli After Market Parts and Services S.p.A., mevcut katalogdaki yazıyı çok özenli bir şekilde hazırlamıştır; O.E. vs. şifrelerine karşılık gelen her türlü model ve tasarım ile ilgili olası eksiklikler ve hatalar ile ilgili sorumluluğunun altını çizer ve öncesinde haber verme zorunluluğu olmaksızın değişiklik yapma hakkını saklı tutar. Kullanıcı tarafından yorumların, eksikliklerin ve her türlü önerilerin belirtilmesi, bir sonraki katalog baskısını daha etkili hale getirecektir.

È vietata la riproduzione, anche parziale, del contenuto del presente catalogo senza preventiva autorizzazione scritta della Magneti Marelli After Market Parts and Services S.p.A., che tutelerà i propri diritti a termine di legge.

It is forbidden to reproduce, even partially, the contents of this catalogue without prior written consent from Magneti Marelli After Market Parts and Services S.p.A., who will protect its rights in accordance with the law.

Die Vervielfältigung, auch teilweise, des urheberrechtlich geschützten Inhalts des vorliegenden Katalogs ist ohne schriftliche Genehmigung durch Magneti Marelli After Market Parts and Services S.p.A. untersagt.

Il est interdit de reproduire même partiellement le contenu de ce catalogue sans autorisation écrite préalable de Magneti Marelli After Market Parts and Services S.p.A., qui protégera ses droits selon les termes de la loi.

Está prohibida la reproducción, total o parcial, del contenido del presente catálogo sin previa autorización escrita de Magneti Marelli After Market Parts and Services S.p.A., que protegerá sus propios derechos con arreglo a la ley.

É proibida a reprodução, também parcial, do conteúdo do presente catálogo sem a prévia autorização escrita de Magneti Marelli After Market Parts and Services S.p.A., que defenderá os próprios direitos, nos termos de lei.

Απαγορεύεται η αναπαραγωγή, ολική ή μερική, του περιεχομένου του παρόντος καταλόγου χωρίς την γραπτή εξουσιοδότηση της Magneti Marelli S.p.A

Zabronina jest nawet częściowa reprodukcja zawartości katalogu bez uprzedniej pisemnej autoryzacji ze strony firmy Magneti Marelli After Market Parts and Services S.p.A., która chroni swą własność zgodnie z przepisami prawa.

Запрещается воспроизводить, даже частично, содержание этого каталога без предварительного письменного согласия от Magneti Marelli S.p. A., которая будет защищать свои права в соответствии с законом.

Tüm yasal hakların sahibi olan Magneti Marelli After Market Parts and Services S.p.A.'ın yazılı izni olmaksızın mevcut kataloğun kısmen de olsa çoğaltılması yasaktır.

La corrispondenza dovrà essere inviata a:  
Correspondence should be sent to:  
Der Briefverkehr ist zu richten an:  
Envoyer la correspondance à:  
La correspondencia debe ser enviada a:  
La correspondência deverá ser enviada a:  
Η αλληλογραφία θα πρέπει να αποστέλεται:  
Korespondencję należy przesyłać na adres:  
Соответствующую корреспонденцию просим присылать по адресу:

MAGNETI MARELLI AFTER MARKET  
PARTS AND SERVICE S.P.A.  
Viale Aldo Borletti, 61/63  
20011 Corbetta (Milano) Italia  
Tel. +39 02 972 27 400  
Fax +39 02 972 27 234





***Applicazione per marca e veicolo***  
***Vehicle application guide***  
***Zuordnung nach Marke und Fahrzeug***  
***Affectations par marques et véhicules***  
***Aplicación por marca y vehículo***  
***Aplicação por marca e veículo***  
***Εφαρμογή ανα μοντέλο***  
***Zastosowanie dla marki i pojazdu***  
***Применение***  
***Marka ve otomobile göre uygulama***

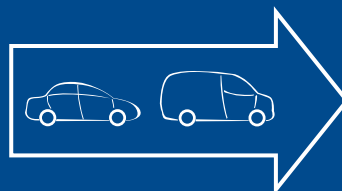



	kw		Cap. cm3	Fuel	Gear	No. of cyl.	No. of valves	Motor code		Short
--	----	--	----------	------	------	-------------	---------------	------------	--	-------

## ACURA

### CL

2.2	108	10/96→09/97	2.156	B	M	4	16	F22B2		81708
2.3 Vtec	112	10/98→09/00	2.254	B	M	4	16	F23A7		81708

### INTEGRA

1.8 LS	125	10/93→09/01	1.797	B	M	4	16	F18C1		81839
--------	-----	-------------	-------	---	---	---	----	-------	--	-------

### SLX

3.5 4 ruote motrici	151	11/97→09/99	3.474	B	M	6	24	C35A5		81848
---------------------	-----	-------------	-------	---	---	---	----	-------	--	-------

## ALFA ROMEO

### 33 - 33 SPORTWAGON I

1.2	50	06/83→12/89	1.186	B	M	4	8	AR30585		11706T
1.3	55	06/83→12/89	1.351	B	M	4	8	AR30502, AR30586		11706T
	58	05/83→12/89	1.351	B	M	4	8	AR30502		11706T
	63	10/84→12/89	1.351	B	M	4	8	AR30168, AR30587		11706T
1.3 i.e.	66	05/83→12/89	1.351	B	M	4	8	AR30168		11706T
1.4	66	01/84→12/88	1.351	B	M	4	8			11706T
1.5	62	06/83→12/85	1.490	B	M	4	8	AR30143, AR30504		11706T
	66	06/83→12/86	1.490	B	M	4	8	AR30520		11706T
	70	05/83→12/93	1.490	B	M	4	8	AR30182, AR30514		11706T
	75	07/86→12/89	1.490	B	M	4	8	AR30588		11706T
	77	12/86→12/89	1.490	B	M	4	8	AR30146, AR30508, AR30588		11706T
1.5 4x4	62	11/83→12/84	1.490	B	M	4	8	AR30504		11706T
	66	09/84→12/86	1.490	B	M	4	8	AR30520		11706T
	70	01/84→12/89	1.490	B	M	4	8	AR30182, AR30514		11706T
	75	07/86→12/89	1.490	B	M	4	8	AR30588		11706T
	77	09/86→12/89	1.490	B	M	4	8	AR30146, AR30508, AR30588		11706T
1.5 QV	77	06/84→12/89	1.490	B	M	4	8	AR30146, AR30508, AR30588		11706T
1.7	87	01/86→12/89	1.712	B	M	4	8	AR30550		11706T
	95	01/86→12/89	1.712	B	M	4	8			11706T
1.7 i.e.	77	09/88→12/89	1.712	B	M	4	8	AR30558		11706T
1.7 i.e. 4x4	77	09/88→12/89	1.712	B	M	4	8	AR30558		11706T
1.7 QV	84	03/88→12/89	1.712	B	M	4	16	AR30550		11706T

### 33 - 33 SPORTWAGON II

1.4	58	06/91→09/94	1.351	B	M	4	8			11706T
1.4 i.e.	65	06/91→09/94	1.351	B	M	4	8	AR30753, AR30755		11706T
	66	06/91→09/94	1.351	B	M	4	8	AR30753, AR30755		11706T
1.4 i.e. 4x4	66	06/91→09/94	1.351	B	M	4	8	AR30587, AR30755		11706T
1.5	77	01/90→04/93	1.490	B	M	4	8	AR30734		11706T
1.5 i.e	71	01/90→09/94	1.490	B	M	4	8	AR30751		11706T
	74	07/90→08/91	1.490	B	M	4	8	AR30750		11706T
1.7 16V	95	01/90→09/94	1.712	B	M	4	16	AR30747		11706T
	97	01/90→09/94	1.712	B	M	4	16	AR30747		11706T
	101	01/90→03/92	1.712	B	M	4	16	AR30746		11706T
1.7 16V 4x4	95	01/90→09/94	1.712	B	M	4	16	AR30747		11706T
	97	01/90→09/94	1.712	B	M	4	16	AR30747		11706T
	101	01/90→09/94	1.712	B	M	4	16	AR30746		11706T

	kw		Cap. cm3	Fuel	Gear	No. of cyl.	No. of valves	Motor code		Short
--	----	--	----------	------	------	-------------	---------------	------------	--	-------

## ALFA ROMEO

### 33 - 33 SPORTWAGON II

1.7 i.e.	77	04/92→09/94	1.712	B	M	4	8	AR30737, AR30737A		11706T
	79	01/90→03/92	1.712	B	M	4	8	AR30736, AR30737		11706T
1.7 i.e. 4x4	79	01/90→03/92	1.712	B	M	4	8	AR30736, AR30737		11706T
1.8 TD	62	07/90→09/94	1.779	D	M	3	6	VM96A		81302

### 75

1.6	81	05/89→02/92	1.567	B	M	4	8	AR61101		11701/T
1.8	90	08/89→02/92	1.779	B	M	4	8	AR61201		11701/T
	95	08/89→02/92	1.773	B	M	4	8	AR67101		11701/T
	95	05/89→12/92	1.779	B	M	4	8	AR61202		11701/T
2.0 T.S.	107	01/87→02/92	1.962	B	M	4	8	AR06166, AR06224		11701/T
	109	05/85→02/92	1.962	B	M	4	8	AR06224		11701/T
	109	01/87→12/88	1.962	B	M	4	8	AR06224		11701/T
2.0 TD	70	05/85→09/92	1.995	D	M	4	8	VM80A		11713
2.4 TD	82	01/89→02/92	2.393	D	M	4	8	VM81A		11713
2.5 V6	115	05/85→08/86	2.492	B	M	6	12	AR01646, AR01911	BC	11707
2.5 V6 Cat.	113	09/86→04/89	2.492	B	M	6	12	AR01648	BC	11707
3.0 V6	136	01/87→02/92	2.959	B	M	6	12	AR06120, AR06124	BC	11707
	141	02/90→02/92	2.959	B	M	6	12	AR61503		19532/E

### 145

1.4 i.e.	66	07/94→12/96	1.351	B	M	4	8	AR33501	07-1994→, →09-1996	11706T
1.4 i.e. 16V T.S.	76	12/96→01/01	1.370	B	M	4	16	AR33503, AR38501		81331
1.6 i.e.	76	10/94→12/96	1.596	B	M	4	8	AR33201		11706T
1.6 i.e. 16V T.S.	88	12/96→01/01	1.598	B	M	4	16	AR38201, AR67601		81348
1.7 i.e. 16V	95	10/94→12/96	1.712	B	M	4	16	AR33401		11706T
1.8 i.e. 16V T.S.	103	12/96→12/98	1.747	B	M	4	16	AR38401, AR67106		81331
1.9 D	68	07/94→02/99	1.929	D	M	4	8	AR67501	(-)COP, 10-1994→, →02-1999	81326
	68	07/94→02/99	1.929	D	M	4	8	AR67501	(+)COP, 10-1996→, →02-1999	81328
	68	07/94→02/99	1.929	D	M	4	8	AR67501	(-)COP, 10-1996→, →02-1999	81363
	68	07/94→02/99	1.929	D	M	4	8	AR67501	(+)COP, 10-1994→, →09-1996	81464
1.9 JTD	77	02/99→01/01	1.910	D	M	4	8	AR32302		81352
1.9 TD	66	10/94→02/99	1.929	D	M	4	8	AR33601, AR67501	(-)COP, 10-1994→, →02-1999	81326
	66	10/94→02/99	1.929	D	M	4	8	AR33601, AR67501	(+)COP, 10-1996→, →02-1999	81328
	66	10/94→02/99	1.929	D	M	4	8	AR33601, AR67501	(-)COP, 10-1996→, →02-1999	81363
	66	10/94→02/99	1.929	D	M	4	8	AR33601, AR67501	(+)COP, 10-1994→, →09-1996	81464
2.0 16V Quadrifoglio	114	03/98→01/01	1.970	B	M	4	16	AR32301		81331
2.0 16V T.S.	110	10/95→01/01	1.970	B	M	4	16	AR67204		81331

	kW		Cap. cm3	Fuel	Gear	No. of cyl.	No. of valves	Motor code		Short
--	----	--	----------	------	------	-------------	---------------	------------	--	-------

## ALFA ROMEO

### 147

1.6 16V T.SPARK	88	01/01	1.598	B	M	4	16	AR32104		81331
1.6 16V T.SPARK ECO	77	01/01	1.598	B	M	4	16	AR37203		81331
1.9 JTD	74	06/03	1.910	D	M	4	8	182B9.000		81352
	85	04/01	1.910	D	M	4	8	937A2.000		81352
1.9 JTD 16V	93	09/03→09/04	1.910	D	M	4	16	937A4.000		81872
	100	10/04	1.910	D	M	4	16	192B1.000		81872
	103	11/02	1.910	D	M	4	16	192A5.000		81872
1.9 JTDM 16V	85	10/04	1.910	D	M	4	16			81352
	110	07/05	1.910	D	M	4	16	937A5.000		81872
	125	06/08	1.910	D	M	4	16			81872
1.9 JTDM 8V	88	07/05	1.910	D	M	4	8	937A3.000		81352
2.0	121	07/02→05/05	1.970	B	M	4	16	937A1.000		81331
2.0 16V T.SPARK	110	01/01	1.970	B	AM	4	16	AR32310		81331
3.2 GTA	184	02/03	3.179	B	M	6	24	932A.000		81355

### 155

1.6 16V T.S.	88	05/96→12/97	1.598	B	M	4	16	AR67601	05-1996→	81348
1.7 T.S.	83	04/93→04/96	1.748	B	M	4	8	AR67103		11708T
	85	04/93→04/96	1.748	B	M	4	8	AR67105		11708T
1.7 T.S. 16V	103	05/96→12/97	1.747	B	M	4	16	AR67106	05-1996→	81348
1.8 T.S.	77	02/92→12/97	1.756	B	M	4	8	AR67402	07-1993→, →04-1996	11708T
	95	02/92→06/93	1.773	B	M	4	8	AR67101	03-1992→, →06-1993	11708T
1.8 T.S. Sport	93	01/92→12/96	1.773	B	M	4	8	AR67101, AR67102	07-1993→, →04-1996	11708T
1.9 TD	66	04/93→12/97	1.929	D	M	4	8	AR67501	(-)COP, 04-1993→, →02-1996	81326
	66	04/93→12/97	1.929	D	M	4	8	AR67501	(+)COP, 02-1996→, →12-1997	81328
	66	04/93→12/97	1.929	D	M	4	8	AR67501	(-)COP, 02-1996→, →12-1997	81363
	66	04/93→12/97	1.929	D	M	4	8	AR67501	(+)COP, 04-1993→, →02-1996	81464
2.0 16V Turbo Q4	137	01/92→12/97	1.995	B	M	4	16	AR67203	07-1992→, →02-1996	81322
	140	01/92→12/97	1.995	B	M	4	16	AR67203	07-1992→, →02-1996	81322
2.0 T.S.	104	02/92→02/95	1.995	B	M	4	8	AR67202		11708T
	106	02/92→04/93	1.995	B	M	4	8	AR67201		11708T
2.0 T.S. 16V	110	03/95→12/97	1.970	B	M	4	16	AR67204		81331
2.5 TD	92	04/93→12/97	2.499	D	M	4	8	VM07B, VM31B	04-1993→	81302

### 156 - 156 SPORTWAGON

1.6 16V T.SPARK	88	09/97→09/05	1.598	B	M	4	16	AR32102, AR32103, AR32104, AR67601	05-2000→	81331
	88	09/97→09/05	1.598	B	M	4	16	AR32102, AR32103, AR32104, AR67601	11-1997→, →04-2000	81348
	88	05/00→05/06	1.598	B	M	4	16	AR32102, AR32103, AR32104, AR67601		81331

	kw		Cap. cm3	Fuel	Gear	No. of cyl.	No. of valves	Motor code		MAGNETI MARELLI Short
--	----	--	----------	------	------	-------------	---------------	------------	--	-----------------------

## ALFA ROMEO

### 156 - 156 SPORTWAGON

1.8 16V T.SPARK	106	09/97→10/00	1.747	B	M	4	16	AR32201		81348
	106	05/00→10/00	1.747	B	M	4	16	AR32201		81331
	103	10/00→05/06	1.747	B	M	4	16	AR32205		81348
1.9 JTD	77	09/97→10/00	1.910	D	M	4	8	AR32302		81352
	81	10/00→05/01	1.910	D	M	4	8	AR37101		81352
	85	05/01→05/06	1.910	D	M	4	8	937A2.000		81352
	110	03/05→05/06	1.910	D	M	4	16	937A5.000		81872
1.9 JTD 16V	103	11/02→05/06	1.910	D	M	4	16	192A5.000		81872
1.9 JTD 16V Q4	110	07/04→05/06	1.910	D	M	4	16	937A5.000		81872
2.0 16V T.SPARK	114	09/97→10/00	1.970	B	M	4	16	AR32301	11-1997→	81331
	110	10/00→03/02	1.970	B	M	4	16	AR32310		81331
2.0 GLX	118	11/97→04/00	1.970	B	M	4	16	AR32303		81331
2.0 JTS	122	03/02→05/06	1.970	B	M	4	16	937A1.000		81331
2.4 JTD	100	09/97→10/00	2.387	D	M	5	10	AR32501		81352
	103	10/00→05/06	2.387	D	M	5	10	839A6.000		81352
	110	03/02→05/06	2.387	D	M	5	10	841C000		81352
	129	10/03→05/06	2.387	D	M	5	20	841G.000		81872
2.5 V6 24V	140	09/97→10/00	2.492	B	M	6	24	AR32401	11-1997→	81355
	141	10/00→05/06	2.492	B	M	6	24	AR32405		81355
3.2 GTA	184	03/02→05/06	3.179	B	M	6	24	932A.000		81355

### 159 - 159 SPORTWAGON

1.8 MPI	103	03/07	1.796	B	M	4	16	939A4.000		82083
1.8 TBi	147	05/09	1.742	B	M	4	16	939B1.000		81331
1.9 JTDM 8V	85	09/05	1.910	D	M	4	8	937A7.000, 939A7.000		81352
	88	09/05	1.910	D	M	4	8	939A1.000		81352
1.9 JTDM 16V	100	09/05	1.910	D	M	4	16	937A8.000, 939A8.000		81872
	110	09/05	1.910	D	M	4	16	939A2.000		81872
1.9 JTS	118	09/05	1.859	B	M	4	16	939A6.000		81812
2.0 JTDM	100	06/10	1.956	D	M	4	16			81872
	125	05/09	1.956	D	M	4	16	939B3.000		81872
2.2 JTS	136	09/05	2.198	B	M	4	16	939A5.000		81812
2.4 JTDM	147	09/05	2.387	D	M	5	20	939A3.000		81872
	154	05/07	2.387	D	M	5	20	939A9.000		81872
2.4 JTDM Q4	154	05/07	2.387	D	M	5	20	939A9.000		81872

### 164

2.0 T.S.	106	09/92→09/98	1.995	B	M	4	8	AR64103		11708T
2.0 Turbo	128	10/87→09/98	1.995	B	M	4	8	AR06476		81443
2.0 V6 Turbo	148	09/92→09/98	1.996	B	M	6	12	AR64102		19532/E
	150	03/91→09/92	1.997	B	M	6	12	AR64101		19532/E
2.5 V6	120	09/92→09/98	2.492	B	M	6	12	AR66201		19532/E
3.0 i.e. QV	147	09/90→09/92	2.959	B	M	6	24	AR06430, AR64301		19532/E
3.0 V6	135	06/87→09/92	2.959	B	M	6	12	AR06412		19532/E
	141	06/87→09/92	2.959	B	M	6	12	AR06410		19532/E
	132	09/92→09/98	2.959	B	M	6	12	AR64305, AR66303		19532/E

	kw		Cap. cm3	Fuel	Gear	No. of cyl.	No. of valves	Motor code		Short
<b>ALFA ROMEO</b>										
<b>166</b>										
2.0 T.Spark	114	09/98→10/00	1.970	B	M	4	16	AR34103		81331
	110	10/00	1.970	B	M	4	16	AR36301		81331
2.0 V6	151	09/98	1.996	B	M	6	12	AR34102		81355
2.4 JTD	100	09/98→10/00	2.387	D	M	5	10	AR34202		81352
	103	10/00	2.387	D	M	5	10	839A6.000		81352
<b>166</b>										
2.4 JTD	110	04/02	2.387	D	M	5	10	841C000		81352
	129	10/03	2.387	D	M	5	20	841G.000, 841H.000		81872
	132	07/06	2.387	D	M	5	20	841M.000		81872
	136	07/05	2.387	D	M	5	20	936B.000		81872
2.5 V6 24V	140	09/98→10/00	2.492	B	M	6	24	AR34201		81355
	138	10/00	2.492	B	M	6	24	AR36201		81355
3.0 V6 24V	162	10/00	2.959	B	AM	6	24	AR36101		81355
	166	09/98→10/00	2.959	B	M	6	24	AR34301		81355
3.2 V6 24V	176	10/03	3.179	B	M	6	24	936A.000	M: AR34301/36101	81355
<b>AR 6</b>										
2.4 D	53	04/85→02/86	2.445	D	M	4	8	8144.61.200		81334
2.4 TD	68	09/86→12/89	2.445	D	M	4	8	8144.21.220		81488
2.5 D	55	03/86→12/89	2.499	D	M	4	8	8144.67.220		81492
<b>AR 8</b>										
2.5 D	55	09/86→12/89	2.499	D	M	4	8	8144.67.220		81334
<b>BRERA</b>										
1.8 Tbi	147	05/09	1.742	B	M	4	16	939B1.000		81331
2.0 JTDM	125	05/09	1.956	D	M	4	16	939B3.000		81872
2.2 JTS	136	01/06	2.198	B	M	4	16	939A5.000		81812
2.4 JTDM 20V	147	01/06	2.387	D	M	5	20	939A3.000		81872
	154	05/07	2.387	D	M	5	20	939A9.000		81872
<b>GIULIETTA</b>										
1.4 TB	88	04/10	1.368	B	M	4	16	198A4.000		82070
	125	04/10	1.368	B	M	4	16	940A2.000		81331
1.6 JTDM	77	04/10	1.598	D	M	4	16	940A3.000		81872
1.8 Tbi	173	04/10	1.742	B	M	4	16	940A1.000		81331
2.0 JTDM	103	04/10	1.956	D	M	4	16			81872
	125	04/10	1.956	D	M	4	16	940A4.000		81872
<b>GT I</b>										
1300 Junior	64	01/66→12/77	1.290	B	M	4	8	AR00530	→12-1970, BC	10526/E
1600	80	01/66→12/68	1.570	B	M	4	8	AR00536	BC	10526/E
A 1600	83	01/65→12/70	1.570	B	M	4	8	AR10538	01-1967→, BC	10526/E
V 1750	83	01/67→12/72	1.779	B	M	4	8	AR00548	BC	10526/E
<b>GT II</b>										
1.8 TS	103	11/03	1.747	B	M	4	16	AR32205		81348
1.9 JTD	110	11/03	1.910	D	M	4	16	937A5.000		81872
	125	05/08	1.910	D	M	4	16			81872
2.0 JTS	121	11/03	1.970	B	M	4	16	932A2.000, 937A1.000		81331



	kw		Cap. cm3	Fuel	Gear	No. of cyl.	No. of valves	Motor code		MAGNETI MARELLI Short
<b>ALFA ROMEO</b>										
<b>GT II</b>										
3.2 GTA	176	11/03	3.179	B	M	6	24	936A.000		81355
<b>GTV II</b>										
1.8 16V	106	05/98	1.747	B	M	4	16	AR32201		81331
2.0 JTS	121	04/03	1.970	B	M	4	16	937A1.000		81331
2.0 T.SPARK 16V	110	06/95	1.970	B	M	4	16	AR16201, AR32310		81331
	114	05/98→08/00	1.970	B	M	4	16	AR32301		81331
3.0 V6 24V	162	10/96→10/00	2.959	B	M	6	24	AR16102		81355
	176	04/03	3.179	B	M	6	24	936A6.000	M: AR16102	81355
<b>MITO</b>										
1.3 JTDM	66	09/08	1.248	D	M	4	16	199A3.000		81862
	70	10/09	1.248	D	M	4	16			81862
1.4	58	09/08	1.368	B	M	4	16	955A1.000		81369
	58	09/08	1.368	B	M	4	16	955A1.000		82070
	70	09/08	1.368	B	M	4	16	199A1.000		81369
	70	09/08	1.368	B	M	4	16	199A1.000		82070
	77	08/10	1.368	B	M	4	16			82070
	88	09/08	1.368	B	M	4	16	198A4.000		81369
	88	09/08	1.368	B	M	4	16	198A4.000		82070
1.4 TB	99	10/09	1.368	B	M	4	16			82070
	114	09/08	1.368	B	M	4	16	199A8.000		82070
	125	10/09	1.368	B	M	4	16	940A2.000		82070
1.4 Turbo	110	09/08	1.368	B	M	4	16	198A1.000		82070
1.6 JTDM	85	09/08	1.598	D	M	4	16	955A4.000		81872
	88	09/08	1.598	D	M	4	16	198A2.000		81872
<b>SPIDER I</b>										
1300	64	01/68→12/77	1.290	B	M	4	8	AR00530	BC	10526/E
1600	80	03/66→12/68	1.570	B	M	4	8	AR00526, AR00536, AR01600	01-1967→, BC	10526/E
1750	83	01/67→12/71	1.779	B	M	4	8	AR00548	BC	10526/E
<b>SPIDER II</b>										
1600	76	03/76→12/90	1.570	B	M	4	8	AR00526	01-1989→	11701/T
	79	01/90→12/93	1.570	B	M	4	8	AR01563		11701/T
	80	03/71→12/79	1.570	B	M	4	8	AR00536	→12-1971, BC	10526/E
2000	85	08/86→12/90	1.962	B	M	4	8	AR01544	01-1989→	11701/T
	88	01/90→12/93	1.962	B	M	4	8	AR01588		11701/T
	92	08/86→12/90	1.962	B	M	4	8	AR00515	01-1989→	11701/T
2000 Veloce	93	01/77→12/93	1.962	B	M	4	8	AR00515, AR01590	01-1989→	11701/T
<b>SPIDER III</b>										
1.8 16V	106	05/98→04/05	1.747	B	M	4	16	AR32201		81331
2.0 JTS	121	04/03→04/05	1.970	B	M	4	16	937A1.000		81331
2.0 T.SPARK 16V	110	06/95→04/05	1.970	B	M	4	16	AR16201, AR32310		81331
	114	05/98→08/00	1.970	B	M	4	16	AR32301		81331
3.0 V6 24V	162	01/99→10/00	2.959	B	M	6	24	AR16102		81355
	176	04/03→04/05	3.179	B	M	6	24	936A6.000		81355

	kW		Cap. cm3	Fuel	Gear	No. of cyl.	No. of valves	Motor code		Short
--	----	--	----------	------	------	-------------	---------------	------------	--	-------

## ALFA ROMEO

### SPIDER IV

1.8 Tbi	147	05/09	1.742	B	M	4	16	939B1.000		81331
2.0 JTDM	125	05/09	1.956	D	M	4	16	939B3.000		81872
2.2 JTS	136	09/06	2.198	B	M	4	16	939A5.000		81812
2.4 JTDM	147	04/07	2.387	D	M	5	20	939A3.000		81872
	154	03/08	2.387	D	M	5	20	939A3.000		81872

## AUDI

### 80 II

1.3	40	05/72→07/78	1.297	B	M	4	8	ZA	(-)COP	81521
	40	05/72→07/78	1.297	B	M	4	8	ZA	(+)COP	82001
	40	09/78→07/81	1.272	B	M	4	8	FY		81520
	44	05/72→07/78	1.297	B	M	4	8	ZF	(-)COP	81521
	44	05/72→07/78	1.297	B	M	4	8	ZF	(+)COP	82001
	44	09/78→07/81	1.272	B	M	4	8	FZ		81520
	44	09/78→07/86	1.297	B	M	4	8	EP	M: FY, M: FZ	81520
	44	09/78→07/86	1.297	B	M	4	8	EP	(-)COP	81522
1.5	44	09/78→07/86	1.297	B	M	4	8	EP	(+)COP, CR	82080
	55	05/72→08/75	1.471	B	M	4	8	YJ, ZB	(-)COP	81521
		05/72→08/75	1.471	B	M	4	8	YJ, ZB	(+)COP	82001
	63	05/72→07/76	1.471	B	M	4	8	ZC	(-)COP	81521
05/72→07/76		1.471	B	M	4	8	ZC	(+)COP	82001	
1.6	51	08/78→07/81	1.588	B	M	4	8	YT, YY	(-)COP, →T: F81-B-149.000	81521
		08/78→07/81	1.588	B	M	4	8	YT, YY	(-)COP, T→: F81-B-149.001	81522
	51	08/78→07/81	1.588	B	M	4	8	YT, YY	(+)COP, →T: F81-B-149.000	82001
		08/78→07/81	1.588	B	M	4	8	YT, YY	(+)COP, CR	82080
	54	02/86→07/86	1.595	B	M	4	8	SA	(-)COP	81522
		02/86→07/86	1.595	B	M	4	8	SA	(+)COP, CR	82080
	55	08/78→07/86	1.588	B	M	4	8	WV, YN	(-)COP, T→: F81-B-149.001	81522
		08/78→07/86	1.588	B	M	4	8	WV, YN	(+)COP, CR	82080
	55	08/78→07/86	1.595	B	M	4	8	DT	(-)COP, →T: F81-B-149.000	81521
		08/78→07/86	1.595	B	M	4	8	DT	(-)COP, T→: F81-B-149.001	81522
	55	08/78→07/86	1.595	B	M	4	8	DT	(+)COP, →T: F81-B-149.000	82001
		08/78→07/86	1.595	B	M	4	8	DT	(+)COP, CR	82080
55	09/75→07/86	1.588	B	M	4	8	WV, YN	(-)COP, →T: F81-B-149.000	81521	

	kW		Cap. cm3	Fuel	Gear	No. of cyl.	No. of valves	Motor code		Short
--	----	--	----------	------	------	-------------	---------------	------------	--	-------

**AUDI**
**80 II**

1.6	55	09/75→07/86	1.588	B	M	4	8	WV, YN	(+)COP, →T: F81-B-149.000	<b>82001</b>
	63	08/78→02/83	1.588	B	M	4	8	YP	(-)COP, T→: F81-B-149.001	<b>81522</b>
	63	08/78→02/83	1.588	B	M	4	8	YP	(+)COP, CR	<b>82080</b>
	63	09/75→02/83	1.588	B	M	4	8	YP	(-)COP, →T: F81-B-149.000	<b>81521</b>
	63	09/75→02/83	1.588	B	M	4	8	YP	(+)COP, →T: F81-B-149.000	<b>82001</b>
1.6 D	40	08/80→08/86	1.588	D	M	4	8	CR, JK	(-)COP, →T: F81-B-149.000	<b>81521</b>
	40	08/80→08/86	1.588	D	M	4	8	CR, JK	(-)COP, T→: F81-B-149.001	<b>81522</b>
	40	08/80→08/86	1.588	D	M	4	8	CR, JK	(+)COP, →T: F81-B-149.000	<b>82001</b>
	40	08/80→08/86	1.588	D	M	4	8	CR, JK	(+)COP, CR	<b>82080</b>
1.6 GLE	81	01/79→12/86	1.588	B	M	4	8	YZ	(-)COP, →T: F81-B-149.000	<b>81521</b>
	81	01/79→12/86	1.588	B	M	4	8	YZ	(-)COP, T→: F81-B-149.001	<b>81522</b>
	81	01/79→12/86	1.588	B	M	4	8	YZ	(+)COP, →T: F81-B-149.000	<b>82001</b>
	81	01/79→12/86	1.588	B	M	4	8	YZ	(+)COP, CR	<b>82080</b>
1.6 GT	74	09/73→07/76	1.584	B	M	4	8	XX	(-)COP, →T: F81-B-149.000	<b>81521</b>
	74	09/73→07/76	1.584	B	M	4	8	XX	(+)COP	<b>82001</b>
1.6 GTE	81	01/76→07/78	1.588	B	M	4	8	YS	(-)COP, →T: F81-B-149.000	<b>81521</b>
	81	01/76→07/78	1.588	B	M	4	8	YS	(+)COP	<b>82001</b>
1.6 TD	51	08/81→05/86	1.588	D	M	4	8	CY	(-)COP	<b>81522</b>
	51	08/81→05/86	1.588	D	M	4	8	CY	(+)COP, CR	<b>82080</b>
1.8	65	02/86→07/86	1.781	B	M	4	8	SF	(-)COP	<b>81522</b>
	65	02/86→07/86	1.781	B	M	4	8	SF	(+)COP, CR	<b>82080</b>
	66	01/83→08/86	1.781	B	M	4	8	DS	(-)COP	<b>81522</b>
	66	01/83→08/86	1.781	B	M	4	8	DS	(+)COP, CR	<b>82080</b>
	68	08/83→08/86	1.781	B	M	4	8	JN	(-)COP	<b>81522</b>
	68	08/83→08/86	1.781	B	M	4	8	JN	(+)COP, CR	<b>82080</b>
1.8 CC quattro	66	08/84→08/86	1.781	B	M	4	8	JV, NE	(-)COP	<b>81522</b>
	66	08/84→08/86	1.781	B	M	4	8	JV, NE	(+)COP, CR	<b>82080</b>
	68	08/85→08/86	1.781	B	M	4	8	JN	(-)COP	<b>81522</b>
	68	08/85→08/86	1.781	B	M	4	8	JN	(+)COP, CR	<b>82080</b>
1.8 GTE	81	08/85→07/86	1.781	B	M	4	8	PV	(-)COP	<b>81522</b>
	81	08/85→07/86	1.781	B	M	4	8	PV	(+)COP, CR	<b>82080</b>
	82	10/84→08/86	1.781	B	M	4	8	DZ	(-)COP	<b>81522</b>
	82	10/84→08/86	1.781	B	M	4	8	DZ	(+)COP, CR	<b>82080</b>

	kw		Cap. cm3	Fuel	Gear	No. of cyl.	No. of valves	Motor code		Short
--	----	--	----------	------	------	-------------	---------------	------------	--	-------

## AUDI

### 80 II

1.8 GTE quattro	81	03/85→08/86	1.781	B	M	4	8	PV	(-)COP	81522
	81	03/85→08/86	1.781	B	M	4	8	PV	(+)COP, CR	82080
	82	08/84→08/86	1.781	B	M	4	8	DZ	(-)COP	81522
1.8 GTE quattro	82	08/84→08/86	1.781	B	M	4	8	DZ	(+)COP, CR	82080

### 80 III

1.4	48	08/86→07/88	1.400	B	M	4	8	SE	(-)COP	81522
	48	08/86→07/88	1.400	B	M	4	8	SE	(+)COP, CR	82080
1.6	51	08/87→09/91	1.595	B	M	4	8	PP	(-)COP	81522
	51	08/87→09/91	1.595	B	M	4	8	PP	(+)COP, CR	82080
	55	09/86→08/91	1.595	B	M	4	8	RN	(-)COP	81522
	55	09/86→08/91	1.595	B	M	4	8	RN	(+)COP, CR	82080
	75	08/90→10/91	1.595	B	M	4	8	ABB	(-)COP	81522
	75	08/90→10/91	1.595	B	M	4	8	ABB	(+)COP, CR	82080
1.6 D	40	09/86→08/91	1.588	D	M	4	8	JK	(-)COP	81522
	40	09/86→08/91	1.588	D	M	4	8	JK	(+)COP, CR	82080
1.6 TD	59	09/86→08/91	1.588	D	M	4	8	RA, SB	(-)COP	81522
	59	09/86→08/91	1.588	D	M	4	8	RA, SB	(+)COP, CR	82080
1.8	55	10/86→01/90	1.781	B	M	4	8	RU	(-)COP	81522
	55	10/86→01/90	1.781	B	M	4	8	RU	(+)COP, CR	82080
	83	09/86→07/88	1.847	B	M	4	8	SD	(-)COP	81522
	83	09/86→07/88	1.847	B	M	4	8	SD	(+)COP, CR	82080
1.8 E	82	06/86→08/91	1.781	B	M	4	8	DZ	(-)COP	81522
	82	06/86→08/91	1.781	B	M	4	8	DZ	(+)COP, CR	82080
1.8 E quattro	82	09/86→08/91	1.781	B	M	4	8	DZ	(-)COP	81522
	82	09/86→08/91	1.781	B	M	4	8	DZ	(+)COP, CR	82080
1.8 quattro	83	09/86→08/90	1.847	B	M	4	8	SD	(-)COP	81522
	83	09/86→08/90	1.847	B	M	4	8	SD	(+)COP, CR	82080
1.8 S	65	09/86→12/90	1.781	B	M	4	8	SF	(-)COP	81522
	65	09/86→12/90	1.781	B	M	4	8	SF	(+)COP, CR	82080
	66	09/86→10/91	1.781	B	M	4	8	JN, NE, PM	(-)COP	81522
	66	09/86→10/91	1.781	B	M	4	8	JN, NE, PM	(+)COP, CR	82080
1.8 S quattro	65	09/86→07/90	1.781	B	M	4	8	SF	(-)COP	81522
	65	09/86→07/90	1.781	B	M	4	8	SF	(+)COP, CR	82080
	66	09/86→09/91	1.781	B	M	4	8	JN, NE, PM	(-)COP	81522
	66	09/86→09/91	1.781	B	M	4	8	JN, NE, PM	(+)COP, CR	82080
1.9 D	50	08/89→08/91	1.896	D	M	4	8	1Y	(-)COP	81522
	50	08/89→08/91	1.896	D	M	4	8	1Y	(+)COP, CR	82080
2.0	82	10/90→08/91	1.984	B	M	4	8	AAD	(-)COP	81522
	82	10/90→08/91	1.984	B	M	4	8	AAD	(+)COP, CR	82080
2.0 E	83	08/88→10/90	1.984	B	M	4	8	3A	(-)COP	81522
	83	08/88→10/90	1.984	B	M	4	8	3A	(+)COP, CR	82080
2.0 E quattro	83	08/88→09/90	1.984	B	M	4	8	3A	(-)COP	81522
	83	08/88→09/90	1.984	B	M	4	8	3A	(+)COP, CR	82080
2.0 E 16V	101	03/90→09/91	1.984	B	M	4	16	6A	(-)COP	81522
	101	03/90→09/91	1.984	B	M	4	16	6A	(+)COP, CR	82080

	kw		Cap. cm3	Fuel	Gear	No. of cyl.	No. of valves	Motor code		Short
--	----	--	----------	------	------	-------------	---------------	------------	--	-------

## AUDI

### 80 III

2.0 E 16V quattro	101	03/90→08/91	1.984	B	M	4	16	6A	(-)COP	81522
	101	03/90→08/91	1.984	B	M	4	16	6A	(+)COP, CR	82080
2.0 quattro	82	10/90→08/91	1.984	B	M	4	8	3A	(-)COP	81522
	82	10/90→08/91	1.984	B	M	4	8	3A	(+)COP, CR	82080
	85	10/90→08/91	1.984	B	M	4	8	AAD	(-)COP	81522
	85	10/90→08/91	1.984	B	M	4	8	AAD	(+)COP, CR	82080

### 80 IV, AVANT

1.6	52	09/91→12/94	1.595	B	M	4	8	ABM	(-)COP	81522
	52	09/91→12/94	1.595	B	M	4	8	ABM	(+)COP, CR	82080
1.6 E	74	06/93→01/96	1.595	B	M	4	8	ADA	(-)COP	81522
	74	06/93→01/96	1.595	B	M	4	8	ADA	(+)COP, CR	82080
1.9 TD	55	09/91→12/94	1.896	D	M	4	8	AAZ	(-)COP	81522
	55	09/91→12/94	1.896	D	M	4	8	AAZ	(+)COP, CR	82080
1.9 TDI	66	09/91→01/96	1.896	D	M	4	8	1Z	(-)COP	81522
	66	09/91→01/96	1.896	D	M	4	8	1Z	(+)COP, CR	82080
2.0	66	09/91→01/96	1.984	B	M	4	8	ABT	(-)COP	81522
	66	09/91→01/96	1.984	B	M	4	8	ABT	(+)COP, CR	82080
2.0 E	85	09/91→01/96	1.984	B	M	4	8	ABK	(-)COP	81522
	85	09/91→01/96	1.984	B	M	4	8	ABK	(+)COP, CR	82080
2.0 E 16V	103	08/92→01/96	1.984	B	M	4	16	ACE	(-)COP	81522
	103	08/92→01/96	1.984	B	M	4	16	ACE	(+)COP, CR	82080
2.0 E 16V quattro	103	04/92→07/95	1.984	B	M	4	16	ACE	(-)COP	81522
	103	04/92→07/95	1.984	B	M	4	16	ACE	(+)COP, CR	82080
2.0 E quattro	85	09/91→12/94	1.984	B	M	4	8	ABK	(-)COP	81522
	85	09/91→12/94	1.984	B	M	4	8	ABK	(+)COP, CR	82080
2.0 quattro	79	11/93→07/96	1.984	B	M	4	8	ADW	(-)COP	81522
	79	11/93→07/96	1.984	B	M	4	8	ADW	(+)COP, CR	82080
2.3 E	98	09/91→01/96	2.309	B	M	5	10	NG		81700
2.3 E quattro	98	09/91→12/94	2.309	B	M	5	10	NG		81700
RS2 quattro	232	03/94→05/95	2.226	B	M	5	20	ADU		81700
S2 quattro	169	02/93→07/95	2.226	B	M	5	20	ABY		81700

### 90 I

1.6 TD	51	10/85→01/87	1.588	D	M	4	8	CY	(-)COP	81522
	51	10/85→01/87	1.588	D	M	4	8	CY	(+)COP, CR	82080

### 90 III

1.6 TD	59	04/87→09/91	1.588	D	M	4	8	RA, SB	(-)COP	81522
	59	04/87→09/91	1.588	D	M	4	8	RA, SB	(+)COP, CR	82080
2.0	85	07/88→09/91	1.994	B	M	5	10	PS	T→: F89-J-394.743	81683
2.0 20 V	118	08/89→07/91	1.994	B	M	5	20	NM		81683
2.0 20 V quattro	118	08/88→09/91	1.994	B	M	5	20	NM		81683
2.0 quattro	101	08/89→07/90	1.984	B	M	4	16	6A	(-)COP	81522
	101	08/89→07/90	1.984	B	M	4	16	6A	(+)COP, CR	82080
2.2 E	100	04/87→07/91	2.226	B	M	5	10	KV	T→: F89-J-394.743	81683
2.2 E quattro	100	04/87→09/91	2.226	B	M	5	10	KV	T→: F89-J-394.743	81683
2.3 E	98	04/87→09/91	2.309	B	M	5	10	NG	T→: F89-J-394.743	81683
	100	04/87→07/91	2.309	B	M	5	10	NG	T→: F89-J-394.743	81683

	kw		Cap. cm3	Fuel	Gear	No. of cyl.	No. of valves	Motor code		Short
<b>AUDI</b>										
<b>90 III</b>										
2.3 E quattro	98	04/87→09/91	2.309	B	M	5	10	NG	T→: F89-J-394.743	81683
	100	04/87→07/91	2.309	B	M	5	10	NG	T→: F89-J-394.743	81683
2.3 E 20V	123	04/90→07/91	2.309	B	M	5	20	7A		81683
	125	08/88→07/91	2.309	B	M	5	20	7A		81683
2.3 E 20V quattro	123	04/90→09/91	2.309	B	M	5	20	7A		81683
	125	06/88→09/91	2.309	B	M	5	20	7A		81683
<b>100 II, AVANT</b>										
1.6	63	08/76→02/83	1.588	B	M	4	8	YV	(-)COP, →T: F43-B-070.000	81521
	63	08/76→02/83	1.588	B	M	4	8	YV	(-)COP, T→: F43-B-070.001	81522
	63	08/76→02/83	1.588	B	M	4	8	YV	(+)COP, →T: F43-B-070.000	82001
	63	08/76→02/83	1.588	B	M	4	8	YV	(+)COP, CR	82080
2.0	85	06/76→07/80	1.984	B	M	4	8	WA	BC	81831
2.0 D	51	08/78→02/83	1.986	D	M	5	10	CN		81593
<b>100 III, AVANT</b>										
1.8	55	08/82→12/87	1.781	B	M	4	8	DR, RS	(-)COP	81522
	55	08/82→12/87	1.781	B	M	4	8	DR, RS	(+)COP, CR	82080
	65	02/86→07/90	1.781	B	M	4	8	SH	(-)COP	81522
	65	02/86→07/90	1.781	B	M	4	8	SH	(+)COP, CR	82080
	66	08/83→07/89	1.781	B	M	4	8	DS, JW, NP	(-)COP, T→: F43-B-070.001	81522
	66	08/83→07/89	1.781	B	M	4	8	DS, JW, NP	(+)COP, CR	82080
1.8 Cat.	66	03/85→11/90	1.781	B	M	4	8	4B, PH	(-)COP	81522
	66	03/85→11/90	1.781	B	M	4	8	4B, PH	(+)COP, CR	82080
1.8 quattro	65	08/86→07/90	1.781	B	M	4	8	SH	(-)COP	81522
	65	08/86→07/90	1.781	B	M	4	8	SH	(+)COP, CR	82080
	66	10/84→07/88	1.781	B	M	4	8	JW, NP	(-)COP	81522
	66	10/84→07/88	1.781	B	M	4	8	JW, NP	(+)COP, CR	82080
1.8 quattro Cat.	66	08/85→11/90	1.781	B	M	4	8	4B, PH	(-)COP	81522
	66	08/85→11/90	1.781	B	M	4	8	4B, PH	(+)COP, CR	82080
1.9	74	08/82→07/84	1.921	B	M	5	10	WH	T→: F43-E-000.001	81683
2.0 Cat.	85	01/88→11/90	1.994	B	M	5	10	RT	M→: 010.236	81683
2.0 D	51	08/82→11/90	1.986	D	M	5	10	CN	→05-1990, →T: F-L-100.000	81593
2.0 D Turbo	74	03/88→11/90	1.986	D	M	5	10	NC	→05-1990, →T: F-L-100.000	81593
	64	08/82→02/88	1.986	D	M	5	10	DE		81593
2.0 E Cat.	85	01/88→11/90	1.994	B	M	5	10	RT	M→: 010.236	81683
2.0 TD	64	03/83→10/87	1.986	D	M	5	10	DE		81593
	74	03/88→11/90	1.986	D	M	5	10	NC	→05-1990, →T: F-L-100.000	81593
2.2	101	08/84→12/88	2.226	B	M	5	10	KU	05-1988→, M→: 077.237	81683

	kw		Cap. cm3	Fuel	Gear	No. of cyl.	No. of valves	Motor code		Short
--	----	--	----------	------	------	-------------	---------------	------------	--	-------

## AUDI

### 100 III, AVANT

2.2 Cat.	101	06/89→11/90	2.226	B	M	5	10	HX, KU		81683
2.2 E Turbo quattro	121	08/86→11/90	2.226	B	M	5	10	MC	05-1988→, M→: 039.951	81683
2.2 quattro	101	08/84→12/88	2.226	B	M	5	10	KU	05-1988→, M→: 077.237	81683
2.2 quattro Cat.	101	06/89→11/90	2.226	B	M	5	10	KU		81683
2.2 Turbo	121	08/86→11/90	2.226	B	M	5	10	MC	05-1988→, M→: 039.951	81683
2.2 Turbo quattro	121	08/86→11/90	2.226	B	M	5	10	MC	05-1988→, M→: 039.951	81683
2.3	98	03/90→11/90	2.309	B	M	5	10	AAR		81683
	100	08/86→11/90	2.309	B	M	5	10	NF	05-1988→, M→: 063.969	81683
2.3 E	98	01/90→11/90	2.309	B	M	5	10	AAR		81683
	100	10/86→11/90	2.309	B	M	5	10	NF	05-1988→, M→: 063.969	81683
2.3 E quattro	100	08/86→11/90	2.309	B	M	5	10	NF	05-1988→, M→: 063.969	81683
2.3 quattro	98	01/90→11/90	2.309	B	M	5	10	AAR		81683
2.4 D	60	08/89→07/91	2.370	D	M	5	10	3D	→05-1990, →T: F-L-100.000	81593

### 100 IV, AVANT

1.6	87	03/92→07/93	1.595	B	M	4	8		(-)COP	81522
	87	03/92→07/93	1.595	B	M	4	8		(+)COP, CR	82080
2.0	74	12/90→06/94	1.984	B	M	4	8	AAE	(-)COP	81522
	74	12/90→06/94	1.984	B	M	4	8	AAE	(+)COP, CR	82080
	103	08/92→07/93	1.984	B	M	4	16	ACE	(-)COP	81522
	103	08/92→07/93	1.984	B	M	4	16	ACE	(+)COP, CR	82080
2.0 E	74	09/91→06/94	1.984	B	M	4	8	AAE	(-)COP	81522
	74	09/91→06/94	1.984	B	M	4	8	AAE	(+)COP, CR	82080
	85	12/90→06/94	1.984	B	M	4	8	AAD, ABK	(-)COP	81522
	85	12/90→06/94	1.984	B	M	4	8	AAD, ABK	(+)COP, CR	82080
2.0 E 16V	103	01/92→06/94	1.984	B	M	4	16	ACE	(-)COP	81522
	103	01/92→06/94	1.984	B	M	4	16	ACE	(+)COP, CR	82080
2.0 E 16V quattro	103	07/92→06/94	1.984	B	M	4	16	ACE	(-)COP	81522
	103	07/92→06/94	1.984	B	M	4	16	ACE	(+)COP, CR	82080
2.0 E quattro	85	12/90→07/92	1.984	B	M	4	8	AAD	(-)COP	81522
	85	12/90→07/92	1.984	B	M	4	8	AAD	(+)COP, CR	82080
2.0 quattro	103	08/92→07/93	1.984	B	M	4	16	ACE	(-)COP	81522
	103	08/92→07/93	1.984	B	M	4	16	ACE	(+)COP, CR	82080
2.3 E	98	12/90→06/94	2.309	B	M	5	10	AAR		81700
2.3 E quattro	98	12/90→06/94	2.309	B	M	5	10	AAR		81700
2.4 D	60	12/90→06/94	2.370	D	M	5	10	AAS		81701
2.5 TDi	85	08/93→07/94	2.460	D	M	5	10	AAT		81701
	85	12/90→06/94	2.461	D	M	5	10	AAT, ABP		81701
S4 Turbo quattro	169	08/91→06/94	2.226	B	M	5	20	AAN		81700

	kw		Cap. cm3	Fuel	Gear	No. of cyl.	No. of valves	Motor code		Short
--	----	--	----------	------	------	-------------	---------------	------------	--	-------

## AUDI

### 200 II, AVANT

2.2 Turbo	121	08/85→09/91	2.226	B	M	5	10	MC	M→: 039.951	81683
	140	02/88→12/90	2.226	B	M	5	10	2B	M→: 001.069	81683
	147	02/88→12/90	2.226	B	M	5	10	1B	M→: 001.571	81683
2.2 Turbo quattro	147	02/88→12/91	2.226	B	M	5	10	1B	M→: 001.571	81683
	121	09/83→12/91	2.226	B	M	5	10	MC	M→: 039.951	81683
2.2 20V Turbo quattro	162	03/89→12/90	2.226	B	M	5	20	3B	T→: F44-J-246.282	81683
2.3	100	11/86→09/91	2.309	B	M	5	10	NF		81683

### A1

1.4 TFSI	90	05/10	1.390	B	M	4	16	CAXA		82097
1.6 TDI	77	05/10	1.598	D	M	4	16	CAYC		83000

### A2

1.2 TDI	45	03/01→08/05	1.191	D	M	3	6	ANY		81791
1.4	55	02/00→08/05	1.390	B	M	4	16	AUA, BBY		81777
1.4 TDI	55	02/00→08/05	1.422	D	M	3	6	AMF, BHC		81791
	66	11/03→08/05	1.422	D	M	3	6	ATL		81791
1.6 FSI	81	05/02→08/05	1.598	B	M	4	16	BAD		81840

### A3 I

1.6	75	08/00	1.595	B	AM	4	8	AVU, BFQ		81702
	74	09/96→08/00	1.595	B	M	4	8	AEH, AKL, APF		81702
1.8	92	09/96	1.781	B	AM	4	20	AGN, APG		81703
1.8 quattro	92	08/98	1.781	B	M	4	20	AGN		81703
1.8 T	110	12/96	1.781	B	M	4	20	AGU, AQA, ARZ, AUM		81703
	132	12/98	1.781	B	M	4	20	AJQ, APP, ARY, AUQ		81703
1.8 T quattro	132	10/98	1.781	B	M	4	20	AJQ, ARY		81703
	110	12/96	1.781	B	M	4	20	AGU, AQA, ARX		81703
1.9 TDI	66	09/96→07/01	1.896	D	M	4	8	AGR, ALH	T→: F8L-V-115.001	81706
	74	10/00	1.896	D	M	4	8	ATD, AXR		81816
	81	08/97→07/01	1.896	D	M	4	8	AHF, ASV	T→: F8L-V-115.001	81706
	96	08/00	1.896	D	AM	4	8	ASZ		81816
1.9 TDI quattro	96	08/00	1.896	D	M	4	8	ASZ		81816
S3 quattro	154	03/99	1.781	B	M	4	20	AMK, APY, AUL		81703
	165	10/01	1.781	B	M	4	20	BAM		81703

### A3 II, SPORTBACK, CABRIOLÉT

1.4 FSI	92	02/08	1.390	B	M	4	16	CAXC		82097
1.4 TFSI	92	09/07	1.390	B	M	4	16	CAXC		82097
1.6	74	08/08	1.595	B	M	4	8			81702
	75	05/03	1.595	B	M	4	8	BGU, BSE		81702
1.6 FSI	85	08/03	1.598	B	M	4	16	BAG, BLP		81865
1.6 TDI	66	05/09	1.598	D	M	4	16	CAYB		83000
	77	05/09	1.598	D	M	4	16	CAYC		83000
1.8 T	110	08/06	1.781	B	M	4	20	BPU		81702
1.8 TFSI	118	04/08	1.798	B	M	4	16	BZB		82096
1.8 TFSI quattro	118	07/08	1.798	B	M	4	16	CDA A		82096
1.9 TDI	77	05/03	1.896	D	M	4	8	BKC, BLS		81791
2.0 FSI	110	05/03	1.984	B	M	4	16	AXW, BLR, BLX, BLY, BMB, BVY, BVZ		81702



	kw		Cap. cm3	Fuel	Gear	No. of cyl.	No. of valves	Motor code		Short
--	----	--	----------	------	------	-------------	---------------	------------	--	-------

## AUDI

### A3 II, SPORTBACK, CABRIOLÉT

2.0 TDI	100	05/03	1.968	D	M	4	16	AZV, CBAA		81816
	103	04/08	1.968	D	M	4	16	CBAB		81816
	103	06/05	1.968	D	M	4	8	BMM		81816
	120	06/06→06/08	1.968	D	M	4	16	BUY		81816
	125	03/06	1.968	D	M	4	16	BMN		81816
2.0 TDI 16V	103	05/03	1.968	D	M	4	16	BKD		81816
2.0 TDI 16V quattro	103	08/04	1.968	D	M	4	16	BKD	M: BKD	81816
2.0 TDI quattro	100	05/03	1.968	D	M	4	16	AZV		81816
	103	01/06	1.968	D	M	4	8	BMM		81816
	125	03/06	1.968	D	M	4	16	BMN		81816
2.0 TFSI	147	04/08	1.984	B	M	4	16	CAWB		82096
	147	09/04	1.984	B	M	4	16	AXX		82025
2.0 TFSI quattro	147	09/04	1.984	B	M	4	16	AXX		82025
3.2	184	11/05	3.189	B	M	6	24	BMJ, BUB		81866
3.2 V6 quattro	184	07/03	3.189	B	M	6	24	BDB, BMJ		81866
S3 quattro	188	02/07	1.984	B	M	4	16	BZC		82025
	195	11/06	1.984	B	M	4	16	BHZ		82025

### A4 I, AVANT

1.6	74	01/95→07/00	1.595	B	M	4	8	ADP, AHL, ANA, ARM	(-)COP, 03-1996→, 01-1995→, →12-1997	81526
	74	01/95→07/00	1.595	B	M	4	8	ADP, AHL, ANA, ARM	(+)COP, 03-1996→, 01-1995→, →12-1997	81529
	74	01/95→07/00	1.595	B	M	4	8	ADP, AHL, ANA, ARM	12-1997→, →07-2000, M: AHL/ANA/ARM	81702
	75	07/00→09/01	1.595	B	M	4	8	ALZ		81702
1.8	85	04/95→09/01	1.781	B	M	4	20	AFY	(-)COP	81526
	85	04/95→09/01	1.781	B	M	4	20	AFY	(+)COP	81529
	92	01/95→09/01	1.781	B	M	4	20	ADR, APT, ARG, AVV	(-)COP	81526
	92	01/95→09/01	1.781	B	M	4	20	ADR, APT, ARG, AVV	(+)COP	81529
	95	01/95→11/00	1.781	B	M	4	20		(-)COP	81526
	95	01/95→11/00	1.781	B	M	4	20		(+)COP	81529
1.8 quattro	85	07/95→09/01	1.781	B	M	4	20	AFY	(-)COP	81526
	85	07/95→09/01	1.781	B	M	4	20	AFY	(+)COP	81529
	92	01/95→09/01	1.781	B	M	4	20	ADR, APT, ARG	(-)COP	81526
	92	01/95→09/01	1.781	B	M	4	20	ADR, APT, ARG	(+)COP	81529
1.8 T	110	01/95→09/01	1.781	B	M	4	20	AEB, ANB, APU, ARK, AWT	(-)COP	81526
	110	01/95→09/01	1.781	B	M	4	20	AEB, ANB, APU, ARK, AWT	(+)COP	81529
	132	12/97→09/01	1.781	B	M	4	20	AJL	(-)COP	81526
	132	12/97→09/01	1.781	B	M	4	20	AJL	(+)COP	81529
1.8 T quattro	110	01/95→09/01	1.781	B	M	4	20	AEB, ANB, APU, ARK, AWT	(-)COP	81526
	110	01/95→09/01	1.781	B	M	4	20	AEB, ANB, APU, ARK, AWT	(+)COP	81529
	132	12/97→09/01	1.781	B	M	4	20	AJL	(-)COP	81526
	132	12/97→09/01	1.781	B	M	4	20	AJL	(+)COP	81529
1.9 DUO	66	03/98→09/01	1.896	D	M	4	8	AHU	M: AHU, M: AHH	81528
1.9 TDI	55	12/95→09/01	1.896	D	M	4	8	AFF		81528
	66	01/95→09/01	1.896	D	M	4	8	1Z, AHH, AHU		81528

	kw		Cap. cm3	Fuel	Gear	No. of cyl.	No. of valves	Motor code		Short
--	----	--	----------	------	------	-------------	---------------	------------	--	-------

## AUDI

### A4 I, AVANT

1.9 TDI	81	10/95→09/01	1.896	D	M	4	8	AFN, AVG		81528
	85	03/00→09/01	1.896	D	M	4	8	AJM		81816
1.9 TDI quattro	85	03/00→09/01	1.896	D	M	4	8	AJM, ATJ		81816
	81	09/96→09/01	1.896	D	M	4	8	AFN, AVG		81528
2.4	110	07/95→07/97	2.393	B	M	6	30	AFM		81842
	120	08/97→09/01	2.393	B	M	6	30	AJG, AMM, APZ		81842
	121	03/97→09/01	2.393	B	M	6	30	AGA, ALF, AML, APS, ARJ		81842
2.4 quattro	120	08/97→09/01	2.393	B	M	6	30	APZ		81842
	121	03/97→09/01	2.393	B	M	6	30	AGA, ALF, AML, APS, ARJ		81842
2.5 TDI	110	09/97→09/01	2.496	D	M	6	24	AFB, AKN		81705
2.5 TDI quattro	110	09/97→09/01	2.496	D	M	6	24	AFB, AKN		81705
2.6	102	01/96→07/97	2.598	B	M	6	12	ACZ		81842
	110	01/95→09/01	2.598	B	M	6	12	ABC		81842
2.6 quattro	110	01/95→09/01	2.598	B	M	6	12	ABC		81842
2.7 Turbo quattro	169	02/99→09/00	2.671	B	M	6	30	AJK		81842
2.8	128	09/95→07/97	2.771	B	M	6	12	AAH		81842
	142	10/96→09/01	2.771	B	M	6	30	ACK, ALG, AMX, APR, AQD		81842
2.8 quattro	128	01/95→07/97	2.771	B	M	6	12	AAH		81842
	142	10/96→09/01	2.771	B	M	6	30	ACK, ALG, AMX, APR, AQD		81842
RS4 quattro	280	05/00→09/01	2.671	B	M	6	30	ASJ, AZR		81842
S4 quattro	195	09/97→09/01	2.671	B	M	6	30	AGB	01-1999→	81842

### A4 II, AVANT

1.6	75	11/00→12/04	1.595	B	M	4	8	ALZ		81702
1.8	125	10/02→10/05	1.781	B	M	4	20	AMB		81703
1.8 T	110	11/00→07/02	1.781	B	M	4	20	AVJ		81703
	120	07/02→12/04	1.781	B	M	4	20	BFB, BKB		81703
	125	07/01→12/04	1.781	B	M	4	20	AMB		81703
	140	11/02→12/04	1.781	B	M	4	20	BEX		81703
1.8 T quattro	110	11/00→07/02	1.781	B	M	4	20	AVJ		81703
	120	07/02→12/04	1.781	B	M	4	20	BFB		81703
	125	07/01→12/04	1.781	B	M	4	20	AMB		81703
	140	11/02→12/04	1.781	B	M	4	20	BEX		81703
1.9 TDI	74	05/01→12/04	1.896	D	M	4	8	AVB		81816
	85	06/04→12/04	1.896	D	M	4	8	BKE		81816
	96	11/00→12/04	1.896	D	M	4	8	AVF, AWX		81816
1.9 TDI quattro	96	11/01→12/04	1.896	D	M	4	8	AVF		81816
2.0	96	11/00→12/05	1.984	B	M	4	20	ALT	M: ALT	81702
	147	11/05	1.984	B	M	4	20			82025
2.0 FSI	110	07/02→12/04	1.984	B	M	4	16	AWA		81702
2.0 TDI	103	01/06	1.968	D	M	4	8	BPW		81816
	93	11/05→10/07	1.968	D	M	4	16	BVF		81816
2.0 TFSI	147	01/06	1.984	B	M	4	16	BWE		82025
2.0 TFSI quattro	147	11/05	1.984	B	M	4	20			82025
2.4	120	09/01→12/05	2.393	B	M	6	30	AMM		81842
	125	09/01→12/05	2.393	B	M	6	30	BDV		81842
2.5 D	132	10/00→05/03	2.496	D	M	6	24	AKE		81705

	kw		Cap. cm3	Fuel	Gear	No. of cyl.	No. of valves	Motor code		MAGNETI MARELLI Short
--	----	--	----------	------	------	-------------	---------------	------------	--	-----------------------

## AUDI

### A4 II, AVANT

2.5 TDI	120	07/02→12/05	2.496	D	M	6	24	BCZ, BDG, BFC		81705
	114	08/01→07/02	2.496	D	M	6	24	AYM		81705
2.5 TDi	132	10/00→05/03	2.496	D	M	6	24	AKE		81705
2.5 TDI quattro	132	11/00→12/04	2.496	D	M	6	24	AKE, BAU, BDH		81705
2.7 TDI	132	06/06	2.698	D	M	6	24	BPP		82015
3.0	160	04/01→12/04	2.976	B	M	6	30	BBJ		81819
	162	11/00→12/05	2.976	B	M	6	30	ASN, AVK		81819
3.0 quattro	160	04/01→12/04	2.976	B	M	6	30	BBJ		81819
	162	09/01→12/04	2.976	B	AM	6	30	ASN, AVK		81819
	162	11/00→12/05	2.976	B	M	6	30	ASN, AVK		81819
3.0 TDI quattro	150	01/06	2.967	D	M	6	24	BKN		82015
	171	01/06	2.967	D	M	6	24	ASB		82015
3.2 FSI	188	01/06	3.123	B	M	6	24	AUK		82015
3.2 FSI quattro	188	01/06	3.123	B	M	6	24	AUK		82015
S4 quattro	253	03/03→12/04	4.163	B	M	8	40	BBK		82046

### A4 III, AVANT

1.6	75	11/04	1.595	B	M	4	8	ALZ		81702
1.8 T	120	11/04	1.781	B	M	4	20	BFB		81703
1.8 T quattro	120	11/04	1.781	B	M	4	20	BFB		81703
1.9 TDI	85	11/04	1.896	D	M	4	8	BKE		81816
2.0	96	11/04	1.984	B	M	4	20	ALT		81702
2.0 FSi	125	10/06	1.984	B	M	4	16	BYK		82025
2.0 GL	110	01/05→07/05	1.984	B	M	4	16	AWA		81702
2.0 TDI	89	09/05→09/06	1.968	D	M	4	16	BVG		81816
	100	11/04	1.968	D	M	4	16	BNA		81816
	103	11/04	1.968	D	M	4	8	BPW		81816
	120	06/06	1.968	D	M	4	16	BVA		81816
	125	06/06	1.968	D	M	4	16	BRD		81816
2.0 TDi	93	11/05→03/08	1.968	D	M	4	16	BVF		81816
2.0 TDI 16V	103	11/04	1.968	D	M	4	16	BLB, BRE		81816
2.0 TDI quattro	103	01/06	1.968	D	M	4	8	BPW		81816
	120	06/06	1.968	D	M	4	16	BVA		81816
	125	06/06	1.968	D	M	4	16	BRD		81816
2.0 TFSI	162	06/05	1.984	B	M	4	16	BUL		82025
	147	11/04	1.984	B	M	4	16	BGB		82025
2.0 TFSI quattro	162	06/05	1.984	B	M	4	16	BUL		82025
	147	11/04	1.984	B	M	4	16	BGB, BWE, BWT		82025
2.5 TDI	120	11/04→05/06	2.496	D	M	6	24	BDG		81705
2.7 TDI	132	01/06	2.698	D	M	6	24	BPP		82015
2.7 TDi	120	11/05→03/08	2.698	D	M	6	24	BSG		82015
3.0	160	11/04→05/06	2.976	B	M	6	30	BBJ		81819
3.0 quattro	160	11/04→07/06	2.976	B	M	6	30	BBJ		81819
3.0 TDI quattro	171	01/06	2.967	D	M	6	24	ASB		82015
	150	11/04	2.967	D	M	6	24	BKN		82015
3.2 FSI	188	01/05	3.123	B	M	6	24	AUK		82015

	kw		Cap. cm3	Fuel	Gear	No. of cyl.	No. of valves	Motor code		Short
--	----	--	----------	------	------	-------------	---------------	------------	--	-------

## AUDI

### A4 III, AVANT

3.2 FSI quattro	188	01/05	3.123	B	M	6	24	AUK, BKH		82015
S4 quattro	253	11/04	4.163	B	M	8	40	BBK, BHF		82046

### A4 IV, AVANT

1.8 FSI	88	04/08	1.798	B	M	4	16	CDHA		82096
1.8 TFSI	88	01/08	1.798	B	M	4	16	CABA		82096
	118	11/07	1.798	B	M	4	16	CABB		82096
1.8 TFSI quattro	118	09/08	1.798	B	M	4	16	CDHB		82096
2.0 TDI	100	11/07	1.968	D	M	4	16	CAGB		81816
	105	11/07	1.968	D	M	4	16	CAGA		81816
	120	08/08	1.968	D	M	4	16	CAHB		81816
	125	01/08	1.968	D	M	4	16	CAHA		81816
2.0 TDi	88	06/08	1.968	D	M	4	16	CAGC		81816
2.0 TDi quattro	125	01/08	1.968	D	M	4	16	CAHA		81816
2.0 TDI quattro	105	04/08	1.968	D	M	4	16	CAGA		81816
2.0 TFSI	132	06/08	1.984	B	M	4	16	CDNB		82096
	155	06/08	1.984	B	M	4	16	CDNC		82096
2.0 TFSI flexible fuel	132	11/09	1.984	B	M	4	16	CFKA		82096
2.0 TFSI flexible fuel quattro	132	11/09	1.984	B	M	4	16	CFKA		82096
2.0 TFSi quattro	155	06/08	1.984	B	M	4	16	CDNC		82096
2.7 TDI	120	11/07	2.698	D	M	6	24	CAMB		82015
	140	11/07	2.698	D	M	6	24	CAMA, CGKA		82015
3.0 TDI quattro	155	06/08	2.967	D	M	6	24	CCWB		82015
	176	11/07	2.967	D	M	6	24	CAPA, CCWA		82015
3.2 FSI	195	09/08	3.197	B	M	6	24	CALA		82037
	192	10/08	3.197	B	M	6	24			82037
3.2 FSI quattro	195	11/07	3.197	B	M	6	24	CALA		82037

### A4 IV, AVANT, ALLROAD

2.0 TDI quattro	100	09/09	1.968	D	M	4	16	CAGB		81816
	105	09/09	1.968	D	M	4	16	CAGA		81816
	120	04/09	1.968	D	M	4	16	CAHB		81816
	124	04/09	1.968	D	M	4	16			81816
	125	04/09	1.968	D	M	4	16	CAHA		81816
2.0 TFSI quattro	153	04/09	1.984	B	M	4	16			82096
	155	04/09	1.984	B	M	4	16	CDNC		82096
3.0 TDI quattro	174	04/09	2.967	D	M	6	24			82015
	176	04/09	2.967	D	M	6	24	CCWA		82015

### A5, CABRIOLÉT

1.8 TFSI	118	05/09	1.798	B	M	4	16	CDHB		82096
	125	10/07	1.798	B	M	4	16	CABD		82096
2.0 TDI	120	08/08	1.968	D	M	4	16	CAHB		81816
	124	10/08	1.968	D	M	4	16			81816
	125	08/08	1.968	D	M	4	16	CAHA		81816
2.0 TDI quattro	125	08/08	1.968	D	M	4	16	CAHA		81816
	124	10/08	1.968	D	M	4	16			81816
2.0 TFSI	132	11/08	1.984	B	M	4	16	CAEA, CDNB		82096
	155	06/08	1.984	B	M	4	16	CDNC		82096

	kw		Cap. cm3	Fuel	Gear	No. of cyl.	No. of valves	Motor code		MAGNETI MARELLI Short
--	----	--	----------	------	------	-------------	---------------	------------	--	-----------------------

## AUDI

### A5, CABRIOLÉT

2.0 TFSI quattro	155	06/08	1.984	B	M	4	16	CDNC		82096
2.7 TDI	120	09/07	2.698	D	M	6	24	CAMB, CGKB		82015
	140	06/07	2.698	D	M	6	24	CAMA, CGKA		82015
3.0 TDI quattro	155	03/08	2.967	D	M	6	24	CCWB		82015
	176	06/07	2.967	D	M	6	24	CAPA, CCWA		82015
3.2 FSI	195	06/07	3.197	B	M	6	24	CALA		82037
3.2 FSI quattro	195	06/07	3.197	B	M	6	24	CALA		82037

### A5, CABRIOLET, SPORTBACK

1.8 TFSI	118	11/09	1.798	B	M	4	16	CDHB		82096
2.0 TDI	100	09/09	1.968	D	M	4	16	CAGB		81816
	105	09/09	1.968	D	M	4	16	CAGA, CMEA		81816
	120	09/09	1.968	D	M	4	16	CAHB		81816
	125	09/09	1.968	D	M	4	16	CAHA		81816
2.0 TDI quattro	125	09/09	1.968	D	M	4	16	CAHA		81816
2.0 TFSI	132	09/09	1.984	B	M	4	16	CDNB		82096
	155	09/09	1.984	B	M	4	16	CDNC		82096
2.0 TFSI quattro	155	09/09	1.984	B	M	4	16	CDNC		82096
2.7 TDI	120	09/09	2.698	D	M	6	24	CGKB		82015
	140	09/09	2.698	D	M	6	24	CGKA		82015
3.0 TDI quattro	176	09/09	2.967	D	M	6	24	CCWA		82015
3.2 FSI quattro	195	09/09	3.197	B	M	6	24	CALA		82037

### A6 I, AVANT

1.8	92	12/95→12/97	1.781	B	M	4	20	ADR	(-)COP	81526
	92	12/95→12/97	1.781	B	M	4	20	ADR	(+)COP	81529
1.8 quattro	92	12/95→12/97	1.781	B	M	4	20	ADR	(-)COP	81526
	92	12/95→12/97	1.781	B	M	4	20	ADR	(+)COP	81529
1.9 TDI	66	06/94→12/97	1.896	D	M	4	8	1Z, AHU	(-)COP, M: 1Z	81522
	66	06/94→12/97	1.896	D	M	4	8	1Z, AHU	M: AHU	81528
	66	06/94→12/97	1.896	D	M	4	8	1Z, AHU	(+)COP, CR	82080
2.0	74	06/94→12/97	1.984	B	M	4	8	AAE	(-)COP	81522
	74	06/94→12/97	1.984	B	M	4	8	AAE	(+)COP, CR	82080
	79	08/95→07/96	1.984	B	M	4	8	ADW	(-)COP	81522
	79	08/95→07/96	1.984	B	M	4	8	ADW	(+)COP, CR	82080
	85	06/94→12/97	1.984	B	M	4	8	ABK	(-)COP	81522
	85	06/94→12/97	1.984	B	M	4	8	ABK	(+)COP, CR	82080
2.0 16V	103	06/94→12/97	1.984	B	M	4	16	ACE	(-)COP	81522
	103	06/94→12/97	1.984	B	M	4	16	ACE	(+)COP, CR	82080
2.0 16V quattro	103	06/94→12/97	1.984	B	M	4	16	ACE	(-)COP	81522
	103	06/94→12/97	1.984	B	M	4	16	ACE	(+)COP, CR	82080
2.3	98	06/94→12/95	2.309	B	M	5	10	AAR		81700
2.3 quattro	98	06/94→12/95	2.309	B	M	5	10	AAR		81700
2.4	110	07/95→12/97	2.393	B	M	6	12	AFM		81842
2.5 TDI	84	01/95→12/97	2.461	D	M	5	10	AAT		81701
	85	06/94→12/97	2.461	D	M	5	10	AAT		81701
	103	08/94→12/97	2.461	D	M	5	10	AEL		81701
2.5 TDI quattro	103	07/95→12/97	2.461	D	M	5	10	AEL		81701

	kW		Cap. cm3	Fuel	Gear	No. of cyl.	No. of valves	Motor code		Short
--	----	--	----------	------	------	-------------	---------------	------------	--	-------

## AUDI

### A6 I, AVANT

2.6	102	06/94→02/97	2.598	B	M	6	12	ACZ	(+)COP, 08-1996→, →02-1997, T→: F44-S-026-715	81529
	102	06/94→10/97	2.598	B	M	6	12	ACZ	08-1996→, →02-1997, T→: F44-S-026-715	81842
	110	06/94→12/97	2.598	B	M	6	12	ABC	08-1996→, →12-1997, →02-1997, T→: F44-S-026-715, T→: F44-S-026-715	81842
2.6 quattro	110	06/94→12/97	2.598	B	M	6	12	ABC	08-1996→, →12-1997, →02-1997, T→: F44-S-026-715, T→: F44-S-026-715	81842
2.8	128	06/94→12/97	2.771	B	M	6	12	AAH, AEJ, AFC	08-1996→, →12-1997, →02-1997, T→: F44-S-026-715	81842
	142	12/95→12/97	2.771	B	M	6	30	ACK	T→: F44-S-026-715	81842
2.8 quattro	128	06/94→12/97	2.771	B	M	6	12	AAH, AEJ	08-1996→, →12-1997, →02-1997, T→: F44-S-026-715	81842
	142	12/95→12/97	2.771	B	M	6	30	ACK	T→: F44-S-026-715	81842
S6 Turbo quattro	169	06/94→12/97	2.226	B	M	5	20	AAN		81700

### A6 II, AVANT

1.8	85	05/97→01/05	1.781	B	M	4	20	AFY	(-)COP	81526
	85	05/97→01/05	1.781	B	M	4	20	AFY	(+)COP	81529
	92	07/97→01/05	1.781	B	M	4	20	AJP, ANQ, AQE, ARH		81702
1.8 T	110	01/97→01/05	1.781	B	M	4	20	AEB, ANB, APU, ARK, AWL, AWT	(-)COP, NOT FOR: M AWT	81526
	110	01/97→01/05	1.781	B	M	4	20	AEB, ANB, APU, ARK, AWL, AWT	(+)COP, NOT FOR: M AWT	81529
	110	01/97→01/05	1.781	B	M	4	20	AEB, ANB, APU, ARK, AWL, AWT	02-2000→, 05-2000→, →07-2004, M: AWT	81703
	132	12/97→01/05	1.781	B	M	4	20	AJL	(-)COP	81526
	132	12/97→01/05	1.781	B	M	4	20	AJL	(+)COP	81529
1.8 T quattro	110	02/97→01/05	1.781	B	M	4	20	AEB, ANB, APU, ARK, AWT	(-)COP, NOT FOR: M AWT	81526
	110	02/97→01/05	1.781	B	M	4	20	AEB, ANB, APU, ARK, AWT	(+)COP, NOT FOR: M AWT	81529
	110	02/97→01/05	1.781	B	M	4	20	AEB, ANB, APU, ARK, AWT	05-2000→, →07-2004, M: AWT	81703
	132	12/97→01/05	1.781	B	M	4	20	AJL	(-)COP	81526
	132	12/97→01/05	1.781	B	M	4	20	AJL	(+)COP	81529
1.9 TDI	81	04/97→04/01	1.896	D	M	4	8	AFN, AVG		81528
	85	07/00→01/05	1.896	D	M	4	8	AJM		81816
	96	08/01→01/05	1.896	D	M	4	8	AVF, AWX		81816
2.0	96	08/01→01/05	1.984	B	M	4	20	ALT		81702
2.4	100	07/98→01/05	2.393	B	M	6	30	ALW, ARN, ASM		81842
	115	02/97→01/05	2.393	B	M	6	30	APC		81842
	120	02/97→01/05	2.393	B	M	6	30	AJG, AMM, APZ		81842
	121	02/97→01/05	2.393	B	M	6	30	AGA, ALF, AML, APS, ARJ		81842
	125	08/01→01/05	2.393	B	AM	6	30	BDV		81842

	kw		Cap. cm3	Fuel	Gear	No. of cyl.	No. of valves	Motor code		MAGNETI MARELLI Short
--	----	--	----------	------	------	-------------	---------------	------------	--	-----------------------

## AUDI

### A6 II, AVANT

2.4 quattro	115	08/98→05/01	2.393	B	M	6	30	APC		81842
	120	02/97→01/05	2.393	B	M	6	30	AJG, APZ		81842
	121	02/97→01/05	2.393	B	M	6	30	AGA, ALF, AML, APS, ARJ		81842
	125	08/01→01/05	2.393	B	AM	6	30	BDV		81842
2.5 TDI	110	07/97→01/05	2.496	D	M	6	24	AFB, AKN		81705
	114	08/01→01/05	2.496	D	M	6	24	AYM		81705
	120	07/02→01/05	2.496	D	M	6	24	BCZ, BDG, BFC		81705
	132	02/00→01/05	2.496	D	M	6	24	AKE, BAU, BDH, BND		81705
2.5 TDI quattro	132	02/00→01/05	2.496	D	M	6	24	AKE, BAU, BDH		81705
	110	07/97→01/05	2.496	D	M	6	24	AFB, AKN		81705
2.7	187	05/01→07/04	2.671	B	M	6	30	APB		81842
2.7 quattro	187	05/01→07/04	2.671	B	M	6	30	APB		81842
	195	11/03→07/04	2.671	B	M	6	30	BEL		81842
2.7 T	169	02/99→01/05	2.671	B	M	6	30	AJK		81842
2.7 T quattro	169	12/97→01/05	2.671	B	M	6	30	AJK, AZA	01-1999→	81842
	184	08/01→01/05	2.671	B	M	6	30	ARE, BES		81842
2.8	132	10/97→07/98	2.771	B	M	6	30	AGE		81842
	140	07/99→01/05	2.771	B	M	6	30	ATX, BBG		81842
	142	02/97→01/05	2.771	B	M	6	30	ACK, ALG, AMX, APR, AQD		81842
2.8 24V	142	05/97→07/99	2.771	B	M	6	24			81842
2.8 quattro	132	01/98→04/00	2.771	B	M	6	30	AGE		81842
	140	07/99→05/01	2.771	B	M	6	30	ATX		81842
	142	02/97→01/05	2.771	B	M	6	30	ACK, ALG, AMX, APR, AQD		81842
3.0	162	08/01→01/05	2.976	B	M	6	30	ASN		81819
3.0 quattro	160	06/01→07/04	2.976	B	M	6	30	BBJ		81819
	162	08/01→01/05	2.976	B	M	6	30	ASN		81819
3.7	191	03/99→01/05	3.697	B	A	8	40	AQG		82081
3.7 quattro	191	03/99→01/05	3.697	B	A	8	40	AQG		82081
4.2 quattro	220	11/98→01/05	4.172	B	M	8	40	ARS, ASG, AWN	04-1999→	82081
RS6	331	07/02→01/05	4.172	B	M	8	40	BCY		82081
RS6 plus	353	04/04→01/05	4.172	B	M	8	40	BRV		82081
S6 quattro	250	09/99→01/05	4.172	B	M	8	40	ANK, AQJ	04-1999→	82081

### A6 II, AVANT, ALLROAD

2.5 TDI quattro	132	05/00→08/05	2.496	D	M	6	24	AKE, BAU		81705
	120	05/03→08/05	2.496	D	M	6	24	BCZ		81705
2.7 quattro	187	09/00→08/05	2.671	B	M	6	30	APB		81842
2.7 T quattro	184	05/00→08/05	2.671	B	M	6	30	ARE, BES		81842
4.2 V8 quattro	220	07/02→08/05	4.163	B	M	8	40	BAS		82046

### A6 III, AVANT, ALLROAD

2.0 TDI	89	09/05→06/06	1.968	D	M	4	16	BVG		81816
	100	07/04	1.968	D	M	4	16	BNA, BRF		81816
	103	07/04→10/08	1.968	D	M	4	16	BLB, BRE		81816
	120	04/09	1.968	D	M	4	16	CAHB		81816
	125	10/08	1.968	D	M	4	16	CAHA		81816
2.0 TFSI	125	06/05	1.984	B	M	4	16	BPJ		82025
2.4	130	05/04→10/08	2.393	B	M	6	24	BDW		82015

	kw		Cap. cm3	Fuel	Gear	No. of cyl.	No. of valves	Motor code		Short
--	----	--	----------	------	------	-------------	---------------	------------	--	-------

## AUDI

### A6 III, AVANT, ALLROAD

2.4 quattro	130	01/05→10/08	2.393	B	M	6	24	BDW		82015
2.7 TDI	120	11/04	2.698	D	M	6	24	BSG		82015
	132	11/04→10/08	2.698	D	M	6	24	BPP		82015
	140	10/08	2.698	D	M	6	24	CANA		82015
2.7 TDI quattro	120	06/05	2.698	D	M	6	24	BSG		82015
	132	11/04→10/08	2.698	D	M	6	24	BPP		82015
	140	10/08	2.698	D	M	6	24	CANA		82015
2.8 FSI	140	10/08	2.773	B	M	6	24	CCDA		82037
	154	11/06→10/08	2.773	B	M	6	24	BDX		82037
	162	10/08	2.773	B	M	6	24	CCEA		82037
2.8 FSI quattro	140	10/08	2.773	B	M	6	24	CCDA		82037
	154	06/07→10/08	2.773	B	M	6	24	BDX		82037
	162	10/08	2.773	B	M	6	24	CCEA		82037
3.0	160	08/04→05/06	2.976	B	M	6	30	BBJ		81819
3.0 quattro	160	05/04→05/06	2.976	B	M	6	30	BBJ		81819
3.0 TDi PF	171	06/06	2.967	D	M	6	24	ASB		82015
3.0 TDI quattro	155	05/04	2.967	D	M	6	24	BNG		82015
	165	05/04→05/06	2.967	D	M	6	24	BMK		82015
	171	05/06→10/08	2.967	D	M	6	24	ASB		82015
	176	10/08	2.967	D	M	6	24	CDYA		82015
3.0 TFSI quattro	213	10/08	2.995	B	M	6	24	CAJA	→02-2009	82015
3.2 FSI	188	05/04→10/08	3.123	B	M	6	24	AUK		82015
3.2 FSI quattro	183	09/06→10/08	3.123	B	M	6	24	BYU		82015
	188	05/04→10/08	3.123	B	M	6	24	AUK, BKH		82015
4.2 quattro	246	05/04→05/06	4.163	B	M	8	40	BAT		82046

### A8 I

2.5 TDI	110	01/97→04/00	2.496	D	M	6	24	AFB, AKN		81705
	132	09/00→09/02	2.496	D	M	6	24	AKE		81705
2.5 TDI quattro	110	07/97→04/00	2.496	D	M	6	24	AFB, AKN		81705
	132	09/00→09/02	2.496	D	M	6	24	AKE		81705
2.8	142	04/96→09/02	2.771	B	M	6	30	ACK, ALG, AMX, APR, AQD	T→: F4D-S-000.497	81842
2.8 FSI	154	08/07→07/10	2.773	B	M	6	24	BDX		82037
2.8 quattro	142	04/96→09/02	2.771	B	M	6	30	ACK, AMX, APR, AQD	T→: F4D-S-000.497	81842
3.0	160	07/03→07/10	2.976	B	M	6	30	BBJ		81819
	162	08/03→07/10	2.976	B	M	6	30	ASN		81819
3.0 Long quattro	162	08/03→05/05	2.976	B	M	6	30	ASN		81819
	160	11/03→05/06	2.976	B	M	6	30	BBJ		81819
3.0 TDI quattro	171	08/03→07/10	2.967	D	M	6	24	ASB		82015
	155	11/03→07/10	2.967	D	M	6	24	BNG		82015
3.2 FSI	191	06/05→07/10	3.123	B	M	6	24	BPK		82015
3.2 FSI quattro	191	06/05→07/10	3.123	B	M	6	24	BPK		82015
3.3 TDI quattro	165	06/00→09/02	3.328	D	M	8	40	AKF		82041
3.7	191	11/98→09/02	3.697	B	A	8	40	AKC, AQG		82081
3.7 quattro	191	11/98→09/02	3.697	B	A	8	40	AKC, AQG		82081
	206	10/02→07/10	3.697	B	A	8	40	BFL		82081
4.0 TDI quattro	202	03/03→07/10	3.936	D	M	8	32	ASE		82046



	kw		Cap. cm3	Fuel	Gear	No. of cyl.	No. of valves	Motor code		Short
--	----	--	----------	------	------	-------------	---------------	------------	--	-------

## AUDI

### A8 I

4.2 quattro	175	02/99→04/00	4.172	B	M	8	32	ARU		82081
	228	11/98→09/02	4.172	B	M	8	40	AQF, AUW, AUX		82081
	246	10/02→07/10	4.172	B	M	8	40	BFM		82081
4.2 TDI quattro	235	07/05→07/10	4.134	D	M	8	32	BMC		82046
	240	07/05→07/10	4.134	D	M	8	32	BVN		82046
S 8 quattro	265	06/99→09/02	4.172	B	A	8	40	AQH, AVP		82081

### CABRIO

1.8	92	01/97→08/00	1.781	B	M	4	20	ADR	(-)COP	81526
	92	01/97→08/00	1.781	B	M	4	20	ADR	(+)COP	81529
1.9 TDI	66	06/95→08/00	1.896	D	M	4	8	1Z, AHU	(-)COP	81522
	66	06/95→08/00	1.896	D	M	4	8	1Z, AHU	(+)COP, CR	82080
2.0 16V	103	06/95→07/96	1.984	B	M	4	16	ACE	(-)COP	81522
	103	06/95→07/96	1.984	B	M	4	16	ACE	(+)COP, CR	82080
2.0 E	85	01/93→07/98	1.984	B	M	4	8	ABK	(-)COP	81522
	85	01/93→07/98	1.984	B	M	4	8	ABK	(+)COP, CR	82080
2.3 E	98	05/91→07/94	2.309	B	M	5	10	NG		81700

### COUPE' I

1.6	55	07/80→08/81	1.588	B	M	4	8	YN	(-)COP	81522
	55	07/80→08/81	1.588	B	M	4	8	YN	(+)COP, CR	82080
1.8	55	08/81→07/83	1.781	B	M	4	8	DD	(-)COP	81522
	55	08/81→07/83	1.781	B	M	4	8	DD	(+)COP, CR	82080
1.8 GT	65	04/86→10/88	1.781	B	M	4	8	SF	(-)COP	81522
	65	04/86→10/88	1.781	B	M	4	8	SF	(+)COP, CR	82080
	66	09/82→10/88	1.781	B	M	4	8	DS, JV	(-)COP	81522
	66	09/82→10/88	1.781	B	M	4	8	DS, JV	(+)COP, CR	82080
	68	01/85→07/88	1.781	B	M	4	8	JN	(-)COP	81522
	68	01/85→07/88	1.781	B	M	4	8	JN	(+)COP, CR	82080
	79	08/86→10/87	1.781	B	M	4	8	PV	(-)COP	81522
	79	08/86→10/87	1.781	B	M	4	8	PV	(+)COP, CR	82080
	82	08/86→10/88	1.781	B	M	4	8	DZ	(-)COP	81522
	82	08/86→10/88	1.781	B	M	4	8	DZ	(+)COP, CR	82080
1.8 GT quattro	66	09/85→10/88	1.781	B	M	4	8	DS, JN, NE	(-)COP	81522
	66	09/85→10/88	1.781	B	M	4	8	DS, JN, NE	(+)COP, CR	82080
	82	12/84→10/88	1.781	B	M	4	8	DZ	(-)COP	81522
	82	12/84→10/88	1.781	B	M	4	8	DZ	(+)COP, CR	82080
2.3	100	01/87→10/88	2.309	B	M	5	10	NG	08-1988→, →T: F88-M-033.000	81683
	100	01/87→10/88	2.309	B	M	5	10	NG	T→: F88-M-033.001	81700
2.3 quattro	100	01/87→10/88	2.309	B	M	5	10	NG	08-1988→, →T: F88-M-033.000	81683
	100	01/87→10/88	2.309	B	M	5	10	NG	T→: F88-M-033.001	81700

### COUPE' II

1.8	82	08/89→07/91	1.781	B	M	4	8	DZ	→12-1990, →T: F88-M-033.000	81683
	82	08/89→07/91	1.781	B	M	4	8	DZ	01-1991→, T→: F88-M-033-001	81700

<b>AUDI</b>										
<b>COUPE' II</b>										
2.0	82	03/90→07/90	1.984	B	M	4	8	3A	(-)COP	81522
	82	03/90→07/90	1.984	B	M	4	8	3A	(+)COP, CR	82080
	83	05/89→03/90	1.984	B	M	4	8	3A	(-)COP	81522
	83	05/89→03/90	1.984	B	M	4	8	3A	(+)COP, CR	82080
	85	05/89→12/96	1.984	B	M	4	8	AAD, ABK	(-)COP	81522
	85	05/89→12/96	1.984	B	M	4	8	AAD, ABK	(+)COP, CR	82080
2.0 16 V	101	01/92→07/92	1.984	B	M	4	16	6A	(-)COP	81522
	101	01/92→07/92	1.984	B	M	4	16	6A	(+)COP, CR	82080
	103	08/92→12/96	1.984	B	M	4	16	ACE	(-)COP	81522
	103	08/92→12/96	1.984	B	M	4	16	ACE	(+)COP, CR	82080
	118	08/89→07/91	1.994	B	M	5	20	NM	→T: F88-M-033.000	81683
	118	08/89→07/91	1.994	B	M	5	20	NM	T→: F88-M-033.001	81700
2.0 20 V quattro	118	08/89→07/91	1.994	B	M	5	20	NM	→T: F88-M-033.000	81683
	118	08/89→07/91	1.994	B	M	5	20	NM	T→: F88-M-033.001	81700
2.2 quattro	100	11/88→07/91	2.226	B	M	5	10	KV		81683
2.3	98	03/90→12/96	2.309	B	M	5	10	NG	→12-1990, →T: F88-M-033.000	81683
	98	03/90→12/96	2.309	B	M	5	10	NG	01-1991→, T→: F88-M-033-001	81700
	100	10/88→07/94	2.309	B	M	5	10	NG	→12-1990, →T: F88-M-033.000	81683
	100	10/88→07/94	2.309	B	M	5	10	NG	01-1991→, T→: F88-M-033-001	81700
2.3 quattro	98	05/90→12/96	2.309	B	M	5	10	NG	→12-1990, →T: F88-M-033.000	81683
	98	05/90→12/96	2.309	B	M	5	10	NG	01-1991→, T→: F88-M-033-001	81700
	100	11/88→12/92	2.309	B	M	5	10	NG	→12-1990, →T: F88-M-033.000	81683
	100	11/88→12/92	2.309	B	M	5	10	NG	01-1991→, T→: F88-M-033-001	81700
2.3 20V	123	08/90→07/91	2.309	B	M	5	20	7A	→12-1990, →T: F88-M-033.000	81683
	123	08/90→07/91	2.309	B	M	5	20	7A	01-1991→, T→: F88-M-033-001	81700
	125	08/89→07/91	2.309	B	M	5	20	7A	→12-1990, →T: F88-M-033.000	81683
	125	08/89→07/91	2.309	B	M	5	20	7A	01-1991→, T→: F88-M-033-001	81700
2.3 20V quattro	123	05/90→12/96	2.309	B	M	5	20	7A	→12-1990, →T: F88-M-033.000	81683
	123	05/90→12/96	2.309	B	M	5	20	7A	01-1991→, T→: F88-M-033-001	81700
	125	11/88→07/91	2.309	B	M	5	20	7A	→12-1990, →T: F88-M-033.000	81683

	kw		Cap. cm3	Fuel	Gear	No. of cyl.	No. of valves	Motor code		MAGNETI MARELLI Short
--	----	--	----------	------	------	-------------	---------------	------------	--	-----------------------

## AUDI

### COUPE' II

2.3 20V quattro	125	11/88→07/91	2.309	B	M	5	20	7A	01-1991→, T→: F88-M-033-001	81700
S2 quattro	162	09/90→09/92	2.226	B	M	5	20	3B	→T: F88-M-033.000	81700
	169	10/92→12/96	2.226	B	M	5	20	ABY		81700

### Q5

2.0 TDI	100	08/09	1.968	D	M	4	16	CAGB		81816
	105	08/09	1.968	D	M	4	16	CAGA		81816
2.0 TFSI	132	08/09	1.984	B	M	4	16	CDNB		82096
	155	11/08	1.984	B	M	4	16	CDNC		82096
3.0 TDI	155	11/08	2.967	D	M	6	24	CCWB		82015
	176	11/08	2.967	D	M	6	24	CCWA		82015
3.2 FSI	199	11/08	3.197	B	M	6	24	CALB		82037

### Q7

3.0 TDI	176	11/07	2.967	D	M	6	24	CASA		82015
3.0 TDi quattro	155	03/06	2.967	D	M	6	24	BUN		82015
	171	03/06	2.967	D	M	6	24	BUG		82015
4.2 TDI quattro	240	03/07	4.134	D	M	8	32	BTR		82046

### TT I, COUPÉ, ROADSTER

1.8 T	110	01/01→06/06	1.781	B	M	4	20	AUM		81703
	120	09/05→06/06	1.781	B	M	4	20	BVP		81703
	140	09/05→06/06	1.781	B	M	4	20	BVR		81703
	132	10/98→06/06	1.781	B	M	4	20	AJQ, APP, ARY, ATC, AUQ, AWP		81703
1.8 T quattro	132	10/98→06/06	1.781	B	M	4	20	AJQ, ARY, ATC, AWP		81703
	140	09/05→06/06	1.781	B	M	4	20	BVR		81703
	165	10/98→06/06	1.781	B	M	4	20	AMU, APX, BAM		81703
	176	03/05→06/06	1.781	B	M	4	20	BFV		81703
3.2 VR6 quattro	184	07/03→06/06	3.189	B	M	6	24	BHE		81866

### TT II, COUPÉ, ROADSTER

1.8 TFSI	118	06/08	1.798	B	M	4	16	CDA A		82096
2.0 quattro	195	05/08	1.984	B	M	4	16	CDLA		82025
2.0 TDI quattro	125	06/08	1.968	D	M	4	16	CBBB		81816
2.0 TFSI	147	10/06	1.984	B	M	4	16	BWA		82025
2.0 TFSI quattro	147	06/08	1.984	B	M	4	16	CCZA		82025
	200	06/08	1.984	B	M	4	16	CDLB		82025
3.2 V6 quattro	184	10/06	3.189	B	M	6	24	BUB		81866

## BMW

### 1, CABRIO, COUPÉ

116 i	85	09/04	1.596	B	M	4	16	N45B16A		82010
116i	90	09/07	1.597	B	M	4	16	N45B16TU2		82010
118 d	90	09/04	1.995	D	M	4	16	M47N204D4		82040
118i	95	09/04	1.995	B	M	4	16	N42B20B		82010
	105	04/07	1.995	B	M	4	16	N43B20A		82010
120 d	120	09/04	1.995	D	M	4	16	M47N204D4		82040
120 i	110	09/04	1.995	B	M	4	16	N42B20A		82010
120i	125	04/07	1.995	B	M	4	16	N43B20A		82010

	kw		Cap. cm3	Fuel	Gear	No. of cyl.	No. of valves	Motor code		Short
--	----	--	----------	------	------	-------------	---------------	------------	--	-------

## BMW

### 1, CABRIO, COUPÉ

2.0	105	03/07	1.995	B	M	4	16			82010
	115	03/07	1.995	B	M	4	16			82010
	125	03/07	1.995	B	M	4	16	N43B20A		82010

### 3 I (E21)

316	66	08/75→08/80	1.573	B	M	4	8	M10B16		81582
	66	09/80→08/82	1.766	B	M	4	8	M10B18		81582
318	72	08/75→08/80	1.766	B	M	4	8	M10B18		81582
318 i	77	11/79→08/82	1.766	B	M	4	8	M10B18		81582
320	80	08/75→08/77	1.990	B	M	4	8	M10B20		81582
320 i	92	06/75→08/82	1.990	B	M	4	8	M10B20	01-1975→, →07-1979	81582
320/6	90	09/77→08/82	1.990	B	M	6	12	M20B20	→09-1981, VF	81583
	90	09/77→08/82	1.990	B	M	6	12	M20B20	10-1981→	81586
323 i	105	01/78→08/82	2.316	B	M	6	12	M20B23	→09-1981, VF	81583
	105	01/78→08/82	2.316	B	M	6	12	M20B23	10-1981→	81586

### 3 II (E30), TOURING, CABRIO

315	55	09/82→10/83	1.573	B	M	4	8	M10B16		81582
316	66	09/82→12/90	1.766	B	M	4	8	M10B18	→09-1987	81584
	66	09/82→12/90	1.766	B	M	4	8	M10B18	10-1987→	81587
316 i	73	09/87→06/91	1.596	B	M	4	8	M40B16 (Kat.)	→09-1988	81584
	73	09/87→06/94	1.596	B	M	4	8	M40B16 (Kat.)	10-1988→	81587
	75	07/88→06/91	1.596	B	M	4	8	M40B16	→09-1988	81584
	75	07/88→06/94	1.596	B	M	4	8	M40B16	10-1988→	81587
316 i 1.8	75	08/87→08/88	1.766	B	M	4	8	M10B18		81584
318 i	75	12/84→08/88	1.766	B	M	4	8	M10B18, M10B18 (L-Jetronic, Kat.)	→09-1987	81584
	75	12/84→08/88	1.766	B	M	4	8	M10B18, M10B18 (L-Jetronic, Kat.)	10-1987→	81587
	77	09/82→08/87	1.766	B	M	4	8	M10B18		81584
	83	09/87→06/94	1.796	B	M	4	8	M40B18	M: M40B16	81587
	85	09/87→06/91	1.796	B	M	4	8	M40B18		81587
318 is	100	09/89→08/91	1.796	B	M	4	16	M42B18		81590
318i	103	06/88→02/92	1.796	B	M	4	8	M40B18C		81587
320 i	92	09/82→12/85	1.990	B	M	6	12	M20B20		81586
	95	12/85→06/91	1.991	B	M	6	12	M20B20, M20B20 (L-Jetronic)	→09-1987	81586
	95	04/86→10/93	1.990	B	M	6	12	M20B20	→09-1987	81586
	95	04/86→10/93	1.990	B	M	6	12	M20B20	10-1987→	81616
	95	12/85→12/91	1.991	B	M	6	12	M20B20, M20B20 (L-Jetronic)	10-1987→	81616
	110	12/85→06/90	1.990	B	M	6	12		→09-1987	81586
	110	12/85→06/90	1.990	B	M	6	12		10-1987→	81616
320 is	141	05/88→12/90	1.990	B	M	4	16	S14204EA		81616
323 i	102	09/82→08/83	2.316	B	M	6	12	M20B23		81586
	110	09/83→08/86	2.316	B	M	6	12	M20B23		81586
324 d	63	09/85→08/91	2.443	D	M	6	12	M21D24W		81585
324 td	85	09/87→06/93	2.443	D	M	6	12	M21D24, M21D24WA		81585
325 e 2.7	95	01/85→08/87	2.693	B	M	6	12	M20B27		81586
	90	10/83→12/88	2.693	B	M	6	12	M20B27	→09-1987	81586

	kw		Cap. cm3	Fuel	Gear	No. of cyl.	No. of valves	Motor code		MAGNETI MARELLI Short
--	----	--	----------	------	------	-------------	---------------	------------	--	-----------------------

## BMW

### 3 II (E30), TOURING, CABRIO

325 e 2.7	90	10/83→12/88	2.693	B	M	6	12	M20B27	10-1987→	81616
325 i	125	12/86→06/91	2.494	B	M	6	12	M20B25	→09-1987	81586
	125	12/86→10/93	2.494	B	M	6	12	M20B25	10-1987→	81616
	126	09/83→11/89	2.494	B	M	6	12	M20B25	→09-1987	81586
	126	09/83→11/89	2.494	B	M	6	12	M20B25	10-1987→	81616
325 i X	125	12/86→08/91	2.494	B	M	6	12	M20B25	→09-1987	81586
	125	12/86→10/93	2.494	B	M	6	12	M20B25	10-1987→	81616
	126	03/86→12/87	2.494	B	M	6	12	M20B25	→09-1987	81586
	126	03/86→12/87	2.494	B	M	6	12	M20B25	10-1987→	81616
M3 2.3	143	07/86→06/91	2.303	B	M	4	16	S14B23		81586
	147	02/87→05/89	2.303	B	M	4	16	S14B23		81586
	158	06/89→06/91	2.303	B	M	4	16	S14B23		81586

### 3 III (E36), TOURING, CABRIO, COMPACT, COUPÉ

316 g	75	12/95→08/00	1.596	BF	M	4	8			81590
316 i	73	09/90→09/93	1.596	B	M	4	8	M40B16 (Kat.)	M: M40B16	81589
	73	09/90→09/93	1.596	B	M	4	8	M40B16 (Kat.)	M: M43B16 / C / K	81590
	75	07/93→08/00	1.596	B	M	4	8	M43B16	M: M43B16 / C / K	81590
	75	09/90→09/93	1.596	B	M	4	8	M40B16, M43B16		81589
	77	12/98→08/00	1.895	B	M	4	8	M43164E3		81590
318 i	83	12/90→10/93	1.796	B	M	4	8	M40B18	M: M40B16	81589
	85	10/93→10/99	1.796	B	M	4	8	M43B18	M: M43B18 / C, M: M40B16, M: M43B19C	81590
318 is	103	03/92→09/97	1.796	B	M	4	16	M42B18		81590
	103	09/95→04/99	1.895	B	M	4	16	M44B19		81590
318 tds	66	01/95→08/00	1.665	D	M	4	8	M41D18 (Inter.)		81597
318 ti	103	11/94→08/95	1.796	B	M	4	16	M42B18		81590
	103	07/95→08/00	1.895	B	M	4	16	M44B19	M: M44B19 / C	81590
320 i	110	09/90→10/99	1.991	B	M	6	24	M50B (206S1), M50B (206S2) Vanos, M50B20TU, M52B (206S3)Vanos		81588
323 i 2.5	125	03/95→10/99	2.494	B	M	6	24	M52B25 (Vanos)	04-1995→	81588
323 ti	125	08/97→08/00	2.494	B	M	6	24	M52B25 (Vanos)		81588
325 i	141	09/90→04/99	2.494	B	M	6	24	M50B25, M50B25 (Vanos)		81588
325 td	85	09/91→02/98	2.497	D	M	6	12	M51D25		81597
325 tds	105	05/93→10/99	2.503	D	M	6	12	M51D25 (Inter.)		81597
328 i	142	01/95→10/99	2.793	B	M	6	24	M52B28		81588

### 3 IV (E46), TOURING, CABRIO, COMPACT, COUPÉ

316 Ci	77	04/00	1.596	B	M	4	8	M43B16 (164E3)	→06-2001	81590
	77	04/00	1.596	B	M	4	8	M43B16 (164E3)	06-2001→	82010
	85	06/02	1.596	B	M	4	16	N45B16A		82010
316 i	77	09/98→02/05	1.895	B	M	4	8	M43164E3, M43B19TU		81590
	77	04/00→02/05	1.596	B	M	4	8	M43B16 (164E3)		81590
	77	04/00→02/05	1.596	B	M	4	8	M43B16 (164E3)	06-2002→	82010
	85	02/02→02/05	1.796	B	M	4	16	N42B18		82010
	85	06/02→02/05	1.596	B	M	4	16	N45B16A		82010
316 ti	85	06/01→02/05	1.796	B	M	4	16	N42B18		82010

	kw		Cap. cm3	Fuel	Gear	No. of cyl.	No. of valves	Motor code		Short
--	----	--	----------	------	------	-------------	---------------	------------	--	-------

**BMW**
**3 IV (E46), TOURING, CABRIO, COMPACT, COUPÉ**

318 Ci	87	11/99→09/01	1.895	B	M	4	8	M43B19		81590
	105	09/01	1.995	B	M	4	16	N42B20, N46B20		82010
	110	02/05	1.995	B	M	4	16	N46B20B		82010
	110	03/05	1.995	B	M	4	16	N46B20A		81588
318 d	85	09/01→02/05	1.951	D	M	4	16	M47204D1		81793
	85	03/03→02/05	1.995	D	M	4	16	M47N204D4	04-2004→	82040
318 i	87	02/98→09/01	1.895	B	M	4	8	M43B19		81590
	105	09/01→02/05	1.995	B	M	4	16	N42B20, N46B20		82010
318 td	85	03/03→02/05	1.995	D	M	4	16	M47N204D4	04-2004→	82040
318 ti	105	09/01→02/05	1.995	B	M	4	16	N42B20		82010
320 Cd	110	11/03	1.995	D	M	4	16	M47N204D4	C: A	82034
	110	11/03	1.995	D	M	4	16	M47N204D4	04-2004→	82040
320 Ci	110	08/99→09/00	1.991	B	M	6	24	M52B (206S4)	C: M	81588
	125	09/00	2.171	B	AM	6	24	M54226S1, M54B22		81588
	125	09/00	2.171	B	M	6	24	M54226S1		81588
320 d	100	04/98→09/01	1.951	D	M	4	16	M47204D1, M47D20	M: M47204D1	81793
	100	04/98→09/01	1.951	D	M	4	16	M47204D1, M47D20	M: M47D20	81794
	110	09/01→02/05	1.995	D	M	4	16	M47N204D4	C: A	82034
	110	09/01→02/05	1.995	D	M	4	16	M47N204D4	04-2004→	82040
320 i	110	03/98→09/00	1.991	B	M	6	24	M52B (206S3)Vanos, M52B20		81588
	125	09/00→02/05	2.171	B	M	6	24	M54226S1		81588
320 td	110	09/01→02/05	1.995	D	M	4	16	M47N204D4	04-2004→	82040
323 Ci	125	04/99→09/00	2.494	B	M	6	24	M52B25 (Vanos)		81588
323 i	125	03/98→09/00	2.494	B	M	6	24	M52B25 (Vanos)		81588
325 Ci	141	09/00	2.494	B	AM	6	24	M54256S5		81588
	141	09/00	2.494	B	M	6	24	M54256S5		81588
325 i	141	09/00→02/05	2.494	B	M	6	24	M54256S5		81588
325 ti	141	06/01→02/05	2.494	B	M	6	24	M54256S5		81588
325 xi	141	09/00→02/05	2.494	B	M	6	24	M54256S5		81588
328 Ci	142	04/99→06/00	2.793	B	M	6	24	M52B28		81588
328 i	142	02/98→06/00	2.793	B	M	6	24	M52B28		81588
330 Cd	150	03/03	2.993	D	M	6	24	M57N306D2		82034
330 Ci	170	06/00	2.979	B	AM	6	24	M54306S3		81588
	170	06/00	2.979	B	M	6	24	M54306S3		81588
330 d	135	10/99→02/05	2.926	D	M	6	24	M57D30		81795
	150	03/03→02/05	2.993	D	M	6	24	M57N306D2		82034
330 i	170	06/00→02/05	2.979	B	M	6	24	M54306S3		81588
330 xd	135	06/00→02/05	2.926	D	M	6	24	M57D30		81795
	150	03/03→02/05	2.993	D	M	6	24	M57N306D2		82034
330 xi	170	06/00→02/05	2.979	B	M	6	24	M54306S3		81588

**3 V (E90), TOURING (E91), COUPÉ (E92), CABRIO (E93)**

1.9	110	03/07→08/07	1.995	B	M	4	16	N46NB20B		82010
2.0	110	11/06→06/07	1.995	B	M	4	16	N46NB20B		82010
316i	85	02/06	1.596	B	M	4	16	N45B16A		82010
318d	90	09/05	1.995	D	M	4	16	M47N204D4		82040
	105	09/05	1.995	D	M	4	16	N47D20A		82040

	kw		Cap. cm3	Fuel	Gear	No. of cyl.	No. of valves	Motor code		Short
--	----	--	----------	------	------	-------------	---------------	------------	--	-------

## BMW

### 3 V (E90), TOURING (E91), COUPÉ (E92), CABRIO (E93)

318i	95	09/05→03/07	1.995	B	M	4	16	N46B20B		82010
320 si	127	05/06	1.997	B	M	4	16	N45B20A		82010
320d	120	01/05	1.995	D	M	4	16	M47N204D4, M47N204D5		82040
	110	09/05	1.995	D	M	4	16	M47N204D4		82040
320i	110	01/05→03/07	1.995	B	M	4	16	N46B20A, N46B20C		82010
	125	03/07	1.995	B	M	4	16	N43B20A		82010
325d	145	09/06	2.993	D	M	6	24	M57306D3, N57306D3, N57N306D3		82040
330d	170	09/05	2.993	D	M	6	24	M57306D3, N57N306D3		82040
330xd	170	09/05	2.993	D	M	6	24	M57306D3		82040
335d	210	09/06	2.993	D	M	6	24	M57N306D5		82040

### 5 I (E12)

518	66	07/74→05/81	1.766	B	M	4	8	M10B18, M10B18 (2B4)		81582
	80	12/75→08/77	1.990	B	M	4	8			81582
518i	75	08/79→08/81	1.776	B	M	4	8	M10B18 (K-Jetronic)		81582
	92	08/77→09/79	1.990	B	M	4	8	M10B20		81582
520	85	08/72→08/77	1.990	B	M	4	8	M10B20		81582
520 i	96	08/72→10/75	1.990	B	M	4	8	M10B20, M10B20 (Sch	01-1972→, →08-1977	81582
	92	10/75→05/77	1.990	B	M	4	8	M10B20	01-1972→, →08-1977	81582
520/6	90	09/77→05/81	1.990	B	M	6	12	M20B20	09-1977→, →05-1981	81583
528 i	130	04/77→05/81	2.788	B	M	6	12	M30B28	04-1978→	81618
	135	04/77→05/81	2.788	B	M	6	12	M30B28	04-1978→	81618
M 535 i	160	06/80→08/81	3.453	B	M	6	12	M30B35 (Motronic,9.3:1)		81618

### 5 II (E28)

518	66	06/81→08/84	1.766	B	M	4	8	M10B18	→04-1982	81582
	66	06/81→08/84	1.766	B	M	4	8	M10B18	05-1982→	81584
518i	75	09/81→08/84	1.776	B	M	4	8	M10B18 (K-Jetronic)	→04-1982	81582
	75	09/81→08/84	1.776	B	M	4	8	M10B18 (K-Jetronic)	05-1982→	81584
	77	09/83→12/87	1.766	B	M	4	8	M10B18		81584
520 i	92	06/81→12/87	1.990	B	M	6	12	M20B20, M20B20 (L-Jetronic)	→09-1987	81586
	92	06/81→12/87	1.990	B	M	6	12	M20B20, M20B20 (L-Jetronic)	10-1987→	81616
	95	08/85→12/87	1.990	B	M	6	12	M20B20	→09-1987	81586
	95	08/85→12/87	1.990	B	M	6	12	M20B20	10-1987→	81616
	110	12/86→06/90	1.990	B	M	6	12		→09-1987	81586
	110	12/86→06/90	1.990	B	M	6	12		10-1987→	81616
524 d	63	03/86→12/87	2.443	D	M	6	12	M21D24W		81585
524 td	85	09/83→12/87	2.443	D	M	6	12	M21D24WA		81585
525 e 2.7	90	09/81→12/87	2.693	B	M	6	12	M20B27		81586
	92	05/83→12/87	2.693	B	M	6	12	M20B27		81586
	95	12/84→12/87	2.693	B	M	6	12	M20B27	01-1983→, →12-1988	81586
525 i	110	06/81→12/87	2.495	B	M	6	12	M30B25 (L-Jet.)		81618
	135	06/81→12/87	2.788	B	M	6	12	M30B28		81618
535 i, M 535 i	136	01/85→12/87	3.430	B	M	6	12	M30B35		81618
	141	01/85→12/87	3.430	B	M	6	12	M30B35 (Motronic)		81618
	160	01/85→12/87	3.430	B	M	6	12	M30B35		81618
M5 3.5	211	08/85→12/87	3.453	B	M	6	24	S38B35		81618

	kW		Cap. cm3	Fuel	Gear	No. of cyl.	No. of valves	Motor code		Short
--	----	--	----------	------	------	-------------	---------------	------------	--	-------

## BMW

### 5 III (E34), TOURING

518 g	85	11/95→06/96	1.796	BF	M	4	8	M43B18		81589
518 i	83	03/93→09/94	1.796	B	M	4	8	M40B18		81589
	83	08/89→09/95	1.796	B	M	4	8	M40B18	04-1989→, →08-1991	81587
	85	08/89→01/97	1.796	B	M	4	8	M43B18	10-1991→, →12-1995, DST:CND	81589
	85	08/89→09/95	1.796	B	M	4	8	M43B18	01-1993→, DST:CTN	81590
	85	08/89→09/95	1.796	B	M	4	8	M43B18	→09-1991, DST:CND	81587
520 i	95	01/88→08/91	1.990	B	M	6	12	M20B20		81616
	110	11/91→01/97	1.991	B	M	6	24	M50B (206S1), M50B (206S2)Vanos		81588
520 i 24V	110	09/89→09/95	1.991	B	M	6	24	M50B (206S1), M50B (206S2)Vanos		81588
524 td	85	03/88→09/95	2.443	D	M	6	12	M21D24, M21D24WA	03-1988→, →09-1991	81617
525 i	125	01/88→08/91	2.494	B	M	6	12	M20B25		81616
	141	11/91→01/97	2.494	B	M	6	24	M50B25		81588
525 i 24V	141	09/89→09/95	2.494	B	M	6	24	M50B25, M52B25 (Vanos)		81588
525 i X	141	02/92→01/97	2.494	B	M	6	24	M50B25, M52B25 (Vanos)		81588
525 i X 24V	141	10/91→09/95	2.494	B	M	6	24	M52B25 (Vanos)		81588
525 td	85	03/93→01/97	2.497	D	M	6	12	M51D25		81597
525 tds	105	09/91→01/97	2.503	D	M	6	12	M51D25 (Inter.)		81597
530 i	138	01/88→08/91	2.986	B	M	6	12	M30B30	03-1988→, →08-1990	81618
535 i	155	01/88→09/95	3.430	B	M	6	12	M30B35		81618
M5 3.6	232	10/88→05/92	3.535	B	M	6	24	S38B36		81618
M5 3.6 Cat.	232	10/88→05/92	3.535	B	M	6	24	S38B36 (Kat)	03-1988→, →06-1994	81618

### 5 IV (E39), TOURING

520 d	100	02/00→09/03	1.951	D	M	4	16	M47204D1, M47D20		81794
520 i	100	04/99→05/04	1.991	B	M	6	24	M52B (206S3)Vanos		81588
	110	01/96→09/00	1.991	B	M	6	24	M52B (206S3)Vanos, M52B (206S4)		81588
	125	09/00→05/04	2.171	B	M	6	24	M54B22		81588
523 i	125	11/95→09/00	2.494	B	M	6	24	M52B25 (Vanos)		81588
525 d	120	02/00→05/04	2.497	D	M	6	24	M57256D1		81795
525 i	141	09/00→05/04	2.494	B	M	6	24	M54256S5		81588
525 td	85	01/97→06/03	2.497	D	M	6	12	M51D25		81597
525 tds	105	01/96→05/04	2.503	D	M	6	12	M51D25 (Inter.)		81597
528 i	142	11/95→09/00	2.793	B	M	6	24	M52B28		81588
530 d	135	08/98→09/00	2.926	D	M	6	24	M57D30	09-1999→, →09-2000	81795
	135	08/98→09/00	2.926	D	M	6	24	M57D30	08-1998→, →08-1999	81796
530 d	142	09/00→05/04	2.926	D	M	6	24	M57D30		81795
530 i	170	09/00→05/04	2.979	B	M	6	24	M54306S3		81588
540 i	210	01/97→05/04	4.398	B	M	8	32	M62448S2, M62B44	09-1998→, →05-2004	81796

### 5 V (E60), TOURING (E61)

520d	110	09/05	1.995	D	M	4	16	M47N204D4		82040
	120	07/05	1.995	D	M	4	16	M47N204D5		82040
520i	125	07/03	2.171	B	M	6	24	M54226S1		81588
525d	120	12/04	2.497	D	M	6	24	M57256D1, M57N256D4		82040



	kW		Cap. cm3	Fuel	Gear	No. of cyl.	No. of valves	Motor code		MAGNETI MARELLI Short
--	----	--	----------	------	------	-------------	---------------	------------	--	-----------------------

## BMW

### 5 V (E60), TOURING (E61)

525d	130	06/04	2.497	D	M	6	24	M57N256D4		82040
	145	01/07	2.993	D	M	6	24	M57306D3		82040
525d xDrive	145	09/08	2.993	D	M	6	24	N57306D3		82040
525i	141	09/03	2.494	B	M	6	24	M54256S5		81588
525xd	145	01/07	2.993	D	M	6	24	M57306D3		82040
530d	160	07/03	2.993	D	M	6	24	N57306D2	04-2004→	82040
	170	07/03	2.993	D	M	6	24	M57306D3	04-2004→	82040
	173	01/07	2.993	D	M	6	24	M57306D3		82040
530d xDrive	173	09/08	2.993	D	M	6	24			82040
	173	09/08	2.993	D	M	6	24			82043
530i	170	07/03	2.979	B	M	6	24	M54306S3		81588
530xd	173	01/07	2.993	D	M	6	24	M57306D3		82040
	170	07/05	2.993	D	M	6	24	M57306D3		82040
535d	210	01/07	2.993	D	M	6	24	M57N306D5		82040
	200	09/04	2.993	D	M	6	24	M57306D4		82040

### 6 (E24)

628 CSI	135	09/79→08/87	2.788	B	M	6	12	M30B28	09-1978→, →12-1987	81618
633 CSI	145	09/78→08/84	3.210	B	M	6	12	M30B32, M30B32 (L-Jetronic,9:1)	09-1979→, →12-1983	81618
635 CSI	136	01/85→05/89	3.430	B	M	6	12	M30B35 (Motronic,8:1,Kat.)	09-1979→, →12-1988	81618
	141	04/85→09/90	3.430	B	M	6	12	M30B35	09-1979→, →12-1988	81618
	155	08/87→05/89	3.430	B	M	6	12	M30B35	09-1979→, →12-1988	81618
M 635 CSI	211	03/84→05/89	3.453	B	M	6	24	S38B35	09-1979→, →12-1988	81618
	191	10/86→10/88	3.453	B	M	6	12	S38B35 (Kat)	09-1979→, →12-1988	81618

### 6 II (E63), CABRIO (E64)

635d	210	07/07	2.993	D	M	6	24	M57N306D5, N57N306D5		82040
------	-----	-------	-------	---	---	---	----	----------------------	--	-------

### 7 I (E23)

728 i	135	07/78→08/86	2.788	B	M	6	12	M30B28	01-1977→, →08-1979	81618
732 i/733 i	145	05/77→09/79	3.210	B	M	6	12	M30B32, M30B32 (L-Jetronic,9:1), M30B32 (Motronic,10:1)	08-1979→	81618
735 i	136	01/85→08/86	3.430	B	M	6	12	M30B35 (Motronic,8:1,Kat.)	09-1979→, →12-1987	81618
	141	04/85→08/86	3.430	B	M	6	12	M30B35 (Motronic)	09-1979→, →12-1987	81618
	160	09/79→08/86	3.453	B	M	6	12	M30B35 (Motronic,10:1), M30B35 (Motronic,9.3:1)	09-1979→, →12-1987	81618
745 i	185	04/80→04/83	3.210	B	M	6	12	M30B32 (Turbo), M30B32 (Turbo,8:1)	04-1980→, →12-1987	81618
	185	05/83→08/86	3.430	B	M	6	12	M30B35	04-1980→, →12-1987	81618

### 7 II (E32)

730 i,iL	138	12/86→09/94	2.986	B	M	6	12	M30B30		81618
	145	12/86→09/94	2.986	B	M	6	12	M30B30		81618
735 i,iL	155	09/86→09/92	3.430	B	M	6	12	M30B35		81618
	162	09/86→12/87	3.430	B	M	6	12	M30B35 (Motronic,9.2:1)		81618

### 7 III (E38)

725 tds	105	04/96→11/01	2.503	D	M	6	12	M51D25 (Inter.)		81597
728 i,iL	142	08/95→11/01	2.793	B	M	6	24	M52B28		81588
728i X	142	11/95→09/01	2.793	B	M	6	24			81588
730 d	135	08/98→04/00	2.926	D	A	6	24	M57D30	10-1999→	81795

	kW		Cap. cm3	Fuel	Gear	No. of cyl.	No. of valves	Motor code		Short
<b>BMW</b>										
<b>7 III (E38)</b>										
730 d	135	08/98→04/00	2.926	D	A	6	24	M57D30	→09-1999	81796
	142	04/00→11/01	2.926	D	A	6	24	M57306D1		81795
<b>7 IV (E65, E66)</b>										
730 d	160	10/02	2.993	D	M	6	24	M57N2306D2		82034
730 i, Li	170	03/03	2.979	B	M	6	24	M54306S3		81588
730 Ld	170	07/05	2.993	D	M	6	24	N57N306D2		82034
<b>X3 I (E83)</b>										
2.0 i	110	07/05	1.995	B	M	4	16	N46B20A		82010
2.5 i	141	01/04	2.494	B	M	6	24	M54256S5		81588
3.0 d	150	01/04	2.993	D	M	6	24	M54N306D2		82040
	160	01/04	2.993	D	M	6	24	M57N2306D2		82040
3.0 i	170	01/04	2.979	B	M	6	24	M54306S3		81588
3.0 sd	210	09/06	2.993	D	M	6	24	M57306D5		82040
xDrive20i	110	09/08	1.995	B	M	4	16			82010
xDrive35d	210	09/08	2.993	D	M	6	24	N57N306D5		82040
<b>X5 (E53)</b>										
3.0 d	135	05/01	2.925	D	A	6	24	M57306D1		81795
	160	12/03	2.993	D	M	6	24	M57N306D4		82034
3.0 i	163	05/00	2.979	B	M	6	24	M54306S3		81588
	170	05/00	2.979	B	M	6	24	M54306S3		81588
<b>X5 (E70)</b>										
3.0 d	173	02/07	2.993	D	M	6	24	M57306D3		82040
3.0 sd	210	09/07	2.993	D	M	6	24	M57N306D5		82040
xDrive30d	173	09/08	2.993	D	M	6	24			82040
xDrive35d	210	09/08	2.993	D	M	6	24			82040
<b>X6</b>										
30d	173	05/08	2.993	D	M	6	24			82040
35d	210	05/08	2.993	D	M	6	24	N57N306D5		82040
XDrive30d	173	09/08	2.993	D	M	6	24			82040
xDrive35d	210	09/08	2.993	D	M	6	24	N57N306D5		82040
<b>Z1</b>										
2.5	125	06/88→06/91	2.494	B	M	6	12	M20B25	11-1988→, →10-1991	81616
<b>Z3, COUPÉ</b>										
1.8	85	10/95→10/98	1.796	B	M	4	8	M43B18	M: M42B18	81590
1.9	85	01/99→01/03	1.895	B	M	4	8	M43194E1	M: M44B19 C	81590
	87	07/98→01/03	1.895	B	M	4	8	M43194E1, M43B19		81590
	103	10/95→03/99	1.895	B	M	4	16	M44B19	M: M44B19 C	81590
2.0	110	04/99→01/03	1.991	B	M	6	24	M52B (206S4)	04-1999→	81588
2.2	125	08/00→01/03	2.171	B	M	6	24	M54226S1, M54B22		81588
2.8	141	04/97→06/00	2.793	B	M	6	24	M52B28		81588
3.0	170	06/00→06/03	2.979	B	M	6	24	M54306S3		81588
<b>Z4 I, COUPÉ</b>										
2.0 i	110	04/05	1.995	B	M	4	16	N46B20A		82010
2.2 i	125	10/03	2.171	B	M	6	24	M54226S1		81588
2.5 i	141	02/03	2.494	B	M	6	24	M54256S5		81588
3.0 i	170	02/03	2.979	B	M	6	24	M54306S3		81588

	kw		Cap. cm3	Fuel	Gear	No. of cyl.	No. of valves	Motor code		MAGNETI MARELLI Short
<b>CHEVROLET</b>										
<b>AVEO</b>										
1.2	53	03/06	1.150	B	M	4	8	F12S3		81783
1.4	69	03/06	1.399	B	M	4	16	F14D3		81782
1.5	62	05/05	1.498	B	M	4	8	F15S3		81781
1.6	77	12/04→09/06	1.598	B	M	4	16	A16DMS		81782
<b>CAPTIVA</b>										
2.4	100	06/06	2.405	B	M	4	16	Z24SED		81550
	103	12/06	2.405	B	M	4	16	Z24SED		81550
2.4 AWD	103	12/06	2.405	B	M	4	16	Z24SED		81550
2.4 FWD	100	06/06	2.405	B	M	4	16	Z24SED		81550
2.4 LPG	100	01/07	2.405		M	4	16			81550
2.4 LPG 4WD	100	01/07	2.405		M	4	16			81550
<b>CRUZE II</b>										
1.6	82	05/09	1.598	B	M	4	16			82083
	83	05/09	1.598	B	M	4	16			82083
1.8	102	05/09	1.796	B	M	4	16			82083
	104	05/09	1.796	B	M	4	16			82083
<b>EVANDA</b>										
2.0	96	03/05	1.998	B	M	4	16	X20SED		81550
<b>KALOS</b>										
1.2	53	03/05	1.150	B	M	4	8	B12S1		81781
	53	03/05	1.150	B	M	4	8	F12S3		81783
1.4	61	03/05	1.399	B	M	4	8	F14S3		81782
1.4 16V	69	03/05	1.399	B	M	4	16	F14D3		81782
<b>LACETTI</b>										
1.4 16V	70	03/05	1.399	B	M	4	16	F14D3		81782
1.6	80	03/05	1.598	B	M	4	16	F16D3		81782
1.8	89	08/05	1.796	B	M	4	16	F18D3		81782
	90	03/05	1.799	B	M	4	16	T18SED		81782
<b>MATIZ</b>										
0.8	38	03/05	796	B	M	3	6	F8CV		81783
0.8 LPG	38	03/05	796		M	3	6	F8CV		81783
1.0	47	03/05	995	B	M	4	8	B10S		81783
	49	03/05	995	B	M	4	8	B10S1		81783
1.0 LPG	49	03/05	995		M	4	8	B10S1		81783
<b>NUBIRA, STATION WAGON</b>										
1.4	69	01/05	1.399	B	M	4	16	F14D3		81782
1.6	80	03/05	1.598	B	M	4	16	F16D3		81782
1.8	89	08/05	1.796	B	M	4	16	F18D3		81782
	90	03/05	1.799	B	M	4	16	T18SED		81782
<b>REZZO</b>										
1.6	77	03/05	1.598	B	M	4	16	A16DMS		81782
	79	08/05	1.598	B	M	4	16	A16DMS		81782
2.0	89	03/05	1.998	B	M	4	16	T20SED		81550
	90	08/05	1.998	B	M	4	16	T20SED		81550

	kW		Cap. cm3	Fuel	Gear	No. of cyl.	No. of valves	Motor code		Short
--	----	--	----------	------	------	-------------	---------------	------------	--	-------

## CHEVROLET

### SPARK I

0.8	38	09/00	796	B	M	3	6	F8CV		81783
1.0	47	11/02	993	B	M	4	8	G10CV		81783

### SPARK II

0.8	37	05/05	796	B	M	3	6	F8CV		81783
1.0 SX	46	05/05	995	B	M	4	8			81783

## CHRYSLER

### 300 C, TOURING

3.0 CRD	160	09/05	2.987	D	M	6	24	M664		82058
---------	-----	-------	-------	---	---	---	----	------	--	-------

### NEON I

1.8 16V	85	09/97→08/99	1.796	B	M	4	16	EBD		81733
2.0 16V	98	05/94→08/99	1.996	B	M	4	16	420H		81733
	107	06/94→08/99	1.996	B	M	4	16	ECC		81733
	109	04/96→08/99	1.996	B	M	4	16	420T		81733

### NEON II

1.6	85	11/01	1.598	B	M	4	16	EJD		81733
2.0 16V	98	08/99	1.996	B	M	4	16	420H		81733
2.0 16V R/T	110	10/01	1.996	B	M	4	16	ECH		81733

### PT CRUISER, CABRIO

1.6	85	11/01	1.598	B	M	4	16	EJD		81733
2.0	104	06/00	1.996	B	AM	4	16	ECC		81733
	100	10/04	1.996	B	M	4	16	ECC		81733

### SEBRING II, CABRIO

2.0	104	04/01	1.996	B	M	4	16	ECC		81733
-----	-----	-------	-------	---	---	---	----	-----	--	-------

### SEBRING III, CABRIO

2.0 CRD	103	07/07	1.968	D	M	4	16			81816
---------	-----	-------	-------	---	---	---	----	--	--	-------

### STRATUS, CABRIO

2.0 16V	98	12/95	1.996	B	M	4	16	ECB		81733
2.0 LE	96	12/95→04/01	1.996	B	M	4	16	420X, C00		81733

### VOYAGER I

2.5 i	72	08/84→09/95	2.501	B	M	4	8	K00		81302
	74	08/90→09/95	2.501	B	M	4	8	K		81302
2.5 TD	87	01/92→09/95	2.500	D	M	4	8	09B, M00		81302

### VOYAGER II

2.0 i	98	01/95→03/01	1.995	B	M	4	16	C00		81733
2.5 TD	85	01/95→03/01	2.499	D	M	4	8	425CLIRS/X	(-)COP	81362

## CITROËN

### AX

10	32	09/86→06/92	954	B	M	4	8	C1A		81556
	33	07/86→12/98	954	B	M	4	8	CDY (TU9M)		81556
	37	02/87→12/98	954	B	M	4	8	CDZ (TU9M)		81556
10 E	30	12/86→12/88	954	B	M	4	8	C3A		81556
11	40	12/86→04/94	1.124	B	M	4	8	H1A, H1B	12-1986→	81556
	44	09/86→12/97	1.124	B	M	4	8	H1B, HDZ (TU1M)		81556
11 4x4	40	06/91→07/92	1.124	B	M	4	8	H1A		81556

	kw		Cap. cm3	Fuel	Gear	No. of cyl.	No. of valves	Motor code		Short
--	----	--	----------	------	------	-------------	---------------	------------	--	-------

## CITROËN

AX										
11 Cat	40	09/88→12/89	1.124	B	M	4	8	HAZ (TU1CP)	09-1988→	81556
13 Sport	70	04/87→12/88	1.294	B	M	4	8	M4A		81556
14	44	12/86→12/88	1.360	B	M	4	8	KAY (TU3CP)		81556
	49	06/88→12/89	1.360	B	M	4	8	K1F		81556
	55	04/87→04/97	1.360	B	M	4	8	KDX (TU3M/Z), KDY (TU3FM), KDY (TU3M), KDZ (TU3M/Z)	08-1992→	81513
	55	04/87→04/97	1.360	B	M	4	8	KDX (TU3M/Z), KDY (TU3FM), KDY (TU3M), KDZ (TU3M/Z)	→12-1993	81556
	62	01/88→12/92	1.360	B	M	4	8	K2A, K2B		81556
14 4x4	55	08/91→12/96	1.360	B	M	4	8	KDX (TU3M/Z), KDY (TU3FM), KDY (TU3M), KDZ (TU3M/Z)	08-1992→	81513
	62	09/86→07/92	1.360	B	M	4	8	K2A		81556
	39	06/91→07/92	1.360	D	M	4	8	K9A (TUD3)		81556
14 Allure	48	08/92→04/94	1.360	B	M	4	8			81513
14 D	37	08/91→12/97	1.360	D	M	4	8	K9Y (TUD3Y)	01-1993→	81556
	38	09/88→06/92	1.360	D	M	4	8	K9A (TUD3)		81556
14 GTI	66	08/91→12/96	1.360	B	M	4	8	KFY (TU3FJ2)	08-1992→	81513
	69	06/91→12/96	1.360	B	M	4	8	KFZ (TU3FJ2)	08-1992→	81513
	74	06/91→12/92	1.360	B	M	4	8	KFZ (TU3FJ2)	PROD→: 5.279	81513
	74	06/91→12/92	1.360	B	M	4	8	KFZ (TU3FJ2)	→PROD: 5.278	81556
15 D	40	08/94→12/97	1.527	D	M	4	8	VJY (TUD5)	05-1994→	81513
	43	08/94→12/97	1.527	D	M	4	8	VJZ (TUD5)		81513

## BERLINGO I, FURGONATO

1.1 i	44	07/96	1.124	B	M	4	8	HDZ (TU1M), HFX (TU1JP)	→M: 3.762.433	81556
	44	07/96	1.124	B	M	4	8	HDZ (TU1M), HFX (TU1JP)	M→: 3.762.434	81797
1.4	48	11/02	1.360	G	M	4	8			81797
	53	11/02→10/05	1.360	B	M	4	8			81797
	53	11/02→10/05	1.360	BF	M	4	8			81797
	54	05/05	1.360		M	4	8			81797
1.4 bivalent	48	11/02	1.360	BF	M	4	8			81797
1.4 GNC	48	11/02	1.360	G	M	4	8			81797
1.4 i	55	07/96	1.360	B	M	4	8	KFW (TU3JP), KFX (TU3JP)	→M: 3.666.765	81556
	55	07/96	1.360	B	M	4	8	KFW (TU3JP), KFX (TU3JP)	M→: 3.666.766	81797
1.4 i bivalent	55	04/03	1.360	BF	M	4	8	KFW (TU3JP)		81797
1.6	81	11/02	1.587	B	M	4	16	NFU (TU5JP4)		81753
1.6 16V	80	10/00	1.587	B	M	4	16	NFU (TU5JP4)		81753
1.6 HDi	80	08/05	1.560	D	M	4	16	DV6TED4		81869
1.6 HDI 75	55	07/05	1.560	D	M	4	16	DV6B		81869
1.6 HDI 90	66	07/05	1.560	D	M	4	16	DV6ATED4		81869
1.8 D	43	07/96	1.769	D	M	4	8	A9A (XUD7)	07-1996→	81642
1.8 i	66	05/97→10/02	1.761	B	M	4	8	LFX (XU7JB)	01-1998→	81512
1.8 i 4WD	66	04/97	1.761	B	M	4	8	LFX (XU7JB)	01-1998→	81512
1.8 X	44	11/96→10/99	1.769	D	M	4	8			81642
1.9 D	50	07/96	1.905	D	M	4	8	D9B (XUD9A/L), DJY (XUD9A)	07-1996→	81642
	51	07/96→10/99	1.905	D	M	4	8	DJY (XUD9A)	07-1996→	81642
	51	07/98	1.868	D	M	4	8	WJY (DW8B), WJZ (DW8)		81713

	kW		Cap. cm3	Fuel	Gear	No. of cyl.	No. of valves	Motor code		Short
--	----	--	----------	------	------	-------------	---------------	------------	--	-------

## CITROËN

### BERLINGO I, FURGONATO

1.9 D 4WD	51	07/98	1.868	D	M	4	8	WJZ (DW8)		81713
1.9 D 70	51	04/99	1.868	D	M	4	8	WJZ (DW8)		81713
1.9 D 70 4WD	51	07/98	1.868	D	M	4	8	WJZ (DW8)		81713
2.0 HDi	66	11/02→10/05	1.997	D	M	4	8	DW10TD		81713
2.0 HDi 4x4	66	11/02→10/05	1.997	D	M	4	8	DW10TD		81713
2.0 HDi 90	66	12/99	1.997	D	M	4	8	RHY (DW10TD)		81713
2.0 HDi 90 4WD	66	11/00	1.997	D	M	4	8	RHY (DW10TD)		81713

### BERLINGO II, FURGONATO

1.6	66	04/08	1.587	B	M	4	16	NFR (TU5JP4B)		81753
	80	04/08	1.587	B	M	4	16	NFU (TU5JP4)		81753
1.6 HDi	55	04/08	1.560	D	M	4	16	9HT (DV6BTED4), 9HT (DV6BUTED4)		81869
	66	04/08	1.560	D	M	4	16	9HX (DV6ATED4)		81869
	80	04/08	1.560	D	M	4	16	9HZ-DV6TED4		81869
1.6 HDi 110	82	07/10	1.560	D	M	4	16			81869
1.6	88	11/09	1.598	B	M	4	16			82032

### BX, BREAK

11	40	10/88→06/92	1.124	B	M	4	8	HDZ (TU1M)	10-1989→, PROD→: 4193	81556
	40	10/88→06/92	1.124	B	M	4	8	HDZ (TU1M)	→09-1989, →PROD: 4192	81572
	42	10/86→06/92	1.124	B	M	4	8		10-1989→, PROD→: 4193	81556
	42	10/86→06/92	1.124	B	M	4	8		→09-1989, →PROD: 4192	81572
14	47	01/89→12/89	1.360	B	M	4	8	K1H (TU3A)	10-1989→, PROD→: 4193	81556
	47	01/89→12/89	1.360	B	M	4	8	K1H (TU3A)	→09-1989, →PROD: 4192	81572
	53	01/86→02/93	1.360	B	M	4	8	150C	02-1992→, PROD→: 5440	81513
	53	01/86→02/93	1.360	B	M	4	8	150C	10-1989→, →01-1992, PROD→: 4193, →PROD: 5440	81556
	53	01/86→02/93	1.360	B	M	4	8	150C	→09-1989, →PROD: 4192	81572
	55	01/89→02/93	1.360	B	M	4	8	KDY (TU3M), KDZ (TU3M/Z)	02-1992→, PROD→: 5440	81513
	55	01/89→02/93	1.360	B	M	4	8	KDY (TU3M), KDZ (TU3M/Z)	10-1989→, →01-1992, PROD→: 4193, →PROD: 5440	81556
	55	01/89→02/93	1.360	B	M	4	8	KDY (TU3M), KDZ (TU3M/Z)	→09-1989, →PROD: 4192	81572
14 E	45	10/82→06/88	1.360	B	M	4	8	150A	→PROD: 4192	81572
	49	09/85→02/93	1.360	B	M	4	8	150F	02-1992→, PROD→: 5440	81513
	49	09/85→02/93	1.360	B	M	4	8	150F	10-1989→, →01-1992, PROD→: 4193, →PROD: 5440	81556

	kW		Cap. cm3	Fuel	Gear	No. of cyl.	No. of valves	Motor code		Short
--	----	--	----------	------	------	-------------	---------------	------------	--	-------

## CITROËN

### BX, BREAK

14 E	49	09/85→02/93	1.360	B	M	4	8	150F	→09-1989, →PROD: 4192	81572
	52	04/83→07/89	1.360	B	M	4	8	150C	→PROD: 4192	81572
	53	04/83→02/93	1.360	B	M	4	8	150C	02-1992→, PROD→: 5440	81513
	53	04/83→02/93	1.360	B	M	4	8	150C	10-1989→, →01-1992, PROD→: 4193, →PROD: 5440	81556
	53	04/83→02/93	1.360	B	M	4	8	150C	→09-1989, →PROD: 4192	81572
	59	10/85→05/89	1.360	B	M	4	8		→PROD: 4192	81572
15	59	10/87→05/92	1.580	B	M	4	8	B1E (XU51C)		81512
16	53	01/87→12/94	1.580	B	M	4	8	B1E (XU51C)	02-1992→, PROD→: 5410	81512
	53	01/87→12/94	1.580	B	M	4	8	B1E (XU51C)	→01-1992, →PROD: 5409	81554
	55	09/88→12/94	1.580	B	M	4	8	BAY (XU5CP), BAZ (XU5CP)	02-1992→, PROD→: 5410	81512
	55	09/88→12/94	1.580	B	M	4	8	BAY (XU5CP), BAZ (XU5CP)	→01-1992, →PROD: 5409	81554
	58	09/87→02/93	1.580	B	M	4	8	B1A (XU51C/K)	02-1992→, PROD→: 5410	81512
	58	09/87→02/93	1.580	B	M	4	8	B1A (XU51C/K)	→01-1992, →PROD: 5409	81554
	64	07/85→12/94	1.580	B	M	4	8	171D	02-1992→, PROD→: 5410	81512
	64	07/85→12/94	1.580	B	M	4	8	171D	→01-1992, →PROD: 5409	81554
	65	05/89→12/94	1.580	B	M	4	8	BDY (XU5M), BDZ (XU5M)	02-1992→, PROD→: 5410	81512
	65	05/89→12/94	1.580	B	M	4	8	BDY (XU5M), BDZ (XU5M)	→01-1992, →PROD: 5409	81554
	66	10/82→06/88	1.580	B	M	4	8	171A, 171B, 171C	→PROD: 5.409	81554
	68	10/82→12/92	1.580	B	M	4	8	XU52C	02-1992→, PROD→: 5410	81512
	68	10/82→12/92	1.580	B	M	4	8	XU52C	→01-1992, →PROD: 5409	81554
	76	03/86→12/94	1.580	B	M	4	8	180Z	02-1992→, PROD→: 5410	81512
	76	03/86→12/94	1.580	B	M	4	8	180Z	→01-1992, →PROD: 5409	81554
85	01/87→01/92	1.580	B	M	4	8	B6D		81554	
16 E	65	05/89→02/93	1.580	B	M	4	8	BDY (XU5M), BDZ (XU5M)	02-1992→, PROD→: 5410	81512
	65	05/89→02/93	1.580	B	M	4	8	BDY (XU5M), BDZ (XU5M)	→01-1992, →PROD: 5409	81554

	kW		Cap. cm3	Fuel	Gear	No. of cyl.	No. of valves	Motor code		Short
<b>CITROËN</b>										
<b>BX, BREAK</b>										
18 D	44	10/85→09/93	1.769	D	M	4	8	161 (XUD7)	→12-1986, →PROD: 3583	<b>81554</b>
	44	10/85→09/93	1.769	D	M	4	8	161 (XUD7)	01-1987→, PROD→: 3584	<b>81672</b>
	44	10/85→09/93	1.769	D	M	4	8	161A (XUD7)	→12-1986, →PROD: 3583	<b>81554</b>
	44	10/85→09/93	1.769	D	M	4	8	161A (XUD7)	01-1987→, PROD→: 3584	<b>81672</b>
19	70	09/86→12/89	1.905	B	M	4	8	D2C (XU92C)	→PROD: 5.409	<b>81554</b>
	75	07/86→12/94	1.905	B	M	4	8	D2A (XU92C)	02-1992→, PROD→: 5410	<b>81512</b>
	75	07/86→12/94	1.905	B	M	4	8	159A, D2A (XU92C)	→01-1992, →PROD: 5409, →PROD: 5.409	<b>81554</b>
	77	07/86→05/89	1.905	B	M	4	8	D2A (XU92C)	→PROD: 5409	<b>81554</b>
	80	06/88→12/94	1.905	B	M	4	8	DDZ (XU9M)	02-1992→, PROD→: 5410	<b>81512</b>
	80	06/88→12/94	1.905	B	M	4	8	DDZ (XU9M)	→01-1992, →PROD: 5409	<b>81554</b>
	88	06/88→12/94	1.905	B	M	4	8	DKZ (XU9JA)	02-1992→, PROD→: 5410	<b>81512</b>
	88	06/88→12/94	1.905	B	M	4	8	DKZ (XU9JA)	→01-1992, →PROD: 5409	<b>81554</b>
19 4x4	80	10/90→05/91	1.905	B	M	4	8	DDZ (XU9M)	→PROD: 5.409	<b>81554</b>
19 Cat.	75	07/86→12/94	1.905	B	M	4	8	DFZ (XU9J1)	02-1992→, PROD→: 5410	<b>81512</b>
	75	07/86→12/94	1.905	B	M	4	8	DFZ (XU9J1)	→01-1992, →PROD: 5409	<b>81554</b>
19 D	47	09/83→12/87	1.905	D	M	4	8	162 (XUD9), D9A (XUD9)	→12-1986, →PROD: 3583	<b>81554</b>
	47	09/83→12/87	1.905	D	M	4	8	162 (XUD9), D9A (XUD9)	01-1987→, PROD→: 3584	<b>81672</b>
	51	03/87→12/94	1.905	D	M	4	8	D9B (XUD9A/U)	PROD→: 3584	<b>81672</b>
19 DT TXD	66	02/92→12/94	1.905	D	M	4	8			<b>81672</b>
19 E	80	06/88→02/93	1.905	B	M	4	8	DDZ (XU9M)	02-1992→, PROD→: 5410	<b>81512</b>
	80	06/88→02/93	1.905	B	M	4	8	DDZ (XU9M)	→01-1992, →PROD: 5409	<b>81554</b>
19 E 4x4	80	04/89→02/93	1.905	B	M	4	8	D2F	02-1992→, PROD→: 5410	<b>81512</b>
	80	04/89→02/93	1.905	B	M	4	8	D2F	→01-1992, →PROD: 5409	<b>81554</b>
19 GTI	88	06/88→02/93	1.905	B	M	4	8	DKZ (XU9JA)	02-1992→, PROD→: 5410	<b>81512</b>
	88	06/88→02/93	1.905	B	M	4	8	DKZ (XU9JA)	→01-1992, →PROD: 5409	<b>81554</b>



	kW		Cap. cm3	Fuel	Gear	No. of cyl.	No. of valves	Motor code		Short
--	----	--	----------	------	------	-------------	---------------	------------	--	-------

## CITROËN

### BX, BREAK

19 GTi	90	07/86→02/93	1.905	B	M	4	8	D6A (XU9J2)	02-1992→, PROD→: 5410	81512
	90	07/86→02/93	1.905	B	M	4	8	D6A (XU9J2)	→01-1992, →PROD: 5409	81554
	117	01/90→01/92	1.905	B	M	4	8		→PROD: 5409	81554
19 GTi 16V	108	03/88→02/93	1.905	B	M	4	16	DFW (XU9J4)	02-1992→, PROD→: 5410	81512
	108	03/88→02/93	1.905	B	M	4	16	DFW (XU9J4)	→01-1992, →PROD: 5409	81554
	116	09/87→12/88	1.905	B	M	4	16	D6C (XU9J4)	→PROD: 5409	81554
19 GTi 4x4	88	06/88→02/93	1.905	B	M	4	8	DKZ (XU9JA)	02-1992→, PROD→: 5410	81512
	88	06/88→02/93	1.905	B	M	4	8	DKZ (XU9JA)	→01-1992, →PROD: 5409	81554
	92	02/92→06/94	1.905	B	M	4	8		PROD→: 5410	81512
19 RD 4x4	52	01/87→01/92	1.905	D	M	4	8		PROD→: 3584	81672
19 TZi	92	02/92→12/94	1.905	B	M	4	8		PROD→: 5410	81512
TRD Turbo	66	03/88→12/94	1.769	D	M	4	8	A8A (XUD7TE), AJZ (XUD7TE)	PROD→: 3584	81672

### C 1

1.0	50	06/05→	998	B	M	3	12	1KR-FE		82063
1.4 HDi	40	06/05→	1.398	D	M	4	8	DV4D		81798

### C 15, STATION WAGON

1.0	33	10/84→12/97	954	B	M	4	8	TU9, XV8	01-1989→, PROD→: 4193	81556
	33	10/84→12/97	954	B	M	4	8	TU9, XV8	→12-1988, →PROD: 4192	81572
1.0 E	37	11/92→07/96	954	B	M	4	8		PROD→: 4193	81556
	37	11/92→07/96	954	B	M	4	8		→PROD: 4192	81572
1.1	35	10/84→12/96	1.124	B	M	4	8	109K, E1A	01-1989→, PROD→: 4193	81556
	35	10/84→12/96	1.124	B	M	4	8	109K, E1A	→12-1988, →PROD: 4237	81560
	35	10/84→12/96	1.124	B	M	4	8	109K, E1A	→PROD: 4192	81572
	40	11/88→07/96	1.124	B	M	4	8	H1A		81556
1.1 i	44	07/88→12/96	1.124	B	M	4	8	HDZ (TU1M)		81556
1.3	47	07/87→05/88	1.294	B	M	4	8	G1A	→PROD: 4237	81560
	47	07/87→05/88	1.294	B	M	4	8	G1A	→PROD: 4192	81572
1.4	49	07/87→12/96	1.360	B	M	4	8	K1H (TU3A)	PROD→: 4193	81556
	49	07/87→12/96	1.360	B	M	4	8	K1H (TU3A)	→PROD: 4192	81572
1.4 E	40	07/87→12/96	1.360	B	M	4	8	K3A	PROD→: 4193	81556
	40	07/87→12/96	1.360	B	M	4	8	K3A	→PROD: 4192	81572
	44	05/87→12/96	1.360	B	M	4	8	150D (XY7)	PROD→: 4193	81556
	44	05/87→12/96	1.360	B	M	4	8	150D (XY7)	→PROD: 4192	81572
1.4 i	55	05/91→12/96	1.360	B	M	4	8	KDY (TU3FM), KDY (TU3M)	PROD→: 4193	81556
	55	05/91→12/96	1.360	B	M	4	8	KDY (TU3FM), KDY (TU3M)	→PROD: 4192	81572

	kW		Cap. cm3	Fuel	Gear	No. of cyl.	No. of valves	Motor code		Short
--	----	--	----------	------	------	-------------	---------------	------------	--	-------

## CITROËN

### C 1

1.8 D	44	07/86→12/00	1.769	D	M	4	8	161A (XUD7)	→PROD: 3583	81554
	44	07/86→12/00	1.769	D	M	4	8	161A (XUD7)	PROD→: 6265	81642
	44	07/86→12/00	1.769	D	M	4	8	161A (XUD7)	PROD→: 3584, →PROD: 6264	81672
1.9 D	44	12/00→12/05	1.868	D	M	4	8			81713

### C 2, ENTERPRISE

1.1	44	09/03→	1.124	B	M	4	8	HFX (TU1JP)		81797
1.4	54	09/03→	1.360	B	M	4	8	KFV (TU3JP)		81797
	55	10/06→	1.360	B	M	4	8	TU3JP		81797
1.4 16V	65	06/06→	1.360	B	M	4	16	KFU (ET3J4)		82016
1.4 HDi	50	09/03→	1.398	D	M	4	8	8HX (DV4TD)		81798
1.6	80	09/03→	1.587	B	M	4	16	NFU (TU5JP4)		81753
1.6 HDi	80	09/05→	1.560	D	M	4	16	9HZ-DV6TED4		81869
1.6 VTS	90	01/05→	1.587	B	M	4	16	NFS (TU5JP4S)		81753

### C 25

1.8	50	11/81→01/94	1.796	B	M	4	8	169 (XM7T)		81367
1.8 E	51	07/87→02/94	1.796	B	M	4	8	169 (XM7T)		81367
1.9 1400	51	01/88→01/94	1.905	D	M	4	8	DJY (XUD9A)	(-)AC	81822
1.9 4x4	51	01/88→01/94	1.905	D	M	4	8	DJY (XUD9A)	(-)AC	81822
1.9 D	51	07/87→02/94	1.905	D	M	4	8	D9B (XUD9A/U)	(-)AC	81822
1.9 TD	60	04/92→02/94	1.930	D	M	4	8	M705	(-)AC	81822
2.0	62	01/87→03/94	1.971	B	M	4	8	170C (XN1T)		81367
2.0 1000 E	57	11/81→12/86	1.971	B	M	4	8			81367
2.0 1400 E	62	01/87→01/94	1.971	B	M	4	8			81367
2.0 4x4	62	01/90→01/94	1.971	B	M	4	8			81367
2.0 E	58	09/81→03/94	1.971	B	M	4	8	170A (XN1T), 170B (XN1T)		81367
2.5 D	54	10/85→02/94	2.500	D	M	4	8	CRD93L (U25-661)	(-)AC	81822
2.5 D 4x4	54	01/87→02/94	2.500	D	M	4	8	CRD93L (U25-661)	(-)AC	81822
2.5 D Turbo	70	08/87→02/94	2.500	D	M	4	8	CRD93LS (U25-673)	(-)AC	81822
2.5 D Turbo 4x4	70	08/87→02/94	2.500	D	M	4	8	CRD93LS (U25-673)	(-)AC	81822
2.5 DT 1400	70	01/87→01/94	2.498	D	M	4	8	CRD93LS (U25-673)	(-)AC	81822

### C 3, PICASSO, PLURIEL

1.1	44	11/09→	1.124	B	M	4	8			81797
1.1 i	44	02/02→	1.124	B	M	4	8	HFX (TU1JP)		81797
1.4	54	05/03→	1.360	B	M	4	8	KFV (TU3JP)		81797
	70	02/09→	1.397	B	M	4	16			82032
1.4 16V	65	12/03→	1.360	B	M	4	16	KFU (ET3J4)		82016
1.4 16V HDi	66	02/02→	1.398	D	M	4	16	8HY (DV4TED4)		81798
1.4 HDi	50	02/02→	1.398	D	M	4	8	8HX (DV4TD), 8HZ (DV4TD)		81798
	55	05/05→	1.398	D	M	4	8			81798
1.4 i	54	02/02→	1.360	B	AM	4	8	KFV (TU3JP)		81797
1.4 i Bivalent	54	02/02→	1.360	BF	AM	4	8	KFV (TU3JP)		81797
1.6	80	05/03→	1.587	B	M	4	16	NFU (TU5JP4)		81753
	88	02/09→	1.598	B	M	4	16			82032
1.6 16V	80	02/02→	1.587	B	M	4	16	NFU (TU5JP4)		81753
	88	11/09→	1.598	B	M	4	16			82032

	kW		Cap. cm3	Fuel	Gear	No. of cyl.	No. of valves	Motor code		MAGNETI MARELLI Short
--	----	--	----------	------	------	-------------	---------------	------------	--	-----------------------

## CITROËN

### C 3, PICASSO, PLURIEL

1.6 16V HDi	66	10/05→	1.560	D	M	4	16	9HX (DV6ATED4)		81869
	80	09/05→	1.560	D	M	4	16	DV6TED4		81869
1.6 HDi	66	02/09→	1.560	D	M	4	16	9HX (DV6ATED4), DV6ATED4		81869
	68	11/09→	1.560	D	M	4	16			81869
	80	02/09→	1.560	D	M	4	16	9HZ-DV6TED4		81869
	82	11/09→	1.560	D	M	4	16			81869
1.6 HDi 90	68	07/10→	1.560	D	M	4	16			81869

### C 35

2.0	65	11/73→01/94	1.985	B	M	4	8	B20614	BC	81493
2.2 D	45	11/73→01/80	2.175	D	M	4	8	B22615	BC	81493
2.5 D	51	02/80→01/94	2.498	D	M	4	8	B25637	BC	81493

### C 4 I, COUPÉ

1.4 16V	65	11/04→	1.360	B	M	4	16	KFU (ET3J4)		82016
1.6 16V	80	11/04→	1.587	B	M	4	16	NFU (TU5JP4)		81753
1.6 16V Bio-Flex	80	09/07→	1.587	FF	M	4	16	NFU (TU5JP4)		81753
1.6 HDi	80	07/06→	1.560	D	M	4	16	DV6TED4		81869
1.6 HDi 110 FAP	80	11/04→	1.560	D	M	4	16	DV6TED4		81869
1.6 HDi 90	66	11/04→	1.560	D	M	4	16	9HX (DV6ATED4)		81869
1.6 THP 140	103	07/08→	1.598	B	M	4	16			82032
1.6 THP 150	110	07/08→	1.598	B	M	4	16	5FX (EP6DT)		82032
1.6 VTi 120	88	07/08→	1.598	B	M	4	16			82032
2.0 16V	100	11/04→	1.997	B	M	4	16	RFN (EW10J4)	(-)COP	81799
	100	11/04→	1.997	B	M	4	16	RFN (EW10J4)	(+)COP	82089
	103	11/04→	1.997	B	M	4	16	EW10A	(-)COP	81799
	103	11/04→	1.997	B	M	4	16	EW10A	(+)COP	82089
	130	11/04→	1.997	B	M	4	16	EW10J4S	(-)COP	81799
	130	11/04→	1.997	B	M	4	16	EW10J4S	(+)COP	82089
2.0 HDi	103	07/08→	1.997	D	M	4	16			81800

### C 4 I, COUPÉ

2.0 HDi 135 FAP	100	11/04→	1.997	D	M	4	16	DW10BTED4		81800
2.0 HDi 135 FFAP	100	11/04→	1.997	D	M	4	16	DW10BTED4		81800

### C 4 II

1.6 HDi	68	11/09→	1.560	D	M	4	16			81869
	82	11/09→	1.560	D	M	4	16			81869
1.6 16V	88	11/09→	1.598	B	M	4	16			82032
	115	11/09→	1.598	B	M	4	16			82032

### C 4 PICASSO, GRAN PICASSO

1.6 16V	110	07/08→	1.598	B	M	4	16	5FX (EP6DT)		82032
1.6 HDi 110FAP	80	10/06→	1.560	D	M	4	16	9HZ-DV6TED4		81869
1.6 THP 140	103	07/08→	1.598	B	M	4	16			82032
1.6 VTi 120	88	07/08→	1.598	B	M	4	16			82032
1.8 16V	92	02/07→	1.749	B	M	4	16	6FY-EW7A	(-)COP	81799
	92	02/07→	1.749	B	M	4	16	6FY-EW7A	(+)COP	82089
1.8 i 16V	92	10/06→	1.749	B	M	4	16	6FY-EW7A	(-)COP	81799
	92	10/06→	1.749	B	M	4	16	6FY-EW7A	(+)COP	82089

	kW		Cap. cm3	Fuel	Gear	No. of cyl.	No. of valves	Motor code		Short
--	----	--	----------	------	------	-------------	---------------	------------	--	-------

## CITROËN

### C 4 PICASSO, GRAN PICASSO

2.0 16V	103	02/07→	1.997	B	M	4	16	RFJ-EW10A	(-)COP	81799
	103	02/07→	1.997	B	M	4	16	RFJ-EW10A	(+)COP	82089
2.0 HDi 135 FAP	100	10/06→	1.997	D	M	4	16	RHJ-DW10BTED4		81800
2.0 HDi 138 FAP	100	02/07→	1.997	D	M	4	16	RHJ-DW10BTED4		81800
2.0 i 16V	103	10/06→	1.997	B	M	4	16	RFJ-EW10A	(-)COP	81799
	103	10/06→	1.997	B	M	4	16	RFJ-EW10A	(+)COP	82089

### C 5 I, BREAK

1.8 16V	85	03/01→08/04	1.749	B	M	4	16	6FZ (EW7J4)	(-)COP	81799
	85	03/01→08/04	1.749	B	M	4	16	6FZ (EW7J4)	(+)COP	82089
2.0 16V	100	03/01→08/04	1.997	B	M	4	16	RFN (EW10J4)	(-)COP	81799
	100	03/01→08/04	1.997	B	M	4	16	RFN (EW10J4)	(+)COP	82089
2.0 16V HPi	103	03/01→08/04	1.997	B	M	4	16	RLZ (EW10D)	(-)COP	81799
	103	03/01→08/04	1.997	B	M	4	16	RLZ (EW10D)	(+)COP	82089
2.0 HDi	66	03/01→08/04	1.997	D	M	4	8	RHY (DW10TD)		81713
	79	03/01→08/04	1.997	D	M	4	8	RHS (DW10ATED)		81713
	80	03/01→08/04	1.997	D	M	4	8	RHZ (DW10ATED)		81713
2.2 HDi	98	03/01→08/04	2.179	D	M	4	16	4HX (DW12TED4/FAP)		81800
3.0 Carlsson HP	173	08/01→08/04	2.946	B	M	6	24			81813
3.0 V6	152	03/01→08/04	2.946	B	AM	6	24	XFX (ES9J4S)		81813
Carlsson	173	09/03→08/04	2.946	B	M	6	24			81813

### C 5 II, BREAK

1.6 HDi	80	09/04→	1.560	D	M	4	16	9HY (DV6TED4), DV6TED4		81869
1.8 16V	85	09/04→	1.749	B	M	4	16	6FZ (EW7J4)	(-)COP	81799
	85	09/04→	1.749	B	M	4	16	6FZ (EW7J4)	(+)COP	82089
	92	09/05→	1.749	B	M	4	16	6FY-EW7A	(-)COP	81799
	92	09/05→	1.749	B	M	4	16	6FY-EW7A	(+)COP	82089
2.0 16V	103	09/04→	1.997	B	M	4	16	EW10A, RFJ-EW10A	(-)COP	81799
	103	09/04→	1.997	B	M	4	16	EW10A, RFJ-EW10A	(+)COP	82089
2.0 HDi	100	09/04→	1.997	D	M	4	16	DW10BTED4, RHR (DW10BTED4)		81800
2.2 HDi	98	09/04→	2.179	D	M	4	16	4HX (DW12TED4/FAP)		81800
2.2 HDi	125	04/06→	2.179	D	M	4	16	4HT (DW12BTED4)		82068
3.0	173	09/04→	2.946	B	M	6	24			81813
3.0 Carlsson HP	173	09/04→	2.946	B	M	6	24			81813
3.0 V6	152	09/04→	2.946	B	M	6	24	XFV (ES9A), XFX (ES9J4S)		81813

### C 5 III, BREAK

1.6 16V	115	04/09→	1.598	B	M	4	16			82032
1.6 HDi	80	02/08→	1.560	D	M	4	16	DV6TED4		81869
	82	07/10→	1.560	D	M	4	16			81869
1.8 16V	92	02/08→	1.749	B	M	4	16	6FY-EW7A	(-)COP	81799
	92	02/08→	1.749	B	M	4	16	6FY-EW7A	(+)COP	82089
2.0 16V	103	02/08→	1.997	B	M	4	16	EW10A	(-)COP	81799
	103	02/08→	1.997	B	M	4	16	EW10A	(+)COP	82089
2.0 16V BioFlex	103	02/08→	1.997	FF	M	4	16	RFJ-EW10A	(-)COP	81799
	103	02/08→	1.997	FF	M	4	16	RFJ-EW10A	(+)COP	82089
2.0 HDi	100	02/08→	1.997	D	M	4	16	DW10BTED4		81800

	kw		Cap. cm3	Fuel	Gear	No. of cyl.	No. of valves	Motor code		MAGNETI MARELLI Short
--	----	--	----------	------	------	-------------	---------------	------------	--	-----------------------

## CITROËN

### C 5 III, BREAK

2.0 HDi	103	04/09→	1.997	D	M	4	16			81800
	120	04/09→	1.997	D	M	4	16			81800
2.2 HDi	125	02/08→	2.179	D	M	4	16	4HT (DW12BTED4)		82068
2.7 HDi	150	02/08→	2.720	D	M	6	24	DT17ED4		82067
3.0	152	02/08→	2.946	B	M	6	24	XFV (ES9A)		81813
3.0 V6	155	02/08→	2.946	B	M	6	24	XFU (ES9A)		81813

### C 6

2.2 HDi 173 FAP	125	06/06→	2.179	D	M	4	16	4HT (DW12BTED4)		82068
2.7 HDi 205 FAP	150	09/05→	2.720	D	M	6	24	DT17ED4		82067
3.0 V6	155	09/05→	2.946	B	M	6	24	ES9J4S		81813

### C 8

2.0	100	07/02→	1.997	B	M	4	16	RFN (EW10J4)	(-)COP	81799
	100	07/02→	1.997	B	M	4	16	RFN (EW10J4)	(+)COP	82089
2.0 16V	103	09/05→	1.997	B	M	4	16	RFJ-EW10A	(-)COP	81799
	103	09/05→	1.997	B	M	4	16	RFJ-EW10A	(+)COP	82089
2.0 HDi	79	07/02→	1.997	D	M	4	16	RHW (DW10ATED4)		81713
	88	02/07→	1.997	D	M	4	16	RHK (DW10UTED4)		81800
	100	03/06→	1.997	D	M	4	16	RHR (DW10BTED4)		81800
	120	03/06→	1.997	D	M	4	16			81800
2.2	116	07/02→	2.230	B	M	4	16	3FZ (EW12J4)	(-)COP	81799
	116	07/02→	2.230	B	M	4	16	3FZ (EW12J4)	(+)COP	82089
2.2 HDi	94	07/02→	2.179	D	M	4	16	4HW (DW12TED4)		81800
	125	06/06→	2.179	D	M	4	16	4HT (DW12BTED4)		82068
3.0 V6	150	07/02→	2.946	B	M	6	24	AFX (ES9J4S)		81813

### C-CROSSER, ENTERPRISE

2.2 HDi	115	02/07→	2.179	D	M	4	16			82068
---------	-----	--------	-------	---	---	---	----	--	--	-------

### CX I, BREAK

25 D Turbo	70	04/83→08/85	2.500	D	M	4	8	M25-648		81822
25 GTi Turbo 2	122	06/84→08/85	2.500	B	M	4	8	M25-662	(-)AC	81822
25 TRi	100	07/83→08/85	2.500	B	M	4	8	M25-659	(-)AC	81822
2400	88	05/80→05/82	2.350	B	M	4	8	M23-639	(-)AC	81822
2400 GTi	94	06/77→06/82	2.347	B	M	4	8	M23-622	07-1980→, (-)AC	81822
	94	07/82→06/83	2.350	B	M	4	8	M23-622	(-)AC	81822
	96	06/77→06/82	2.347	B	M	4	8	M23-622	07-1980→, (-)AC	81822
2500 D	55	02/78→08/85	2.500	D	M	4	8	M25-629		81822
2500 D Turbo	70	04/83→08/85	2.500	D	M	4	8	M25-648		81822

### CX II, BREAK

25 D	54	08/85→12/92	2.500	D	M	4	8	M25-660		81822
25 D Turbo	70	08/85→12/86	2.500	D	M	4	8	M25-648		81822
	88	01/87→12/92	2.500	D	M	4	8	M25-669		81822
25 D Turbo 2	88	01/87→12/92	2.500	D	M	4	8	M25-669		81822
25 GTi	89	05/86→12/92	2.500	B	M	4	8	M25-668	(-)AC	81822
25 GTi Turbo 2	115	09/86→12/92	2.500	B	M	4	8	M25-667	(-)AC	81822
	122	08/85→12/92	2.500	B	M	4	8	M25-662	(-)AC	81822
25 i	89	05/86→12/92	2.500	B	M	4	8	M25-668	(-)AC	81822
25 TRi	100	08/85→12/92	2.500	B	M	4	8	M25-659	(-)AC	81822

	kW		Cap. cm3	Fuel	Gear	No. of cyl.	No. of valves	Motor code		Short
--	----	--	----------	------	------	-------------	---------------	------------	--	-------

## CITROËN

### CX II, BREAK

2500 D Turbo	70	08/85→12/86	2.500	D	M	4	8	M25-648		81822
--------------	----	-------------	-------	---	---	---	---	---------	--	-------

### DS 3

1.4 16V	70	04/10→	1.397	B	M	4	16			82032
1.6 16V	88	04/10→	1.598	B	M	4	16			82032
	115	04/10→	1.598	B	M	4	16			82032

### EVASION

1.8	73	05/97→07/02	1.761	B	M	4	8	LFZ (XU7JP)	06-1996→	81512
1.9 TD	66	11/94→07/02	1.905	D	M	4	8	D8B (XUD9TF), DHX (XUD9TF/BTF)		81642
	68	10/95→12/98	1.905	D	M	4	8	D8B (XUD9TF)		81642
2.0	89	06/94→07/02	1.998	B	M	4	8	RFU (XU10J2/C)	06-1994→	81642
2.0 16V	97	05/98→04/00	1.998	B	M	4	16	RFV (XU10J4R)		81711
	100	05/00→07/02	1.997	B	M	4	16	RFN (EW10J4)	(-)COP	81799
	100	05/00→07/02	1.997	B	M	4	16	RFN (EW10J4)	(+)COP	82089
2.0 HDI	80	08/99→07/02	1.997	D	M	4	8	RHZ (DW10ATED)		81713
2.0 TD	68	05/97→07/02	1.998	D	M	4	8			81642
2.0 Turbo C.T.	108	06/94→07/02	1.998	B	M	4	8	RGX (XU10J2TE)	06-1994→	81642
2.1 TD	80	05/96→07/02	2.088	D	M	4	12	P8C (XUD11BTE)	06-1996→	81353

### JUMPER I

1.9 D	50	07/99→04/02	1.905	D	M	4	8	DJY (XUD9A)		81642
	51	02/94→04/02	1.905	D	M	4	8	D9B (XUD9A/U)		81642
1.9 TD	66	03/94→04/02	1.905	D	M	4	8	D8C (XUD9UTF), DHX (XUD9TF/BTF)		81642
	68	02/94→04/02	1.905	D	M	4	8	D8C (XUD9UTF)		81642
1.9 TD 4x4	68	08/96→04/02	1.905	D	M	4	8	D8C (XUD9UTF)		81642
2.0	80	02/94→04/02	1.998	B	M	4	8	RFW (XU10J2U)		81642
2.0 4x4	80	08/96→04/02	1.998	B	M	4	8	RFW (XU10J2U)		81642
2.0 HDI	62	11/01→04/02	1.997	D	M	4	8	DW10UTD		81713
2.5 D	63	03/94→04/02	2.446	D	M	4	8	T9A (DJ5)	05-1996→	81712
	63	03/94→04/02	2.446	D	M	4	8	T9A (DJ5)	→04-1996	81752
2.5 D 4x4	63	08/96→04/02	2.446	D	M	4	8	T9A (DJ5)		81712
2.5 DT 4x4	76	10/96→08/97	2.446	D	M	4	8			81712
2.5 TD	76	03/94→04/02	2.446	D	M	4	8	T8A (DJ5T)	05-1996→	81712
	76	03/94→04/02	2.446	D	M	4	8	T8A (DJ5T)	→04-1996	81752
2.5 TD 4x4	76	08/96→04/02	2.446	D	M	4	8	T8A (DJ5T)		81712
2.5 TDi	79	12/96→04/02	2.446	D	M	4	8	THX (DJ5TED)		81712
2.5 TDi 4x4	79	12/96→04/02	2.446	D	M	4	8	THX (DJ5TED)		81712
2.8 HDi	93	10/00→01/02	2.798	D	M	4	8	8140.43S		81316
	94	09/00→04/02	2.798	D	M	4	8	8140.43S		81316
2.8 HDi 4x4	94	09/00→04/02	2.798	D	M	4	8	8140.43S		81316

### JUMPER II

2.0	81	04/02→	1.998	B	M	4	8	XU10J2		81642
2.0 bivalent	81	02/03→	1.998	BF	M	4	8	XU10J2		81642
2.0 HDi	62	04/02→	1.997	D	M	4	8	DW10UTD		81713
2.2 HDi	74	02/02→06/06	2.179	D	M	4	8			81800
	74	04/02→	2.179	D	M	4	16	DW12TED		81800

	kW		Cap. cm3	Fuel	Gear	No. of cyl.	No. of valves	Motor code		MAGNETI MARELLI Short
--	----	--	----------	------	------	-------------	---------------	------------	--	-----------------------

## CITROËN

### JUMPER II

2.8 HDi	94	04/02→	2.798	D	AM	4	8	8140.43S		81316
	107	04/04→06/06	2.798	D	M	4	8	8140.43N		81316
	107	05/04→	2.800	D	M	4	8	8140.43N		81316
2.8 HDi 4x4	94	02/02→06/06	2.798	D	M	4	8	8140.43S, F28TDCR		81316

### JUMPER III

2.2 HDi 100	74	04/06→	2.198	D	M	4	16			82066
2.2 HDi 120	88	04/06→	2.198	D	M	4	16			82066
3.0 HDi 160	116	09/06→	2.999	D	M	4	16			82094

### JUMPY I

1.6	58	10/95→	1.581	B	M	4	8	1580SPI, 220A2.000	(+)COP	81346
	58	10/95→	1.581	B	M	4	8	1580SPI, 220A2.000	(-)COP	81368
	59	10/95→08/00	1.581	B	M	4	8	220A2.000	(+)COP	81346
	59	10/95→08/00	1.581	B	M	4	8	220A2.000	(-)COP	81368
1.6 i	58	10/95→	1.581	B	M	4	8	1580SPI, 220A2.000	(+)COP, 10-1995→	81346
	58	10/95→	1.581	B	M	4	8	1580SPI, 220A2.000	(-)COP	81368
1.9 D	51	10/95→08/98	1.905	D	M	4	8	D9B (XUD9A/U)	10-1995→	81642
1.9 D 70	51	04/98→	1.868	D	M	4	8	WJZ (DW8)		81713
1.9 DT	65	10/95→08/00	1.905	D	M	4	8			81642
1.9 TD	66	10/95→	1.905	D	M	4	8	DHX (XUD9TF/BTF)	10-1995→	81642
	68	04/96→	1.905	D	M	4	8	D8B (XUD9TF)		81642
2.0	100	04/00→12/06	1.997	B	M	4	16	RFN (EW10J4)	(-)COP	81799
	100	04/00→12/06	1.997	B	M	4	16	RFN (EW10J4)	(+)COP	82089
2.0 HDi	80	12/03→10/06	1.997	D	M	4	8			81713
2.0 HDi 110	80	03/00→	1.997	D	M	4	8	RHZ (DW10ATED)		81713
2.0 HDi 95	69	10/99→	1.997	D	M	4	8	RHX, RHX (DW10BTED)		81713
2.0 i 16V	102	03/00→	1.997	B	M	4	16		(-)COP	81799
	102	03/00→	1.997	B	M	4	16		(+)COP	82089
2.2 HDi	66	12/03→10/06	2.179	D	M	4	8			81800

### JUMPY II

1.6 HDi 90	66	01/07→	1.560	D	M	4	8			81869
2.0 HDi 120	88	01/07→	1.997	D	M	4	16	RHK (DW10UTED4)		81800
2.0 HDi 140	100	01/07→	1.997	D	M	4	16	RHR (DW10BTED4)		81800
2.0 i	103	01/07→	1.997	B	M	4	16	RFH (EW10A)	(-)COP	81799
	103	01/07→	1.997	B	M	4	16	RFH (EW10A)	(+)COP	82089

### LNA

1.0	33	07/84→10/86	954	B	M	4	8	108C		81572
1.1	37	07/82→04/85	1.124	B	M	4	8	109/5E		81572

### NEMO, STATION WAGON

1.4	54	02/08→	1.360	B	M	4	8			81797
1.4 HDi	50	02/08→	1.399	D	M	4	8			81798

### SAXO

1.0 X	33	05/96→11/98	954	B	M	4	8	CDZ (TU9M)		81556
	37	05/98→06/03	954	B	M	4	8	CDZ (TU9M)		81556
1.1 X,SX	40	05/96→09/03	1.124	B	M	4	8	HDZ (TU1M)	→07-2000, →M: 3.666.765	81556

	kW		Cap. cm3	Fuel	Gear	No. of cyl.	No. of valves	Motor code		Short
--	----	--	----------	------	------	-------------	---------------	------------	--	-------

## CITROËN

### SAXO

1.1 X,SX	40	05/96→09/03	1.124	B	M	4	8	HDZ (TU1M)	08-2000→, M→: 3.666.766	81797
	44	05/96→09/03	1.124	B	M	4	8	HDZ (TU1M), HFX (TU1JP)	→07-2000, →M: 3.666.765	81556
	44	05/96→09/03	1.124	B	M	4	8	HDZ (TU1M), HFX (TU1JP)	08-2000→, M→: 3.666.766	81797
1.4 VTS	55	05/96→06/03	1.360	B	M	4	8	KFW (TU3JP), KFX (TU3JP)	→07-2000, →M: 3.666.765	81556
	55	05/96→06/03	1.360	B	M	4	8	KFW (TU3JP), KFX (TU3JP)	08-2000→, M→: 3.666.766	81797
1.5 D	40	09/96→09/03	1.527	D	M	4	8	VJY (TUD5)		81513
	42	09/96→06/01	1.527	D	M	4	8	VJZ (TUD5)		81513
1.6 VTL,VTR	65	05/96→06/03	1.587	B	M	4	8	NFZ (TU5JP)		81513
1.6 VTS	72	09/00→09/03	1.587	B	M	4	8	NFT		81513
	87	06/96→09/03	1.587	B	M	4	16	NFX (TU5JP4)		81753

### VISA, CABRIO

1.0	33	09/84→06/88	954	B	M	4	8			81572
11 E	35	09/78→06/88	1.124	B	M	4	8	109K		81572
	37	07/82→03/91	1.124	B	M	4	8	109/5F		81572
	42	09/78→03/91	1.124	B	M	4	8	109/5		81572
11 RE	37	03/83→10/88	1.124	B	M	4	8	109/5F		81572
14	44	07/84→03/91	1.360	B	M	4	8	150D (XY7)		81572
14 GT	55	03/82→03/87	1.360	B	M	4	8			81572
	58	03/82→03/91	1.360	B	M	4	8	150B (XY8)		81572
16 GTI	76	01/85→06/86	1.580	B	M	4	8	180A (XU5J)	→PROD: 3583	81554
	83	06/86→03/91	1.580	B	M	4	8	B6D	PROD→: 3584	81512
17 D	44	04/84→03/91	1.769	D	M	4	8	161A (XUD7)	01-1987→, PROD→: 3584	81512
	44	04/84→03/91	1.769	D	M	4	8	161A (XUD7)	→12-1986, →PROD: 3583	81554
II Super X	47	07/80→06/82	1.219	B	M	4	8	129/5		81572

### XANTIA I, BREAK

1.6 i	65	03/93→01/98	1.580	B	M	4	8	BFZ (XU5JP)	11-1996→	81512
1.8 i	66	04/97→01/98	1.761	B	M	4	8	LFX (XU7JB)		81512
	74	03/93→01/98	1.761	B	M	4	8	LFZ (XU7JP)	11-1996→, 03-1993→, →10-1996	81512
1.8 i 16V	81	06/95→01/98	1.761	B	M	4	16	LFY (XU7JP4)	11-1996→	81710
1.9 D	50	06/94→01/98	1.905	D	M	4	8	DJZ (XUD9Y)	PROD→: 6265	81642
	50	06/94→01/98	1.905	D	M	4	8	DJZ (XUD9Y)	→PROD: 6264	81672
	51	06/94→01/98	1.905	D	M	4	8	D9B (XUD9A/L)	PROD→: 6265	81642
	51	06/94→01/98	1.905	D	M	4	8	D9B (XUD9A/L)	→PROD: 6264	81672
1.9 SD	55	02/96→01/98	1.905	D	M	4	8	DHW (XUD9SD)	PROD→: 6265	81642
	55	02/96→01/98	1.905	D	M	4	8	DHW (XUD9SD)	→PROD: 6264	81672
1.9 Turbo D	66	10/94→01/98	1.905	D	M	4	8	D8B (XUD9TF), DHX (XUD9TF/BTF), DHY (XUD9TE/Y)	PROD→: 6265	81642



	kW		Cap. cm3	Fuel	Gear	No. of cyl.	No. of valves	Motor code		MAGNETI MARELLI Short
--	----	--	----------	------	------	-------------	---------------	------------	--	-----------------------

## CITROËN

### XANTIA I, BREAK

1.9 Turbo D	66	10/94→01/98	1.905	D	M	4	8	D8B (XUD9TF), DHX (XUD9TF/BTF), DHY (XUD9TE/Y)	→PROD: 6264	81672
2.0 i	89	03/93→01/98	1.998	B	M	4	8	RFX (XU10J2C)	03-1993→, →05-1995	81642
2.0 i 16V	97	06/95→01/98	1.998	B	M	4	16	RFV (XU10J4R)	→10-1996	81642
	97	06/95→01/98	1.998	B	M	4	16	RFV (XU10J4R)	11-1996→	81711
	110	06/94→01/98	1.998	B	M	4	16	RFT (XU10J4/Z)	06-1995→, →10-1996	81642
	112	03/93→01/98	1.998	B	M	4	16	RFY (XU10J4/Z)	03-1993→	81642
2.0 Turbo	108	06/95→01/98	1.998	B	M	4	8	RGX (XU10J2TE)	06-1995→	81642
2.1 Turbo D 12V	80	06/95→01/98	2.088	D	M	4	12	P8C (XUD11BTE)	11-1996→, 06-1995→	81353
3.0 i 24V	140	01/97→01/98	2.946	B	M	6	24	XFZ (ES9J4)	→T: 08441	81844
	140	01/97→01/98	2.946	B	M	6	24	XFZ (ES9J4)	T→: 08442	82042

### XANTIA II, BREAK

1.8 i	66	01/98→04/03	1.761	B	M	4	8	LFX (XU7JB)		81512
1.8 i 16V	81	01/98→04/03	1.761	B	M	4	16	LFY (XU7JP4)		81710
1.9 SD	55	01/98→04/03	1.905	D	M	4	8	DHW (XUD9SD)		81642
1.9 Turbo D	66	01/98→04/03	1.905	D	M	4	8	D8B (XUD9TF), DHX (XUD9TF/BTF), DHY (XUD9TE/Y)		81642
2.0 HDI 90	66	03/99→04/03	1.997	D	M	4	8	RHY (DW10TD)		81713
2.0 HDI 109	80	02/99→04/03	1.997	D	M	4	8	RHZ (DW10ATED)		81713
2.0 i	89	01/98→04/03	1.998	B	M	4	8	RFX (XU10J2C)		81642
2.0 i 16V	97	01/98→04/03	1.998	B	M	4	16	RFV (XU10J4R)		81711
2.0 Turbo	108	01/98→04/03	1.998	B	M	4	8	RGX (XU10J2TE)		81642
2.1 Turbo D 12V	80	01/98→02/99	2.088	D	M	4	12	P8C (XUD11BTE)	11-1996→	81353
3.0 V6	140	01/98→04/03	2.946	B	M	6	24	XFZ (ES9J4)	→T: 08441	81844
	140	01/98→04/03	2.946	B	M	6	24	XFZ (ES9J4)	T→: 08442	82042

### XM I, BREAK

2.0	84	05/89→04/94	1.998	B	M	4	8			81642
2.0 i	79	05/89→04/94	1.998	B	M	4	8	RDZ (XU10MZ)		81642
	89	05/89→06/94	1.998	B	M	4	8	RFZ (XU10J2)		81642
2.0 Turbo	104	09/92→04/94	1.998	B	M	4	8	RGY (XU10J2TE/Z)		81642
2.0 i Turbo	104	09/92→06/94	1.998	B	M	4	8	RGY (XU10J2TE/Z)	01-1993→, →05-1994	81642
2.1 D 12V	60	05/89→06/94	2.138	D	M	4	12	P9A (XUD11A)		81642
2.1 TD 12V	80	05/89→06/94	2.088	D	M	4	12	P8A (XUD11ATE), P8C (XUD11BTE), PHZ (XUD11ATE), PJZ (XUD11ATE)	01-1991→, 05-1989→, →07-1994	81353

### XM II, BREAK

2.0 i 16V	97	05/94→10/00	1.998	B	M	4	16	RFV (XU10J4R)	08-1994→	81711
2.0 Turbo	108	05/94→10/00	1.998	B	M	4	8	RGX (XU10J2TE), RGY (XU10J2TE/Z)		81642
2.1 D12	60	07/94→06/96	2.138	D	M	4	12	P9A (XUD11A)		81642
2.1 D12 VSX	60	03/96→08/96	2.138	D	M	4	12	P9A (XUD11A)		81642
2.1 TD 12V	80	05/94→10/00	2.088	D	M	4	12	P8A (XUD11ATE), P8C (XUD11BTE), PHZ (XUD11ATE), PJZ (XUD11ATE)	01-1993→, 01-1994→	81353
2.5 TD	95	05/94→10/00	2.446	D	M	4	12	THY (DK5ATE)	PROD→: 7144	81712
	95	05/94→10/00	2.446	D	M	4	12	THY (DK5ATE)	→PROD: 7143	81752
3.0 V6	140	04/97→10/00	2.946	B	M	6	24	XFZ (ES9J4)	→T: 08441	81844
	140	04/97→10/00	2.946	B	M	6	24	XFZ (ES9J4)	T→: 08442	82042

	kW		Cap. cm3	Fuel	Gear	No. of cyl.	No. of valves	Motor code		Short
--	----	--	----------	------	------	-------------	---------------	------------	--	-------

## CITROËN

### XSARA, BREAK, COUPÉ, PICASSO

1.4 HDi	50	01/03→08/05	1.398	D	M	4	8	8HX (DV4TD)		81798
1.4 i	55	04/97→08/05	1.360	B	M	4	8	KFW (TU3JP), KFX (TU3JP)	→08-2000, →M: 3.666.765	81556
	55	04/97→08/05	1.360	B	M	4	8	KFW (TU3JP), KFX (TU3JP)	09-2000→, M→: 3.666.766	81797
1.5 D	42	04/97→09/00	1.527	D	M	4	8	VJZ (TUD5)	→PROD: 8385	81513
1.6	65	12/99→	1.587	B	M	4	8	NFZ (TU5JP)		81513
	67	06/02→	1.587	B	M	4	8			81513
	70	12/99→	1.587	B	M	4	8	NFV (TU5JP)		81513
1.6 16V	80	09/05→	1.587	B	M	4	16	NFU (TU5JP4)		81513
	80	09/00→03/05	1.587	B	M	4	16	NFU (TU5JP4)		81753
	80	09/00→08/05	1.587	B	AM	4	16	NFU (TU5JP4)		81753
1.6 Chrono	74	04/01→10/04	1.587	B	M	4	8			81513
1.6 HDi	66	09/05→	1.560	D	M	4	8			81869
	80	05/04→	1.560	D	M	4	16	DV6TED4		81869
1.6 i	65	04/97→09/00	1.587	B	M	4	8	NFZ (TU5JP)	07-1997→	81513
1.8 16V	85	02/00→	1.749	B	M	4	16	6FZ (EW7J4), LFY (XU7JP4)	(-)COP	81799
	85	02/00→	1.749	B	M	4	16	6FZ (EW7J4), LFY (XU7JP4)	(+)COP	82089
1.8 D	43	04/97→09/00	1.769	D	M	4	8	161A (XUD7), A9A (XUD7)		81642
1.8 i	66	04/97→09/00	1.761	B	M	4	8	LFX (XU7JB)	07-1997→	81512
	74	02/98→09/00	1.761	B	M	4	8	LFZ (XU7JP)		81512
1.8 i 16V	81	04/97→09/00	1.761	B	M	4	16	LFY (XU7JP4)	07-1997→	81710
1.8 i Aut.	74	04/97→09/00	1.761	B	A	4	8	LFZ (XU7JP)	07-1997→	81512
1.8 SX	76	06/00→08/05	1.761	B	M	4	8			81512
1.8 TD	66	10/97→09/00	1.761	D	M	4	8			81642
1.8 VTS	85	09/00→10/04	1.749	B	M	4	16	6FZ (EW7J4)	(-)COP	81799
	85	09/00→10/04	1.749	B	M	4	16	6FZ (EW7J4)	(+)COP	82089
1.9 D	51	07/98→08/05	1.868	D	M	4	8	WJY (DW8B), WJZ (DW8)		81713
	50	04/97→09/00	1.905	D	M	4	8	DJY (XUD9A)		81642
	55	01/98→09/00	1.905	D	M	4	8	DHV (XUD9BSD)		81642
1.9 SD	55	01/98→09/00	1.905	D	M	4	8	DHV (XUD9BSD)		81642
1.9 TD	66	04/97→09/00	1.905	D	M	4	8	DHY (XUD9TE/Y)		81642
2.0 16V	97	07/98→09/00	1.998	B	M	4	16	RFV (XU10J4R)		81711
	100	09/00→08/05	1.997	B	M	4	16	RFN (EW10J4)	(-)COP	81799
	100	09/00→08/05	1.997	B	M	4	16	RFN (EW10J4)	(+)COP	82089
	120	04/97→09/00	1.998	B	M	4	16	RFS (XU10J4RS)	01-1998→	81711
2.0 HDi	66	12/99→	1.997	D	M	4	8	RHY (DW10TD)		81713
2.0 HDi 90	66	02/99→08/05	1.997	D	M	4	8	RHY (DW10TD)		81713
2.0 HDi 109	80	05/01→08/05	1.997	D	AM	4	8	RHZ (DW10ATED)		81713
2.0 i 16V	120	02/98→03/05	1.998	B	M	4	16	RFS (XU10J4RS)		81711

### ZX, BREAK

1,1	40	03/91→08/93	1.124	B	M	4	8	H1A		81556
	44	03/91→06/97	1.124	B	M	4	8	HDZ (TU1M)		81556
1.4	37	07/94→10/97	1.360	D	M	4	8			81556
	55	03/91→06/97	1.360	B	M	4	8	KDZ (TU3M/Z)		81556

	kW		Cap. cm3	Fuel	Gear	No. of cyl.	No. of valves	Motor code		
										Short

## CITROËN

### ZX, BREAK

1.4 i	55	03/91→10/97	1.360	B	M	4	8	KDX (TU3M/Z), KDY (TU3M), KDZ (TU3M/Z), KFX (TU3JP)	07-1994→, →07-1995	81556
1.6 i	65	03/91→10/97	1.580	B	M	4	8	BDY (XU5M), BFZ (XU5JP)	09-1992→, PROD→: 5410, PROD→: 5.410, PROD→: 5410	81512
	65	03/91→06/97	1.580	B	M	4	8	BDY (XU5M), BFZ (XU5JP)	→08-1992, →PROD: 5409	81554
1.8 D	44	06/93→10/97	1.769	D	M	4	8	161A (XUD7)		81642
1.8 i	74	07/92→10/97	1.761	B	M	4	8	LFZ (XU7JP)	PROD→: 5410	81512
	74	07/92→10/97	1.761	B	M	4	8	LFZ (XU7JP)	→PROD: 5409	81554
1.8 i 16V	81	01/96→02/98	1.761	B	M	4	16	LFY (XU7JP4)		81710
1.9 D	47	03/91→10/97	1.905	D	M	4	8	DJZ (XUD9Y)	07-1994→, PROD→: 6171	81642
	47	03/91→10/97	1.905	D	M	4	8	DJZ (XUD9Y)	→06-1994, →PROD: 6170	81672
	50	06/94→10/97	1.905	D	M	4	8	D9B (XUD9A/U)	07-1994→, PROD→: 6.171	81642
1.9 i	88	03/91→06/97	1.905	B	M	4	8	DKZ (XU9JA)	09-1992→, PROD→: 5410	81512
	88	03/91→06/97	1.905	B	M	4	8	DKZ (XU9JA)	→08-1992, →PROD: 5409	81554
1.9 TD	66	07/92→10/97	1.905	D	M	4	8	DHY (XUD9TE/Y)	07-1994→, PROD→: 6171	81642
	66	07/92→10/97	1.905	D	M	4	8	DHY (XUD9TE/Y)	→06-1994, →PROD: 6170	81672
2.0 i	89	07/92→06/97	1.998	B	M	4	8	RFX (XU10J2C)		81642
2.0 i 16V	110	06/94→06/97	1.998	B	M	4	16	RFT (XU10J4/Z)		81672
	112	07/92→10/94	1.998	B	M	4	16	RFT (XU10J4/Z), RFY (XU10J4/Z)		81672
	120	05/96→06/97	1.998	B	M	4	16	RFS (XU10J4RS)		81672

## DACIA

### DUSTER

1.5 dCi	63	04/10→	1.461	D	M	4	8	K9K796		81810
	66	10/10→	1.461	D	M	4	8			81810
	79	06/10→	1.461	D	M	4	8			81810
1.5 dCi 4x4	66	10/10→	1.461	D	M	4	8			81810
	79	06/10→	1.461	D	M	4	8			81810
	81	10/10→	1.461	D	M	4	8			81810
1.6 16V	77	04/10→	1.598	B	M	4	16	K4M690		81806
1.6 16V 4x4	77	06/10→	1.598	B	M	4	16			81806

### LOGAN, STATION WAGON, VAN

1.4	55	09/04→	1.390	B	M	4	8	K7J710		81579
1.4 Bifuel	55	02/06→	1.390	BF	M	4	8	K7J710		81579
1.5 dCi	48	09/05→	1.461	D	M	4	8	K9K790		81810
	50	01/06→	1.461	D	M	4	8	K9K792		81810
	63	09/07→	1.461	D	M	4	8	K9K796		81810



kW



Cap. cm3

Fuel

Gear

No. of cyl.

No. of valves

Motor code



MAGNETI MARELLI  
Short

## DACIA

### LOGAN, STATION WAGON, VAN

1.6	64	09/04→	1.598	B	M	4	8	K7M710		81579
1.6 16V	77	02/06→	1.598	B	M	4	16	K4M690, K7M690		81806
1.6 LPG	62	11/08→	1.598	B	M	4	8	K7M710		81579

### SANDERO

1.2 16V	55	11/08→	1.149	B	M	4	16	D4F732		81820
1.4	55	06/08→	1.390	B	M	4	8	K7J710		81579
1.5 dCi	50	11/08→	1.461	D	M	4	8	K9K792		81810
	63	11/08→	1.461	D	M	4	8	K9K796		81810
1.6	64	06/08→	1.598	B	M	4	8	K7M710		81579

### SOLENZA

1.4	55	02/03→	1.390	B	M	4	8			81578
1.9 D	46	02/03→	1.870	D	M	4	8	F8Q630		81574

## DAEWOO

### CIELO

1.5	66	06/94→07/98	1.498	B	M	4	16	V15L		81549
-----	----	-------------	-------	---	---	---	----	------	--	-------

### ESPERO

1.5	55	10/97→09/99	1.498	B	M	4	8			81549
1.5 16V	65	10/93→09/94	1.498	B	M	4	16			81780
	66	02/95→06/99	1.498	B	M	4	16	A15MF		81780
1.8	66	02/95→09/99	1.796	B	M	4	8	C18LE	→10-1995	81606
	66	02/95→09/99	1.796	B	M	4	8	C18LE	11-1995→	81548
	70	02/95→06/99	1.796	B	M	4	8	C18LE	→10-1995	81606
	70	02/95→06/99	1.796	B	M	4	8	C18LE	11-1995→	81548
2.0	74	10/91→09/93	1.998	B	M	4	8	C20LZ		81606
	77	02/95→06/99	1.998	B	M	4	8	C20LE	11-1995→	81548
	77	02/95→06/99	1.998	B	M	4	8	C20LE	→10-1995	81606
	81	10/93→09/94	1.998	B	M	4	8	C20LE		81606

### EVANDA

2.0	96	08/02→	1.998	B	M	4	16	L88		81550
-----	----	--------	-------	---	---	---	----	-----	--	-------

### KALOS

1.2	53	04/03→	1.150	B	M	4	8			81781
1.4	61	09/02→	1.399	B	M	4	8			81781
1.4 16V	69	04/03→	1.399	B	M	4	16	F14D3		81782

### KORANDO, CABRIO

2.3	105	01/99→	2.295	B	M	4	8			81509
2.9 D	72	01/99→	2.874	D	M	5	10	MB-OM662		81506
2.9 TD	88	01/99→	2.874	D	M	5	10	MB-OM60129TD		81506
3.2	156	01/99→	3.199	B	M	6	24	M104.995		81722

### LACETTI III

1.4	70	02/04→	1.399	B	M	4	16	F14D3		81782
1.6	80	02/04→	1.598	B	M	4	16	F16D3		81782
1.8	90	02/04→	1.799	B	M	4	16	T18SED		81550
1.8 CDX	90	08/03→12/04	1.799	B	M	4	16	T18SED		81550

	kW		Cap. cm3	Fuel	Gear	No. of cyl.	No. of valves	Motor code		MAGNETI MARELLI Short
--	----	--	----------	------	------	-------------	---------------	------------	--	-----------------------

## DAEWOO

### LANOS

1.4	55	05/97→	1.349	B	M	4	8	A14SMS		81781
1.5	63	05/97→	1.498	B	M	4	8	A15SMS	01-1997→	81781
1.6 16V	78	05/97→	1.598	B	M	4	16	A16DMS		81780

### LEGANZA

2.0 16V	98	06/97→12/02	1.998	B	M	4	16	X20SED		81550
	93	07/00→	1.998	B	M	4	16	T20SED		81550
2.2 16V	100	04/99→12/02	2.198	B	M	4	16	T22SED		81550

### MATIZ

0.8	38	09/98→	796	B	M	3	6	F8CV		81783
1.0	47	01/03→	995	B	M	4	8			81783

### MUSSO

2.2 TD	74	09/99→	2.299	D	M	4	8	MBOM601		81506
2.3	103	01/99→	2.295	B	M	4	16	M111.970		81509
2.9 D	73	01/99→09/99	2.874	D	M	5	10	MB-OM662		81506
2.9 TD	88	01/99→	2.874	D	M	5	10	MB-OM60129TD		81506
3.2	162	01/99→	3.199	B	M	6	24	M104.992		81722

### NEXIA

1.5	44	08/96→08/97	1.498	B	M	4	8	G15MF		81549
	52	02/95→08/97	1.498	B	M	4	8	G15MF		81549
	55	02/95→08/97	1.498	B	M	4	8	G15MF		81549
1.5 16V	66	02/95→08/97	1.498	B	M	4	16	A15MF		81780

### NUBIRA I, STATION WAGON

1.6 16V	66	06/97→	1.598	B	M	4	16			81782
	76	07/00→	1.598	B	M	4	16	A16DMS		81782
	78	05/97→	1.598	B	M	4	16	A16DMS		81782
2.0 16V	98	05/97→	1.998	B	M	4	16	X20SED		81550

### NUBIRA II, STATION WAGON

1.6	80	07/03→	1.598	B	M	4	16	F16D3		81782
1.8	90	07/03→	1.799	B	M	4	16	T18SED		81782

### REZZO

1.6	77	09/00→	1.598	B	M	4	16	A16DMS		81782
1.6 SX	66	08/01→12/04	1.598	B	M	4	16			81782
2.0	89	09/01→	1.998	B	M	4	16	X20SED		81550
	94	09/00→	1.998	B	M	4	8			81550

### TICO

0.8	35	02/95→12/00	796	B	M	3	6	F8C		81783
	38	01/96→12/00	796	B	M	3	6	F8CV		81783

## DAIHATSU

### APPLAUSE I

1.6 16V	66	06/89→07/97	1.590	B	M	4	16	HD		81714
	77	06/89→07/97	1.590	B	M	4	16	HD-E		81714
1.6 16V 4WD	77	06/89→07/97	1.590	B	M	4	16	HD-E		81714

### APPLAUSE II

1.6 16V	73	07/97→05/00	1.590	B	M	4	16	HD-E		81714
---------	----	-------------	-------	---	---	---	----	------	--	-------

	kW		Cap. cm3	Fuel	Gear	No. of cyl.	No. of valves	Motor code		Short
--	----	--	----------	------	------	-------------	---------------	------------	--	-------

## DAIHATSU

### CHARADE I

1.0	37	10/77→02/81	993	B	M	3	6	CB20		81432
	38	02/81→02/83	993	B	M	3	6	CB20, CB22		81432

### CHARADE II

1.0	38	10/83→03/87	993	B	M	3	6	CB20, CB22	→06-1985	81441
1.0 D	27	10/83→03/87	993	D	M	3	6	CL10		81441
1.0 TD	34	02/85→03/87	993	D	M	3	6	CL60		81441
1.0 Turbo	50	10/83→03/87	993	B	M	3	6	CB60		81441

### CHARADE III

1.0 D	27	03/87→12/92	993	D	M	3	6	CL11		81441
1.0 TD	35	03/87→12/92	993	D	M	3	6	CL, CL61		81441
1.3	56	09/88→01/92	1.295	B	M	4	16	HC-C		81714
	66	11/90→02/93	1.296	B	M	4	16	HCE		81714
1.3 i	66	06/88→12/92	1.296	B	M	4	16	HCE		81714
1.3 i 4WD	66	06/88→01/93	1.296	B	M	4	16	HCE		81714

### CHARADE IV

1.0	38	09/94→03/96	993	B	M	3	6	CB22		81714
1.3	44	09/96→11/99	1.296	B	M	4	16	HC		81714
1.3 16V	55	05/96→11/99	1.296	B	M	4	16			81714
	62	01/93→11/99	1.296	B	M	4	16	HC		81714
1.5	55	10/94→	1.499	B	M	4	8	HE		81714
1.5 16V	66	08/94→11/99	1.499	B	M	4	16	HEE, HEEG		81714
1.5 HG	55	06/94→03/96	1.499	B	M	4	16	HEE		81714
1.6 GTi	77	03/93→11/99	1.590	B	M	4	16	HD-E		81714

### COPEN

1.3	64	03/06→	1.298	B	M	4	16	K3-VE	Flange: 3 holes	81808
-----	----	--------	-------	---	---	---	----	-------	-----------------	-------

### CUORE VIII

1.0	51	04/07→	998	B	M	3	12	1KR-FE		82063
-----	----	--------	-----	---	---	---	----	--------	--	-------

### FEROZA HARD TOP

1.6 16V	63	10/88→	1.590	B	M	4	16	HDC		81715
1.6 i 16V	70	10/88→	1.590	B	M	4	16	HD-E		81715

### FEROZA SOFT TOP

1.6 16V	63	10/88→	1.590	B	M	4	16	HDC		81715
1.6 i 16V	70	10/88→	1.590	B	M	4	16	HD-E		81715

### GRAN MOVE

1.5 16V	66	10/96→07/98	1.499	B	M	4	16	HEEG		81714
1.6 16V	67	05/98→	1.590	B	M	4	16	HDEP		81714

### HIJET II

1.0	33	12/92→05/98	993	B	M	3	6	CB41		81441
1.0 i	35	07/94→05/98	993	B	M	3	6	CB42		81441
1.3 i 16V	48	05/98→	1.295	B	M	4	16	HCE		81714

### MATERIA

1.3	67	10/06→	1.298	B	M	4	16	K3-VE	Flange: 3 holes	81808
1.3 DVVT Turbo	95	10/06→	1.298	B	M	4	16		Flange: 3 holes	81808
1.5	76	10/06→	1.495	B	M	4	16	3SZ-VE	Flange: 3 holes	81808
1.5 ECO 4WD	76	10/06→	1.495	B	M	4	16	3SZ-VE	Flange: 3 holes	81808

	kW		Cap. cm3	Fuel	Gear	No. of cyl.	No. of valves	Motor code		MAGNETI MARELLI Short
--	----	--	----------	------	------	-------------	---------------	------------	--	-----------------------

## DAIHATSU

### ROCKY HARD TOP

2.8 TD	67	12/87→04/93	2.765	D	M	4	8	DL51		81714
	75	09/91→	2.765	D	M	4	8	DL52		81714

### SIRION I

1.3 DWVT 16V	75	02/01→04/05	1.298	B	M	4	16	K3-VE	Flange: 3 holes	81808
1.3 DWVT CX 16V 4x4	75	02/01→10/02	1.298	B	M	4	16	K3-VE	Flange: 3 holes	81808
1.3 Sport	75	08/00→01/05	1.298	B	AM	4	8	K3-VE2	Flange: 3 holes	81808
1.3 Sport 4WD	75	08/00→01/05	1.298	B	M	4	8	K3-VE2	Flange: 3 holes	81808

### SIRION II

1.0	51	01/05→	998	B	M	3	12	1KR-FE		82063
1.0 DWVT Executive 4x4	51	04/05→	998	B	M	3	12	1KR-FE		82063
1.3	64	01/05→	1.298	B	M	4	16	K3-VE	Flange: 3 holes	81808
	67	03/08→	1.298	B	M	4	16	K3-VE	Flange: 3 holes	81808
1.3 4WD	67	03/08→	1.298	B	M	4	16	K3-VE	Flange: 3 holes	81808
1.3 DWVT Executive 4x4	64	04/05→	1.298	B	M	4	16	K3-VE	Flange: 3 holes	81808
1.5	76	03/08→	1.495	B	M	4	16	3SZ-VE	Flange: 3 holes	81808
1.5 4WD	76	05/06→10/08	1.495	B	M	4	16	3SZ-VE	Flange: 3 holes	81808

### STORIA

1.0	51	04/05→	998	B	M	3	12			82063
-----	----	--------	-----	---	---	---	----	--	--	-------

### TERIOS I

1.3 4WD	61	10/97→10/00	1.296	B	M	4	8	HE-EJ		81715
---------	----	-------------	-------	---	---	---	---	-------	--	-------

### TERIOS II

1.3 DWVT	63	11/05→	1.298	B	M	4	16		Flange: 3 holes	81808
1.3 DWVT 4x4	63	11/05→	1.298	B	M	4	16	K3-VE	Flange: 3 holes	81808
1.5 16V	77	05/06→	1.495	B	M	4	16	3SZ-VE	Flange: 3 holes	81808
1.5 DWVT	77	11/05→	1.495	B	M	4	16	3SZ-VE	Flange: 3 holes	81808

### YRV

1.3	64	02/01→	1.298	B	AM	4	16	K3-VE	Flange: 3 holes	81808
1.3 4WD	64	02/01→	1.298	B	AM	4	16	K3-VE	Flange: 3 holes	81808
1.3 GTti	95	07/02→	1.298	B	A	4	8	K3-VET	Flange: 3 holes	81808

## DODGE

### AVENGER

2.0 CRD	103	06/07→	1.968	D	M	4	16	ECD		81816
---------	-----	--------	-------	---	---	---	----	-----	--	-------

### CALIBER

2.0 CRD	103	06/06→	1.968	D	M	4	16	ECD		81816
---------	-----	--------	-------	---	---	---	----	-----	--	-------

### JOURNEY

2.0 CRD	103	06/08→	1.968	D	M	4	16	ECE		81816
---------	-----	--------	-------	---	---	---	----	-----	--	-------

## FIAT

### 500 II, CABRIO

1.2	51	10/07→	1.242	B	M	4	8	169A4.000		81369
	51	10/07→	1.242	B	M	4	8	169A4.000		82070
1.3 D Multijet	55	10/07→	1.248	D	M	4	16	169A1.000		81862
	70	09/09→	1.248	D	M	4	16	199B1.000		81862
1.4	74	10/07→	1.368	B	M	4	16	169A3.000		81369
	74	10/07→	1.368	B	M	4	16	169A3.000		82070

	kW		Cap. cm3	Fuel	Gear	No. of cyl.	No. of valves	Motor code		Short
--	----	--	----------	------	------	-------------	---------------	------------	--	-------

## FIAT

### 500 II, CABRIO

1.4 Abarth	99	08/08→	1.368	B	M	4	16	312A1.000		81369
	103	09/09→	1.368	B	M	4	16			82070
	118	08/08→	1.368	B	M	4	16			82070
	132	08/08→	1.368	B	M	4	16			82070
	140	08/08→	1.368	B	M	4	16			82070

### BARCETTA

1.8 16V	96	04/95→	1.747	B	M	4	16	183A1.000, 188A6.000	→08-2000	81331
	96	04/95→	1.747	B	M	4	16	183A1.000, 188A6.000	09-2000→	81348

### BRAVA

1.2 16V 80	60	12/98→10/00	1.242	B	M	4	16	182B2.000	04-1999→	81369
	59	10/00→10/01	1.242	B	M	4	16	188A5.000		81369
1.4	55	10/95→10/01	1.370	B	M	4	12	182A5.000	→12-1997, →M: 705.144	81340
	55	10/95→10/01	1.370	B	M	4	12	182A5.000	01-1998→, M→: 705.145	81351
1.4 12 V	59	10/95→08/98	1.370	B	M	4	12	182A3.000	→12-1997, →M: 705.144	81340
	59	10/95→08/98	1.370	B	M	4	12	182A3.000	01-1998→, M→: 705.145	81351
1.6 16V	66	10/95→10/01	1.581	B	M	4	16	182A6.000	(+)COP	81341
	66	10/95→10/01	1.581	B	M	4	16	182A6.000	(-)COP	81364
	76	02/96→10/01	1.581	B	M	4	16	182A4.000	(+)COP	81341
	76	02/96→10/01	1.581	B	M	4	16	182A4.000	(-)COP	81364
1.8 GT 16V	83	10/95→10/01	1.747	B	M	4	16	182A2.000	10-1995→	81331
1.9 D	48	10/95→10/01	1.929	D	M	4	8	160A7.000	(+)COP	81342
	48	10/95→10/01	1.929	D	M	4	8	160A7.000	(-)COP	81372
1.9 JTD	74	09/00→10/01	1.910	D	M	4	8	182B9.000		81330
1.9 JTD 105	77	12/98→10/01	1.910	D	M	4	8	182B4.000		81352
1.9 TD 75 S	55	03/96→10/01	1.910	D	M	4	8	182A8.000	09-1996→	81352
1.9 TD 100 S	74	03/96→10/01	1.910	D	M	4	8	182A7.000	09-1996→	81330
2.0	113	09/98→08/00	1.998	B	M	5	20	182B7.000		81329

### BRAVO I

1.2 16V 80	60	12/98→10/00	1.242	B	M	4	16	182B2.000	04-1999→	81369
	59	10/00→10/01	1.242	B	M	4	16	188A5.000		81369
1.4	55	10/95→10/01	1.370	B	M	4	12	182A5.000	→12-1997, →M: 705.144	81340
	55	10/95→10/01	1.370	B	M	4	12	182A5.000	01-1998→, M→: 705.145	81351
	59	10/95→10/01	1.370	B	M	4	12	182A3.000	→12-1997, →M: 705.144	81340
	59	10/95→10/01	1.370	B	M	4	12	182A3.000	01-1998→, M→: 705.145	81351
1.6	76	09/00→02/02	1.596	B	M	4	16	182B6.000	(+)COP	81341
	76	09/00→02/02	1.596	B	M	4	16	182B6.000	(-)COP	81364
1.6 16V	66	10/95→10/01	1.581	B	M	4	16	182A6.000	(+)COP, 10-1995→	81341
	66	10/95→10/01	1.581	B	M	4	16	182A6.000	(-)COP, 10-1995→	81364



	kW		Cap. cm3	Fuel	Gear	No. of cyl.	No. of valves	Motor code		MAGNETI MARELLI Short
--	----	--	----------	------	------	-------------	---------------	------------	--	-----------------------

## FIAT

### BRAVO I

1.6 16V	76	03/96→10/01	1.581	B	M	4	16	182A4.000	(+)COP	81341
	76	03/96→10/01	1.581	B	M	4	16	182A4.000	(-)COP	81364
1.8 GT	83	10/95→10/01	1.747	B	M	4	16	182A2.000	10-1995→	81331
1.9 D	48	10/95→10/01	1.929	D	M	4	8	160A7.000	(+)COP	81342
	48	10/95→10/01	1.929	D	M	4	8	160A7.000	(-)COP	81372
1.9 JTD	74	09/00→10/01	1.910	D	M	4	8	182B9.000		81330
1.9 JTD 105	77	12/98→10/01	1.910	D	M	4	8	182B4.000		81352
1.9 TD 75 S	55	03/96→10/01	1.910	D	M	4	8	182A8.000	09-1996→	81352
1.9 TD 100 S	74	03/96→10/01	1.910	D	M	4	8	182A7.000	09-1996→	81330
2.0 HGT 20V	108	10/95→07/98	1.998	B	M	5	20	182A1.000	10-1995→	81329
	113	07/98→10/01	1.998	B	M	5	20	182B7.000		81329

### BRAVO II

1.4	66	04/07→	1.368	B	M	4	16	192B2.000		81369
	66	04/07→	1.368	B	M	4	16	192B2.000		82070
1.4 T-Jet	88	09/07→	1.368	B	M	4	16	198A4.000		81369
	110	09/07→	1.368	B	M	4	16	198A1.000		81369
	88	09/07→	1.368	B	M	4	16	198A4.000		82070
	110	09/07→	1.368	B	M	4	16	198A1.000		82070
1.6 D Multijet	66	03/08→	1.598	D	M	4	16			81872
	77	03/08→	1.598	D	M	4	16			81872
	88	03/08→	1.598	D	M	4	16	198A2.000		81872
1.9 D Multijet	66	04/07→12/08	1.910	D	M	4	8	192B5.000		81352
	88	04/07→	1.910	D	M	4	8	192A8.000		81352
	110	04/07→	1.910	D	M	4	16	937A5.000		81872
2.0 D Multijet	121	09/08→	1.956	D	M	4	16	198A5.000		81872

### CINQUECENTO

0.9	30	07/91→12/93	903	B	M	4	8	170A1.000	(-)AC	81300
	30	07/91→12/93	903	B	M	4	8	170A1.000	(+)AC	81301
0.9 i.e.	30	07/91→12/93	903	B	M	4	8	170A1.046	(-)AC	81300
	30	07/91→12/93	903	B	M	4	8	170A1.046	(+)AC	81301
0.9 i.e. S	29	07/91→07/99	899	B	M	4	8	1170A1.000, 1170A1.046		81301
1.1 Sporting	40	10/94→01/98	1.108	B	M	4	8	176B2.000		81801

### COUPE'

1.8 16V	96	03/96→08/00	1.747	B	M	4	16	183A1.000		81331
2.0 16V	102	11/93→08/96	1.995	B	M	4	16	836A3.000	02-1994→	81322
2.0 16V Turbo	140	11/93→08/96	1.995	B	M	4	16	175A1.000	02-1994→	81322
2.0 20V	108	08/96→04/98	1.998	B	M	5	20	182A1.000	09-1996→	81329
	113	04/98→08/00	1.998	B	M	5	20	182B3.000		81329
2.0 20V Turbo	162	08/96→08/00	1.998	B	M	5	20	175A3.000	09-1996→	81329

### CROMA I

1600	61	12/85→12/90	1.585	B	M	4	8	154A.048	01-1985→, →12-1993	81444
1900 Turbo D i.d.	66	05/89→10/92	1.929	D	M	4	8	154C6.000	T→: 286.050	81309
2000 16V	101	08/92→08/96	1.995	B	M	4	16	154E1.000		81490
2000 CHT	66	12/85→02/89	1.995	B	M	4	8	154A1.000	01-1985→, →12-1992	81443
	74	01/91→09/92	1.995	B	M	4	8			81443

	kW		Cap. cm3	Fuel	Gear	No. of cyl.	No. of valves	Motor code		Short
--	----	--	----------	------	------	-------------	---------------	------------	--	-------

**FIAT**
**CROMA I**

2000 i.e.	83	03/86→09/90	1.995	B	M	4	8	834B.048	08-1986→, →02-1991, →T: 285.921	81443
	85	10/87→08/96	1.995	B	M	4	8	154C3.046, 834B.146	03-1991→, T→: 285.922	81360
	85	10/87→08/96	1.995	B	M	4	8	154C3.046, 834B.146	→02-1991, →T: 285.921	81443
	88	03/87→09/92	1.995	B	M	4	8	154C3.000, 834B.000	03-1991→, T→: 285.922	81360
	88	03/87→09/92	1.995	B	M	4	8	154C3.000, 834B.000	→02-1991, →T: 285.921	81443
2000 i.e. Turbo	110	06/87→08/96	1.995	B	M	4	8	154C4.046, 834C.146	04-1991→, T→: 285.922	81360
	110	06/87→08/96	1.995	B	M	4	8	154C4.046, 834C.146	→02-1991, →T: 285.921	81443
	111	11/86→11/88	1.995	B	M	4	8	834C.146		81443
	114	12/85→06/90	1.995	B	M	4	8	154A2.000		81443
2500 D	55	12/85→12/89	2.499	D	M	4	8	8144.67	→M: 1.340.162	81445
2500 TD	74	12/85→08/89	2.445	D	M	4	8	8144.91.2000	→M: 1.340.162	81445
	85	05/89→08/96	2.500	D	M	4	8	8144.97, 8144.97Y	10-1991→, →12-1992, →M: 1.340.163	81324
	85	05/89→08/96	2.500	D	M	4	8	8144.97, 8144.97Y	01-1993→	81325
	85	05/89→08/96	2.500	D	M	4	8	8144.97, 8144.97Y	→09-1991, →M: 1.340.162	81445
2500 TDE	77	12/91→08/96	2.500	D	M	4	8	8144.97S	→12-1992, M→: 1.340.163	81324
	77	12/91→08/96	2.500	D	M	4	8	8144.97S	01-1993→	81325
2500 V6	119	06/93→08/96	2.492	B	M	6	12	834G.000		19532/E

**CROMA II**

1.8 16V	103	12/05→	1.796	B	M	4	16	939A4.000		82083
1.9 D Multijet	85	06/05→	1.910	D	M	4	8	939A7.000		81352
	88	06/05→	1.910	D	M	4	8	939A1.000		81352
	110	06/05→	1.910	D	M	4	16	939A2.000		81872
2.2 16V	108	06/05→	2.198	B	M	4	16	194A1.000		81812
2.4 D Multijet	147	06/05→	2.387	D	M	5	20	939A3.000		81872

**DOBLO' I, CARGO**

1.2	48	03/01→	1.242	B	M	4	8	223A5.000		81370
1.3 D Multijet	55	10/05→	1.248	D	M	4	16	199A2.000		81862
	62	10/05→	1.248	D	M	4	16	223A9.000		81862
1.3 JTD	55	05/05→	1.248	D	M	4	16	199A2.000		81862
1.3 JTD 16V	51	05/04→	1.248	D	M	4	16	188A9.000		81862
1.3 JTD 16V Multijet	62	08/06→	1.248	D	M	4	16			81862
1.4	57	10/05→	1.368	B	M	4	8	350A1.000		81369
	57	10/05→	1.368	B	M	4	8	350A1.000		82070
1.6	68	09/02→	1.596	B	M	4	16	182B6.000	(+)COP	81341
	68	09/02→	1.596	B	M	4	16	182B6.000	(-)COP	81364

	kW		Cap. cm3	Fuel	Gear	No. of cyl.	No. of valves	Motor code		MAGNETI MARELLI Short
--	----	--	----------	------	------	-------------	---------------	------------	--	-----------------------

## FIAT

### DOBLO' I, CARGO

1.6 16V	76	10/01→	1.596	B	M	4	16	182B6.000	(+)COP	81341
	76	10/01→	1.596	B	M	4	16	182B6.000	(-)COP	81364
1.6 Natural Power	76	09/02→	1.596	BF	M	4	16	182B6.000	(+)COP	81341
	76	09/02→	1.596	BF	M	4	16	182B6.000	(-)COP	81364
1.9 D	46	03/01→	1.910	D	M	4	8	223A6.000		81352
1.9 D Multijet	88	10/05→	1.910	D	M	4	8	186A9.000		81352
1.9 JTD	74	10/01→	1.910	D	M	4	8	182B9.000		81352
	77	07/03→	1.910	D	M	4	8	223A7.000		81352

### DOBLO' II, CARGO

1.3 D Multijet	66	02/10→	1.248	D	M	4	16	199A3.000		81862
1.6 D Multijet	74	02/10→	1.598	D	M	4	16			81872
	77	02/10→	1.598	D	M	4	16			81872
1.6 D 16V Multijet	66	02/10→	1.598	D	M	4	16			81872
	77	02/10→	1.598	D	M	4	16			81872
2.0 D Multijet	99	02/10→	1.956	D	M	4	16			81872

## IDEA

1.2 16V	59	01/04→	1.242	B	M	4	16	188A5.000		81369
	59	01/04→	1.242	B	M	4	16	188A5.000		82070
1.3 D Multijet	66	10/05→	1.248	D	M	4	16	199A3.000		81862
1.3 JTD	51	01/04→	1.248	D	M	4	16	188A9.000		81862
1.4	57	10/05→	1.368	B	M	4	8	350A1.000		81369
	57	10/05→	1.368	B	M	4	8	350A1.000		82070
	66	12/03→	1.368	B	M	4	16	192B2.000		81369
1.4 16V	70	01/04→	1.368	B	M	4	16	843A1.000		81369
	70	01/04→	1.368	B	M	4	16	843A1.000		82070
1.9 JTD	74	01/04→	1.910	D	M	4	8	188B2.000		81352

## LINEA

1.3 D Multijet	66	06/07→	1.248	D	M	4	16	199A3.000		81862
1.4	57	06/07→	1.368	B	M	4	8	350A1.000		81369
	57	06/07→	1.368	B	M	4	8	350A1.000		82070
1.4 T-Jet	88	09/07→	1.368	B	M	4	16	198A4.000		81369
	88	09/07→	1.368	B	M	4	16	198A4.000		82070
1.6 D Multijet	77	06/09→	1.598	D	M	4	16	198A3.000		81872

## MAREA, WEEKEND

1.2 16V	60	10/98→	1.242	B	M	4	16	182B2.000		81369
1.4 80 12V	59	09/96→	1.370	B	M	4	12	182A3.000	→12-1997, →M: 705.144	81340
	59	09/96→	1.370	B	M	4	12	182A3.000	01-1998→, M→: 705.145	81351
1.6	68	03/99→08/00	1.581	B	M	4	16	185A3.000	(+)COP	81341
	68	03/99→08/00	1.581	B	M	4	16	185A3.000	(-)COP	81364
	76	09/00→08/02	1.596	B	M	4	16	182B6.000	(+)COP	81341
	76	09/00→08/02	1.596	B	M	4	16	182B6.000	(-)COP	81364
1.6 100 16V	76	09/96→	1.581	B	M	4	16	182A4.000	(+)COP	81341
	76	09/96→	1.581	B	M	4	16	182A4.000	(-)COP	81364



kW



Cap. cm3

Fuel

Gear

No. of cyl.

No. of valves

Motor code



Short

## FIAT

### MAREA, WEEKEND

1.6 100 16V Bipower	76	04/99→	1.581	BF	M	4	16	185A3.000, 186A4.000	(+)COP	81341
	76	04/99→	1.581	BF	M	4	16	185A3.000, 186A4.000	(-)COP	81364
1.6 SX	72	09/00→08/02	1.581	B	M	4	16	182B5.098	(+)COP	81341
	72	09/00→08/02	1.581	B	M	4	16	182B5.098	(-)COP	81364
1.8 115 16V	83	09/96→	1.747	B	M	4	16	182A2.000		81331
1.9 JTD 105	77	04/99→01/01	1.910	D	M	4	8	182B4.000		81352
1.9 JTD 110	81	01/01→	1.910	D	M	4	8	186A6.000		81352
1.9 TD 75	55	09/96→	1.910	D	M	4	8	182A8.000	(+)COP, 05-1999→	81303
	55	09/96→	1.910	D	M	4	8	182A8.000	→04-1999	81330
	55	09/96→	1.910	D	M	4	8	182A8.000	05-1999→	81352
1.9 TD 100	74	09/96→	1.910	D	M	4	8	182A7.000		81330
2.0 150 20V	108	09/96→04/99	1.998	B	M	5	20	182A1.000	10-1996→	81329
	110	01/01→	1.998	B	M	5	20	185A8.000		81329
2.0 155 20V	113	04/99→01/01	1.998	B	M	5	20	182B7.000		81329
2.4 JTD 130	96	04/99→	2.387	D	M	5	10	185A6.000, 839A5.000		81330
	96	04/99→	2.387	D	M	5	10	185A6.000, 839A5.000		81352
2.4 TD 125	91	09/96→04/99	2.387	D	M	5	10	185A2.000	11-1996→	81330

### MULTIPLA

1.6	68	05/04→08/05	1.596	G	M	4	16	182B6.000	(-)COP	81364
	68	05/04→08/05	1.596	G	M	4	16	182B6.000	(+)COP	81341
	74	03/01→08/05	1.596	G	M	4	16	182B6.000	(-)COP	81364
	74	03/01→08/05	1.596	G	M	4	16	182B6.000	(+)COP	81341
	76	09/00→02/01	1.596	B	M	4	16	182B6.000	(+)COP	81341
	76	09/00→02/01	1.596	B	M	4	16	182B6.000	(-)COP	81364
1.6 100 16V	76	04/99→	1.581	B	M	4	16	182A4.000	(+)COP	81341
	76	04/99→	1.581	B	M	4	16	182A4.000	(-)COP	81364
1.6 16V Bipower	76	04/99→	1.581	BF	M	4	16	186A4.000	(+)COP	81341
	76	04/99→	1.581	BF	M	4	16	186A4.000	(-)COP	81364
	76	10/01→	1.596	BF	M	4	16	182B6.000	(+)COP	81341
	76	10/01→	1.596	BF	M	4	16	182B6.000	(-)COP	81364
1.6 16V Blupower	70	04/99→	1.581	G	M	4	16	186A3.000	(+)COP	81341
	70	04/99→	1.581	G	M	4	16	186A3.000	(-)COP	81364
	70	04/02→	1.596	G	M	4	16	182B6.000	(+)COP	81341
	70	04/02→	1.596	G	M	4	16	182B6.000	(-)COP	81364
1.9 JTD	88	04/02→	1.910	D	M	4	8	186A9.000		81352
1.9 JTD 105	77	04/99→	1.910	D	M	4	8	182B4.000		81352
1.9 JTD 110	81	03/01→07/02	1.910	D	M	4	8	186A6.000		81352
1.9 JTD 115	85	07/02→	1.910	D	M	4	8	186A8.000		81352

### PALIO, WEEKEND

1.1	40	07/97→10/03	1.108	B	M	4	8			81801
1.2	44	07/97→08/02	1.242	B	M	4	8	178B7.045, 188A4.000	M→: 9.042.883	81370
	50	06/99→10/00	1.242	B	M	4	8	178E2.000	M→: 9.042.883	81370
	50	06/99→10/00	1.242	B	M	4	8	178E2.000	→M: 9.042.882	81801
	54	04/96→02/01	1.242	B	M	4	8	178B5.000, 178E2.000	→M: 9.042.882	81801
	54	04/96→02/01	1.242	B	M	4	8	178B5.000, 178E2.000	M→: 9.042.883	81370
	59	09/01→	1.242	B	M	4	16	188A5.000		81369

	kW		Cap. cm3	Fuel	Gear	No. of cyl.	No. of valves	Motor code		MAGNETI MARELLI Short
--	----	--	----------	------	------	-------------	---------------	------------	--	-----------------------

## FIAT

### PALIO, WEEKEND

1.2	59	09/01→	1.242	B	M	4	16	188A5.000	M→: 9.042.883	81370
	59	09/01→	1.242	B	M	4	16	188A5.000	→M: 9.042.882	81801
1.3 JTD Multijet	51	06/03→	1.248	D	M	4	16	188A9.000		81862
1.4	51	04/96→	1.372	B	M	4	8	178B2.000	(+)COP, (+)AC	81303
	51	04/96→	1.372	B	M	4	8	178B2.000	(-)COP, (+)AC	81339
	51	04/96→	1.372	B	M	4	8	178B2.000	(+)COP, (-)SS	81343
	51	04/96→	1.372	B	M	4	8	178B2.000	(-)COP, (-)SS	81366
1.4 Cat.	51	04/96→	1.372	B	M	4	8	178B2.016	(+)COP, (+)AC	81303
	51	04/96→	1.372	B	M	4	8	178B2.016	(-)COP, (+)AC	81339
	51	04/96→	1.372	B	M	4	8	178B2.016	(+)COP, (-)SS	81343
	51	04/96→	1.372	B	M	4	8	178B2.016	(-)COP, (-)SS	81366
1.4 EL	51	07/97→08/01	1.372	B	M	4	8	178B2.000	(+)COP, (+)AC	81303
	51	07/97→08/01	1.372	B	M	4	8	178B2.000	(-)COP, (+)AC	81339
	51	07/97→08/01	1.372	B	M	4	8	178B2.000	(+)COP, (-)SS	81343
	51	07/97→08/01	1.372	B	M	4	8	178B2.000	(-)COP, (-)SS	81366
1.6	68	07/97→10/03	1.581	B	M	4	8	178C7.098, 178D2..011	(+)COP	81341
	68	07/97→10/03	1.581	B	M	4	8	178C7.098, 178D2..011	(-)COP	81364
	70	06/99→	1.581	B	M	4	8		(-)COP	81364
	70	06/99→	1.581	B	M	4	8		(+)COP	81341
1.6 16V	74	04/96→02/01	1.581	B	M	4	16	178B3.000	(+)COP, 07-1997→	81341
	74	04/96→02/01	1.581	B	M	4	16	178B3.000	(-)COP, 07-1997→	81364
	76	02/01→	1.596	B	M	4	16	182B6.000	(+)COP	81341
	76	02/01→	1.596	B	M	4	16	182B6.000	(-)COP	81364
1.7 TD	51	04/96→03/01	1.698	D	M	4	8	176A3.000	(+)COP, →09-1999, →M: 2.427.906	81304
	51	04/96→03/01	1.698	D	M	4	8	176A3.000	(-)COP, →09-1999, →M: 2.427.906	81365
	51	04/96→03/01	1.698	D	M	4	8	176A3.000	10-1999→, M→: 2.427.907	82086
1.7 TD ED	52	07/97→10/03	1.697	D	M	4	8	176A5.000	(+)COP, →09-1999, →M: 2.427.906	81304
	52	07/97→10/03	1.697	D	M	4	8	176A5.000	(-)COP, →09-1999, →M: 2.427.906	81365
	52	07/97→10/03	1.697	D	M	4	8	176A5.000	10-1999→, M→: 2.427.907	82086
1.7 TD HL	53	09/01→	1.697	D	M	4	8	176A5.000	M→: 2.427.907	82086
1.9 D	46	09/00→	1.910	D	M	4	8	223A6.000		81352
1.9 JTD EL	59	09/01→	1.910	D	M	4	8	188A2.000		81352

### PANDA I, VAN

650	22	01/82→07/04	652	B	M	2	4	141A.000		81415
	22	01/82→07/04	652	B	M	4	8			81415
750	25	01/86→01/95	770	B	M	4	8	141B.000		81458
	25	01/86→07/92	764	B	M	4	8	141B.000		81458
	25	01/86→12/97	770	B	M	4	8	156A4.000, 156A4.048		81801
800	25	02/81→12/85	837	B	M	4	8			81415

	kw		Cap. cm3	Fuel	Gear	No. of cyl.	No. of valves	Motor code		Short
--	----	--	----------	------	------	-------------	---------------	------------	--	-------

## FIAT

### PANDA I, VAN

900	29	04/92→12/96	899	B	M	4	8	1170A1.046		81300
	33	10/80→06/94	903	B	M	4	8	100GL3.000, 146A.000	01-1992→	81300
	33	10/80→06/94	903	B	M	4	8	100GL3.000, 146A.000	→12-1991	81415
950	35	09/82→08/83	965	B	M	4	8	A112B1.054		81415
950 4x4	35	09/83→12/86	965	B	M	4	8	A112B1.054		81415
1000	37	01/85→12/92	999	B	M	4	8	156A3.000		81801
	32	01/86→04/92	999	B	M	4	8	156A2.100, 156A3.100		81801
1000 4x4	32	01/86→07/89	999	B	M	4	8	156A2.100, 156A3.100		81801
	33	05/86→12/94	999	B	M	4	8	141C2.000, 156A2.246		81801
	37	01/86→12/92	999	B	M	4	8	156A3.000		81801
1000 i.e	33	08/92→02/04	999	B	M	4	8	156A2.246		81801
1000 i.e. Cat.	33	10/87→08/98	999	B	M	4	8	141C2.000, 156A2.246		81801
1100	37	05/91→12/99	1.108	B	M	4	8	156C.046		81801
	40	02/95→09/03	1.108	B	M	4	8	176B2.000, 187A1.000		81801
1100 4x4	40	02/95→07/04	1.108	B	M	4	8	176B2.000		81801
1100 Trekking 4x4	37	10/91→07/04	1.108	B	M	4	8	156C.046		81801
1300 D	27	04/86→12/92	1.302	D	M	4	8	156A5.000		81434
1.1	40	09/00→02/04	1.108	B	M	4	8	187A1.000	M→: 2.533.529	81369
	40	09/00→02/04	1.108	B	M	4	8	187A1.000	→M: 2.533.528	81370
1.1 AWD	40	09/00→02/04	1.108	B	M	4	8	187A1.000	M→: 2.533.529	81369
	40	09/00→02/04	1.108	B	M	4	8	187A1.000	→M: 2.533.528	81370

### PANDA II, VAN

1.1	40	09/03→	1.108	B	M	4	8	187A1.000	M→: 2.533.529	81369
	40	09/03→	1.108	B	M	4	8	187A1.000	→M: 2.533.528	81370
1.2	44	09/03→	1.242	B	M	4	8	188A4.000	M→: 2533529, M→: 2.533.529	81369
	44	09/03→	1.242	B	M	4	8	188A4.000	→M: 2533528, →M: 2.533.528	81370
	44	09/03→	1.242	B	M	4	8	188A4.000		82070
	51	03/10→	1.242	B	M	4	8	169A4.000		82070
1.2 4x4	44	10/04→	1.242	B	M	4	8	188A4.000	M→: 2.533.529	81369
	44	10/04→	1.242	B	M	4	8	188A4.000	→M: 2.533.528	81370
	44	10/04→	1.242	B	M	4	8	188A4.000		82070
	51	10/04→	1.242	B	M	4	8	169A4.000		82070
1.2 Bi-Power	44	01/07→	1.242	BF	M	4	8	188A4.000		81369
1.2 LPG	44	04/09→	1.242		M	4	8	188A4.000		81369
	44	04/09→	1.242		M	4	8	188A4.000		82070
1.2 X	44	09/04→	1.242	B	M	4	8	188A4.000	M→: 2533529	81369
	44	09/04→	1.242	B	M	4	8	188A4.000	→M: 2533528	81370
1.3 D 16V Multijet 4x4	55	09/03→	1.248	D	M	4	16			81862
1.3 D Multijet	55	06/06→	1.248	D	M	4	16	169A1.000		81862
1.3 JTD	51	09/03→	1.248	D	M	4	16	188A9.000		81862
	55	01/06→	1.248	D	M	4	16	169A1.000		81862
1.3 JTD 4x4	51	10/04→	1.248	D	M	4	16	188A9.000		81862

	kW		Cap. cm3	Fuel	Gear	No. of cyl.	No. of valves	Motor code		MAGNETI MARELLI Short
--	----	--	----------	------	------	-------------	---------------	------------	--	-----------------------

## FIAT

### PANDA II, VAN

1.4	74	10/06→	1.368	B	M	4	16	169A3.000		81369
	74	10/06→	1.368	B	M	4	16	169A3.000		82070
1.4 Bi-Power / Natural Power	57	01/07→	1.368	BF	M	4	8			82070

### PUNTO EVO

1.2	48	10/09→	1.242	B	M	4	8	199A4.000		82070
	50	10/09→	1.242	B	M	4	8			82070
1.3 16V Multijet	63	10/09→	1.248	D	M	4	16			81862
1.3 D Multijet	55	10/09→	1.248	D	M	4	16	199A2.000, 199A9.000		81862
	66	10/09→	1.248	D	M	4	16	199A3.000		81862
	70	10/09→	1.248	D	M	4	16	199B1.000		81862
1.4	57	10/09→	1.368	B	M	4	8	350A1.000		82070
1.4 16V	77	10/09→	1.368	B	M	4	16	955A6.000		82070
	99	10/09→	1.368	B	M	4	16	955A2.000		82070
1.4 Abarth	120	10/09→	1.368	B	M	4	16			82070
1.4 Natural Power	57	10/09→	1.368	BF	M	4	8			82070
1.6 D Multijet	88	10/09→	1.598	D	M	4	16	955A3.000		81872

### PUNTO I, CABRIO, VAN

1.1	40	04/96→02/00	1.108	B	M	4	8	176B2.000		81801
1.4 GT Turbo	96	09/96→09/99	1.372	B	M	4	8	176B6.000	(+)COP	81303
	96	09/96→09/99	1.372	B	M	4	8	176B6.000	(-)COP	81339
	98	01/94→09/96	1.372	B	M	4	8	176A4.000	(-)COP	81339
	98	01/94→09/96	1.372	B	M	4	8	176A4.000	(+)COP	81303
1.7 D	42	04/94→02/00	1.698	D	M	4	8	176B3.000	(+)COP	81304
	42	04/94→02/00	1.698	D	M	4	8	176B3.000	(-)COP	81365
1.7 TD	51	01/94→09/99	1.698	D	M	4	8	176A3.000	(+)COP, →08-1996	81304
	51	01/94→09/99	1.698	D	M	4	8	176A3.000	08-1996→	82086
	51	01/94→09/99	1.698	D	M	4	8	176A3.000	(-)COP, →08-1996	81365
	52	01/94→02/00	1.698	D	M	4	8	176A5.000	(+)COP, →08-1996	81304
	52	01/94→02/00	1.698	D	M	4	8	176A5.000	(-)COP, →08-1996	81365
	52	01/94→09/99	1.698	D	M	4	8	176A5.000	08-1996→	82086
55 1.1	40	09/93→09/99	1.108	B	M	4	8	176A6.000, 176B2.000		81801
60 1.2	43	01/94→06/00	1.242	B	M	4	8	176A7.000		81801
	44	03/94→06/00	1.242	B	M	4	8	176B1.000, 176B4.000		81801
60 TD 1.7	46	09/96→09/99	1.698	D	M	4	8	176B7.000		82086
75 1.2	54	10/93→09/99	1.242	B	M	4	8	176A8.000		81801
85 16V 1.2	63	04/97→06/00	1.242	B	M	4	16	176B9.000		81369
90 1.6	65	01/94→04/97	1.581	B	M	4	8	176A9.000	(+)COP	81303
	65	01/94→04/97	1.581	B	M	4	8	176A9.000	(-)COP, 10-1993→	81339

### PUNTO II, VAN

1.2 16V 80	59	09/99→	1.242	B	M	4	16	188A5.000		81369
1.2 60	44	09/99→	1.242	B	M	4	8	188A4.000		81370
1.2 Natural Power	44	09/03→	1.242	BF	M	4	8	188A4.000		81370
	44	09/03→	1.242	BF	M	4	8	188A4.000		82070
1.3 JTD	51	06/03→10/05	1.248	D	M	4	16	188A9.000		81862
1.3 JTD 16V	51	06/03→	1.248	D	M	4	16	188A9.000		81862
1.4	70	09/03→	1.368	B	M	4	16	843A1.000		81369

	kW		Cap. cm3	Fuel	Gear	No. of cyl.	No. of valves	Motor code		Short
--	----	--	----------	------	------	-------------	---------------	------------	--	-------

## FIAT

### PUNTO II, VAN

1.8 130 HGT	96	09/99→	1.747	B	M	4	16	183A1.000, 188A6.000	→08-2000, M: 183 A1.000	81331
	96	09/99→	1.747	B	M	4	16	183A1.000, 188A6.000	09-2000→, M: 188 A6.000	81348
1.9 D 60	44	02/00→	1.910	D	M	4	8	188A3.000		81352
1.9 DS 60	44	09/99→	1.910	D	M	4	8	188A3.000		81352
1.9 JTD	63	02/00→	1.910	D	M	4	8	188A7.000		81352
	74	06/03→	1.910	D	M	4	8	188B2.000		81352
1.9 JTD 80	59	09/99→	1.910	D	M	4	8	188A2.000		81352

### GRANDE PUNTO

1.2	48	10/05→	1.242	B	M	4	8	199A4.000		81369
	48	10/05→	1.242	B	M	4	8	199A4.000		82070
	50	09/10→	1.242	B	M	4	8			82070
1.3 D Multijet	55	10/05→	1.248	D	M	4	16	199A2.000		81862
	66	10/05→	1.248	D	M	4	16	199A3.000		81862
1.4	57	10/05→	1.368	B	M	4	8	350A1.000		81369
	57	10/05→	1.368	B	M	4	8	350A1.000		82070
1.4 16V	70	10/05→	1.368	B	M	4	16	199A6.000		81369
	70	10/05→	1.368	B	M	4	16	199A6.000		82070
1.4 Abarth	114	12/07→	1.368	B	M	4	16			81369
	132	12/07→	1.368	B	M	4	16	199A8.000		81369
1.4 Natural Power	57	07/08→	1.368	BF	M	4	8	350A1.000		81369
1.4 T-Jet	88	09/07→	1.368	B	M	4	16	198A4.000		81369
	88	09/07→	1.368	B	M	4	16	198A4.000		82070
1.9 D Multijet	88	10/05→	1.910	D	M	4	8	939A1.000		81352
	96	10/05→	1.910	D	M	4	8	199A5.000		81352

### QUBO

1.3 D Multijet	55	09/08→	1.248	D	M	4	16	199A2.000		81862
	70	07/10→	1.248	D	M	4	16	199B1.000		81862
1.4	54	09/08→	1.360	B	M	4	8			81797
	54	01/09→	1.360	B	M	4	8			82070
1.4 Natural Power	57	10/09→	1.368	M	M	4	8			81369
	57	10/09→	1.368	M	M	4	8			82070

### REGATA, WEEKEND

60 Diesel 1.7	44	05/85→03/89	1.698	D	M	4	8	149B3.000	Mat:Al	81437
	44	05/85→03/89	1.698	D	M	4	8	149B3.000	(+)COP, Mat:Gh	81449
65 Diesel 1.9	48	04/84→07/89	1.929	D	M	4	8	149A1.000	Mat:Al, 04-1984→, →12-1986	81437
	48	04/84→07/89	1.929	D	M	4	8	149A1.000	(+)COP, 01-1987→	81446
70 1.3	48	09/83→07/89	1.301	B	M	4	8	149A3.000, 149A7.000	(-)COP, 09-1986→	81481
	48	09/83→07/89	1.301	B	M	4	8	149A3.000, 149A7.000	(+)COP, →08-1986	81482
	48	09/83→07/89	1.301	B	M	4	8	149A3.000, 149A7.000	(+)COP, 09-1986→	82060
	50	09/83→07/86	1.301	B	M	4	8	138B2.000	(+)AC	81431
	50	09/83→07/86	1.301	B	M	4	8	138B2.000	(-)COP	81481
	50	09/83→07/86	1.301	B	M	4	8	138B2.000	(+)COP	82060



	kW		Cap. cm3	Fuel	Gear	No. of cyl.	No. of valves	Motor code		Short
--	----	--	----------	------	------	-------------	---------------	------------	--	-------

## FIAT

### REGATA, WEEKEND

75 1.5	55	12/83→12/87	1.498	B	M	4	8	138B3.048, 138C3.048	(+)COP, →08-1986	81482
	55	12/83→07/89	1.498	B	M	4	8	138B3.048, 138C3.048	(-)COP, 09-1986→	81481
	55	12/83→07/89	1.498	B	M	4	8	138B3.048, 138C3.048	(+)COP, 09-1986→	82060
75 1.5 i.e.	55	07/85→07/89	1.498	B	M	4	8	138C2.048, 149C1.000	(-)COP, 09-1986→	81481
	55	07/85→07/89	1.498	B	M	4	8	138C2.048, 149C1.000	(+)COP, →08-1986	81482
	55	07/85→07/89	1.498	B	M	4	8	138C2.048, 149C1.000	(+)COP, 09-1986→	82060
75 1.5 i.e. Cat.	55	12/86→07/89	1.498	B	M	4	8	138C2.048	(-)COP	81481
	55	12/86→07/89	1.498	B	M	4	8	138C2.048	(+)COP	82060
80 Turbo Diesel 1.9	59	05/86→07/89	1.929	D	M	4	8	831D1.000	(+)COP	81446
85 1.5	58	05/85→12/87	1.498	B	M	4	8	149A5.000	(+)AC	81431
	60	01/84→04/89	1.498	B	M	4	8	138B3.000	(-)COP	81481
	60	01/84→04/89	1.498	B	M	4	8	138B3.000	(+)COP	82060
85 1.6	60	10/83→06/90	1.585	B	M	4	8	149A.000		81435
85 Super 1.5	60	09/83→04/85	1.498	B	M	4	8	138B3.000	(-)COP	81481
	60	09/83→04/85	1.498	B	M	4	8	138B3.000	(+)COP	82060
90 i.e. 1.6	66	01/87→07/89	1.595	B	M	4	8	149C2.000	01-1986→, →12-1990	81436
100 1.6	74	09/84→12/86	1.585	B	M	4	8	149A4.000	01-1984→, →12-1990	81436
100 Super 1.6	70	10/83→07/89	1.585	B	M	4	8	149C3.000		81436
	74	10/83→12/90	1.585	B	M	4	8	149A2.000, 149A4.000		81436

### RITMO II, CABRIO

50 1.3	50	10/85→12/87	1.302	B	M	4	8		(+)AC	81431
	50	10/85→12/87	1.302	B	M	4	8		(-)COP, (-)AC	81481
	50	10/85→12/87	1.302	B	M	4	8		(+)COP, (-)AC	82060
60 1.1	40	10/82→10/85	1.116	B	M	4	8	138B.000, 138B1.000, 138C1.000	(-)COP, M: 138B000	81481
	40	10/82→10/85	1.116	B	M	4	8	138B.000, 138B1.000, 138C1.000	(+)COP	81482
	40	10/82→10/85	1.116	B	M	4	8	138B.000, 138B1.000, 138C1.000	(+)COP, M: 138B000	82060
	43	04/85→12/87	1.116	B	M	4	8	146A4.048	(-)COP	81481
	43	04/85→12/87	1.116	B	M	4	8	146A4.048	(+)COP	82060
60 Diesel 1.7	44	05/85→12/87	1.698	D	M	4	8	138C.000, 149B3.000	Mat:Al	81437
	44	05/85→12/87	1.698	D	M	4	8	138C.000, 149B3.000	(+)COP, Mat:Gh	81449
70 1.3	50	01/83→04/85	1.301	B	M	4	8	138B2.000	(+)AC	81431
	50	01/83→04/85	1.301	B	M	4	8	138B2.000	(-)COP, (-)AC	81481
	50	01/83→04/85	1.301	B	M	4	8	138B2.000	(+)COP, (-)AC	82060
75 1.5	55	09/85→12/88	1.498	B	M	4	8	138A2.000	(+)AC	81431
	55	09/85→12/88	1.498	B	M	4	8	138A2.000	(+)COP, (-)AC	81482
75 1.5 Cat.	55	09/85→12/88	1.498	B	M	4	8	138C2.048, 149C1.000	(+)AC	81431
	55	09/85→12/88	1.498	B	M	4	8	138C2.048, 149C1.000	(+)COP, (-)AC	81482
80 Turbo Diesel 1.9	59	12/85→12/87	1.929	D	M	4	8	831D1.000	(+)COP	81446
85 1.5	58	08/85→05/87	1.498	B	M	4	8	149A5.000	(+)AC	81431
	58	08/85→05/87	1.498	B	M	4	8	149A5.000	(+)COP, (-)AC	81482
	60	01/83→12/87	1.498	B	M	4	8	138B3.000	(+)AC	81431

	kW		Cap. cm3	Fuel	Gear	No. of cyl.	No. of valves	Motor code		Short
--	----	--	----------	------	------	-------------	---------------	------------	--	-------

## FIAT

### RITMO II, CABRIO

85 1.5	60	01/83→12/87	1.498	B	M	4	8	138B3.000	(+)COP, (-)AC	81482
	63	01/80→07/89	1.498	B	M	4	8	138A4.000	(+)AC	81431
	63	01/80→07/89	1.498	B	M	4	8	138A4.000	(+)COP, (-)AC	81482
90 1.6 i.e.	66	12/85→12/87	1.585	B	M	4	8	138AR.000		81436
100 1.6	74	01/83→12/87	1.585	B	M	4	8	138AR.048, 149A4.000	01-1986→	81436
	74	10/85→12/87	1.585	B	M	4	8	138AR.048	→12-1985	81440
	77	10/85→12/87	1.585	B	M	4	8	138AR.000	01-1986→	81436
	77	10/85→12/87	1.585	B	M	4	8	138AR.000	→12-1985	81440
105 1.6	77	01/83→12/87	1.585	B	M	4	8	138AR.000		81440
125 TC Abarth 2.0	92	12/82→12/87	1.995	B	M	4	8	138AR1.000		81440
130 TC Abarth 2.0	96	04/83→12/87	1.995	B	M	4	8	138AR2.000		81440

### SEDICI

1.6 16V	79	06/06→	1.586	B	M	4	16	M16A		82026
	88	06/06→	1.586	B	M	4	16			82026
1.6 16V 4x4	88	06/06→	1.586	B	M	4	16			82026
1.9 D Multijet	88	06/06→	1.910	D	M	4	8	D19AA		81352
2.0 D Multijet	99	06/06→	1.956	D	M	4	16			81872
2.0 D Multijet 4x4	99	06/06→	1.956	D	M	4	16			81872

### SEICENTO, VAN

0.9	29	01/98→	899	B	M	4	8	1170A1.046		81300
1.1	40	01/98→	1.108	B	M	4	8	176B2.000, 187A1.000	05-1999→, M→: 9.042.883	81370
	40	01/98→	1.108	B	M	4	8	176B2.000, 187A1.000	→04-1999, →M: 9.042.882	81801

### SIENA

1.2	44	09/01→	1.242	B	M	4	8	188A4.000		81370
	54	09/98→	1.242	B	M	4	8	178B5.000	07-1999→	81370
	54	09/98→	1.242	B	M	4	8	178B5.000	→06-1999	81801
	57	06/02→	1.242	B	M	4	16			81369
	59	09/01→	1.242	B	M	4	16	188A5.000		81369
1.4	51	04/96→	1.372	B	M	4	8	178B2.000	(+)COP, (+)SS, (+)AC	81303
	51	04/96→	1.372	B	M	4	8	178B2.000	(-)COP, (+)SS, (+)AC	81339
	51	04/96→	1.372	B	M	4	8	178B2.000	(+)COP, (-)AC, (-)SS	81343
	51	04/96→	1.372	B	M	4	8	178B2.000	(-)COP, (-)AC, (-)SS	81366
1.4 Cat.	51	04/96→	1.372	B	M	4	8	178B2.016	(+)COP, (+)SS, (+)AC	81303
	51	04/96→	1.372	B	M	4	8	178B2.016	(-)COP, (+)SS, (+)AC	81339
	51	04/96→	1.372	B	M	4	8	178B2.016	(+)COP, (-)AC, (-)SS	81343
	51	04/96→	1.372	B	M	4	8	178B2.016	(-)COP, (-)AC, (-)SS	81366
1.6	76	11/00→	1.596	B	M	4	16	182B6.000	(+)COP	81341
	76	11/00→	1.596	B	M	4	16	182B6.000	(-)COP	81364
1.6 16V	78	09/98→	1.581	B	M	4	16	178B3.000	(+)COP	81341
	78	09/98→	1.581	B	M	4	16	178B3.000	(-)COP	81364
1.7 GL	51	02/06→	1.697	D	M	4	8	176A3.000		82086
1.9	46	11/00→	1.910	D	M	4	8	223A6.000		81352

	kW		Cap. cm3	Fuel	Gear	No. of cyl.	No. of valves	Motor code		Short
--	----	--	----------	------	------	-------------	---------------	------------	--	-------

## FIAT

### STILO, STATION WAGON

1.2 16V	59	02/02→	1.242	B	M	4	16	188A5.000		81369
1.4 16V	66	03/05→	1.368	B	M	4	16	192B2.000		82070
	66	03/05→	1.368	B	M	4	16	192B2.000		81369
	70	01/04→	1.368	B	M	4	16	843A1.000		81369
	70	01/04→	1.368	B	M	4	16	843A1.000		82070
1.6	100	04/05→	1.596	B	M	4	16			82083
1.6 16V	76	10/01→	1.596	B	M	4	16	182B6.000	(+)COP	81341
	76	10/01→	1.596	B	M	4	16	182B6.000	(-)COP	81364
	77	05/05→	1.598	B	M	4	16	192B30	(+)COP	81341
	77	05/05→	1.598	B	M	4	16	192B30	(-)COP	81364
1.8 16V	98	10/01→	1.747	B	M	4	16	192A4.000		81348
1.9 D	66	09/04→	1.910	D	M	4	8	192B5.000		81352
1.9 D Multijet	74	09/05→	1.910	D	M	4	8	192A9.000		81352
	88	09/05→	1.910	D	M	4	8	192A8.000		81352
	110	09/05→	1.910	D	M	4	16	937A5.000		81872
1.9 JTD	59	02/02→	1.910	D	M	4	8	192A3.000		81352
	66	09/04→	1.910	D	M	4	8	192B5.000		81352
	85	10/01→	1.910	D	M	4	8	192A1.000, 937A7.000		81352
	93	09/03→	1.910	D	M	4	16	937A4.000		81872
	100	04/04→	1.910	D	M	4	16	192B1.000		81872
	103	01/04→	1.910	D	M	4	16	192A5.000		81872
2.4 20V	125	10/01→	2.446	B	M	5	20	192A2.000		81329

### STRADA

1.2	44	04/03→	1.242	B	M	4	8	188A4.000		81370
	44	04/03→	1.242	B	M	4	8	188A4.000		82070
	54	06/99→	1.242	B	M	4	8	178B5.000		81801
	54	06/99→	1.242	B	M	4	8	178B5.000		82070
1.2 Trekking	60	11/05→	1.242	B	M	4	8			81369
1.3 D Multijet	62	05/06→	1.248	D	M	4	16	223A9.000		81862
1.6 Trekking	76	11/05→	1.581	B	M	4	8		(+)COP	81341
	76	11/05→	1.581	B	M	4	8		(-)COP	81364
1.7 TD	51	06/99→	1.698	D	M	4	8	176A3.000	(+)COP, →M: 2.427.906	81304
	51	06/99→	1.698	D	M	4	8	176A3.000	(-)COP, →M: 2.427.906	81365
	51	06/99→	1.698	D	M	4	8	176A3.000	M→: 2.427.907	82086
1.9 D	46	12/00→	1.910	D	M	4	8	223A6.000		81352
1.9 JTD	59	04/03→	1.910	D	M	4	8	188A2.000		81352

### TEMPRA, STATION WAGON

1.4 i.e.	51	03/92→08/96	1.372	B	M	4	8	160A1.046, 836A4.000	(-)COP, 01-1993→, M→: 9.336.693, (+)AC	81339
	51	03/92→08/96	1.372	B	M	4	8	160A1.046, 836A4.000	(+)COP, 01-1993→, M→: 9.336.693, (+)AC	81303
	51	03/92→08/96	1.372	B	M	4	8	160A1.046, 836A4.000	(+)COP, M→: 9.336.693, (-)SS	81343
	51	03/92→08/96	1.372	B	M	4	8	160A1.046, 836A4.000	→12-1992, →M: 9.336.692, (+)SS, (+)AC	81333

	kW		Cap. cm3	Fuel	Gear	No. of cyl.	No. of valves	Motor code		Short
--	----	--	----------	------	------	-------------	---------------	------------	--	-------

**FIAT**
**TEMPRA, STATION WAGON**

1.4 i.e.	51	03/92→08/96	1.372	B	M	4	8	160A1.046, 836A4.000	(-)COP, M→: 9.336.693, (-)SS	<b>81366</b>
	51	03/92→08/96	1.372	B	M	4	8	160A1.046, 836A4.000	(-)COP, →M: 9.336.692, (+)AC	<b>81314</b>
	51	03/92→08/96	1.372	B	M	4	8	160A1.046, 836A4.000	(+)COP, →M: 9.336.692, (+)AC	<b>81476</b>
	57	03/91→08/96	1.372	B	M	4	8	159A2.000	(+)COP, 01-1993→, (+)AC	<b>81303</b>
	57	03/91→08/96	1.372	B	M	4	8	159A2.000	(+)COP, →M: 9.336.692, (+)AC	<b>81476</b>
	57	03/91→08/96	1.372	B	M	4	8	159A2.000	(+)COP, M→: 9.336.693, (-)SS	<b>81343</b>
	57	03/91→08/96	1.372	B	M	4	8	159A2.000	(-)COP, →M: 9.336.692, (+)AC	<b>81314</b>
	57	03/91→08/96	1.372	B	M	4	8	159A2.000	(-)COP, M→: 9.336.693, (-)SS	<b>81366</b>
	57	03/91→08/96	1.372	B	M	4	8	159A2.000	→12-1992, →M: 9.336.692	<b>81333</b>
	57	03/91→08/96	1.372	B	M	4	8	159A2.000	(-)COP, 01-1993→, (+)AC	<b>81339</b>
1.6	51	04/90→06/93	1.581	B	M	4	8	159A3.048	(+)SS, (+)AC	<b>81333</b>
	51	04/90→06/93	1.581	B	M	4	8	159A3.048	(-)COP, (+)AC	<b>81314</b>
	51	04/90→06/93	1.581	B	M	4	8	159A3.048	(+)COP, (+)AC	<b>81476</b>
	51	07/93→07/96	1.581	B	M	4	8	159A3.048	(+)COP, (+)AC	<b>81303</b>
	51	07/93→07/96	1.581	B	M	4	8	159A3.048	(-)COP, (+)AC	<b>81339</b>
	63	03/90→04/93	1.581	B	M	4	8	159A3.000	(-)COP, (+)AC	<b>81314</b>
	63	03/90→04/93	1.581	B	M	4	8	159A3.000	(+)SS, (+)AC	<b>81333</b>
	63	03/90→04/93	1.581	B	M	4	8	159A3.000	(+)COP, (+)AC	<b>81476</b>
1.6 i.e.	55	06/92→08/96	1.581	B	M	4	8	159A3.048, 835C1.000	(+)COP, (+)AC	<b>81303</b>
	55	06/92→08/96	1.581	B	M	4	8	159A3.048, 835C1.000	(-)COP, (+)AC	<b>81339</b>
	57	10/90→08/96	1.581	B	M	4	8	159A3.046, 835C1.000	(+)COP, 01-1993→, (+)AC	<b>81303</b>
	57	06/90→08/96	1.581	B	M	4	8	159A3.046, 835C1.000	(+)COP, →12-1992, (+)AC	<b>81476</b>
	57	10/90→08/96	1.581	B	M	4	8	159A3.046, 835C1.000	(-)COP, 01-1993→, (+)AC	<b>81339</b>
	57	06/90→08/96	1.581	B	M	4	8	159A3.046, 835C1.000	(-)COP, →12-1992, (+)AC	<b>81314</b>
	57	06/90→08/96	1.581	B	M	4	8	159A3.046, 835C1.000	→12-1992, (+)AC, (+)SS, (+)AC	<b>81333</b>
	63	06/94→08/96	1.581	B	M	4	8	159B9.000	(+)COP, (+)AC	<b>81303</b>
	63	06/94→08/96	1.581	B	M	4	8	159B9.000	(-)COP, (+)AC	<b>81339</b>
	66	06/94→08/96	1.581	B	M	4	8	159B9.000	(+)COP, (+)AC	<b>81303</b>
66	06/94→08/96	1.581	B	M	4	8	159B9.000	(-)COP, (+)AC	<b>81339</b>	

	kw		Cap. cm3	Fuel	Gear	No. of cyl.	No. of valves	Motor code		Short
--	----	--	----------	------	------	-------------	---------------	------------	--	-------

## FIAT

### TEMPRA, STATION WAGON

1.8 i.e.	66	09/93→08/96	1.756	B	M	4	8	835C4.000		<b>81315</b>
	74	10/94→08/96	1.756	B	M	4	8	836A5.000	01-1992→, →07-1996	<b>81315</b>
	76	09/93→08/96	1.756	B	M	4	8	835C2.000	01-1992→, →07-1996	<b>81315</b>
	77	03/92→08/96	1.756	B	M	4	8	159A4.046	01-1992→, →07-1996	<b>81315</b>
	81	03/90→08/96	1.756	B	M	4	8		07-1992→	<b>81315</b>
	81	03/90→08/96	1.756	B	M	4	8		→06-1992	<b>81477</b>
1.9 D	48	07/91→08/96	1.929	D	M	4	8	160A7.000	(+)COP	<b>81328</b>
	48	07/91→08/96	1.929	D	M	4	8	160A7.000	(-)COP	<b>81363</b>
1.9 TD	66	05/90→08/96	1.929	D	M	4	8	160A6.000, 160D1.000	(-)COP, →M: 1.071.902, (+)AC	<b>81326</b>
	66	05/90→08/96	1.929	D	M	4	8	160A6.000, 160D1.000	(+)COP, →M: 1.071.902, (+)AC	<b>81464</b>
2.0 i.e.	83	10/90→08/96	1.995	B	M	4	8	159A6.046	01-1992→	<b>81315</b>
	83	10/90→08/96	1.995	B	M	4	8	159A6.046	→12-1991	<b>81360</b>
2.0 i.e. 4x4	83	03/92→03/95	1.995	B	M	4	8	159A6.046		<b>81315</b>

### TIPO

1.1	41	01/88→10/91	1.108	B	M	4	8	160A3.000		<b>81801</b>
1.4	52	07/87→12/89	1.372	B	A	4	8	160A1.000, 160A1.048	(-)COP, (+)AC	<b>81314</b>
	52	07/87→12/89	1.372	B	A	4	8	160A1.000, 160A1.048	(+)AC, (+)SS	<b>81333</b>
	52	07/87→12/89	1.372	B	A	4	8	160A1.000, 160A1.048	(+)COP, (+)AC	<b>81476</b>
1.4 i.e.	51	05/89→04/95	1.372	B	M	4	8	160A1.046, 836A4.000	(-)COP, (+)AC	<b>81314</b>
	51	05/89→04/95	1.372	B	M	4	8	160A1.046, 836A4.000	(+)AC, (+)SS	<b>81333</b>
	51	05/89→04/95	1.372	B	M	4	8	160A1.046, 836A4.000	(+)COP, (+)AC	<b>81476</b>
	57	05/89→04/95	1.372	B	M	4	8	159A2.000	(-)COP, (+)AC	<b>81314</b>
	57	05/89→04/95	1.372	B	M	4	8	159A2.000	(+)AC, (+)SS	<b>81333</b>
	57	05/89→04/95	1.372	B	M	4	8	159A2.000	(+)COP, (+)AC	<b>81476</b>
1.6	61	01/88→10/91	1.581	B	M	4	8	160A2.000	(-)COP, (+)AC	<b>81314</b>
	61	01/88→10/91	1.581	B	M	4	8	160A2.000	(+)AC, (+)SS	<b>81333</b>
	61	01/88→10/91	1.581	B	M	4	8	160A2.000	(+)COP, (+)AC	<b>81476</b>
1.6 i.e.	55	10/92→04/95	1.581	B	M	4	8	159A3.048, 835C1.000	(-)COP, (+)AC	<b>81314</b>
	55	10/92→04/95	1.581	B	M	4	8	159A3.048, 835C1.000	(+)AC, (+)SS	<b>81333</b>
	55	10/92→04/95	1.581	B	M	4	8	159A3.048, 835C1.000	(+)COP, (+)AC	<b>81476</b>
	57	07/90→01/93	1.581	B	M	4	8	159A3.046	(+)COP, (+)AC	<b>81476</b>
	57	07/90→01/93	1.581	B	M	4	8	159A3.046	(-)COP, (+)AC	<b>81314</b>
	57	07/90→01/93	1.581	B	M	4	8	159A3.046	(+)AC, (+)SS	<b>81333</b>
	66	02/88→05/91	1.595	B	M	4	8	149C2.046		<b>81477</b>
1.6 SX DGT	66	05/89→10/92	1.581	B	M	4	8	159A3.000		<b>81477</b>
1.7 D	43	01/88→10/94	1.697	D	M	4	8	149B4.000	(+)COP, 01-1993→	<b>81328</b>
	43	01/88→10/94	1.697	D	M	4	8	149B4.000	(+)COP, →12-1992	<b>81463</b>
	43	01/88→10/94	1.697	D	M	4	8	149B4.000	(-)COP, 01-1993→	<b>81363</b>
	45	01/88→10/95	1.697	D	M	4	8		(+)COP, 01-1993→	<b>81328</b>
	45	01/88→10/95	1.697	D	M	4	8		(-)COP, 01-1993→	<b>81363</b>
45	01/88→10/95	1.697	D	M	4	8		(+)COP, →12-1992	<b>81463</b>	



kW



Cap. cm3

Fuel

Gear

No. of cyl.

No. of valves

Motor code

MAGNETI MARELLI  
Short

## FIAT

### TIPO

1.8 i.e	66	09/93→04/95	1.756	B	M	4	8	835C4.000		81315
	71	03/93→04/95	1.756	B	M	4	8	836A5.000		81315
	74	10/94→04/95	1.756	B	M	4	8	159A4.000		81315
	76	04/93→04/95	1.756	B	M	4	8	835C2.000		81315
	77	10/90→06/93	1.756	B	M	4	8	159A4.046		81315
	81	10/90→06/93	1.756	B	M	4	8	159A4.000		81315
1.8 i.e.16V Sport	100	11/89→06/92	1.756	B	M	4	16	160A5.000		81477
1.9 D	48	07/91→08/96	1.929	D	M	4	8	160A7.000	(+)COP, 01-1993→	81328
	48	07/91→08/96	1.929	D	M	4	8	160A7.000	(-)COP, 01-1993→	81363
	48	07/91→08/96	1.929	D	M	4	8	160A7.000	(+)COP, →12-1992	81463
1.9 TD	59	03/92→06/93	1.929	D	M	4	8	160B6.046	(+)COP, →12-1992, (+)SS, (+)AC	81464
	59	03/92→06/93	1.929	D	M	4	8	160B6.046	(-)COP, →12-1992, (+)SS, (+)AC	81326
	66	09/90→04/95	1.929	D	M	4	8	160A6.000, 160A6.046, 160D1.000	(-)COP, →12-1992, (+)AC, (+)SS, (+)AC	81326
	66	09/90→04/95	1.929	D	M	4	8	160A6.000, 160A6.046, 160D1.000	(+)COP, →12-1992, (+)AC, (+)SS, (+)AC	81464
2.0 16V	107	07/91→04/95	1.995	B	M	4	16	160A8.046		81315
2.0 i.e.	80	06/90→03/92	1.995	B	M	4	8	159A5.046	07-1991→	81315
	80	06/90→03/92	1.995	B	M	4	8	159A5.046	→06-1991	81360
	83	03/90→04/95	1.995	B	M	4	8	159A6.046	07-1991→	81315
	83	03/90→04/95	1.995	B	M	4	8	159A6.046	→06-1991	81360
2.0 i.e. 16V Sport	102	03/93→04/95	1.995	B	M	4	16	836A3.000		81322

### ULYSSE I

1.8	73	05/97→08/02	1.761	B	M	4	8	LFW		81512
1.9 TD	66	02/95→08/02	1.905	D	M	4	8	DHX (XUD9TF/L)	05-1995→	81642
	66	02/95→08/02	1.905	D	M	4	8	DHX (XUD9TF/L)	→04-1995	81672
2.0	89	06/94→08/02	1.998	B	M	4	8	RFU (XU10J2C)		81642
2.0 16V	100	09/00→08/02	1.997	B	M	4	16	RFN		81711
	97	05/98→09/00	1.998	B	M	4	16	RFV		81711
2.0 JTD	80	10/99→08/02	1.997	D	M	4	8	RHZ		81713
2.0 Turbo	108	06/94→08/02	1.998	B	M	4	8	RGX (XU10J2CTE)		81642
2.1 TD	80	03/96→10/99	2.088	D	M	4	8	P8C	04-1996→	81353

### ULYSSE II

2.0	100	08/02→	1.997	B	M	4	16	RFN (EW10J4)	(-)COP	81799
	100	08/02→	1.997	B	M	4	16	RFN (EW10J4)	(+)COP	82089
2.0 D Multijet	88	05/06→	1.997	D	M	4	16	RHK		81800
	100	05/06→	1.997	D	M	4	16	RHR		81800
2.0 JTD	79	05/03→	1.997	D	M	4	16	RHM (DW10ATED4)		81713
	80	08/02→	1.997	D	M	4	16	RHW (DW10ATED4)		81713
2.2 D Multijet	125	03/08→	2.179	D	M	4	16			82068
2.2 JTD	94	08/02→	2.179	D	M	4	16	4HW (DW12ATED4)		81800
3.0 V6	150	08/02→	2.946	B	M	6	24	XFW		81813

	kW		Cap. cm3	Fuel	Gear	No. of cyl.	No. of valves	Motor code		MAGNETI MARELLI Short
--	----	--	----------	------	------	-------------	---------------	------------	--	-----------------------

## FIAT

UNO										
1.0	35	11/94→08/00	994	B	M	4	8	146A2.166		81434
1.0 iE	34	05/98→08/00	999	B	M	4	8	156A2.246		81801
1.3 Super Diesel	33	06/83→03/92	1.302	D	M	4	8	127A5.000, 146B1.000		81434
1.3 Turbo i.e.	73	01/87→12/87	1.301	B	M	4	8	146A2.146	(+)COP, 01-1985→, →12-1990	81482
	74	09/89→03/91	1.301	B	M	4	8	146A2.246	(+)COP	81482
	77	04/85→08/89	1.301	B	M	4	8	146A2.000	(+)COP	81482
1.4 Turbo i.e.	82	09/89→09/93	1.372	B	M	4	8	146A8.046	(-)COP	81481
	82	09/89→09/93	1.372	B	M	4	8	146A8.046	(+)COP	82060
	87	12/89→12/96	1.372	B	M	4	8	146A8.000	(-)COP	81481
	87	12/89→12/96	1.372	B	M	4	8	146A8.000	(+)COP	82060
1.9 D	44	09/89→03/94	1.929	D	M	4	8	149B5.046	(+)COP	81469
45 0.9	33	03/83→09/92	903	B	M	4	8	146A.000, 146A.1000		81415
45 1.0	32	06/86→12/93	999	B	M	4	8	156A2.048, 156A2.100		81801
	37	06/86→12/93	999	B	M	4	8			81801
45 i.e. 1.0	33	04/84→10/95	999	B	M	4	8	156A2.246		81801
50 1.1	37	01/90→12/93	1.108	B	M	4	8	156C.046	01-1989→, →12-1991	81801
	37	01/86→12/89	1.116	B	M	4	8	146A4.044		81434
50 i.e. 1.1	36	06/92→12/93	1.116	B	M	4	8	146C3.000		81801
55 1.0	41	04/94→08/00	994	B	M	4	8			81434
55 1.1	40	01/83→08/89	1.116	B	M	4	8	138B.000	(-)COP	81481
	40	01/83→08/89	1.116	B	M	4	8	138B.000	(+)COP	82060
60 1.1	42	04/89→12/92	1.108	B	M	4	8	160A3.000		81801
	43	05/85→08/89	1.116	B	M	4	8	146A4.048	(-)COP	81481
	43	05/85→08/89	1.116	B	M	4	8	146A4.048	(+)COP	82060
60 Diesel 1.7	42	09/89→12/93	1.698	D	M	4	8	146B2.000	(+)COP	81469
	44	07/86→08/89	1.698	D	M	4	8	149B3.000	(+)COP	81469
70 1.3	48	05/85→08/89	1.302	B	M	4	8	149A7.000	(-)COP	81481
	48	05/85→08/89	1.302	B	M	4	8	149A7.000	(+)COP	82060
	50	01/83→04/85	1.302	B	M	4	8	138B2.000	(-)COP, 01-1983→, →12-1985	81481
	50	01/83→04/85	1.302	B	M	4	8	138B2.000	(+)COP	82060
70 i.e. 1.4	51	09/89→12/93	1.372	B	M	4	8	160A1.046	(-)COP, (+)AC	81314
	51	09/89→12/93	1.372	B	M	4	8	160A1.046	(+)SS, (+)AC	81333
	51	09/89→12/93	1.372	B	M	4	8	160A1.046	(+)COP, (+)AC	81476
	51	09/89→12/93	1.372	B	M	4	8	160A1.046	(-)COP, (-)AC	81481
	51	09/89→12/93	1.372	B	M	4	8	160A1.046	(+)COP, (-)AC	82060
	53	09/89→12/93	1.372	B	M	4	8	146C1.000	(-)COP, (+)AC	81314
	53	09/89→12/93	1.372	B	M	4	8	146C1.000	(+)SS, (+)AC	81333
	53	09/89→12/93	1.372	B	M	4	8	146C1.000	(+)COP, (+)AC	81476
	53	09/89→12/93	1.372	B	M	4	8	146C1.000	(-)COP, (-)AC	81481
	53	09/89→12/93	1.372	B	M	4	8	146C1.000	(+)COP, (-)AC	82060
70 TD 1.4	52	10/86→10/90	1.367	D	M	4	8	146B.000, 146B3.000	(+)COP, →12-1989, M: 146B.000	81450
75 i.e. 1.5	55	10/85→12/93	1.499	B	M	4	8	138C2.048, 149C1.000	(+)COP	81482

	kW		Cap. cm3	Fuel	Gear	No. of cyl.	No. of valves	Motor code		Short
--	----	--	----------	------	------	-------------	---------------	------------	--	-------

**FIAT**
**DUCATO I**

1.8	49	01/82→10/88	1.783	B	M	4	8	169B		81367
	51	07/82→12/88	1.783	B	M	4	8			81367
1.9 D	52	02/87→08/90	1.929	D	M	4	8	149B1.000		81489
1.9 TD	60	03/89→08/90	1.929	D	M	4	8	280A1.000		81489
2.0	55	07/85→08/90	1.971	B	M	4	8	170B		81367
	58	01/82→08/90	1.971	B	M	4	8	XN1T		81367
	62	08/88→08/90	1.971	B	M	4	8	170D		81367
2.4 D	53	01/82→08/90	2.428	D	M	4	8	8144.61	10-1986→	81488
	53	01/82→08/90	2.428	D	M	4	8	8144.61	→09-1986	81492
2.5 D	55	01/82→08/90	2.500	D	M	4	8	8144.67, CRD93L (U25-661)		81822
2.5 D 4x4	55	01/87→08/90	2.500	D	M	4	8	8144.67		81488
2.5 TD	68	01/86→08/90	2.445	D	M	4	8	8144.21, 8144.21.220		81488
2.5 TD 4x4	68	01/86→08/90	2.445	D	M	4	8	8144.21		81488
	68	09/86→05/90	2.499	D	M	4	8			81488
	70	09/86→05/90	2.499	D	M	4	8	8140.27		81488

**DUCATO II**

1.9 D	52	07/90→03/94	1.929	D	M	4	8	149B1.000		81489
1.9 TD	60	03/89→03/94	1.929	D	M	4	8	280A1.000		81489
2.0	62	07/90→03/94	1.971	B	M	4	8	170D		81367
	63	06/90→05/94	1.971	B	M	4	8	170D		81367
2.0 4x4	63	06/90→05/94	1.971	B	M	4	8	170D		81367
2.5 D	55	07/90→03/94	2.500	D	M	4	8	8144.67		81488
2.5 D 4x4	55	07/90→03/94	2.500	D	M	4	8	8144.67		81488
2.5 TD	70	07/90→03/94	2.500	D	M	4	8	8140.27		81488
2.5 TD 4x4	70	06/90→05/94	2.499	D	M	4	8	8140.27		81488
	70	07/90→03/94	2.500	D	M	4	8	8140.27		81488

**DUCATO III**

1.9	59	05/98→11/01	1.905	D	M	4	8			81318
1.9 D	51	03/94→04/02	1.929	D	M	4	8	230A2.000	03-1994→	81320
	50	04/98→04/02	1.905	D	M	4	8	D9B, DJY		81642
1.9 D Combinato	51	06/95→04/02	1.929	D	M	4	8	230A2.000		81320
1.9 TD	59	05/98→11/01	1.905	D	M	4	8			81642
	60	03/94→04/02	1.929	D	M	4	8	230A3.000	(-)AC	81318
	60	03/94→04/02	1.929	D	M	4	8	230A3.000	(+)AC	81319
	66	04/98→04/02	1.905	D	M	4	8	DHX (XUD9TF/L)		81642
1.9 TD CAT	59	08/94→04/02	1.929	D	M	4	8	230A4.000	(-)AC	81318
	59	08/94→04/02	1.929	D	M	4	8	230A4.000	(+)AC	81319
1.9 TD Combinato	59	08/94→04/02	1.929	D	M	4	8	230A4.000	(-)AC	81318
	59	08/94→04/02	1.929	D	M	4	8	230A4.000	(+)AC	81319
1.9 TD Panorama/Combinato	60	03/94→04/02	1.929	D	M	4	8	230A3.000	(-)AC	81318
	60	03/94→04/02	1.929	D	M	4	8	230A3.000	(+)AC	81319
2.0	74	06/94→12/95	1.998	B	M	4	8			81642
	80	03/94→04/02	1.998	B	M	4	8	RFW		81642
2.0 4x4	80	11/94→04/02	1.998	B	M	4	8	RFW		81642
2.0 JTD	62	10/01→04/02	1.997	D	M	4	8	RHV (DW10)		81713



	kW		Cap. cm3	Fuel	Gear	No. of cyl.	No. of valves	Motor code		MAGNETI MARELLI Short
--	----	--	----------	------	------	-------------	---------------	------------	--	-----------------------

## FIAT

### DUCATO III

2.0 Panorama/Combinato	80	03/94→04/02	1.998	B	M	4	8	RFW		81642
2.5 D	62	03/94→04/02	2.500	D	M	4	8	8140.67		81316
2.5 D 4x4	62	03/94→04/02	2.500	D	M	4	8	8140.67		81316
2.5 D Combinato	62	08/94→04/02	2.500	D	M	4	8	8140.67		81316
2.5 TD	85	06/94→04/98	2.499	D	M	4	8	8140.47		81316
	80	06/94→08/98	2.499	D	M	4	8	8140.47		81316
2.5 TD 4x4	80	11/94→04/98	2.499	D	M	4	8	8140.47		81316
	85	11/94→04/98	2.499	D	M	4	8	8140.47		81316
2.5 TDI	80	03/94→04/02	2.500	D	M	4	8	8140.47R		81316
	85	03/94→04/02	2.500	D	M	4	8	8140.47		81316
2.5 TDI 4x4	85	04/97→04/02	2.500	D	M	4	8	8140.47		81316
2.5 TDI Combinato	80	08/94→04/02	2.500	D	M	4	8	8140.47R		81316
2.5 TDI Maxi	85	03/94→04/02	2.500	D	M	4	8	8140.47		81316
2.5 TDI Panorama/Combinato	80	07/94→04/02	2.500	D	M	4	8	8140.47R		81316
	85	03/94→04/02	2.500	D	M	4	8	8140.47		81316
2.8 4x4	90	05/98→09/01	2.799	D	M	4	8	8140.43		81316
2.8 D	64	02/98→04/02	2.800	D	M	4	8	8140.63		81316
2.8 D 4x4	64	08/98→04/02	2.800	D	M	4	8	8140.63		81316
2.8 JTD	94	11/00→04/02	2.798	D	M	4	8	8140.43S		81316
	93	03/01→11/01	2.799	D	M	4	8	8140.43S		81316
2.8 JTD 4x4	94	11/00→04/02	2.798	D	M	4	8	8140.43S		81316
2.8 TD 4x4	64	05/98→11/01	2.799	D	M	4	8	8140.63		81316
2.8 TDI	90	10/97→04/02	2.800	D	M	4	8	8140.43		81316
2.8 TDI 4x4	90	06/99→04/02	2.800	D	M	4	8	8140.43		81316

### DUCATO IV

2.0	81	04/02→	1.998	B	M	4	16	RFL		81642
2.0 4x4	81	05/02→07/06	1.998	B	M	4	8			81642
2.0 Bipower	81	11/02→	1.998	BF	M	4	8			81642
2.0 JTD	62	04/02→	1.997	D	M	4	8	RHV (DW10)		81713
2.3 JTD	81	04/02→	2.286	D	M	4	16	F1AE0481C		82024
2.8	90	11/03→07/06	2.799	D	M	4	8	8140.43		81316
2.8 4x4	90	11/03→07/06	2.799	D	M	4	8	8140.43		81316
2.8 JTD	94	04/02→	2.798	D	M	4	8	8140.43S		81316
	107	04/04→07/06	2.799	D	M	4	8	8140.43N		81316
2.8 JTD 4x4	94	07/02→	2.798	D	M	4	8	8140.43S		81316
2.8 JTD Power	107	05/04→	2.800	D	M	4	8	8140.43N		81316

### DUCATO V

100 Multijet 2,2 D	74	07/06→	2.198	D	M	4	16	4HV		82066
120 Multijet 2,3 D	88	07/06→	2.287	D	M	4	16	F1AE0481D		82024
	96	01/07→	2.287	D	M	4	16			82024
130 Multijet 2,3 D	96	01/07→	2.287	D	M	4	16			82024
140 Natural Power	100	04/09→	2.999	D	M	4	16			82094
140 Natural Power 3,0	100	04/09→	2.999	M	M	4	16			82094
160 Multijet Power 3,0 D	116	07/06→	2.999	D	M	4	16	F1CE0481D		82094

	kW		Cap. cm3	Fuel	Gear	No. of cyl.	No. of valves	Motor code		Short
--	----	--	----------	------	------	-------------	---------------	------------	--	-------

**FIAT**
**FIORINO II**

1.0 iE	33	11/92→04/96	999	B	M	4	8	156A2.246		81801
1.3	49	01/88→12/94	1.301	B	M	4	8	146A5.000		81434
1.4	49	05/94→05/01	1.372	B	M	4	8	146D5.000	(+)COP, M→: 9.470.269	81343
	49	05/94→05/01	1.372	B	M	4	8	146D5.000	(-)COP, M→: 9.470.269	81366
	49	05/94→05/01	1.372	B	M	4	8	146D5.000	(+)COP, →M: 9.470.268	81476
	49	05/94→05/01	1.372	B	M	4	8	146D5.000	(-)COP, →M: 9.470.268	81314
	52	11/92→10/96	1.372	B	M	4	8	146C5.000	(-)COP, →M: 9.470.268	81314
	52	11/92→10/96	1.372	B	M	4	8	146C5.000	(+)COP, M→: 9.470.269	81343
	52	11/92→10/96	1.372	B	M	4	8	146C5.000	(+)COP, →M: 9.470.268	81476
52	11/92→10/96	1.372	B	M	4	8	146C5.000	(-)COP, M→: 9.470.269	81366	
1.5 iE	55	01/88→10/92	1.498	B	M	4	8	149C1.000	(+)COP	81482
1.6	55	01/94→05/01	1.581	B	M	4	8	146C6.000	(-)COP, →M: 9.470.268	81314
	55	01/94→05/01	1.581	B	M	4	8	146C6.000	(+)COP, M→: 9.470.269	81343
	55	01/94→05/01	1.581	B	M	4	8	146C6.000	(-)COP, M→: 9.470.269	81366
	55	01/94→05/01	1.581	B	M	4	8	146C6.000	(+)COP, →M: 9.470.268	81476
1.7	44	01/88→10/99	1.697	D	M	4	8	146B2.000	(+)SS, (+)AC	81344
	44	01/88→10/99	1.697	D	M	4	8	146B2.000	(+)COP, (-)SS, (-)AC	81456
1.7 D	42	10/93→10/99	1.697	D	M	4	8	146B2.000	(+)SS, (+)AC	81344
	42	10/93→10/99	1.697	D	M	4	8	146B2.000	(+)COP, (-)SS, (-)AC	81456
	44	05/88→10/99	1.698	D	M	4	8	149B3.000	(+)SS, (+)AC	81344
	44	05/88→10/99	1.698	D	M	4	8	149B3.000	(+)COP, (-)SS, (-)AC	81456
1.7 TD	46	01/97→05/01	1.698	D	M	4	8	146D7.000		81344
1.7 TD S	46	11/96→05/00	1.697	D	M	4	8	146D7.000		81344
60 1.1	40	05/88→12/93	1.116	B	M	4	8	146A9.000		81434
60 1.7 D	42	05/88→10/96	1.697	D	M	4	8	146B2.000	(+)SS, (+)AC	81344
	42	05/88→10/96	1.697	D	M	4	8	146B2.000	(+)COP, (-)SS, (-)AC	81456
	44	05/88→05/00	1.698	D	M	4	8	149B3.000	(+)SS, (+)AC	81344
	44	05/88→05/00	1.698	D	M	4	8	149B3.000	(+)COP, (-)SS, (-)AC	81456
65 1.7 TD	46	01/97→05/01	1.698	D	M	4	8	146D7.000		81344
70 1.3	49	01/88→12/94	1.301	B	M	4	8	146A5.000		81434
70 i.e. 1.4	49	05/94→05/01	1.372	B	M	4	8	146C5.000, 146D5.000	(-)COP, →M: 9.470.268	81314
	49	05/94→05/01	1.372	B	M	4	8	146C5.000, 146D5.000	(+)COP, M→: 9.470.269	81343
	49	05/94→05/01	1.372	B	M	4	8	146C5.000, 146D5.000	(-)COP, M→: 9.470.269	81366
	49	05/94→05/01	1.372	B	M	4	8	146C5.000, 146D5.000	(+)COP, →M: 9.470.268	81476
75 i.e. 1.5	55	05/88→12/93	1.499	B	M	4	8	149C1.000	(+)COP	81482
75 i.e. 1.6	55	10/93→05/01	1.581	B	M	4	8	146C6.000, 146D6.000	(-)COP, →M: 9.470.268	81314
	55	10/93→05/01	1.581	B	M	4	8	146C6.000, 146D6.000	(+)COP, M→: 9.470.269	81343
	55	10/93→05/01	1.581	B	M	4	8	146C6.000, 146D6.000	(-)COP, M→: 9.470.269	81366
	55	10/93→05/01	1.581	B	M	4	8	146C6.000, 146D6.000	(+)COP, →M: 9.470.268	81476

**FIORINO III**

1.3 D Multijet	55	02/08→	1.248	D	M	4	16	199A2.000		81862
1.4	54	02/08→	1.360	B	M	4	16			81797

	kW		Cap. cm3	Fuel	Gear	No. of cyl.	No. of valves	Motor code		MAGNETI MARELLI Short
--	----	--	----------	------	------	-------------	---------------	------------	--	-----------------------

## FIAT

### SCUDO I

1.6	58	02/96→	1.581	B	M	4	8	220A2.000	(+)COP	81346
	58	02/96→	1.581	B	M	4	8	220A2.000	(-)COP	81368
1.9 D	51	04/98→	1.868	D	M	4	8	WJZ (DW8)		81642
	51	02/96→04/98	1.905	D	M	4	8	D9B		81642
1.9 TD	66	02/96→	1.905	D	M	4	8	DHX (XUD9TF/L)		81642
	68	02/96→	1.905	D	M	4	8	D8B		81642
1.9 TD Eco	66	02/96→	1.905	D	M	4	8	DHX (XUD9TF/L)		81642
2.0	100	05/00→	1.997	B	M	4	16	RFN	(-)COP	81799
	100	05/00→	1.997	B	M	4	16	RFN	(+)COP	82089
2.0 16V	100	06/00→	1.997	B	M	4	16	RFN	(-)COP	81799
	100	06/00→	1.997	B	M	4	16	RFN	(+)COP	82089
2.0 JTD	69	12/99→	1.997	D	M	4	8	RHX		81713
	80	12/99→	1.997	D	M	4	8	RHZ		81713

### SCUDO II

1.6 D Multijet	66	01/07→	1.560	D	M	4	16			81869
2.0 D Multijet	88	01/07→	1.997	D	M	4	16	RHK		81800
	100	01/07→	1.997	D	M	4	16	RHR		81800

### TALENTO

1.9 D	52	03/89→03/94	1.929	D	M	4	8	149B1.000		81489
2.0	55	03/89→03/94	1.971	B	M	4	8	170B		81367

## FORD

### C-MAX I

1.6	74	02/07→	1.596	B	M	4	16	HWDA		82027
1.6 TDCi	66	02/07→	1.560	D	M	4	16	HHDA		81869
	80	02/07→	1.560	D	M	4	16	G8DA		81869
1.8	92	02/07→	1.798	B	M	4	16	QQDA		81804
1.8 Flexifuel	92	02/07→	1.798	FF	M	4	16	Q7DA		81804
2.0	107	02/07→	1.999	B	M	4	16	AODA		81804
2.0 CNG	107	04/09→	1.999	M	M	4	16	SYDA		81804
2.0 LPG	107	06/08→	1.999		M	4	16	SYDA		81804
2.0 TDCi	81	02/08→	1.997	D	M	4	16	IXDA		81800
	100	02/07→	1.997	D	M	4	16	G6DA		81800

### COUGAR

2.0 16V	96	08/98→12/01	1.988	B	M	4	16	EDBA, EDBB, EDBC, EDBD		81803
2.5 ST 200	151	01/00→12/01	2.495	B	M	6	24	SGA		81845
2.5 V6 24V	125	06/00→12/01	2.495	B	M	6	24	LCBB, LCBC, LCBE		81845
	125	08/98→12/01	2.544	B	M	6	24	LCBA		81845

### ESCORT III, STATION WAGON

1.1	37	03/81→02/86	1.117	B	M	4	8	GLB, GSE		81531
	40	09/80→08/83	1.117	B	M	4	8	GLB, GMA		81531
	43	09/80→08/83	1.117	B	M	4	8	GPA		81531
1.3	51	09/80→02/86	1.296	B	M	4	8	JPA	09-1981→	81535
1.6	48	05/83→07/86	1.555	B	M	4	8	CHT1600		81535
	58	09/80→12/85	1.597	B	M	4	8	LP1, LPA	09-1981→	81535

	kW		Cap. cm3	Fuel	Gear	No. of cyl.	No. of valves	Motor code		Short
--	----	--	----------	------	------	-------------	---------------	------------	--	-------

## FORD

### ESCORT III, STATION WAGON

1.6	61	03/81→02/86	1.567	B	M	4	8			81535
	71	09/80→10/82	1.597	B	M	4	8	LUA	09-1981→	81535
1.6 D	40	02/84→02/86	1.608	D	M	4	8	LTA		81536
1.6 i	66	07/85→12/85	1.597	B	M	4	8	L4B		81535
	77	09/83→12/85	1.597	B	M	4	8	LR1, LRA		81535
1.6 L	44	09/82→02/86	1.608	D	M	4	8			81535
1.6 RS Turbo	97	11/84→12/85	1.597	B	M	4	8	LNA		81535
1.6 XR3i	77	10/82→12/85	1.597	B	M	4	8	LR1, LRA		81535
RS 1600i	85	05/82→12/85	1.597	B	M	4	8			81535

### ESCORT IV, STATION WAGON

1.1	37	10/85→09/90	1.117	B	M	4	8	GSG	→12-1988	81531
1.3	51	11/86→07/88	1.296	B	M	4	8			81650
	44	01/86→07/90	1.297	B	M	4	8	JBB, JLA, JLB		81650
	46	07/88→10/90	1.297	B	M	4	8	JBA	02-1986→, →04-1991	81650
1.4	51	10/85→10/90	1.392	B	M	4	8	FUAA		81538
	54	01/86→07/90	1.392	B	M	4	8	F6B, F6D, FUC		81538
	55	01/86→07/90	1.392	B	M	4	8	FUA	01-1986→	81538
1.4 i	54	02/86→07/90	1.392	B	M	4	8	F6B, F6D, FUC		81538
1.6	58	01/86→07/90	1.597	B	M	4	8	LP2		81538
	60	02/86→07/90	1.597	B	M	4	8			81538
	65	04/89→07/90	1.598	B	M	4	8	LUG	02-1982→, →12-1992	81538
	75	04/87→08/89	1.597	B	M	4	8	LJB		81538
	77	04/87→08/89	1.597	B	M	4	8	LRB		81538
1.6 D	40	01/86→07/90	1.608	D	M	4	8	LTA, LTC		81536
1.6 i	66	01/86→07/90	1.597	B	M	4	8	L4B		81538
	66	01/86→05/90	1.598	B	M	4	8	L4B		81538
	75	08/89→07/90	1.597	B	M	4	8	LJB	02-1982→, →12-1992	81538
1.6 Turbo RS	97	01/86→07/90	1.597	B	M	4	8	LNB	02-1982→, →12-1992	81538
1.6 XR3i	77	01/86→07/90	1.597	B	M	4	8	LR2, LRB	02-1982→, →12-1992	81538
1.8 D	44	07/88→07/90	1.753	D	M	4	8	RTA, RTB	01-1990→	81651

### ESCORT V, STATION WAGON

1.3	44	07/90→09/92	1.299	B	M	4	8	J4B, J6A	→04-1991	81650
	44	07/90→09/92	1.299	B	M	4	8	J4B, J6A	05-1991→	81653
	46	07/90→12/94	1.299	B	M	4	8	JBD	05-1991→	81653
1.4	52	07/90→12/94	1.391	B	M	4	8	F6F, F6G		81538
	52	07/90→12/92	1.392	B	M	4	8	F6F, F6G		81538
1.6	66	07/90→08/92	1.598	B	M	4	8	LUJ, LUK		81538
	77	07/90→12/92	1.598	B	M	4	8	LJF		81538
1.8 16V	77	02/92→12/92	1.796	B	M	4	16	RDA		81655
1.8 16V XR3i	77	02/92→12/92	1.796	B	M	4	16	RDA		81655
	96	02/92→12/92	1.796	B	M	4	16	RQB		81655
1.8 D	44	07/90→12/94	1.753	D	M	4	8	RTE, RTF, RTH		81651
RS 2000	110	05/91→12/92	1.998	B	M	4	16	N7A	→06-1991	81654
	110	05/91→12/92	1.998	B	M	4	16	N7A	07-1991→	81658

	<b>kW</b>		<b>Cap. cm3</b>	<b>Fuel</b>	<b>Gear</b>	<b>No. of cyl.</b>	<b>No. of valves</b>	<b>Motor code</b>		 Short
--	-----------	--	-----------------	-------------	-------------	--------------------	----------------------	-------------------	--	-----------

## FORD

### ESCORT VI, STATION WAGON

1.3	44	09/92→01/95	1.299	B	M	4	8	J4B, J6A		81653
1.4	52	09/92→01/95	1.391	B	M	4	8	F6F, F6G		81538
	52	12/92→04/94	1.392	B	M	4	8	F6F, F6G		81538
	55	08/93→01/95	1.391	B	M	4	8	F4B, FUH		81538
1.4 i	55	07/93→01/95	1.391	B	M	4	8	F4B		81538
1.6 16V XR3i	66	12/92→01/95	1.597	B	M	4	16	L1E		81655
1.6 i 16V	65	01/94→01/95	1.597	B	M	4	16	L1H		81655
	66	09/92→01/95	1.597	B	M	4	16	L1E, L1K		81655
1.8 16V XR3i	77	12/92→01/95	1.796	B	M	4	16	RDA		81655
	96	09/92→01/95	1.796	B	M	4	16	RQB		81655
1.8 D	44	09/92→01/95	1.753	D	M	4	8	RTE, RTF, RTH	01-1990→	81651
1.8 i 16V	77	09/92→01/95	1.796	B	M	4	16	RDA	01-1990→	81655
	96	02/93→01/95	1.796	B	M	4	16	RQB		81655
1.8 TD	66	02/93→01/95	1.753	D	M	4	8	RFD, RFK, RFS		81657
1.8 XR3i 16V 4x4	77	08/93→01/95	1.796	B	M	4	16	RDA		81655
	96	08/93→01/95	1.796	B	M	4	16	RQB		81655
RS 2000	110	09/92→01/95	1.998	B	M	4	16	N7A		81658
RS 2000 4x4	110	08/93→01/95	1.998	B	M	4	16	N7A		81658
RS Cosworth 4x4	162	09/92→01/95	1.994	B	M	4	16	N5F		81658

### ESCORT VII, STATION WAGON

1.3	44	01/95→02/99	1.299	B	M	4	8	J4B, J6A		81653
1.4	54	01/95→	1.391	B	M	4	8	F4B		81538
	55	01/95→02/99	1.391	B	M	4	8	F4B, FUH	01-1986→	81538
1.6 16V	66	01/95→02/99	1.597	B	M	4	16	L1E		81655
1.6 16V 4x4	66	01/95→10/98	1.597	B	M	4	16	L1E		81655
1.6 16V XR3i	65	02/95→12/96	1.597	B	M	4	16	L1H		81655
	66	02/95→09/99	1.597	B	M	4	16	L1E		81655
1.6 i 16V	65	01/95→08/95	1.597	B	M	4	16	L1H		81655
	66	01/95→02/99	1.597	B	M	4	16	L1E, L1K		81655
1.8 16V	77	01/95→08/95	1.796	B	M	4	16	RDA		81655
	85	01/95→02/99	1.796	B	M	4	16	RKC		81655
1.8 16V XR3i	77	02/95→08/98	1.796	B	M	4	16	RDA		81655
	85	10/95→08/98	1.796	B	M	4	16	RKC		81655
	96	02/95→08/00	1.796	B	M	4	16	RQB		81655
1.8 D	44	01/95→02/99	1.753	D	M	4	8	RTE, RTF, RTH		81651
1.8 TD	66	01/95→02/99	1.753	D	M	4	8	RFD, RFK		81657
1.8 Turbo D	51	12/95→06/01	1.753	D	M	4	8	RVA		81657
RS 2000	110	02/95→02/98	1.998	B	M	4	16	N7A		81658
RS 2000 4x4	110	02/95→10/98	1.998	B	M	4	16	N7A		81658
RS Cosworth 4x4	162	02/95→10/98	1.994	B	M	4	16	N5F		81658

### ESCORT VIII, STATION WAGON

1.6 16V	66	10/98→07/00	1.597	B	M	4	16	L1E		81803
1.8 TD	66	10/98→07/00	1.753	D	M	4	8	RFD, RFK		81657

	kW		Cap. cm3	Fuel	Gear	No. of cyl.	No. of valves	Motor code		Short
--	----	--	----------	------	------	-------------	---------------	------------	--	-------

## FORD

### FIESTA II, VAN

1.0	33	08/83→11/89	957	B	M	4	8	TKB		81531
	33	09/83→11/89	999	B	M	4	8			81531
1.1	36	05/86→02/89	1.117	B	M	4	8	GSH		81531
	37	09/83→02/89	1.117	B	M	4	8	GLC, GSF		81531
1.3	51	09/83→01/87	1.296	B	M	4	8	JPC	→01-1986	81535
	51	09/83→01/87	1.296	B	M	4	8	JPC	02-1986→	81538
1.4	51	09/83→01/87	1.392	B	M	4	8	FUBA		81538
	52	10/86→02/89	1.392	B	M	4	8	F6A, F6C		81538
	54	02/87→02/89	1.392	B	M	4	8	FUD	01-1987→, →01-1989	81538
	55	10/85→11/89	1.392	B	M	4	8	FUB		81538
1.6 D	40	04/84→02/89	1.608	D	M	4	8	LTB		81536
1.6 XR2	70	03/84→02/89	1.597	B	M	4	8	LUD	02-1986→	81538
	70	03/84→02/89	1.597	B	M	4	8	LUD	→01-1986	81535
	71	04/84→02/89	1.597	B	M	4	8	LUB	→01-1986	81535
	71	04/84→02/89	1.597	B	M	4	8	LUB	02-1986→	81538
1.8 D	43	03/89→12/95	1.753	D	M	4	8	RTC, RTD, RTG		81651

### FIESTA III, VAN

1.0	33	03/89→12/95	1.001	B	M	4	8	TLB	→04-1991	81650
	33	03/89→12/95	1.001	B	M	4	8	TLB	05-1991→	81653
1.1	37	03/89→12/95	1.119	B	M	4	8	G6A	→04-1991	81650
	37	03/89→12/95	1.119	B	M	4	8	G6A	05-1991→	81653
	40	03/89→12/95	1.119	B	M	4	8	GUD, GUE	→04-1991	81650
	40	03/89→12/95	1.119	B	M	4	8	GUD, GUE	05-1991→	81653
1.3	44	03/89→12/92	1.299	B	M	4	8	JBC	→04-1991	81650
	44	03/89→02/96	1.299	B	M	4	8	J6B, JBC	05-1991→	81653
1.3 Cat.	44	05/91→01/97	1.299	B	M	4	8	J6B		81653
1.4	52	03/89→12/95	1.391	B	M	4	8	F6E		81538
	54	03/89→12/95	1.391	B	M	4	8	FUG, FUJ		81538
1.4 Cat.	54	03/89→12/95	1.391	B	M	4	8	F4A		81538
1.6	65	01/89→01/94	1.597	B	M	4	8	LUH		81538
1.6 i 16V	65	01/94→12/95	1.597	B	M	4	16	L1G		81655
1.6 Turbo	96	03/90→10/92	1.598	B	M	4	8	LHA		81538
1.6 XR2i	76	03/89→03/93	1.598	B	M	4	8	LJD		81538
	81	03/89→01/94	1.597	B	M	4	8	LJC		81538
1.8 16V	77	02/92→12/95	1.796	B	M	4	16	RDB		81655
1.8 D	44	03/89→02/96	1.753	D	M	4	8	RTC, RTD, RTG		81651
1.8 TD	57	03/93→12/95	1.753	D	M	4	8	RFL		81657
1.8 XR2i 16V	96	02/92→12/95	1.796	B	M	4	16	RQC		81655

### FIESTA IV, VAN

1.25 i 16V	55	08/95→01/02	1.242	B	M	4	16	DHA, DHB, DHC, DHD, DHE, DHF, DHG		81598
1.3	44	02/96→	1.299	B	M	4	8	J4C		81653
1.3 i	37	08/95→01/02	1.299	B	M	4	8	JJA, JJC, JJE, JJJ, JJK, JJM		81716
	44	08/95→01/02	1.299	B	M	4	8	J4C, J4J, J4L, J4Q, J4R, J4T		81716



kW



Cap. cm3

Fuel

Gear

No. of cyl.

No. of valves

Motor code



MAGNETI MARELLI

Short

## FORD

### FIESTA IV, VAN

1.4 i	66	04/96→10/99	1.388	B	M	4	16	FHA		81598
1.4 i 16V	66	04/96→01/02	1.388	B	M	4	16	FHA, FHE		81598
1.6 16V Sport	76	02/00→01/02	1.596	B	M	4	16	L1T, L1V		81598
1.8 D	44	08/95→04/00	1.753	D	M	4	8	RTJ, RTK	01-1989→	81651
1.8 DI	55	04/00→01/02	1.753	D	M	4	8	RTN, RTP, RTQ		81802

### FIESTA V, VAN

1.25 16V	55	05/02→	1.242	B	M	4	16	FUJA, FUJB	05-2005→	82027
	55	05/02→	1.242	B	M	4	16	FUJA, FUJB	→04-2005	81598
	51	03/03→	1.242	B	M	4	16	M7JA, M7JB	→04-2005	81598
	51	03/03→	1.242	B	M	4	16	M7JA, M7JB	05-2005→	82027
1.3	44	11/01→	1.299	B	M	4	8	BAJA		82018
	51	11/01→	1.299	B	M	4	8	A9JA, A9JB		82018
1.4 16V	59	11/01→	1.388	B	M	4	16	FXJA, FXJB	→04-2005	81598
	59	11/01→	1.388	B	M	4	16	FXJA, FXJB	05-2005→	82027
1.4 TDCi	50	11/01→	1.399	D	M	4	8	F6JA, F6JB		81798
1.6 16V	74	11/01→	1.596	B	M	4	16	FYJA	→04-2005	81598
	74	11/01→	1.596	B	M	4	16	FYJA	05-2005→	82027
1.6 TDCi	66	11/04→	1.560	D	M	4	16	HHJA, HHJB		81869
D 1.8	44	05/98→	1.753	D	M	4	8	RTJ, RTK		81651
ST150	110	03/05→	1.999	B	M	4	16	N4JB		81804
TD 1.8	55	03/00→	1.753	D	M	4	8	RTN		81802

### FIESTA VI, VAN

1.25	44	10/08→	1.242	B	M	4	16	STJA		82027
	60	10/08→	1.242	B	M	4	16	SNJA		82027
1.4	71	10/08→	1.388	B	M	4	16	SPJA		82027
1.4 LPG	71	01/09→	1.388		M	4	16	RTJA		82027
1.4 TDCi	50	01/09→	1.399	D	M	4	8	F6JB		81798
	50	01/09→	1.399	D	M	4	16			81798
1.6	88	10/08→	1.596	B	M	4	16	HXJA		82027
1.6 TDCi	55	10/08→	1.560	D	M	4	16	HHJF		81869
	66	01/09→	1.560	D	M	4	16			81798
	66	10/08→	1.560	D	M	4	16	HHJD		81869
	70	02/10→	1.560	D	M	4	16	TZJA		81869

### FOCUS I, STATION WAGON, CABRIO

1.4 16V	55	10/98→11/04	1.388	B	M	4	16	FXDA, FXDB, FXDC, FXDD	10-1998→	81598
1.6	74	09/00→08/03	1.596	B	M	4	16			81598
1.6 16V	74	10/98→11/04	1.596	B	M	4	16	FYDA, FYDB, FYDC, FYDD	10-1998→	81598
1.6 16V Flexifuel	75	01/02→11/04	1.596	FF	M	4	16			81598
1.8	85	09/02→08/03	1.796	B	M	4	16			81803
1.8 16V	85	10/98→11/04	1.796	B	M	4	16	EYDB, EYDC, EYDD, EYDE, EYDF, EYDG, EYDI, EYDJ, EYDL		81803
1.8 BiFuel	82	02/03→01/05	1.796	B	M	4	16			81803
1.8 DI / TDDi	55	08/99→11/04	1.753	D	M	4	8	BHDA, BHDB		81802
1.8 TDCi	74	09/02→11/04	1.753	D	M	4	8	FFDA		81802
	85	03/01→11/04	1.753	D	M	4	8	F9DA, F9DB		81802
1.8 TDDi	55	08/01→03/05	1.753	D	M	4	8			81802

	kW		Cap. cm3	Fuel	Gear	No. of cyl.	No. of valves	Motor code		Short
--	----	--	----------	------	------	-------------	---------------	------------	--	-------

## FORD

### FOCUS I, STATION WAGON, CABRIO

1.8 Turbo DI / TDDi	66	10/98→11/04	1.753	D	M	4	8	C9DA, C9DB, C9DC		81802
2.0 16V	96	10/98→11/04	1.988	B	M	4	16	EDDB, EDCC, EDDD, EDDF		81803
RS	158	10/02→11/04	1.988	B	M	4	16	HMDA		81803
ST170	127	03/02→11/04	1.988	B	M	4	16	ALDA		81803

### FOCUS II, STATION WAGON, CABRIO

1.4	59	11/04→	1.388	B	M	4	16	ASDA, ASDB	→04-2005	81598
	59	11/04→	1.388	B	M	4	16	ASDA, ASDB	05-2005→	82027
1.6	74	11/04→	1.596	B	M	4	16	HWDA, HWDB	→04-2005	81598
	74	11/04→	1.596	B	M	4	16	HWDA, HWDB	05-2005→	82027
1.6 TDCi	66	11/04→	1.560	D	M	4	16	HHDA, HHDB		81869
	80	11/04→	1.560	D	M	4	16	G8DA, G8DB		81869
1.6 Ti	85	11/04→	1.596	B	M	4	16	HXDA	→04-2005	81598
	85	11/04→	1.596	B	M	4	16	HXDA	05-2005→	82027
1.8	92	03/06→	1.798	B	M	4	16			81804
1.8 Flexifuel	92	01/06→	1.798	FF	M	4	16	Q7DA		81804
1.8 Ghia FFV Flexifuel	97	12/05→	1.798	B	M	4	16			81804
1.8 Ghia Flexifuel	96	12/05→	1.798	B	M	4	16			81804
1.8 TDCi	85	11/04→	1.753	D	M	4	16	KKDA		81802
2.0	107	11/04→	1.999	B	M	4	16	AODA, AODB		81804
2.0 CNG	107	04/09→	1.999	M	M	4	16			81804
2.0 LPG	107	06/08→	1.999		M	4	16			81804
2.0 TDCi	81	02/08→	1.997	D	M	4	16	IXDA		81800
	100	11/04→	1.997	D	M	4	16	G6DA, G6DB		81800
2.5 RS	224	01/09→	2.521	B	M	5	20			82056
2.5 ST	166	10/05→	2.522	B	M	5	20	HYDA		82056

### FOCUS C-MAX

1.6	74	10/03→03/07	1.596	B	M	4	16	HWDA	→04-2005	81598
	74	10/03→03/07	1.596	B	M	4	16	HWDA	05-2005→	82027
1.6 TDCi	80	10/03→03/07	1.560	D	M	4	16	G8DA		81869
	66	02/05→03/07	1.560	D	M	4	16	HHDA, HHDB		81869
1.6 Ti	85	08/04→03/07	1.596	B	M	4	16	HXDA	→04-2005	81598
	85	08/04→03/07	1.596	B	M	4	16	HXDA	05-2005→	82027
1.8	88	10/03→03/07	1.798	B	M	4	16	CSDA, CSDB		81804
	92	04/04→03/07	1.798	B	M	4	16	Q7DA, QQDA, QQDB		81804
1.8 Flexifuel	92	01/06→03/07	1.798	FF	M	4	16	Q7DA		81804
1.8 TDCi	85	01/05→03/07	1.753	D	M	4	16	KKDA		81802
2.0	107	04/04→03/07	1.999	B	M	4	16	AODA, AODB		81804
2.0 TDCi	100	10/03→03/07	1.997	D	M	4	16	G6DD		81800

### FUSION

1.25	55	08/04→	1.242	B	M	4	16	FUJA, FUJB	→04-2005	81598
	55	08/04→	1.242	B	M	4	16	FUJA, FUJB	05-2005→	82027
1.3	44	11/02→	1.299	B	M	4	8			82018
1.4	59	08/02→	1.388	B	M	4	16	FXJA, FXJB	→04-2005	81598
	59	08/02→	1.388	B	M	4	16	FXJA, FXJB	05-2005→	82027
1.4 TDCi	50	08/02→	1.399	D	M	4	8	F6JA		81798



	kW		Cap. cm3	Fuel	Gear	No. of cyl.	No. of valves	Motor code		Short
--	----	--	----------	------	------	-------------	---------------	------------	--	-------

## FORD

### FUSION

1.6	74	08/02→	1.596	B	M	4	16	FYJA	→04-2005	81598
	74	08/02→	1.596	B	M	4	16	FYJA	05-2005→	82027
1.6 TDCi	66	11/04→	1.560	D	M	4	16	HHJA, HHJB		81869

### GALAXY I

1.8 TDCi	74	05/06→	1.753	D	M	4	8	FFWA		81802
	92	05/06→	1.753	D	M	4	16	QYWA		81802
1.9 TDI	66	03/95→05/06	1.896	D	M	4	8	1Z, AHU, ANU	(-)COP, →04-2000	81522
	66	03/95→05/06	1.896	D	M	4	8	1Z, AHU, ANU	(+)COP, CR	82080
	66	03/95→05/06	1.896	D	M	4	8	1Z, AHU, ANU	05-2000→, M: ANU	81816
	81	08/97→04/00	1.896	D	M	4	8	AFN, AVG	(-)COP, →04-2000	81522
	81	08/97→04/00	1.896	D	M	4	8	AFN, AVG	(+)COP, CR	82080
	85	04/00→05/06	1.896	D	M	4	8	AUY	M: VW19NPD	81816
	96	02/03→05/06	1.896	D	M	4	8	ASZ		81791
	110	05/05→05/06	1.896	D	M	4	8	BTB		81791
2.0	107	05/06→	1.999	B	M	4	16	AOWB		81804
2.0 Flexifuel	107	05/06→	1.999	FF	M	4	16	TBWA		81804
2.0 i	85	11/95→05/06	1.998	B	M	4	8	NSE, ZVSA		81658
2.0 SCTi	149	03/10→	1.999	B	M	4	16	TNWA		81804
2.0 TDCi	96	05/06→	1.997	D	M	4	16	AZWA		81800
	103	05/06→	1.997	D	M	4	16	QXWA		81800
	85	11/07→	1.997	D	M	4	16	TYWA		81800
2.2 TDCi	129	03/08→	2.179	D	M	4	16	Q4WA		82068
2.3	118	07/07→	2.261	B	M	4	16	SEWA		81804
2.3 16V	107	01/97→05/06	2.295	B	M	4	16	E5SA, Y5B		81658
	103	09/01→05/06	2.295	B	M	4	16	E5SB		81658
2.3 4x4	107	09/96→04/00	2.295	B	M	4	16	Y5B		81658
2.8 i V6	128	11/95→04/00	2.792	B	M	6	12	AAA, AMY		81773
2.8 i V6 4x4	128	04/96→04/00	2.792	B	M	6	12	AAA, AMY		81773
2.8 V6	150	04/00→05/06	2.792	B	M	6	24	AYL		81773

### KA I, STREET KA

1.0 i	38	07/97→09/99	999	B	M	4	8	ZH10JRB		81716
1.0 i	48	09/99→11/08	999	B	M	4	8			81716
1.3 i	37	09/96→10/02	1.299	B	M	4	8	JJB		81716
	36	06/98→11/08	1.299	B	M	4	8	JJD, JJF, JIG, JJH, JJJ		81716
	44	09/96→11/08	1.299	B	M	4	8	BAA, J4D, J4K, J4M, J4N, J4P, J4S	M: J4P, M: J4D, M: J4K, M: J4P	81716
	44	09/96→11/08	1.299	B	M	4	8	BAA, J4D, J4K, J4M, J4N, J4P, J4S	M: DU13BAYA, M: DU13BAA	82018
	51	08/02→11/08	1.299	B	M	4	8	A9A, A9B		82018
1.6	70	05/03→07/05	1.599	B	M	4	8	CDRA, CDRB		82018
1.6 i	70	07/03→11/08	1.599	B	M	4	8	CDB, CDC		82018

### KA II

1.2	51	02/09→	1.242	B	M	4	8	FP4		81369
1.3 TDCi	55	02/09→	1.248	D	M	4	16	FD4		81862

	kW		Cap. cm3	Fuel	Gear	No. of cyl.	No. of valves	Motor code		Short
--	----	--	----------	------	------	-------------	---------------	------------	--	-------

## FORD

### KUGA

2.0 TDCi	100	03/08→	1.997	D	M	4	16	G6DG		81800
2.0 TDCi AWD	100	03/08→	1.997	D	M	4	16	G6DG		81800
2.5	147	03/09→	2.522	B	M	5	20			82056
2.5 4x4	147	03/09→	2.522	B	M	5	20	HYDB		82056

### MAVERICK II

2.3 16V	110	03/04→	2.261	B	M	4	16	GZ		81804
3.0 24V	149	03/04→	2.967	B	M	6	24	AJ		82036
3.0 V6 24V	145	02/01→	2.967	B	A	6	24	AJ	→03-2004	81845
	145	02/01→	2.967	B	A	6	24	AJ	05-2003→	82036

### MONDEO I, STATION WAGON

1.6 i 16V	65	07/94→08/96	1.597	B	M	4	16	L1J		82004
	66	02/93→08/96	1.597	B	M	4	16	L1F		82004
1.8 4x4	85	02/93→08/96	1.796	B	M	4	16	RKA		82004
1.8 i 16V	82	01/94→08/96	1.796	B	M	4	16	RKB		82004
	85	02/93→08/96	1.796	B	M	4	16	RKA		82004
1.8 i 16V 4x4	85	02/93→08/96	1.796	B	M	4	16	RKA		82004
1.8 TD	65	06/93→08/96	1.753	D	M	4	8	RFM, RFN		81656
	66	10/95→08/96	1.753	D	M	4	8	RFM, RFN		81656
2.0 i 16V	97	01/93→08/96	1.988	B	M	4	16			82004
	100	02/93→08/96	1.988	B	M	4	16	NGA	02-1993→	82004
2.0 i 16V 4x4	97	12/94→08/96	1.988	B	M	4	16	NGA		82004
	100	04/93→08/96	1.988	B	M	4	16	NGA		82004
2.5 i 24V	125	07/94→08/96	2.544	B	M	6	24	SEA		81845

### MONDEO II, STATION WAGON

1.6 i	66	09/96→11/00	1.597	B	M	4	16	L1J		82004
1.6 i 16V	70	05/98→11/00	1.597	B	M	4	16	L1L, L1N, L1Q		82004
1.8 i	85	09/96→11/00	1.796	B	M	4	16	RKB, RKF, RKH, RKJ, RKK	→04-1998	82004
1.8 TD	66	09/96→11/00	1.753	D	M	4	8	RFN		81656
2.0 i	96	09/96→11/00	1.988	B	M	4	16	NGA, NGB, NGC, NGD		82004
2.5 24V	125	10/99→11/00	2.495	B	M	6	24	SEB		81845
	125	09/96→11/00	2.544	B	M	6	24	SEA		81845
2.5 ST 200	151	05/99→11/00	2.495	B	M	6	24	SGA		81845

### MONDEO III, STATION WAGON

1.8 16V	81	11/00→08/07	1.798	B	M	4	16	CGBA, CGBB		81804
	92	11/00→08/07	1.798	B	M	4	16	CHBA, CHBB		81804
1.8 SCi	96	06/03→08/07	1.798	B	M	4	16	CFBA		81804
2.0 16V	107	11/00→08/07	1.999	B	AM	4	16	CJBA, CJBB		81804
2.0 16V DI / TDDi / TDCi	66	11/00→08/07	1.998	D	M	4	16	D5BA, SDBA		81805
2.0 16V TDDi / TDCi	85	11/00→08/07	1.998	D	M	4	16	D6BA, HJBA, HJBB, HJBC		81805
2.0 TDCi	96	10/01→08/07	1.998	D	M	4	16	FMBA, N7BA		81805
	92	02/03→06/05	1.998	D	M	4	16			81805
	114	09/04→08/07	2.198	D	M	4	16	QJBA, QJBB		81805
2.5 V6 24V	125	11/00→08/07	2.495	B	AM	6	24	LCBD		82036
3.0 V6 24V	150	09/04→08/07	2.967	B	M	6	24	REBA		82036
ST220	166	04/02→08/07	2.967	B	M	6	24	MEBA		82036

	kW		Cap. cm3	Fuel	Gear	No. of cyl.	No. of valves	Motor code		MAGNETI MARELLI Short
--	----	--	----------	------	------	-------------	---------------	------------	--	-----------------------

## FORD

### MONDEO IV, STATION WAGON

1.6 Ti	81	03/07→	1.596	B	M	4	16	RHBA		82027
	92	03/07→	1.596	B	M	4	16	PNBA		82027
1.8 TDCi	74	03/07→	1.753	D	M	4	16	FFBA		81802
	92	06/07→	1.753	D	M	4	16	KHBA, QYBA		81802
2.0	107	03/07→	1.999	B	M	4	16	AOBA		81804
2.0 Flexifuel	107	03/07→	1.999	FF	M	4	16	TBBA		81804
2.0 LPG	107	07/09→	1.999		M	4	16			81804
2.0 SCTi	149	03/10→	1.976	B	M	4	16	TNBA		81804
2.0 TDCi	85	11/07→	1.997	D	M	4	16	KLBA		81800
	96	03/07→	1.997	D	M	4	16	AZBA		81800
	100	03/07→	1.997	D	M	4	16			81800
	103	03/07→	1.997	D	M	4	16	QXBB		81800
2.2 TDCi	129	03/08→	2.179	D	M	4	16	Q4BA		82068
2.3	118	07/07→	2.261	B	M	4	16	SEBA		81804
2.5	162	03/07→	2.521	B	M	5	20	HUBA		82056

### ORION III

1.3	44	07/90→12/93	1.299	B	M	4	8	J4B, J6A	→04-1991	81650
	44	07/90→12/93	1.299	B	M	4	8	J4B, J6A	05-1991→	81653
1.4	52	07/90→12/93	1.391	B	M	4	8	F6F, F6G		81538
	54	07/90→12/93	1.392	B	M	4	8	FUH		81538
1.6	66	07/90→12/92	1.598	B	M	4	8	LUJ, LUK		81538
1.6 i	77	07/90→09/92	1.598	B	M	4	8	LJF		81538
1.6 i 16V	66	07/92→12/93	1.597	B	M	4	16	L1E, L1K		81655
1.8 D	44	11/90→12/93	1.753	D	M	4	8	RTE, RTF, RTH		81651
1.8 i 16V	77	02/92→12/93	1.796	B	M	4	16	RDA		81655
	96	01/92→12/93	1.796	B	M	4	16	RQB		81655
1.8 TD	66	03/92→12/93	1.753	D	M	4	8	RFD, RFK		81657

### PUMA

1.4 16V	66	11/97→10/00	1.388	B	M	4	16	FHD, FHF		81598
1.6 16V	76	08/00→	1.596	B	M	4	16	L1W		81598
1.7 16V	92	03/97→	1.679	B	M	4	16	MHA, MHB		81598
ST 160	118	06/99→	1.679	B	M	4	16			81598

### SCORPIO I, STATION WAGON

1.8	66	04/85→02/92	1.796	B	M	4	8	REC	10-1984→, →12-1990, VA	81602
2.0	77	04/85→08/89	1.993	B	M	4	8	N8D, NEL	04-1985→, →12-1989	81602
	77	03/90→08/92	1.998	B	M	4	8	N8B	02-1991→	81658
	77	03/90→08/92	1.998	B	M	4	8	N8B	→01-1991	81654
	80	11/88→03/93	1.998	B	M	4	8	N8A, N8B	→01-1991	81654
	80	11/88→03/93	1.998	B	M	4	8	N8A, N8B	02-1991→	81658
2.0 i	74	10/85→12/90	1.993	B	M	4	8	NRC		81602
	85	04/85→02/92	1.993	B	M	4	8	NRA, NRI	→12-1988	81602
	85	04/85→09/94	1.993	B	M	4	8	NRA, NRI	02-1991→	81658
	85	04/85→02/92	1.993	B	M	4	8	NRA, NRI	01-1989→, →01-1991	81654
	88	05/89→09/94	1.998	B	M	4	8	N9D	→01-1991	81654
	88	05/89→09/94	1.998	B	M	4	8	N9D	02-1991→	81658

	kW		Cap. cm3	Fuel	Gear	No. of cyl.	No. of valves	Motor code		Short
--	----	--	----------	------	------	-------------	---------------	------------	--	-------

## FORD

### SCORPIO I, STATION WAGON

2.0 i	92	05/89→02/92	1.998	B	M	4	8		02-1991→	81658
	92	05/89→02/92	1.998	B	M	4	8		→01-1991	81654
	85	09/91→09/94	1.998	B	M	4	8	N9F		81658
2.5 D	51	12/85→12/94	2.498	D	M	4	8	STR		81603
2.5 TD	68	06/88→07/93	2.498	D	M	4	8	SFA, SFB	09-1988→, →08-1993	81659
	85	08/93→09/94	2.500	D	M	4	8	SCB	→09-1993	81302

### SCORPIO II, STATION WAGON

2.0 i	85	10/94→08/98	1.998	B	M	4	8	NSD		81658
2.0 i 16V	100	10/94→08/98	1.998	B	M	4	16	N3A		81658
2.3 i 16V	108	06/96→08/98	2.295	B	M	4	16	Y5A		81654
2.5 TD	85	10/94→08/98	2.500	D	M	4	8	SCC	06-1996→, →09-1996	81302
	92	09/96→08/98	2.500	D	M	4	8	VM	(-)COP	81362

### SIERRA II, STATION WAGON

1.6	55	01/87→02/93	1.597	B	M	4	8	LSE	(+)SS	81602
	55	01/87→02/93	1.597	B	M	4	8	LSE		81532
	53	01/88→02/93	1.597	B	M	4	8	LSF	(-)SS	81532
	53	01/88→02/93	1.597	B	M	4	8	LSF	(+)SS, VA	81602
1.6 i	59	10/89→02/93	1.597	B	M	4	8	L6B		81532
	59	10/89→02/93	1.597	B	M	4	8	L6B	(+)SS	81602
	59	10/89→02/93	1.598	B	M	4	8	L6B		81532
	59	10/89→02/93	1.598	B	M	4	8	L6B	(+)SS	81602
1.8	59	10/87→05/88	1.796	B	M	4	8	RED, REF		81532
	59	10/87→05/88	1.796	B	M	4	8	RED, REF	(+)SS	81602
	66	01/87→05/88	1.796	B	M	4	8	R2A, RED		81532
	66	01/87→05/88	1.796	B	M	4	8	R2A, RED	(+)SS	81602
2.0	77	01/87→02/93	1.993	B	M	4	8	N8C, NES		81532
	77	01/87→02/93	1.993	B	M	4	8	N8C, NES	(+)SS	81602
	77	01/87→02/93	1.993	B	M	4	8	N8C, NES	→01-1991	81654
	77	01/87→02/93	1.993	B	M	4	8	N8C, NES	02-1991→	81658
	80	07/89→12/92	1.998	B	M	4	8	N8A		81532
	80	07/89→12/92	1.998	B	M	4	8	N8A	(+)SS	81602
2.0 16V Cosworth 4x4	162	01/90→02/93	1.993	B	M	4	16	N5D		81602
2.0 16V Cosworth 4x4 Cat.	162	01/90→02/93	1.993	B	M	4	16	N5C		81602
2.0 4x4	88	01/90→02/93	1.998	B	M	4	8	N9C		81532
	88	01/90→02/93	1.998	B	M	4	8	N9C	(+)SS	81602
	88	02/90→02/93	1.998	B	M	4	8	N9C	02-1991→	81658
	88	02/90→02/93	1.998	B	M	4	8	N9C	→01-1991	81654
	92	05/89→02/93	1.998	B	M	4	8	N9C	→01-1991	81654
	92	05/89→02/93	1.998	B	M	4	8	N9C	02-1991→	81658
2.0 i	74	01/87→02/93	1.993	B	M	4	8	NE5, NEJ		81532
	74	01/87→02/93	1.993	B	M	4	8	NE5, NEJ	(+)SS	81602
	85	01/87→02/93	1.993	B	M	4	8	N4A, N4I	(+)SS	81602
	85	01/87→02/93	1.993	B	M	4	8	N4A, N4I	→01-1991	81654
	85	01/87→02/93	1.993	B	M	4	8	N4A, N4I	02-1991→	81658
	80	06/89→02/93	1.998	B	M	4	8	N8A		81532
80	06/89→02/93	1.998	B	M	4	8	N8A	(+)SS	81602	

	<b>kW</b>		<b>Cap. cm3</b>	<b>Fuel</b>	<b>Gear</b>	<b>No. of cyl.</b>	<b>No. of valves</b>	<b>Motor code</b>		 Short
--	-----------	--	-----------------	-------------	-------------	--------------------	----------------------	-------------------	--	-----------

## FORD

### SIERRA II, STATION WAGON

2.0 i	88	05/89→02/93	1.998	B	M	4	8	N9C	→01-1991	81654
	88	05/89→02/93	1.998	B	M	4	8	N9C	02-1991→	81658
	92	05/89→02/93	1.998	B	M	4	8	N9B, N9C	→01-1991	81654
	92	05/89→02/93	1.998	B	M	4	8	N9B, N9C	01-1991→, 02-1991→	81658
2.0 i Cat.	74	01/87→02/93	1.993	B	M	4	8	N4B		81532
	74	01/87→02/93	1.993	B	M	4	8	N4B	(+)SS	81602
2.0 i DOHC	85	12/91→02/93	1.998	B	M	4	8	N9E		81658
2.0 RS Cosworth	150	11/87→01/90	1.993	B	M	4	16	N5B		81602
2.3 D	49	01/87→02/93	2.304	D	M	4	8	YTR, YTT	→07-1988	81603
	49	01/87→02/93	2.304	D	M	4	8	YTR, YTT	08-1988→	81659

### S-MAX

1.8 TDCi	92	05/06→	1.753	D	M	4	16	QYWA		81802
	74	01/07→	1.753	D	M	4	8	FFWA		81802
2.0	107	05/06→	1.999	B	M	4	16	AOWA		81804
2.0 Flexifuel	107	05/06→	1.999	FF	M	4	16	TBWA		81804
2.0 SCTi	149	03/10→	1.999	B	M	4	16	TNWA		81804
2.0 TDCi	96	05/06→	1.997	D	M	4	16	AZWA		81800
	100	05/06→	1.997	D	M	4	16			81800
	103	05/06→	1.997	D	M	4	16	QXWA		81800
	85	11/07→	1.997	D	M	4	16	KLWA		81800
2.2 TDCi	129	03/08→	2.179	D	M	4	16	Q4WA		82068
2.3	118	07/07→	2.261	B	M	4	16	SEWA		81804
2.5 ST	162	05/06→	2.521	B	M	5	20	HUWA		82056

### TOURNEO CONNECT

1.8 Di	55	06/02→	1.753	D	M	4	8	BHPA		81802
1.8 TDCi	81	08/06→	1.753	D	M	4	8	RWPA		81802
1.8 Turbo Di	66	06/02→	1.753	D	M	4	8	HCPA		81802
1.8 16V	85	06/02→	1.796	B	M	4	16	EYPA, EYPC		81803

## FORD

### TRANSIT III

1.6	48	11/77→10/86	1.593	B	M	4	8	4RB, B		81532
	48	11/77→10/86	1.593	B	M	4	8	4RB, B	VA	81602
	62	01/78→10/86	1.598	B	M	4	8			81532
	62	01/78→10/86	1.598	B	M	4	8		VA	81602
2.0	43	11/77→07/82	1.993	B	M	4	8	4RC	01-1978→, →03-1991	81532
	43	11/77→07/82	1.993	B	M	4	8	4RC	VA	81602
	55	11/77→10/86	1.993	B	M	4	8	4RC		81532
	57	11/77→10/86	1.993	B	M	4	8	4RC		81532
	55	11/77→10/86	1.993	B	M	4	8	4RC	VA	81602
	57	11/77→10/86	1.993	B	M	4	8	4RC	VA	81602
2.4 D	46	11/77→10/86	2.358	D	M	4	8	4AA	VA	81534
2.5 D	50	10/83→10/86	2.496	D	M	4	8	4AB	VA	81558
	50	10/83→10/86	2.496	D	M	4	8	4AB		81559

	kW		Cap. cm3	Fuel	Gear	No. of cyl.	No. of valves	Motor code		Short
--	----	--	----------	------	------	-------------	---------------	------------	--	-------

## FORD

### TRANSIT IV

1.6	62	10/85→07/87	1.598	B	M	4	8			81532
	46	09/85→09/92	1.593	B	M	4	8	LAT		81532
	46	09/85→09/92	1.593	B	M	4	8	LAT	VA	81602
2.0	60	10/85→03/91	1.993	B	M	4	8	N6TS		81532
	60	10/85→03/91	1.993	B	M	4	8	N6TS	VA	81602
	57	11/85→09/92	1.993	B	M	4	8	N6T		81532
	57	11/85→09/92	1.993	B	M	4	8	N6T	VA	81602
	57	09/85→09/92	1.994	B	M	4	8	NAT, NAV		81532
	57	09/85→09/92	1.994	B	M	4	8	NAT, NAV	VA	81602
2.0 L	56	10/85→03/91	1.993	B	M	4	8	NAW, NAX		81532
	56	10/85→03/91	1.993	B	M	4	8	NAW, NAX	VA	81602
2.5 D	50	12/85→09/91	2.496	D	M	4	8	4AB		81559
	52	09/88→09/92	2.496	D	M	4	8	4BA, 4CA		81559
2.5 DI	52	09/88→09/92	2.496	D	M	4	8	4BA, 4CA		81559

### TRANSIT V

2.0	66	09/91→09/94	1.993	B	M	4	8	NBA		81602
	72	09/91→08/94	1.994	B	M	4	8	NCA		81602
2.0 i	72	09/91→07/94	1.994	B	M	4	8	NCA		81602
2.5 DI	51	05/91→08/94	2.496	D	M	4	8	4BC, 4CC, 4FA		81559
	59	05/91→08/94	2.496	D	M	4	8	4DA		81559
	63	10/92→06/94	2.496	D	M	4	8	4GA		81559
2.5 TD	74	05/91→08/94	2.496	D	M	4	8	4EA		81559
	63	10/92→08/94	2.496	D	M	4	8	4GA, 4GB, 4GC		81559

### TRANSIT VI

2.0	84	06/94→03/00	1.998	B	M	4	8	NSF, NSG		81602
2.0 CNG	84	06/94→03/00	1.998	BF	M	4	8	NSH		81602
2.5 DI	51	06/94→03/00	2.496	D	M	4	8	4FA, 4FB, 4FC, 4FD		81559
	56	06/94→03/00	2.496	D	M	4	8	4HB, 4HC		81559
	85	08/97→03/00	2.496	D	M	4	8	4ED		81559
2.5 TD	55	08/94→06/00	2.496	D	M	4	8	4HA, 4HD		81559
	63	06/94→03/00	2.496	D	M	4	8	4GA, 4GB, 4GC, 4GD, 4GE, 4GF		81559
	74	07/94→03/00	2.496	D	M	4	8	4EB, 4EC		81559
2.5 TDI	74	06/94→03/00	2.496	D	M	4	8	4EB, 4EC		81559

### TRANSIT VII

2.0 DI	55	08/00→05/06	1.998	D	M	4	16	D3FA		81805
	63	08/00→05/06	1.998	D	M	4	16	F3FA		81805
	74	08/00→05/06	1.998	D	M	4	8	ABFA		81805
2.0 TDCi	92	08/02→05/06	1.998	D	M	4	16	F1FA		81805
2.3	107	08/00→03/06	2.295	B	M	4	16	E5FA		81654
	105	03/01→03/06	2.295	B	M	4	16	E5FC		81654
2.3 16V	107	08/00→05/06	2.295	B	M	4	16	E5FA		81654
2.4	66	10/00→03/06	2.402	D	M	4	16	D2FE		82057
2.4 DI	55	01/00→05/06	2.402	D	M	4	16	F4FA		82057
	66	01/00→05/06	2.402	D	M	4	16	D2FA, D2FB, D2FE		82057
	88	01/00→05/06	2.402	D	M	4	8	D4FA		82057
	88	01/00→05/06	2.402	D	M	4	16	D4FA		82057

	kW		Cap. cm <sup>3</sup>	Fuel	Gear	No. of cyl.	No. of valves	Motor code		MAGNETI MARELLI Short
--	----	--	----------------------	------	------	-------------	---------------	------------	--	-----------------------

## FORD

### TRANSIT VII

2.4 TD	55	08/00→08/03	2.402	D	M	4	16	F4FA		81805
	55	08/00→08/03	2.402	D	M	4	16	F4FA		82057
2.4 TD 4 ruote motrici	55	08/00→08/03	2.402	D	M	4	16	F4FA		82057
2.4 TDCi	101	03/04→05/06	2.402	D	M	4	16	H9FA		82057
2.4 TDDi	88	08/00→08/03	2.402	D	M	4	16	D4FA		82057
	66	10/01→03/06	2.402	D	M	4	16	D2FE		82057
2.4 TDE	92	07/01→05/06	2.402	D	M	4	16	DOFA		82057
	85	03/04→05/06	2.402	D	M	4	16	FXFA		82057

### TRANSIT VIII

2.2 TDCi	63	07/06→	2.198	D	M	4	16	P8FA		82066
	81	07/06→	2.198	D	M	4	16	QVFA		82066
	96	07/06→	2.198	D	M	4	16	QWFA		82066
	103	10/07→	2.198	D	M	4	16	PGFA		82066
	85	10/08→	2.198	D	M	4	16	SRFA		82066
2.3 16V	107	07/06→	2.295	B	M	4	16	GZFA		81654
2.4 TDCi	74	07/06→	2.402	D	M	4	16	PHFA		82057
	85	07/06→	2.402	D	M	4	16	JXFA		82057
	103	07/06→	2.402	D	M	4	16	H9FB, H9FD		82057
2.4 TDCi 4 ruote motrici	103	11/06→	2.402	D	M	4	16	H9FB		82057

### TRANSIT CONNECT

1.8 Di	55	06/02→	1.753	D	M	4	8	BHPA		81802
1.8 TDCi	66	06/02→	1.753	D	M	4	8	HCPA		81802
1.8 TDCi DPF	81	08/06→	1.753	D	M	4	8	RWPA		81802
1.8 16V	85	06/02→	1.796	B	M	4	16	EYPA, EYPC		81803

### TRANSIT TOURNEO I

2.0	84	11/94→12/00	1.998	B	M	4	8	NSH		81602
2.4 D	50	10/83→09/85	2.496	D	M	4	8			81559
	55	08/94→06/00	2.496	D	M	4	8	4HA		81559
2.5 DI	51	11/94→12/00	2.496	D	M	4	8	4FA, 4FB, 4FC, 4FD		81559
	56	11/94→12/00	2.496	D	M	4	8	4HA, 4HB, 4HC		81559
2.5 TD	63	11/94→12/00	2.496	D	M	4	8	4GA, 4GB, 4GC		81559
	74	04/98→12/00	2.496	D	M	4	8	4EB, 4EC		81559

### TRANSIT TOURNEO II

2.2 TDCi	81	07/06→	2.198	D	M	4	16	QVFA		82066
	96	07/06→	2.198	D	M	4	16	QWFA		82066
	103	10/07→	2.198	D	M	4	16	PGFA		82066
	85	10/08→	2.198	D	M	4	16	SRFA		82066

## HONDA

### ACCORD IV, AERODECK, COUPÉ

2.0 16V	66	01/90→03/93	1.997	B	M	4	16	F20A6		81708
	81	01/90→03/93	1.997	B	M	4	16	F20A2		81708
2.0 i 16V	98	01/90→12/93	1.997	B	M	4	16	F20A4, F20A7, F20A8, F20Z3		81708
2.2 i 16V	108	01/91→12/93	2.156	B	M	4	16	F22A8		81708
	110	01/90→12/93	2.156	B	M	4	16	F22A3, F22A7		81708
2.2 i 16V Automatic	108	01/90→03/93	2.156	B	M	4	16	F22A3		81708



kW



Cap. cm3

Fuel

Gear

No. of cyl.

No. of valves

Motor code



MAGNETI MARELLI  
Short

## HONDA

### ACCORD V, AERODECK, COUPÉ

2.0	100	09/93→12/97	1.997	B	M	4	16	F20B3		81708
2.0 i	85	03/93→01/96	1.997	B	M	4	16	F20Z2		81708
2.0 i LS 16V	100	09/93→02/98	1.997	B	M	4	16	F20B3		81708
2.0 i S	96	03/93→01/96	1.997	B	M	4	16	F20Z1		81708
2.2 i ES	110	09/93→02/98	2.156	B	M	4	16	F22B5		81708
2.3 i SR	116	03/93→01/96	2.259	B	M	4	16	H23A3		81709

### ACCORD VI, AERODECK, COUPÉ

1.9 i	85	02/96→10/98	1.850	B	M	4	16	F18A3		81708
2.0 i LS	96	02/96→10/98	1.997	B	M	4	16	F20Z1		81708
2.0 TDi	77	04/96→10/98	1.994	D	M	4	8	20T2N		81707
2.2 i VTEC	110	02/96→10/98	2.156	B	M	4	16	F22Z2		81708

### ACCORD VII, AERODECK, COUPÉ

1.6	65	10/98→12/02	1.598	B	M	4	12	A16A5		81838
1.6 i	85	10/98→12/02	1.590	B	M	4	16	D16B6		81838
1.6 LS	79	10/98→12/02	1.590	B	M	4	16	D16B7		81838
2.0	108	12/99→12/02	1.997	B	M	4	16	F20B6		81708
2.0 i	108	10/98→01/01	1.997	B	M	4	16	F20B6		81708
2.0 i 16V	108	02/98→06/03	1.997	B	M	4	16	F20B5, F20B7		81708
2.0 TDi	77	12/99→10/00	1.994	D	M	4	8	20T2N		81707
2.0 Turbo DI	77	02/99→12/02	1.994	D	M	4	8	20T2N		81707
2.3	113	11/00→06/03	2.254	B	M	4	16	F23Z5		81708
2.3 16 V	118	02/98→	2.254	B	M	4	16	F23A7		81708
2.3 VTi	113	02/98→10/02	2.254	B	M	4	16	F23A3		81708

### ACCORD VIII, AERODECK, COUPÉ

2.0	114	04/03→	1.998	B	M	4	16	K20A		81708
	114	02/03→	1.998	B	AM	4	16	K20A		81708
2.0 4 ruote motrici	114	02/03→	1.998	B	AM	4	16	K20A		81708
2.2 i-CTDi	103	01/04→	2.204	D	M	4	16	N22A1		82093

### CIVIC II, HATCHBACK, SHUTTLE

1.2	40	01/84→10/87	1.187	B	M	4	8	D12B1, ZA2		81611
1.5	63	10/83→10/87	1.488	B	M	4	8	EW2		81611
1.5 4WD	63	01/85→10/87	1.488	B	M	4	8	EW2		81611
1.5 GL	63	10/83→10/87	1.488	B	M	4	8	EW2		81611
1.5 GT	74	01/85→10/87	1.488	B	M	4	12	EW3		81611
1.5 GTI	66	03/86→10/87	1.488	B	M	4	8	EW4		81611

### CIVIC III, HATCHBACK, SHUTTLE

1.3	55	10/87→12/89	1.343	B	M	4	16	D13B1		81613
1.3 16 V	55	09/89→09/91	1.343	B	M	4	16	D13B2		81611
1.4 i 16V	66	01/88→12/92	1.396	B	M	4	16	D14A1		81613
1.4 L	66	10/87→12/89	1.396	B	M	4	8	D14A1		81613
	66	10/87→12/89	1.396	B	M	4	16	D14A1		81613
1.5	60	01/88→12/89	1.493	B	M	4	16	D15B1		81613
1.5 i 16V	66	10/87→09/91	1.493	B	M	4	16	D15B2		81613
	69	10/87→11/91	1.493	B	M	4	16	D15B2		81613
1.6	91	01/88→12/89	1.590	B	M	4	16	D16Z5		81613





kW



Cap. cm3

Fuel

Gear

No. of cyl.

No. of valves

Motor code



MAGNETI MARELLI

Short

## HONDA

### CIVIC III, HATCHBACK, SHUTTLE

1.6 4x4	85	01/88→12/92	1.590	B	M	4	16	D16A, D16A7		81613
	91	01/89→12/89	1.590	B	M	4	16	D16Z5		81613
	110	01/88→12/91	1.590	B	M	4	16			81613
1.6 i 16V	80	10/87→09/91	1.590	B	M	4	16	D16A6		81613
	81	10/87→09/91	1.590	B	M	4	16	D16Z2		81613
	96	09/87→09/91	1.590	B	M	4	16	D16A7, D16A9		81613
1.6 i 16V 4WD	80	01/88→12/89	1.590	B	M	4	16	D16A6		81613
	81	01/88→02/95	1.590	B	M	4	16	D16A6		81613
1.6 i 16V 4x4	80	10/89→09/91	1.590	B	M	4	16	D16A6		81613
1.6 i 16V Vtec	110	10/89→09/91	1.595	B	M	4	16	B16A1		81613

### CIVIC IV, HATCHBACK, SHUTTLE

1.3 16V	55	10/91→11/95	1.343	B	M	4	16	D13B2		81613
1.4 16V	55	01/97→02/01	1.396	B	M	4	16	D14A7		81838
	66	01/97→02/01	1.396	B	M	4	16	D14A8		81838
1.4 i	55	09/95→01/97	1.396	B	M	4	16	D14A5		81613
	66	09/94→01/97	1.396	B	M	4	16	D14A2		81613
1.5	61	01/92→12/92	1.493	B	M	4	16	D15B2		81613
1.5 16V	84	01/97→02/01	1.493	B	M	4	16	D15Z8		81838
1.5 i 16V	66	10/91→11/95	1.493	B	M	4	16	D15B2		81613
	69	10/91→11/95	1.493	B	M	4	16	D15B2, D15Z1		81613
1.5 i LSi	74	01/94→11/95	1.493	B	M	4	16	D15B7		81613
1.5 i Vtec-E	66	09/94→01/97	1.493	B	M	4	16	D15Z3		81613
1.6	92	11/98→10/00	1.590	B	M	4	16	D16W4		81838
1.6 16V	85	01/97→02/01	1.590	B	M	4	16	D16B2		81838
1.6 16V Vtec	92	10/91→11/95	1.590	B	M	4	16	D16Z6		81613
1.6 4x4	92	01/92→10/95	1.590	B	M	4	16	D16Z7		81613
1.6 EX	88	08/93→10/95	1.590	B	M	4	16	D16A7		81613
1.6 i	77	01/94→11/95	1.590	B	M	4	16	D16Y7		81613
	83	09/94→01/97	1.590	B	M	4	16	D16Y3		81613
1.6 i Vtec	92	01/94→03/96	1.590	B	M	4	16	D16Y6, D16Z9		81613
	93	09/94→01/97	1.590	B	M	4	16	D16Y2		81613
	118	01/94→11/95	1.595	B	M	4	16	B16A2		81839
1.6 VTi	118	10/91→02/01	1.595	B	M	4	16	B16A2		81839
1.6 VTi 16V	118	10/91→11/95	1.595	B	M	4	16	B16A2		81839
1.8 16V	124	01/97→02/01	1.797	B	M	4	16	B18C4		81839
2.0 i TD	63	01/97→02/01	1.994	D	M	4	8	20T2R		81707

### CIVIC V, AERODECK, HATCHBACK, SHUTTLE

1.4	55	11/95→10/98	1.396	B	M	4	16	D14A4		81613
1.4 16V	55	04/98→02/01	1.396	B	M	4	16	D14A7	M: SOHC	81838
	66	04/98→02/01	1.396	B	M	4	16	D14A8	M: SOHC	81838
1.4 i	55	11/95→02/01	1.396	B	M	4	16	D14A3		81838
	66	11/95→02/01	1.396	B	M	4	16	D14A4		81613
1.4 i S	66	11/95→02/01	1.396	B	M	4	16	D14A4		81613
1.5 16V	84	04/98→02/01	1.493	B	M	4	16	D15Z8		81838
1.5 i	84	11/95→02/01	1.493	B	M	4	16	D15Z6		81838
1.6	92	11/98→10/00	1.590	B	M	4	16	D16W4		81838



kW



Cap. cm3

Fuel

Gear

No. of cyl.

No. of valves

Motor code



MAGNETI MARELLI  
Short

## HONDA

### CIVIC V, AERODECK, HATCHBACK, SHUTTLE

1.6 16V	85	04/98→02/01	1.590	B	M	4	16	D16B2		81838
1.6 i	77	03/96→03/00	1.590	B	M	4	16	D16Y7	M: SOHC	81838
	84	11/95→02/01	1.590	B	M	4	16	D16Y5		81838
1.6 i Vtec	92	11/95→02/01	1.590	B	M	4	16	D16Y6, D16Y8		81838
	118	04/99→12/00	1.595	B	M	4	16	B16A2		81839
1.6 VTi	118	11/95→02/01	1.595	B	M	4	16	B16A2		81839
1.8 16V	124	04/98→02/01	1.797	B	M	4	16	B18C4		81839
2.0 iD	77	04/98→02/01	1.994	D	M	4	8	20T2N		81707

### CIVIC VI, AERODECK, HATCHBACK, SHUTTLE

1.4	66	02/01→09/05	1.396	B	M	4	16	D14Z5		82039
1.4 i	55	02/01→09/05	1.396	B	M	4	8			81838
1.4 iS	66	02/01→09/05	1.396	B	AM	4	16	D14Z6		82039
1.6	81	02/01→09/05	1.590	B	M	4	16	D16V1		82039
	84	09/05→09/05	1.586	B	M	4	16	R16A1		82039
1.6 i	81	02/01→12/05	1.590	B	AM	4	16	D16V1		82039
1.7	85	02/01→09/05	1.668	B	M	4	16	D17A6		82039
1.7 i	88	05/01→12/05	1.668	B	M	4	16	D17A8		82039
1.7 i VTEC	92	05/01→12/05	1.668	B	M	4	16	D17A5		82039
2.0 i Sport	118	01/04→09/05	1.998	B	M	4	16	K20A3		82043

### CIVIC VII, HATCHBACK

1.4	61	01/06→	1.339	B	M	4	8	L13A7		82045
2.2 CTDi	103	01/06→	2.204	D	M	4	16	N22A2		82093

### CONCERTO

1.4	61	10/89→10/92	1.396	B	M	4	16	D14A1		81613
	66	08/89→10/91	1.396	B	M	4	16	D14A1, D14A8		81613
1.5 i 16V	66	08/89→05/95	1.493	B	M	4	16	D15B2		81613
1.6	96	10/89→10/92	1.590	B	M	4	16	D16A9		81613
1.6 16V	78	08/89→03/95	1.590	B	M	4	16	D16Z2		81613
1.6 i 16V	82	08/89→03/95	1.590	B	M	4	16	D16Z2		81613
	90	08/89→03/95	1.590	B	M	4	16	D16A8		81613
1.8 TD	58	08/94→10/96	1.769	D	M	4	8	XUD7T		81642
	65	08/94→10/96	1.769	D	M	4	8	XUD7T		81642

### CR-V II

2.0	110	07/02→09/06	1.998	B	M	4	16	K20A4		82043
2.2 CTDi	103	02/05→09/06	2.204	D	M	4	16	N22A2		82093

### CR-V III

2.2 i-CTDi	103	01/07→	2.204	D	M	4	16	N22A2		82093
------------	-----	--------	-------	---	---	---	----	-------	--	-------

### CRX I

1.3	52	10/83→10/87	1.342	B	M	4	12	EV2		81611
1.5 i	74	10/83→11/86	1.488	B	M	4	12	EW3		81611

### CRX II

1.4 GL	66	01/90→12/91	1.396	B	M	4	16	D14A1		81613
1.6 i 16V	79	10/87→05/88	1.590	B	M	4	16	D16A, D16A6		81613
	96	10/87→12/89	1.590	B	M	4	16	D16A9		81613
	91	10/87→02/92	1.590	B	M	4	16	D16Z5		81613
1.6 i 16V Vtec	110	10/89→02/92	1.595	B	M	4	16	B16A1		81613

	kW		Cap. cm3	Fuel	Gear	No. of cyl.	No. of valves	Motor code		MAGNETI MARELLI Short
--	----	--	----------	------	------	-------------	---------------	------------	--	-----------------------

## HONDA

### CRX III

1.6 ESi	92	03/92→12/98	1.590	B	M	4	16	D16Z6		81613
1.6 i VTi	118	03/92→12/98	1.595	B	M	4	16	B16A2		81613

### FR-V

1.7	92	02/05→	1.668	B	M	4	16	D17A2		82039
2.0	110	02/05→	1.998	B	M	4	16	K20A9		82043
2.2 i CTDi	103	07/05→	2.204	D	M	4	16	N22A1		82093

### HR-V

1.6 16V	77	03/99→	1.590	B	M	4	16	D16W1		81838
1.6 16V 4WD	77	03/99→	1.590	B	M	4	16	D16W1		81838
	91	10/99→	1.590	B	M	4	16	D16W5		81838

### INTEGRA I

1.5	63	10/85→08/89	1.488	B	M	4	8	D15A1		81613
-----	----	-------------	-------	---	---	---	---	-------	--	-------

### INTEGRA II

1.8 Type-R	140	11/97→10/01	1.797	B	M	4	16	B18C6		81839
------------	-----	-------------	-------	---	---	---	----	-------	--	-------

### INTEGRA III

2.0	118	02/02→	1.998	B	M	4	16	K20A3		82043
2.0 16V Type-R	162	02/02→	1.998	B	M	4	16			82043

### JAZZ II

1.2	57	03/02→	1.243	B	M	4	8	L12A1		82045
1.4	61	03/02→07/08	1.339	B	M	4	8	L13A1		82045
	65	04/05→	1.339	B	M	4	8	L13A5		82045

### JAZZ III

1.4	66	07/08→	1.198	B	M	4	16	L12B1		82045
	73	07/08→	1.339	B	M	4	8	L13Z1		82045

### PRELUDE IV

2.0 i 16V	98	02/92→09/96	1.997	B	M	4	16	F20A4		81708
2.2 i 16V Vtec	136	02/93→09/96	2.157	B	M	4	16	H22A2		81708
2.3 i 16V	118	02/92→09/96	2.259	B	M	4	16	H23A2		81709

### PRELUDE V

2.0 16V	98	10/96→10/00	1.997	B	M	4	16	F20A4		81708
2.2 16V	136	10/96→10/00	2.157	B	M	4	16	H22A5		81708
	147	10/96→10/00	2.157	B	M	4	16	H22A5		81708

### SHUTTLE

2.2 16V	110	10/94→02/98	2.156	B	M	4	16	F22B8		81708
2.2 4x4	102	06/94→09/97	2.156	B	M	4	16			81708
2.3 16V	110	10/97→06/02	2.254	B	M	4	16	F23A7		81708
2.3 16V 4x4	110	10/97→06/02	2.254	B	M	4	16	F23A		81708

### STREAM I

1.7 16V	92	05/01→	1.668	B	M	4	16	D17A2		82039
2.0 16V	115	05/01→	1.998	B	M	4	16	K20A		82039



kW



Cap. cm3

Fuel

Gear

No. of cyl.

No. of valves

Motor code



MAGNETI MARELLI  
Short

## HYUNDAI

### ACCENT II

1.3	40	09/95→05/98	1.341	B	M	4	12		82020
	44	10/94→01/00	1.341	B	M	4	12	G4EH	81784
	55	10/94→01/00	1.341	B	M	4	12	G4EH	81784
1.3 i 12V	62	10/94→01/00	1.341	B	M	4	12	G4EH	81784
1.5 i 12V	65	10/94→01/00	1.495	B	M	4	12	G4EK	81784
1.5 i 16V	73	10/95→01/00	1.495	B	M	4	16	G4ER	82020

### ACCENT III

1.3	55	01/00→	1.341	B	M	4	12	G4E-A	81784
	61	01/00→	1.341	B	M	4	12		81784
	62	08/02→	1.341	B	M	4	12		81784
	63	01/00→	1.341	B	A	4	12	G4E-A	81784
1.5	66	01/00→	1.495	B	M	4	12	G4EB	82020
	75	09/00→	1.495	B	AM	4	16	G4EC-G	82020
	75	09/99→10/02	1.495	B	M	4	16		82020
1.6	77	12/02→	1.599	B	M	4	16	G4ED-G	82020
1.5 CRDi	60	01/02→	1.493	D	M	3	12	D3-EA	82085

### ACCENT IV

1.4 GL	71	11/05→	1.399	B	M	4	16	G4EE	82020
1.6 GLS	82	11/05→	1.599	B	M	4	16	G4ED	82020

### ATOS, ATOS PRIME

0.8	38	04/99→07/03	798	B	M	3	6		81837
1.0 i	40	02/98→03/02	999	B	AM	4	12	G4HC	81837
	43	03/01→	999	B	M	4	12	G4HC-E	81837
1.1	43	06/03→05/05	1.086	B	M	4	12	G4HD	81837
	46	03/04→	1.086	B	M	4	12	G4HG	81837

### COUPE' I

1.6 16V	85	03/98→04/02	1.599	B	M	4	16	G4GR	81785
1.6 i 16V	84	12/96→04/02	1.599	B	M	4	16	4G61	81785
2.0	101	08/99→01/02	1.975	B	M	4	16	G4DF	81785
2.0 16V	99	03/01→04/02	1.975	B	M	4	16	G4DF	81785
	102	08/96→04/02	1.975	B	M	4	16	G4GF	81785

### COUPE' II

1.6 16V	77	03/02→	1.599	B	M	4	16	G4ED-G	82020
	79	03/02→	1.599	B	M	4	16	G4ED-G	82020
2.0	100	08/01→	1.975	B	M	4	16	G4GC-G	81785
	102	03/02→	1.975	B	M	4	16	G4GC-G	81785
2.0 GLS	105	02/03→	1.975	B	M	4	16	G4GC-G	81785
2.7 V6	123	03/02→	2.656	B	M	6	24	G6BA-G	82021

### ELANTRA I

1.6	66	06/00→07/06	1.599	B	M	4	16		82020
	77	05/03→	1.599	B	M	4	16	G4ED-G	82020
	79	06/00→	1.599	B	AM	4	16	G4ED-G	82020
	82	09/03→	1.599	B	M	4	16	G4GA	82020
1.8	97	06/00→	1.795	B	M	4	16	G4BB	81785

	kW		Cap. cm3	Fuel	Gear	No. of cyl.	No. of valves	Motor code		MAGNETI MARELLI Short
--	----	--	----------	------	------	-------------	---------------	------------	--	-----------------------

## HYUNDAI

### ELANTRA I

2.0	102	06/00→	1.975	B	M	4	16	G4GC-G		81785
	104	06/00→	1.975	B	AM	4	16	G4GC		81785
	105	10/03→	1.975	B	M	4	16	G4GC		81785
2.0 CRDi	83	04/01→	1.991	D	M	4	16	D4EA		82085
CRDi	85	02/06→	1.582	D	M	4	16	D4FB		81817

### ELANTRA II

2.0 CVVT	105	06/06→	1.975	B	M	4	16	G4GC	11-2006→	81785
----------	-----	--------	-------	---	---	---	----	------	----------	-------

### GALLOPER I

2.5 TD	62	08/91→07/98	2.477	D	M	4	8	4D56T		81787
2.5 TD intercooler	70	08/91→07/98	2.477	D	M	4	8	4D56T		81787

### GALLOPER II

2.5 Tci D	77	08/98→	2.476	D	M	4	8	D4BH		81787
-----------	----	--------	-------	---	---	---	---	------	--	-------

### GETZ

1.1	46	09/02→	1.086	B	M	4	12	G4HD		81837
	49	09/05→	1.086	B	M	4	16			82020
1.3	60	09/02→	1.341	B	M	4	12	G4E-A		81784
	63	09/03→	1.341	B	M	4	12	G4E-A		81784
1.4	71	08/05→	1.399	B	M	4	16	G4EE		82020
1.5 CRDi	60	03/03→	1.493	D	M	3	12	D3-EA		82085
1.6	77	09/02→	1.599	B	M	4	16	G4ED-G		82020
	78	08/05→	1.599	B	M	4	16	G4ED-G		82020

### H - 1 I

2.4	82	10/97→	2.351	B	M	4	8	G4CS		81788
2.4 4WD	82	10/97→	2.351	B	M	4	8	G4CS		81788
2.5 D	57	10/97→	2.476	D	M	4	8	D4BB		81787
2.5 TD	59	10/97→	2.476	D	M	4	8	D4BF		81787

### H - 100

2.4	84	01/97→03/00	2.351	B	M	4	8	G4CS		81788
	90	07/93→03/00	2.351	B	M	4	8	G4CS		81788
2.5 D	55	07/93→12/94	2.477	D	M	4	8	D4BA, D4BX		81787
	57	12/94→03/00	2.477	D	M	4	8	D4BB		81787
2.5 TD	59	07/93→03/00	2.477	D	M	4	8	D4BF		81787

### HIGHWAY VAN

2.0 16V	100	03/00→	1.997	B	M	4	16		→01-2004	82031
---------	-----	--------	-------	---	---	---	----	--	----------	-------

### I30, STATION WAGON

2.0	105	10/07→	1.975	B	M	4	16	G4GC-G		81785
-----	-----	--------	-------	---	---	---	----	--------	--	-------

### LANTRA I

1.5 i.e.	63	10/90→11/95	1.468	B	M	4	8	G15B, G4DJ		81784
1.6 i.e. 16V	78	10/90→11/95	1.596	B	M	4	16	G4CR		81785
	84	10/90→11/95	1.596	B	M	4	16	G4CR		81785
1.8 i.e. 16V	93	10/90→11/95	1.836	B	M	4	16	G4CN		81786

### LANTRA II, STATION WAGON

1.5 12V	65	12/96→09/00	1.495	B	M	4	12	G4EK		81784
1.6 16V	84	11/95→09/00	1.599	B	M	4	16	4G61		81785
1.6 i	66	11/95→09/00	1.599	B	M	4	16	G4GR		81785
1.8 16V	94	11/95→09/00	1.795	B	M	4	16	G4GM		81785

	kw		Cap. cm3	Fuel	Gear	No. of cyl.	No. of valves	Motor code		Short
--	----	--	----------	------	------	-------------	---------------	------------	--	-------

## HYUNDAI

### LANTRA II, STATION WAGON

1.9 D	50	03/98→09/00	1.905	D	M	4	8			81642
2.0 16V	102	08/96→09/00	1.975	B	M	4	16	G4GF		81785

### MATRIX

1.8	90	06/01→	1.795	B	M	4	12	G4GB-G		81785
1.6	66	01/02→12/05	1.599	B	M	4	16	G4ED-L		82020
	76	06/01→	1.599	B	AM	4	16	G4ED-G		82020
1.5 CRDi	60	10/01→	1.496	D	M	3	12	D3-EA		82085

### PONY II, STATION WAGON

1.3	50	10/85→09/89	1.299	B	M	4	8	G13B		81784
1.5	53	10/85→09/89	1.468	B	M	4	8	G15B, G4DJ		81784

### PONY III, EXCEL

1.3	43	10/89→01/95	1.299	B	M	4	8	G4DG		81784
	49	10/89→01/95	1.299	B	M	4	8			81784
1.5	53	10/89→01/95	1.468	B	M	4	8	G15B, G4DJ		81784
1.5 i	61	10/89→01/95	1.468	B	M	4	8	G15B, G4DJ		81784
	62	10/89→01/95	1.468	B	M	4	8	G15B, G4DJ		81784

### S COUPÉ

1.5 GS	57	03/90→12/92	1.468	B	M	4	8			81784
1.5 i	62	02/90→05/96	1.468	B	M	4	8	G15B, G4DJ		81784
	65	04/92→05/96	1.495	B	M	4	12	G4EK		81784
1.5 i Turbo	85	04/91→05/96	1.495	B	M	4	12	G4EK-TC		81784

### SANTA FE' I

2.0	99	08/01→	1.997	B	M	4	16	G4BP		82031
2.0 CRDi	83	08/01→	1.991	D	M	4	16	D4EA		82085
2.0 CRDi 4 ruote motrici	107	11/03→02/06	1.991	D	M	4	16			82085
2.0 CRDi 4x4	83	04/01→	1.991	D	AM	4	16	D4EA		82085
	92	08/03→	1.991	D	M	4	16	D4EA		82085
2.4 16V	100	02/01→	2.351	B	M	4	16	G4JS-G		82031
	107	02/01→	2.351	B	M	4	16	G4JS-G		82031
2.4 16V 4x4	100	02/01→	2.351	B	M	4	16	G4JS-G		82031
	107	02/01→	2.351	B	M	4	16	G4JS-G		82031
2.7 V6 4x4	127	02/01→	2.656	B	A	6	24	G6BA-G		82021

### SANTAMO

2.0 16V	102	05/99→	1.997	B	M	4	16			82031
2.0 16V 4x4	102	05/99→	1.997	B	M	4	16			82031

### SONATA II

2.0 i 16V	92	06/96→06/98	1.997	B	M	4	16	G4CP-DM		81786
	102	05/93→06/98	1.997	B	M	4	16	G4CP-D		81786
3.0 i V6	107	05/93→06/98	2.972	B	M	6	12	G6AT	01-1989→, →12-1997	81788

### SONATA III

2.0	96	10/01→11/04	1.997	B	AM	4	16	G4JP-EG		82031
2.0 16V	100	06/98→10/01	1.997	B	M	4	16	G4JP-G		82031
2.4 16V	105	03/98→10/01	2.351	B	M	4	16			82031
2.5 V6 24V	118	06/98→10/01	2.493	B	A	6	24	G6BV-G		82021
2.7 V6	127	10/01→11/04	2.656	B	AM	6	24	G6BA-G		82021
	129	11/02→11/04	2.656	B	M	6	24	G6BA		82021

	kW		Cap. cm3	Fuel	Gear	No. of cyl.	No. of valves	Motor code		MAGNETI MARELLI Short
--	----	--	----------	------	------	-------------	---------------	------------	--	-----------------------

## HYUNDAI

### STAREX

2.4	82	06/97→	2.351	B	M	4	8	G4CS		81788
2.4 4WD	82	02/98→	2.351	B	M	4	8	G4CS		81788
2.5 TD	59	06/97→	2.476	D	M	4	8	D4BF		81787
2.5 TD 4WD	59	02/98→	2.476	D	M	4	8	D4BF		81787

### TIBURON

1.6 CVVT	78	10/06→	1.599	B	M	4	16	G4ED-G		82020
2.0 CVVT	105	10/06→	1.975	B	M	4	16	G4GC		81785

### TRAJET

2.0	92	08/05→	1.991	D	M	4	16	D4EA		82085
	100	03/00→	1.997	B	M	4	16	G4JP-G		82031
	103	01/04→	1.975	B	M	4	16	G4GC-G		81785
	104	11/03→	1.975	B	M	4	16	G4GC	02-2004→	81785
	104	11/03→	1.975	B	M	4	16	G4GC	→01-2004	82031
2.0 CRDi	83	04/01→	1.991	D	AM	4	16	D4EA		82085
2.7 V6	127	09/00→	2.656	B	A	6	24	G6BA-G		82021

### TUCSON

2.0	104	08/04→	1.975	B	M	4	16	G4GC		81785
2.0 4 ruote motrici	104	08/04→	1.975	B	M	4	16	G4GC		81785
2.0 CRDi	83	08/04→	1.991	D	M	4	16	D4EA	→12-2005	82085
2.0 CRDi 4 ruote motrici	83	08/04→	1.991	D	M	4	16	D4EA	→12-2005	82085
2.7 4 ruote motrici	129	08/04→	2.656	B	M	6	24	G6BA-G		82021

## IVECO

### DAILY I

30-8	53	01/78→12/89	2.445					8140.61.200		81334
	55	01/92→08/98	2.499					8140.07.2700, 8140.67F.	→12-1995	81334
	55	01/92→08/98	2.499					8140.07.2700, 8140.67F.	01-1996→	81332
	60	01/96→08/98	2.499					8140.67F.		81332
	62	09/98→	2.798					8140.63.		81332
30-8 V	62	09/98→	2.798					8140.63.		81332
30-8 V,30-8 C	53	01/78→12/89	2.445					8140.61.200		81334
	55	01/89→08/98	2.499					8140.07.2700, 8140.07.2712, 8140.67F.		81332
	60	01/96→08/98	2.499					8140.67F.		81332
	62	09/98→	2.798					8140.63.		81332
30-10	76	01/98→	2.798					8140.23.		81332
30-10 C	76	01/97→	2.798					8140.23.		81332
30-10 V,30-10 C	76	01/97→	2.798					8140.23.		81332
35-8	53	01/78→12/89	2.445					8140.61.200		81334
	62	09/98→	2.798					8140.63.		81332
35-8 K	62	09/98→	2.798					8140.63.		81332
35-8 V,35-8 C	53	01/78→12/89	2.445					8140.61.200		81334
	62	09/98→	2.798					8140.63.		81332
35-10	68	01/85→12/89	2.445					8140.21.200		81491
	68	01/89→12/96	2.499					8140.47R.2790	01-1991→, →12-1995	81334
	68	01/89→12/96	2.499					8140.47R.2790	01-1991→, →12-1995	81423

	kw		Cap. cm3	Fuel	Gear	No. of cyl.	No. of valves	Motor code		Short
--	----	--	----------	------	------	-------------	---------------	------------	--	-------

## IVECO

### DAILY I

35-10	68	01/89→12/96	2.499					8140.47R.2790	→12-1990	81491
	76	01/96→	2.798					8140.23.		81332
35-10 K	76	01/97→	2.798					8140.23.		81332
35-10 V,35-10 C	76	01/96→	2.798					8140.23.		81332
35-12	85	01/90→04/96	2.499					8140.47.2700	→12-1991	81335
	90	05/96→	2.798					8140.43.		81332
35-12 K	90	09/96→08/98	2.798					8140.43.		81332
40-8	53	01/83→06/89	2.445					8140.61.200		81334
40-8 V	53	01/83→06/89	2.445					8140.61.200		81334
40-10 V	76	01/90→04/96	2.499					8140.27.2720		81334
45-10	76	01/89→04/96	2.499					8140.27.2720		81334
45-10 V	76	01/89→04/96	2.499					8140.27.2720		81334
49-10	76	01/89→04/96	2.499					8140.27.2700, 8140.47R.2790		81334
	76	05/96→	2.798					8140.23.		81332
49-10 K	76	01/89→04/96	2.499					8140.27.2700, 8140.47R.2790		81334
	76	05/96→	2.798					8140.23.		81332
49-10 V	76	01/89→04/96	2.499					8140.27.2700, 8140.47R.2790		81334
49-12	90	05/96→	2.798					8140.43.		81332
49-12 K	90	05/96→	2.798					8140.43.		81332
49-12 V	90	05/96→	2.798					8140.43.		81332
59-12 K	90	05/96→	2.798					8140.43.		81332
59-12 V	90	05/96→	2.798					8140.43.		81332
A 40-10	76	01/91→12/96	2.499					8140.27.2720		81334
A 45-10	76	01/91→04/96	2.499					8140.27.2720		81334

### DAILY II

29 L 9	62	05/99→	2.798					8140.63.		82072
29 L 9 V	62	05/99→	2.798					8140.63.		82072
29 L 11	78	05/99→	2.798					8140.43B, 8140.43C		82072
29 L 11 V	78	05/99→	2.798					8140.43C		82072
29 L 12	85	09/02→	2.287					F1AE0481B		82024
29 L 12 V	85	09/02→	2.287					F1AE0481B		82024
35 C 14	100	09/04→04/06	2.998					F1CE0481A		82095
35 C 14, 35 S 14	100	01/05→04/06	2.287					F1AE0481M		82095
35 C 17, 35 S 17	122	01/05→04/06	2.998					F1CE0481B		82095
35 S 13,35 C 13	92	05/99→	2.798					8140.43S		82072
35 S 13 V,35 C 13 V	92	05/99→	2.798					8140.43S		82072
40 C 14	100	09/04→04/06	2.998					F1CE0481A		82095
40 C 17, 40 S 17	122	01/05→04/06	2.998					F1CE0481B		82095
50 C 11	78	05/99→	2.798					8140.43C		82072
50 C 13	92	05/99→	2.798					8140.43S		82072
50 C 14	100	09/04→04/06	2.998					F1CE0481A		82095
50 C 17	122	09/04→04/06	2.998					F1CE0481B		82095
65 C 14	100	09/04→04/06	2.998					F1CE0481A		82095
65 C 17	122	09/04→04/06	2.998					F1CE0481B		82095



	kW		Cap. cm3	Fuel	Gear	No. of cyl.	No. of valves	Motor code		MAGNETI MARELLI Short
--	----	--	----------	------	------	-------------	---------------	------------	--	-----------------------

## IVECO

### DAILY III

35C15, 35C15 /P, 35C15 D, 35C15 D/P	107		2.998					F1CE0481FA		82095
35C15 K, 35C15 DK	107		2.998					F1CE0481FA		82095
35C15 V, 35C15 V/P	107		2.998					F1CE0481FA		82095
35C18 K, 35C18 DK	130	05/06→	2.998					F1CE0481HA		82095
35C18 V, 35C18 V/P, 35S18 V, 35S18 V/P	130	05/06→	2.998					F1CE0481HA		82095
35C18, 35C18 /P, 35C18 D, 35C18 D/P, 35S18, 35S18 /P	130	05/06→	2.998					F1CE0481HA		82095
40C15 V, 40C15 V/P	107	05/06→	2.998					F1CE0481FA		82095
40C15, 40C15 /P, 40C15 D, 40C15 D/P	107	05/06→	2.998					F1CE0481FA		82095
40C18 V, 40C18 V/P	130	05/06→	2.998					F1CE0481HA		82095
40C18, 40C18 /P, 40C18 D, 40C18 D/P	130	05/06→	2.998					F1CE0481HA		82095
45C15 V, 45C15 V/P	107	05/06→	2.998					F1CE0481FA		82095
45C15, 45C15 /P, 45C15 D, 45C15 D/P	107	05/06→	2.998					F1CE0481FA		82095
45C18 V, 45C18 V/P	130	05/06→	2.998					F1CE0481HA		82095
45C18, 45C18 /P, 45C18 D, 45C18 D/P	130	05/06→	2.998					F1CE0481HA		82095
50C15 K, 50C15 DK	107	05/06→	2.998					F1CE0481FA		82095
50C15 V, 50C15 V/P	107	05/06→	2.998					F1CE0481FA		82095
50C15, 50C15 /P, 50C15 D, 50C15 D/P, 50C15 CCS, 50C15 CCS/P	107	05/06→	2.998					F1CE0481FA		82095
50C18 K, 50C18 DK	130	05/06→	2.998					F1CE0481HA		82095
50C18 V, 50C18 V/P	130	05/06→	2.998					F1CE0481HA		82095
50C18, 50C18 /P, 50C18 D, 50C18 D/P, 50C18 CCS, 50C18 CCS/P	130	05/06→	2.998					F1CE0481HA		82095
60C15, 60C15 /P, 60C15 D, 60C15 D/P	107	05/06→	2.998					F1CE0481FA		82095
60C15 K, 60C15 KK, 60C15 DK	107	05/06→	2.998					F1CE0481FA		82095
60C15 V, 60C15 V/P	107	05/06→	2.998					F1CE0481FA		82095
60C18, 60C18 V/P	130	05/06→	2.998					F1CE0481HC		82095
60C18, 60C18 /P, 60C18 D, 60C18 D/P, 60C18 CCS, 60C18 CCS/P	130	05/06→	2.998					F1CE0481HC		82095
60C18 K, 60C18 KK, 60C18 DK	130	05/06→	2.998					F1CE0481HC		82095
65C15, 65C15 /P, 65C15 D, 65C15 D/P	107	05/06→	2.998					F1CE0481FA		82095
65C15 V, 65C15 V/P	107	05/06→	2.998					F1CE0481FA		82095
65C18, 65C18 /P, 65C18 D, 65C18 D/P, 65C18 CCS, 65C18 CCS/P	130	05/06→	2.998					F1CE0481HC		82095
65C18 V, 65C18 V/P	130	05/06→	2.998					F1CE0481HC		82095

	kW		Cap. cm3	Fuel	Gear	No. of cyl.	No. of valves	Motor code		Short
--	----	--	----------	------	------	-------------	---------------	------------	--	-------

## JAGUAR

### X-TYPE, ESTATE

2.0 D	96	07/03→10/05	1.998	D	M	4	16	R4-X404		81805
2.0 V6	115	03/02→10/05	2.099	B	M	6	24			81845
2.2 D	114	10/05→	2.198	D	M	4	16	LJ46G		81805
	107	01/07→	2.198	D	M	4	16	LJ46G		81805
2.5	144	02/04→	2.495	B	M	6	24			81845
2.5 V6	144	06/01→	2.495	B	M	6	24			81845
3.0	169	02/04→	2.967	B	M	6	24			81845
3.0 V6	169	06/01→	2.967	B	M	6	24			81845

## JEEP

### CHEROKEE I

2.5 TD	85	01/88→	2.499	D	M	4	8		(-)COP	81362
2.5 TD	89	10/95→	2.469	B	M	4	8		(-)COP	81362

### COMPASS

2.0 CRD	103	09/06→	1.968	D	M	4	16			81816
2.0 D	103	08/06→	1.968	D	M	4	16			81816

### GRAND CHEROKEE I

2.5 TD	85	10/95→04/99	2.499	D	M	4	8	M51, M52	(-)COP	81362
2.5 TD Laredo	85	10/96→09/98	2.498	D	M	4	8		(-)COP	81362

### GRAND CHEROKEE II

3.1 TD	103	04/99→	3.125	D	M	5	10		(-)COP	81362
--------	-----	--------	-------	---	---	---	----	--	--------	-------

### PATRIOT

2.0 TD	103	01/08→	1.968	D	M	4	16	ECD		81816
--------	-----	--------	-------	---	---	---	----	-----	--	-------

### WRANGLER II

2.4	105	11/02→	2.429	B	M	4	16	ED1	(+)COP	81304
	105	11/02→	2.429	B	M	4	16	ED1	(-)COP	81365

## KIA

### CARENS II

2.0 CRDi	83	07/02→	1.991	D	M	4	16	D4EA		82085
2.0 CVT	102	08/04→	1.975	B	M	4	16	G4GC		81785

### CARNIVAL I

2.9 TD	93	08/99→10/01	2.903	D	M	4	16			82038
--------	----	-------------	-------	---	---	---	----	--	--	-------

### CARNIVAL II

2.9 TD	93	10/01→	2.903	D	M	4	16			82038
--------	----	--------	-------	---	---	---	----	--	--	-------

### CEE'D, STATION WAGON, PRO CEE'D

2.0	105	12/06→	1.975	B	M	4	16	G4GC		81785
2.0 CRDi	103	09/07→	1.991	D	M	4	16	D4EA-F		82085

### CERATO I, STATION WAGON

2.0	105	04/04→	1.975	B	M	4	16	G4GC		81785
1.6	77	04/04→	1.599	B	M	4	16	G4ED		82020
	90	05/06→	1.591	B	M	4	16	G4FC		82020
2.0 CRDi	83	04/04→	1.991	D	M	4	16	D4EA	→05-2005	82085

	kw		Cap. cm3	Fuel	Gear	No. of cyl.	No. of valves	Motor code		Short
--	----	--	----------	------	------	-------------	---------------	------------	--	-------

<b>KIA</b>										
<b>JOICE</b>										
2.0	88	09/01→	1.997	B	M	4	16			81786
	102	02/00→	1.997	B	M	4	16			81786
<b>MAGENTIS I</b>										
2.5 V6	124	05/01→	2.493	B	A	6	24			82021
2.0	100	05/01→	1.997	B	AM	4	16			82031
<b>PICANTO</b>										
1.0	45	09/05→	999	B	M	4	12	G4HE		81837
1.1	48	04/04→	1.086	B	M	4	12	G4HG		81837
<b>PRIDE I</b>										
1.6 CVT LX	82	03/05→	1.599	B	M	4	16	G4ED		82020
<b>RIO II</b>										
1.4 16V	71	03/05→	1.399	B	M	4	16	G4EE		82020
1.6 16V	82	03/05→	1.599	B	M	4	16	G4ED		82020
<b>SPORTAGE II</b>										
2.0 16V	104	09/04→	1.975	B	M	4	16	G4GC		81785
2.0 16V 4WD	104	09/04→	1.975	B	M	4	16	G4GC		81785
2.0 CRDi	83	02/05→	1.991	D	M	4	16	D4EA	EU3	82085
	103	01/06→	1.991	D	M	4	16	D4EA-V	EU3	82085
2.0 CRDi 4WD	83	09/04→	1.991	D	M	4	16	D4EA	EU3	82085
	103	01/06→	1.991	D	M	4	16	D4EA-V	EU3	82085
2.7 V6 4WD	129	09/04→	2.656	B	M	6	24	G6BA		82021

<b>LANCIA</b>										
<b>DEDRA, STATION WAGON</b>										
1.6	66	10/94→07/99	1.581	B	M	4	8	159B9.000	(+)COP	81303
	66	10/94→07/99	1.581	B	M	4	8	159B9.000	(-)COP	81339
1.6 16V	76	01/96→07/99	1.581	B	M	4	16	182A4.000	(+)COP	81303
	76	01/96→07/99	1.581	B	M	4	16	182A4.000	(-)COP	81339
1.6 i.e.	55	04/93→07/99	1.581	B	M	4	8	835C1.000	(+)COP	81303
	55	04/93→07/99	1.581	B	M	4	8	835C1.000	(-)COP	81339
	57	08/89→03/93	1.581	B	M	4	8	835A1.046	(-)COP	81314
	57	08/89→03/93	1.581	B	M	4	8	835A1.046	(+)SS	81333
	57	08/89→03/93	1.581	B	M	4	8	835A1.046	(+)COP	81476
	66	08/89→06/94	1.581	B	M	4	8	835A1.000	(-)COP	81314
	66	08/89→06/94	1.581	B	M	4	8	835A1.000	(+)SS	81333
	66	08/89→06/94	1.581	B	M	4	8	835A1.000	(+)COP	81476
1.6 LE	66	07/94→07/99	1.581	B	M	4	8	159B9.000	(+)COP	81303
	66	07/94→07/99	1.581	B	M	4	8	159B9.000	(-)COP	81339
1.8 16V LE	83	03/96→07/99	1.747	B	M	4	16	182A2.000		81331
1.8 GT 16V	96	03/96→07/99	1.747	B	M	4	16	183A1.000		81331
1.8 i.e.	66	08/93→07/99	1.756	B	M	4	8	835C5.000		81315
	74	07/94→07/99	1.756	B	M	4	8	836A5.000		81315
	77	09/89→07/99	1.756	B	M	4	8	835A2.046	05-1994→	81315
	77	09/89→07/99	1.756	B	M	4	8	835A2.046	09-1989→, →04-1994	81360
	80	09/89→06/94	1.756	B	M	4	8	835A2.000		81360

	kW		Cap. cm3	Fuel	Gear	No. of cyl.	No. of valves	Motor code		Short
--	----	--	----------	------	------	-------------	---------------	------------	--	-------

## LANCIA

### DEDRA, STATION WAGON

1.9 TDS	66	04/89→07/99	1.929	D	M	4	8	160D1.000, 835A4.000, 835A4.046	(-)COP, →04-1994	81326
	66	04/89→07/99	1.929	D	M	4	8	160D1.000, 835A4.000, 835A4.046	(+)COP, 05-1994→	81328
	66	04/89→07/99	1.929	D	M	4	8	160D1.000, 835A4.000, 835A4.046	(-)COP, 05-1994→	81363
	66	04/89→07/99	1.929	D	M	4	8	160D1.000, 835A4.000, 835A4.046	(+)COP, →04-1994	81464
2.0 16V	102	07/94→07/99	1.995	B	M	4	16	836A3.000		81322
2.0 HF Integrale	124	11/90→07/94	1.995	B	M	4	8	835A7.046		81315
2.0 i.e.	83	09/89→07/99	1.995	B	M	4	8	835A5.046	05-1994→	81315
	83	09/89→07/99	1.995	B	M	4	8	835A5.046	09-1989→, →04-1994	81360
	86	09/89→07/92	1.995	B	M	4	8	835A5.000		81360
2.0 i.e. Turbo	119	04/91→07/99	1.995	B	M	4	8	835A8.046		81315
2.0 i.e. Turbo Integrale	121	05/90→07/94	1.995	B	M	4	8	835A7.000		81315
2.0 Integrale	102	07/94→07/99	1.995	B	M	4	16	836A3.000		81322
2.0 Turbo	130	11/90→06/94	1.995	B	M	4	8	835A8.000		81315

### DELTA I

1.1	47	01/86→12/90	1.116	B	M	4	8	831B8.000	(-)COP	81481
	47	01/86→12/90	1.116	B	M	4	8	831B8.000	(+)COP	82060
1.3	55	09/79→08/92	1.301	B	M	4	8	831A2.000, 831B.000	(-)COP	81481
	55	09/79→08/92	1.301	B	M	4	8	831A2.000, 831B.000	(+)COP	82060
	58	09/83→08/92	1.301	B	M	4	8		(-)COP	81481
	58	09/83→08/92	1.301	B	M	4	8		(+)COP	82060
1.5	63	09/79→12/92	1.498	B	M	4	8	831A1.000, 831B1.000	(-)COP, →03-1986	81481
	63	09/79→12/92	1.498	B	M	4	8	831A1.000, 831B1.000	(+)COP, 04-1986→	81482
1.5	63	09/79→12/92	1.498	B	M	4	8	831A1.000, 831B1.000	(+)COP, →03-1986	82060
1.6 GT	77	11/82→04/86	1.585	B	M	4	8	831A4.000		81436
1.6 GT i.e.	66	05/87→08/92	1.585	B	M	4	8	149C2.000		81436
	80	08/86→08/88	1.585	B	M	4	8	831B7.000		81436
1.6 HF Turbo	96	10/83→12/86	1.585	B	M	4	8	831A7.000		81436
	97	04/87→03/89	1.585	B	M	4	8	831B7.046		81436
	103	08/86→08/88	1.585	B	M	4	8	831B3.000		81436
	122	08/86→05/93	1.585	B	M	4	8			81436
1.9 Turbo DS	59	10/86→12/89	1.929	D	M	4	8	831D1.000	M→: 792.526	81454
2.0 16V HF Integrale	144	03/89→09/91	1.995	B	M	4	16	831D5.000		81490
2.0 16V HF Evo Integrale	155	06/93→01/94	1.995	B	M	4	16	831E5.000, 831E5.046		81490
2.0 HF Integrale	130	12/86→12/92	1.995	B	M	4	8	831C5.046		81490

### DELTA II

1.4 i.e.	51	10/94→08/99	1.372	B	M	4	8	160A1.046, 836A4.000	(+)COP, 04-1995→	81303
	51	10/94→08/99	1.372	B	M	4	8	160A1.046, 836A4.000	→03-1995	81333
	51	10/94→08/99	1.372	B	M	4	8	160A1.046, 836A4.000	(-)COP, 04-1995→	81339
1.6 i.e.	55	06/93→08/99	1.581	B	M	4	8	835C1.000	(+)COP, 04-1995→, (+)SS, (+)AC	81303
	55	06/93→08/99	1.581	B	M	4	8	835C1.000	→03-1995	81333

	kw		Cap. cm3	Fuel	Gear	No. of cyl.	No. of valves	Motor code		Short
--	----	--	----------	------	------	-------------	---------------	------------	--	-------

## LANCIA

### DELTA II

1.6 i.e.	55	06/93→08/99	1.581	B	M	4	8	835C1.000	(-)COP, 04-1995→, (+)SS, (+)AC	81339
	66	03/96→08/99	1.581	B	M	4	16	182A6.000	(+)COP	81341
	66	03/96→08/99	1.581	B	M	4	16	182A6.000	(-)COP	81364
1.6 i.e. 16V	76	01/96→08/99	1.581	B	M	4	16	182A4.000	(+)COP	81341
	76	01/96→08/99	1.581	B	M	4	16	182A4.000	(-)COP	81364
1.8 i.e.	66	07/94→08/99	1.756	B	M	4	8	835C4.000, 836A6.000, 836C4.000		81315
	76	06/93→08/99	1.756	B	M	4	8	835C2.000		81315
1.8 i.e. 16V	83	03/96→08/99	1.747	B	M	4	16	182A2.000		81331
1.8 i.e. 16V GT	96	03/96→08/99	1.747	B	M	4	16	183A1.000		81331
1.9 TD	66	10/94→08/99	1.929	D	M	4	8	160D1.000, 835A4.000	(+)COP	81328
	66	10/94→08/99	1.929	D	M	4	8	160D1.000, 835A4.000	(-)COP	81363
2.0	108	11/94→04/98	1.995	B	M	4	16			81322
2.0 16V	102	06/93→08/99	1.995	B	M	4	16	836A3.000		81322
2.0 16V Turbo	137	06/93→08/99	1.995	B	M	4	16	836A2.000		81322
	142	07/96→08/99	1.995	B	M	4	16	175A4.000		81322

### DELTA III

1.4	88	09/08→	1.368	B	M	4	16	198A4.000		81369
	88	09/08→	1.368	B	M	4	16	198A4.000		82070
	110	09/08→	1.368	B	M	4	16	198A1.000		81369
	110	09/08→	1.368	B	M	4	16	198A1.000		82070
1.4 16V	103	07/10→	1.368	B	M	4	16			82070
1.6 MULTIJET	88	09/08→	1.598	D	M	4	16	198A2.000		81872
1.8 16V	147	02/09→	1.742	B	M	4	16			81331
1.8 Di	147	01/09→	1.759	B	M	4	16			81331
1.9 MULTIJET	140	01/09→	1.910	D	M	4	16	844A1.000		81872
2.0 MULTIJET	121	09/08→	1.956	D	M	4	16	198A5.000		81872

### KAPPA, STATION WAGON, COUPÉ

2.0 16V Turbo	151	02/95→10/01	1.995	B	M	4	16	838A4.000		81490
2.0 20V	107	10/94→10/01	1.998	B	M	5	20	838A1.000		81329
	114	07/96→10/01	1.998	B	M	5	20	838A6.000		81329
2.0 20V Turbo	162	06/98→10/01	1.998	B	M	5	20	175A3.000		81329
2.4 20V	129	08/94→10/01	2.446	B	M	5	20	838A2.000, 838A2.027		81329
2.4 JTD	100	06/98→10/01	2.387	D	M	5	10	838A8.000		81352
2.4 T.DS	91	08/94→10/01	2.387	D	M	5	10	838A3.000, 838A7.000	→08-1997, →M: 727.390	81330
	91	08/94→10/01	2.387	D	M	5	10	838A3.000, 838A7.000	09-1997→, M→: 727.391	81352
3.0 24V	150	08/94→10/01	2.959	B	M	6	24	838B.000		81355

### LYBRA, STATION WAGON

1.6 16V	76	07/99→	1.581	B	M	4	16	182A4.000, 182B6.000	(+)COP	81341
	76	07/99→	1.581	B	M	4	16	182A4.000, 182B6.000	(-)COP	81364
1.8 16V	96	07/99→	1.747	B	M	4	16	839A4.000, 839A7.000, 839A9.000		81331



kW



Cap. cm3

Fuel

Gear

No. of cyl.

No. of valves

Motor code

MAGNETI MARELLI  
Short

## LANCIA

### LYBRA, STATION WAGON

1.9 JTD	77	07/99→09/00	1.910	D	M	4	8	AR32302		81352
	81	09/00→05/01	1.910	D	M	4	8	AR37101		81352
	85	05/01→	1.910	D	M	4	8	937A2.000		81352
2.0 20V	113	07/99→09/00	1.998	B	M	5	20	182B7.000		81329
	110	09/00→	1.998	B	M	5	20	185A8.000		81329
2.4 JTD	99	07/99→09/00	2.387	D	M	5	10	839A5.000, AR32501		81352
	103	09/00→05/02	2.387	D	M	5	10	839A6.000		81352
	110	05/02→	2.387	D	M	5	10	841C.000		81352
	110	05/02→	2.387	D	M	5	10	841C.000		81796

### MUSA

1.3 D Multijet	70	08/09→	1.248	D	M	4	16			81862
1.3 Multijet	51	10/04→	1.248	D	M	4	16	188A9.000		81862
	66	09/06→	1.248	D	M	4	16	199A3.000		81862
1.4	57	09/05→	1.368	B	M	4	8	350A1.000		81369
	57	09/05→	1.368	B	M	4	8	350A1.000		82070
	70	10/04→	1.368	B	M	4	16	843A1.000		81369
	70	10/04→	1.368	B	M	4	16	843A1.000		82070
1.6 D Multijet	85	07/08→	1.598	D	M	4	16			81872
1.6 D Multijet	88	07/08→	1.598	D	M	4	16	350A2.000		81872
1.9 Multijet	74	10/04→	1.910	D	M	4	8	188B2.000		81352

### PHEDRA

2.0	100	09/02→	1.997	B	M	4	16	RFN (EW10J4)	(-)COP	81799
	100	09/02→	1.997	B	M	4	16	RFN (EW10J4)	(+)COP	82089
2.0 D Multijet	100	07/06→	1.997	D	M	4	16	RHR		81800
2.0 JTD	79	07/03→	1.997	D	M	4	16	RHM		81713
	80	09/02→	1.997	D	M	4	16	RHW (DW10ATED4)		81713
	88	06/06→	1.997	D	M	4	16	RHK		81800
2.2 D Multijet	125	03/08→	2.179	D	M	4	16			82068
2.2 JTD	94	09/02→	2.179	D	M	4	16	4HW (DW12ATED4)		81800
3.0 V6	150	09/02→	2.946	B	M	6	24	ES9J4S		81813

### PRISMA

1.3	58	01/83→02/92	1.301	B	M	4	8		(-)COP	81481
	58	01/83→02/92	1.301	B	M	4	8		(+)COP	82060
1.5	55	09/85→02/92	1.498	B	M	4	8	138C2.048, 831B1.048	(+)COP	81482
	59	08/86→02/92	1.498	B	M	4	8	831B1.000	(+)COP	81482
	63	01/83→04/86	1.498	B	M	4	8	831A1.000	(+)COP	82060
	63	01/83→04/86	1.498	B	M	4	8	831A1.000	(-)COP	81481
1.6	73	08/86→02/92	1.585	B	M	4	8	831B6.000		81436
	77	01/83→04/86	1.585	B	M	4	8	831A4.000		81436
1.6 i.e.	80	05/86→12/89	1.585	B	M	4	8	831B7.000		81436
1.6 i.e. Super	66	05/87→12/89	1.585	B	M	4	8	149C2.000		81436
1.9 Diesel	48	01/83→02/92	1.911	D	M	4	8	831D.000	(+)COP, →12-1985	81452
1.9 Turbo Diesel	59	05/85→12/89	1.928	D	M	4	8	831D1.000	(+)COP, →12-1985	81451
2.0 i.e. 4WD	85	04/86→12/89	1.995	B	M	4	8	831B4.000		81490

**kW**

**Cap. cm3**
**Fuel**
**Gear**
**No. of cyl.**
**No. of valves**
**Motor code**

**MAGNETI MARELLI**  
Short

**LANCIA**
**THEMA, STATION WAGON**

2000 16V	112	05/92→07/94	1.995	B	M	4	16	834F1.000		81490
2000 16V Turbo	133	12/88→06/90	1.995	B	M	4	16	834C1.000		81490
	148	10/92→07/94	1.995	B	M	4	16	834F2.000		81490
2000 i.e.	83	03/86→09/88	1.995	B	M	4	8	834B.048		81360
	85	09/87→05/92	1.995	B	M	4	8	834B.146		81360
	86	09/88→05/92	1.995	B	M	4	8	834B1.000		81360
	88	11/84→09/88	1.995	B	M	4	8	834B.000	12-1985→	81360
	88	11/84→09/88	1.995	B	M	4	8	834B.000	→11-1985	81443
2000 i.e. 16V	104	02/89→05/92	1.995	B	M	4	16	834B2.246		81490
	108	05/88→08/92	1.995	B	M	4	16	834B2.000		81490
2000 i.e. 16V Turbo	130	04/89→03/93	1.995	B	M	4	16	834C1.246		81490
	133	12/88→06/90	1.995	B	M	4	16	834C1.000		81490
2000 i.e. Turbo	110	07/86→05/90	1.995	B	M	4	8	834C.146	12-1985→, →05-1990	81360
	122	11/84→12/87	1.995	B	M	4	8	834C.000		81360
2000 Turbo	110	01/89→03/92	1.995	B	M	4	8	834C.146		81360
2000 Turbo 16V	148	11/92→07/94	1.995	B	M	4	16	834F2.000		81490
2500 Turbo D	74	11/84→09/88	2.445	D	M	4	8	8144.91		81445
2500 Turbo DS	74	03/87→09/90	2.445	D	M	4	8	8144.91		81445
	77	05/88→07/92	2.500	D	M	4	8	8144.97S	→10-1991	81445
	77	05/88→07/92	2.500	D	M	4	8	8144.97S	11-1991→	81324
	85	06/88→05/92	2.499	D	M	4	8	8144.97	11-1991→	81324
	85	06/88→05/92	2.499	D	M	4	8	8144.97	→10-1991	81445
	85	05/92→07/94	2.500	D	M	4	8	8144.97Y		81325
3000 V6	126	08/92→07/94	2.959	B	M	6	12	834F.000		81331

**THESIS**

2.0 Turbo	136	07/02→	1.998	B	M	5	20	841E.000		81329
2.4	125	07/02→	2.446	B	M	5	20	841D.000		81329
2.4 JTD	110	07/02→	2.387	D	M	5	10	841C.000		81352
	129	05/03→	2.387	D	M	5	20	841G.000		81872
2.4 Multijet	136	04/06→	2.387	D	M	5	20	841P.000		81872
3.0 V6	158	07/02→	2.959	B	A	6	24	841A.000		81355
3.2 V6	169	05/03→	3.179	B	M	6	24	841L.000		81355

**Y**

1.1	40	11/95→09/03	1.108	B	M	4	8	176B2.000		81801
1.2	44	03/96→09/03	1.242	B	M	4	8	188A4.000, 840A3.000	09-2000→	81370
	44	03/96→09/03	1.242	B	M	4	8	188A4.000, 840A3.000	→08-2000	81801
1.2 16V	59	10/00→09/03	1.242	B	M	4	16	188A5.000		81369
	63	04/97→09/03	1.242	B	M	4	16	176B9.000		81369
1.4 12V	55	03/96→09/03	1.370	B	M	4	12	840A4.000	M→: 705.145	81351
	55	03/96→09/03	1.370	B	M	4	12	840A4.000	→M: 705.144	81340
	59	10/96→09/03	1.370	B	M	4	12	840A2.000	→M: 705.144	81340
	59	10/96→09/03	1.370	B	M	4	12	840A2.000	M→: 705.145	81351

	kW		Cap. cm3	Fuel	Gear	No. of cyl.	No. of valves	Motor code		Short
--	----	--	----------	------	------	-------------	---------------	------------	--	-------

## LANCIA

### Y10

1.0 Fire	41	03/85→07/89	1.049	B	M	4	8	156A.000		81801
	37	03/85→02/90	999	B	M	4	8	156A2.000		81801
	32	06/85→06/91	999	B	M	4	8	156A2.100		81801
	33	03/85→02/92	999	B	M	4	8	156A2.000, 156A2.246		81801
1.0 Fire 4WD	32	12/86→02/89	999	B	M	4	8	156A2.100		81801
	33	12/87→02/92	999	B	M	4	8	156A2.246		81801
	37	12/87→02/90	999	B	M	4	8	156A2.000		81801
1.0 Turbo	62	03/85→02/89	1.049	B	M	4	8	156A1.000		81434
1.1 Avenue	40	01/95→12/95	1.108	B	M	4	8	176B2.000		81801
1.1 Avenue 4WD	40	01/95→12/95	1.108	B	M	4	8	176B2.000		81801
1.1 i.e	42	08/89→06/92	1.108	B	M	4	8	156C.000		81801
1.1 i.e 4WD	42	08/89→06/92	1.108	B	M	4	8	156C.000		81801
1.1 i.e. Fire	37	07/89→09/95	1.108	B	M	4	8	156C.046		81801
1.1 i.e. Fire 4WD	37	09/92→12/95	1.108	B	M	4	8	156C.046		81801
1.3 i.e. Fire	53	02/89→12/95	1.297	B	M	4	8	146A5.046, 156B.000		81434
	56	11/87→05/93	1.301	B	M	4	8	156B.000		81434

### YPSILON

1.2	44	10/03→	1.242	B	M	4	8	188A4.000		81370
	44	10/03→	1.242	B	M	4	8	188A4.000		82070
	59	10/03→	1.242	B	M	4	16	188A5.000		81369
	59	10/03→	1.242	B	M	4	16	188A5.000		82070
1.3 JTD	51	10/03→	1.248	D	M	4	16	188A9.000		81862
1.3 Multijet	55	09/06→	1.248	D	M	4	16	199A2.000		81862
	66	09/06→	1.248	D	M	4	16	199A3.000		81862
	77	05/07→	1.248	D	M	4	16			81862
1.4	57	02/06→	1.368	B	M	4	8	350A1.000		81369
	57	02/06→	1.368	B	M	4	8	350A1.000		82070
	70	10/03→	1.368	B	M	4	16	843A1.000		81369
	70	10/03→	1.368	B	M	4	16	843A1.000		82070

### ZETA

2.0 16V	97	05/98→07/00	1.998	B	M	4	16	RFV		81711
	100	07/00→09/02	1.997	B	M	4	16	RFN	(-)COP	81799
	100	07/00→09/02	1.997	B	M	4	16	RFN	(+)COP	82089
2.0 JTD	80	09/99→09/02	1.997	D	M	4	16	RHW		81713
2.0 Turbo	108	05/95→09/02	1.998	B	M	4	8	RGX		81642
2.1 TD	80	05/96→09/99	2.088	D	M	4	8	P8C		81353

## LAND ROVER

### DISCOVERY

2.0 16 V	99	09/93→10/98	1.994	B	M	4	16			81707
----------	----	-------------	-------	---	---	---	----	--	--	-------

### FREELANDER

2.0 DI	72	02/98→11/00	1.994	D	M	4	8			81707
2.5 V6	130	11/00→	2.497	B	M	6	24	25K4F		82029

### FREELANDER 2

2.2	118	10/06→	2.179	D	M	4	16			82068
2.2 SD4	140	08/10→	2.179	D	M	4	16			82068



	kW		Cap. cm3	Fuel	Gear	No. of cyl.	No. of valves	Motor code		MAGNETI MARELLI Short
--	----	--	----------	------	------	-------------	---------------	------------	--	-----------------------

## LAND ROVER

### FREELANDER 2

2.2 TD4	110	08/10→	2.179	D	M	4	16			82068
	112	01/07→	2.179	D	M	4	16			82068
2.2 TD4 4x4	110	10/06→	2.179	D	M	4	16			82068
	115	10/06→	2.179	D	M	4	16			82068

### RANGE ROVER

2.5 D	100	07/94→03/02	2.497	D	M	6	12	256T (BMW)		81597
3.0 Td 6	130	03/02→	2.926	D	M	6	24			81795

## LEXUS

### IS

220 d	130	10/05→	2.231	D	M	4	16	2AD-FHV		82071
-------	-----	--------	-------	---	---	---	----	---------	--	-------

### RX II

300	150	05/03→	2.995	B	M	6	24	1MZ-FE		82051
400h	155	09/04→	3.311	B	M	6	24	3MZ-FE		82051
400h FWD	155	09/05→	3.311	B	M	6	24	3MZ-FE		82051
3.3 4x4	171	04/03→	3.311	B	M	6	24	3MZ-FE		82051
3.3 FWD	171	04/03→01/06	3.311	B	M	6	24	3MZ-FE		82051

## MAZDA

### 121 III

1.25	55	03/96→	1.242	B	M	4	16	DHF, DHG		81598
1.8 D	44	03/96→	1.753	D	M	4	8	RTJ, RTK		81651
1.3	37	03/96→	1.299	B	M	4	8			81716
	44	03/96→	1.299	B	M	4	8			81716

### 323 C IV

1.3	49	09/89→07/94	1.324	B	M	4	8	B3E		81718
323 F VI										
2.0 TD	66	09/98→01/01	1.998	D	M	4	8			82092
2.0 TD	74	01/01→05/04	1.998	D	M	4	16	RF4F		82092

### 323 III, HATCHBACK, STATION WAGON

1.1	40	08/85→04/90	1.071	B	M	4	8	E1		81718
1.3	44	08/85→04/90	1.296	B	M	4	8	E3		81718
	50	09/85→03/87	1.296	B	M	4	8			81718
1.3 i	49	09/85→08/89	1.324	B	M	4	8			81718
1.4	44	04/87→10/89	1.324	B	M	4	8	B3		81718
1.5	54	01/87→10/89	1.498	B	M	4	8	B5, B50, B53		81718
	55	08/85→05/89	1.490	B	M	4	8	B50, B53, E5		81718
	55	09/89→09/91	1.498	B	M	4	8			81718
1.5 i	70	08/85→05/89	1.490	B	M	4	8	E5E3		81718
1.5 LX	50	01/86→06/87	1.490	B	M	4	8			81718

### 323 S VI

2.0 TD	66	09/98→05/04	1.998	D	M	4	8	RF3F		81718
2.0	74	10/00→10/02	1.998	D	M	4	16	RF4F		82092
2.0 TD	66	09/98→05/04	1.998	D	M	4	8	RF3F		82092

	kW		Cap. cm3	Fuel	Gear	No. of cyl.	No. of valves	Motor code		MAGNETI MARELLI Short
--	----	--	----------	------	------	-------------	---------------	------------	--	-----------------------

## MAZDA

### 626 V, STATION WAGON, HATCHBACK

2.0 DITD	66	04/98→10/02	1.998	D	M	4	16	RF3F		82092
2.0 TD	81	10/00→10/02	1.998	D	M	4	8			82092
2.0 Turbo DI	74	04/98→10/02	1.998	D	M	4	8			82092
	74	04/98→10/02	1.998	D	M	4	16	RF4F		82092

### 2 I

1.25	55	04/03→	1.242	B	M	4	16	FUJA		81598
1.4	59	04/03→	1.388	B	M	4	16	FXJA		81598
1.6	74	04/03→	1.596	B	M	4	16	FYJA		81598
1.4 CD	50	04/03→	1.399	D	M	4	8	F6JA		81798

### 2 II

1.4 MZR	50	01/08→	1.399	D	M	4	8			81798
1.6 MZ-CD	66	10/08→	1.560	D	M	4	16			81869

### 3 I

2.0	110	10/03→	1.999	B	M	4	16	LF17		81804
2.3	118	03/04→03/09	2.261	B	M	4	16			81804
	126	06/00→03/03	2.261	B	M	4	16			81804
2.3 DiSi Turbo MPS	184	06/06→	2.261	B	M	4	16			81804
2.3 MPS	191	12/06→	2.261	B	M	4	16			81804
2.3 MZR	115	03/04→03/09	2.261	B	M	4	16			81804
2.3 MZR Sport	126	10/03→	2.261	B	M	4	16			81804
1.6 DI Turbo	80	06/04→	1.560	D	M	4	16	Y601		81869
2.0 MZR-CD	105	12/06→	1.998	D	M	4	16	RF7J		82092

### 3 II

2.0 MZR	110	06/09→	1.999	B	M	4	16			81804
2.0 MZR DISI	111	06/09→	1.999	B	M	4	16			81804
2.3 MPS Turbo	190	06/09→	2.261	B	M	4	16			81804
1.6 MZR-CD	80	06/09→	1.560	D	M	4	16			81869

### 6 I, HATCHBACK, STATION WAGON

1.8	88	08/02→	1.798	B	M	4	16	L813		81804
2.0	104	06/02→	1.999	B	M	4	16	LF17, LF18		81804
	108	03/05→	1.999	B	M	4	16	LFF7		81804
2.3	122	06/02→	2.261	B	M	4	16	L3C1		81804
2.3 AWD	119	11/02→	2.261	B	M	4	16			81804
2.3 MPS	191	12/05→	2.261	B	M	4	16			81804
2.0 DI	89	08/02→	1.998	D	M	4	16	RF5C		82092
	100	06/02→	1.998	D	M	4	16	RF5C		82092
	105	06/05→	1.998	D	M	4	16	RF7J		82092

### 6 II, HATCHBACK, STATION WAGON

1.8 MRZ	88	08/07→	1.798	B	M	4	16	L813		81804
2.0 MRZ	108	08/07→	1.999	B	M	4	16			81804
2.5 MRZ	125	08/07→	2.488	B	M	4	16			81804
2.0 MRZ-CD	103	08/07→	1.998	D	M	4	16			82092

### CX-7

2.3 MZR DISI Turbo	175	11/06→	2.261	B	M	4	16			81804
2.3 MZR DISI Turbo	191	09/09→	2.261	B	M	4	16			81804
MZR DISI Turbo	190	10/07→	2.261	B	M	4	16	L3-VDT		81804

	kW		Cap. cm <sup>3</sup>	Fuel	Gear	No. of cyl.	No. of valves	Motor code		MAGNETI MARELLI Short
--	----	--	----------------------	------	------	-------------	---------------	------------	--	-----------------------

## MAZDA

### MPV II

2.0 DI	100	07/02→	1.998	D	M	4	16	RF5C		82092
2.3	104	07/02→	2.261	B	M	4	16			81804

### MX-5 III

1.8	93	03/05→	1.798	B	M	4	16			81804
2.0	118	03/05→	1.999	B	M	4	16			81804

### PREMACY

2.0 TD	66	10/99→07/00	1.998	D	M	4	16	RF3F		82092
	74	07/00→	1.998	D	M	4	16	RF4F		82092
2.3 SVT	122	02/05→	2.261	B	M	4	16			81804

### TRIBUTE

2.0	91	03/00→	1.989	B	M	4	16			81803
2.0 4WD	91	03/00→	1.989	B	M	4	16			81803
2.3 AWD	110	04/04→	2.261	B	M	4	16	L3-VE		81804
2.3 GX	110	12/03→10/04	2.261	B	M	4	16	L3-VE		81804

## MERCEDES-BENZ

### 190

2.0	77	09/84→05/90	1.996	B	M	4	8	M102.924		81509
	75	01/86→05/90	1.996	B	M	4	8	M102.924		81509
2.0 E	87	10/88→05/93	1.997	B	M	4	8	M102.962		81509
2.3	97	09/87→09/88	2.299	B	M	4	8	M102.985		81509
2.3 E	100	10/82→09/88	2.299	B	M	4	8	M102.985		81509
2.6	118	10/82→09/88	2.599	B	M	6	12	M103.942		81507
D 2.0	53	08/83→08/89	1.997	D	M	4	8	OM601.911		81504
	55	08/89→08/93	1.997	D	M	4	8	OM601.911		81504
D 2.5	66	04/85→08/93	2.497	D	M	5	10	OM602.911		81506
	69	08/89→08/93	2.497	D	M	5	10	OM602.911		81506
E 1.8	80	04/90→08/93	1.797	B	M	4	8	M102.910		81509
E 2.0	83	02/85→12/86	1.996	B	M	4	8	M102.961, M102.962		81509
	85	02/85→12/86	1.996	B	M	4	8	M102.962		81509
	87	01/85→08/93	1.996	B	M	4	8	M102.962		81509
	90	10/82→06/93	1.996	B	M	4	8	M102.961, M102.962		81509
	93	10/82→06/93	1.996	B	M	4	8			81509
E 2.3	97	09/86→08/91	2.298	B	M	4	8	M102.985		81509
	100	10/86→08/93	2.298	B	M	4	8	M102.985		81509
E 2.3-16	125	09/85→12/87	2.298	B	M	4	16	M102.983		81509
	130	09/85→08/88	2.298	B	M	4	16	M102.983		81509
	136	04/84→01/87	2.298	B	M	4	16	M102.983		81509
E 2.5-16	143	03/89→08/93	2.498	B	M	4	16	M102.991		81509
	150	09/88→08/93	2.498	B	M	4	16	M102.990	05-1991→, →05-1993	81509
E 2.6	118	09/86→08/93	2.597	B	M	6	12	M103.942		81507
E Evolution II 2.5	173	05/90→08/93	2.498	B	M	4	8	M102.992	05-1991→, →05-1993	81509
Turbo-D 2.5	90	02/88→08/93	2.497	D	M	5	10	OM602.961	01-1985→, →05-1993	81506
	93	02/88→08/93	2.497	D	M	5	10	OM602.961	01-1985→, →05-1993	81506

	kW		Cap. cm3	Fuel	Gear	No. of cyl.	No. of valves	Motor code		Short
--	----	--	----------	------	------	-------------	---------------	------------	--	-------

## MERCEDES-BENZ

### A (W168)

A 140	60	07/97→08/04	1.397	B	M	4	8	M166.940		82087
	60	01/01→08/04	1.598	B	A	4	8	M166.960		82087
A 160	75	07/97→08/04	1.598	B	M	4	8	M166.960		82087
A 160 CDI	44	07/98→02/01	1.689	D	M	4	16	OM668.941		82087
	55	02/01→08/04	1.689	D	M	4	16	OM668.940		82087
A 170 CDI	66	07/98→02/01	1.689	D	M	4	16	OM668.940		82087
	70	02/01→08/04	1.689	D	M	4	16	OM668.942		82087
A 190	92	03/99→08/04	1.898	B	M	4	8	M166.990		82087
A 210	103	03/02→08/04	2.084	B	M	4	8	M166.995		82087

### A (W169)

A 150	70	09/04→	1.498	B	M	4	8	M266.920		82017
A 160	70	04/09→	1.498	B	M	4	8	M266.920		82017
A 160 CDI	60	09/04→	1.991	D	M	4	16	OM640.942		82017
A 170	85	09/04→	1.699	B	M	4	8	M266.940		82017
A 180	85	04/09→	1.699	B	M	4	8	M266.940		82017
A 180 CDI	80	09/04→	1.991	D	M	4	16	OM640.940		82017
A 200	100	09/04→	2.034	B	M	4	8	M266.960		82017
A 200 CDI	103	09/04→	1.991	D	M	4	16	OM640.941		82017
A 200 TURBO	142	09/05→	2.034	B	M	4	8	M266.980		82017

### B (W245)

B 150	70	03/05→	1.498	B	M	4	8	M266.920		82017
B 160	70	04/09→	1.498	B	M	4	8	M266.920		82017
B 170	85	03/05→	1.699	B	M	4	8	M266.940		82017
B 170 NGT	85	04/08→	2.034	BF	M	4	8			82017
B 180	85	04/09→	1.699	B	M	4	8	M266.940		82017
B 180 CDI	80	03/05→	1.991	D	M	4	16	OM640.940		82017
B 180 NGT	85	04/08→	2.034	BF	M	4	8			82017
B 200	100	03/05→	2.034	B	M	4	8	M266.960		82017
B 200 CDI	103	03/05→	1.991	D	M	4	16	OM640.941		82017
B 200 TURBO	142	03/05→	2.034	B	M	4	8	M266.980		82017

### C, STATION WAGON (202)

C 180	90	03/93→05/00	1.799	B	M	4	16	M111.920, M111.921		81499
	89	11/94→05/00	1.799	B	M	4	16	M111.921		81499
C 180 T	90	06/96→09/00	1.799	B	M	4	16	M111.920, M111.921		81499
	95	09/00→03/01	1.998	B	M	4	16	M111.952		81499
C 200	100	01/94→05/00	1.998	B	M	4	16	M111.941, M111.945		81499
C 200 CDI	75	03/98→05/00	2.151	D	M	4	16	OM611.960		81499
C 200 D	55	03/93→05/00	1.997	D	M	4	8	OM601.913		81722
	65	10/96→05/00	1.997	D	M	4	16	OM604.915	06-1993→	81504
C 200 Kompressor	132	10/95→05/00	1.998	B	M	4	16	M111.944		81499
	141	11/96→05/00	1.998	B	M	4	16	M111.944		81499
C 200 T	100	06/96→03/01	1.998	B	M	4	16	M111.941, M111.945		81499
C 200 T CDI	75	03/98→03/01	2.151	D	M	4	16	OM611.960		82088
C 200 T Kompressor	141	11/96→03/01	1.998	B	M	4	16	M111.944		81499
	120	09/00→03/01	1.998	B	M	4	16	M111.956		81499
C 220	110	03/93→05/00	2.199	B	M	4	16	M111.961		81499

	kw		Cap. cm3	Fuel	Gear	No. of cyl.	No. of valves	Motor code		MAGNETI MARELLI Short
--	----	--	----------	------	------	-------------	---------------	------------	--	-----------------------

## MERCEDES-BENZ

### C, STATION WAGON (202)

C 220 CDI	92	09/97→05/00	2.151	D	M	4	16	OM611.960		82088
C 220 D	70	08/93→05/00	2.155	D	M	4	16	OM604.910		81723
	55	07/96→05/00	2.155	D	M	4	8	OM604.910		81723
C 220 T CDI	92	09/97→03/01	2.151	D	M	4	16	OM611.960		82088
C 220 T D	70	06/96→09/98	2.155	D	M	4	8	OM604.910		81499
	55	06/96→03/01	2.155	D	M	4	8	OM604.910		82088
C 230	110	06/96→06/97	2.295	B	M	4	16	M111.974		81499
C 230 Kompressor	142	10/95→05/00	2.295	B	M	4	16	M111.975		81725
C 230 T	110	06/96→06/98	2.295	B	M	4	16	M111.974		81499
C 230 T Kompressor	142	06/97→09/00	2.295	B	M	4	16	M111.975		81725
C 240	125	06/97→05/00	2.398	B	M	6	18	M112.910		81730
C 240 T	125	06/97→09/00	2.398	B	M	6	18	M112.910		81730
	125	09/00→03/01	2.597	B	M	6	18	M112.915		81730
C 250 D	83	05/93→05/00	2.497	D	M	5	20	OM605.910		81506
C 250 T Turbo-D	110	06/96→03/01	2.497	D	M	5	10	OM605.960		82088
C 250 Turbo-D	110	10/95→05/00	2.497	D	M	5	10	OM605.960	01-1997→	81726
C 280	142	05/93→05/00	2.799	B	M	6	24	M104.941		81722
	145	06/97→05/00	2.799	B	M	6	18	M112.920		81722
C 280 T	145	06/97→03/01	2.799	B	M	6	18	M112.920		81722
C 36 AMG	206	05/94→05/00	3.606	B	M	6	24	M104.941 (AMG3.6)		81722
C 43 AMG	225	08/97→03/01	4.266	B	M	8	24	M113.944	01-1998→	81730

### C, STATION WAGON, COUPÉ (203)

C 200 CDI	75	02/01→	2.148	D	M	4	16	OM646.962		82088
	85	03/01→	2.148	D	AM	4	16	OM611.962		82088
	85	09/00→	2.148	D	M	4	16	OM611.962		82088
C 200 CDI	90	04/03→	2.148	D	M	4	16	OM646.962		82088
C 220 CDI	105	03/01→	2.148	D	AM	4	16	OM611.962		82088
	105	05/00→	2.148	D	M	4	16	OM611.962		82088
	110	02/04→	2.148	D	M	4	16	OM646.963		82088
C 240	125	05/00→	2.597	B	M	6	18	M112.912		81730
C 240 4-matic	125	07/02→	2.597	B	M	6	18	M112.916		81730
C 270 CDI	125	03/01→	2.685	D	AM	5	20	OM612.962		82088
	125	12/00→	2.685	D	M	5	20	OM612.962		82088
C 320	160	05/00→	3.199	B	A	6	18	M112.946		81730
C 320 CDI	165	01/05→	2.987	D	M	6	24	OM642.910		82058

### C, STATION WAGON (204)

C 200 CDI	100	01/07→	2.148	D	M	4	16	OM646.811		82082
C 220 CDI	125	12/08→	2.143	D	M	4	16	OM651.911		82082
	125	01/07→	2.148	D	M	4	16	OM646.811		82082
	150	01/09→	2.143	D	M	4	16			82082
C 320 CDI	165	01/07→	2.987	D	M	6	24	OM642.960		82058
C 320 CDI 4-matic	165	07/07→	2.987	D	M	6	24	OM642.961		82058
C 350 CDI	165	07/09→	2.987	D	M	6	24	OM642.832		82058
	170	10/09→	2.987	D	M	6	24	OM642.830		82058
C 350 CDI 4-matic	165	07/09→	2.987	D	M	6	24	OM642.832		82058
	170	10/09→	2.987	D	M	6	24			82058

	kW		Cap. cm3	Fuel	Gear	No. of cyl.	No. of valves	Motor code		Short
--	----	--	----------	------	------	-------------	---------------	------------	--	-------

## MERCEDES-BENZ

### CLC

CLC 200 CDI	90	05/08→	2.148	D	M	4	16	OM646.962		82082
CLC 220 CDI	110	05/08→	2.148	D	M	4	16	OM646.963		82082

### CLK, CABRIO (208)

200	100	06/97→06/02	1.998	B	M	4	16	M111.941, M111.945		81499
	100	03/98→03/02	1.998	B	M	4	16	M111.941, M111.945		81725
200 Kompressor	120	06/00→06/02	1.998	B	M	4	16	M111.956		81725
	141	03/98→06/00	1.998	B	M	4	16	M111.944		81724
	141	06/97→06/00	1.998	B	M	4	16	M111.944		81725
230 Kompressor	142	06/97→06/00	2.295	B	M	4	16	M111.973, M111.975		81725
	145	06/00→06/02	2.295	B	M	4	16	M111.982		81725
320	160	03/98→03/02	3.199	B	A	6	24	M112.940		81730
	160	06/97→06/02	3.199	B	M	6	24	M112.940		81730
430	205	07/98→06/02	4.266	B	A	8	24	M113.943		81730

### CLK, CABRIO (209)

200 CGI	125	07/03→	1.796	B	M	4	16	M271.942		81725
220 CDI	110	01/05→	2.148	D	M	4	16	OM646.966		82082
240	125	06/02→	2.597	B	M	6	18	M112.912		81730
270 CDI	125	10/02→	2.685	D	M	5	20	OM612.962, OM612.967		82088
320	160	02/03→	3.199	B	M	6	18	M112.955		81730
	160	06/02→	3.199	B	A	6	18	M112.955		81730
320 CDI	165	01/05→	2.987	D	M	6	24	OM642.910		82058
500	225	02/03→	4.966	B	M	8	24	M113.968		81730
	225	06/02→	4.966	B	A	8	32	M113.968		81730

### CLS (219)

320 CDI	165	01/05→	2.987	D	M	6	24	OM642.910		82058
350 CDI	165	04/09→	2.987	D	M	6	24	OM642.920		82058
500	225	10/04→	4.966	B	M	8	24	M113.967		81730

### E, STATION WAGON, CABRIO, COUPÉ (124)

E 200	100	06/93→03/98	1.998	B	M	4	16	M111.940	06-1993→	81499
E 200 D	55	06/93→06/95	1.997	D	M	4	8	OM601.912		81504
E 200 T	100	06/93→06/96	1.998	B	M	4	16	M111.940	06-1993→, →01-1996	81499
E 220	110	06/93→03/98	2.199	B	M	4	16	M111.960	06-1993→	81499
E 220 T	110	06/93→06/96	2.199	B	M	4	16	M111.960		81499
E 250 D	83	07/93→06/95	2.497	D	M	5	20	OM605.911	→M: 033.729	81506
	83	07/93→06/95	2.497	D	M	5	20	OM605.911	M→: 033.730	81726
E 250 T D	83	06/93→06/96	2.497	D	M	5	20	OM605.911	01-1985→	81506
E 250 Turbo-D	93	06/93→06/95	2.497	D	M	5	10	OM602.962	01-1988→	81506
E 280	145	06/93→06/95	2.799	B	M	6	24	M104.942	06-1993→, →06-1995	81722
E 280 long	142	06/93→06/95	2.799	B	M	6	24	M104.942	06-1993→, →06-1995	81722
E 280 T	142	06/93→06/96	2.799	B	M	6	24	M104.942	06-1993→, →01-1996	81722
	145	06/93→06/96	2.799	B	M	6	24	M104.942	06-1993→, →01-1996	81722
E 300 4-matic	132	06/93→06/95	2.960	B	M	6	12	M103.985	01-1985→, →12-1996, M→: 094.339	81507
E 300 D	100	07/93→06/95	2.996	D	M	6	24	OM606.910	06-1993→	81506
E 300 T 4-matic	132	06/93→06/96	2.960	B	M	6	12	M103.985	06-1993→, →01-1996	81507
E 300 T D	100	06/93→06/96	2.996	D	M	6	24	OM606.910	07-1995→	81506

	kw		Cap. cm3	Fuel	Gear	No. of cyl.	No. of valves	Motor code		MAGNETI MARELLI Short
--	----	--	----------	------	------	-------------	---------------	------------	--	-----------------------

## MERCEDES-BENZ

### E, STATION WAGON, CABRIO, COUPÉ (124)

E 300 T Turbo-D	108	06/93→06/96	2.996	D	M	6	12	OM603.960	01-1987→	81506
E 300 T Turbo-D 4-matic	108	06/93→06/96	2.996	D	M	6	12	OM603.963	01-1987→	81506
E 300 Turbo-D	108	06/93→06/95	2.996	D	M	6	12	OM603.960	06-1993→	81506
E 300 Turbo-D 4-matic	108	06/93→06/95	2.996	D	M	6	12	OM603.963	06-1993→	81506
E 320	162	06/93→03/98	3.199	B	M	6	24	M104.992, M104.995	06-1993→	81722
E 320 T	162	06/93→06/96	3.199	B	M	6	24	M104.992	06-1993→	81722
E 36 AMG	200	05/94→03/98	3.606	B	M	6	24	M104.992 (AMG3.6)		81722

### E, STATION WAGON (210)

E 200	100	06/95→08/00	1.998	B	M	4	16	M111.942		81499
E 200 CDI	75	06/98→03/02	2.151	D	M	4	16	OM611.961		82088
	85	07/99→03/02	2.148	D	M	4	16	OM611.961		82088
E 200 D	65	01/96→03/02	1.997	D	M	4	16	OM604.917		81723
E 200 Kompressor	120	08/00→03/02	1.998	B	M	4	16	M111.957		81499
	137	06/97→03/02	1.998	B	M	4	16	M111.947		81725
E 200 T	100	06/96→08/00	1.998	B	M	4	16	M111.942		81499
E 200 T Kompressor	120	08/00→03/03	1.998	B	M	4	16	M111.957		81499
	137	06/97→03/03	1.998	B	M	4	16	M111.947		81725
E 220 CDI	92	06/98→07/99	2.151	D	M	4	16	OM611.961		82088
	105	07/99→03/02	2.148	D	M	4	16	OM611.961		82088
E 220 D	70	06/95→07/99	2.155	D	M	4	16	OM604.912		81723
	55	05/96→03/02	2.155	D	M	4	16	OM604.912		81723
E 220 T CDI	92	06/98→07/99	2.151	D	M	4	16	OM611.961		82088
	105	07/99→03/03	2.148	D	M	4	16	OM611.961		82088
E 230	110	06/95→06/97	2.295	B	M	4	16	M111.970		81499
E 230 T	110	06/96→06/97	2.295	B	M	4	16	M111.970		81499
E 240	125	06/97→08/00	2.398	B	M	6	18	M112.911		81730
	125	08/00→03/02	2.597	B	M	6	18	M112.914		81730
E 240 T	125	06/97→03/03	2.398	B	M	6	18	M112.911		81730
	125	08/00→03/03	2.597	B	M	6	18	M112.914		81730
E 250 D	83	06/95→07/99	2.497	D	M	5	20	OM605.912	01-1985→	81506
E 250 T D	83	06/96→07/99	2.497	D	M	5	20	OM605.912	01-1988→	81506
E 250 T Turbo-D	110	06/97→07/99	2.497	D	M	5	20	OM605.962	01-1988→	81506
E 250 Turbo-D	110	06/97→07/99	2.497	D	M	5	20	OM605.962	01-1988→	81506
E 270 CDI	125	07/99→03/02	2.685	D	M	5	20	OM612.961		82088
E 270 T CDI	125	07/99→03/03	2.685	D	M	5	20	OM612.961		82088
E 280	142	01/96→06/97	2.799	B	M	6	24	M104.945		81722
	150	12/96→03/02	2.799	B	M	6	18	M112.921		81722
E 280 4-matic	150	12/96→03/02	2.799	B	M	6	18	M112.921		81722
E 280 T	150	12/96→03/03	2.799	B	M	6	18	M112.921		81722
E 280 T 4-matic	150	12/96→03/03	2.799	B	M	6	18	M112.921		81722
E 290 T Turbo-D	95	06/96→07/99	2.874	D	M	5	10	OM602.982		81506
E 290 Turbo-D	95	03/96→07/99	2.874	D	M	5	10	OM602.982		81506
E 300 D	100	06/95→06/97	2.996	D	M	6	24	OM606.912	07-1995→	81506
E 300 T Turbo-D	130	12/96→07/99	2.996	D	M	6	24	OM606.962	07-1995→	81506
E 300 Turbo-D	130	12/96→07/99	2.996	D	M	6	24	OM606.962		81506

	kW		Cap. cm3	Fuel	Gear	No. of cyl.	No. of valves	Motor code		Short
--	----	--	----------	------	------	-------------	---------------	------------	--	-------

## MERCEDES-BENZ

### E, STATION WAGON (210)

E 320	162	06/95→06/97	3.199	B	M	6	24	M104.995		81722
	165	06/97→03/02	3.199	B	M	6	18	M112.941		81722
E 320 4-matic	165	06/97→03/02	3.199	B	M	6	18	M112.941		81722
E 320 CDI	145	07/99→03/02	3.226	D	A	6	24	OM613.961		82084
E 320 T	165	12/96→03/03	3.199	B	M	6	18	M112.941		81722
E 320 T 4-matic	165	12/96→03/03	3.199	B	M	6	18	M112.941		81722
E 320 T CDI	145	07/99→03/03	3.226	D	A	6	24	OM613.961		82084
E 430	205	06/97→03/02	4.266	B	M	8	24	M113.940		81730
E 430 4-matic	205	05/99→03/02	4.266	B	M	8	24	M113.940		81730
E 430 T	205	06/97→03/03	4.266	B	M	8	24	M113.940		81730
E 430 T 4-matic	205	05/99→03/03	4.266	B	M	8	24	M113.940		81730
E 55 AMG	260	08/97→03/02	5.439	B	M	8	24	M113.980		81730
E 55 T AMG	260	08/97→03/03	5.439	B	M	8	24	M113.980	01-1998→	81730

### E, STATION WAGON (211)

200 CDI	100	04/06→	2.148	D	M	4	16	OM646.820		82082
220 CDI	100	03/02→	2.148	D	M	4	16	OM646.961		82082
E 200 CDI	75	07/02→	2.148	D	M	4	16	OM646.951		82082
	90	07/02→	2.148	D	M	4	16	OM646.951		82082
	100	04/06→	2.148	D	M	4	16	OM646.821		82082
E 220 CDI	110	03/02→	2.148	D	M	4	16	OM646.961		82082
	125	04/06→	2.148	D	M	4	16	OM646.821		82082
E 220 T CDI	110	03/03→	2.148	D	M	4	16	OM646.961		82082
	125	04/06→	2.148	D	M	4	16	OM646.821		82082
E 240	130	03/02→	2.597	B	M	6	18	M112.913, M112.917	→M: 036.808	81730
E 240 4-matic	130	03/03→	2.597	B	M	6	18	M112.917		81730
E 240 T	130	03/03→	2.597	B	M	6	18	M112.913		81730
E 240 T 4-matic	130	07/03→	2.597	B	M	6	18	M112.917		81730
E 270 CDI	130	03/02→	2.685	D	M	5	20	OM647.961		83002
E 270 T CDI	130	03/03→	2.685	D	M	5	20	OM647.961		83002
E 280	170	03/05→	2.996	B	M	6	24	M272.943		83002
E 280 4-matic	170	01/06→	2.996	B	M	6	24	M272.943		83002
E 280 CDI	130	05/04→	3.222	D	M	6	24	OM648.961		83002
	140	03/05→	2.987	D	M	6	24	OM642.920		82058
E 280 CDI 4-matic	140	03/05→	2.987	D	M	6	24	OM642.921		82058
E 280 T	170	03/05→	2.996	B	M	6	24	M272.943		83002
E 280 T 4-matic	170	03/05→	2.996	B	M	6	24	M272.943		83002
E 280 T CDI	130	05/04→	3.222	D	M	6	24	OM648.961		83002
	140	03/05→	2.987	D	M	6	24	OM642.920		82058
E 280 T CDI 4-matic	140	03/05→	2.987	D	M	6	24	OM642.921		82058
E 300 BLUETEC	155	09/07→	2.987	D	M	6	24	OM642.920		82058
E 320	165	03/02→	3.199	B	M	6	18	M112.949		81730
E 320 4-matic	165	03/03→	3.199	B	M	6	18	M112.954		81730
E 320 CDI	150	11/02→	3.222	D	A	6	24	OM648.961		83002
	165	03/05→	2.987	D	M	6	24	OM642.920		82058
E 320 CDI 4-matic	165	03/05→	2.987	D	M	6	24	OM642.910		82058
E 320 T	165	03/03→	3.199	B	M	6	18	M112.949		81730



	kw		Cap. cm3	Fuel	Gear	No. of cyl.	No. of valves	Motor code		MAGNETI MARELLI Short
--	----	--	----------	------	------	-------------	---------------	------------	--	-----------------------

## MERCEDES-BENZ

### E, STATION WAGON (211)

E 320 T 4-matic	165	07/03→	3.199	B	M	6	18	M112.954		81730
E 320 T CDI	150	03/03→	3.222	D	M	6	24	OM648.961		83002
	165	03/05→	2.987	D	M	6	24	OM642.920		82058
E 320 T CDI 4-matic	165	03/05→	2.987	D	M	6	24	OM642.920		82058
E 500	225	03/02→	4.966	B	M	8	24	M113.967		81730
	285	04/06→	5.461	B	M	8	32	M273.960		81730
E 500 4-matic	225	10/03→	4.966	B	M	8	24	M113.969		81730
	285	04/06→	5.461	B	M	8	32	M273.962		81730
E 500 T	225	10/03→	4.966	B	M	8	24	M113.967		81730
	285	04/06→	5.461	B	M	8	32	M273.960		81730
E 500 T 4-matic	225	10/03→	4.966	B	M	8	24	M113.969		81730
	285	04/06→	5.461	B	M	8	32	M273.962		81730

### E, STATION WAGON (212), CABRIO, COUPÉ (207)

E 350 BlueTEC	155	01/09→	2.987	D	M	6	24	OM642.850		82058
E 350 CDI	170	01/09→	2.987	D	M	6	24	OM642.836, OM642.850, OM642.852		82058
E 350 CDI 4-matic	170	09/09→	2.987	D	M	6	24	OM642.856, OM642.858		82058

### GL

GL 320 CDI	165	09/06→05/09	2.987	D	M	6	24	OM642.940		82059
GL 350 CDI	165	05/09→	2.987	D	M	6	24	OM642.940		82059
GL 350 CDI BlueTEC	155	12/09→	2.987	D	M	6	24	OM642.820		82058

### GLK

320 CDI 4-matic	165	06/08→	2.987	D	M	6	24	OM642.961		82058
350 CDI 4-matic	165	07/09→	2.987	D	M	6	24	OM642.832		82058

### M (163)

ML 230	110	02/98→06/05	2.295	B	M	4	16	M111.977		81499
ML 270 CDI	120	12/99→06/05	2.685	D	M	5	20	OM612.963		82088
ML 320	160	02/98→08/02	3.199	B	M	6	18	M112.942		81730
ML 350	173	02/03→06/05	3.724	B	M	6	18	M112.970		81730
	180	08/02→06/05	3.724	B	M	6	18	M112.970		81730
ML 430	200	02/98→06/05	4.266	B	A	8	24	M113.942		81730
ML 55 AMG	255	02/00→06/05	5.439	B	A	8	24	M113.981	→M: M036.808	81730

### M (164)

ML 280 CDI 4-matic	140	07/05→07/09	2.987	D	M	6	24	OM642.940		82059
ML 300 CDI 4-matic	140	07/09→	2.987	D	M	6	24	OM642.940		82059
	150	02/10→	2.987	D	M	6	24			82058
ML 320 CDI 4-matic	165	07/05→07/09	2.987	D	M	6	24	OM642.940		82059
ML 350 CDI 4-matic	165	07/09→	2.987	D	M	6	24	OM642.940		82059
	170	02/10→	2.987	D	M	6	24			82059
ML 350 CDI BlueTEC 4-matic	155	09/09→	2.987	D	M	6	24	OM642.820		82058
ML 500 4-matic	225	07/05→	4.966	B	M	8	24	M113.964		81730

### R (251)

R 280 CDI	140	05/06→	2.987	D	M	6	24	OM642.950	→10-2007	82058
	140	05/06→	2.987	D	M	6	24	OM642.950	11-2007→	82059
R 300 CDI	140	07/09→	2.987	D	M	6	24	OM642.950		82059
R 300 CDI 4-matic	140	07/09→	2.987	D	M	6	24	OM642.950		82059

	kW		Cap. cm3	Fuel	Gear	No. of cyl.	No. of valves	Motor code		Short
--	----	--	----------	------	------	-------------	---------------	------------	--	-------

## MERCEDES-BENZ

### R (251)

R 320 CDI	165	01/06→	2.987	D	M	6	24	OM642.950	→10-2007	82058
	165	01/06→	2.987	D	M	6	24	OM642.950	11-2007→	82059
R 350 BlueTEC 4-matic	155	07/09→	2.987	D	M	6	24	OM642.950		82059
R 350 CDI 4-matic	165	07/09→	2.987	D	M	6	24	OM642.950		82059

### S (116)

280 S	115	08/72→07/80	2.746	B	M	6	12	M110.922	01-1974→, →12-1980	81503
	118	08/72→07/80	2.746	B	M	6	12	M110.922	01-1974→, →12-1980	81503
280 SE,SEL	130	08/72→07/80	2.746	B	M	6	12	M110.985	01-1974→, →12-1976	81503
	136	08/72→07/80	2.746	B	M	6	12	M110.983, M110.985	01-1972→, →12-1976	81503

### S, COUPÉ (126)

260 SE	118	09/85→06/91	2.597	B	M	6	12	M103.941	09-1985→, →06-1991, M→: 002.988	81507
	122	09/85→06/91	2.597	B	M	6	12	M103.941	09-1985→, →06-1991, M→: 002.988	81507
300 SE,SEL	132	01/86→06/91	2.960	B	M	6	12	M103.981		81507
	138	09/85→12/89	2.960	B	M	6	12	M103.981	01-1987→, →12-1991, M→: 004.966	81507

### S, COUPÉ (140)

300 SE 2.8	145	01/93→10/98	2.799	B	M	6	24	M104.944		81724
300 SE,SEL/S320	170	03/91→10/98	3.199	B	M	6	24	M104.990, M104.994		81724
S 280	142	02/93→10/98	2.799	B	M	6	24	M104.944		81724
S 300 Turbo-D	130	05/96→10/98	2.996	D	M	6	24	OM606.961		81506
S 350 Turbo-D	110	01/93→10/98	3.449	D	M	6	12	OM603.971		81506

### S (220), COUPÉ (215)

CL 500	225	03/99→03/06	4.966	B	A	8	24	M113.960	→M: 036.808	81730
CL 55 AMG	265	10/99→03/06	5.439	B	A	8	24	M113.986		81730
S 320	165	10/98→08/05	3.199	B	A	6	18	M112.944		81724
S 430	205	10/98→08/05	4.266	B	A	8	24	M113.941	→M: 036.808	81730
S 500	225	10/98→08/05	4.966	B	A	8	24	M113.960		81499

### S (221), COUPÉ (216)

S 320 CDI	173	12/05→	2.987	D	M	6	24	OM642.930		82059
S 320 CDI 4-matic	173	10/06→	2.987	D	M	6	24	OM642.930		82059

### SL (129)

280	142	08/93→10/01	2.799	B	M	6	24	M104.943	09-1994→	81722
	150	05/98→10/01	2.799	B	M	6	18	M112.923, M112.925		81722
300 SL	140	03/89→08/93	2.960	B	M	6	12	M103.984	06-1989→, →09-1993	81507
320	165	05/98→10/01	3.199	B	A	6	18	M112.943		81730
	170	09/93→10/01	3.199	B	M	6	24	M104.991		81724

### SL (230)

350	180	03/03→	3.724	B	M	6	18	M112.973		81730
500	225	10/01→	4.966	B	M	8	24	M113.963	→M: 036.808	81730

### SLK (170)

200	100	09/96→03/00	1.998	B	M	4	16	M111.946		81499
200 Kompressor	141	10/96→03/00	1.998	B	M	4	16	M111.943		81725
230 Kompressor	142	09/96→03/00	2.295	B	M	4	16	M111.973		81725
320	160	03/00→04/04	3.199	B	AM	6	18	M112.947		81730

	kW		Cap. cm3	Fuel	Gear	No. of cyl.	No. of valves	Motor code		MAGNETI MARELLI Short
--	----	--	----------	------	------	-------------	---------------	------------	--	-----------------------

## MERCEDES-BENZ

<b>V</b>										
V 200	95	02/97→07/03	1.998	B	M	4	16	M111.948	→M: 002.353	81728
	95	02/97→07/03	1.998	B	M	4	16	M111.948	M→: 002.354	81729
V 200 CDI	75	03/99→07/03	2.151	D	M	4	16	OM611.980		82030
V 220 CDI	90	03/99→07/03	2.151	D	M	4	16	OM611.980		82030
V 230	105	10/96→07/03	2.295	B	M	4	16	M111.978	→M: 001.594	81728
	105	10/96→07/03	2.295	B	M	4	16	M111.978	M→: 001.595	81729
V 230 TD	72	09/96→07/03	2.299	D	M	4	8	OM601.970		81506
V 280	128	08/97→07/03	2.792	B	M	6	12	M104.900		81773
<b>VANEO</b>										
1.6	60	02/02→	1.598	B	M	4	8	M166.961		82087
	75	02/02→	1.598	B	M	4	8	M166.961		82087
1.7 CDI	55	02/02→	1.689	D	M	4	16	OM668.914		82087
	67	02/02→	1.689	D	M	4	16	OM668.914		82087
1.9	92	02/02→	1.898	B	M	4	8	M166.991		82087

## MERCEDES-BENZ

<b>SPRINTER I (904)</b>										
2.3 D 4x4	58	06/97→12/99	2.299	D	M	4	8	OM601.943		81506
408 CDI	60	04/00→05/06	2.148	D	M	4	16	OM611.987		82047
408 D	58	02/96→05/06	2.299	D	M	4	8	OM601.943	01-1996→	81774
410 D	75	02/96→05/06	2.874	D	M	5	10	OM602.980	12-1994→	81506
410 D 4x4	75	05/97→05/06	2.874	D	M	5	10	OM602.980	12-1994→	81506
411 CDI	80	04/00→05/06	2.148	D	M	4	16	OM611.981		82047
411 CDI 4x4	80	04/00→05/06	2.148	D	M	4	16	OM611.981		82047
412 D	85	02/96→05/06	2.874	D	M	5	10	OM602.980	12-1994→	81506
	90	02/96→05/06	2.874	D	M	5	10	OM602.980	12-1994→	81506
412 D 4x4	85	05/97→05/06	2.874	D	M	5	10	OM602.980	12-1994→	81506
	90	05/97→05/06	2.874	D	M	5	10	OM602.980	12-1994→	81506
413 CDI	95	04/00→05/06	2.148	D	M	4	16	OM611.981		82047
413 CDI 4x4	95	04/00→05/06	2.148	D	M	4	16	OM611.981		82047
414	105	02/96→05/06	2.295	B	M	4	16	M111.979, M111.984	01-1996→	81774
414 4x4	105	05/97→05/06	2.295	B	M	4	16	M111.979, M111.984	01-1996→	81774
416 CDI	115	04/00→05/06	2.685	D	M	5	20	OM612.981		82047
416 CDI 4x4	115	04/00→05/06	2.685	D	M	5	20	OM612.981		82047
<b>SPRINTER II (905)</b>										
2.3 D 4x4	58	06/97→12/99	2.299	D	M	4	8	OM601.943		81506
2.9 TDi	75	01/97→12/99	2.874	D	M	5	10	OM602.980		81506
208 CDI	60	04/00→05/06	2.148	D	M	4	16	OM611.987		82047
208 D	58	02/95→04/00	2.299	D	M	4	8	OM601.943		81506
	58	01/95→04/00	2.299	D	M	4	8	OM601.943	01-1996→	81774
	60	09/96→04/00	2.299	D	M	4	8		01-1996→	81774
	60	10/96→04/00	2.299	D	M	4	16		01-1996→	81774
210 D	75	01/97→04/00	2.874	D	M	5	10	OM602.980	12-1994→	81506
211 CDI	80	04/00→05/06	2.148	D	M	4	16	OM611.981		82047
212 D	90	02/95→04/00	2.874	D	M	5	10	OM602.980	12-1994→	81506
213 CDI	95	04/00→05/06	2.148	D	M	4	16	OM611.981		82047

	kw		Cap. cm3	Fuel	Gear	No. of cyl.	No. of valves	Motor code		Short
--	----	--	----------	------	------	-------------	---------------	------------	--	-------

## MERCEDES-BENZ

### SPRINTER II (905)

214	105	02/95→05/06	2.295	B	M	4	16	M111.979, M111.984	01-1996→	81774
214 NGT	92	04/00→05/06	2.295	G	M	4	8			81774
	92	04/00→05/06	2.295	G	M	4	16	M111.984		81774
216 CDI	115	04/00→05/06	2.685	D	M	5	20	OM612.981		82047
308 CDI	60	04/00→05/06	2.148	D	M	4	16	OM611.987		82047
308 D	58	02/95→04/00	2.299	D	M	4	8	OM601.943	01-1996→	81774
308 D 2.3	58	02/95→04/00	2.299	D	M	4	8	OM601.943	01-1996→	81774
	60	02/95→04/00	2.299	D	M	4	8		→04-1995	81506
	60	11/96→04/00	2.299	D	M	4	8		01-1996→	81774
310 D 2.9	75	02/95→04/00	2.874	D	M	5	10	OM602.980	12-1994→	81506
310 D 4x4	75	05/97→08/02	2.874	D	M	5	10	OM602.980	12-1994→	81506
311 CDI	80	04/00→05/06	2.148	D	M	4	16	OM611.981		82047
311 CDI 4x4	80	08/02→05/06	2.148	D	M	4	16	OM611.981		82047
312 D 2.9	90	02/95→04/00	2.874	D	M	5	10	OM602.980	12-1994→	81506
312 D 2.9 4x4	90	05/97→08/02	2.874	D	M	5	10	OM602.980	12-1994→	81506
313 CDI	95	04/00→05/06	2.148	D	M	4	16	OM611.981		82047
313 CDI 4x4	95	08/02→05/06	2.148	D	M	4	16	OM611.981		82047
314	105	02/95→05/06	2.295	B	M	4	16	M111.979, M111.984	01-1996→	81774
314 4x4	105	08/02→05/06	2.295	B	M	4	16	M111.979, M111.984		81774
314 NGT	92	04/00→05/06	2.295	G	M	4	8			81774
	92	04/00→05/06	2.295	G	M	4	16	M111.984		81774
316 CDI	115	04/00→05/06	2.685	D	M	5	20	OM612.981		82047
316 CDI 4x4	115	08/02→05/06	2.685	D	M	5	20	OM612.981		82047

### SPRINTER III (906)

209 CDI	65	06/06→	2.148	D	M	4	16	OM646.984		82052
211 CDI	80	06/06→	2.148	D	M	4	16	OM646.985		82052
213 CDI	95	06/06→	2.148	D	M	4	16	OM646.986		82052
215 CDI	110	06/06→	2.148	D	M	4	16	OM646.990		82052
218 CDI	135	06/06→	2.987	D	M	6	24	OM642.992		82052
	135	06/06→	2.987	D	M	6	24	OM642.992		82058
219 CDI	140	03/09→	2.987	D	M	6	24	OM642.992		82058
224	190	06/06→	3.498	B	M	6	24	M272.979		82052
309 CDI	65	06/06→	2.148	D	M	4	16	OM646.984		82052
311 CDI	80	06/06→	2.148	D	M	4	16	OM646.985		82052
311 CDI 4x4	80	02/08→	2.148	D	M	4	16	OM646.985		82052
313 CDI	95	06/06→	2.148	D	M	4	16	OM646.986		82052
315 CDI	110	06/06→	2.148	D	M	4	16	OM646.990		82052
315 CDI 4x4	110	02/08→	2.148	D	M	4	16	OM646.990		82052
318 CDI	135	06/06→	2.987	D	M	6	24	OM642.992		82052
	135	02/08→	2.987	D	M	6	24			82058
318 CDI 4x4	135	02/08→	2.987	D	M	6	24	OM642.992		82058
319 CDI	140	03/09→	2.987	D	M	6	24	OM642.992		82058
319 CDI 4x4	140	03/09→	2.987	D	M	6	24			82058
324	190	06/06→	3.498	B	M	6	24	M272.979		82052
415 CDI	110	06/06→	2.148	D	M	4	16			82052
418 CDI	135	06/06→	2.987	D	M	6	24			82058

	kw		Cap. cm3	Fuel	Gear	No. of cyl.	No. of valves	Motor code		Short
--	----	--	----------	------	------	-------------	---------------	------------	--	-------

## MERCEDES-BENZ

### SPRINTER III (906)

419 CDI	140	03/09→	2.987	D	M	6	24	OM642.992		82058
509 CDI	65	06/06→	2.148	D	M	4	16	OM646.984		82052
511 CDI	80	06/06→	2.148	D	M	4	16	OM646.985		82052
515 CDI	110	06/06→	2.148	D	M	4	16	OM646.986, OM646.990		82052
518 CDI	135	06/06→	2.987	D	M	6	24	OM642.992		82052
	135	06/06→	2.987	D	M	6	24	OM642.992		82058
519 CDI	140	03/09→	2.987	D	M	6	24	OM642.992		82058

### T1 I (601)

207 D 2.4	48	04/77→12/82	2.404	D	M	4	8	OM616.917, OM616.934	01-1972→, →12-1981	81503
	53	07/82→01/90	2.376	D	M	4	8			81508
	53	12/77→10/89	2.399	D	M	4	8	OM616.937		81503
	53	06/82→01/90	2.399	D	M	4	8	OM616.937, OM616.939		81508
208 D 2.3	58	10/88→02/96	2.299	D	M	4	8	OM601.940		81506
	60	10/88→02/96	2.299	D	M	4	8	OM601.940	02-1988→, →04-1995	81506
209 D 2.9	65	12/82→01/90	2.998	D	M	5	10	OM617.913		81721
210 D 2.8	70	10/88→02/96	2.874	D	M	5	10	OM602.940	01-1983→	81506
	72	10/88→02/96	2.874	D	M	5	10	OM602.940	01-1983→	81506
210 D 2.9	70	11/88→02/96	2.874	D	M	5	10	OM602.940		81506

### T1 II (602)

307 D 2.4	48	04/77→01/83	2.399	D	M	4	8	OM616.937	01-1972→, →12-1981	81503
	53	06/82→01/90	2.399	D	M	4	8	OM616.937, OM616.939		81508
308 D 2.3	58	11/88→02/96	2.299	D	M	4	8	OM601.940	01-1983→, →04-1995	81506
	60	06/89→02/96	2.299	D	M	4	8	OM601.940	01-1983→, →04-1995	81506
309 D 3.0	65	10/82→01/90	2.998	D	M	5	10	OM617.913		81721
310 D 2.9	70	06/89→02/96	2.874	D	M	5	10	OM602.940	01-1983→	81506
	72	06/89→02/96	2.874	D	M	5	10	OM602.940	01-1983→	81506

### VITO - VIANO I (638)

108 CDI 2.2	60	03/99→07/03	2.148	D	M	4	16	OM611A (60KWCDI)		82030
	60	03/99→07/03	2.151	D	M	4	16	OM611A (60KWCDI)		82030
108 D 2.3	58	02/96→07/03	2.299	D	M	4	8	OM601.942		81506
	58	03/97→07/03	2.299	D	M	4	16	OM601.942	11-1995→	81506
110 CDI 2.2	75	03/99→07/03	2.148	D	M	4	16	OM611LA (75KWCDI)		82030
	75	03/99→07/03	2.151	D	M	4	16	OM611LA (75KWCDI)		82030
110 D 2.3	72	03/97→07/03	2.299	D	M	4	8	OM601.970	11-1995→	81506
110 TD 2.3	72	02/96→07/03	2.299	D	M	4	8	OM601.970		81506
112 CDI 2.2	90	03/99→07/03	2.151	D	M	4	16	OM611.980		82030
113 2.0	95	02/96→07/03	1.998	B	M	4	16	M111.948	→M: 002.353	81728
	95	02/96→07/03	1.998	B	M	4	16	M111.948	M→: 002.354	81729
114 2.3	105	12/96→07/03	2.295	B	M	4	16	M111.978, M111.980	→M: 001.594, →M: 001.954	81728
	105	12/96→07/03	2.295	B	M	4	16	M111.978, M111.980	M→: 001.595	81729

### VITO - VIANO II (639)

109 CDi	70	08/06→	2.148	D	M	4	16	OM646.981		82052
109 CDI 2.2	65	09/03→	2.148	D	M	4	16	OM646.983		82052
	70	09/06→	2.148	D	M	4	16	OM646.980, OM646.981		82052

	kW		Cap. cm3	Fuel	Gear	No. of cyl.	No. of valves	Motor code		Short
--	----	--	----------	------	------	-------------	---------------	------------	--	-------

## MERCEDES-BENZ

### VITO - VIANO II (639)

111 CDI 2.2	80	09/03→	2.148	D	M	4	16	OM646.982		82052
	85	09/07→	2.148	D	M	4	16	OM646.982		82052
111 CDI 2.2 4x4	80	09/07→	2.148	D	M	4	16	OM646.982		82052
115 CDI 2.2	110	09/03→	2.148	D	M	4	16	OM646.982		82052
115 CDI 2.2 4x4	110	09/07→	2.148	D	M	4	16	OM646.982		82052
119	140	09/03→	3.199	B	M	6	18	M112.951		81730
119 3.2	140	09/03→	3.199	B	M	6	18	M112.951		81730
120 CDI	150	09/07→	2.987	D	M	6	24	OM642.990		82058
122	160	09/03→	3.199	B	M	6	18	M112.951		81730
122 3.2	160	09/03→	3.199	B	M	6	18	M112.951		81730
123	170	06/04→	3.724	B	M	6	24	M112.976	→M: 31.000.000	81730
	170	06/04→07/08	3.724	B	M	6	18		→M: 31.000.000	81730
2.2 Cdi	85	08/05→	2.148	D	M	4	16			82052
3.0 CDI	150	03/06→	2.987	D	M	6	24	OM642.990		82058
3.2	140	09/03→	3.199	B	M	6	18	M112.951		81730
	160	09/03→	3.199	B	M	6	18	M112.951		81730
3.7	170	06/04→	3.724	B	M	6	24	M112.976	→M: 31.000.000	81730
CDI 2.0 4-matic	80	07/05→	2.148	D	M	4	16	OM646.982		82052
CDI 2.2	80	09/03→	2.148	D	M	4	16	OM646.982		82052
	110	09/03→	2.148	D	M	4	16	OM646.982		82052
CDI 2.2 4-matic	110	07/05→	2.148	D	M	4	16	OM646.982		82052

## MG

### MG TF

115	85	03/02→	1.588	B	M	4	16	16K4F		81615
120	88	03/02→	1.796	B	A	4	16	18K4F		81615
135	100	03/02→	1.796	B	M	4	16	18K4F		81615
160	118	03/02→	1.796	B	M	4	16	18K4K		81615

### MG ZR

105	76	06/01→	1.396	B	M	4	16	14K4F		81615
120	86	06/01→	1.796	B	M	4	16	18K4F		81615
160	118	06/01→	1.796	B	M	4	16	18K4K		81615
Turbodiesel	74	06/01→	1.994	D	M	4	8	20T2N		81707

### MG ZS

120	86	07/01→	1.796	B	M	4	16	18K4F		81615
180	130	07/01→	2.497	B	M	6	24	25K4F		82029
2.0 TD	74	01/04→	1.994	D	M	4	8	20T2N		81707
	83	01/04→	1.994	D	M	4	8			81707

### MGF

1.6	82	02/00→03/02	1.588	B	M	4	16	16K4F		81615
1.8 i 16V	88	03/95→03/02	1.796	B	M	4	16	18K4F		81615
1.8 i V6C	107	03/95→03/02	1.796	B	M	4	8	18K4K		81615
	118	10/01→03/02	1.796	B	M	4	16	18K4K		81615

	<b>kW</b>		<b>Cap. cm3</b>	<b>Fuel</b>	<b>Gear</b>	<b>No. of cyl.</b>	<b>No. of valves</b>	<b>Motor code</b>		
--	-----------	--	-----------------	-------------	-------------	--------------------	----------------------	-------------------	--	--

## MINI

### MINI CLUBMAN

1.6	88	10/07→	1.598	B	M	4	16	N12B16A		82032
	120	10/07→	1.598	B	M	4	16	N14B16A		82032
	128	10/07→	1.598	B	M	4	16	N14B16A		82032
1.6 D	80	10/07→	1.560	D	M	4	16	9HZ (DV6TED4)		81869
Cooper	90	03/10→	1.598	B	M	4	16			82032
Cooper S	135	03/10→	1.598	B	M	4	16			82032
John Cooper Works	155	03/08→	1.598	B	M	4	16			82032
One	70	03/10→	1.397	B	M	4	16	N12B14A		82032
	72	03/10→	1.598	B	M	4	16			82032

### MINI COUNTRYMAN

COOPER	90	06/10→	1.598	B	M	4	16			82032
COOPER S	135	06/10→	1.598	B	M	4	16			82032
COOPER S ALL4	135	06/10→	1.598	B	M	4	16			82032
ONE	72	06/10→	1.598	B	M	4	16			82032

## MITSUBISHI

### CARISMA

1.9 TD	66	10/96→09/00	1.870	D	M	4	8	F8QT		81574
1.9 DI-D	75	09/00→06/06	1.870	D	M	4	8	F9Q1		81814
	85	09/00→06/06	1.870	D	M	4	8	F9Q2		81814

### COLT IV

1.3 GLi 12V	55	04/92→04/96	1.299	B	M	4	12	4G13 (BJ92-.,12V)		81784
1.6 4x4	84	08/93→08/95	1.597	B	M	4	16	4G92		81731
1.6 GLXi 16V	83	04/92→04/96	1.597	B	M	4	16	4G92		81731
1.8 GTi 16V	103	04/92→04/96	1.834	B	M	4	16	4G93		81731

### COLT V

1500	69	11/95→07/05	1.468	B	M	4	16	4G15 (16V)		81784
------	----	-------------	-------	---	---	---	----	------------	--	-------

### COLT VI, CZC

1.1	55	10/04→	1.124	B	M	3	12	3A91		82049
1.3	70	06/04→	1.332	B	M	4	16	4A90		82049
1.5	80	06/04→	1.499	B	M	4	16	4A91		82049
1.5 DI-D	50	08/04→	1.493	D	M	3	12			82017
	70	08/04→	1.493	D	M	3	12	OM639		82017

### COLT VII

1.3	70	09/08→	1.332	B	M	4	16			82049
-----	----	--------	-------	---	---	---	----	--	--	-------

### ECLIPSE I, CABRIO

2.0 i 16V	110	04/91→11/95	1.997	B	M	4	16	4G63		81786
2.0 i 16V 4x4	110	04/91→11/95	1.997	B	M	4	16	4G63		81786

### ECLIPSE II, CABRIO

2.0 Turbo	147	04/94→04/99	1.997	B	M	4	16			81733
2.0 Turbo 4WD	147	04/94→04/99	1.997	B	M	4	16			81733
	157	12/95→04/99	1.997	B	M	4	16			81733
2000 GS 16V	107	12/95→04/99	1.997	B	M	4	16	4G63		81733
2000 GT 16V	157	12/95→04/99	1.997	B	M	4	16			81733

	kw		Cap. cm3	Fuel	Gear	No. of cyl.	No. of valves	Motor code		Short
--	----	--	----------	------	------	-------------	---------------	------------	--	-------

## MITSUBISHI

### GALANT V, STATION WAGON

1.8	85	02/94→08/96	1.834	B	M	4	16	4G93		81731
1.8 GLSi	93	11/92→08/96	1.834	B	M	4	16	4G93	01-1993→	81731

### GRANDIS II

2.0 DI-D	100	09/05→	1.968	D	M	4	16	BSY		81816
	103	02/07→	1.968	D	M	4	16	BWC		81816

### L 200 II

2.5 D	51	11/86→08/96	2.476	D	M	4	8	4D56	→06-1996	81787
2.5 D 4WD	51	12/87→05/93	2.476	D	M	4	8	4D56		81787

### L 200 III

2.5 D	55	06/96→	2.477	D	M	4	8	4D56		81787
-------	----	--------	-------	---	---	---	---	------	--	-------

### L 300 II

2.0	64	11/86→	1.997	B	M	4	8	G63B		81788
	65	11/86→07/88	1.997	B	M	4	8	G63B		81788
	66	11/86→	1.997	B	M	4	8	4G63		81788
	78	06/94→08/95	1.997	B	M	4	16	4G63		81788
	83	06/94→04/00	1.997	B	M	4	16	4G63		81788
	85	07/94→	1.997	B	M	4	16	4G63		81788
2.0 4WD	65	12/86→	1.997	B	M	4	8	4G63		81788
	66	11/86→	1.997	B	M	4	8	4G63		81788
2.0 4x4	82	06/94→05/03	1.997	B	M	4	8	4G63		81788
2.0 GLS	78	06/94→05/96	1.997	B	M	4	16	4G63		81788
2.4	82	11/86→08/97	2.351	B	M	4	8	4G64, G64B		81788
	94	09/97→05/03	2.350	B	M	4	8	4G64		81788
2.4 4WD	80	11/86→12/90	2.351	B	M	4	8	G64B		81788
	82	11/90→	2.351	B	M	4	8	4G64		81788
2.4 4x4	82	11/86→08/97	2.351	B	M	4	8	G64B		81788
2.4 GLX 4x4	82	11/86→08/97	2.351	B	M	4	8	4G64		81788
2.5 D	51	11/86→	2.477	D	M	4	8	4D56		81787
	64	11/94→	2.477	D	M	4	8	4D56T		81787
2.5 TD	64	02/87→05/03	2.477	D	M	4	8	4D56T		81787
2.5 TD 4WD	64	11/88→	2.477	D	M	4	8	4D56T		81787

### L 400 I

2500 TD	64	06/96→	2.477	D	M	4	8	4D56T		81787
2500 TD 4x4	64	09/96→	2.477	D	M	4	8	4D56T		81787

### LANCER SPORTBACK

1.5	80	06/08→	1.499	B	M	4	16	4A91		82049
2.0 DI-D	103	06/08→	1.968	D	M	4	16	BKD		81816

### LANCER V, STATION WAGON, COUPÉ

1.3	55	06/92→02/95	1.298	B	M	4	12	4G13 (12V)		81784
	55	06/92→	1.299	B	M	4	12	4G13 (BJ92-.,12V)		81784
1.6	66	02/94→	1.597	B	M	4	16	4G92		81731
1.6 16V	83	06/92→	1.597	B	M	4	16	4G92		81731
1.6 16V 4WD	83	06/92→	1.597	B	M	4	16	4G92		81731
1.6 GLXi 16V	83	12/92→10/03	1.597	B	M	4	16	4G92	→02-1996	81731
1.6 GLXi 16V 4WD	83	12/92→10/03	1.597	B	M	4	16	4G92	→02-1996	81731



	kW		Cap. cm3	Fuel	Gear	No. of cyl.	No. of valves	Motor code		MAGNETI MARELLI Short
--	----	--	----------	------	------	-------------	---------------	------------	--	-----------------------

## MITSUBISHI

### LANCER VI, STATION WAGON, COUPÉ

1.8 16V	103	06/92→12/93	1.834	B	M	4	16	4G93		81731
1.5 16V	69	12/95→08/03	1.468	B	M	4	16	4G15 (16V)		81784

### LANCER VIII, STATION WAGON

1.5	80	06/08→	1.499	B	M	4	16	4A91		82049
2.0 DI-D	103	01/08→	1.968	D	M	4	16	BKD		81816

### OUTLANDER II

2.0 DI-D	103	02/07→	1.968	D	M	4	16	BSY		81816
2.2 DI-D	115	08/07→	2.179	D	M	4	16	4HN		82068

### PAJERO II

2.4	82	04/91→04/00	2.351	B	M	4	12	4G64		81788
-----	----	-------------	-------	---	---	---	----	------	--	-------

### SANTAMO

2.0 16V	102	05/99→	1.997	B	M	4	16			81786
2.0 16V 4x4	102	05/99→	1.997	B	M	4	16			81786

### SPACE GEAR

2.5 TD	73	05/95→05/00	2.477	D	M	4	8	4D56TD		81787
2.5 TD 4x4	73	05/95→05/00	2.477	D	M	4	8	4D56TD		81787

### SPACE RUNNER I

1.8	85	06/96→08/99	1.834	B	M	4	16	4G93		81731
	90	10/91→08/99	1.834	B	M	4	16	4G93		81731
1.8 4x4	85	06/96→08/99	1.834	B	M	4	16	4G93		81731
	90	10/91→08/99	1.834	B	M	4	16	4G93		81731

### SPACE STAR

1.3 16V	60	09/00→	1.299	B	M	4	16	4G13 (16V)		81784
	61	12/98→	1.299	B	M	4	16	4G13 (16V)		81784
	63	06/98→	1.299	B	M	4	16	4G13 (16V)		81784
1.9 DI-D	75	02/01→	1.870	D	M	4	8	F9Q1		81814
	85	10/02→	1.870	D	M	4	8	F9Q2		81814

### SPACE WAGON II

1.8	90	10/91→10/98	1.834	B	M	4	16	4G93		81731
1.8 4x4	90	10/91→10/98	1.834	B	M	4	16	4G93		81731

## NISSAN

### 100 NX

1.6	66	03/90→10/94	1.597	B	M	4	16	GA16DS		81744
1.6 SR	75	09/93→10/94	1.597	B	M	4	16	GA16DE		81744
2.0	110	10/90→10/94	1.998	B	M	4	16	SR20DE		81736
2.0 GTI	105	03/91→10/94	1.998	B	M	4	16	SR20DE		81736

### 200 SX II

1.8 Turbo	124	07/88→11/93	1.809	B	M	4	16	CA18DET		81740
-----------	-----	-------------	-------	---	---	---	----	---------	--	-------

### 200 SX III

2.0 i 16V	118	10/93→12/99	1.998	B	M	4	16	SR20DE		81736
-----------	-----	-------------	-------	---	---	---	----	--------	--	-------

### ALMERA I, HATCHBACK

1.4	64	09/95→07/00	1.392	B	M	4	16	GA14DE		81744
1.4 GX,LX	55	09/95→07/00	1.392	B	M	4	16	GA14DE		81744
1.4 S,GX,LX	55	09/95→03/00	1.392	B	M	4	16	GA14DE		81744
1.6	73	09/95→07/00	1.597	B	M	4	16	GA16DE		81744

	kw		Cap. cm3	Fuel	Gear	No. of cyl.	No. of valves	Motor code		Short
--	----	--	----------	------	------	-------------	---------------	------------	--	-------

## NISSAN

### ALMERA I, HATCHBACK

1.6 SLX	66	09/95→07/00	1.597	B	M	4	16	GA16DE		81744
1.6 SR,SLX	66	09/95→03/00	1.597	B	M	4	16	GA16DE		81744
2.0 D	55	11/95→07/00	1.974	D	M	4	8	CD20		81736
	55	11/95→03/00	1.974	D	M	4	8	CD20		81745
2.0 GTi	105	07/96→03/00	1.998	B	M	4	16	SR20DE		81736

### ALMERA II, HATCHBACK

1.5	66	03/00→	1.498	B	M	4	16	QG15DE		82028
	72	10/02→	1.497	B	M	4	16	QG15DE		82028
1.5 dCi	60	01/03→	1.461	D	M	4	8	K9K722		81810
1.5 XL	77	03/01→	1.498	B	M	4	16	QG15DE		82028
1.8	84	01/00→	1.769	B	M	4	16	QG18DE		82028
	85	10/02→	1.769	B	M	4	16	QG18DE		82028
2.2 dCi	82	09/03→	2.184	D	M	4	16	YD22DDT		82023
	100	09/03→	2.184	D	M	4	16	YD22DDTi		82023
2.2 Di	81	03/00→	2.184	D	M	4	16	YD22DDT		82023

### ALMERA TINO

1.8	84	08/00→	1.769	B	M	4	16	QG18DE		82028
	85	12/02→	1.769	B	M	4	16	QG18DE		82028
2.0	100	08/00→	1.998	B	A	4	16	SR20DE		81736
2.2 dCi	82	09/03→	2.184	D	M	4	16	YD22DDT		82023
	100	09/03→	2.184	D	M	4	16	YD22DDTi		82023
2.2 Di	84	08/00→	2.184	D	M	4	16	YD22DDTi		82023

### CHERRY II, HATCHBACK

1.3	44	05/82→10/86	1.269	B	M	4	8	E13	M: 310	11706T
1.5	55	11/83→10/86	1.488	B	M	4	8	E15S	M: 310	11706T

### CUBE

1.5 dCi	78	03/10→	1.491	D	M	4	8			82098
---------	----	--------	-------	---	---	---	---	--	--	-------

### JUKE

1.5 dCi	81	06/10→	1.461	D	M	4	16			82098
---------	----	--------	-------	---	---	---	----	--	--	-------

### KUBISTAR

1.2	44	08/03→	1.149	B	M	4	8	D7F764		81762
1.2 16V	55	04/06→	1.149	B	M	4	16	D4F712		81820
1.5 dCi	48	08/03→	1.461	D	M	4	8	K9K704		81810
	60	08/03→	1.461	D	M	4	8	K9K722		81810
1.6 16V	70	08/03→	1.598	B	M	4	16	K4M752		81806

### MICRA I (K10)

1.0	37	12/82→12/89	988	B	M	4	8	MA10S	→M: 945.692	81734
	40	12/82→05/89	988	B	M	4	8	MA10S	→M: 945.692	81734
	43	12/82→05/91	988	B	M	4	8		→12-1988, →M: 945.692	81734
	43	12/82→05/91	988	B	M	4	8		01-1989→, M→: 945.693	81743
1.2	40	07/86→07/92	1.235	B	M	4	8	MA12S	→12-1988, →M: 945.692	81734
	40	07/86→07/92	1.235	B	M	4	8	MA12S	01-1989→, M→: 945.693	81743
	44	07/86→07/92	1.235	B	M	4	8	MA12S	→12-1988, →M: 945.692	81734
	44	07/86→07/92	1.235	B	M	4	8	MA12S	01-1989→, M→: 945.693	81743
1.0 i 16V	40	08/92→09/00	998	B	M	4	16	CG10DE		81742
	44	09/00→02/03	998	B	M	4	16	CG10DE		81742

	kw		Cap. cm3	Fuel	Gear	No. of cyl.	No. of valves	Motor code		MAGNETI MARELLI Short
--	----	--	----------	------	------	-------------	---------------	------------	--	-----------------------

## NISSAN

### MICRA I (K10)

1.3 i 16V	55	08/92→09/00	1.275	B	M	4	16	CG13DE		81742
1.4 i 16V	60	09/00→02/03	1.348	B	M	4	16	CGA3DE		81742
1.5 D	42	02/98→02/03	1.527	D	M	4	8	TD15		81513

### MICRA III (K12), MICRA C+C

1.0 16V	48	01/03→	998	B	M	4	16	CG10DE		82014
1.2 16V	48	01/03→	1.240	B	M	4	16	CR12DE		82014
	59	01/03→	1.240	B	M	4	16	CR12DE		82014
1.4 16V	65	01/03→	1.386	B	M	4	16	CR14DE		82014
1.5 dCi	48	01/03→	1.461	D	M	4	8	K9K704		81810
	50	06/05→	1.461	D	M	4	8			81810
	60	09/03→	1.461	D	M	4	8	K9K722		81810
	63	06/05→	1.461	D	M	4	8			81810
1.6 160 SR	81	08/05→	1.598	B	M	4	16	HR16DE		82014
160 SR	81	05/05→	1.598	B	M	4	16	HR16DE		82014

### NOTE

1.4	65	03/06→	1.386	B	M	4	16	CR14DE		82014
1.5 dCi	50	03/06→	1.461	D	M	4	8	K9K700		81810
	63	03/06→	1.461	D	M	4	8	K9K276		81810
	76	07/08→	1.461	D	M	4	8			81810

### PRIMERA I

1.6	66	06/90→01/96	1.597	B	M	4	16	GA16DS		81744
	71	06/90→01/96	1.597	B	M	4	16	GA16DS		81744
	75	06/93→01/96	1.597	B	M	4	16	GA16DE		81744
1.6 i	66	07/90→03/98	1.597	B	M	4	16	GA16DS		81744
	75	03/94→03/98	1.597	B	M	4	16	GA16DE		81744
2.0	105	06/90→04/93	1.998	B	M	4	16	SR20DE		81736
	110	06/90→01/98	1.998	B	M	4	16	SR20DE		81736
2.0 16V	85	06/90→01/96	1.998	B	M	4	16	SR20DI		81736
2.0 16V 4x4	85	04/91→06/96	1.998	B	M	4	16	SR20DI		81736
2.0 D	55	07/90→01/96	1.974	D	M	4	8	CD20		81745
2.0 GT	110	06/90→01/96	1.998	B	M	4	16	SR20DE		81736
2.0 GT 4x4	105	03/91→04/93	1.998	B	M	4	16	SR20DE		81736
2.0 i	85	07/90→03/98	1.998	B	M	4	16	SR20DI		81736
	92	01/95→06/96	1.998	B	M	4	16	SR20DE		81736

### PRIMERA II

1.6 16V	66	09/96→07/02	1.597	B	M	4	16	GA16DE		81744
	73	09/96→07/02	1.597	B	M	4	16	GA16DE		81744
	78	06/96→07/02	1.597	B	M	4	16	QG16DE		81744
1.6 Visia	80	04/98→12/01	1.597	B	M	4	16	QG16DE		81744
1.8 16V	84	08/99→07/02	1.769	B	M	4	16	QG18DE		82028
2.0 16V	85	09/96→07/02	1.998	B	M	4	16	SR20De		81736
	96	09/96→07/02	1.998	B	M	4	16	SR20DE		81736
	103	08/99→07/02	1.998	B	M	4	16	SR20DE		81736
	110	09/96→07/02	1.998	B	M	4	16	SR20DE		81736
2.0 TD	66	09/96→07/02	1.974	D	M	4	8	CD20T		81745



kw



Cap. cm3

Fuel

Gear

No. of cyl.

No. of valves

Motor code



MAGNETI MARELLI  
Short

## NISSAN

### PRIMERA III

1.6	78	03/02→	1.597	B	M	4	16	QG16DE		82028
1.6 Visia	80	01/02→	1.597	B	M	4	16	QG16DE		82028
1.8	85	03/02→	1.769	B	M	4	16	QG18DE		82028
1.9 dCi	88	04/03→	1.870	D	M	4	8			81868
2.2 dCi	102	04/03→	2.184	D	M	4	16	YD22DDT		82023
2.2 Di	93	03/02→	2.184	D	M	4	16	YD22DDT		82023

### QASHQAI

1.5 dCi	76	07/08→	1.461	D	M	4	16			81810
	78	02/07→	1.461	D	M	4	8			81810
2.0 dCi	110	02/07→	1.995	D	M	4	16	M1D		82069
2.0 dCi 4 ruote motrici	110	02/07→	1.995	D	M	4	16	M1D		82069

### SERENA I

1.6	75	10/94→08/00	1.597	B	M	4	16	GA16DE		81744
1.6 16V	71	02/93→	1.597	B	M	4	16	GA16DE		81744
2.0 16V	93	11/92→	1.998	B	M	4	16	SR20DE		81736
2.0 D	49	11/92→	1.952	D	M	4	8	LD20		82054
2.3 D	55	01/95→	2.283	D	M	4	8	LD23		82053

### SILVIA II

2.0 GP	107	04/84→09/88	1.991	B	M	4	8	FJ20E		81740
--------	-----	-------------	-------	---	---	---	---	-------	--	-------

### SUNNY II

1.6	88	02/87→10/88	1.597	B	M	4	16	GA16DE		81744
-----	----	-------------	-------	---	---	---	----	--------	--	-------

### SUNNY III

1.4	60	10/90→06/95	1.392	B	M	4	16	GA14DS		81744
1.4 i	55	10/90→05/95	1.392	B	M	4	16	GA14DE, GA14DS		81744
1.4 i 16V	64	10/90→06/95	1.392	B	M	4	16	GA14DE		81744
1.6 16V 4x4	66	11/90→05/95	1.597	B	M	4	16	GA16DS		81744
1.6 i	66	10/90→03/00	1.597	B	M	4	16	GA16DE, GA16DS		81744
1.6 i 16V	66	10/92→03/00	1.597	B	M	4	16	GA16DE		81744
	75	10/92→05/95	1.597	B	M	4	16	GA16DE		81744
1.6 i 16V 4WD	66	10/90→05/95	1.597	B	M	4	16	GA16DS		81744
1.6 i 16V 4x4	75	10/92→03/00	1.597	B	M	4	16	GA16DE		81744
1.6 L	75	11/92→04/96	1.597	B	M	4	16	GA16DE		81744
1.6 SR 4x4	66	01/92→06/95	1.598	B	M	4	16	GA16DEL		81744
2.0 D	55	10/90→03/00	1.974	D	M	4	8	CD20		81745
2.0 GTI 16V	105	10/90→05/95	1.998	B	M	4	16	SR20DE		81736
2.0 GTI-R 4x4	162	10/90→05/95	1.998	B	M	4	16	SR20DET		81736
2.0 i 16V	105	10/90→05/95	1.998	B	M	4	16	SR20DE		81736

### X-TRAIL I

2.2 DCi	84	10/04→	2.184	D	M	4	16	YD22DDTi		82023
	100	12/03→	2.184	D	M	4	16	YD22DDTi		82023
2.2 dCi 4x4	100	12/03→	2.184	D	M	4	16	YD22DDTi		82023
2.2 DCi FWD	84	06/01→09/03	2.184	D	M	4	16	YD22DDTi		82023
2.2 Di 4x4	84	07/01→	2.184	D	M	4	16	YD22ETI		82023

	kW		Cap. cm3	Fuel	Gear	No. of cyl.	No. of valves	Motor code		MAGNETI MARELLI Short
--	----	--	----------	------	------	-------------	---------------	------------	--	-----------------------

<b>NISSAN</b>										
<b>X-TRAIL II</b>										
2.0 dCi	110	06/07→	1.995	D	M	4	16	M9R		82069
	127	06/07→	1.995	D	M	4	16	M9R760		82069
2.0 dCi FWD	110	06/07→	1.995	D	M	4	16			82069

<b>NISSAN</b>										
<b>INTERSTAR</b>										
dCi 80	60	07/02→	1.870	D	M	4	8	F9Q772		81814
dCi 90	66	07/02→	2.188	D	M	4	16	G9T722		81855
<b>PRIMASTAR</b>										
2.0	88	03/01→	1.998	B	M	4	16	F4R720, F4R722		81814
dCi 80	60	03/01→	1.870	D	M	4	8	F9Q762		81814
dCi 90	66	09/06→	1.985	D	M	4	8			82069
dCi 100	74	03/01→	1.870	D	M	4	8	F9Q760		81814
dCi 120	84	09/06→	1.995	D	M	4	8			82069
dCi 140	99	07/03→	2.463	D	M	4	16	G9U730		81855

<b>VANETTE II</b>										
2.0 D	47	10/86→12/95	1.952	D	M	4	8	LD20		82054
	49	10/86→12/95	1.952	D	M	4	8	LD20, LD20II		82054

<b>VANETTE III, CARGO</b>										
1.6 i	71	01/95→	1.597	B	M	4	16	GA16DE		81744
	72	01/96→	1.597	B	M	4	16	GA16DE		81744
2.0 D	49	01/95→	1.952	D	M	4	8	LD20		82054
2.3 D	55	01/95→	2.283	D	M	4	8	LD23		82053

<b>OPEL</b>										
<b>AGILA A</b>										
1.0	44	08/03→	998	B	M	3	12	Z10XEP		82011
1.0 12V	43	09/00→	973	B	M	3	12	Z10XE		81749
1.2 16V	55	09/00→	1.199	B	M	4	16	Z12XE		81749
1.2 16V Twinport	59	07/04→	1.229	B	M	4	16	Z12XEP		82011
1.3 CDTI	51	08/03→	1.248	D	M	4	16	Z13DT		81862
<b>AGILA B</b>										
1.3 CDTI	55	09/07→	1.248	D	M	4	16	Z13DTJ		81862
<b>ANTARA</b>										
2.4	104	05/06→	2.405	B	M	4	16	Z24XED		81550
2.4 FWD	103	09/08→	2.405	B	M	4	16	Z24XE		81550
<b>ASTRA F CLASSIC</b>										
1.4 Comfort	66	09/03→01/05	1.364	B	M	4	16	Z14XEP		82011
1.4 i	44	01/98→01/05	1.389	B	M	4	8	X14NZ		81549
	66	03/98→08/00	1.389	B	M	4	16	X14XE		82005
1.6 i	55	01/98→01/05	1.598	B	M	4	8	X16SZR		81549
1.6 i 16V	74	01/98→01/05	1.598	B	M	4	16	X16XEL		82005

	kw		Cap. cm3	Fuel	Gear	No. of cyl.	No. of valves	Motor code		Short
--	----	--	----------	------	------	-------------	---------------	------------	--	-------

## OPEL

### ASTRA F, STATION WAGON, CABRIO

1.4	55	09/91→09/93	1.389	B	M	4	8	14NV		81549
	60	09/92→09/98	1.389	B	M	4	8	14SE		81549
1.4 i	44	09/91→01/99	1.389	B	M	4	8	C14NZ		81549
1.4 i 16V	66	01/96→03/01	1.389	B	M	4	16	X14XE		82005
1.4 Si	60	03/92→03/01	1.389	B	M	4	8	C14SE		81549
1.6	55	09/95→09/98	1.598	B	M	4	8	16LZ2, 16NZR		81551
1.6 i	52	02/93→08/96	1.598	B	M	4	8	X16SZ		81549
	55	09/91→03/01	1.598	B	M	4	8	C16NZ, X16SZR		81549
1.6 i 16V	74	08/94→09/98	1.598	B	M	4	16	X16XEL		82005
1.6 Si	74	03/92→12/94	1.598	B	M	4	8	C16SE		81549
1.7 D	42	12/91→09/92	1.700	D	M	4	8	17D		81605
	44	07/92→01/99	1.700	D	M	4	8	17DR	01-1993→, M→: 14.363.652	81550
	44	07/92→01/99	1.700	D	M	4	8	17DR	→12-1992, →M: 14.363.651	81605
1.7 TD	50	08/94→01/99	1.700	D	M	4	8	X17DTL		81550
1.7 TDS	60	12/91→09/98	1.686	D	M	4	8	17DT (TC4EE1), X17DT (TC4EE1)	→12-1992, →M: 855.805	81687
	60	12/91→09/98	1.686	D	M	4	8	17DT (TC4EE1), X17DT (TC4EE1)	01-1993→, M→: 855.806	81746
1.8	85	11/91→07/93	1.796	B	M	4	8	18SE		81550
1.8 i	66	09/91→09/98	1.796	B	M	4	8	C18NZ	11-1992→, M→: 14.254.439	81551
	66	09/91→09/98	1.796	B	M	4	8	C18NZ	→10-1992, →M: 14.254.438	81606
1.8 i 16V	85	07/94→03/01	1.799	B	M	4	16	C18XEL, X18XE		81550
	92	06/93→01/98	1.799	B	M	4	16	C18XE		81550
2.0 GSI 16V	110	09/91→01/98	1.998	B	M	4	16	C20XE	01-1993→, M→: 14.142.840	81550
	110	09/91→01/98	1.998	B	M	4	16	C20XE	→12-1992, →M: 14.142.839	81680
2.0 i	85	09/91→09/98	1.998	B	M	4	8	C20NE	01-1992→, 11-1992→, M→: 14.608.701	81551
	85	09/91→09/98	1.998	B	M	4	8	C20NE	→10-1992, →M: 14.608.700	81606
2.0 i 16V	100	02/95→09/98	1.998	B	M	4	16	X20XE		81550
	110	03/93→01/98	1.998	B	M	4	16	C20XE	M→: 14.142.840	81550

### ASTRA G, STATION WAGON, CABRIO

1.2 16V	48	02/98→09/00	1.199	B	M	4	16	X12XE		81749
	55	09/00→01/05	1.199	B	M	4	16	Z12XE		81749
1.4 16V	66	02/98→01/05	1.389	B	M	4	16	X14XE, Z14XE	09-2000→, M→: 20U75999, M→: 02MV7225, M→: 20U75999	81817
	66	09/98→01/05	1.389	B	M	4	16	X14XE, Z14XE	09-2000→	81818
	66	02/98→01/05	1.389	B	M	4	16	X14XE, Z14XE	→08-2000, →M: 20U75998, →M: 02MV7224, →M: 20U75998	82005

	kw		Cap. cm3	Fuel	Gear	No. of cyl.	No. of valves	Motor code		Short
--	----	--	----------	------	------	-------------	---------------	------------	--	-------

**OPEL**
**ASTRA G, STATION WAGON, CABRIO**

1.6	55	02/98→09/00	1.598	B	M	4	16	X16SZR	09-1996→	81549
	62	09/00→04/05	1.598	B	M	4	8	Z16SE	→M: 02MZ5253, →M: 20U75998	81549
	62	09/00→04/05	1.598	B	M	4	8	Z16SE	M→: 02MZ5254, M→: 20U75999	81818
	76	12/02→01/05	1.598	B	M	4	16	Z16XEP		81818
	76	12/02→10/05	1.598	B	M	4	16	Z16XEP		82083
1.6 16V	74	02/98→10/05	1.598	B	M	4	16	X16XEL, Z16XE	M→: 02MV7225, M→: 20U75999	81817
	74	09/98→01/05	1.598	B	M	4	16	X16XEL, Z16XE	09-2000→	81818
	74	02/98→10/05	1.598	B	M	4	16	X16XEL, Z16XE	→M: 02MV7224, →M: 20U75998	82005
	76	03/00→05/05	1.598	B	M	4	16	Z16XEP		82083
1.6 CNG	71	03/03→07/04	1.598	G	M	4	16	Z16YNG		81817
1.7 CDTI	59	04/03→01/05	1.686	D	M	4	16	Z17DTL		81836
1.7 DTI 16V	55	02/00→01/05	1.686	D	M	4	16	Y17DT	→08-2000, →09-2000, →M: 073532	81746
	55	02/00→01/05	1.686	D	M	4	16	Y17DT	09-2000→, M→: 073533	81836
1.7 TD	50	02/98→04/05	1.700	D	M	4	8	X17DTL		81550
	50	09/98→08/00	1.700	D	M	4	8	X17DTL		81687
1.8 16V	85	09/98→09/00	1.796	B	M	4	16	X18XE1		81550
	85	02/98→10/00	1.796	B	M	4	16	X18XE1		81751
	92	09/00→10/05	1.796	B	M	4	16	Z18XE		81751
2.0 16V	100	02/98→01/05	1.998	B	M	4	16	X20XEV	M→: 14.142.840	81550
	100	09/98→01/05	1.998	B	M	4	16	X20XEV	→M: 14.142.839	81680
2.0 16V OPC	118	11/99→09/02	1.998	B	M	4	16	X20XER		81550
2.0 16V Turbo	140	09/00→08/01	1.998	B	M	4	16	Z20LET		81550
	141	08/01→05/05	1.998	B	M	4	16	Z20LET		81550
	147	11/02→10/05	1.998	B	M	4	16	Z20LER		81550
2.0 DI	60	02/98→04/05	1.995	D	M	4	16	X20DTL, Y20DTL		81747
2.0 DTI 16V	74	08/99→01/05	1.995	D	M	4	16	X20DTH, Y20DTH		81747
2.0 OPC	141	03/02→10/05	1.998	B	M	4	16	Z20LET		81550
	147	11/02→01/05	1.998	B	M	4	16	Z20LER, Z20LET		81550
2.2 16V	108	09/00→10/05	2.198	B	M	4	16	Z22SE		81812
2.2 DTI	92	09/02→10/05	2.172	D	M	4	16	Y22DTR		81747

**ASTRA H, STATION WAGON, CABRIO, HTC, TWINTOP**

1.2	48	10/06→	1.199	B	M	4	16	X12XE		82011
	59	08/05→	1.229	B	M	4	16	Z12XEP		82011
1.3 CDTI	66	04/05→	1.248	D	M	4	16	Z13DTH		81862
1.4	59	04/04→10/04	1.364	B	M	4	16	Z14XEL		82011
	66	03/04→	1.364	B	M	4	16	Z14XEP		82011
1.6	77	03/04→	1.598	B	M	4	16	Z16XEP		82083
	85	02/07→	1.598	B	M	4	8	Z16XER		82083
1.6	85	12/06→	1.598	B	M	4	16	Z16XER		82083
1.6 CNG	69	11/05→	1.598		M	4	16	Z16YNG		82083
	69	11/05→	1.598	B	M	4	16	Z16YNG		82083

	kw		Cap. cm3	Fuel	Gear	No. of cyl.	No. of valves	Motor code		Short
--	----	--	----------	------	------	-------------	---------------	------------	--	-------

## OPEL

### ASTRA H, STATION WAGON, CABRIO, HTC, TWINTOP

1.6 Turbo	132	02/07→	1.598	B	M	4	16	Z16LET		82083
1.7 CDTI	59	03/04→	1.686	D	M	4	16	Z17DTL		81836
	74	03/04→	1.686	D	M	4	16	Z17DTH	→T: 1874032	81836
	81	02/07→	1.686	D	M	4	16	A17DTJ, Z17DTJ		81836
	92	02/07→	1.686	D	M	4	16	A17DTR, Z17DTR		81836
1.8	92	03/04→	1.796	B	M	4	16	Z18XE		82083
	103	08/05→	1.796	B	M	4	16	Z18XER		82083
1.9 CDTI	74	01/06→	1.910	D	M	4	16	Z19DTL		81352
	74	09/05→	1.910	D	M	4	8	Z19DT		81352
	88	06/04→	1.910	D	M	4	8	Z19DT		81352
	103	12/04→	1.910	D	M	4	16			81872
	110	09/04→	1.910	D	M	4	16	Z19DTH		81872
1.9 CDTI 16V	88	04/04→	1.910	D	M	4	16	Z19DTJ		81872
2.0 Turbo	125	03/04→	1.998	B	M	4	16	Z20LEL		81550
	147	09/04→	1.998	B	M	4	16	Z20LER		81550
	177	03/05→	1.998	B	M	4	16	Z20LEH		81550

### ASTRA J

1.3 CDTI	70	10/10→	1.248	D	M	4	16			81862
1.3 CDTI ecoFLEX	70	12/09→	1.248	D	M	4	16	A13DTE		81862
1.6	85	12/09→	1.598	B	M	4	16	A16XER		82083
1.6 Turbo	132	12/09→	1.598	B	M	4	16	A16LET		82083
2.0 CDTI	118	12/09→	1.956	D	M	4	16	A20DTH		81872

### CALIBRA

2.0 i	85	06/90→07/97	1.998	B	M	4	8	C20NE	01-1993→, M→: 14.608.701	81551
	85	06/90→07/97	1.998	B	M	4	8	C20NE	→12-1992, →M: 14.608.700	81606
2.0 i 16V	100	02/94→07/97	1.998	B	M	4	16	X20XEV	M→: 14.142.840	81550
	110	06/90→02/94	1.998	B	M	4	16	C20XE	01-1993→, M→: 14.142.839	81550
	110	06/90→02/94	1.998	B	M	4	16	C20XE	→12-1992, →M: 14.142.838	81680
2.0 i 16V 4x4	100	02/94→07/97	1.998	B	M	4	16	X20XEV	M→: 14.142.840	81550
	110	06/90→02/94	1.998	B	M	4	16	C20XE	01-1993→, M→: 14.142.839	81550
	110	06/90→02/94	1.998	B	M	4	16	C20XE	→12-1992, →M: 14.142.838	81680
2.0 i 4x4	85	06/90→07/97	1.998	B	M	4	8	C20NE	01-1993→, M→: 14.608.701	81551
	85	06/90→07/97	1.998	B	M	4	8	C20NE	→12-1992, →M: 14.608.700	81606
2.0 i Turbo 4x4	150	03/92→07/97	1.998	B	M	4	16	C20LET	01-1993→, M→: 14.002.935	81550
	150	03/92→07/97	1.998	B	M	4	16	C20LET	→12-1992, →M: 14.002.934	81680
2.5 i V6	125	04/93→07/97	2.498	B	M	6	24	C25XE, X25XE		81846



	kw		Cap. cm3	Fuel	Gear	No. of cyl.	No. of valves	Motor code		MAGNETI MARELLI Short
--	----	--	----------	------	------	-------------	---------------	------------	--	-----------------------

## OPEL

### COMBO I

1.2	33	07/94→10/01	1.195	B	M	4	8	C12NZ, X12SZ		81549
1.4	44	07/94→10/01	1.389	B	M	4	8	C14NZ, X14SZ	09-1995→, →08-1996	81549
	60	07/94→10/01	1.389	B	M	4	8	C14SE		81549
1.7 D	44	07/94→10/01	1.686	D	M	4	8	17D (4EE1), X17D (4EE1)	→M: 877.697	81687
	44	07/94→10/01	1.686	D	M	4	8	17D (4EE1), X17D (4EE1)	M→: 877.698	81746

### COMBO II

1.3 CDTI 16V	51	10/04→	1.248	D	M	4	16	Z13DT		81862
	55	10/05→	1.248	D	M	4	16	Z13DTJ		81862
1.4	66	10/04→	1.364	B	M	4	16	Z14XEP		81836
1.4 16V	66	08/05→	1.364	B	M	4	16	Z14XEP		82011
1.6	62	08/01→	1.598	B	M	4	8	Z16SE		81818
	64	10/01→	1.598	B	M	4	8	Z16SE	M: Z16SE	81818
1.6 16V	69	06/06→	1.598		M	4	16	Z16YNG		81817
	69	06/06→	1.598	M	M	4	16	Z16YNG		81817
1.7 CDTI 16V	74	12/04→	1.686	D	M	4	16	Z17DTH		81836
1.7 DI 16V	48	10/01→	1.686	D	M	4	16	Y17DTL		81836
1.7 DTI 16V	55	10/01→	1.686	D	M	4	16	Y17DT		81836
	74	12/04→	1.686	D	M	4	16	Z17DTH		81836

### CORSA B, STATION WAGON, VAN

1.0 i 12V	40	11/96→09/00	973	B	M	3	12	X10XE		81749
1.2 i	33	03/93→09/00	1.195	B	M	4	8	12NZ, C12NZ, X12SZ		81549
1.2 i 16V	48	03/98→09/00	1.199	B	M	4	16	X12XE		81749
1.4	54	04/93→08/94	1.389	B	M	4	8			81549
1.4 i	44	03/93→09/00	1.389	B	M	4	8	C14NZ, X14SZ		81549
1.4 i 16V	63	08/97→09/00	1.389	B	M	4	16	C14SEL		82005
	66	09/94→09/00	1.389	B	M	4	16	X14XE		82005
1.4 Si	60	03/93→09/00	1.389	B	M	4	8	C14SE		81549
1.5 D	37	03/93→09/00	1.488	D	M	4	8	15D (4EC1)	→08-1994, →M: 877.697	81685
	37	03/93→09/00	1.488	D	M	4	8	15D (4EC1)	09-1994→, M→: 877.698	81748
1.5 TD	49	03/93→09/00	1.488	D	M	4	8	15DT (T4EC1), X15DT (T4EC1)	→M: 877.697	81685
	49	03/93→09/00	1.488	D	M	4	8	15DT (T4EC1), X15DT (T4EC1)	→08-1994, M→: 877.698, →M: 076.350	81748
	49	03/93→09/00	1.488	D	M	4	8	15DT (T4EC1), X15DT (T4EC1)	09-1994→, M→: 076.351	81750
1.6 GSI 16V	80	03/93→09/00	1.598	B	M	4	16	C16XE		82005
1.6 i 16V	74	08/97→09/00	1.598	B	M	4	16	C16SEL		82005
	78	09/94→09/00	1.598	B	M	4	16	X16XE		82005
1.7 D	44	02/96→09/00	1.686	D	M	4	8	17D (4EE1), X17D (4EE1)	→M: 877.697	81687
	44	02/96→09/00	1.686	D	M	4	8	17D (4EE1), X17D (4EE1)	M→: 877.698	81746
1.7 DTi	55	08/01→	1.686	D	M	4	16	Y17DT		81836

### CORSA C, VAN

1.0	43	09/00→	973	B	M	3	12	Z10XE		81749
	44	06/03→	998	B	M	3	12	Z10XEP		82011
1.2	55	09/00→	1.199	B	AM	4	16	Z12XE		81749
	59	07/05→	1.229	B	M	4	16	Z12XEP		82011
1.2 16V	55	09/00→	1.199	B	M	4	16	Z12XE		81749
1.2 Twinport	59	07/04→	1.229	B	M	4	16	Z12XEP		82011

	kw		Cap. cm3	Fuel	Gear	No. of cyl.	No. of valves	Motor code		Short
--	----	--	----------	------	------	-------------	---------------	------------	--	-------

## OPEL

### CORSA C, VAN

1.3 CDTI	51	06/03→	1.248	D	M	4	16	Z13DT		81862
1.3 CDTI 16V	51	08/05→	1.248	D	M	4	16	Z13DT		81862
1.4	66	08/03→	1.364	B	M	4	16	Z14XEP		82011
	66	09/00→	1.389	B	M	4	16	Z14XE		81817
1.4 Twinport	66	06/03→	1.364	B	M	4	16	Z14XEP		82011
1.6	71	08/05→07/06	1.598	B	M	4	16			81818
1.6 X	71	08/05→	1.598	B	M	4	16			81818
1.7 CDTI	74	06/03→	1.686	D	M	4	16	Z17DTH		81836
1.7 DI	48	09/00→	1.686	D	M	4	16	Y17DTL		81836
1.7 DI 16V	48	09/00→	1.686	D	M	4	16	Y17DTL		81836
1.7 DTI	55	09/00→	1.686	D	M	4	16	Y17DT		81836
1.7 DTI 16V	55	09/00→	1.686	D	M	4	16	Y17DT		81836
1.8	92	09/00→	1.796	B	M	4	16	Z18XE		81751

### CORSA D

1.0	44	07/06→	998	B	M	3	12	Z10XEP		82011
1.2	59	07/06→	1.229	B	M	4	16	Z12XEP		82011
1.2 ecoFLEX	57	09/09→	1.229	BF	M	4	16	Z12XEP		82011
1.3 CDTI	55	07/06→	1.248	D	M	4	16	Z13DTJ		81862
	66	07/06→	1.248	D	M	4	16	Z13DTH		81862
	70	06/10→	1.248	D	M	4	16	A13DTR, Z13DTE		81862
1.4	66	07/06→	1.364	B	M	4	16	Z14XEP		82011
1.6 Turbo	110	02/07→	1.598	B	M	4	16	Z16LEL		82083
	141	02/07→	1.598	B	M	4	16	Z16LER		82083
1.7 CDTI	92	07/06→	1.686	D	M	4	16	Z17DTR	→T: 1874032	81836
	96	06/10→	1.686	D	M	4	16	A17DTS	→T: 1874032	81836

### FRONTERA A

2.0 i	85	03/92→10/98	1.998	B	M	4	8	C20NE, X20SE	M: X20SE	81551
	85	03/92→10/98	1.998	B	M	4	8	C20NE, X20SE	M: C20NE	81606
2.2 i	100	03/95→10/98	2.198	B	M	4	16	X22XE		81550
2.3 TD	74	03/92→10/98	2.260	D	M	4	8	Z3DTR		81682
2.4 i	92	03/92→10/98	2.410	B	M	4	8	C24NE		81682
2.5 TDS	85	09/96→10/98	2.499	D	M	4	8	Z5TDS (VM41B)	(-)COP	81362

### FRONTERA B

2.2 i	100	10/98→	2.198	B	M	4	16	X22SE, Y22SE		81550
2.2 DTI	85	10/98→09/02	2.171	D	M	4	16	X22DTH, Y22DTH		81747
	88	09/02→	2.171	D	M	4	16	Y22DTH		81747
3.2 i	151	10/98→	3.165	B	M	6	24	6VD1, Y32NE		81848

### INSIGNA, STATION WAGON

1.6	85	07/08→	1.598	B	M	4	16	A16XER		82083
1.6 Turbo	132	07/08→	1.598	B	M	4	16	A16LET		82083
1.8	103	07/08→	1.796	B	M	4	16	A18XER		82083
2.0 Biturbo CDTI 4x4	140	07/08→	1.956	D	M	4	16	A20DTR		81872
2.0 CDTI	81	07/08→	1.956	D	M	4	16	A20DTC		81872
	96	07/08→	1.956	D	M	4	16	A20DTJ		81872
	118	07/08→	1.956	D	M	4	16	A20DTH		81872
	140	07/08→	1.956	D	M	4	16	A20DTR		81872

	kW		Cap. cm3	Fuel	Gear	No. of cyl.	No. of valves	Motor code		Short
--	----	--	----------	------	------	-------------	---------------	------------	--	-------

## OPEL

### INSIGNA, STATION WAGON

2.0 CDTI 4x4	118	06/10→	1.956	D	M	4	16	A20DTH		81872
2.0 Turbo	162	07/08→	1.998	B	M	4	16	A20NHT		81812
2.0 Turbo 4x4	162	07/08→	1.998	B	M	4	16	A20NHT		81812

### KADETT E, STATION WAGON, VAN

1.2	40	09/84→07/86	1.196	B	M	4	8	12SC	M: OHV	81544
	40	09/84→07/86	1.196	B	M	4	8	12SC	M: OHC	81549
1.3 i Cat.	44	09/85→08/91	1.297	B	M	4	8	C13N		81543
1.3 N	44	09/84→08/91	1.297	B	M	4	8	13N, 13NB		81543
1.3 S	55	09/84→02/93	1.297	B	M	4	8	13S		81543
1.4 i	44	01/90→07/94	1.389	B	M	4	8	C14NZ	M→: 19.311.738	81549
	44	01/90→07/94	1.389	B	M	4	8	C14NZ	→M: 19.311.737	81681
1.4 S	55	07/89→02/93	1.389	B	M	4	8	14NV		81549
	60	09/89→08/91	1.389	B	M	4	8	C14SE	M→: 19.311.738	81549
	60	09/89→08/91	1.389	B	M	4	8	C14SE	→M: 19.311.737	81681
1.5 TD	53	07/88→08/91	1.488	D	M	4	8	15DT (T4EC1)	→M: 804.794	81684
	53	07/88→08/91	1.488	D	M	4	8	15DT (T4EC1)	M→: 804.795	81685
1.6	60	09/86→12/91	1.598	B	M	4	8	16SV	M→: 19.311.738	81549
	60	09/86→12/91	1.598	B	M	4	8	16SV	→M: 19.311.737	81681
1.6 D	40	08/84→12/89	1.598	D	M	4	8	16D, 16DA	→12-1986, →C: 14.503.756, →C: 14.478.630, →C: 14.503.756	81545
	40	08/84→12/89	1.598	D	M	4	8	16D, 16DA	01-1987→, C→: 14.503.757, C→: 14.478.631, C→: 14.503.757, →C: 14.478.631	81605
1.6 i	55	09/86→07/94	1.598	B	M	4	8	C16NZ, E16NZ	M→: 19.311.738	81549
	55	09/86→07/94	1.598	B	M	4	8	C16NZ, E16NZ	→M: 19.311.737	81681
	60	07/89→02/93	1.598	B	M	4	8	16SV	M→: 19.311.738	81549
	60	07/89→02/93	1.598	B	M	4	8	16SV	→M: 19.311.737	81681
1.6 i Cat.	55	09/86→02/93	1.598	B	M	4	8	C16LZ, C16NZ	M→: 19.311.738	81549
	55	09/86→02/93	1.598	B	M	4	8	C16LZ, C16NZ	→M: 19.311.737	81681
1.6 S	60	09/86→08/91	1.598	B	M	4	8	16SV	M→: 19.311.738	81549
	60	09/86→08/91	1.598	B	M	4	8	16SV	→M: 19.311.737	81681
	66	09/84→08/86	1.598	B	M	4	8	16SH		81548
1.7 D	42	08/88→07/94	1.700	D	M	4	8	17D	09-1989→, →05-1992	81605
	44	07/92→07/94	1.700	D	M	4	8	17DR		81605
1.8	84	09/87→08/90	1.796	B	M	4	8	18E	→08-1988, →M: 14.237.769	81548
	84	09/87→08/90	1.796	B	M	4	8	18E	09-1988→, M→: 14.237.770	81606
1.8 E	74	10/85→08/86	1.796	B	M	4	8	C18NE	→M: 14.237.769	81548
1.8 GSI	85	09/84→08/86	1.796	B	M	4	8	18E		81548
1.8 i	66	08/84→09/92	1.796	B	M	4	8	C18NT, C18NZ	→C: 14.237.769	81548
	66	06/85→08/91	1.796	B	M	4	8	C18NT, C18NZ, S18NV		81606
	74	10/85→08/86	1.796	B	M	4	8	C18NE		81548



kW



Cap. cm3

Fuel

Gear

No. of cyl.

No. of valves

Motor code



MAGNETI MARELLI  
Short

## OPEL

### INSIGNA, STATION WAGON

1.8 i	85	09/84→08/86	1.796	B	M	4	8	18E	→M: 14.237.769	81548
	85	09/84→08/86	1.796	B	M	4	8	18E	M→: 14.237.770	81606
1.8 S	62	09/87→08/91	1.796	B	M	4	8	E18NV, S18NV		81606
	62	09/87→08/91	1.798	B	M	4	8	E18NV		81606
2.0 GSI	85	09/86→08/91	1.998	B	M	4	8	20NE		81606
	95	09/86→08/91	1.998	B	M	4	8	20SEH		81606
2.0 GSI 16V	110	03/88→08/91	1.998	B	M	4	16	20XEJ		81680
	115	12/87→08/91	1.998	B	M	4	16	20XE		81680
2.0 GSI 16V Cat.	110	03/88→08/91	1.998	B	M	4	16	C20XE		81680
2.0 GSI Cat.	85	09/86→08/91	1.998	B	M	4	8	C20NE		81606
2.0 i	85	10/86→02/93	1.998	B	M	4	8	20NE		81606
2.0 i Cat.	85	10/86→02/93	1.998	B	M	4	8	C20NE		81606

### MERIVA A

1.3 CDTI	51	04/05→	1.248	D	M	4	16	Z13DT		81862
	55	09/03→	1.248	D	M	4	16	Z13DTJ		81862
1.4 16V Twinport	66	07/04→	1.364	B	M	4	16	Z14XEP		82011
1.4 16V Twinport LPG	66	07/04→05/10	1.364		M	4	16			82011
1.6	64	05/03→	1.598	B	M	4	8	Z16SE		81818
	77	01/06→	1.598	B	M	4	16	Z16XEP		82083
1.6 16V	74	05/03→	1.598	B	M	4	16	Z16XE		81817
1.6 Turbo	132	09/05→	1.598	B	M	4	16	Z16LET		82083
1.7 CDTI	74	09/03→	1.686	D	M	4	16	Z17DTH		81836
	92	09/06→	1.686	D	M	4	16	Z17DTR		81836
1.7 DTI	55	09/03→	1.686	D	M	4	16	Y17DT		81836
1.8	92	05/03→	1.796	B	M	4	16	Z18XE		81751

### MERIVA B

1.3 CDTI	55	06/10→	1.248	D	M	4	16	A13DTC		81862
	70	06/10→	1.248	D	M	4	16	A13DTE		81862

### MOVANO A

1.9 DTI	59	09/00→10/01	1.870	D	M	4	8	F9Q770		81574
	60	10/01→	1.870	D	M	4	8	F9Q774		81814
2.2 DTI	66	09/00→	2.188	D	M	4	16	G9T720		81855
2.5 CDTI	74	08/06→	2.464	D	M	4	16	G9U650		81855
	88	08/06→	2.464	D	M	4	16	G9U632, G9U650		81855
	107	08/06→	2.464	D	M	4	16			81855
2.5 D	59	07/98→09/00	2.499	D	M	4	8	S8U770		81834
2.5 DTi	73	10/03→	2.463	D	M	4	16	G9U754		81855
	74	10/03→	2.463	D	M	4	16	G9U754		81855
	84	10/01→	2.463	D	M	4	16	G9U720, G9U754		81855
2.8 DTI	84	01/99→10/01	2.799	D	M	4	8	S9W702	→12-1999	81834
	84	07/98→10/01	2.799	D	M	4	8	S9W702	01-2000→	81835

### MOVANO B

2.3 CDTI FWD	74	05/10→	2.299	D	M	4	16			82069
	92	05/10→	2.299	D	M	4	16			82069
	107	05/10→	2.299	D	M	4	16			82069

	kw		Cap. cm3	Fuel	Gear	No. of cyl.	No. of valves	Motor code		Short
--	----	--	----------	------	------	-------------	---------------	------------	--	-------

## OPEL

### OMEGA A, STATION WAGON

1.8	65	09/87→03/94	1.796	B	M	4	8	E18NVR		81606
	85	09/86→03/94	1.796	B	M	4	8	18SEH		81606
1.8 N	60	09/86→08/87	1.796	B	M	4	8	18NV		81606
1.8 S	66	09/86→03/94	1.796	B	M	4	8	18SV		81606
2.0	73	09/90→03/94	1.998	B	M	4	8	C20NEJ		81551
	74	09/90→03/94	1.998	B	M	4	8	C20NEF	M→: 14.608.701	81551
	90	09/86→03/94	1.998	B	M	4	8	20SE	01-1990→, M→: 14608701, M→: 14.608.701	81551
	90	09/86→03/94	1.998	B	M	4	8	20SE	→12-1989, →M: 14.608.700	81606
2.0 i	73	09/90→03/94	1.998	B	M	4	8	C20NEJ		81551
	85	09/86→03/94	1.998	B	M	4	8	C20NE	01-1990→, M→: 14.608.701	81551
2.0 i	85	09/86→03/94	1.998	B	M	4	8	C20NE	→12-1989, →M: 14.608.700	81606
2.3 D	54	09/86→03/94	2.260	D	M	4	8	23YD		81682
2.3 TD	66	09/86→08/88	2.260	D	M	4	8	23YDT		81682
2.3 TD Interc.	74	08/88→03/94	2.260	D	M	4	8	23DTR		81682
2.4 i	92	09/88→03/94	2.410	B	M	4	8	C24NE		81682
3.0	115	03/87→03/94	2.969	B	M	6	12	C30LE		81682
	130	03/87→03/94	2.969	B	M	6	12	30NE, C30NE		81682
3.0 Cat.	130	03/87→03/94	2.969	B	M	6	12	C30NE		81682

### OMEGA B, STATION WAGON

2.0	85	03/94→12/00	1.998	B	M	4	8	20SE, X20SE		81551
2.0 16V	100	03/94→09/99	1.998	B	M	4	16	X20XE		81550
2.0 DTI 16V	74	09/97→09/00	1.995	D	M	4	16	X20DTH		81747
2.2 16V	106	09/99→07/03	2.198	B	M	4	16	Y22XE, Z22XE		81550
	81	09/00→07/03	2.171	D	M	4	16	Y22DTH		81747
88		09/00→07/03	2.171	D	M	4	16	Y22DTH		81747
2.5 DTI	110	09/01→07/03	2.497	D	M	6	24	Y25DT		81795
2.5 TD	96	04/94→07/03	2.497	D	M	6	12	25DT, X25DT, X25TD		81597
2.5 V6	125	03/94→09/00	2.498	B	M	6	24	X25XE		81846
2.6 V6	132	09/00→07/03	2.597	B	M	6	24	Y26SE		81846
3.0 V6	155	04/94→02/01	2.962	B	M	6	24	X30XE		81846
3.2 V6	160	02/01→07/03	3.175	B	A	6	24	Y32SE		81846

### SIGNUM

1.8	90	05/03→	1.796	B	M	4	16	Z18XE		81751
	103	09/05→	1.796	B	M	4	16	Z18XER		82083
1.9 CDTI	74	08/05→	1.910	D	M	4	8	Z19DT		81352
	88	04/04→	1.910	D	M	4	8	Z19DT		81352
	110	04/04→	1.910	D	M	4	16	Z19DTH		81872
2.0 DTI	74	05/03→	1.994	D	M	4	16	Y20DTH		81747
2.0 Turbo	129	05/03→	1.998	B	M	4	16	Z20NET		81812
2.2 direct	114	05/03→	2.198	B	M	4	16	Z22YH		81812
2.2 DTI	92	05/03→	2.171	D	M	4	16	Y22DTR		81747

	kW		Cap. cm3	Fuel	Gear	No. of cyl.	No. of valves	Motor code		Short
<b>OPEL</b>										
<b>SIGNUM</b>										
3.0 V6 CDTI	130	05/03→	2.958	D	M	6	24	Y30DT		81871
	135	09/05→	2.959	D	M	6	24	Z30DT		81871
3.2 V6	155	05/03→	3.175	B	M	6	24	Z32SE		81846
<b>SINTRA</b>										
2.2 i 16V	104	11/96→04/99	2.198	B	M	4	16	X22XE		81550
2.2 DTI	85	07/97→04/99	2.171	D	M	4	16	X22DTH		81747
3.0 i 24V	148	11/96→04/99	2.962	B	A	6	24	X30XE		81846
<b>SPEEDSTER</b>										
2.0 Turbo	147	04/03→	1.998	B	M	4	16	Z20LET		81550
2.2	108	09/00→	2.198	B	M	4	16	Z22SE		81812
<b>TIGRA</b>										
1.4 16V	63	08/97→12/00	1.389	B	M	4	16	X14XE		82005
	66	07/94→12/00	1.389	B	M	4	16	X14XE		82005
1.6 16V	74	08/97→08/98	1.598	B	M	4	16	C16SEL		82005
	78	07/94→08/98	1.598	B	M	4	16	X16XE		82005
<b>TIGRA TWINTOP</b>										
1.3 CDTI	51	06/04→	1.248	D	M	4	16	Z13DT		81862
1.4	66	06/04→	1.364	B	M	4	16	Z14XEP		82011
1.8	92	06/04→	1.796	B	M	4	16	Z18XE		81751
<b>VECTRA A</b>										
1.4 S	55	04/88→06/92	1.389	B	M	4	8	14NV	M→: 19.307.806	81549
	55	04/88→06/92	1.389	B	M	4	8	14NV	→M: 19.307.805	81681
1.6	60	09/88→05/93	1.598	B	M	4	8	16SV	M→: 2.122.350	81549
	60	09/88→05/93	1.598	B	M	4	8	16SV	→M: 2.122.349	81681
1.6 i	52	09/93→11/95	1.598	B	M	4	8	X16SZ	M→: 2.122.350	81549
	52	09/93→11/95	1.598	B	M	4	8	X16SZ	→M: 2.122.349	81681
	55	09/88→11/95	1.598	B	M	4	8	16LZ2, E16NZ	M→: 2.122.350	81549
	55	09/88→11/95	1.598	B	M	4	8	16LZ2, E16NZ	→M: 2.122.349	81681
1.6 i Cat.	55	09/88→11/95	1.598	B	M	4	8	C16NZ, C16NZ2	M→: 2.122.350	81549
	55	09/88→11/95	1.598	B	M	4	8	C16NZ, C16NZ2	→M: 2.122.349	81681
1.6 S	60	09/88→05/93	1.598	B	M	4	8	16SV	M→: 2.122.350	81549
	60	09/88→05/93	1.598	B	M	4	8	16SV	→M: 2.122.349	81681
1.7 D	42	10/88→09/92	1.700	D	M	4	8	17D	M→: 14.333.450	81550
	42	09/88→09/92	1.700	D	M	4	8	17D	→M: 14.333.449	81605
	44	07/92→11/95	1.700	D	M	4	8	17DR	01-1993→, M→: 14.333.450	81550
	44	07/92→11/95	1.700	D	M	4	8	17DR	→12-1992, →M: 14.333.449	81605
1.7 TD	60	03/90→11/95	1.686	D	M	4	8	17DT (TC4EE1), X17DT (TC4EE1)		81687
1.8 i	66	09/88→10/90	1.796	B	M	4	8	18SV	T→: P1.000.001	81551
	66	09/88→10/90	1.796	B	M	4	8	18SV	→T: N5.999.999	81606
1.8 i Cat.	66	03/90→11/95	1.796	B	M	4	8	C18NZ	01-1993→, T→: P1.000.001	81551
	66	03/90→11/95	1.796	B	M	4	8	C18NZ	→12-1992, →T: N5.999.999	81606

	kW		Cap. cm3	Fuel	Gear	No. of cyl.	No. of valves	Motor code		MAGNETI MARELLI Short
--	----	--	----------	------	------	-------------	---------------	------------	--	-----------------------

**OPEL**
**VECTRA A**

1.8 S	65	09/88→07/89	1.796	B	M	4	8	E18NVR	T→: P1.000.001	<b>81551</b>
	65	09/88→07/89	1.796	B	M	4	8	E18NVR	→T: N5.999.999	<b>81606</b>
	66	09/89→10/90	1.796	B	M	4	8	18SV	T→: P1.000.001	<b>81551</b>
	66	09/89→10/90	1.796	B	M	4	8	18SV	→T: N5.999.999	<b>81606</b>
1.8 S 4x4	65	01/89→07/89	1.796	B	M	4	8	E18NVR	T→: P1.000.001	<b>81551</b>
	65	01/89→07/89	1.796	B	M	4	8	E18NVR	→T: N5.999.999	<b>81606</b>
2.0	74	04/88→09/89	1.998	B	M	4	8	C20NEF	T→: P1.000.001	<b>81551</b>
	74	04/88→09/89	1.998	B	M	4	8	C20NEF	→T: N5.999.999	<b>81606</b>
2.0 i	85	09/88→10/90	1.998	B	M	4	8	20NE	T→: P1.000.001	<b>81551</b>
	85	09/88→10/90	1.998	B	M	4	8	20NE	→T: N5.999.999	<b>81606</b>
	95	09/88→09/92	1.998	B	M	4	8	20SEH	T→: P1.000.001	<b>81551</b>
	95	09/88→09/92	1.998	B	M	4	8	20SEH	08-1988→, →12-1992, →T: N5.999.999	<b>81606</b>
2.0 i 16V	100	06/94→11/95	1.998	B	M	4	16	X20XEV	M→: 14.142.839	<b>81550</b>
	100	06/94→11/95	1.998	B	M	4	16	X20XEV	→M: 14.142.838	<b>81680</b>
	110	02/89→10/90	1.998	B	M	4	16	20XEJ	M→: 14.142.839	<b>81550</b>
	110	02/89→10/90	1.998	B	M	4	16	20XEJ	→M: 14.142.838	<b>81680</b>
2.0 i 16V 4x4	100	06/94→11/95	1.998	B	M	4	16	X20XEV	M→: 14.142.839	<b>81550</b>
	100	06/94→11/95	1.998	B	M	4	16	X20XEV	→M: 14.142.838	<b>81680</b>
2.0 i 16V Cat.	110	02/90→11/95	1.998	B	M	4	16	C20XE	M→: 14.142.839	<b>81550</b>
	110	02/90→11/95	1.998	B	M	4	16	C20XE	→M: 14.142.838	<b>81680</b>
2.0 i 4x4	85	01/89→10/90	1.998	B	M	4	8	20NE	T→: P1.000.001	<b>81551</b>
	85	01/89→10/90	1.998	B	M	4	8	20NE	→T: N5.999.999	<b>81606</b>
	95	01/89→09/92	1.998	B	M	4	8	20SEH	T→: P1.000.001	<b>81551</b>
	95	01/89→09/92	1.998	B	M	4	8	20SEH	08-1988→, →12-1992, →T: N5.999.999	<b>81606</b>
2.0 i 4x4 Cat.	85	01/89→11/95	1.998	B	M	4	8	C20NE	T→: P1.000.001	<b>81551</b>
	85	01/89→11/95	1.998	B	M	4	8	C20NE	08-1988→, →12-1992, →T: N5.999.999	<b>81606</b>
2.0 i Cat.	85	09/88→11/95	1.998	B	M	4	8	C20NE	01-1993→, T→: P1.000.001	<b>81551</b>
	85	09/88→11/95	1.998	B	M	4	8	C20NE	→12-1992, →T: N5.999.999	<b>81606</b>
2.0 i GT	95	09/88→11/95	1.998	B	M	4	8	20SEH	01-1993→, T→: P1.000.001	<b>81551</b>
	95	09/88→11/95	1.998	B	M	4	8	20SEH	→12-1992, →T: N5.999.999	<b>81606</b>
2.0 i Turbo 4x4	150	06/94→11/95	1.998	B	M	4	16	C20LET	M→: 14.002.935	<b>81550</b>
	150	06/94→11/95	1.998	B	M	4	16	C20LET	→M: 14.002.934	<b>81680</b>
2.5 V6	125	02/93→11/95	2.498	B	M	6	24	C25XE		<b>81846</b>
2000 16V 4x4	110	01/89→10/90	1.998	B	M	4	16	20XEJ	M→: 14.142.839	<b>81550</b>
	110	01/89→10/90	1.998	B	M	4	16	20XEJ	→M: 14.142.838	<b>81680</b>
2000/GT 16V	110	01/89→06/94	1.998	B	M	4	16	20XEJ	M→: 14.142.839	<b>81550</b>
	110	01/89→06/94	1.998	B	M	4	16	20XEJ	→M: 14.142.838	<b>81680</b>
2000/GT 16V 4x4 Cat.	110	02/90→11/95	1.998	B	M	4	16	C20XE	M→: 14.142.839	<b>81550</b>
	110	02/90→11/95	1.998	B	M	4	16	C20XE	→M: 14.142.838	<b>81680</b>

	kW		Cap. cm3	Fuel	Gear	No. of cyl.	No. of valves	Motor code		Short
--	----	--	----------	------	------	-------------	---------------	------------	--	-------

## OPEL

### VECTRA A

2000/GT 16V Cat.	110	02/90→11/95	1.998	B	M	4	16	C20XE	M→: 14.142.839	81550
	110	02/90→11/95	1.998	B	M	4	16	C20XE	→M: 14.142.838	81680

### VECTRA B, STATION WAGON

1.6 i	55	10/95→07/03	1.598	B	M	4	8	X16SZR	→12-1999, →M: 02MZ5253	81549
	55	10/95→07/03	1.598	B	M	4	8	16LZ2		81551
	55	10/95→07/03	1.598	B	M	4	8	X16SZR	01-2000→, M→: 02MZ5254	81818
1.6 i 16V	74	10/95→07/02	1.598	B	M	4	16	X16XEL, Y16XE, Z16XE	M→: 02MZ5254, M→: 20U75999, M→: 02MV7225, M→: 02MZ5254	81817
	74	10/95→07/02	1.598	B	M	4	16	X16XEL, Y16XE, Z16XE	→M: 02MZ5253, →M: 20U75998, →M: 02MV7224, →M: 02MZ5253	82005
1.7 TD	60	10/95→12/98	1.686	D	M	4	8	X17DT (TC4EE1)		81746
1.8 i 16V	85	10/95→09/00	1.796	B	M	4	16	X18XE1	→12-1998, M: X18XE	81550
	85	10/95→09/00	1.796	B	M	4	16	X18XE1	01-1999→, M: X18XE1	81751
	92	09/00→07/03	1.796	B	M	4	16	Z18XE		81751
2.0 DI 16V	60	11/96→04/02	1.995	D	M	4	16	X20DTL		81747
2.0 DTI 16V	74	06/97→07/03	1.995	D	M	4	16	X20DTH, Y20DTH		81747
2.0 i	82	10/95→04/02	1.998	B	M	4	8	Z0NEJ		81551
2.0 i 16V	100	10/95→09/00	1.998	B	M	4	16	C20SEL, X20XEV		81550
2.2 DTI 16V	92	09/00→07/03	2.172	D	M	4	16	Y22DTR		81747
2.2 i 16V	108	09/00→07/03	2.198	B	M	4	16	Z22SE		81812
2.5 i V6	125	10/95→09/00	2.498	B	M	6	24	X25XE		81846
2.6 i V6	125	09/00→07/03	2.597	B	M	6	24	Y26SE		81846
i 500 2.5	143	05/98→09/00	2.498	B	M	6	24	X25XE		81846

### VECTRA C, STATION WAGON, GTS

1.6	74	08/05→	1.598	B	M	4	16	Z16XE		81817
	77	01/06→	1.598	B	M	4	16	Z16XEP		82083
1.6 16V	74	06/04→	1.598	B	M	4	16	Z16XE		81817
1.8	81	04/02→	1.796	B	M	4	16	Z18XEL		81751
	90	10/03→	1.796	B	M	4	16	Z18XE		81751
	103	01/06→	1.796	B	M	4	16	Z18XER		82083
1.8 16V	90	04/02→	1.796	B	M	4	16	Z18XE		81751
1.9 CDTI	74	10/05→	1.910	D	M	4	8	Z19DT		81352
	74	10/05→	1.910	D	M	4	16	Z19DT		81352
	88	04/04→	1.910	D	M	4	8	Z19DT		81352
	110	04/04→	1.910	D	M	4	16	Z19DTH		81872
2.0 16V Turbo	129	03/03→	1.998	B	M	4	16	Z20NET		81812
2.0 DTI	74	10/03→	1.995	D	M	4	16	Y20DTH		81747
2.0 DTI 16V	74	04/02→	1.995	D	M	4	16	Y20DTH		81747
2.0 Turbo	129	10/03→	1.998	B	M	4	16	Z20NET		81812
2.2 16V	108	04/02→	2.198	B	M	4	16	Z22SE		81812
2.2 direct	114	10/03→	2.198	B	M	4	16	Z22YH		81812
2.2 DTI	92	10/03→	2.172	D	M	4	16	Y22DTR		81747



	kw		Cap. cm3	Fuel	Gear	No. of cyl.	No. of valves	Motor code		Short
--	----	--	----------	------	------	-------------	---------------	------------	--	-------

## OPEL

### VECTRA C, STATION WAGON, GTS

2.2 DTI 16V	92	04/02→	2.172	D	M	4	16	Y22DTR		81747
3.0 CDTI	130	06/03→	2.958	D	M	6	24	Y30DT		81871
	135	08/05→	2.958	D	M	6	24	Z30DT		81871
3.0 V6 CDTI	130	10/03→	2.958	D	M	6	24	Y30DT		81871
	135	08/05→	2.958	D	M	6	24	Z30DT		81871
3.2 V6	155	08/02→	3.175	B	M	6	24	Z32SE		81846

### VIVARO

1.9 DI	60	08/01→	1.870	D	M	4	8	F9Q762, F9Q774		81814
1.9 DTI	74	08/01→	1.870	D	M	4	8	F9Q760		81814
2.0 16V	88	08/01→	1.998	B	M	4	16	F4R720		81814
2.0 CDTI	66	01/06→	1.995	D	M	4	16			82069
	84	08/06→	1.995	D	M	4	16	M9R780		82069
2.0 ECOTEC	86	08/06→	1.998	B	M	4	16	F4R820		81814
2.5 CDTI	84	08/06→	2.464	D	M	4	16	G9U630		81855
	107	08/06→	2.463	D	M	4	16	G9MB6, G9U630		81855
2.5 DTI	99	05/03→	2.463	D	M	4	16	G9U730		81855

### ZAFIRA A

1.6	70	09/02→06/05	1.598	BF	M	4	16	Z16YNG		81817
1.6 16V	74	04/99→06/05	1.598	B	M	4	16	X16XEL, Z16XE	07-2000→, M→: 02MV7225, M→: 20U75999, M→: 02MV7225	81817
	74	04/99→06/05	1.598	B	M	4	16	X16XEL, Z16XE	→06-2000, →M: 02MV7224, →M: 20U75998, →M: 02MV7224	82005
1.6 CNG	71	09/01→06/05	1.598	G	M	4	16	Z16YNG		81817
1.8	81	02/03→06/05	1.796	B	M	4	16	Z18XEL		81751
1.8 16V	85	04/99→09/00	1.796	B	M	4	16	X18XE1		81751
	92	09/00→06/05	1.796	B	M	4	16	Z18XE		81751
2.0 DI 16V	60	10/99→06/05	1.995	D	M	4	16	X20DTL		81747
2.0 DTI 16V	74	09/00→06/05	1.995	D	M	4	16	Y20DTH		81747
2.0 OPC	141	09/01→06/05	1.998	B	M	4	16	Z20LET		81550
	147	11/02→06/05	1.998	B	M	4	16	Z20LER		81550
2.2 16V	108	09/00→06/05	2.198	B	M	4	16	Z22SE		81812
2.2 DTI 16V	92	01/02→06/05	2.172	D	M	4	16	Y22DTR		81747

### ZAFIRA B

1.6	69	01/06→	1.598	M	M	4	16	Z16YNG		81817
	77	07/05→	1.598	B	M	4	16	Z16XEP		82083
	85	01/08→	1.598	B	M	4	16	Z16XER		82083
1.6 CNG Turbo	110	02/09→	1.598		M	4	16	Z16XNT		81817
1.7 CDTI	81	01/08→	1.686	D	M	4	16	A17DTJ	→T: 1874032	81836
	92	01/08→	1.686	D	M	4	16	A17DTR	→T: 1874032	81836
1.8	103	07/05→	1.796	B	M	4	16	Z18XEP, Z18XER		82083
1.9 CDTI	74	07/05→	1.910	D	M	4	8	Z19DT		81352
	88	07/05→	1.910	D	M	4	8	Z19DT		81352
	110	07/05→	1.910	D	M	4	16	Z19DTH		81872

	kW		Cap. cm3	Fuel	Gear	No. of cyl.	No. of valves	Motor code		Short
--	----	--	----------	------	------	-------------	---------------	------------	--	-------

## OPEL

### ZAFIRA B

2.0	147	07/05→	1.998	B	M	4	16	Z20LER		81550
	177	01/06→	1.998	B	M	4	16	Z20LEH		81550
2.2	110	07/05→	2.198	B	M	4	16	Z22YH		81812

## PEUGEOT

### 107

1.4 HDi	40	06/05→	1.398	D	M	4	8			81798
1.0	50	06/05→	998	B	M	3	12	1KR (384F)		82063

### 605

2.0	79	02/90→09/99	1.998	B	M	4	8			81642
	84	06/89→09/99	1.998	B	M	4	8	R5A (XU102C)		81642
	89	06/89→09/99	1.998	B	M	4	8	RFZ (XU10J2Z)		81642
2.0 16V	97	07/94→09/99	1.998	B	M	4	16	RFV (XU10J4R)		81711
2.0 Turbo	104	07/92→09/99	1.998	B	M	4	8	RGY (XU10J2TE)		81642
	108	07/91→09/99	1.998	B	M	4	8	RGX (XU10J2TE)		81642
2.1 D	60	06/89→07/95	2.138	D	M	4	12	P9A (XUD11A)		81642
2.1 TD 12V	80	08/94→09/99	2.088	D	M	4	12	P8C (XUD11BTE)		81353
2.1 Turbo Diesel	80	06/89→09/99	2.088	D	M	4	12	PHZ (XUD11ATE)		81353
2.5 Turbo Diesel	95	07/94→09/99	2.446	D	M	4	12	THY (DK5ATE)	04-1995→, PROD→: 7144	81712
	95	07/94→09/99	2.446	D	M	4	12	THY (DK5ATE)	→03-1995, →PROD: 7143	81752

### 607

2.0	100	02/00→	1.997	B	M	4	16	RFN (EW10J4)	(-)COP	81799
	100	02/00→	1.997	B	M	4	16	RFN (EW10J4)	(+)COP	82089
2.0 HDi	79	03/01→07/04	1.997	D	M	4	8	RHS (DW10ATED)		81713
	80	05/00→	1.997	D	M	4	8	RHZ (DW10ATED)		81713
	100	09/05→	1.997	D	M	4	16	RHR (DW10BTED4)		81800
2.2 16V	116	02/00→	2.230	B	M	4	16	3FZ (EW12J4)	(-)COP	81799
	116	02/00→	2.230	B	M	4	16	3FZ (EW12J4)	(+)COP	82089
	120	09/05→	2.230	B	M	4	16	3FY (EW12J4)	(-)COP	81799
	120	09/05→	2.230	B	M	4	16	3FY (EW12J4)	(+)COP	82089
2.2 HDI	98	02/00→	2.179	D	M	4	16	4HX (DW12TED4/FAP)		81800
	125	05/06→	2.179	D	M	4	16	4HT (DW12BTED4)		82068
2.7 HDi 24V	150	12/04→	2.721	D	M	6	24	DT17TED4		82067
3.0 V6 24V	152	02/00→	2.946	B	M	6	24	XFX (ES9J4S)		81813
	155	03/04→	2.946	B	M	6	24	XFV (ES9A)		81813

### 806

1.8	73	07/95→08/02	1.761	B	M	4	8	LFW (XU7JP)		81512
1.9 TD	66	07/95→08/02	1.905	D	M	4	8	DHX (XUD9TE)		81642
	68	05/97→08/02	1.905	D	M	4	8	DHY (XUD9TE)		81642
2.0	89	06/94→08/02	1.998	B	M	4	8	RFU (XU10J2)		81642
2.0 16V	97	05/98→09/00	1.998	B	M	4	16	RFV (XU10J4R)		81711
	100	09/00→08/02	1.997	B	M	4	16	RFN (EW10J4)	(-)COP	81799
	100	09/00→08/02	1.997	B	M	4	16	RFN (EW10J4)	(+)COP	82089

	kw		Cap. cm3	Fuel	Gear	No. of cyl.	No. of valves	Motor code		MAGNETI MARELLI Short
--	----	--	----------	------	------	-------------	---------------	------------	--	-----------------------

## PEUGEOT

### 806

2.0 HDI	80	08/99→08/02	1.997	D	M	4	8	RHZ (DW10ATED)		81713
2.0 HDI 16V	80	08/99→08/02	1.997	D	M	4	16	RHW (DW10ATED4)		81713
2.0 Turbo	108	06/94→08/02	1.998	B	M	4	8	RGX (XU10J2TE)		81642
2.1 td 12V	80	06/96→08/99	2.088	D	M	4	12	P8C (XUD11BTE)		81353

### 807

2.0	100	06/02→	1.997	B	M	4	16	RFN (EW10J4)	(-)COP	81799
	100	06/02→	1.997	B	M	4	16	RFN (EW10J4)	(+)COP	82089
2.0 16V	103	09/05→	1.997	B	M	4	16	RFJ (EW10A)	(-)COP	81799
	103	09/05→	1.997	B	M	4	16	RFJ (EW10A)	(+)COP	82089
2.0 HDi	80	04/04→05/06	1.997	D	M	4	8			81800
	88	11/06→	1.997	D	M	4	16	RHK (DW10UTED4)		81800
	100	06/06→	1.997	D	M	4	16	RHR (DW10BTED4)		81800
2.0 HDi FAP	79	06/02→	1.997	D	M	4	16	RHW (DW10ATED4)		81713
2.2	116	06/02→	2.230	B	M	4	16	3FZ (EW12J4)	(-)COP	81799
	116	06/02→	2.230	B	M	4	16	3FZ (EW12J4)	(+)COP	82089
2.2 HDi	125	06/06→	2.179	D	M	4	16	4HT (DW12BTED4)		82068
2.2 HDi FAP	94	06/02→	2.179	D	M	4	16	4HX (DW12TED4/FAP)		81800
3.0 V6	150	06/02→	2.946	B	M	6	24	XFV (ES9J4S)		81813

### 1007

1.4	54	04/05→	1.360	B	M	4	8	KFV (TU3JP)		81797
1.4 16V	65	10/05→	1.360	B	M	4	16	KFU (ET3J4)		81797
1.4 HDi	50	04/05→	1.398	D	M	4	8	8HX (DV4TD), 8HZ (DV4TD)		81798
1.6 16V	80	04/05→	1.587	B	M	4	16	NFU (TU5JP4)		81753
1.6 HDi	80	06/07→	1.560	D	M	4	16	9HZ (DV6TED4)		81869

### 3008

1.6 HDi	80	06/09→	1.560	D	M	4	16	9HZ (DV6TED4)		81869
	82	08/10→	1.560	D	M	4	16			81869
1.6 THP	110	06/09→	1.598	B	M	4	16	5FX (EP6DT)		82032
	115	06/09→	1.598	B	M	4	16			82032
1.6 VTi	88	06/09→	1.598	B	M	4	16	EP6		82032

### 4007

2.2 HDi	115	02/07→	2.179	D	M	4	16			82068
---------	-----	--------	-------	---	---	---	----	--	--	-------

### 5008

1.6 16V	88	09/09→	1.598	B	M	4	16	EP6		82032
	115	09/09→	1.598	B	M	4	16	EP6CDT		82032
1.6 HDi	80	09/09→	1.560	D	M	4	16			81869
	82	08/10→	1.560	D	M	4	16			81869

### 106 I

1.0	33	09/91→04/96	954	B	M	4	8	CDY (TU9M)		81556
	37	09/91→04/96	954	B	M	4	8	CDZ (TU9M)		81556
1.1	44	09/91→04/96	1.124	B	M	4	8	HDZ (TU1M)		81556
1.3	72	10/93→04/96	1.294	B	M	4	8	TU2J2		81556
1.4	51	08/91→03/96	1.360	B	M	4	8	TU3		81556
	55	09/91→04/96	1.361	B	M	4	8	KDX (TU3MC), KDY (TU3M)		81556
	69	09/91→04/96	1.361	B	M	4	8	KFZ (TU3J2/Z)		81556
1.4 D	37	09/92→04/96	1.361	D	M	4	8	K9Y (TUD3Y)		81556

	kW		Cap. cm3	Fuel	Gear	No. of cyl.	No. of valves	Motor code		Short
--	----	--	----------	------	------	-------------	---------------	------------	--	-------

## PEUGEOT

### 106 I

1.5 D	40	06/94→04/96	1.527	D	M	4	8	VJY (TUD5)		81513
	43	06/94→04/96	1.527	D	M	4	8			81513
1.6	65	06/93→04/96	1.587	B	M	4	8	NFZ (TU5JP)		81556
	76	01/94→04/96	1.587	B	M	4	8	NFY (TU5J2)		81513

### 106 II

1.0 i	33	05/96→	954	B	M	4	8	CDY (TU9M)		81556
	37	01/97→	954	B	M	4	8	CDZ (TU9M)		81556
1.1	42	09/00→10/02	1.124	G	M	4	8			81556
1.1 i	40	01/97→	1.124	B	M	4	8	HDY (TU1M)		81556
	44	05/96→	1.124	B	M	4	8	HDZ (TU1M), HFX (TU1JP)		81556
1.4 i	55	05/96→	1.360	B	M	4	8	KFW (TU3JP), KFX (TU3JP)		81556
1.5 D	40	05/96→	1.527	D	M	4	8	VJY (TUD5)	04-1996→	81513
	42	10/00→	1.527	D	M	4	8	VJX (TUD5)		81513
1.6 i	65	05/96→	1.587	B	M	4	8	NFZ (TU5JP)		81556
	74	05/96→	1.587	B	M	4	8	NFW (TU5J2), NFY (TU5J2)		81513
1.6 S16	87	05/96→	1.587	B	M	4	16	NFX (TU5J4)		81753

### 205 I, CABRIO, VAN

1.0	33	02/83→10/87	954	B	M	4	8	108C (XV8)		81572
1.1	36	02/83→10/87	1.124	B	M	4	8	109N (XW7)		81572
	37	02/83→10/87	1.124	B	M	4	8	109F (XW7)		81572
	40	08/87→12/94	1.124	B	M	4	8	H1B (TU1)		81556
1.1 CJ	44	10/89→12/94	1.124	B	M	4	8	HDZ (TU1M)		81556
1.3	47	02/84→10/87	1.294	B	M	4	8	G1A		81560
1.4	44	02/83→10/87	1.360	B	M	4	8	150D (XY7), 150G (XY7)		81572
	53	02/83→10/87	1.360	B	M	4	8	150 (XY6B)		81572
	58	10/85→10/87	1.360	B	M	4	8	150H (XY8)		81572
	59	02/83→10/87	1.360	B	M	4	8	150B (XY8)		81572
	62	08/87→06/94	1.360	B	M	4	8	K2B (TU3S)		81572
1.4 CJ	44	03/88→05/89	1.360	B	M	4	8	150D (XY7), 150G (XY7)		81572
	49	03/89→12/94	1.360	B	M	4	8	K1D (TU3A)		81556
	55	05/91→12/94	1.361	B	M	4	8	KDY (TU3M), KDZ (TU3M)		81556
1.4 CJ Cat.	44	01/89→09/93	1.361	B	M	4	8	KAY (TU3CP)		81572
1.4 CT	58	04/86→12/88	1.360	B	M	4	8	150B (XY8), 150H (XY8)		81572
1.6	53	03/87→10/87	1.580	B	M	4	8	B1E (XU51C)		81554
	55	08/86→10/87	1.580	B	M	4	8	B1A (XU51C), BAZ (XU5CP)		81554
	85	08/87→07/92	1.580	B	M	4	8			81554
1.6 CJ	65	08/92→12/94	1.580	B	M	4	8	BDY (XU5M3Z)		81512
1.6 CTI	76	04/86→10/90	1.580	B	M	4	8	180A (XU5J), 180Z (XU5J)		81554
1.6 GTI	76	12/84→10/87	1.580	B	M	4	8	180A (XU5J)		81554
1.7 Diesel	44	08/83→10/87	1.769	D	M	4	8	161A (XUD7)	→10-1986	81554
	44	08/83→10/87	1.769	D	M	4	8	161A (XUD7)	11-1986→	81672
	44	03/94→	1.769	D	M	4	8	161A (XUD7)		81642
1.9 CTI	75	10/87→12/94	1.905	B	M	4	8	DFZ (XU9J1)	01-1992→	81512
	75	10/87→12/94	1.905	B	M	4	8	DFZ (XU9J1)	→12-1991	81554
	92	08/90→07/92	1.905	B	M	4	8			81554

	kW		Cap. cm3	Fuel	Gear	No. of cyl.	No. of valves	Motor code		Short
--	----	--	----------	------	------	-------------	---------------	------------	--	-------

## PEUGEOT

### 205 I, CABRIO, VAN

1.9 GTI	75	03/87→10/87	1.905	B	M	4	8	DFZ (XU9J1)		81554
	94	10/86→10/87	1.905	B	M	4	8	D6B (XU9JA (ohneKAT))		81554

### 205 II, VAN

1.0	33	10/87→09/98	954	B	M	4	8	TU9		81556
	37	08/92→05/97	954	B	M	4	8	CDZ (TU9M)		81556
1.1	36	10/87→10/90	1.124	B	M	4	8	109N (XW7)		81572
	40	10/87→10/90	1.124	B	M	4	8	H1B (TU1)		81556
	44	07/89→09/98	1.124	B	M	4	8	HDZ (TU1M)		81556
1.1 XA	40	07/87→10/88	1.118	B	M	4	8	E1		81560
1.2	47	01/87→12/90	1.204	B	M	4	8	F1		81560
1.3	47	08/90→07/92	1.294	B	M	4	8	G1A		81560
1.3 Rallye	74	10/87→10/90	1.294	B	M	4	8	TU24		81556
1.4	44	10/87→05/89	1.360	B	M	4	8	150D (XY7), 150G (XY7)		81572
	49	10/87→10/90	1.360	B	M	4	8	K1D (TU3A)		81556
	53	01/87→07/88	1.360	B	M	4	8	150 (XY6B)		81572
	55	07/88→09/98	1.361	B	M	4	8	KDY (TU3M), KDZ (TU3M), KFX (TU3JP)		81556
	58	07/88→05/89	1.360	B	M	4	8	150B (XY8), 150H (XY8)		81572
	62	06/87→12/89	1.360	B	M	4	8	K2B (TU3S)		81556
	63	06/87→12/89	1.442	B	M	4	8			81556
1.4 Cat.	44	08/87→09/93	1.360	B	M	4	8	KAY (TU3CP)		81556
1.6	53	10/87→09/98	1.580	B	M	4	8	B1E (XU51C)		81554
	55	10/87→09/98	1.580	B	M	4	8	B1A (XU51C), BAZ (XU5CP)		81554
1.6 Aut.	58	10/87→09/98	1.580	B	M	4	8		01-1992→	81512
	58	10/87→09/98	1.580	B	M	4	8		→12-1991	81554
	65	05/90→09/98	1.580	B	M	4	8	BDY (XU5M2Z), BDY (XU5M3Z)		81512
1.6 GTI	76	10/87→12/89	1.580	B	M	4	8	180A (XU5J), 180Z (XU5J)		81554
	85	10/87→12/89	1.580	B	M	4	8			81554
1.6 GTX	69	01/87→10/91	1.592	B	M	4	8			81560
1.7 Diesel	44	07/87→09/98	1.769	D	M	4	8	161A (XUD7)		81672
1.7 TD	57	01/90→09/98	1.769	D	M	4	8	A8B (XUD7TE)		81672
1.9	51	08/87→06/94	1.905	D	M	4	8	XUD9		81672
1.9 Diesel	47	10/87→09/98	1.905	D	M	4	8	DJZ (XUD9Y)		81672
1.9 GTI	75	10/87→05/89	1.905	B	M	4	8	D2A (XU92C)		81554
	88	10/87→10/94	1.905	B	M	4	8	DKZ (XU9JAZ)	01-1992→	81512
	88	10/87→10/94	1.905	B	M	4	8	DKZ (XU9JAZ)	→12-1991	81554
	94	10/87→09/98	1.905	B	M	4	8	D6B (XU9JA (G-KAT))	01-1992→	81512
	94	10/87→09/98	1.905	B	M	4	8	D6B (XU9JA (G-KAT))	→12-1991	81554
1.9 GTI Cat.	75	10/87→07/94	1.905	B	M	4	8	DFZ (XU9J1)	01-1992→	81512
	75	10/87→07/94	1.905	B	M	4	8	DFZ (XU9J1)	→12-1991	81554

### 206, STATION WAGON, CC, PLUS

1.1	40	08/98→07/00	1.124	B	M	4	8		→M: 3.762.433	81556
	40	08/98→07/00	1.124	B	M	4	8		M→: 3.762.434	81797
	44	07/02→	1.124	B	M	4	8	HFX (TU1JP)	→M: 3.762.433	81556
	44	07/02→	1.124	B	M	4	8	HFX (TU1JP)	M→: 3.762.434	81797

	kw		Cap. cm3	Fuel	Gear	No. of cyl.	No. of valves	Motor code		Short
--	----	--	----------	------	------	-------------	---------------	------------	--	-------

## PEUGEOT

### 206, STATION WAGON, CC, PLUS

1.1 i	44	09/98→	1.124	B	M	4	8	HFX (TU1JP), HFZ (TU1JP)	→M: 3.762.433	81556
	44	09/98→	1.124	B	M	4	8	HFX (TU1JP), HFZ (TU1JP)	M→: 3.762.434	81797
1.4	55	07/02→	1.360	B	M	4	8	KFW (TU3JP)	→M: 3.666.765	81556
	55	07/02→	1.360	B	M	4	8	KFW (TU3JP)	M→: 3.666.766	81797
1.4 16V	65	10/03→	1.360	B	M	4	16	KFU (ET3J4)		82016
1.4 HDi	50	07/02→	1.398	D	M	4	8	8HX (DV4TD)		81798
1.4 HDi eco 70	50	09/01→	1.398	D	M	4	8	8HX (DV4TD), 8HZ (DV4TD)		81798
1.4 i	55	09/98→	1.360	B	M	4	8	KFW (TU3JP), KFX (TU3JP)	→M: 3.666.765	81556
	55	09/98→	1.360	B	M	4	8	KFV (TU3A), KFW (TU3JP), KFX (TU3JP)	M→: 3.666.766	81797
1.6 16V	80	07/02→	1.587	B	M	4	16	NFU (TU5JP4)		81753
	80	09/00→	1.587	B	AM	4	16	NFU (TU5JP4)		81753
1.6 HDi FAP 110	80	05/04→	1.560	D	M	4	16	9HY (DV6TED4), 9HZ (DV6TED4)		81869
1.6 i	65	09/98→12/00	1.587	B	M	4	8	NFZ (TU5JP)		81513
1.9 D	51	09/98→11/01	1.868	D	M	4	8	WJZ (DW8)		81713
2.0 16V	100	07/02→	1.997	B	M	4	16	RFN (EW10J4)	(-)COP	81799
	100	07/02→	1.997	B	M	4	16	RFN (EW10J4)	(+)COP	82089
2.0 HDi	66	07/02→	1.997	D	M	4	8	RHY (DW10TD)		81713
2.0 HDi 90	66	12/99→	1.997	D	M	4	8	RHY (DW10TD)		81713
2.0 RC	130	07/03→	1.997	B	M	4	16	RFK (EW10J4S)	(-)COP	81799
	130	07/03→	1.997	B	M	4	16	RFK (EW10J4S)	(+)COP	82089
2.0 S16	99	04/99→10/00	1.997	B	M	4	16	RFR (DEW10J4)	(-)COP	81799
	99	04/99→10/00	1.997	B	M	4	16	RFR (DEW10J4)	(+)COP	82089
	100	09/00→	1.997	B	M	4	16	RFN (EW10J4)	(-)COP	81799
	100	09/00→	1.997	B	M	4	16	RFN (EW10J4)	(+)COP	82089

### 207, STATION WAGON, CC

1.4	53	02/06→	1.360	B	M	4	8	KFV (TU3A)		81797
	54	06/07→	1.360	B	M	4	8	KFV (TU3A)		81797
1.4 16V	65	02/06→	1.360	B	M	4	16	KFU (ET3J4)		82016
	70	06/07→	1.397	B	M	4	16	EP3		82016
	70	06/07→	1.397	B	M	4	16	EP3		82032
1.4 HDi	50	02/06→	1.398	D	M	4	16			81798
1.6 16V	80	02/06→	1.587	B	M	4	16	NFU (TU5JP4)		81753
	88	02/07→	1.598	B	M	4	16	EP6		82032
1.6 16V RC	128	02/07→	1.598	B	M	4	16			82032
1.6 16V Turbo	110	02/06→	1.598	B	M	4	16	EP6DT		82032
	115	10/09→	1.598	B	M	4	16			82032
1.6 16V VTi	88	02/07→	1.598	B	M	4	16	EP6		82032
1.6 HDi	66	02/06→	1.560	D	M	4	16	9HX (DV6ATED4)		81869
	68	11/09→	1.560	D	M	4	16			81869
	80	02/06→	1.560	D	M	4	16	9HY (DV6TED4), 9HZ (DV6TED4)		81869
	82	08/09→	1.560	D	M	4	16			81869

	kW		Cap. cm3	Fuel	Gear	No. of cyl.	No. of valves	Motor code		Short
--	----	--	----------	------	------	-------------	---------------	------------	--	-------

## PEUGEOT

### 306, BREAK, CABRIO

1.1	44	05/93→05/01	1.124	B	M	4	8	HDZ (TU1M)		81556
1.4	55	05/93→04/02	1.360	B	M	4	8	KDX (TU3MC), KFW (TU3JP), KFX (TU3JP)	→M: 3.666.765	81556
	55	05/93→04/02	1.360	B	M	4	8	KDX (TU3MC), KFW (TU3JP), KFX (TU3JP)	M→: 3.666.766	81797
1.4 SL	55	06/94→05/01	1.360	B	M	4	8	KDX (TU3MC), KFW (TU3JP), KFX (TU3JP)	→M: 3.666.765	81556
	55	06/94→05/01	1.360	B	M	4	8	KDX (TU3MC), KFW (TU3JP), KFX (TU3JP)	M→: 3.666.766	81797
1.6	65	05/93→10/00	1.587	B	M	4	8	NFZ (TU5JP)		81513
	72	10/00→04/02	1.587	B	M	4	8	NFT		81513
1.6 SR	65	06/94→10/00	1.587	B	M	4	8	NFZ (TU5JP)		81513
1.8	74	05/93→04/02	1.762	B	M	4	8	LFZ (XU7JP)		81512
1.8 16V	81	03/97→04/02	1.761	B	M	4	16	LFY (XU7JP4)		81710
1.8 D	43	05/93→05/01	1.769	D	M	4	8	A9A (XUD7)	PROD→: 7391	81642
	43	05/93→05/01	1.769	D	M	4	8	A9A (XUD7)	→PROD: 7390	81672
1.8 ST	74	06/94→05/01	1.762	B	M	4	8	LFZ (XU7JP)		81512
1.9 D	47	05/93→05/01	1.905	D	M	4	8	DJZ (XUD9Y)	PROD→: 7391	81642
	47	05/93→05/01	1.905	D	M	4	8	DJZ (XUD9Y)	→PROD: 7390	81672
	50	06/94→04/02	1.905	D	M	4	8	DJY (XUD9A)	PROD→: 7391	81642
	50	06/94→04/02	1.905	D	M	4	8	DJY (XUD9A)	→PROD: 7390	81672
	51	09/98→04/02	1.868	D	M	4	8	WJY (DW8B), WJZ (DW8)		81713
	55	03/98→04/02	1.905	D	M	4	8	DHV (XUD9BSD)	PROD→: 7391	81642
1.9 DT	66	05/93→05/01	1.905	D	M	4	8	DHY (XUD9TE)	PROD→: 7391	81642
	66	05/93→05/01	1.905	D	M	4	8	DHY (XUD9TE)	→PROD: 7390	81672
1.9 SLD	47	06/94→05/01	1.905	D	M	4	8	DJZ (XUD9Y)	PROD→: 7391	81642
	47	06/94→05/01	1.905	D	M	4	8	DJZ (XUD9Y)	→PROD: 7390	81672
	50	06/94→05/01	1.905	D	M	4	8	DJY (XUD9A)	PROD→: 7391	81642
	50	06/94→05/01	1.905	D	M	4	8	DJY (XUD9A)	→PROD: 7390	81672
1.9 SRDT	66	06/94→05/01	1.905	D	M	4	8	DHY (XUD9TE)	PROD→: 7391	81642
	66	06/94→05/01	1.905	D	M	4	8	DHY (XUD9TE)	→PROD: 7390	81672
1.9 TD	66	02/97→04/02	1.905	D	M	4	8	DHY (XUD9TE)	PROD→: 7391	81642
	66	02/97→04/02	1.905	D	M	4	8	DHY (XUD9TE)	→PROD: 7390	81672
2.0	89	03/94→04/02	1.998	B	M	4	8	RFX (XU10J2)		81642
	97	03/97→04/02	1.998	B	M	4	16	RFV (XU10J4R)		81711
2.0 16V	97	03/97→04/02	1.998	B	M	4	16	RFV (XU10J4R)		81711
2.0 HDI 90	66	06/99→04/02	1.997	D	M	4	8	RHY (DW10TD)		81713
2.0 S16	110	06/94→05/01	1.998	B	M	4	16	RFT (XU10J4)		81642
	112	05/93→05/01	1.998	B	M	4	16	RFY (XU10J4Z)		81642
	120	03/96→05/01	1.998	B	M	4	16	RFS (XU10J4RS)		81711
2.0 ST	89	07/94→05/01	1.998	B	M	4	8	RFX (XU10J2)		81642
2.0 XSi	89	05/93→05/01	1.998	B	M	4	8	RFX (XU10J2)		81642

	kW		Cap. cm3	Fuel	Gear	No. of cyl.	No. of valves	Motor code		Short
--	----	--	----------	------	------	-------------	---------------	------------	--	-------

## PEUGEOT

### 307, BREAK, CC

1.4	55	08/00→09/03	1.360	B	M	4	8	KFW (TU3JP), TU3JP	→M: 3.666.765	81556
	55	08/00→09/03	1.360	B	M	4	8	KFW (TU3JP), TU3JP	M→: 3.666.766	81797
1.4 16V	65	11/03→	1.360	B	M	4	16	KFU (ET3J4)		82016
1.4 HDi	50	10/01→	1.398	D	M	4	8	8HX (DV4TD), 8HZ (DV4TD)		81798
1.6 16V	80	08/00→	1.587	B	M	4	16	NFU (TU5JP4)		81753
1.6 HDi	66	04/05→	1.560	D	M	4	16	9HX (DV6ATED4)		81869
1.6 HDi 110 FAP	80	02/04→	1.560	D	M	4	16	9HY (DV6TED4)		81869
2.0	100	03/02→	1.997	B	M	4	16	RFN (EW10J4)	(-)COP	81799
	100	03/02→	1.997	B	M	4	16	RFN (EW10J4)	(+)COP	82089
2.0 16V	100	08/00→	1.997	B	M	4	16	RFN (EW10J4)	(-)COP	81799
	100	08/00→	1.997	B	M	4	16	RFN (EW10J4)	(+)COP	82089
	103	03/05→	1.997	B	M	4	16	RFJ (EW10A)	M: EW10J4, (-)COP	81799
	103	03/05→	1.997	B	M	4	16	RFJ (EW10A)	(+)COP	82089
	130	10/03→	1.997	B	M	4	16	RFK (EW10J4S)	(-)COP	81799
	130	10/03→	1.997	B	M	4	16	RFK (EW10J4S)	(+)COP	82089
2.0 HDi 90	66	08/00→	1.997	D	M	4	8	RHY (DW10TD)		81713
2.0 HDi 110 FAP	79	08/00→	1.997	D	M	4	8	RHS (DW10ATED)		81713
2.0 HDi 135 FAP	100	10/03→	1.997	D	M	4	16	RHR (DW10BTED4)		81800

### 308, STATION WAGON, CC

1.4 16V	70	09/07→	1.397	B	M	4	16			82032
	72	12/09→	1.397	B	M	4	16			82032
1.6 16V	88	09/07→	1.598	B	M	4	16	EP6		82032
	103	09/07→	1.598	B	M	4	16			82032
	110	09/07→	1.598	B	M	4	16	EP6DT		82032
	115	06/09→	1.598	B	M	4	16	EP6CDT		82032
	128	03/08→	1.598	B	M	4	16	EP6DTS		82032
1.6 Bioflex	82	03/09→	1.587	FF	M	4	16			82032
1.6 GTi	147	07/10→	1.598	B	M	4	16	EP6CDTX		82032
1.6 HDi	66	09/07→	1.560	D	M	4	8			81869
	68	11/09→	1.560	D	M	4	16			81869
	80	09/07→	1.560	D	M	4	16	9HZ (DV6TED4)		81869
	82	06/09→	1.560	D	M	4	16			81869
2.0 Bioflex	103	01/08→	1.997	FF	M	4	16		(+)COP	82089
2.0 D	103	04/09→	1.997	D	M	4	16			81800
2.0 HDi	100	09/07→	1.997	D	M	4	16	RHR (DW10BTED4)		81800
	103	09/07→	1.997	D	M	4	16			81800

### 405 II, BREAK

1.4	55	08/92→10/96	1.361	B	M	4	8	KDX (TU3MC)		81513
1.6	65	08/92→10/96	1.580	B	M	4	8	BDY (XU5M2Z), BDY (XU5M3Z), BDZ (XU5M), BFZ (XU5JP)		81512
1.8	74	08/92→10/96	1.762	B	M	4	8	LFZ (XU7JP)		81512
1.9 D	47	08/92→10/96	1.905	D	M	4	8	DJZ (XUD9Y)		81512
	50	06/94→10/96	1.905	D	M	4	8	DJY (XUD9A)		81512
1.9 TD	66	08/92→10/96	1.905	D	M	4	8	DHY (XUD9TE)		81512
2.0	89	08/92→10/96	1.998	B	M	4	8	RFX (XU10J2)		81642



	kw		Cap. cm3	Fuel	Gear	No. of cyl.	No. of valves	Motor code		Short
--	----	--	----------	------	------	-------------	---------------	------------	--	-------

## PEUGEOT

### 405 II, BREAK

2.0 16V	110	06/94→10/95	1.998	B	M	4	16	RFT (XU10J4)		81642
2.0 4x4	89	08/92→10/96	1.998	B	M	4	8	RFX (XU10J2)		81642
2.0 MI-16	112	08/92→10/95	1.998	B	M	4	16	RFY (XU10J4Z)		81642
2.0 T 16 X4	144	08/92→10/95	1.998	B	M	4	16	RGZ (XU10J4TE/Z)		81642
2.0 X4	89	08/92→10/95	1.998	B	M	4	8	RFX (XU10J2)		81642

### 406, BREAK, COUPÉ

1.6	65	11/95→05/04	1.580	B	M	4	8	BFZ (XU5JP)		81512
1.8	66	05/97→05/04	1.761	B	AM	4	8	LFX (XU7JB)		81512
	66	05/97→10/04	1.761	B	M	4	8	LFX (XU7JB)	06-1997→	81512
	74	10/96→03/99	1.761	B	M	4	8	LFZ (XU7JP)		81512
	82	10/97→03/99	1.761	B	M	4	16			81710
1.8 16V	81	11/95→10/00	1.761	B	M	4	16	LFY (XU7JP4)		81710
	85	10/00→10/04	1.749	B	M	4	16	6FZ (EW7J4)		81710
1.9 D	55	10/96→10/04	1.905	D	M	4	8	DHW (XUD9SD)		81642
1.9 TD	66	01/96→10/04	1.905	D	M	4	8	DHX (XUD9TE)		81642
	68	01/96→05/04	1.905	D	M	4	8	DHY (XUD9TE)		81642
2.0	104	11/96→03/99	1.998	B	M	4	8	RGY (XU10J2TE)		81711
2.0 16V	97	11/95→12/04	1.998	B	M	4	16	RFV (XU10J4R)	→12-1999, →03-1999	81711
	97	11/95→10/04	1.998	B	M	4	16	RFV (XU10J4R)	04-1999→, (-)COP	81799
	97	11/95→10/04	1.998	B	M	4	16	RFV (XU10J4R)	(+)COP	82089
	99	01/99→10/00	1.997	B	M	4	16	RFR (DEW10J4)	(-)COP	81799
	99	01/99→10/00	1.997	B	M	4	16	RFR (DEW10J4)	(+)COP	82089
	100	08/00→12/04	1.997	B	M	4	16	RFN (EW10J4)	(-)COP	81799
	100	08/00→12/04	1.997	B	M	4	16	RFN (EW10J4)	(+)COP	82089
2.0 16V HPI	103	05/01→10/04	1.997	B	M	4	16	RLZ (EW10D)	(-)COP	81799
	103	05/01→10/04	1.997	B	M	4	16	RLZ (EW10D)	(+)COP	82089
2.0 HDI 90	66	02/99→10/04	1.997	D	M	4	8	RHY (DW10TD)		81713
2.0 HDI 110	80	06/98→04/04	1.997	D	M	4	8	RHZ (DW10ATED)		81713
2.0 HDi 110 FAP	79	08/01→10/04	1.997	D	M	4	8	RHS (DW10ATED)		81713
2.0 Turbo	108	04/96→10/04	1.998	B	M	4	8	RGX (XU10J2TE)		81642
2.1 TD 12V	80	01/96→10/04	2.088	D	M	4	12	P8C (XUD11BTE)		81353
2.2	116	07/00→12/04	2.230	B	M	4	16	3FZ (EW12J4)	(-)COP	81799
	116	07/00→12/04	2.230	B	M	4	16	3FZ (EW12J4)	(+)COP	82089
2.2 HDi FAP	98	03/00→12/04	2.179	D	M	4	16	4HX (DW12TED4/FAP)		81800
3.0 24V	140	10/96→10/04	2.946	B	M	6	24	XFZ (ES9J4)	→12-1999, →T: 08441, →PROD: 8554	81844
	140	10/96→10/04	2.946	B	M	6	24	XFZ (ES9J4)	T→: 08442	82042
3.0 V6	152	03/00→12/04	2.946	B	M	6	24	XFY (ES9J4S)	PROD→: 8555	81813
3.0 V6 24V	140	03/97→12/04	2.946	B	M	6	24	XFZ (ES9J4)	→T: 08441	81844
	140	03/97→12/04	2.946	B	M	6	24	XFZ (ES9J4)	T→: 08442	82042

### 407, BREAK, COUPÉ

1.6 HDi 110 FAP	80	05/04→	1.560	D	M	4	16	9HY (DV6TED4)		81869
1.8	85	05/04→	1.749	B	M	4	16	6FZ (EW7J4)	(-)COP	81799
	85	05/04→	1.749	B	M	4	16	6FZ (EW7J4)	(+)COP	82089
1.8 16V	92	09/05→	1.749	B	M	4	16	6FY (EW7A)	(-)COP	81799
	92	09/05→	1.749	B	M	4	16	6FY (EW7A)	(+)COP	82089

	kw		Cap. cm3	Fuel	Gear	No. of cyl.	No. of valves	Motor code		Short
--	----	--	----------	------	------	-------------	---------------	------------	--	-------

## PEUGEOT

### 407, BREAK, COUPÉ

2.0	100	05/04→	1.997	B	M	4	16	RFN (EW10J4)	(-)COP	81799
	100	05/04→	1.997	B	M	4	16	RFN (EW10J4)	(+)COP	82089
2.0 16V	103	09/05→	1.997	B	M	4	16	RFJ (EW10A)	(-)COP	81799
	103	09/05→	1.997	B	M	4	16	RFJ (EW10A)	(+)COP	82089
2.0 Bioflex	103	01/08→	1.997	FF	M	4	16		(+)COP	82089
2.0 HDi	93	05/04→07/08	1.997	D	M	4	16			81800
	100	10/05→	1.997	D	M	4	16	RHR (DW10BTED4)		81800
	103	08/08→	1.997	D	M	4	16			81800
	110	02/10→	1.997	D	M	4	16			81800
	120	06/09→	1.997	D	M	4	16			81800
2.0 HDi 135 FAP	100	05/04→	1.997	D	M	4	16	RHR (DW10BTED4)		81800
2.2	116	05/04→	2.230	B	M	4	16	3FZ (EW12J4)	(-)COP	81799
	116	05/04→	2.230	B	M	4	16	3FZ (EW12J4)	(+)COP	82089
	120	10/05→	2.230	B	M	4	16	3FY (EW12J4)	(-)COP	81799
	120	10/05→	2.230	B	M	4	16	3FY (EW12J4)	(+)COP	82089
2.2 16V	120	09/05→	2.230	B	M	4	16	3FY (EW12J4)	(-)COP	81799
	120	09/05→	2.230	B	M	4	16	3FY (EW12J4)	(+)COP	82089
2.2 HDi	120	06/08→	2.179	D	M	4	16			82068
2.2 HDi 170 FAP	125	05/06→	2.179	D	M	4	16	4HT (DW12BTED4)		82068
2.7 HDi	150	10/05→	2.720	D	M	6	24	UHZ (DT17)		82067
3.0	155	05/04→	2.946	B	M	6	24	XFV (ES9A)		81813
3.0 V6	155	10/05→	2.946	B	M	6	24	XFV (ES9A)		81813

### 508, STATION WAGON

1.6 HDi	82	11/10→	1.560	D	M	4	16			81869
1.6 THP	115	11/10→	1.598	B	M	4	16			82032
1.6 VTi	88	11/10→	1.598	B	M	4	16			82032
2.2 HDi	150	11/10→	2.179	D	M	4	16			82068

### BIPPER, TEPEE

1.4	54	02/08→	1.360	B	M	4	8			81797
1.4 HDi	50	02/08→	1.398	D	M	4	8			81798

### BOXER I

1.9 D	50	07/99→04/02	1.905	D	M	4	8	DJY (XUD9A)		81642
	51	03/94→04/02	1.905	D	M	4	8	D8C (XUD9AU)		81642
1.9 TD	66	08/94→04/02	1.905	D	M	4	8	DHY (XUD9TE), XUD9TE		81642
	68	03/94→04/02	1.905	D	M	4	8	D8C (XUD9UTF)		81642
1.9 TD 4x4	68	07/96→04/02	1.905	D	M	4	8	D8C (XUD9UTF)		81642
2.0	81	12/01→	1.998	B	M	4	8			81642
2.0 4x4	80	03/96→09/98	1.998	B	M	4	8			81642
2.0 HDI	62	08/01→04/02	1.997	D	M	4	8			81713
2.0 i	80	03/94→04/02	1.998	B	M	4	8	RFW (XU10J2)		81642
2.0 i 4x4	80	08/96→04/02	1.998	B	M	4	8	RFW (XU10J2)		81642
2.5 D	63	03/94→04/02	2.446	D	M	4	8	T9A (DJ5)	01-1999→, M: SOFIM	81316
	63	03/94→04/02	2.446	D	M	4	8	T9A (DJ5)	06-1996→, PROD→: 7144	81712
	63	03/94→04/02	2.446	D	M	4	8	T9A (DJ5)	→05-1996, →PROD: 7143	81752

	kW		Cap. cm3	Fuel	Gear	No. of cyl.	No. of valves	Motor code		Short
--	----	--	----------	------	------	-------------	---------------	------------	--	-------

## PEUGEOT

### BOXER I

2.5 D 4x4	63	07/96→04/02	2.446	D	M	4	8	T9A (DJ5)	M: SOFIM	81316
	63	07/96→04/02	2.446	D	M	4	8	T9A (DJ5)		81712
2.5 TD	76	03/94→04/02	2.446	D	M	4	8	T8A (DJ5T)	06-1996→, PROD→: 7144	81712
	76	03/94→04/02	2.446	D	M	4	8	T8A (DJ5T)	→05-1996, →PROD: 7143	81752
2.5 TD 4x4	76	07/96→04/02	2.446	D	M	4	8	T8A (DJ5T)	M: SOFIM	81316
	76	07/96→04/02	2.446	D	M	4	8	T8A (DJ5T)		81712
2.5 TDI	79	01/97→04/02	2.446	D	M	4	8	THX (DJ5TED)		81712
2.5 TDI 4x4	79	01/97→04/02	2.446	D	M	4	8	THX (DJ5TED)		81712
2.8 HDi	93	10/00→11/01	2.798	D	M	4	8	8140.43S		81316
	94	11/00→04/02	2.798	D	M	4	8	8140.43S		81316
2.8 HDi 4 ruote motrici	93	10/00→11/01	2.798	D	M	4	8	8140.43S		81316

### BOXER II

2.0	81	04/02→	1.998	B	M	4	8	RFL (XU10J2U)		81642
2.0 HDi	62	04/02→	1.997	D	M	4	8	RHV (DW10UTD)		81713
2.2 HDi	74	04/02→	2.179	D	M	4	8	4HY (DW12UTED)		81800
2.8 HDi	94	04/02→	2.798	D	M	4	8	8140.43S		81316
	107	04/04→	2.798	D	M	4	8			81316
2.8 HDi 4x4	94	04/02→	2.798	D	M	4	8	8140.43S		81316

### BOXER III

2.2 HDi 100	74	04/06→	2.198	D	M	4	16	4HV		82066
2.2 HDi 120	88	04/06→	2.198	D	M	4	16	4HU		82066
3.0 D	115	07/06→	2.998	D	M	4	16			82094
3.0 HDi	107	04/10→	2.999	D	M	4	16			82094
3.0 HDi 160	115	04/06→	2.999	D	M	4	16			82094
	116	04/06→	2.999	D	M	4	16			82094

### EXPERT I

1.6	58	02/96→	1.581	B	M	4	8	222A2 (1580SPI)	(+)COP	81346
	58	02/96→	1.581	B	M	4	8	222A2 (1580SPI)	(-)COP	81368
1.8	74	10/96→09/00	1.761	B	M	4	8	LFZ (XU7JP)		81512
1.9 D	51	06/98→11/03	1.868	D	M	4	8	WJZ (DW8)		81642
	51	02/96→	1.905	D	M	4	8	D9B (XUD9AU)		81642
1.9 D 70	51	12/98→	1.868	D	M	4	8	WJY (DW8B), WJZ (DW8)		81713
1.9 TD	66	02/96→	1.905	D	M	4	8	DHX (XUD9TE)		81642
	68	02/96→	1.905	D	M	4	8	D8B (XUD9TE)		81642
2.0	100	07/00→	1.997	B	M	4	16	RFN (EW10J4)	(-)COP	81799
	100	07/00→	1.997	B	M	4	16	RFN (EW10J4)	(+)COP	82089
2.0 HDi	69	10/00→10/06	1.997	D	M	4	8	RHX (DW10BTED)		81713
	69	07/00→	1.997	D	M	4	8	RHX (DW10BTED)		81800
	80	07/00→	1.997	D	M	4	8	RHZ (DW10ATED)		81713
	80	07/00→11/03	1.997	D	M	4	16	RHW (DW10ATED4)		81713
	80	07/00→	1.997	D	M	4	8	RHZ (DW10ATED)		81800
	80	07/00→	1.997	D	M	4	16	RHW (DW10ATED4)		81800
2.0 HDi Comfort	69	10/00→11/03	1.997	D	M	4	8	RHX (DW10BTED)		81713

	kw		Cap. cm3	Fuel	Gear	No. of cyl.	No. of valves	Motor code		Short
--	----	--	----------	------	------	-------------	---------------	------------	--	-------

## PEUGEOT

### EXPERT II, TEPEE

1.6 HDi 90	66	01/07→	1.560	D	M	4	16			81869
1.9 D	51	06/98→11/03	1.868	D	M	4	8			81642
2.0 16V	103	01/07→	1.997	B	M	4	16	RFJ (EW10A)	(-)COP	81799
	103	01/07→	1.997	B	M	4	16	RFJ (EW10A)	(+)COP	82089
2.0 HDi	69	10/00→10/06	1.997	D	M	4	8			81713
	80	10/00→11/03	1.997	D	M	4	16			81713
2.0 HDi 120	88	01/07→	1.997	D	M	4	16	RHK (DW10UTED4)		81800
2.0 HDi 140	100	01/07→	1.997	D	M	4	16	RHR (DW10BTED4)		81800

### PARTNER - RANCH, I

1.1	44	06/96→	1.124	B	M	4	8	HDZ (TU1M), HFX (TU1JP)	→10-2002	81556
	44	06/96→	1.124	B	M	4	8	HDZ (TU1M), HFX (TU1JP)	11-2002→	81797
1.4	55	06/96→	1.360	B	M	4	8	KFW (TU3JP), KFX (TU3JP)	→10-2002	81556
	55	06/96→	1.360	B	M	4	8	KFW (TU3JP), KFX (TU3JP)	11-2002→	81797
1.4 BiFuel	55	04/03→	1.360	BF	M	4	8	KFW (TU3JP)	→M: 3.666.765	81556
	55	04/03→	1.360	BF	M	4	8	KFW (TU3JP)	M→: 3.666.766	81797
1.6	80	09/00→10/02	1.587	B	M	4	16			81753
1.6 16V	80	07/01→	1.587	B	M	4	16	NFU (TU5JP4)		81753
1.6 HDi 75	55	02/06→	1.560	D	M	4	16			81869
1.6 HDi 90	66	02/06→	1.560	D	M	4	16	9HX (DV6ATED4)		81869
1.8	66	05/97→	1.761	B	M	4	8	LFX (XU7JB)	03-1997→	81512
1.8 D	43	06/96→	1.769	D	M	4	8	A9A (XUD7)	03-1997→	81512
1.9 D	50	05/96→12/98	1.905	D	M	4	8	DJY (XUD9A)		81642
	51	12/98→	1.868	D	M	4	8	WJY (DW8B), WJZ (DW8)		81642
	51	06/96→	1.868	D	M	4	8	WJY (DW8B), WJZ (DW8)		81713
	51	05/96→12/98	1.905	D	M	4	8	DJY (XUD9A), XUD9		81642
2.0 HDI	66	02/00→	1.997	D	M	4	8	RHY (DW10TD)		81713
2.0 HDi 4x4	66	04/04→	1.997	D	M	4	8	RHY (DW10TD)		81713
	66	04/04→08/05	1.997	D	M	4	8	RHY (DW10TD)		81800

### PARTNER - RANCH, II, TEPEE

1.6	66	04/08→	1.587	B	M	4	16			81753
	80	04/08→	1.587	B	M	4	16			81753
1.6 HDi	55	04/08→	1.560	D	M	4	16			81869
	66	04/08→	1.560	D	M	4	16	9HX (DV6ATED4)		81869
	80	04/08→	1.560	D	M	4	16			81869
	82	08/10→	1.560	D	M	4	16			81869

### RCZ

1.6 16V	115	03/10→	1.598	B	M	4	16	EP6CDT		82032
	147	06/10→	1.598	B	M	4	16	EP6CDTX		82032

## RENAULT

### 19 II, CHAMADE, VAN, CABRIO

1.2	40	04/92→12/95	1.237	B	M	4	8	C1G730	(-)COP	81573
	40	03/92→12/95	1.237	B	M	4	8	C1G730		81661
	40	04/92→12/95	1.237	B	M	4	8	C1G730	(+)COP	81811
	44	05/92→09/94	1.171	B	M	4	8	E7F730		81661

	kw		Cap. cm3	Fuel	Gear	No. of cyl.	No. of valves	Motor code		MAGNETI MARELLI Short
--	----	--	----------	------	------	-------------	---------------	------------	--	-----------------------

## RENAULT

### 19 II, CHAMADE, VAN, CABRIO

1.4	43	04/92→12/95	1.397	B	M	4	8	C3J710	(-)COP	81573
	43	04/92→12/95	1.397	B	M	4	8	C3J710	(+)COP	81811
	55	01/92→12/95	1.390	B	M	4	8	E7J742		81661
	59	01/92→12/95	1.390	B	M	4	8	E6J700, E7J706		81661
1.7	54	04/92→12/95	1.721	B	M	4	8	F3N740, F3N741		81574
	66	04/92→12/95	1.721	B	M	4	8	F3N742, F3N743		81574
1.8	65	04/92→06/96	1.794	B	M	4	8	F3P704, F3P705, F3P706, F3P707, F3P708, F3P760		81574
	66	04/92→06/96	1.794	B	M	4	8	F3P706, F3P760		81574
	79	05/94→12/95	1.783	B	M	4	8	F3P682		81574
	79	05/94→06/96	1.794	B	M	4	8	F3P682, F3P764, F3P765		81574
	81	04/92→05/94	1.794	B	M	4	8	F3P700		81574
1.8 16V	99	04/92→06/96	1.764	B	M	4	16	F7P704		81574
1.9 D	47	04/92→12/95	1.870	D	M	4	8	F8Q742		81574
	48	03/92→12/95	1.870	D	M	4	8	F8Q706, F8Q742		81574
1.9 dT	66	04/92→12/95	1.870	D	M	4	8	F8Q744		81574
	68	03/92→12/95	1.870	D	M	4	8	F8Q740		81574

### AVANTIME

2.0 16V Turbo	120	11/01→05/03	1.998	B	M	4	16	F4R760, F4R761		81814
2.2 dCi	110	05/02→05/03	2.188	D	M	4	16	G9T712		81855
3.0 V6	152	09/01→05/03	2.946	B	AM	6	24	L7X720, L7X721		81813

### CLIO I, VAN

1.1	34	01/91→09/98	1.108	B	M	4	8	C1E700	(-)COP, →05-1994, M: C1E700, (-)COP	81573
	34	01/91→09/98	1.108	B	M	4	8	C1E700	(+)COP, →05-1994, M: C1E700, (+)COP	81811
	36	04/92→08/92	1.108	B	M	4	8	C1E700	(-)COP, →05-1994, M: C1E700, (-)COP	81573
	36	04/92→08/92	1.108	B	M	4	8	C1E700	(+)COP, →05-1994, M: C1E700, (+)COP	81811
1.2	40	01/96→09/98	1.149	B	M	4	8	D7F730		81762
	40	01/91→09/98	1.171	B	M	4	8	E7F706		81661
	40	06/94→02/98	1.239	B	M	4	8	C3G720	(-)COP	81596
	40	06/94→02/98	1.239	B	M	4	8	C3G720	(+)COP	81854
	43	01/96→09/98	1.149	B	M	4	8	D7F730		81762
	43	05/90→09/98	1.171	B	M	4	8	E7F700, E7F708, E7F750		81661
	44	05/90→09/98	1.171	B	M	4	8	E5F710, E7F750		81661
1.4	55	01/91→09/98	1.390	B	M	4	8	E7J756, E7J757		81661
	58	01/91→09/98	1.390	B	M	4	8	E7J718, E7J719, E7J754		81661
	59	01/91→09/98	1.390	B	M	4	8	E7J710		81661
1.7	68	01/91→12/93	1.721	B	M	4	8	F2N770		81574
1.8	65	01/91→09/98	1.794	B	M	4	8	F3P710, F3P714		81574
	66	08/94→09/98	1.794	B	M	4	8	F3P754, F3P755		81574
	70	01/91→09/98	1.794	B	M	4	8	F3P710		81574
1.8 16V	99	01/91→03/96	1.764	B	M	4	16	F7P722		81574

**kw**

**Cap. cm3**
**Fuel**
**Gear**
**No. of cyl.**
**No. of valves**
**Motor code**

**MAGNETI MARELLI**  
Short

**RENAULT**
**CLIO I, VAN**

1.8 Rsi	79	08/95→09/98	1.783	B	M	4	8	F3P758		81574
	80	01/93→08/95	1.794	B	M	4	8	F3P712		81574
1.9 D	40	01/97→09/98	1.870	D	M	4	8	F8Q678		81574
	47	01/91→09/98	1.870	D	M	4	8	F8Q730, F8Q732		81574
	48	01/91→09/98	1.870	D	M	4	8	F8Q730, F8Q732		81574
1.9 RND	40	04/96→02/98	1.870	D	M	4	8	F8Q678		81574
Williams	108	01/94→09/98	1.998	B	M	4	16	F7R700		81574

**CLIO II, VAN**

1.1	43	09/98→	1.149	B	M	4	8	D7F720, D7F722		81762
1.2	43	09/98→	1.149	B	M	4	8	D7F710, D7F720, D7F726	→12-2003	81762
	43	09/98→	1.149	B	M	4	8	D7F710, D7F720, D7F726	01-2004→	82091
	44	03/99→10/03	1.149	B	M	4	8	D7F722, D7F726		81762
	55	06/01→10/03	1.149	B	M	4	8			81762
1.2 16V	55	06/01→	1.149	B	M	4	16	D4F712, D4F714	→05-2003	81820
	55	06/01→	1.149	B	M	4	16	D4F712, D4F714	06-2003→	82090
1.4	55	09/98→05/05	1.390	B	M	4	8	E7J780		81578
1.4 16V	70	10/99→08/00	1.390	B	M	4	16	K4J712, K4J713		81806
	72	08/00→	1.390	B	M	4	16	K4J700, K4J712, K4J713		81806
1.5 D	50	08/04→	1.461	D	M	4	8	K9K714		81810
1.5 dCi	47	06/05→	1.461	D	M	4	8	K9K740		81810
	48	06/01→	1.461	D	M	4	8	K9K700, K9K704		81810
	50	04/04→	1.461	D	M	4	8	K9K714		81810
	59	06/01→10/04	1.461	D	M	4	8	K9K702		81810
	60	06/01→	1.461	D	M	4	8	K9K702, K9K710		81810
	62	02/07→	1.461	D	M	4	8	K9K718		81810
	74	01/04→	1.461	D	M	4	8	K9K712		81810
1.6	66	09/98→05/05	1.598	B	M	4	8	K7M744, K7M745		81579
1.6 16V	79	09/98→	1.598	B	M	4	16	K4M708, K4M748		81806
1.6 X	79	11/03→	1.598	B	M	4	16	K4M746		81806
1.9 D	40	03/99→01/00	1.870	D	M	4	8	F8Q662		81574
	47	09/98→05/05	1.870	D	M	4	8	F8Q630		81574
	48	02/00→05/01	1.870	D	M	4	8	F8Q632		81574
1.9 dTi	59	12/99→05/05	1.870	D	M	4	8	F9Q780		81574
2.0 16V Sport	124	02/00→	1.998	B	M	4	16	F4R730		81574
	132	01/04→	1.998	B	M	4	16	F4R738		81574
3.0 V6 Sport	166	11/00→12/02	2.946	B	M	6	24	L7X760		81813
	187	12/02→	2.946	B	M	6	24	L7X762		81813

**CLIO III, GRANDTOUR**

1.2	43	09/06→	1.149	B	M	4	8	D7F726		82091
1.2 16V	48	06/05→	1.149	B	M	4	16	D4F740		82090
	55	06/05→	1.149	B	M	4	16	D4F740		82090
	58	06/05→	1.149	B	M	4	16	D4F764		82090
	74	05/07→	1.149	B	M	4	16	D4F784		82090
1.2 16V Hi-Flex	55	07/08→	1.149	FF	M	4	16	D4F740		82090
1.2 SL	57	10/05→	1.149	B	M	4	16	D4F764		82090

	kW		Cap. cm3	Fuel	Gear	No. of cyl.	No. of valves	Motor code		MAGNETI MARELLI Short
--	----	--	----------	------	------	-------------	---------------	------------	--	-----------------------

## RENAULT

### CLIO III, GRANDTOUR

1.4 16V	72	06/05→	1.390	B	M	4	16	K4J780		81806
1.5 D	60	11/07→	1.461	D	M	4	8	K9K750		81810
1.5 dCi	47	06/05→	1.461	D	M	4	8			81810
	48	05/05→10/06	1.461	D	M	4	8	K9K752		81810
	50	06/05→	1.461	D	M	4	8	K9K768		81810
	63	06/05→	1.461	D	M	4	8	K9K766		81810
	76	06/05→	1.461	D	M	4	8	K9K772		81810
	78	06/05→	1.461	D	M	4	8	K9K764		81810
1.6 16V	65	06/05→	1.598	B	M	4	16	K4M804		81806
	82	06/05→	1.598	B	M	4	16	K4M800, K4M801		81806
1.6 16V GT	94	06/09→	1.598	B	M	4	16	K4M862		81806
16V Hi-Flex	55	07/08→	1.149	FF	M	4	16	D4F740		82090
2.0 16V Sport	145	02/06→	1.998	B	M	4	16	F4R830		81814
	148	09/08→	1.998	B	M	4	16	F4R830		81814

### ESPACE II

2.0	76	01/91→10/96	1.995	B	M	4	8	J7R768		81666
2.1 RTDT Quadra	65	01/91→05/92	2.068	D	M	4	8	J8S772		81667
2.1 TD	65	01/91→10/96	2.068	D	M	4	8	J8S610, J8S772, J8S776, J8S778		81667
	66	11/94→10/96	2.068	D	M	4	8	J8S612		81667
2.2	79	01/91→10/96	2.165	B	M	4	8	J7T772, J7T773, J7T776		81666
2.2 4x4	79	03/91→12/96	2.165	B	M	4	8	J7T772, J7T773		81666

### ESPACE III

1.9 dTi	72	02/99→10/02	1.870	D	M	4	8	F9Q722		81574
2.0	84	11/96→10/00	1.998	B	M	4	8	F3R728, F3R729, F3R742, F3R768, F3R769		81574
	102	09/01→10/02	1.998	B	M	4	16	F4R700		81574
2.0 16V	103	10/98→10/02	1.998	B	M	4	16	F4R700, F4R701		81574
2.2 12V TD	83	11/96→10/00	2.188	D	M	4	12	G8T714, G8T716		81761
2.2 D	84	11/97→01/00	2.188	D	M	4	12	G8T716		81761
2.2 dCi	85	07/00→10/02	2.188	D	M	4	16	G9T710		81855
	95	10/00→10/02	2.188	D	M	4	16	G9T710		81855
3.0 V6 24V	140	10/98→10/02	2.946	B	M	6	24	L7X727	→T: 08441	81844
	140	10/98→10/02	2.946	B	M	6	24	L7X727	T→: 08442	82042

### ESPACE IV

1.9 dCi	88	11/02→	1.870	D	M	4	8	F9Q680, F9Q820, F9Q826		81814
1.9 DCi Expression	85	04/03→02/05	1.870	D	M	4	8	F9Q820		81814
2.0	98	11/02→02/05	1.998	B	M	4	16	F4R790		81814
	100	11/02→	1.998	B	M	4	16	F4R790, F4R792		81814
	125	04/05→	1.998	B	M	4	16	F4R897		81814
2.0 dCi	96	01/06→	1.995	D	M	4	16			82069
	110	01/06→	1.995	D	M	4	16	M9R740		82069
	127	01/06→	1.995	D	M	4	16	M9R760		82069
2.0 Turbo	120	11/02→	1.998	B	AM	4	16	F4R794, F4R795, F4R797		81814
2.2 dCi	102	02/06→	2.188	D	M	4	16	G9T645		81855
	110	11/02→	2.188	D	M	4	16	G9T742, G9T743		81855

	kw		Cap. cm3	Fuel	Gear	No. of cyl.	No. of valves	Motor code		Short
--	----	--	----------	------	------	-------------	---------------	------------	--	-------

## RENAULT

### ESPACE IV

3.0 dCi	130	11/02→	2.958	D	M	6	24	P9X701		81871
	133	01/06→	2.958	D	M	6	24	P9X715		81871

### KANGOO I

1.2	43	08/97→	1.149	B	M	4	8	D7F710, D7F720, D7F722, D7F726, D7F744, D7F746		81762
	44	07/98→07/01	1.149	B	M	4	8	D7F764		81762
1.2 16V	55	06/01→	1.149	B	M	4	16	D4F712, D4F714, D4F716		81820
1.4	55	08/97→	1.390	B	M	4	8	E7J634, E7J635, E7J780, K7J700, K7J701	M: E7J 634, M: E7J 780, M: E7J 635, M: E7J 634	81578
	55	08/97→	1.390	B	M	4	8	E7J634, E7J635, E7J780, K7J700, K7J701	M: K7J 701, M: K7J 700	81579
1.5 dCi	42	12/02→	1.461	D	M	4	8	K9K704		81810
	48	12/01→	1.461	D	M	4	8	K9K700, K9K704		81810
	50	06/05→	1.461	D	M	4	8	K9K714		81810
	60	07/02→	1.461	D	M	4	8	K9K702, K9K710		81810
	62	06/05→	1.461	D	M	4	8	K9K718		81810
1.6	66	09/99→06/01	1.598	B	M	4	8	K7M746		81579
1.6 16V	70	06/01→	1.598	B	M	4	16	K4M750, K4M752, K4M753		81806
1.6 16V 4x4	70	10/01→	1.598	B	M	4	16	K4M750, K4M752, K4M753		81806
1.6 16V bivalent	60	06/05→	1.598	BF	M	4	16			81806
1.9 D	48	09/99→06/03	1.870	D	M	4	8	F8Q632		81574
1.9 dCi	62	07/03→	1.870	D	M	4	8	F9Q790		81574
1.9 dCi 4x4	59	10/01→	1.870	D	M	4	8	F9Q782, F9Q790		81574
	62	07/03→	1.870	D	M	4	8	F9Q790		81574
1.9 dTi	59	02/00→	1.870	D	M	4	8	F9Q780, F9Q782		81574
1.9 RXED	48	09/99→06/01	1.870	D	M	4	8	F8Q632		81574
D 55 1.9	40	08/97→	1.870	D	M	4	8	F8Q662		81574
D 65 1.9	47	08/97→	1.870	D	M	4	8	F8Q630, F8Q632		81574

### KANGOO II, BEPOP

1.5 dCi	50	02/08→	1.461	D	M	4	8	K9K840		81810
1.5 dCi	63	02/08→	1.461	D	M	4	8	K9K802		81810
1.5 dCi	66	06/09→	1.461	D	M	4	8			82098
1.5 dCi	76	02/08→	1.461	D	M	4	8	K9K804, K9K806		81810
1.6	64	02/08→	1.598	B	M	4	8	K7M750		81579
	78	02/09→	1.598	B	M	4	16	K4M830		81806
1.6 16V	78	02/08→	1.598	B	M	4	16			81806
1.6 16V Hi-Flex	78	02/08→	1.598	FF	M	4	16			81806
1.6 16V LPG	72	02/08→	1.598		M	4	16			81806

### ESPACE II

2.0 dCi	110	09/08→	1.995	D	M	4	16	M9R832		82069
	130	09/08→	1.995	D	M	4	16			82069
2.0 dCi 4x4	110	09/08→	1.995	D	M	4	16	M9R832		82069
	127	09/08→	1.995	D	M	4	16	M9R830		82069



	kw		Cap. cm3	Fuel	Gear	No. of cyl.	No. of valves	Motor code		MAGNETI MARELLI Short
--	----	--	----------	------	------	-------------	---------------	------------	--	-----------------------

## RENAULT

### LAGUNA I, GRANDTOUR

1.6 16V	79	11/97→03/01	1.598	B	M	4	16	K4M720, K4M724		81806
1.8	66	08/95→03/01	1.783	B	M	4	8	F3P670, F3P678		81574
	66	11/93→03/01	1.794	B	M	4	8	F3P720, F3P724		81574
	69	06/95→02/01	1.783	B	M	4	8	F3P674		81574
	69	08/95→03/01	1.794	B	M	4	8	F3P720, F3P724		81574
	70	06/95→06/98	1.783	B	M	4	8	F3P676		81574
	70	06/95→06/98	1.794	B	M	4	8	F3P676		81574
1.8 16V	88	04/98→03/01	1.783	B	M	4	16	F4P760		81574
1.9 dCi	79	09/99→03/01	1.870	D	M	4	8	F9Q718		81814
1.9 dTi	72	10/97→03/01	1.870	D	M	4	8	F9Q710, F9Q716		81574
2.0	70	11/93→03/01	1.994	B	M	4	8			81574
	80	03/99→03/01	1.998	B	A	4	8	F3R611		81574
	83	11/93→03/01	1.998	B	M	4	8	F3R722, F3R723		81574
	84	06/95→02/01	1.998	B	M	4	8	F3R768		81574
	102	09/99→02/01	1.998	B	M	4	16	F4R780		81574
	103	06/95→02/01	1.948	B	M	4	16	N7Q700		82056
2.0 16V	102	06/95→03/01	1.948	B	M	4	16	N7Q700, N7Q704		82056
	103	09/99→03/01	1.998	B	M	4	16	F4R780		81814
2.2 D	61	11/93→03/01	2.188	D	M	4	12	G8T706, G8T752, G8T790, G8T794		81760
2.2 dT	83	03/96→03/01	2.188	D	M	4	12	G8T760		81761
3.0 24V	140	03/97→03/01	2.946	B	M	6	24	L7X700, L7X701	→T: 08441	81844
	140	03/97→03/01	2.946	B	M	6	24	L7X700, L7X701	T→: 08442	82042

### LAGUNA II, GRANDTOUR

1.6 16V	79	03/01→	1.598	B	M	4	16	K4M710, K4M711		81806
	82	02/05→	1.598	B	M	4	16	K4M716		81806
1.6 FlexFuel	76	06/01→10/03	1.598	B	M	4	16	K4M718		81806
1.8 16V	85	03/01→	1.783	B	A	4	16	F4P770, F4P771, F4P773, F4P774, F4P775	M: F4P 775	81806
	85	03/01→	1.783	B	A	4	16	F4P770, F4P771, F4P773, F4P774, F4P775		81814
	88	03/01→	1.783	B	M	4	16	F4P770, F4P773		81814
	89	03/01→	1.783	B	AM	4	16	F4P770, F4P774		81814
	89	03/01→	1.783	B	M	4	16	F4P770, F4P774		81814
1.9 dCi	68	03/04→	1.870	D	M	4	8	F9Q664		81868
	74	10/01→	1.870	D	M	4	8	F9Q754		81814
	77	06/01→	1.870	D	AM	4	8	F9Q752		81814
	79	03/01→	1.870	D	M	4	8	F9Q718		81814
	81	01/05→	1.870	D	M	4	8	F9Q674		81868
	88	03/01→	1.870	D	M	4	8	F9Q750, F9Q756		81814
	96	05/05→	1.870	D	M	4	8	F9Q758		81868
2.0	95	09/02→05/05	1.998		M	4	16	F4R713		81814
2.0 16V	99	08/02→	1.998	B	M	4	16	F4R712, F4R713, F4R714, F4R715		81814
	125	01/05→	1.998	B	M	4	16	F4R786, F4R787		81814
	150	01/05→	1.998	B	M	4	16	F4R886		81814

	kw		Cap. cm3	Fuel	Gear	No. of cyl.	No. of valves	Motor code		Short
--	----	--	----------	------	------	-------------	---------------	------------	--	-------

## RENAULT

### LAGUNA II, GRANDTOUR

2.0 16V IDE	103	04/01→	1.998	B	AM	4	16	F5R700		81814
2.0 16V Turbo	120	01/03→	1.998	B	M	4	16	F4R764, F4R765, F4R786, F4R787		81814
2.0 dCi	110	08/05→	1.995	D	M	4	16	M9R740		82069
	127	01/06→	1.995	D	M	4	16	M9R760		82069
2.2 dCi	102	05/05→	2.188	D	M	4	16	G9T600		81855
	110	10/01→	2.188	D	AM	4	16	G9T702		81855
2.2 DCi Authentique	85	04/04→10/05	2.188	D	M	4	16	G9T600		81855
3.0 V6 24V	152	03/01→	2.946	B	A	6	24	L7X731		81813
	152	03/01→	2.946	B	M	6	24	L7X731		81813

### LAGUNA III, GRANDTOUR

1.5 dCi	81	10/07→	1.461	D	M	4	8	K9K780		81810
1.6 16V	81	10/07→	1.598	B	M	4	16	K4M824		81806
2.0 16V Turbo	125	10/07→	1.998	B	M	4	16	F4R811		81814
2.0 dCi	96	10/07→	1.995	D	M	4	16	M9R802		82069
	110	10/07→	1.995	D	M	4	16	M9R740, M9Ra742		82069
	127	01/08→	1.995	D	M	4	16	M9R800, M9R816		82069
2.0 dCi GT	131	03/08→	1.995	D	M	4	16	M9R816, M9Rk816		82069
2.0 GT	150	03/08→	1.998	B	M	4	16	F4R800, F4Rt800		81814
3.0 dCi	173	09/08→	2.998	D	M	6	24	M9R891		82069

### LOGAN, STATION WAGON

1.4	55	09/04→	1.390	B	M	4	8	K7J710		81579
1.5 DCi	50	04/07→	1.461	D	M	4	8	K9K792		81810
1.6	64	09/04→	1.598	B	M	4	8	K7M710		81579
	77	04/07→	1.598	B	M	4	16	K4M690, K7M690		81806

### MASTER I

28-35 2.0	58	10/86→07/98	1.995	B	M	4	8	J5R718, J5R728	M→: F029.329	81754
	58	10/86→07/98	1.995	B	M	4	8	J5R718, J5R728	→M: F029.328	81828
	59	08/80→10/86	1.995	B	M	4	8	829730, 829731	M→: F029.329	81754
	59	08/80→10/86	1.995	B	M	4	8	829730, 829731	→M: F029.328	81828
28-35 2.1 D	44	08/80→07/98	2.068	D	M	4	8	J8S330		81576
28-35 2.4 D	52	08/80→08/89	2.445	D	M	4	8	8140.61.2300, S8U731		81334
28-35 2.5 D	52	09/80→07/98	2.445	D	M	4	8	8140.61.2300, S8U731		81334
	55	08/89→07/98	2.499	D	M	4	8	8140.67.2510, S8U742		81334
	55	08/89→07/98	2.499	D	M	4	8	8140.67.2510, S8U742		81334
30 2,2	67	08/80→07/98	2.165	B	M	4	8	J7T782, J7T788	M→: F305.273	81666
	67	08/80→07/98	2.165	B	M	4	8	J7T782, J7T788	→M: F305.272	81828

### MASTER II

1.9 dCi 80	60	11/01→	1.870	D	M	4	8	F9Q772		81814
1.9 dTI	59	09/00→	1.870	D	M	4	8	F9Q770		81574
2.2 dCi 90	66	09/00→	2.188	D	M	4	16	G9T722		81855
2.5 D	59	07/98→01/01	2.499	D	M	4	8	S8U770	11-1989→	81491
	59	07/98→01/01	2.499	D	M	4	8	S8U770		81834
2.5 dCi 120	84	10/01→	2.463	D	M	4	16	G9U720, G9U754		81855
2.8 dTI	84	07/98→10/01	2.799	D	M	4	8	S9W702	→12-1999	81834
	84	07/98→10/01	2.799	D	M	4	8	S9W702	01-2000→	81835

	kw		Cap. cm3	Fuel	Gear	No. of cyl.	No. of valves	Motor code		MAGNETI MARELLI Short
--	----	--	----------	------	------	-------------	---------------	------------	--	-----------------------

## RENAULT

### MASTER III

2.5 dCi 100	73	10/03→	2.463	D	M	4	16	G9U754		81855
-------------	----	--------	-------	---	---	---	----	--------	--	-------

### MEGANE I, COACH, GRANTOUR, SCENIC

1.4	55	09/96→	1.390	B	M	4	8	E7J626, E7J764		81578
1.4 16V	70	03/99→08/03	1.390	B	M	4	16	K4J714, K4J750		81806
1.4 e	55	01/96→	1.390	B	M	4	8	E7J626, E7J764		81578
1.4 Eco	52	01/96→03/99	1.390	B	M	4	8	E7J624		81578
1.4 i	55	01/97→09/99	1.390	B	M	4	8	E7J764		81578
1.6 16V	79	03/99→08/03	1.598	B	M	4	16	K4M700, K4M701, K4M704, K4M708		81806
1.6 e	66	01/96→09/99	1.598	B	M	4	8	K7M702, K7M703, K7M790		81579
1.6 i	55	01/96→09/99	1.598	B	M	4	8	K7M720		81579
1.8 16V	85	01/01→	1.783	B	M	4	16	F4P720, F4P722		81574
1.9 D	47	09/96→09/99	1.870	D	M	4	8	F8Q620, F8Q622, F8Q624, F8Q790		81574
1.9 D Eco	47	01/96→	1.870	D	M	4	8	F8Q620, F8Q624		81574
1.9 dCi	75	02/01→08/03	1.870	D	M	4	8	F9Q732, F9Q733, F9Q738		81814
1.9 dT	66	01/96→09/99	1.870	D	M	4	8	F8Q784, F8Q786		81574
1.9 dTi	72	03/97→02/01	1.870	D	M	4	8	F9Q730, F9Q731, F9Q734, F9Q736		81574
	59	02/01→	1.870	D	M	4	8	F9Q744		81574
1.9 TDI	69	09/96→	1.870	D	M	4	8	F8Q784	10-1996→	81574
2.0	84	04/97→	1.998	B	M	4	8	F3R750		81574
2.0 16V	108	03/96→11/99	1.998	B	M	4	16	F7R710, F7R714		81574
	102	01/02→08/03	1.998	B	M	4	16	F4R770		81574
2.0 16V IDE	103	11/99→08/03	1.998	B	M	4	16	F5R740		81574
2.0 i	84	01/96→08/03	1.998	B	M	4	8	F3R750, F3R751		81574
	80	01/99→08/03	1.998	B	M	4	8	F3R750, F3R752, F3R791, F3R796		81574
2.0 RT	112	10/96→02/99	1.998	B	M	4	16			81574
2.0 RXE 4x4	84	05/97→10/99	1.998	B	M	4	8	F3R750		81574

### MEGANE II, STATION WAGON, C-C, SCENIC

1.4	60	09/03→	1.390	B	M	4	16	K4J732		81806
	72	08/03→	1.390	B	M	4	16	K4J730		81806
1.4 16V	60	10/03→	1.390	B	M	4	16	K4J732		81806
	72	11/02→	1.390	B	M	4	16	K4J730		81806
1.5 dCi	60	11/02→	1.461	D	M	4	8	K9K722		81810
	63	05/05→	1.461	D	M	4	8	K9K724		81810
	74	10/03→	1.461	D	M	4	8	K9K729		81810
	76	01/07→	1.461	D	M	4	8	K9K728		81810
	78	05/05→	1.461	D	M	4	8	K9K732		81810
1.6	75	09/03→	1.598	B	M	4	16	K4M768		81806
	77	05/05→	1.598	B	M	4	16	K4M762		81806
	83	08/03→	1.598	B	M	4	16	K4M760		81806
1.6 16V	82	01/07→	1.598	B	M	4	16	K4M760, K4M812		81806
	83	11/02→	1.598	B	M	4	16	K4M760		81806
1.6 Flex-Fuel	77	01/07→	1.598	FF	M	4	16	K4M762, K4M788		81806
1.6 GL	77	06/05→	1.598	B	M	4	16	K4M788		81806
1.6 Turbo Sport	77	06/05→	1.598	B	M	4	16	K4M788		81806



kW



Cap. cm3

Fuel

Gear

No. of cyl.

No. of valves

Motor code



MAGNETI MARELLI  
Short

## RENAULT

### MEGANE II, STATION WAGON, C-C, SCENIC

1.9 dCi	66	11/02→12/05	1.870	D	M	4	8	F9Q808		81868
	68	03/04→	1.870	D	M	4	8	F9Q808		81868
	81	05/05→	1.870	D	M	4	8	F9Q816, F9Q818		81868
	88	11/02→	1.870	D	M	4	8	F9Q750, F9Q800		81868
	96	05/05→	1.870	D	M	4	8	F9Q803		81868
2.0	99	08/03→	1.998	B	M	4	16	F4R770		81814
	169	08/06→	1.998	B	M	4	16			81814
2.0 16V	99	11/02→	1.998	B	M	4	16	F4R770		81814
2.0 16V Turbo	120	05/04→	1.998	B	M	4	16	F4R776		81814
2.0 dCi	110	09/05→	1.995	D	M	4	16	M9R700		82069
	127	01/07→	1.995	D	M	4	16	M9R724		82069
2.0 DCi Dynamic	110	09/05→	1.995	D	M	4	16	M9R700		82069
2.0 Renault Sport	165	05/04→	1.998	B	M	4	16	F4R774		81814

### MEGANE III, STATION WAGON, C-C, SCENIC

1.5 dCi	66	11/08→	1.461	D	M	4	8	K9K834, K9KH834		82098
	78	02/09→	1.461	D	M	4	8	K9KG832		81810
	81	02/09→	1.461	D	M	4	8	K9K836, K9KJ836		82098
	96	11/08→	1.461	D	M	4	8			82098
1.6	74	11/08→	1.598	B	M	4	16			81806
1.6 16V	74	05/09→	1.598	B	M	4	16			81806
	81	11/08→	1.598	B	M	4	16	K4M858		81806
	82	06/09→	1.598	B	M	4	16			81806
1.6 16V Bifuel	81	11/08→	1.598	BF	M	4	16	K4M866		81806
1.9 dCi	96	11/08→	1.870	D	M	4	8	F9Q870, F9Q872		82099
2.0	132	11/08→	1.998	B	M	4	16	F4R870		81814
2.0 16V	103	05/09→	1.997	B	M	4	16	M4RF713		82069
	132	11/08→	1.998	B	M	4	16	F4R870		81814
2.0 dCi	118	04/09→	1.995	D	M	4	16	M9R610		82069
2.0 TCe	132	06/10→	1.998	B	M	4	16			81814

### MODUS

1.2	48	05/05→	1.149	B	M	4	16	D4F740		81820
	55	12/04→	1.149	B	M	4	16	D4F740		81820
	58	12/04→	1.149	B	M	4	16	D4F764		81820
1.2 16V	74	05/07→	1.149	B	M	4	16	D4F784		81820
1.2 16V Hi-Flex	55	10/08→	1.149	FF	M	4	16	D4F740		81820
1.4	72	12/04→	1.390	B	M	4	16	K4J770		81806
1.5 dCi	48	12/04→	1.461	D	M	4	8	K9K752		81810
	50	12/04→	1.461	D	M	4	8	K9K768		81810
	60	09/05→	1.461	D	M	4	8			81810
	63	12/04→	1.461	D	M	4	8	K9K766		81810
	76	05/07→	1.461	D	M	4	8	K9K772		81810
	78	05/05→	1.461	D	M	4	8	K9K764		81810
1.5 dCi 75	55	10/10→	1.461	D	M	4	8			81810
1.5 dCi 90	65	10/10→	1.461	D	M	4	8			81810
1.6	65	12/04→	1.598	B	M	4	16	K4M792		81806
	82	12/04→	1.598	B	M	4	16	K4M790, K4M791		81806

	kW		Cap. cm3	Fuel	Gear	No. of cyl.	No. of valves	Motor code		Short
--	----	--	----------	------	------	-------------	---------------	------------	--	-------

## RENAULT

### RAPID, EXPRESS

1.0	27	02/86→05/92	949	B	M	4	8		(-)COP, (-)AC, (-)COP	81573
	27	02/86→05/92	949	B	M	4	8		(-)COP, (+)AC	81756
	27	02/86→05/92	949	B	M	4	8		(+)COP, (-)AC, (+)COP	81811
	27	02/86→05/92	949	B	M	4	8		(+)COP, (+)AC	81853
1.1	33	07/85→04/95	1.108	B	M	4	8	C1E750, C1E752, C1E754, C1E756, C1E760, C1E762, C1E792	(-)COP, (-)AC, (-)COP	81573
	33	07/85→04/95	1.108	B	M	4	8	C1E750, C1E752, C1E754, C1E756, C1E760, C1E762, C1E792	(-)COP, (+)AC	81756
	33	07/85→04/95	1.108	B	M	4	8	C1E750, C1E752, C1E754, C1E756, C1E760, C1E762, C1E792	(+)COP, (-)AC, (+)COP	81811
	33	07/85→04/95	1.108	B	M	4	8	C1E750, C1E752, C1E754, C1E756, C1E760, C1E762, C1E792	(+)COP, (+)AC	81853
1.2	40	09/91→03/98	1.239	B	M	4	8	C3G710, C3G712	(-)COP, (-)AC, (-)COP	81573
	40	09/91→03/98	1.239	B	M	4	8	C3G710, C3G712	(-)COP	81596
	40	09/91→03/98	1.239	B	M	4	8	C3G710, C3G712	(-)COP, (+)AC	81756
	40	09/91→03/98	1.239	B	M	4	8	C3G710, C3G712	(+)COP, (-)AC, (+)COP	81811
	40	09/91→03/98	1.239	B	M	4	8	C3G710, C3G712	(+)COP, (+)AC	81853
	40	09/91→03/98	1.239	B	M	4	8	C3G710, C3G712	(+)COP, 05-1995→	81854
1.4	43	07/85→03/98	1.397	B	M	4	8	C1J768, C1J780, C3J700, C3J702, C3J760, C3J762	(-)COP, (-)AC, (-)COP	81573
	43	07/85→03/98	1.397	B	M	4	8	C1J768, C1J780, C3J700, C3J702, C3J760, C3J762	(-)COP, (+)AC	81756
	43	07/85→03/98	1.397	B	M	4	8	C1J768, C1J780, C3J700, C3J702, C3J760, C3J762	(+)COP, (-)AC, (+)COP	81811
	43	07/85→03/98	1.397	B	M	4	8	C1J768, C1J780, C3J700, C3J702, C3J760, C3J762	(+)COP, (+)AC	81853
	44	03/86→08/91	1.397	B	M	4	8	C2J784	(-)COP, (-)AC, (-)COP	81573
	44	03/86→08/91	1.397	B	M	4	8	C2J784	(-)COP, (+)AC	81756
	44	03/86→08/91	1.397	B	M	4	8	C2J784	(+)COP, (-)AC, (+)COP	81811
	44	03/86→08/91	1.397	B	M	4	8	C2J784	(+)COP, (+)AC	81853
	55	09/91→03/98	1.390	B	M	4	8	E7J720, E7J724, E7J726, E7J773	01-1996→	81578
	55	09/91→03/98	1.390	B	M	4	8	E7J720, E7J724, E7J726, E7J773		81661
1.4 RN	44	09/91→08/93	1.390	B	M	4	8	E6J734	(-)COP, (-)AC, (-)COP	81573
	44	09/91→08/93	1.390	B	M	4	8	E6J734	(-)COP, (+)AC	81756
	44	09/91→08/93	1.390	B	M	4	8	E6J734	(+)COP, (-)AC, (+)COP	81811
	44	09/91→08/93	1.390	B	M	4	8	E6J734	(+)COP, (+)AC	81853
1.6 D	40	09/93→04/95	1.595	D	M	4	8	F8M736		81574
	40	03/86→08/98	1.596	D	M	4	8	F8M720, F8M730, F8M736, F8M760		81574
1.9 D	40	09/94→03/98	1.870	D	M	4	8	F8Q640, F8Q682		81574
	47	09/91→03/98	1.870	D	M	4	8	F8Q722, F8Q724, F8Q774, F8Q776		81574

	kw		Cap. cm3	Fuel	Gear	No. of cyl.	No. of valves	Motor code		Short
--	----	--	----------	------	------	-------------	---------------	------------	--	-------

## RENAULT

### SAFRANE I

2.0	77	11/92→07/96	1.995	B	M	4	8	J7R732, J7R733		81759
2.0 12V	97	04/92→07/96	1.995	B	M	4	12	J7R734, J7R735		81759
2.1 dT	65	11/93→07/96	2.068	D	M	4	8	J8S760	→M: 920.501, (-)AC	81757
	65	11/93→07/96	2.068	D	M	4	8	J8S760	M→: 920.502, (+)AC, (-)AC	81758
2.2	79	04/92→07/96	2.165	B	M	4	8	J7T762		81759
	101	04/92→07/96	2.165	B	M	4	12	J7T760, J7T761		81759
2.5 dT	83	12/92→07/96	2.500	D	M	4	8	S8U762, S8U763		81325
3.0 Biturbo 4x4	193	02/93→07/96	2.963	B	M	6	12	Z7X726		81764
3.0 V6	123	12/92→07/96	2.963	B	M	6	12	Z7X721, Z7X722, Z7X723		81764
3.0 V6 4x4	123	12/92→07/96	2.963	B	M	6	12	Z7X721, Z7X722, Z7X723		81764

### SAFRANE II

2.0 16V	100	07/96→12/00	1.948	B	M	4	16	N7Q710, N7Q711		81759
2.2 dT	83	07/96→12/00	2.188	D	M	4	12	G8T740		81761
2.5 20V	121	07/96→12/00	2.435	B	M	5	20	N7U700, N7U701		81846
2.9 24V	140	03/99→12/00	2.946	B	A	6	24	L7X713	→T: 08441	81844
	140	03/99→12/00	2.946	B	A	6	24	L7X713	T→: 08442	82042
3.0 V6	123	07/96→12/00	2.963	B	M	6	12	Z7X721, Z7X722, Z7X723		81844

### SCENIC I, GRAND SCENIC

1.4 16V	70	09/99→08/03	1.390	B	M	4	16	K4J714, K4J750		81806
1.5 dCi	74	04/04→	1.461	D	M	4	8	K9K728		81810
	78	05/05→	1.461	D	M	4	8	K9K728		81810
1.6	75	03/01→08/03	1.598	B	M	4	16	K4M708		81574
	77	06/06→	1.598	B	M	4	16	K4M788		81806
	83	04/04→	1.598	B	M	4	16	K4M761		81806
1.6 16V	79	09/99→08/03	1.598	B	M	4	16	K4M700, K4M701, K4M704, K4M708		81806
1.6 e	66	09/99→	1.598	B	M	4	8	K7M702, K7M703		81579
1.6 i	55	09/99→	1.598	B	M	4	8	K7M720		81579
1.8 16V	85	01/01→08/03	1.783	B	M	4	16	F4P720, F4P722		81574
1.8 4x4	85	07/00→04/01	1.783	B	M	4	16	F4P722		81574
1.9 dCi	75	09/99→08/03	1.870	D	M	4	8	F9Q732, F9Q733		81574
	81	05/05→	1.870	D	M	4	8	F9QE804		81868
	88	04/04→	1.870	D	M	4	8	F9Q812		81868
	96	05/05→	1.870	D	M	4	8	F9Q816		81868
1.9 dCi RX4	75	11/00→08/03	1.870	D	M	4	8	F9Q740		81574
1.9 dTi	59	02/01→08/03	1.870	D	M	4	8	F9Q744		81574
	72	09/99→08/03	1.870	D	M	4	8	F9Q731, F9Q734, F9Q736		81574
2.0	99	04/04→	1.998	B	M	4	16	F4R770		81814
	120	04/04→	1.998	B	M	4	16	F4R776		81814
2.0 16V	102	07/00→08/03	1.998	B	M	4	16	F4R740, F4R741		81574
2.0 16V IDE	103	09/99→08/03	1.998	B	M	4	16	F4R740	10-1996→	81574
2.0 16V RX4	102	06/00→08/03	1.998	B	M	4	16	F4R744		81574
2.0 dCi	110	09/05→	1.995	D	M	4	16	M9R700		82069

	kW		Cap. cm3	Fuel	Gear	No. of cyl.	No. of valves	Motor code		Short
--	----	--	----------	------	------	-------------	---------------	------------	--	-------

## RENAULT

### SCENIC II, GRAND SCENIC

1.4	72	06/03→	1.390	B	M	4	16	K4J730		81806
1.5 dCi	60	06/03→	1.461	D	M	4	8	K9K722		81810
	63	05/05→	1.461	D	M	4	8	K9K722		81810
	74	11/03→	1.461	D	M	4	8	K9K728		81810
	76	01/07→	1.461	D	M	4	8	K9K728		81810
	78	05/05→	1.461	D	M	4	8	K9K732		81810
1.6	77	06/06→	1.598	B	M	4	16	K4M788		81806
	83	06/03→	1.598	B	M	4	16	K4M761, K4M782		81806
1.6 16V	82	01/07→	1.598	B	M	4	16	K4M812		81806
1.9 D	85	06/06→	1.870	D	M	4	8	F9Q812		81868
1.9 dCi	81	05/05→	1.870	D	M	4	8	F9Q803		81868
	88	06/03→	1.870	D	M	4	8	F9Q812		81868
	96	05/05→	1.870	D	M	4	8	F9Q804		81868
2.0	99	06/03→	1.998	B	M	4	16	F4R770, F4R771		81814
2.0 16V Turbo	120	05/04→	1.998	B	M	4	16	F4R776		81814
2.0 dCi	110	09/05→	1.995	D	M	4	16	M9R700		82069

### SCENIC III, GRAND SCENIC

1.5 dCi	78	02/09→	1.461	D	M	4	8	K9K832		81810
1.6 16V	82	02/09→	1.598	B	M	4	16	K4M9766		81806
1.9 dCi	96	02/09→	1.870	D	M	4	8	F9Q870		82099
2.0 dCi	110	02/09→	1.995	D	M	4	16	M9R615		82069
	118	04/09→	1.995	D	M	4	16	M9R610		82069

### SPORT SPIDER

2.0 16V	110	03/95→10/99	1.998	B	M	4	16	F7R710		81574
---------	-----	-------------	-------	---	---	---	----	--------	--	-------

### SUPER 5, VAN

1.0	30	10/84→10/88	956	B	M	4	8	C1C700	(-)COP, (-)AC, (-)COP	81573
	30	10/84→10/88	956	B	M	4	8	C1C700	(-)COP, (+)AC	81756
	30	10/84→10/88	956	B	M	4	8	C1C700	(+)COP, (-)AC, (+)COP	81811
	30	10/84→10/88	956	B	M	4	8	C1C700	(+)COP, (+)AC	81853
1.1	33	01/86→03/95	1.108	B	M	4	8	C1E750, C1E752, C1E756, C1E760	(-)COP, (-)AC, (-)COP	81573
	33	01/86→03/95	1.108	B	M	4	8	C1E750, C1E752, C1E756, C1E760	(-)COP, (+)AC	81756
	33	01/86→03/95	1.108	B	M	4	8	C1E750, C1E752, C1E756, C1E760	(+)COP, (-)AC, (+)COP	81811
	33	01/86→03/95	1.108	B	M	4	8	C1E750, C1E752, C1E756, C1E760	(+)COP, (+)AC	81853
	34	10/84→12/96	1.108	B	M	4	8	C1E750, C1E752, C1E754	(-)COP, (-)AC, (-)COP	81573
	34	10/84→12/96	1.108	B	M	4	8	C1E750, C1E752, C1E754	(-)COP, (+)AC	81756
	34	10/84→12/96	1.108	B	M	4	8	C1E750, C1E752, C1E754	(+)COP, (-)AC, (+)COP	81811
	34	10/84→12/96	1.108	B	M	4	8	C1E750, C1E752, C1E754	(+)COP, (+)AC	81853
1.2	40	01/87→08/90	1.237	B	M	4	8	C1G702, C1G720, C1G722	(-)COP, (-)AC, (-)COP	81573
	40	01/87→08/90	1.237	B	M	4	8	C1G702, C1G720, C1G722	(-)COP, (+)AC	81756
	40	01/87→08/90	1.237	B	M	4	8	C1G702, C1G720, C1G722	(+)COP, (-)AC, (+)COP	81811
	40	01/87→08/90	1.237	B	M	4	8	C1G702, C1G720, C1G722	(+)COP, (+)AC	81853
	44	01/87→12/96	1.237	B	M	4	8		(-)COP, (-)AC, (-)COP	81573
	44	01/87→12/96	1.237	B	M	4	8		(-)COP, (+)AC	81756
	44	01/87→12/96	1.237	B	M	4	8		(+)COP, (-)AC, (+)COP	81811
	44	01/87→12/96	1.237	B	M	4	8		(+)COP, (+)AC	81853



kW



Cap. cm3

Fuel

Gear

No. of cyl.

No. of valves

Motor code



MAGNETI MARELLI  
Short

## RENAULT

### SUPER 5, VAN

1.4	43	10/84→12/96	1.397	B	M	4	8	C1J768, C1J780, C3J700, C3J702, C3J760	(-)COP, (-)AC, (-)COP	81573
	43	10/84→12/96	1.397	B	M	4	8	C1J768, C1J780, C3J700, C3J702, C3J760	(-)COP, (+)AC	81756
	43	10/84→12/96	1.397	B	M	4	8	C1J768, C1J780, C3J700, C3J702, C3J760	(+)COP, (-)AC, (+)COP	81811
	43	10/84→12/96	1.397	B	M	4	8	C1J768, C1J780, C3J700, C3J702, C3J760	(+)COP, (+)AC	81853
	44	06/87→08/90	1.397	B	M	4	8	C2J784	(-)COP, (-)AC, (-)COP	81573
	44	06/87→08/90	1.397	B	M	4	8	C2J784	(-)COP, (+)AC	81756
	44	06/87→08/90	1.397	B	M	4	8	C2J784	(+)COP, (-)AC, (+)COP	81811
	44	06/87→08/90	1.397	B	M	4	8	C2J784	(+)COP, (+)AC	81853
	49	06/87→07/89	1.397	B	M	4	8	C2J782	(-)COP, (-)AC, (-)COP	81573
	49	06/87→07/89	1.397	B	M	4	8	C2J782	(-)COP, (+)AC	81756
	49	06/87→07/89	1.397	B	M	4	8	C2J782	(+)COP, (-)AC, (+)COP	81811
	49	06/87→07/89	1.397	B	M	4	8	C2J782	(+)COP, (+)AC	81853
	52	10/84→07/89	1.397	B	M	4	8	C2J700, C2J780, C2J781, C2J788, C2J789, C2J798	(-)COP, (-)AC, (-)COP	81573
	52	10/84→07/89	1.397	B	M	4	8	C2J700, C2J780, C2J781, C2J788, C2J789, C2J798	(-)COP, (+)AC	81756
52	10/84→07/89	1.397	B	M	4	8	C2J700, C2J780, C2J781, C2J788, C2J789, C2J798	(+)COP, (-)AC, (+)COP	81811	
52	10/84→07/89	1.397	B	M	4	8	C2J700, C2J780, C2J781, C2J788, C2J789, C2J798	(+)COP, (+)AC	81853	
1.4 Turbo	85	08/85→06/89	1.397	B	M	4	8	C1J788	(-)COP, (-)AC, (-)COP	81573
	85	08/85→06/89	1.397	B	M	4	8	C1J788	(-)COP, (+)AC	81756
	85	08/85→06/89	1.397	B	M	4	8	C1J788	(+)COP, (-)AC, (+)COP	81811
	85	08/85→06/89	1.397	B	M	4	8	C1J788	(+)COP, (+)AC	81853
	88	04/85→08/90	1.397	B	M	4	8	C1J782, C1J784, C1J788	(-)COP, (-)AC, (-)COP	81573
	88	04/85→08/90	1.397	B	M	4	8	C1J782, C1J784, C1J788	(-)COP, (+)AC	81756
	88	04/85→08/90	1.397	B	M	4	8	C1J782, C1J784, C1J788	(+)COP, (-)AC, (+)COP	81811
88	04/85→08/90	1.397	B	M	4	8	C1J782, C1J784, C1J788	(+)COP, (+)AC	81853	
1.4 Turbo GT	118	01/85→05/91	1.397	B	M	4	8	840730	(-)COP, (-)AC, (-)COP	81573
	118	01/85→05/91	1.397	B	M	4	8	840730	(-)COP, (+)AC	81756
	118	01/85→05/91	1.397	B	M	4	8	840730	(+)COP, (-)AC, (+)COP	81811
	118	01/85→05/91	1.397	B	M	4	8	840730	(+)COP, (+)AC	81853
1.6 D	40	10/84→12/96	1.595	D	M	4	8	F8M720		81574
	40	08/85→12/96	1.596	D	M	4	8	F8M720, F8M730		81574
1.7	54	10/86→03/95	1.721	B	M	4	8	F3N716, F3N717		81574
	64	06/87→03/95	1.721	B	M	4	8	F2N740, F2N742		81574
1.7 i	69	10/86→08/91	1.721	B	M	4	8	F3N702, F3N722		81574

### THALIA

1.2	43	02/98→10/03	1.149	B	M	4	8	D7F744, D7F746		81661
1.2 16V	55	04/02→	1.149	B	M	4	16	D4F712		81820
1.4	55	08/00→	1.390	B	M	4	8	K7J700		81578
1.4 16V	72	08/00→	1.390	B	M	4	16	K4J712		81806



	kW		Cap. cm3	Fuel	Gear	No. of cyl.	No. of valves	Motor code		MAGNETI MARELLI Short
--	----	--	----------	------	------	-------------	---------------	------------	--	-----------------------

## RENAULT

### THALIA

1.5 dCi	48	04/02→	1.461	D	M	4	8	K9K700		81810
	50	02/03→	1.461	D	M	4	8			81810
	60	06/01→	1.461	D	M	4	8	K9K702		81810
1.5 DCi RT	59	06/01→10/03	1.461	D	M	4	8	K9K702		81810
1.6	66	03/98→05/01	1.598	B	M	4	8	K7M746		81579
1.6 16V	79	04/02→	1.598	B	M	4	16	K4M740		81806
2.0	124	09/01→	1.998	B	M	4	16	F4R738		81574
3.0 V6 Turbo Sport	169	04/00→09/01	2.946	B	M	6	24	L7X732		81844
	187	06/02→	2.946	B	M	6	24	L7X762		81844

### TRAFIC I

1.4	35	03/80→04/89	1.397	B	M	4	8	847700, 847701, C1J700	01-1983→	81829
1.7	50	06/86→08/94	1.721	B	M	4	8	F1N720, F1N724	01-1986→, →12-1995	81574
1.9 D	44	06/97→03/01	1.870	D	M	4	8	F8Q606		81574
2.0	59	06/86→08/90	1.995	B	M	4	8	J5R716, J5R722, J5R726	01-1981→, M→: F029.329	81666
	59	06/86→08/90	1.995	B	M	4	8	J5R716, J5R722, J5R726	01-1981→, →08-1994, →M: F029.328	81828
	63	03/80→12/86	1.995	B	M	4	8	829720, 829721	01-1981→, →08-1994	81828
2.1 D	43	03/80→06/94	2.068	D	M	4	8	852720, 852750	01-1981→, →12-1995	81664
	47	06/94→10/97	2.068	D	M	4	8	J8S620, J8S758	09-1994→	81608
2.2	70	05/89→06/94	2.165	B	M	4	8	J7T780	01-1981→	81828
	74	06/94→10/97	2.165	B	M	4	8	J7T600	01-1981→, M→: F305.273	81666
	74	06/94→10/97	2.165	B	M	4	8	J7T600	01-1981→, →M: F305.272	81828
2.5 D	51	03/80→03/01	2.445	D	M	4	8	8140.61.240, S8U720, S8U722		81334
	55	05/89→03/01	2.499	D	M	4	8	8140.67.2500, 8140.67.2550, 8140.67.2580, S8U750, S8U752, S8U758		81334

### TRAFIC II

1.9 dCi	59	04/01→07/03	1.870	D	M	4	8	F9Q762		81814
1.9 dCi 80	60	03/01→	1.870	D	M	4	8	F9Q762		81814
1.9 dCi 100	74	03/01→	1.870	D	M	4	8	F9Q760		81814
2.0	88	03/01→	1.998	B	M	4	16	F4R720, F4R722		81814
2.0 16V	86	08/06→	1.998	B	M	4	16	F4R820		81814
2.0 dCi	66	08/06→	1.995	D	M	4	16	M9R780, M9R782		82069
	84	08/06→	1.995	D	M	4	16	M9R780		82069
2.5 dCi	84	08/07→	2.463	D	M	4	16	G9U630		81855
	99	05/03→	2.464	D	M	4	16	G9U730		81855
	107	08/06→	2.464	D	M	4	16	G9U630		81855
2.5 dCi 115	84	02/08→	2.464	D	M	4	16			81855
2.5 dCi 135	99	03/01→	2.463	D	M	4	16	G9U730		81855
2.5 DTi	99	03/03→07/03	2.463	D	M	4	16	G9U730		81855

### TWINGO I, VAN

1.2	40	05/96→	1.149	B	M	4	8	D7F700, D7F701		81762
	40	03/93→10/96	1.239	B	M	4	8	C3G700, C3G702	(-)COP, (-)AC	81596
	40	03/93→10/96	1.239	B	M	4	8	C3G700, C3G702	(+)COP, (+)AC	81852

	kw		Cap. cm3	Fuel	Gear	No. of cyl.	No. of valves	Motor code		Short
--	----	--	----------	------	------	-------------	---------------	------------	--	-------

## RENAULT

### TWINGO I, VAN

1.2	40	03/93→10/96	1.239	B	M	4	8	C3G700, C3G702	(+)COP, (-)AC	81854
	43	05/96→	1.149	B	M	4	8	D7F700, D7F701, D7F702, D7F703, D7F704, D7F706		81762
	44	09/98→08/00	1.149	B	M	4	8	D7F702		81762
1.2 16V	44	08/04→	1.149	B	M	4	16	D4F708		81820
	55	01/01→	1.149	B	M	4	16	D4F702, D4F704		81820

### TWINGO II

1.2	43	03/07→	1.149	B	M	4	8	D7F800		82091
1.2 16V	56	03/07→	1.149	B	M	4	16	D4F772		82090
1.2 Turbo	74	03/07→	1.149	B	M	4	16	D4F780		82090
1.5 dCi	47	03/07→	1.461	D	M	4	8	K9K740		81810
	62	04/08→	1.461	D	M	4	8	K9K718		81810
1.6 RS	98	05/08→	1.598	B	M	4	16	K4M754		81806

### VEL SATIS

2.0	108	04/05→	1.998	B	M	4	16	F4R867		81814
2.0 16V Turbo	120	06/02→	1.998	B	M	4	16	F4R762, F4R763		81814
	125	04/04→	1.998	B	M	4	16	F4R766		81814
2.0 dCi	110	08/05→	1.995	D	M	4	16	M9R760		82069
	127	01/06→	1.995	D	M	4	16	M9R760		82069
2.2 dCi	85	04/04→	2.188	D	M	4	16	G9T600		81855
	102	09/04→	2.188	D	M	4	16	G9T600		81855
	110	06/02→	2.188	D	M	4	16	G9T702		81855
3.0 dCi	130	06/02→	2.958	D	M	6	24	P9X701		81871
	133	06/06→	2.958	D	M	6	24	P9X715		81871

### WIND

1.6	98	07/10→	1.598	B	M	4	16	K4M854		81806
-----	----	--------	-------	---	---	---	----	--------	--	-------

## ROVER

### 45

1.4	76	02/00→	1.396	B	M	4	16	14K4F		81615
1.6	80	02/00→	1.588	B	M	4	16	16K4F		81615
1.8	86	02/00→	1.796	B	M	4	16	18K4F		81615
2.0 iDT	74	02/00→05/05	1.994	D	M	4	8	20T2N		81707
2.0 V6	110	02/00→	1.997	B	A	6	24	20K4F		82029

### 200 II, COUPÉ

2.0	152	10/92→09/97	1.994	B	M	4	16			81707
214	55	09/93→10/95	1.396	B	M	4	8	14K2A, 14K2D		81614
214 GSi/Si	70	01/90→10/95	1.396	B	M	4	16	14K4C		81615
	76	12/92→10/95	1.396	B	M	4	16	14K4F		81615
214 Si/Gsi	66	10/89→10/95	1.396	B	M	4	16	14K4C, 14K4D		81615
216	90	10/92→06/99	1.590	B	M	4	16	D16A8		81613
216 GSi	82	10/89→10/95	1.590	B	M	4	16	D16Z2		81613
	85	10/89→10/95	1.590	B	M	4	16	D16A7		81613
216 GTi	90	09/90→10/95	1.590	B	M	4	16	D16A8		81613
	96	09/90→10/95	1.590	B	M	4	16	D16A9		81613
218 D	52	09/91→10/95	1.905	D	M	4	8			81672

	kw		Cap. cm3	Fuel	Gear	No. of cyl.	No. of valves	Motor code		MAGNETI MARELLI Short
--	----	--	----------	------	------	-------------	---------------	------------	--	-----------------------

## ROVER

### 200 II, COUPÉ

218 TD	65	09/91→10/95	1.769	D	M	4	8	XUD7TE		81672
220 GSi	100	05/94→06/99	1.994	B	M	4	16	20T4H		81707
220 GTi	100	01/93→10/95	1.994	B	M	4	16	20T4H		81707
	103	09/91→10/95	1.994	B	M	4	16	20M4F		81707
220 Turbo	147	10/92→06/99	1.994	B	M	4	16	20T4G		81707

### 200 III

211	44	01/98→03/00	1.119	B	M	4	8	11K2D		81614
214 i	55	11/95→03/00	1.396	B	M	4	8	14K2F	03-1996→	81614
214 Si	76	11/95→03/00	1.396	B	M	4	16	14K4F		81615
216 Si	82	11/95→03/00	1.588	B	M	4	16	16K4F		81615
218 K Vi	107	11/95→03/00	1.796	B	M	4	16	18K4K		81615
220 D/SD	63	11/95→03/00	1.994	D	M	4	8	20T2R		81707
220 SDi	77	11/95→03/00	1.994	D	M	4	8	20T2N		81707

### 400 I

414	70	01/93→04/95	1.396	B	M	4	16	14K4C		81615
414 GSi/SI	66	04/90→04/95	1.396	B	M	4	16	14K4C, 14K4D		81615
414 GSi/SI Cat.	76	01/93→04/95	1.396	B	M	4	16	14K4F		81615
416 GSi	82	04/90→04/95	1.590	B	M	4	16	D16Z2		81613
416 GSi/GSE	85	04/90→04/95	1.590	B	M	4	16	D16A7		81613
416 GTi	90	04/90→04/95	1.590	B	M	4	16	D16A8		81613
416 GTi/GTE	96	04/90→04/95	1.590	B	M	4	16	D16A9		81613
418 D	49	09/91→04/95	1.905	D	M	4	8			81672
418 TD	65	09/91→04/95	1.769	D	M	4	8	XUD7TE		81672
420 GSi/SLI/GTi/Vite	100	01/93→04/95	1.994	B	M	4	16	20T4H		81707
420 GTi/GSi/Vitesse	103	02/92→04/95	1.994	B	M	4	16	20M4F	10-1992→	81707
	103	02/92→04/95	1.994	B	M	4	16	20M4F	→09-1992	81843
420 Turbo	147	01/93→04/95	1.994	B	M	4	16	20T4G		81707
1.6 i	82	05/94→11/98	1.590	B	M	4	16	D16Z2	→02-1996	81613
	82	05/94→11/98	1.590	B	M	4	16	D16Z2	03-1996→	81615
	90	05/94→11/98	1.590	B	M	4	16	D16A8	→02-1996	81613
	90	05/94→11/98	1.590	B	M	4	16	D16A8	03-1996→	81615
1.8 i	107	06/96→11/98	1.796	B	M	4	16	18K4K		81615
1.8 TD	65	09/93→11/98	1.769	D	M	4	8	XUD7TE		81672
2.0 i	100	05/94→11/98	1.994	B	M	4	16	20T4H		81707
2.0 Turbo GSi Sport	152	10/92→04/95	1.994	B	M	4	16			81707

### 400 II

414 Si	76	05/95→03/00	1.396	B	M	4	16	14K4F		81615
416 Si	82	05/95→03/00	1.588	B	M	4	16	16K4F		81615
	83	05/95→03/00	1.590	B	A	4	16	D16Y2		81615
420 Si Lux	100	12/95→03/00	1.994	B	M	4	16	20T4H		81707
420 D	63	11/95→03/00	1.994	D	M	4	8	20T2R		81707
420 Di	77	05/95→03/00	1.994	D	M	4	8	20T2N		81707

### 75, TOURER

1.8	88	02/99→	1.796	B	M	4	16	K1.8		81615
1.8 Turbo	110	05/03→	1.796	B	M	4	16			81615
2.0 V6	110	02/99→	1.997	B	M	6	24	20K4F		82029

	kw		Cap. cm3	Fuel	Gear	No. of cyl.	No. of valves	Motor code		Short
--	----	--	----------	------	------	-------------	---------------	------------	--	-------

## ROVER

### 75, TOURER

2.5 V6	129	02/99→10/01	2.497	B	M	6	24	KV6		82029
	130	08/01→	2.497	B	M	6	24	25K4F, KV6		82029

### STREETWISE

1.4	62	08/03→	1.396	B	M	4	16	14K4M		81615
	76	08/03→	1.396	B	M	4	16	14K4F		81615
2.0 TD	74	08/03→	1.994	D	M	4	8	20T2N		81707

## SAAB

### 900 I, CABRIO

2.0	98	10/87→10/91	1.985	B	M	4	16	B202I		81601
2.0 -16	92	01/86→12/88	1.985	B	M	4	16	B202XI		81601
	93	01/89→06/94	1.985	B	M	4	16	B202I		81601
2.0 c	74	09/79→12/88	1.985	B	M	4	8	B20, B201XC		81601
2.0 c	79	09/78→08/84	1.985	B	M	4	8	B20T, BT20		81601
2.0 EMS	87	09/78→12/80	1.985	B	M	4	8	BI20		81601
2.0 i	81	09/85→08/90	1.985	B	M	4	8	B201		81601
	85	11/80→08/90	1.985	B	M	4	8	B201XI, BI20		81601
2.0 S Turbo-16	104	07/91→06/94	1.985	B	M	4	16	B202S		81601
	107	01/92→12/93	1.985	B	M	4	16	B202S		81601
2.0 Turbo	103	10/86→12/91	1.985	B	M	4	8	B201XL		81601
	107	09/78→07/85	1.985	B	M	4	8	B201S, BSI20		81601
	110	01/86→12/88	1.985	B	M	4	8	B201XL		81601
2.0 Turbo-16	118	11/85→06/94	1.985	B	M	4	16	B202XL		81601
	132	01/93→06/94	1.985	B	M	4	16	B202L		81601
2.0 Turbo-16 S	129	01/84→06/94	1.985	B	M	4	16	B202XL		81601
2.0 Turbo-16 S Cat.	125	01/89→12/93	1.985	B	M	4	16	B202XL		81601
	129	01/89→12/93	1.985	B	M	4	16	B202XL		81601
2.1 -16	100	08/90→06/94	2.119	B	M	4	16	B212I		81601

### 900 II, CABRIO, COUPÉ

2.0 i	96	12/93→02/98	1.985	B	M	4	16	B204I		81764
	98	07/93→07/94	1.985	B	M	4	16	B206I		81764
2.0 -16 Turbo	136	07/93→02/98	1.985	B	M	4	16	B204L		81764
2.3 -16	110	07/93→02/98	2.290	B	M	4	16	B234I		81764
2.5 -24 V6	125	07/93→02/98	2.498	B	M	6	24	B258I		81846

### 9000

2.0 -16	92	12/85→12/88	1.985	B	M	4	16	B202XI (KAT)		81621
	94	12/85→01/93	1.985	B	M	4	16	B202I, B202XI		81621
2.0 -16 CD	96	09/93→12/98	1.985	B	M	4	16	B204I		81763
	110	09/93→12/98	1.985	B	M	4	16	B204E		81763
2.0 -16 CS	94	01/89→12/98	1.985	B	M	4	16	B202I		81621
	96	09/93→12/98	1.985	B	M	4	16	B204I		81763
2.0 -16 ND Turbo	110	09/93→12/98	1.985	B	M	4	16	B202S, B204E		81763
2.0 -16 Turbo	118	09/84→08/93	1.985	B	M	4	16	B202XL		81621
	120	05/88→08/93	1.985	B	M	4	16	B202XL		81621
	127	06/89→12/92	1.985	B	M	4	16	B202		81621
	129	09/84→12/91	1.985	B	M	4	16	B202XL		81621

	kw		Cap. cm3	Fuel	Gear	No. of cyl.	No. of valves	Motor code		MAGNETI MARELLI Short
--	----	--	----------	------	------	-------------	---------------	------------	--	-----------------------

## SAAB

### 9000

2.0 -16 Turbo CD	108	09/92→12/98	1.985	B	M	4	16	B202S, B204E		81763
	120	09/88→08/93	1.985	B	M	4	16	B202XL		81621
	136	09/89→12/98	1.985	B	M	4	16	B202L	→12-1993	81621
	136	09/89→12/98	1.985	B	M	4	16	B202L	01-1994→	81763
2.0 -16 Turbo CS	136	09/88→12/98	1.985	B	M	4	16	B202L	→12-1993	81621
	136	09/88→12/98	1.985	B	M	4	16	B202L	01-1994→	81763
2.0 T16	150	06/89→10/90	1.985	B	M	4	16			81621
2.3	165	09/90→10/98	2.290	B	M	4	16	B234R		81763
2.3 -16 Aero CS	162	02/93→12/98	2.290	B	M	4	16	B234R		81763
	165	02/93→12/98	2.290	B	M	4	16	B234R		81763
2.3 -16 CD	107	08/89→12/98	2.290	B	M	4	16	B234I		81763
2.3 -16 CD Turbo	147	07/90→12/98	2.290	B	M	4	16	B234L		81763
2.3 -16 CDE	108	09/93→12/98	2.290	B	M	4	16	B234I		81763
2.3 -16 CDE Eco-Power	125	09/93→12/98	2.290	B	M	4	16	B234E		81763
2.3 -16 CS	107	09/89→12/98	2.290	B	M	4	16	B234I		81763
2.3 -16 CSE	108	09/93→12/98	2.290	B	M	4	16	B234I		81763
2.3 -16 CSE Eco Power	125	09/93→12/98	2.290	B	M	4	16	B234E		81763
2.3 -16 Turbo	143	09/90→12/98	2.290	B	M	4	16	B234L		81763
2.3 -16 Turbo CSE	147	09/93→12/98	2.290	B	M	4	16	B234L		81763
3.0 -24 V6 CD/CDE	155	07/94→12/98	2.962	B	M	6	24	B308I		81846
3.0 -24 V6 CS/CSE	155	07/94→12/98	2.962	B	M	6	24	B308I		81846

### 9-3 I, CABRIO

2.0 i	96	02/98→08/03	1.985	B	M	4	16	B204I		81764
2.0 SE Turbo	147	02/98→08/03	1.985	B	M	4	16	B204R		81764
2.0 Turbo	110	01/01→08/03	1.985	B	M	4	16	B205E		81764
	113	10/98→08/03	1.985	B	M	4	16	B204E		81764
	136	02/98→08/03	1.985	B	M	4	16	B204L		81764
	151	10/99→08/03	1.985	B	M	4	16	B205R		81764
2.2 TiD	85	02/98→11/00	2.171	D	M	4	16	D223L, X22DTH		81747
	92	11/00→09/02	2.171	D	M	4	16	D223L		81747
2.3	169	09/99→01/02	2.290	B	M	4	16	B235R		81764
2.3 i	110	02/98→08/03	2.290	B	M	4	16	B234I		81764
2.3 Turbo	165	10/98→08/03	2.290	B	M	4	16	B235R		81764

### 9-3 II, 9-3 X, STATION WAGON, CABRIO

1.8 i	90	01/04→	1.796	B	M	4	16	Z18XE		81751
1.8 t	110	09/02→	1.998	B	M	4	16	B207E		81812
1.8 t BioPower	110	01/07→	1.998	FF	M	4	16	B207E		81812
	129	01/07→	1.998	FF	M	4	16	B207L		81812
1.9 TiD	88	03/05→	1.910	D	M	4	16			81352
	88	09/04→	1.910	D	M	4	8	Z19DT		81352
	110	09/04→	1.910	D	M	4	16	Z19DTH		81872
1.9 TTiD	132	12/07→	1.910	D	M	4	16	Z19DTR		81872
2.0	143	04/06→09/07	1.998	B	M	4	16			81812
2.0 T	110	03/05→	1.998	B	M	4	16	B207E		81812
	129	09/02→	1.998	B	M	4	16	B207L		81812
	147	02/09→	1.998	B	M	4	16			81812



kW



Cap. cm3

Fuel

Gear

No. of cyl.

No. of valves

Motor code



MAGNETI MARELLI  
Short

## SAAB

### 9-3 II, 9-3 X, STATION WAGON, CABRIO

2.0 T	154	09/02→	1.998	B	M	4	16	B207R		81812
	177	05/09→	1.998	B	M	4	16			81812
2.0 T BioPower	129	01/07→	1.998	FF	M	4	16	B207L		81812
	145	06/07→	1.998	FF	M	4	16			81812
	147	06/07→	1.998	FF	M	4	16			81812
	154	02/09→	1.998	BF	M	4	16	B207R		81812
	154	09/02→	1.998	FF	M	4	16	B207R		81812
2.0 T XWD	154	06/08→	1.998	B	M	4	16	B207R		81812
2.0 Turbo Performance	185	04/04→	1.998	B	M	4	16			81812
2.0 Turbo XWD	154	09/02→	1.998	B	M	4	16	B207R		81812
2.2 TiD	92	09/02→	2.171	D	M	4	16	D223L		81747

### 9-5 I, STATION WAGON

1.9 TiD	110	01/06→	1.910	D	M	4	16	Z19DTH		81872
2.0	136	07/00→07/01	1.985	B	M	4	16	B205L		81764
2.0 t	110	09/97→	1.985	B	M	4	16	B205E		81764
	141	10/98→	1.985	B	M	4	16	B204R		81764
2.0 T Biopower	132	09/05→	1.985	B	M	4	16			81764
2.0 Turbo SE	141	10/98→07/00	1.985	B	M	4	16			81764
2.2 TiD	88	03/02→	2.171	D	M	4	16	D223L		81747
2.3	224	06/03→08/05	2.290	B	M	4	16			81764
2.3 t	125	09/97→	2.290	B	M	4	16	B235E		81764
	136	01/01→	2.290	B	M	4	16	B235E		81764
2.3 Turbo	162	07/03→	2.290	B	M	4	16	B235L		81764
	169	10/99→09/01	2.290	B	M	4	16	B235R		81764
	184	09/01→	2.290	B	M	4	16	B235R		81764
	191	11/05→	2.290	B	M	4	16	B235R		81764
3.0 V6t	147	01/98→	2.962	B	A	6	24	B308E		81846

### 9-5 II, STATION WAGON

1.6 T	132	05/10→	1.598	B	M	4	16			82083
2.0 T	162	05/10→	1.998	B	M	4	16	A20NHT		81812
2.0 T BioPower	162	05/10→	1.998	FF	M	4	16	A20NHT		81812
	162	05/10→	1.998	FF	M	4	16	A20NHT		81812
2.0 T XWD	162	05/10→	1.998	B	M	4	16	A20NHT		81812
2.0 TiD	118	05/10→	1.956	D	M	4	16	A20DTH		81872
2.0 TTiD	140	05/10→	1.956	D	M	4	16	A20DTR		81872
2.0 TTiD XWD	140	05/10→	1.956	D	M	4	16	A20DTR		81872

## SEAT

### ALHAMBRA I

1.8 T 20V	110	10/97→	1.781	B	M	4	20	AJH, AWC		81703
1.9 TDI	66	04/96→	1.896	D	M	4	8	1Z, AHU, ANU	(-)COP, →07-2000	81522
	66	04/96→	1.896	D	M	4	8	1Z, AHU, ANU	08-2000→	81816
	66	04/96→	1.896	D	M	4	8	1Z, AHU, ANU	(+)COP, CR	82080
	81	08/96→06/00	1.896	D	M	4	8	AFN, AVG	(-)COP	81522
	81	08/96→06/00	1.896	D	M	4	8	AFN, AVG	(+)COP, CR	82080
	85	06/00→	1.896	D	M	4	8	AUY		81816

	kw		Cap. cm3	Fuel	Gear	No. of cyl.	No. of valves	Motor code		Short
--	----	--	----------	------	------	-------------	---------------	------------	--	-------

## SEAT

### ALHAMBRA I

1.9 TDI	96	11/02→	1.896	D	M	4	8	ASZ		81791
	110	05/05→	1.896	D	M	4	8	ARL		81816
1.9 TDI 4motion	85	02/01→	1.896	D	M	4	8	AUY, BVK		81816
1.9 Tdi 4x4	96	06/05→	1.896	D	M	4	8	ASZ		81791
2.0 i	85	04/96→	1.984	B	AM	4	8	ADY, ATM	(-)COP, →07-2000, M: ADY	81522
	85	04/96→	1.984	B	AM	4	8	ADY, ATM	08-2000→, M: ATM	81703
	85	04/96→	1.984	B	AM	4	8	ADY, ATM	(+)COP, CR	82080
2.0 TDI	103	11/05→	1.968	D	M	4	8	BRT		81816
2.8 V6	150	06/00→	2.792	B	M	6	24	AYL		81866
2.8 V6 4motion	150	02/01→	2.792	B	M	6	24	AYL		81866

### ALHAMBRA II

2.0 TDI	103	06/10→	1.968	D	M	4	16	CFFB		83000
	125	06/10→	1.968	D	M	4	16	CFGB		83000

### ALTEA, ALTEA XL

1.4	63	10/06→	1.390	B	M	4	16	BXW		81777
1.4 16V	63	05/06→	1.390	B	M	4	16	BXW		81777
1.4 TSI	92	11/07→	1.390	B	M	4	16	CAXC		82097
1.6	75	03/04→	1.595	B	M	4	8	BGU, BSE, BSF		81702
1.6 LPG	75	09/09→	1.595		M	4	8	CHGA		81702
1.6 Multifuel	75	10/06→	1.595	FF	M	4	8	CCSA		81702
1.6 TDI	66	11/10→	1.598	D	M	4	16	CAYB		83000
	77	10/09→	1.598	D	M	4	16	CAYC		83000
1.8 TFSI	118	01/07→	1.798	B	M	4	16	BYT	06-2007→, T→: 5P7084001	82096
1.9 TDI	66	08/09→	1.896	D	M	4	8	BXF		81791
	77	04/04→	1.896	D	M	4	8	BJB, BKC, BLS, BXE		81791
2.0 FSI	110	05/04→03/09	1.984	B	M	4	16	BLR, BLY, BVY, BVZ		81702
2.0 TDI	100	03/04→05/09	1.968	D	M	4	16	AZV		81816
	103	03/04→	1.968	D	M	4	16	BKD		81816
	103	11/05→	1.968	D	M	4	8	BMM		81816
	125	03/06→	1.968	D	M	4	16	BMN		81816
2.0 TDI 16V	100	11/06→03/09	1.968	D	M	4	16	AZV		81816
	103	10/06→	1.968	D	M	4	16	BKD		81816
2.0 TDI 4WD	103	06/07→	1.968	D	M	4	8	BMM		81816
	125	06/07→	1.968	D	M	4	16	BMN		81816
2.0 TFSI	147	04/06→05/09	1.984	B	M	4	16	BWA		82025
2.0 TFSI 4WD	147	06/07→05/09	1.984	B	M	4	16	BWA		82025
2.0 TFSI 4x4	155	05/09→	1.984	B	M	4	16	CCZB		82096

### AROSA

1.0	37	05/97→06/04	999	B	M	4	8	AER, ALD, ALL, ANV, AUC	M: ALD, M: AER, M: ALL, M: ALD, M: AUC, M: AER	81775
	37	05/97→06/04	999	B	M	4	8	AER, ALD, ALL, ANV, AUC	→11-1999, M: AHT	81807
1.4	44	05/97→06/04	1.390	B	AM	4	8	AEX, AKK, AKV, ANW, APQ, AUD	→11-1999	81527
	44	05/97→06/04	1.390	B	AM	4	8	AEX, AKK, AKV, ANW, APQ, AUD	12-1999→, M: AUD, M: ANW, M: AUD	81775

	kw		Cap. cm3	Fuel	Gear	No. of cyl.	No. of valves	Motor code		Short
--	----	--	----------	------	------	-------------	---------------	------------	--	-------

## SEAT

### AROSA

1.4 16V	74	01/00→06/04	1.390	B	M	4	16	AFK, ANM, AQQ, AUB		81777
1.4 TDI	55	01/00→06/04	1.422	D	M	3	6	AMF		81791
1.7 SDI	44	08/97→06/04	1.716	D	M	4	8	AKU		81528

### CORDOBA I, VARIO

1.0 CL	33	02/93→06/96	1.043	B	M	4	8	AAU		81775
1.0 i	37	09/96→06/99	999	B	M	4	8	AER		81775
1.4 i	44	06/94→06/99	1.390	B	M	4	8	ABD, AEX, AKV, ANX, APQ	→05-1996	81524
	44	06/94→06/99	1.390	B	M	4	8	ABD, AEX, AKV, ANX, APQ	05-1997→, 06-1996→	81527
1.4 i 16V	74	09/96→06/99	1.390	B	M	4	16	AFH		81776
1.6 i	55	05/94→06/99	1.595	B	M	4	8	1F	(-)COP	81522
	55	05/94→06/99	1.595	B	M	4	8	1F	(+)COP, CR	82080
	55	09/96→06/99	1.598	B	M	4	8	AEE, ALM	(-)COP	81522
	55	02/93→06/99	1.598	B	M	4	8	ABU, AEE, ALM		81524
	55	09/96→06/99	1.598	B	M	4	8	AEE, ALM	(+)COP, CR	82080
	74	07/96→06/99	1.595	B	M	4	8	AFT	(-)COP	81522
1.7 SDI	44	07/97→06/99	1.716	D	M	4	8		(-)COP	81522
	44	07/97→06/99	1.716	D	M	4	8		(+)COP, CR	82080
1.8 i	66	02/93→06/99	1.781	B	M	4	8	ABS, ADZ	(-)COP, 10-1993→	81522
	66	02/93→06/99	1.781	B	M	4	8	ABS, ADZ	(+)COP, CR	82080
1.8 i 16V	95	10/93→08/96	1.781	B	M	4	16	ADL	(-)COP, 10-1993→	81522
	95	10/93→08/96	1.781	B	M	4	16	ADL	(+)COP, CR	82080
1.9 D	47	01/96→08/96	1.896	D	M	4	8	1Y	(-)COP, 06-1996→	81522
	47	01/96→08/96	1.896	D	M	4	8	1Y	(+)COP, CR	82080
	50	02/93→08/96	1.896	D	M	4	8	1Y	(-)COP, 10-1993→	81522
	50	02/93→08/96	1.896	D	M	4	8	1Y	(+)COP, CR	82080
1.9 SDI	47	08/96→06/99	1.896	D	M	4	8	AEY	(-)COP, 05-1997→	81522
	47	08/96→06/99	1.896	D	M	4	8	AEY	(+)COP, CR	82080
1.9 TD	55	02/93→08/96	1.896	D	M	4	8	AAZ	(-)COP, 10-1993→	81522
	55	02/93→08/96	1.896	D	M	4	8	AAZ	(+)COP, CR	82080
1.9 TDI	66	08/96→06/99	1.896	D	M	4	8	1Z, AHU	(-)COP, 06-1996→	81522
	66	08/96→06/99	1.896	D	M	4	8	1Z, AHU	(+)COP, CR	82080
	81	03/97→06/99	1.896	D	M	4	8	AFN	(-)COP, 05-1997→	81522
	81	03/97→06/99	1.896	D	M	4	8	AFN	(+)COP, CR	82080
2.0 i	85	02/93→06/99	1.984	B	M	4	8	2E, AGG	(-)COP, 10-1993→	81522
	85	02/93→06/99	1.984	B	M	4	8	2E, AGG	(+)COP, CR	82080
2.0 i 16V	110	08/96→06/99	1.984	B	M	4	16	ABF	(-)COP, 02-1997→	81522
	110	08/96→06/99	1.984	B	M	4	16	ABF	(+)COP, CR	82080

### CORDOBA II, VARIO

1.0	37	06/99→10/02	999	B	M	4	8	ALD, ANV, AUC		81775
1.0 16V	51	05/00→10/02	999	B	M	4	16	AST, AVZ		81776
1.4	44	06/99→12/02	1.390	B	M	4	8	AKK, ANW, AUD		81775
1.4 16V	55	06/99→12/02	1.390	B	M	4	16	APE, AUA		81777
	74	02/00→10/02	1.390	B	M	4	16	AQQ, AUB		81777
1.6	55	06/99→12/02	1.598	B	M	4	8	ALM		81527
	74	06/99→12/02	1.595	B	M	4	8	AEH, AKL, APF, AUR		81702



	kw		Cap. cm3	Fuel	Gear	No. of cyl.	No. of valves	Motor code		Short
--	----	--	----------	------	------	-------------	---------------	------------	--	-------

## SEAT

### CORDOBA II, VARIO

1.8 T 20V Cupra	115	07/00→10/02	1.781	B	M	4	20	AQX, AYP		81703
1.9 SDI	50	06/99→12/02	1.896	D	M	4	8	AGP, AQM		81706
1.9 TDI	66	06/99→12/02	1.896	D	M	4	8	AGR, ALH		81706
	81	06/99→12/02	1.896	D	M	4	8	ASK, ASV		81706

### CORDOBA III, VARIO

1.2	47	10/02→	1.198	B	M	3	12	AZQ		81867
1.4 16V	55	09/02→	1.390	B	AM	4	16	BBY		81777
	74	10/02→	1.390	B	M	4	16	BBZ		81777
1.4 TDI	51	05/05→	1.422	D	M	3	6	BNM		81791
	55	10/02→	1.422	D	M	3	6	AMF		81791
	59	06/05→	1.422	D	M	3	6	BMS, BNV		81791
1.6	74	04/03→	1.598	B	M	4	8	BAH		81527
1.9 SDI	47	09/02→	1.896	D	M	4	8	ASY		82013
1.9 TDI	74	09/02→	1.896	D	M	4	8	ATD		81791
	96	10/02→	1.896	D	M	4	8	ASZ		81791
2.0	85	09/02→	1.984	B	M	4	8	AZL, BBX		81703

### EXEO, EXEO ST

1.6	75	03/09→	1.595	B	M	4	8	ALZ		81702
1.8 T	110	12/08→	1.781	B	M	4	20	CFMA		81702
1.8 TSI	88	09/10→	1.798	B	M	4	16	CDHA		82096
	118	05/10→	1.798	B	M	4	16	CDHB		82096
2.0 TDI	88	12/08→	1.968	D	M	4	16	CAGC		81816
	105	03/09→	1.968	D	M	4	16	CAGA		81816
	125	03/09→	1.968	D	M	4	16	CAHA		81816
2.0 TFSI	147	03/09→	1.984	B	M	4	16	BWE		82025
	155	05/10→	1.984	B	M	4	16	CDND		82096

### IBIZA II

1.0	33	03/93→09/96	1.043	B	M	4	8	AAU		81524
1.0 i	37	09/96→08/99	999	B	M	4	8	AER		81775
1.3 i	40	03/93→08/99	1.272	B	M	4	8	AAV		81524
1.4 i	44	09/93→08/99	1.390	B	M	4	8	ABD, AEX, AKV, APQ	→07-1996, M: ABD	81524
	44	09/93→08/99	1.390	B	M	4	8	ABD, AEX, AKV, APQ	08-1996→, M: AEX	81527
1.4 i 16V	74	09/96→08/99	1.390	B	M	4	16	AFH		81527
1.6 i	55	09/94→06/99	1.595	B	M	4	8	1F	(-)COP	81522
	55	09/94→06/99	1.595	B	M	4	8	1F	(+)COP, CR	82080
	55	03/93→08/99	1.598	B	M	4	8	ABU, AEE, ALM	(-)COP, 01-1995→, M: AEE	81522
	55	03/93→08/99	1.598	B	M	4	8	ABU, AEE, ALM	→12-1994, M: ABU	81524
	55	03/93→08/99	1.598	B	M	4	8	ABU, AEE, ALM	(+)COP, CR	82080
	74	04/96→08/99	1.595	B	M	4	8	AFT	(-)COP	81522
	74	04/96→08/99	1.595	B	M	4	8	AFT	(+)COP, CR	82080
1.8 i	66	03/93→08/99	1.781	B	M	4	8	ABS, ADZ	(-)COP, 01-1993→	81522
	66	03/93→08/99	1.781	B	M	4	8	ABS, ADZ	(+)COP, CR	82080
1.8 i 16V	95	11/93→08/96	1.781	B	M	4	16	ADL	(-)COP	81522
	95	11/93→08/96	1.781	B	M	4	16	ADL	(+)COP, CR	82080

	kw		Cap. cm3	Fuel	Gear	No. of cyl.	No. of valves	Motor code		Short
--	----	--	----------	------	------	-------------	---------------	------------	--	-------

## SEAT

### IBIZA II

1.9 D	47	04/93→08/96	1.896	D	M	4	8	1Y	(-)COP	81522
	47	04/93→08/96	1.896	D	M	4	8	1Y	(+)COP, CR	82080
	50	10/94→08/96	1.896	D	M	4	8	1Y	(-)COP	81522
	50	10/94→08/96	1.896	D	M	4	8	1Y	(+)COP, CR	82080
1.9 SDI	47	08/96→08/99	1.896	D	M	4	8	AEY	(-)COP	81522
	47	08/96→08/99	1.896	D	M	4	8	AEY	(+)COP, CR	82080
1.9 TD	55	03/93→08/96	1.896	D	M	4	8	AAZ	(-)COP, 06-1994→	81522
	55	03/93→08/96	1.896	D	M	4	8	AAZ	(+)COP, CR	82080
1.9 TDI	66	08/96→08/99	1.896	D	M	4	8	1Z, AHU		81528
	81	02/97→08/99	1.896	D	M	4	8	AFN		81528
2.0 i	85	03/93→08/99	1.984	B	M	4	8	2E, AGG	(-)COP	81522
	85	03/93→08/99	1.984	B	M	4	8	2E, AGG	(+)COP, CR	82080
2.0 i 16V	110	08/96→08/99	1.984	B	M	4	16	ABF	(-)COP	81522
	110	08/96→08/99	1.984	B	M	4	16	ABF	(+)COP, CR	82080

### IBIZA III

1.0	37	08/99→02/02	999	B	M	4	8	ALD, ANV, AUC		81775
1.0 16V	51	05/00→02/02	999	B	M	4	16	AST, AVZ		81776
1.4	44	08/99→02/02	1.390	B	M	4	8	AKK, ANW, AUD		81775
1.4 16V	55	05/00→02/02	1.390	B	M	4	16	APE, AUA		81777
	74	08/99→02/02	1.390	B	M	4	16	AQQ, AUB		81777
1.6	55	08/99→02/02	1.598	B	M	4	8	ALM		81527
	74	08/99→02/02	1.595	B	M	4	8	AEH, AKL, APF, AUR		81702
1.8 T 20V Cupra	115	07/00→02/02	1.781	B	M	4	20	AQX, AYP		81703
1.9 SDI	50	08/99→02/02	1.896	D	M	4	8	AGP, AQM		81706
1.9 TDI	66	08/99→02/02	1.896	D	M	4	8	AGR, ALH		81706
	81	08/99→02/02	1.896	D	M	4	8	ASK, ASV		81706

### IBIZA IV

1.2	47	02/02→06/06	1.198	B	M	3	12	AZQ		81867
1.4 16V	55	02/02→12/07	1.390	B	AM	4	16	BBY		81777
	74	02/02→	1.390	B	M	4	16	AUB, BBZ		81777
1.4 TDI	51	05/05→	1.422	D	M	3	6	BNM		81791
	55	05/02→12/05	1.422	D	M	3	6	AMF		81791
	59	06/05→	1.422	D	M	3	6	BMS, BNV		81791
1.6	74	02/03→	1.598	B	M	4	8	BAH		81527
1.8 T Cupra R	132	01/04→02/08	1.781	B	M	4	20	BBU		81703
1.8 T FR	110	12/03→05/08	1.781	B	M	4	20	BJX, BKV		81703
1.9 SDI	47	02/02→12/05	1.896	D	M	4	8	ASY		82013
1.9 TDI	74	02/02→	1.896	D	M	4	8	ATD		81791
	96	02/02→	1.896	D	M	4	8	ASZ		81791
1.9 TDI Cupra R	110	01/04→	1.896	D	M	4	8	ARL		81816
	118	03/04→02/08	1.896	D	M	4	8	BPX		81816
2.0	85	04/02→	1.984	B	M	4	8	AZL		81703

### IBIZA V, SPORTCOUPÉ, ST

1.2	44	07/09→	1.198	B	M	3	12	CGPB		81867
	51	03/08→	1.198	B	M	3	12	BZG, CGPA		81867
1.2 TDI	55	04/10→	1.199	D	M	3	12	CFWA		83000

	<b>kW</b>		<b>Cap. cm3</b>	<b>Fuel</b>	<b>Gear</b>	<b>No. of cyl.</b>	<b>No. of valves</b>	<b>Motor code</b>		<b>MAGNETI MARELLI</b> Short
--	-----------	--	-----------------	-------------	-------------	--------------------	----------------------	-------------------	--	---------------------------------

## SEAT

### IBIZA V, SPORTCOUPÉ, ST

1.4	63	03/08→	1.390	B	M	4	16	BXW, CGGB		81777
1.4 TDI	59	07/08→	1.422	D	M	3	6	BMS		81791
1.6	77	05/08→	1.598	B	M	4	16	BTS	T→: 6J9002801	81777
	77	05/08→	1.598	B	M	4	16	BTS	→T: 6J9002800	81865
1.6 TDI	66	05/09→	1.598	D	M	4	16	CAYB		83000
	77	05/09→	1.598	D	M	4	16	CAYC, CLNA		83000
1.9 TDI	66	07/08→	1.896	D	M	4	8	BXJ		81791
	77	03/08→	1.896	D	M	4	8	BLS		81791
2.0 TDI	105	01/10→	1.968	D	M	4	16	CFHD		83000

## INCA

1.4 16V	55	04/00→06/03	1.390	B	M	4	16	AUA		81777
1.4 i	44	11/95→06/03	1.390	B	M	4	8	AEX, AKV, APQ, AUD	01-1998→	81527
1.6 i	55	11/95→05/98	1.595	B	M	4	8	1F	(-)COP, 11-1995→	81522
	55	11/95→05/98	1.595	B	M	4	8	1F	(+)COP, CR	82080
	55	11/95→05/98	1.598	B	M	4	8	AEE		81527
1.7 D	42	09/96→06/03	1.716	D	M	4	8	AHB	(-)COP	81522
	42	09/96→06/03	1.716	D	M	4	8	AHB	(+)COP, CR	82080
1.9 D	47	11/95→06/03	1.896	D	M	4	8	1Y	(-)COP, 11-1995→	81522
	47	11/95→06/03	1.896	D	M	4	8	1Y	(+)COP, CR	82080
1.9 SDI	47	11/95→06/03	1.896	D	M	4	8	AEY, AYQ	(-)COP, 11-1995→	81522
	47	11/95→06/03	1.896	D	M	4	8	AEY, AYQ	(+)COP, CR	82080
1.9 TDI	66	09/96→06/03	1.896	D	M	4	8	ALH	11-1995→	81706

## LEON I

1.4 16V	55	11/99→06/06	1.390	B	M	4	16	AHW, APE, AXP, BCA		81777
1.6	74	11/99→06/06	1.595	B	M	4	8	AEH, AKL		81702
	75	10/05→06/06	1.595	B	M	4	8	BFQ		81702
1.6 16 V	77	09/00→06/06	1.598	B	M	4	16	AUS, AZD, BCB		81840
1.8 20V	92	11/99→06/06	1.781	B	AM	4	20	AGN, APG		81703
1.8 20V T	132	11/99→06/06	1.781	B	M	4	20	APP, AUQ		81703
1.8 20V T 4	132	11/99→06/06	1.781	B	M	4	20	AJQ, ARY		81703
1.8 T Cupra R	154	02/02→06/06	1.781	B	M	4	20	AMK		81703
	165	07/03→06/06	1.781	B	M	4	20	BAM		81703
1.8 Turbo 4x4	154	05/02→05/03	1.781	B	M	4	20	AMK		81703
1.9 SDI	50	11/99→06/06	1.896	D	M	4	8	AQM		81706
1.9 TDI	66	11/99→06/06	1.896	D	M	4	8	AGR, ALH		81706
	74	10/05→06/06	1.896	D	M	4	8	AXR		81816
	81	11/99→06/06	1.896	D	M	4	8	AHF, ASV		81706
	96	05/03→06/06	1.896	D	M	4	8	ASZ		81816
	110	02/01→06/06	1.896	D	M	4	8	ARL		81816
1.9 TDI Syncro	110	05/02→06/06	1.896	D	M	4	8	ARL		81816
2.3 VR5	125	09/00→11/03	2.324	B	M	5	20	AQN		81856
2.8	150	05/02→06/04	2.792	B	M	6	24	BDE		81866
2.8 Cupra 4	150	02/01→06/06	2.792	B	M	6	24	AUE	→09-2001	81773
	150	02/01→06/06	2.792	B	M	6	24	AUE	10-2001→	81866

	kw		Cap. cm3	Fuel	Gear	No. of cyl.	No. of valves	Motor code		Short
--	----	--	----------	------	------	-------------	---------------	------------	--	-------

## SEAT

### LEON II

1.4 16V	55	09/05→	1.390	B	M	4	16	BCA		81777
	63	06/06→	1.390	B	M	4	16	BXW		81777
1.4 TSI	92	11/07→	1.390	B	M	4	16	CAXC		82097
1.6	75	07/05→	1.595	B	M	4	8	BSE, BSF		81702
1.6 16V	77	09/05→	1.597	B	M	4	16			81702
1.6 LPG	75	12/09→	1.595	BF	M	4	8	CHGA		81702
1.6 TDI	66	11/10→	1.598	D	M	4	16	CAYB		83000
	77	02/10→	1.598	D	M	4	16	CAYC		83000
1.8 T 20V	132	09/05→	1.781	B	M	4	20	AUQ		81703
	165	09/05→	1.781	B	M	4	20	BAM		81703
1.8 TSI	118	06/07→	1.798	B	M	4	16	BZB		82096
1.9 TDI	66	06/07→	1.896	D	M	4	8	BXF		81791
	77	07/05→	1.896	D	M	4	8	BKC, BLS		81791
	81	09/05→	1.896	D	M	4	8	ASV		81706
1.9 TDi	81	10/05→	1.896	D	M	4	8	ASV		81791
	110	09/05→	1.896	D	M	4	8		M: AHF-ASV	81706
2.0 D	100	08/05→	1.968	D	M	4	16	AZV		81816
2.0 FSI	110	07/05→	1.984	B	M	4	16	BLR, BLY, BVY, BVZ		81702
2.0 TDI	100	07/05→	1.968	D	M	4	16	AZV		81816
	103	10/05→	1.968	D	M	4	8	BMM		81816
	125	05/06→	1.968	D	M	4	16	BMN		81816
2.0 TDI 16V	103	07/05→	1.968	D	M	4	16	BKD		81816
2.0 TFSI	136	09/05→05/06	1.984	B	M	4	16	BWA1		82025
	147	05/05→	1.984	B	M	4	16	BWA		82025
	155	06/09→	1.984	B	M	4	16	CCZB		82096
	177	11/06→	1.984	B	M	4	16	BWJ		82025
	195	09/09→	1.984	B	M	4	16	CDLA		82096

### TOLEDO I

1.6 i	52	05/91→12/93	1.595	B	M	4	8	1F	(-)COP	81522
	52	05/91→12/93	1.595	B	M	4	8	1F	(+)COP, CR	82080
	54	05/91→03/99	1.595	B	M	4	8	1F, ABN, EZ	(-)COP, 05-1991→	81522
	54	05/91→03/99	1.595	B	M	4	8	1F, ABN, EZ	(+)COP, CR	82080
	55	01/93→03/99	1.595	B	M	4	8	1F	(-)COP, 05-1991→	81522
	55	01/93→03/99	1.595	B	M	4	8	1F	(+)COP, CR	82080
	74	11/96→03/99	1.595	B	M	4	8	AFT	(-)COP	81522
	74	11/96→03/99	1.595	B	M	4	8	AFT	(+)COP, CR	82080
1.8 16V	92	05/91→03/99	1.781	B	M	4	16	PL	(-)COP, 05-1991→	81522
	92	05/91→03/99	1.781	B	M	4	16	PL	(+)COP, CR	82080
	98	05/91→03/99	1.781	B	M	4	16	KR	(-)COP, 05-1991→	81522
	98	05/91→03/99	1.781	B	M	4	16	KR	(+)COP, CR	82080
1.8 GT	102	05/91→11/92	1.781	B	M	4	16	KR	(-)COP	81522
	102	05/91→11/92	1.781	B	M	4	16	KR	(+)COP, CR	82080
1.8 i	65	05/91→12/96	1.781	B	M	4	8	RP	(-)COP	81522
	65	05/91→12/96	1.781	B	M	4	8	RP	(+)COP, CR	82080
	66	11/93→12/96	1.781	B	M	4	8	ABS, ADZ	(-)COP	81522
	66	11/93→12/96	1.781	B	M	4	8	ABS, ADZ	(+)COP, CR	82080

	kw		Cap. cm3	Fuel	Gear	No. of cyl.	No. of valves	Motor code		Short
--	----	--	----------	------	------	-------------	---------------	------------	--	-------

## SEAT

### TOLEDO I

1.9 D	47	12/95→03/99	1.896	D	M	4	8	1Y	(-)COP, 05-1991→	81522
	47	12/95→03/99	1.896	D	M	4	8	1Y	(+)COP, CR	82080
	50	05/91→03/99	1.896	D	M	4	8	1Y	(-)COP, 05-1991→	81522
	50	05/91→03/99	1.896	D	M	4	8	1Y	(+)COP, CR	82080
1.9 SDI	47	12/95→03/99	1.896	D	M	4	8	1Y	(-)COP, 05-1991→	81522
	47	12/95→03/99	1.896	D	M	4	8	1Y	(+)COP, CR	82080
1.9 TD	55	05/91→03/99	1.896	D	M	4	8	AAZ	(-)COP, 05-1991→	81522
	55	05/91→03/99	1.896	D	M	4	8	AAZ	(+)COP, CR	82080
1.9 TDI	66	08/95→03/99	1.896	D	M	4	8	1Z, AHU	(-)COP, 05-1991→	81522
	66	08/95→03/99	1.896	D	M	4	8	1Z, AHU	(+)COP, CR	82080
	81	11/96→03/99	1.896	D	M	4	8	AFN	(-)COP, 05-1991→	81522
	81	11/96→03/99	1.896	D	M	4	8	AFN	(+)COP, CR	82080
2.0 i	85	05/91→03/99	1.984	B	M	4	8	2E, AGG	(-)COP	81522
	85	05/91→03/99	1.984	B	M	4	8	2E, AGG	(+)COP, CR	82080
2.0 i 16V	110	11/93→03/99	1.984	B	M	4	16	ABF	(-)COP, 01-1997→	81522
	110	11/93→03/99	1.984	B	M	4	16	ABF	(+)COP, CR	82080

### TOLEDO II

1.4 16V	55	07/99→05/06	1.390	B	M	4	16	AHW, AXP		81777
1.6	74	04/99→09/00	1.595	B	M	4	8	AEH, AKL	08-1995→	81702
1.6 16V	77	09/00→05/06	1.598	B	M	4	16	AUS, AZD		81840
1.8 20V	92	04/99→05/06	1.781	B	AM	4	20	AGN, APG		81703
1.8 20VT	132	05/01→05/06	1.781	B	AM	4	20	AUQ		81703
1.9 SDI	50	11/99→06/04	1.896	D	M	4	8	AQM		81706
1.9 TDI	66	04/99→05/06	1.896	D	M	4	8	AGR, ALH	05-1991→	81706
	81	04/99→05/06	1.896	D	M	4	8	AHF, ASV	05-1991→	81706
	96	05/03→05/06	1.896	D	M	4	8	ASZ		81816
	110	10/00→05/06	1.896	D	M	4	8	ARL		81816
2.3 V5	110	04/99→05/01	2.324	B	M	5	10	AGZ		81856
2.3 V5 20V	125	05/01→05/06	2.324	B	M	5	20	AQN		81856

### TOLEDO III

1.6	75	10/04→05/09	1.595	B	M	4	8	BGU, BSE, BSF		81702
1.9 TDI	77	10/04→	1.896	D	M	4	8	BJB, BKC		81791
2.0 FSI	110	10/04→	1.984	B	M	4	16	BLR, BLY		81702
2.0 TDI	103	04/04→05/09	1.968	D	M	4	16	BKD		81816

## SKODA

### FABIA I, STATION WAGON

1.2	40	07/01→03/08	1.198	B	M	3	6	AWY, BMD		81867
	47	01/03→03/08	1.198	B	M	3	12	AZQ, BME		81867
1.4 16V	55	10/99→03/08	1.390	B	AM	4	16	AUA, BBY, BKY		81777
	59	04/06→12/07	1.390	B	M	4	16	BUD		81777
	74	04/00→12/07	1.390	B	AM	4	16	AUB, BBZ		81777
	74	12/99→03/08	1.390	B	M	4	16	AUB, BBZ		81777
1.4 TDI	51	10/05→03/08	1.422	D	M	3	6	BNM		81791
	55	04/03→03/08	1.422	D	M	3	6	AMF		81791
	59	10/05→03/08	1.422	D	M	3	6	BNV		81791

	kw		Cap. cm3	Fuel	Gear	No. of cyl.	No. of valves	Motor code		Short
--	----	--	----------	------	------	-------------	---------------	------------	--	-------

## SKODA

### FABIA I, STATION WAGON

1.9 SDI	47	11/99→03/08	1.896	D	M	4	8	ASY		82013
1.9 TDI	74	01/00→03/08	1.896	D	M	4	8	ATD		81791
1.9 TDI RS	96	06/03→03/08	1.896	D	M	4	8	ASZ		81791
2.0	85	12/99→03/08	1.984	B	M	4	8	AQY, AZL		81703

### FABIA II, STATION WAGON

1.2	44	12/06→	1.198	B	M	3	6	BBM		81867
	51	01/07→	1.198	B	M	3	12	BZG		81867
1.2 TDI	55	05/10→	1.199	D	M	3	12	CFWA		83000
1.4	63	01/07→	1.390	B	M	4	16	BXW		81777
1.4 TDI	51	02/07→	1.422	D	M	3	6	BNM		81791
	59	01/07→	1.422	D	M	3	6	BMS		81791
1.6	77	04/07→	1.598	B	M	4	16	BTS		81865
1.6 TDI	55	04/10→	1.598	D	M	4	16	CAYA		83000
	66	03/10→	1.598	D	M	4	16	CAYB		83000
	77	03/10→	1.598	D	M	4	16	CAYC		83000
	77	04/07→	1.896	D	M	4	8	BLS, BSW		81791

### FELICIA I, STATION WAGON

1.6	55	06/97→	1.598	B	M	4	8	AEE		81527
1.6 GLX	55	08/95→03/98	1.598	B	M	4	8	AEE		81527
1.6 LX	55	08/95→03/98	1.598	B	M	4	8	AEE		81527
1.9 D	47	10/95→03/98	1.896	D	M	4	8	AEF		81528

### FELICIA II, STATION WAGON

1.6	55	01/98→06/01	1.598	B	M	4	8	AEE		81527
1.9 D	47	01/98→06/01	1.896	D	M	4	8	AEF		81528

### OCTAVIA I, STATION WAGON

1.4 16V	55	08/00→	1.390	B	M	4	16	AXP, BCA		81777
1.6	55	09/96→09/00	1.598	B	M	4	8	AEE		81527
	74	02/97→	1.595	B	AM	4	8	AEH, AKL		81702
	74	07/98→	1.595	B	M	4	8	AEH, AKL		81702
	75	09/00→	1.595	B	M	4	8	AVU, BFQ		81702
1.8	92	09/96→	1.781	B	M	4	20	AGN		81703
1.8 20V	92	07/98→	1.781	B	M	4	20	AGN		81703
1.8 T	110	07/98→	1.781	B	M	4	20	AGU, ARX, ARZ, AUM		81703
	110	08/97→	1.781	B	AM	4	20	AGU, ARX, ARZ, AUM		81703
1.8 T 4x4	110	05/01→	1.781	B	M	4	20	AGU, ARX, AUM		81703
1.9 SDI	50	06/97→	1.896	D	M	4	8	AGP, AQM		81706
1.9 TDI	66	07/98→	1.896	D	M	4	8	AGR, ALH		81706
	66	09/96→	1.896	D	AM	4	8	AGR, ALH		81706
	81	08/97→	1.896	D	M	4	8	AHF, ASV		81706
	96	01/03→	1.896	D	M	4	8	ASZ		81816
1.9 TDI 4x4	66	11/99→09/00	1.896	D	M	4	8	AGR		81706
	74	09/00→	1.896	D	M	4	8	ATD		81816
2.0	85	04/99→	1.984	B	AM	4	8	AEG, APK, AQY, AZH		81703
	85	04/99→	1.984	B	M	4	8	AEG, APK, AQY, AZH, AZJ		81703
	88	01/00→	1.984	B	M	4	8	ATF		81703

	<b>kw</b>		<b>Cap. cm3</b>	<b>Fuel</b>	<b>Gear</b>	<b>No. of cyl.</b>	<b>No. of valves</b>	<b>Motor code</b>		
--	-----------	--	-----------------	-------------	-------------	--------------------	----------------------	-------------------	--	--

## SKODA

### OCTAVIA I, STATION WAGON

2.0 4x4	85	05/01→	1.984	B	M	4	8	AEG, AQY, AZH, AZJ		81703
RS 1.8 T	132	05/01→	1.781	B	M	4	20	AUQ		81703

### OCTAVIA II, STATION WAGON

1.4	55	05/04→	1.390	B	M	4	16	BCA		81777
	59	06/04→	1.390	B	M	4	16	BUD		81777
1.4 TSI	90	11/08→	1.390	B	M	4	16	CAXA		82097
1.6	75	06/04→	1.595	B	M	4	8	BGU		81702
1.6 FSI	85	02/04→	1.598	B	M	4	16	BLF		81865
1.6 GreenLine	75	01/08→	1.595	FF	M	4	8	CCSA		81702
1.6 LPG	75	08/09→	1.595		M	4	8	CHGA		81702
1.6 TDI	77	06/09→	1.598	D	M	4	16	CAYC		83000
1.6 TDI 4x4	77	06/09→	1.598	D	M	4	16	CAYC		83000
1.8	118	06/07→	1.798	B	M	4	16			82096
1.8 TSI	118	06/07→	1.798	B	M	4	16	BZB		82096
1.8 TSI 4x4	118	11/08→	1.798	B	M	4	16	CDAA		82096
1.9 TDI	77	06/04→	1.896	D	M	4	8	BJB, BKC		81791
1.9 TDI 4x4	77	11/04→	1.896	D	M	4	8	BKC		81791
2.0 FSI	110	11/04→11/05	1.984	B	M	4	16	BLR, BLY		81702
2.0 FSI 4x4	110	11/04→	1.984	B	M	4	16	BLX		81702
2.0 RS	147	10/05→	1.984	B	M	4	16	BWA		82025
2.0 TDI	103	11/05→	1.968	D	M	4	8	BMM		81816
	125	04/06→	1.968	D	M	4	16	BMN		81816
2.0 TDI 16V	100	02/04→	1.968	D	M	4	16	AZV		81816
	103	02/04→	1.968	D	M	4	16	BKD		81816
2.0 TDI 16V 4x4	103	07/06→	1.968	D	M	4	8	BMM		81816

### PRAKTIK

1.2	51	03/07→	1.198	B	M	3	12	BZG		81867
1.4	63	03/07→	1.390	B	M	4	16	BXW		81777
1.4 TDI	51	03/07→	1.422	D	M	3	6	BNM		81791
	59	03/07→	1.422	D	M	3	6	BMS		81791

### ROOMSTER

1.2	47	05/06→01/07	1.198	B	M	3	12	BME		81867
	51	01/07→	1.198	B	M	3	12	BZG		81867
1.4	63	09/06→	1.390	B	M	4	16	BXW		81777
1.4 TDI	51	07/06→	1.422	D	M	3	6	BNM		81791
	59	09/06→	1.422	D	M	3	6	BMS		81791
1.6	77	09/06→	1.598	B	M	4	16	BTS		81865
1.6 TDI	66	03/10→	1.598	D	M	4	16	CAYB		83000
	77	03/10→	1.598	D	M	4	16	CAYC		83000
1.9 TDI	77	09/06→	1.896	D	M	4	8	BLS		81791

### SUPERB I

1.8 T	110	02/02→03/08	1.781	B	M	4	20	AWT		81703
1.9 TDI	74	08/02→10/05	1.896	D	M	4	8	AVB		81816
	77	10/05→05/07	1.896	D	M	4	8	BSV		81816
	96	02/02→03/08	1.896	D	M	4	8	AVF, AWX		81816

	kw		Cap. cm3	Fuel	Gear	No. of cyl.	No. of valves	Motor code		Short
--	----	--	----------	------	------	-------------	---------------	------------	--	-------

## SKODA

### SUPERB I

2.0	85	02/02→03/08	1.984	B	M	4	8	AZM		81703
2.0 TDI	103	10/05→03/08	1.968	D	M	4	8	BSS		81816
2.5 TDI	114	02/02→08/03	2.496	D	AM	6	24	AYM		81705
	120	06/03→03/08	2.496	D	M	6	24	BDG		81705
2.8 V6	142	02/02→03/08	2.771	B	AM	6	30	AMX		81842

### SUPERB II, STATION WAGON

1.4 TSI	92	07/08→	1.390	B	M	4	16	CAXC		82097
1.8 TSI	118	03/08→	1.798	B	M	4	16	BZB, CDAA		82096
1.8 TSI 4x4	118	11/08→	1.798	B	M	4	16	CDAA		82096
1.9 TDI	77	03/08→	1.896	D	M	4	8	BLS, BXE		81791
2.0 TDI	103	03/08→	1.968	D	M	4	8	BMP		81816
	125	07/08→	1.968	D	M	4	16	CBBB, CFGB		81816
2.0 TDI 16V	103	01/09→	1.968	D	M	4	16	BKD, CFFB, CLJA		81816
2.0 TDI 4x4	125	09/08→	1.968	D	M	4	16	CBBB, CFGB		81816
3.6 4x4	191	11/08→	3.580	B	M	6	24	CDVA		81866
3.6 FSI 4x4	191	04/09→	3.597	B	M	6	24			81866
3.6 V6 4x4	191	10/09→	3.580	B	M	6	24	CDVA		81866

### YETI

1.4 TSI	90	06/10→	1.390	B	M	4	16	CAXA		82097
1.8 TSI 4x4	118	05/09→	1.798	B	M	4	16	CDAA		82096
2.0 TDI	81	11/09→	1.968	D	M	4	16	CFHA		83000
2.0 TDI 4x4	81	11/09→	1.968	D	M	4	16	CFHF		83000
	103	05/09→	1.968	D	M	4	16	CBDB, CFHC	M: CBDB	81816
	103	05/09→	1.968	D	M	4	16	CBDB, CFHC	M: CFHC	83000
	125	11/09→	1.968	D	M	4	16	CEGA, CFJA	M: CEGA	81816
	125	11/09→	1.968	D	M	4	16	CEGA, CFJA	M: CFJA	83000

## SMART

### FORFOUR

1.1	47	02/05→	1.124	B	M	3	6			82049
	55	01/04→	1.124	B	M	3	6			82049
1.3	70	01/04→	1.332	B	M	4	16			82049
1.5	80	01/04→	1.499	B	M	4	16	M135.950		82049
	90	01/04→	1.499	B	M	4	16			82049
1.5 BRABUS	130	05/05→	1.468	B	M	4	16			82049
1.5 CDI	50	09/04→	1.493	D	M	3	12	OM639.939		82017
	70	09/04→	1.493	D	M	3	12	OM639.939		82017

## SSANGYONG

### KORANDO

2.0	94	05/97→	1.998	B	M	4	8			81718
2.3	103	05/97→	2.295	B	M	4	8			81718
	105	01/99→	2.295	B	M	4	8			81718
2.3 D	58	12/96→	2.299	D	M	4	8	OM601.940		81506
2.9 D	72	12/96→	2.874	D	M	5	10	MB-OM662		81506



	kw		Cap. cm3	Fuel	Gear	No. of cyl.	No. of valves	Motor code		MAGNETI MARELLI Short
<b>SSANGYONG</b>										
2.9 TD	88	04/98→	2.874	D	M	5	10			81506
3.2	154	12/96→	3.199	B	M	6	24	M104.995		81724
	156	01/99→	3.199	B	M	6	24	M104.995		81724
	162	06/97→	3.199	B	M	6	24			81724
<b>MUSSO</b>										
2.0	93	10/96→	1.998	B	M	4	8	E20		81718
2.3	103	10/96→	2.295	B	M	4	16	M111.970		81718
	110	04/03→	2.295	B	M	4	16			81718
2.3 D	59	10/95→	2.299	D	M	4	8	MB-OM661, OM601.940		81506
2.9 D	73	03/96→	2.874	D	M	5	10	MB-OM662		81506
2.9 TD	88	04/98→	2.874	D	M	5	10			81506
3.2	162	06/96→	3.199	B	M	6	24	M104.992		81724
<b>REXTON</b>										
2.9	88	04/02→	2.874	D	M	5	10			81506
3.2	162	04/02→	3.199	B	M	6	24			81724
<b>SUBARU</b>										
<b>JUSTY II</b>										
1.3 4x4	63	04/01→11/03	1.298	B	M	4	16	G13BB		81858
1.3 GX 4x4	50	10/95→11/03	1.298	B	M	4	8	EF13		81858
<b>JUSTY III</b>										
1.3	69	09/03→	1.328	B	M	4	16			82026
1.5	73	09/03→	1.490	B	M	4	16	M15A		82026
<b>JUSTY IV</b>										
1.0	51	01/07→	998	B	M	3	12			82063
<b>SUZUKI</b>										
<b>ALTO III</b>										
1.0	39	09/94→06/02	993	B	M	4	16	G10B	01-1991→	81858
1.0	43	01/00→	993	B	M	4	16	G10B		81858
<b>ALTO IV</b>										
1.1	46	06/02→	1.061	B	M	4	8			81858
<b>BALENO, STATION WAGON</b>										
1.3	52	09/96→05/02	1.298	B	M	4	8	G13BA		81858
1.3 16V	63	03/97→05/02	1.298	B	M	4	16	G13BB		81858
1.3 i 16V	63	07/95→05/02	1.298	B	M	4	16	G13B	01-1994→	81858
1.6 i 16V	72	07/95→05/02	1.590	B	M	4	16	G16B		81790
1.6 i 16V 4x4	72	07/95→05/02	1.590	B	M	4	16	G16B		81790
1.8 GT	89	03/96→05/02	1.839	B	M	4	16	J18A		81790
1.8 i 16V	89	08/96→05/02	1.839	B	M	4	16	J18A		81790
1.9 TD	55	04/98→05/02	1.905	D	M	4	8			81642
<b>GRAND VITARA I</b>										
1.6	69	03/98→	1.590	B	M	4	16	G16B		82050
1.6 4 ruote motrici	73	02/00→09/02	1.590	B	M	4	16			82050
2.0 HDI 110	80	07/01→	1.997	D	M	4	16	RHW, RHZ		81713

	kw		Cap. cm3	Fuel	Gear	No. of cyl.	No. of valves	Motor code		MAGNETI MARELLI Short
--	----	--	----------	------	------	-------------	---------------	------------	--	-----------------------

## SUZUKI

### GRAND VITARA II

1.6	78	04/05→	1.586	B	M	4	16	M16A		82050
1.6 4 ruote motrici	73	09/05→	1.586	B	M	4	16	M16A		82050
1.9 DDIS	95	10/05→	1.870	D	M	4	16			81868

### IGNIS I

1.3	61	10/00→09/03	1.328	B	AM	4	16	M13A	M: M13A	82026
1.3 4WD	61	10/00→09/03	1.328	B	M	4	16	M13A		82026

### IGNIS II

1.3	69	09/03→	1.328	B	M	4	16	M13A		82026
1.3 4x4	69	09/03→	1.328	B	M	4	16	M13A		82026
1.3 DDIS	51	09/03→	1.248	D	M	4	16	Z13DT		81862
1.5	73	09/03→	1.490	B	M	4	16	M15A		82026
1.5 4x4	73	09/03→	1.490	B	M	4	16	M15A		82026
1.5 Sport	80	12/03→	1.490	B	M	4	16	M15A		82026

### JIMNY

1.3 16V	59	09/98→	1.298	B	M	4	16	G13BB		81789
	60	02/01→	1.328	B	M	4	16	M13A		82026
	63	08/05→	1.328	B	M	4	16	M13A		82026
1.3 16V 4WD	59	09/98→	1.298	B	M	4	16	G13BB		81789
	60	02/01→	1.328	B	M	4	16	M13A	M: G13BB	82026
1.3 4x4	63	09/98→08/00	1.298	B	M	4	16	G13BB		81789
	65	09/00→08/02	1.328	B	M	4	16	M13A		82026
1.5 DDIS	63	08/05→	1.461	D	M	4	16			81810
1.5 DDIS 4WD	48	12/03→	1.461	D	M	4	8	K9K700		81810

### LIANA, STATION WAGON

1.3	66	03/02→	1.328	B	M	4	16	M13A		82026
	66	07/01→	1.328	B	M	4	8			82026
1.4 DDIS	66	04/04→	1.398	D	M	4	8	8HY		81798
1.6	76	03/02→	1.586	B	M	4	8			82026
	76	07/01→	1.586	B	AM	4	8			82026
	78	04/02→	1.586	B	M	4	16	M16A		82026
1.6 4WD	76	03/02→	1.586	B	M	4	8			82026
	76	07/01→	1.586	B	AM	4	8			82026
	78	04/02→	1.586	B	M	4	16	M16A		82026

### SAMURAI

1.3	44	11/88→	1.324	B	M	4	8	G13A		81789
	47	11/88→	1.324	B	M	4	8	G13A		81789
	51	11/88→	1.298	B	M	4	8	G13BA		81789
1.9 TD	46	11/98→	1.905	D	M	4	8	XUD9		81642

### SJ 413

1.3	44	08/86→08/90	1.324	B	M	4	8	G13A		81789
1.3	47	09/84→12/88	1.324	B	M	4	8	G13A		81789

### SPLASH

1.3 CDTI	55	01/08→	1.248	D	M	4	16	D13A		81862
----------	----	--------	-------	---	---	---	----	------	--	-------

	kw		Cap. cm3	Fuel	Gear	No. of cyl.	No. of valves	Motor code		MAGNETI MARELLI Short
--	----	--	----------	------	------	-------------	---------------	------------	--	-----------------------

## SUZUKI

### SWIFT I

1.0	37	10/83→03/89	993	B	M	3	6	G10, G10A		81858
1.0 Turbo	52	02/85→12/89	993	B	M	3	6			81789
1.3	47	08/86→03/89	1.324	B	M	4	8	G13A		81858
	50	10/84→03/89	1.324	B	M	4	8	G13A		81858
	54	10/84→03/89	1.324	B	M	4	8	G13A		81858
1.3 GTi/GXi	74	08/86→03/89	1.298	B	M	4	16	G13B		81858

### SWIFT II, CABRIO

1.0	37	03/89→05/01	993	B	M	3	6	G10A		81858
1.0 i	39	09/91→05/01	993	B	M	3	6	G10A		81858
	40	03/89→12/91	993	B	M	3	6	G10A		81858
1.3	50	03/89→05/01	1.298	B	M	4	8	G13A, G13BA		81858
	50	03/89→05/01	1.324	B	M	4	8	G13A		81858
	52	03/89→12/91	1.324	B	M	4	8	G13A		81858
1.3 4WD	50	03/89→05/01	1.324	B	M	4	8	G13A		81858
	52	10/89→12/91	1.324	B	M	4	8	G13A		81858
1.3 GTi	74	03/89→05/01	1.298	B	M	4	16	G13B		81858
1.6	70	11/89→12/91	1.590	B	M	4	16	G16B		81790
1.6 4WD	70	11/89→12/91	1.590	B	M	4	16	G16B		81790
1.6 i	68	01/90→05/01	1.590	B	M	4	16	G16B		81790
1.6 i 4WD	68	01/90→05/01	1.590	B	M	4	16	G16B		81790

### SWIFT III

1.3	68	02/05→	1.328	B	M	4	16	M13A		82026
1.3 4x4	66	01/06→	1.328	B	M	4	16	M13A		82026
	68	02/05→	1.328	B	M	4	16	M13A		82026
1.3 DDiS	51	08/05→	1.248	D	M	4	16	Z13DT		81862
	55	08/05→	1.248	D	M	4	16	D13A		81862
1.5	75	02/05→	1.490	B	M	4	16	M15A		82026
1.5 4x4	74	02/05→	1.490	B	M	4	16	M15A		82026
1.6	92	05/06→	1.586	B	M	4	16	M16A		82026

### SX4

1.5	73	06/06→	1.490	B	M	4	16	M15A		82026
1.6	74	06/06→	1.586	B	M	4	16	M16A		82026
	75	10/07→	1.586	B	M	4	16	M16A		82026
	79	10/07→	1.586	B	M	4	16	M16A		82026
	79	10/07→	1.586	B	M	4	16	M16A		82026
1.6 DDiS	66	04/07→	1.560	D	M	4	16	9HX		81869
1.6 VVT	79	06/06→	1.586	B	M	4	16	M16A		82026
	88	07/09→	1.586	B	M	4	16	M16A		82026
1.6 VVT 4x4	79	06/06→	1.586	B	M	4	16	M16A		82026
	88	07/09→	1.586	B	M	4	16	M16A		82026
1.9 DDiS	88	06/06→	1.910	D	M	4	8	D19AA		81352
1.9 DDiS 4x4	88	06/06→	1.910	D	M	4	8	D19AA		81352
2.0 DDiS	99	07/09→	1.956	D	M	4	16	D20AA		81872
2.0 DDiS 4x4	99	07/09→	1.956	D	M	4	16	D20AA		81872

	kw		Cap. cm3	Fuel	Gear	No. of cyl.	No. of valves	Motor code		Short
--	----	--	----------	------	------	-------------	---------------	------------	--	-------

## SUZUKI

### VITARA, CABRIO

1.6	59	07/88→03/98	1.589	B	M	4	8	G16A		81790
	60	07/88→12/91	1.589	B	M	4	8	G16A		81790
1.6 16V	71	07/90→03/99	1.589	B	M	4	16	G16B		81790
1.9 D	50	01/95→03/98	1.905	D	M	4	8	XUD9A		81642
	55	08/96→03/99	1.905	D	M	4	8	XUD9SD		81642
2.0 V6 24V	100	12/94→03/98	1.998	B	M	6	24	H20A		81790

### WAGON R, R+ III

1.3	56	05/00→	1.298	B	AM	4	16	G13BB		81858
	65	08/01→	1.328	B	M	4	16	M13A		82026
	69	09/03→	1.328	B	M	4	16	M13A		82026
1.3 4WD	56	10/01→	1.298	B	M	4	8			81858
	69	09/03→	1.328	B	M	4	16	M13A		82026
1.3 DDiS	51	09/03→	1.248	D	M	4	16	Z13DT		81862

### X-90

1.6 i 16V	71	09/95→	1.590	B	M	4	16	G16B		81790
1.6 i 16V 4x4	71	09/95→	1.590	B	M	4	16	G16B		81790

## TATA

### INDICA VISTA

1.2	48	08/08→	1.172	B	M	4	16			82070
1.3	55	08/08→	1.248	D	M	4	16			81862

### INDIGO MANZA

1.3 D	66	08/09→	1.248	D	M	4	16	169A1.000		81862
1.4	66	08/09→	1.368	B	M	4	8	350A1.000		82070

## TOYOTA

### AURIS

1.4 D-4D	66	03/07→	1.364	D	M	4	16		→01-2009	81821
1.4 VVTi	71	03/07→	1.398	B	M	4	16	4ZZ-FE		82012
2.0 D-4D	93	03/07→	1.998	D	M	4	16	1AD-FTV		82071
2.2 D	130	03/07→	2.231	D	M	4	16	2AD-FHV		82071

### AVENSIS I, LIFTBACK, STATION WAGON

1.6	74	09/97→10/00	1.587	B	M	4	16	4A-FE	(+)COP	81767
	81	09/97→10/00	1.587	B	M	4	16	4A-FE	(+)COP	81767
1.6 VVT-i	81	10/00→02/03	1.598	B	M	4	16	3ZZ-FE		82012
1.8	81	09/97→10/00	1.762	B	M	4	16	7A-FE	(+)COP, OEM: SEM	81768
	81	09/97→10/00	1.762	B	M	4	16	7A-FE	(+)COP, OEM: AISIN	81769
1.8 VVT-i	95	10/00→02/03	1.794	B	AM	4	16	1ZZ-FE		82012
2.0	94	09/97→10/00	1.998	B	M	4	16	3S-FE	(-)COP, 01-1997→	81770
2.0 D-4D	81	10/99→02/03	1.995	D	M	4	16	1CD-FTV		82022

### AVENSIS II, STATION WAGON

1.6 VVT-i	81	04/03→	1.598	B	M	4	16	3ZZ-FE		82012
1.8	95	04/03→	1.794	B	M	4	16	1ZZ-FE		82012
2.0 D-4D	85	04/03→	1.995	D	M	4	16	1CD-FTV	→06-2004	82022
	85	04/03→	1.995	D	M	4	16	1CD-FTV	07-2004→	82044
	93	03/06→	1.998	D	M	4	16	1AD-FTV		82071

	kw		Cap. cm3	Fuel	Gear	No. of cyl.	No. of valves	Motor code		Short
--	----	--	----------	------	------	-------------	---------------	------------	--	-------

## TOYOTA

### AVENSIS II, STATION WAGON

2.2 D-4D	110	10/05→	2.231	D	M	4	16	2AD-FTV		82071
2.2 D-CAT	130	07/05→	2.231	D	M	4	16	2AD-FHV		82071

### AVENSIS III, STATION WAGON

2.0 D	93	02/09→	1.998	D	M	4	16	1AD-FTV		82071
2.2 D	110	02/09→	2.231	D	M	4	16	2AD-FTV		82071
	130	02/09→	2.231	D	M	4	16	2AD-FHV		82071

### AVENSIS VERSO

2.0 D-4D	85	08/01→	1.995	D	M	4	16	1CD-FTV		82022
----------	----	--------	-------	---	---	---	----	---------	--	-------

### AYGO

1.0	50	07/05→	998	B	M	3	12	1KR-FE		82063
1.0 GPL	50	07/05→	998		M	3	12			82063
1.4 HDi	40	07/05→	1.398	D	M	4	8			81798

### CAMRY II, STATION WAGON

2.0	94	11/86→05/91	1.998	B	M	4	16	3S-FE	(-)COP	81770
2.0 Gli 16V	89	11/86→05/91	1.998	B	M	4	16	3S-FE	(-)COP	81770
2.0 GLi 4x4	88	10/87→07/88	1.998	B	M	4	16	3S-FE	(-)COP	81770

### CAMRY III, STATION WAGON

2.2	100	06/91→08/96	2.164	B	M	4	16	5S-FE	(-)COP	81770
-----	-----	-------------	-------	---	---	---	----	-------	--------	-------

### CAMRY IV, STATION WAGON

2.2	93	11/00→11/01	2.164	B	M	4	16	5S-FE	(-)COP	81770
	96	08/96→11/01	2.164	B	AM	4	16	5S-FE	(-)COP, 01-1993→	81770
3.0 24V	140	08/96→11/01	2.995	B	A	6	24	1MZ-FE		82051
3.0 V6	135	08/96→11/01	2.995	B	M	6	24	1MZ-FE		82051

### CAMRY V, STATION WAGON

3.0 V6	137	11/01→	2.995	B	A	6	24	1MZ-FE		82051
--------	-----	--------	-------	---	---	---	----	--------	--	-------

### CARINA E (T19), STATION WAGON

1.5 SG	77	04/92→09/97	1.498	B	M	4	8		(-)COP	81771
1.6	73	12/93→09/97	1.587	B	M	4	16	4A-FE	(+)COP, →12-1994	81766
	73	12/93→09/97	1.587	B	M	4	16	4A-FE	(+)COP, 01-1995→	81767
	73	12/93→09/97	1.587	B	M	4	16	4A-FE	(-)COP	81815
	78	10/95→09/97	1.587	B	M	4	16	4A-FE	(+)COP	81767
	79	01/93→09/97	1.587	B	M	4	16	4A-FE	(+)COP, →12-1994	81766
	79	01/93→09/97	1.587	B	M	4	16	4A-FE	(+)COP, 01-1995→	81767
	79	01/93→09/97	1.587	B	M	4	16	4A-FE	(-)COP, →12-1994	81815
	85	12/93→09/97	1.587	B	M	4	16	4A-FE	(+)COP, →12-1994	81766
	85	12/93→09/97	1.587	B	M	4	16	4A-FE	(+)COP, 01-1995→	81767
	85	12/93→09/97	1.587	B	M	4	16	4A-FE	(-)COP	81815
1.6 16V	78	10/95→09/97	1.587	B	M	4	16	4A-FE	(+)COP	81767
	85	12/94→09/97	1.587	B	M	4	16	4A-FE	(+)COP	81767
1.6 GLI	79	04/92→09/97	1.587	B	M	4	16	4A-FE	(+)COP, →12-1994	81766
	79	04/92→09/97	1.587	B	M	4	16	4A-FE	(+)COP, 01-1995→	81767
	79	04/92→09/97	1.587	B	M	4	16	4A-FE	(-)COP, →12-1994	81815
1.6 i	73	02/95→09/97	1.587	B	M	4	16	4A-FE	(+)COP	81767
1.8	79	01/95→09/97	1.762	B	M	4	16	7A-FE	(+)COP, →12-1995	81768
	79	01/95→09/97	1.762	B	M	4	16	7A-FE	(+)COP, 01-1996→	81769

**kw**

**Cap. cm3**
**Fuel**
**Gear**
**No. of cyl.**
**No. of valves**
**Motor code**

**MAGNETI MARELLI**  
Short

**TOYOTA**
**CARINA E (T19), STATION WAGON**

1.8	85	04/92→09/97	1.762	B	M	4	16	7A-FE	(+)COP, 01-1995→, →12-1995	81768
	85	04/92→09/97	1.762	B	M	4	16	7A-FE	(+)COP, 01-1996→	81769
	85	04/92→09/97	1.762	B	M	4	16	7A-FE	(-)COP, →12-1994	81770
1.8 GL	92	10/94→09/97	1.762	B	M	4	16		(+)COP, →12-1995	81768
	92	10/94→09/97	1.762	B	M	4	16		(+)COP, 01-1996→	81769
1.8 i	79	02/95→09/97	1.762	B	M	4	16	7A-FE	(+)COP	81768
1.8 i 16V	79	01/95→09/97	1.762	B	M	4	16	7A-FE	(+)COP, →12-1995	81768
	79	01/95→09/97	1.762	B	M	4	16	7A-FE	(+)COP, 01-1996→	81769
2.0	98	01/93→09/97	1.998	B	M	4	16	3S-FE	(-)COP	81770
2.0 GLI	98	04/92→09/97	1.998	B	M	4	16	3S-FE	(-)COP	81770
2.0 GTi	116	04/92→02/94	1.998	B	M	4	16	3S-GE	(-)COP	81770
2.0 GTi 16V	129	03/94→09/97	1.998	B	M	4	16	3S-GE	(-)COP	81770
2.0 i	93	12/92→09/97	1.998	B	M	4	16	3S-FE	(-)COP	81770

**CELICA V, CABRIO, COUPÉ**

1.6 STI	77	10/89→01/94	1.587	B	M	4	16	4A-FE	(+)COP	81766
	77	10/89→01/94	1.587	B	M	4	16	4A-FE	(-)COP	81815
1.8 i 16V	85	11/93→11/99	1.762	B	M	4	16	7A-FE	(+)COP	81769

**CELICA VII**

1.8 16V TS	141	11/99→	1.796	B	M	4	16	2ZZ-GE		82035
1.8 16V VT-i	105	11/99→	1.794	B	M	4	16	1ZZ-FE		82012

**COROLLA V, STATION WAGON, LIFTBACK, COMPACT**

1.3 XLI	55	09/95→04/97	1.332	B	M	4	16	4E-FE	(-)COP	81771
	65	07/92→04/97	1.332	B	M	4	16	4E-FE	(-)COP	81771
1.3 XLI 16V	65	07/92→09/95	1.332	B	M	4	16	4E-FE	(-)COP	81771
1.6 GLI	84	07/92→04/97	1.587	B	M	4	16	4A-FE	(+)COP	81766
	84	07/92→04/97	1.587	B	M	4	16	4A-FE	(-)COP	81815
1.6 Si	84	07/92→04/97	1.587	B	M	4	16	4A-FE	(+)COP	81766
	84	07/92→04/97	1.587	B	M	4	16	4A-FE	(-)COP	81815
1.8 16V 4WD	81	09/95→04/97	1.762	B	M	4	16	7A-FE	(+)COP	81769
1.8 GT	86	11/92→05/95	1.762	B	M	4	16	7A-FE	(+)COP	81769

**COROLLA VERSO I**

1.4 VWT-i	71	01/02→05/04	1.398	B	M	4	16	4ZZ-FE		82012
1.6 VWT-i	81	01/02→05/04	1.598	B	M	4	16	3ZZ-FE		82012
1.8 VWT-i	99	01/02→05/04	1.794	B	A	4	16	1ZZ-FE		82012
2.0 D-4D	66	01/02→05/04	1.995	D	M	4	16	1CD-FTV		82022
2.0 D4d	85	06/04→	1.995	D	M	4	16	1CD-FTV		82022

**COROLLA VERSO II**

1.4 D4d	66	03/04→	1.364	D	M	4	8	1ND-TV	→01-2009	81821
1.6	81	04/04→	1.598	B	M	4	16	3ZZ-FE		82012
1.8	95	04/04→	1.794	B	M	4	16	1ZZ-FE		82012
2.0 D-4D	85	04/04→	1.995	D	M	4	16	1CD-FTV		82044
	100	10/05→	2.231	D	M	4	16	2AD-FTV		82071
	130	10/05→	2.231	D	M	4	16	2AD-FHV		82071

	kW		Cap. cm3	Fuel	Gear	No. of cyl.	No. of valves	Motor code		Short
--	----	--	----------	------	------	-------------	---------------	------------	--	-------

## TOYOTA

### COROLLA VI, STATION WAGON, LIFTBACK, COMPACT

1.4	63	04/97→02/00	1.332	B	M	4	16	4E-FE	(-)COP	81771
	71	02/00→01/02	1.398	B	M	4	16	4ZZ-FE	11-2001→	82012
1.4 16V	71	02/00→01/02	1.398	B	M	4	16	4ZZ-FE	11-2001→	82012
1.6	81	04/97→02/00	1.587	B	M	4	16	4A-FE	(+)COP	81766
	81	04/97→02/00	1.587	B	M	4	16	4A-FE	(-)COP	81815
	81	02/00→01/02	1.598	B	M	4	16	3ZZ-FE		82012
1.6 16V	81	02/00→01/02	1.598	B	M	4	16	3ZZ-FE		82012
1.6 Aut.	79	04/97→02/00	1.587	B	A	4	16	4A-FE	(+)COP	81766
	79	04/97→02/00	1.587	B	M	4	16	4A-FE	(+)COP	81766
	79	04/97→02/00	1.587	B	A	4	16	4A-FE	(-)COP	81815
	79	04/97→02/00	1.587	B	M	4	16	4A-FE	(-)COP	81815
1.8 AWD	81	04/97→01/02	1.762	B	M	4	16	7A-FE	(+)COP	81769
1.8 Linea Terra	81	10/97→10/01	1.762	B	M	4	16	7A-FE	(+)COP	81769
2.0 D-4D	66	09/00→01/02	1.995	D	M	4	16	1CD-FTV		82022

### COROLLA VII, STATION WAGON, LIFTBACK

1.4 D	66	07/04→	1.364	D	M	4	8	1ND-TV		81809
1.4 VVT-i	71	01/02→	1.398	B	M	4	16	4ZZ-FE		82012
1.6 VVT-i	81	01/02→	1.598	B	M	4	16	3ZZ-FE		82012
1.8	92	05/02→05/04	1.794	B	M	4	16	1ZZ-FE		82012
	96	06/04→	1.794	B	M	4	16	1ZZ-FE		82012
	100	06/04→	1.794	B	M	4	16	1ZZ-FE		82012
1.8 4 ruote motrici	100	12/01→	1.794	B	M	4	16	1ZZ-FE		82012
1.8 4x4	94	06/07→	1.797	B	M	4	16			82012
1.8 VVT-i TS	141	01/02→	1.796	B	M	4	16	2ZZ-GE		82035
	165	02/05→	1.796	B	M	4	16	2ZZ-GE		82035
2.0	85	06/04→	1.995	D	M	4	16	1CD-FTV		82022
2.0 D-4D	66	01/02→	1.995	D	M	4	16	1CD-FTV	→06-2004	82022
	66	01/02→	1.995	D	M	4	16	1CD-FTV	07-2004→	82044
	81	01/02→	1.995	D	M	4	16	1CD-FTV		82022
	85	05/03→	1.995	D	M	4	16	1CD-FTV		82022
	85	04/04→	1.995	D	M	4	16	1CD-FTV		82044
2.2 D4d	130	11/06→	2.231	D	M	4	16	2AD-FHV		82071

### COROLLA VIII, STATION WAGON

1.4 D-4D	66	01/09→	1.364	D	M	4	8	1ND-TV	→01-2009	81821
----------	----	--------	-------	---	---	---	---	--------	----------	-------

### MR 2 III

1.8 16V VT-i	103	04/00→	1.794	B	M	4	16	1ZZ-FE		82012
--------------	-----	--------	-------	---	---	---	----	--------	--	-------

### PICNIC I

2.0	90	01/01→12/01	1.998	B	M	4	16	3S-FE	(-)COP	81770
2.0 16V	94	05/96→12/01	1.998	B	M	4	16	3S-FE	(-)COP	81770

### PREVIA II

2.0 D-4D	85	03/01→	1.995	D	M	4	16	1CD-FTV		82022
----------	----	--------	-------	---	---	---	----	---------	--	-------

### PRIUS I

1.5	53	05/00→01/04	1.497	B	A	4	16	1NZ-FXE		81809
-----	----	-------------	-------	---	---	---	----	---------	--	-------

### PRIUS II

1.5	57	08/03→	1.497	B	M	4	16	1NZ-FXE		81809
-----	----	--------	-------	---	---	---	----	---------	--	-------

	kw		Cap. cm3	Fuel	Gear	No. of cyl.	No. of valves	Motor code		Short
--	----	--	----------	------	------	-------------	---------------	------------	--	-------

## TOYOTA

### RAV 4 I

2.0 16V	94	12/97→06/00	1.998	B	M	4	16	3S-FE	(-)COP	81770
	95	06/94→06/00	1.998	B	M	4	16	3S-FE	(-)COP	81770

### RAV 4 II

1.8 VVTi	92	02/01→	1.794	B	M	4	16	1ZZ-FE		82012
2.0 D-4D 4WD	85	09/01→	1.995	D	M	4	16	1CD-FTV		82022

### RAV 4 III

2.2 D-4D	100	03/06→	2.231	D	M	4	16	2AD-FTV		82071
	110	12/08→	2.231	D	M	4	16	2AD-FTV		82071
2.2 D-CAT	130	03/06→	2.231	D	M	4	16	2AD-FHV		82071

### STARLET IV

1.3	55	04/96→03/99	1.332	B	M	4	16	4E-FE	(-)COP	81771
-----	----	-------------	-------	---	---	---	----	-------	--------	-------

### VERSO

2.0 D-4D	93	04/09→	1.998	D	M	4	16	1AD-FTV		82071
2.2 D-4D	110	04/09→	2.231	D	M	4	16	2AD-FHV		82071
2.2 D-CAT	130	04/09→	2.231	D	M	4	16	2AD-FHV		82071

### YARIS I

1.0 16V	48	03/03→	998	B	M	4	16	1SZ-FE	Flange: 3 holes	81808
	48	03/03→	998	B	M	4	16	1SZ-FE	Flange: 4 holes	82048
	50	04/99→	998	B	M	4	16	1SZ-FE	Flange: 3 holes	81808
	50	04/99→	998	B	M	4	16	1SZ-FE	Flange: 4 holes	82048
1.3	64	04/02→	1.298	B	M	4	16	2SZ-FE		81809
1.3 16V	63	11/99→	1.299	B	M	4	16	2NZ-FE		81809
1.4 D-4D	55	12/01→	1.364	D	M	4	8	1ND-TV		81809
1.5 TS	77	01/03→	1.497	B	M	4	16	1NZ-FE		81809
1.5 VVT-i TS	78	04/01→	1.497	B	M	4	16	1NZ-FE		81809
	110	03/03→07/05	1.497	B	M	4	16			81809

### YARIS II

1.0 GPL	51	01/06→	998		M	3	12			82063
1.0 VVT-i	51	01/06→	998	B	M	3	12	1KR-FE		82063
1.3 VVT-i	64	01/06→	1.298	B	M	4	16	2SZ-FE	Flange: 4 holes	82048
1.5	80	11/05→	1.497	B	M	4	16	1NZ-FE		81809
D-4D	66	01/06→	1.364	D	M	4	8	1ND-TV		81821

### YARIS VERSO

1.3	62	11/99→	1.299	B	M	4	16	2NZ-FE		81809
	63	11/99→	1.299	B	M	4	16	2NZ-FE		81809
1.4 D-4D	55	12/01→	1.364	D	M	4	8	1ND-TV		81809
1.5	77	05/03→	1.497	B	M	4	16	1NZ-FE		81809
	78	03/00→	1.497	B	M	4	16	1NZ-FE		81809

## VOLKSWAGEN

### BORA, STATION WAGON

1.4 16V	55	03/00→05/05	1.390	B	M	4	16	AHW, AKQ, APE, AXP, BCA	04-1998→	81777
1.6	74	10/98→05/05	1.595	B	M	4	8	AEH, AKL, APF		81702
	75	08/00→05/05	1.595	B	A	4	8	AVU, BFQ, BJH		81702
	78	06/02→10/04	1.595	B	M	4	8	AWB		81702



	kW		Cap. cm3	Fuel	Gear	No. of cyl.	No. of valves	Motor code		Short
--	----	--	----------	------	------	-------------	---------------	------------	--	-------

## VOLKSWAGEN

### BORA, STATION WAGON

1.6 16V	77	02/00→05/05	1.598	B	M	4	16	ATN, AUS, AZD, BCB		81840
1.6 FSI	81	01/02→05/05	1.598	B	M	4	16	BAD		81840
1.8	92	10/98→05/05	1.781	B	M	4	20	AGN, BAF		81703
	110	05/00→05/05	1.781	B	M	4	20	AGU, ARX, AUM		81703
1.8 4motion	92	02/99→05/05	1.781	B	M	4	20	AGN		81703
	110	10/00→05/01	1.781	B	M	4	20	ARX		81703
1.8 T	110	05/00→05/05	1.781	B	M	4	20	AGU, ARX, AUM, BAE		81703
	132	03/02→05/05	1.781	B	M	4	20	AUQ		81703
1.9 SDI	50	10/98→05/05	1.896	D	M	4	8	AGP, AQM		81706
1.9 TDI	66	10/98→06/01	1.896	D	M	4	8	AGR, ALH		81706
	74	09/00→05/05	1.896	D	M	4	8	ATD, AXR		81816
	81	10/98→06/01	1.896	D	M	4	8	AHF, ASV		81706
	85	12/98→06/01	1.896	D	M	4	8	AJM, AUY		81816
	96	11/00→05/05	1.896	D	M	4	8	ASZ		81816
	110	05/00→05/05	1.896	D	M	4	8	ARL		81816
1.9 TDI 4motion	66	02/99→06/01	1.896	D	M	4	8	AGR		81706
	74	09/00→05/05	1.896	D	M	4	8	ATD		81816
	85	02/99→06/01	1.896	D	M	4	8	AJM, AUY		81816
	96	11/00→05/05	1.896	D	M	4	8	ASZ		81816
	110	05/00→05/05	1.896	D	M	4	8	ARL		81816
2.0	85	10/98→05/05	1.984	B	M	4	8	APK, AQY, AZG, AZH, AZJ		81703
2.0 4motion	85	04/00→05/05	1.984	B	M	4	8	AZH, AZJ		81703
2.3 V5	110	10/98→10/00	2.324	B	M	5	10	AGZ	08-1998→	81856
	125	10/00→05/05	2.324	B	M	5	20	AQN		81856
2.3 V5 4motion	110	12/98→10/00	2.324	B	M	5	10	AGZ	08-1998→	81856
	125	10/00→05/05	2.324	B	M	5	20	AQN		81856
2.8 V6 4motion	150	03/99→05/05	2.792	B	M	6	24	AQP, AUE, BDE	M: AUE, M: AQP	81773
	150	03/99→05/05	2.792	B	M	6	24	AQP, AUE, BDE	M: BDE	81866

### CADDY I

1.5	51	08/82→07/83	1.457	B	M	4	8	JB	(-)COP	81522
	51	08/82→07/83	1.457	B	M	4	8	JB	(+)COP, CR	82080
1.6	55	10/82→10/83	1.588	B	M	4	8	EM	(-)COP	81522
	55	10/82→10/83	1.588	B	M	4	8	EM	(+)COP, CR	82080
	55	01/83→07/92	1.595	B	M	4	8	EW	(-)COP	81522
	55	01/83→07/92	1.595	B	M	4	8	EW	(+)COP, CR	82080
1.6 D	40	08/82→07/92	1.588	D	M	4	8	JK, ME	(-)COP	81522
	40	08/82→07/92	1.588	D	M	4	8	JK, ME	(+)COP, CR	82080
1.8	70	08/85→07/92	1.781	B	M	4	8	JH	(-)COP	81522
	70	08/85→07/92	1.781	B	M	4	8	JH	(+)COP, CR	82080

### CADDY II

1.4	44	11/95→01/04	1.390	B	M	4	8	AEX, AKV, APQ, AUD		81527
	55	08/00→01/04	1.390	B	M	4	16	AUA		81777
1.4 16V	55	08/00→01/04	1.390	B	M	4	16	AUA		81777
1.6	55	11/95→05/97	1.595	B	M	4	8	1F	(-)COP	81522
	55	11/95→05/97	1.595	B	M	4	8	1F	(+)COP, CR	82080
	55	06/96→12/00	1.598	B	M	4	8	AEE		81527

	kW		Cap. cm3	Fuel	Gear	No. of cyl.	No. of valves	Motor code		Short
--	----	--	----------	------	------	-------------	---------------	------------	--	-------

## VOLKSWAGEN

### CADDY II

1.7 SDI	42	07/96→09/00	1.716	D	M	4	8	AHB	(-)COP	81522
	42	07/96→09/00	1.716	D	M	4	8	AHB	(+)COP, CR	82080
1.9 D	47	11/95→01/04	1.896	D	M	4	8	1Y	(-)COP	81522
	47	06/96→12/00	1.896	D	M	4	8	AEF		81528
	47	11/95→01/04	1.896	D	M	4	8	1Y	(+)COP, CR	82080
1.9 SDI	47	11/95→01/04	1.896	D	M	4	8	AEY, AYQ	(-)COP, M: AEY	81522
	47	11/95→01/04	1.896	D	M	4	8	AEY, AYQ	M: AYQ	81706
	47	11/95→01/04	1.896	D	M	4	8	AEY, AYQ	(+)COP, CR	82080
1.9 TDI	66	09/96→01/04	1.896	D	M	4	8	1Z, AHU, ALE, ALH	(-)COP	81522
	66	09/96→01/04	1.896	D	M	4	8	1Z, AHU, ALE, ALH	(+)COP, CR	82080
60 1.4	44	11/95→01/04	1.390	B	M	4	8	AEX, APQ, AUD		81527
75 1.6	55	11/95→05/97	1.595	B	M	4	8	1F	(-)COP	81522
	55	11/95→05/97	1.595	B	M	4	8	1F	(+)COP, CR	82080
	55	11/95→09/00	1.598	B	M	4	8	AEE		81527

### CADDY III

1.4	55	03/04→	1.390	B	M	4	16	BCA		81777
1.4 16V	59	05/06→	1.390	B	M	4	16	BUD		81777
1.6	74	03/05→	1.595	B	M	4	8	BRY		81702
	75	04/04→	1.595	B	M	4	8	BGU		81702
1.6 TDI	55	08/10→	1.598	D	M	4	16	CAYE		83000
	75	08/10→	1.598	D	M	4	16	CAYD		83000
1.9 TDI	55	09/05→	1.896	D	M	4	8	BSU		81791
	77	04/04→	1.896	D	M	4	8	BJB		81791
1.9 TDI 4motion	77	05/08→	1.896	D	M	4	8	BLS		81791
2.0 EcoFuel	80	04/06→	1.984	M	M	4	16	BSX		81703
2.0 SDI	51	03/04→	1.968	D	M	4	8	BDJ		81791
2.0 TDI	103	09/07→	1.968	D	M	4	8	BMM		81816
2.0 TDI 16V	103	11/10→	1.968	D	M	4	16	CFHC		83000
2.0 TDI 4motion	81	10/10→	1.968	D	M	4	16	CFHF		83000

### CORRADO

1.8 16V	100	04/89→07/92	1.781	B	M	4	16	KR	(-)COP	81522
	100	04/89→07/92	1.781	B	M	4	16	KR	(+)COP, CR	82080
1.8 G60	118	09/88→09/93	1.781	B	M	4	8	PG	(-)COP	81522
	118	09/88→09/93	1.781	B	M	4	8	PG	(+)COP, CR	82080
2.0 i	85	04/93→12/95	1.984	B	M	4	8	2E, ADY	(-)COP	81522
	85	04/93→12/95	1.984	B	M	4	8	2E, ADY	(+)COP, CR	82080
2.0 i 16V	100	08/91→12/95	1.984	B	M	4	16	9A	(-)COP	81522
	100	08/91→12/95	1.984	B	M	4	16	9A	(+)COP, CR	82080
2.9 VR6	140	08/91→12/95	2.861	B	M	6	12	ABV		81773

### CRAFTER

2.5 TDI	65	04/06→	2.461	D	M	5	10	BJJ		81791
---------	----	--------	-------	---	---	---	----	-----	--	-------

### EOS

1.4 TSI	118	05/08→	1.390	B	M	4	16	CAVD		82097
1.6 FSI	85	06/06→	1.598	B	M	4	16	BLF		81865
2.0 FSI	110	03/06→	1.984	B	M	4	16	BVY		81702
2.0 TDI	103	06/06→05/08	1.968	D	M	4	8	BMM		81816

	kw		Cap. cm3	Fuel	Gear	No. of cyl.	No. of valves	Motor code		Short
--	----	--	----------	------	------	-------------	---------------	------------	--	-------

## VOLKSWAGEN

### EOS

2.0 TDI 16V	103	05/08→	1.968	D	M	4	16	CBAB		81816
2.0 TFSI	147	03/06→	1.984	B	M	4	16	BWA		82025
2.0 TSI	155	11/09→	1.984	B	M	4	16	CCZB		82096
3.2 V6	184	06/06→	3.189	B	M	6	24	BUB		81866
3.6 V6	191	05/09→	3.597	B	M	6	24	CDVA		81866

### FOX

1.2	40	04/05→	1.198	B	M	3	6	BMD		81867
1.4	55	04/05→	1.390	B	M	4	16	BKR		81527
1.4 TDI	51	04/05→	1.422	D	M	3	6	BNM		81791
1.6	74	10/03→	1.598	B	M	4	8	BAH		81527
	74	10/05→	1.599	B	M	4	8	BAH, BLH, BPA, CCRA		81527
1.6 Alcohol	76	10/03→	1.598	B	M	4	8			81527
1.6 Total Flex	74	10/03→	1.598	FF	M	4	8	BJA, BPA, CCRA		81527
1.9 D	47	12/07→	1.896	D	M	4	8	ASY		82013

### GOLF I, CABRIO

1.1	37	04/74→07/83	1.093	B	M	4	8	FA, GG		81520
	38	01/81→07/83	1.093	B	M	4	8	FJ		81520
	44	01/81→07/83	1.093	B	M	4	8	HC		81520
1.3	43	08/82→12/83	1.272	B	M	4	8	GS		81520
	44	08/79→07/83	1.272	B	M	4	8	GF		81520
1.5	51	08/77→11/83	1.457	B	M	4	8	JB	(-)COP, →07-1980	81521
	51	08/77→11/83	1.457	B	M	4	8	JB	(-)COP, 08-1980→	81522
	51	08/77→11/83	1.457	B	M	4	8	JB	(+)COP, →07-1980	82001
	51	08/77→11/83	1.457	B	M	4	8	JB	(+)COP, CR	82080
	51	04/74→12/75	1.471	B	M	4	8	FH	(-)COP	81521
	51	04/74→12/75	1.471	B	M	4	8	FH	(+)COP	82001
1.5 D	37	08/76→07/80	1.471	D	M	4	8	CK	(-)COP	81521
	37	08/76→07/80	1.471	D	M	4	8	CK	(+)COP	82001
1.6	51	08/75→07/77	1.588	B	M	4	8	FT	(-)COP	81521
	51	08/75→07/77	1.588	B	M	4	8	FT	(+)COP	82001
	53	04/86→02/90	1.595	B	M	4	8	RE	(-)COP	81522
	53	04/86→02/90	1.595	B	M	4	8	RE	(+)COP, CR	82080
	55	08/75→02/84	1.588	B	M	4	8	EM, FN, FP	(-)COP, →07-1980	81521
	55	08/75→02/84	1.588	B	M	4	8	EM, FN, FP	(-)COP, 08-1980→	81522
	55	08/75→02/84	1.588	B	M	4	8	EM, FN, FP	(+)COP, →07-1980	82001
	55	08/75→02/84	1.588	B	M	4	8	EM, FN, FP	(+)COP, CR	82080
	55	01/83→04/92	1.595	B	M	4	8	EW, HN	(-)COP, 08-1980→	81522
	55	01/83→04/92	1.595	B	M	4	8	EW, HN	(+)COP, CR	82080
	81	08/79→07/82	1.588	B	M	4	8	EG	(-)COP, →07-1980	81521
	81	08/79→07/82	1.588	B	M	4	8	EG	(-)COP, 08-1980→	81522
	81	08/79→07/82	1.588	B	M	4	8	EG	(+)COP, →07-1980	82001
81	08/79→07/82	1.588	B	M	4	8	EG	(+)COP, CR	82080	
1.6 D	40	08/80→07/83	1.588	D	M	4	8	CR, JK	(-)COP, →T: 17.C.630.000	81521
	40	08/80→07/83	1.588	D	M	4	8	CR, JK	(-)COP, T→: 17.C.630.001	81522

	kW		Cap. cm3	Fuel	Gear	No. of cyl.	No. of valves	Motor code		Short
--	----	--	----------	------	------	-------------	---------------	------------	--	-------

## VOLKSWAGEN

### GOLF I, CABRIO

1.6 D	40	08/80→07/83	1.588	D	M	4	8	CR, JK	(+)COP, →T: 17.C.630.000	82001
	40	08/80→07/83	1.588	D	M	4	8	CR, JK	(+)COP, CR	82080
1.6 GTI	81	08/76→07/82	1.588	B	M	4	8	EG	(-)COP, →07-1980	81521
	81	08/76→07/82	1.588	B	M	4	8	EG	(-)COP, 08-1980→	81522
	81	08/76→07/82	1.588	B	M	4	8	EG	(+)COP, →07-1980	82001
	81	08/76→07/82	1.588	B	M	4	8	EG	(+)COP, CR	82080
1.6 TD	51	03/82→07/83	1.588	D	M	4	8	CY	(-)COP, →T: 17.C.630.000	81521
	51	03/82→07/83	1.588	D	M	4	8	CY	(-)COP, T→: 17.C.630.001	81522
	51	03/82→07/83	1.588	D	M	4	8	CY	(+)COP, →T: 17.C.630.000	82001
	51	03/82→07/83	1.588	D	M	4	8	CY	(+)COP, CR	82080
1.6 TD CL	55	08/83→07/85	1.588	D	M	4	8		(-)COP, T→: 17.C.630.001	81522
	55	08/83→07/85	1.588	D	M	4	8		(+)COP, CR	82080
1.8	66	08/83→09/92	1.781	B	M	4	8	EX	(-)COP	81522
	66	08/83→09/92	1.781	B	M	4	8	EX	(+)COP, CR	82080
	70	08/83→04/93	1.781	B	M	4	8	JH	(-)COP	81522
	70	08/83→04/93	1.781	B	M	4	8	JH	(+)COP, CR	82080
	72	08/89→03/93	1.781	B	M	4	8	2H	(-)COP	81522
	72	08/89→03/93	1.781	B	M	4	8	2H	(+)COP, CR	82080
	82	08/82→12/89	1.781	B	M	4	8	DX, EV, PB	(-)COP	81522
	82	08/82→12/89	1.781	B	M	4	8	DX, EV, PB	(+)COP, CR	82080
1.8 GTI	82	08/82→12/83	1.781	B	M	4	8	DX, JJ	(-)COP	81522
	82	08/82→12/83	1.781	B	M	4	8	DX, JJ	(+)COP, CR	82080

### GOLF II

1.0	33	11/83→08/85	1.043	B	M	4	8	GN	→M: 786.022	81520
	33	11/83→08/85	1.043	B	M	4	8	GN	M→: 786.023	81524
	37	08/85→10/91	1.043	B	M	4	8	HZ	→M: 786.022	81520
	37	08/85→10/91	1.043	B	M	4	8	HZ	M→: 786.023	81524
1.3	37	08/85→12/87	1.272	B	M	4	8	NU	→M: 200.000	81520
	37	08/85→12/87	1.272	B	M	4	8	NU	M→: 200.001	81524
	40	08/83→06/87	1.272	B	M	4	8	HK, MH	→M: 262.739	81520
	40	08/83→06/87	1.272	B	M	4	8	HK, MH	M→: 262.740	81524
	43	08/83→10/86	1.272	B	M	4	8	GT	→M: 200.000	81520
	43	08/83→10/86	1.272	B	M	4	8	GT	M→: 200.001	81524
1.3 Cat.	40	06/86→12/92	1.272	B	M	4	8	2G, MH, NZ	→M: 262.739	81520
	40	06/86→12/92	1.272	B	M	4	8	2G, MH, NZ	M→: 262.740	81524
1.6	51	10/86→12/92	1.595	B	M	4	8	PN	(-)COP	81522
	51	10/86→12/92	1.595	B	M	4	8	PN	(+)COP, CR	82080
	53	02/86→10/91	1.595	B	M	4	8	RF	(-)COP	81522
	53	02/86→10/91	1.595	B	M	4	8	RF	(+)COP, CR	82080
	55	08/83→07/92	1.595	B	M	4	8	ABN, EZ, HM	(-)COP	81522
	55	08/83→07/92	1.595	B	M	4	8	ABN, EZ, HM	(+)COP, CR	82080

	kW		Cap. cm3	Fuel	Gear	No. of cyl.	No. of valves	Motor code		Short
--	----	--	----------	------	------	-------------	---------------	------------	--	-------

## VOLKSWAGEN

### GOLF II

1.6 D	37	08/83→10/91	1.588	D	M	4	8		(-)COP	81522
	37	08/83→10/91	1.588	D	M	4	8		(+)COP, CR	82080
	40	08/83→10/91	1.588	D	M	4	8	JP, ME	(-)COP	81522
	40	08/83→10/91	1.588	D	M	4	8	JP, ME	(+)COP, CR	82080
1.6 TD	44	08/89→10/91	1.589	D	M	4	8	1V	(-)COP	81522
	44	08/89→10/91	1.589	D	M	4	8	1V	(+)COP, CR	82080
	51	08/83→10/91	1.588	D	M	4	8	JR, MF	(-)COP	81522
	51	08/83→10/91	1.588	D	M	4	8	JR, MF	(+)COP, CR	82080
	59	04/89→10/91	1.588	D	M	4	8	RA, SB	(-)COP	81522
	59	04/89→10/91	1.588	D	M	4	8	RA, SB	(+)COP, CR	82080
1.6 TD CL	55	08/83→07/85	1.588	D	M	4	8		(-)COP	81522
	55	08/83→07/85	1.588	D	M	4	8		(+)COP, CR	82080
1.8	62	08/86→01/90	1.781	B	M	4	8	RH	(-)COP	81522
	62	08/86→01/90	1.781	B	M	4	8	RH	(+)COP, CR	82080
	66	08/84→10/91	1.781	B	M	4	8	GU, GX, HV	(-)COP	81522
	66	08/84→10/91	1.781	B	M	4	8	GU, GX, HV	(+)COP, CR	82080
1.8 GTI	77	01/85→07/85	1.781	B	M	4	8	HT	(-)COP	81522
	77	01/85→07/85	1.781	B	M	4	8	HT	(+)COP, CR	82080
	79	08/85→10/87	1.781	B	M	4	8	RD	(-)COP	81522
	79	08/85→10/87	1.781	B	M	4	8	RD	(+)COP, CR	82080
	82	08/83→10/91	1.781	B	M	4	8	DX, EV, GZ, PB	(-)COP	81522
	82	08/83→10/91	1.781	B	M	4	8	DX, EV, GZ, PB	(+)COP, CR	82080
1.8 GTI 16V	95	02/86→10/91	1.781	B	M	4	16	PL	(-)COP	81522
	95	02/86→10/91	1.781	B	M	4	16	PL	(+)COP, CR	82080
	102	02/86→06/90	1.781	B	M	4	16	KR	(-)COP	81522
	102	02/86→06/90	1.781	B	M	4	16	KR	(+)COP, CR	82080
1.8 GTI Cat.	79	01/87→10/91	1.781	B	M	4	8	PF	(-)COP	81522
	79	01/87→10/91	1.781	B	M	4	8	PF	(+)COP, CR	82080
1.8 GTI G60	118	04/90→07/91	1.781	B	M	4	8	PG	(-)COP	81522
	118	04/90→07/91	1.781	B	M	4	8	PG	(+)COP, CR	82080
1.8 GTI G60 Syncro	118	08/88→07/91	1.781	B	M	4	8	1H, PG	(-)COP	81522
	118	08/88→07/91	1.781	B	M	4	8	1H, PG	(+)COP, CR	82080
1.8 i Cat.	66	08/87→10/91	1.781	B	M	4	8	GX, RP	(-)COP	81522
	66	08/87→10/91	1.781	B	M	4	8	GX, RP	(+)COP, CR	82080
1.8 i Syncro Cat.	66	08/87→10/91	1.781	B	M	4	8	RP	(-)COP	81522
	66	08/87→10/91	1.781	B	M	4	8	RP	(+)COP, CR	82080
1.8 Syncro	66	02/86→07/91	1.781	B	M	4	8	GU, GX	(-)COP	81522
	66	02/86→07/91	1.781	B	M	4	8	GU, GX	(+)COP, CR	82080
	72	08/88→07/91	1.781	B	M	4	8	1P	(-)COP	81522
	72	08/88→07/91	1.781	B	M	4	8	1P	(+)COP, CR	82080
2.0	57	08/85→07/92	1.968	B	M	4	8		(-)COP	81522
	57	08/85→07/92	1.968	B	M	4	8		(+)COP, CR	82080

	kw		Cap. cm3	Fuel	Gear	No. of cyl.	No. of valves	Motor code		Short
--	----	--	----------	------	------	-------------	---------------	------------	--	-------

## VOLKSWAGEN

### GOLF III, CABRIO, VARIANT

1.3 CL	40	08/91→07/92	1.272	B	M	4	8	2G		81524
1.4	40	11/91→04/99	1.390	B	M	4	8	ABD, AEX	11-1991→, →07-1995, M: ABD	81524
	40	11/91→04/99	1.390	B	M	4	8	ABD, AEX	08-1995→, M: AEX	81527
	44	10/91→04/99	1.390	B	M	4	8	ABD, AEX, APQ	→07-1995, M: ABD	81524
	44	10/91→04/99	1.390	B	M	4	8	ABD, AEX, APQ	08-1995→, M: AEX	81527
1.6	55	09/92→12/97	1.598	B	M	4	8	ABU, AEA, AEE	→07-1995, M: ABU	81524
	55	09/92→12/97	1.598	B	M	4	8	ABU, AEA, AEE	06-1995→, 05-1996→, M: AEE, M: AEA, M: AEE	81527
	74	07/94→04/99	1.595	B	M	4	8	AEK, AFT, AKS	(-)COP, 05-1996→	81522
	74	07/94→04/99	1.595	B	M	4	8	AEK, AFT, AKS	(+)COP, CR	82080
1.8	55	11/91→04/99	1.781	B	M	4	8	AAM, ANN	(-)COP	81522
	55	11/91→04/99	1.781	B	M	4	8	AAM, ANN	(+)COP, CR	82080
	66	11/91→04/99	1.781	B	M	4	8	ABS, ACC, ADZ, ANP	(-)COP	81522
	66	11/91→04/99	1.781	B	M	4	8	ABS, ACC, ADZ, ANP	(+)COP, CR	82080
1.8 Syncro	66	01/93→04/99	1.781	B	M	4	8	ABS, ADZ	(-)COP	81522
	66	01/93→04/99	1.781	B	M	4	8	ABS, ADZ	(+)COP, CR	82080
1.9 D	48	11/91→04/99	1.896	D	M	4	8	1Y	(-)COP, →07-1995	81522
	48	11/91→04/99	1.896	D	M	4	8	1Y	08-1995→, →04-1996	81528
	48	11/91→04/99	1.896	D	M	4	8	1Y	(+)COP, CR	82080
1.9 SDI	47	07/95→08/97	1.896	D	M	4	8	AEY	(-)COP	81522
	47	07/95→04/99	1.896	D	M	4	8	AEY		81528
	47	07/95→08/97	1.896	D	M	4	8	AEY	(+)COP, CR	82080
1.9 TD	55	07/93→04/99	1.896	D	M	4	8	AAZ	(-)COP, →07-1995	81522
	55	07/93→04/99	1.896	D	M	4	8	AAZ	08-1995→, →12-1997	81528
	55	07/93→04/99	1.896	D	M	4	8	AAZ	(+)COP, CR	82080
1.9 TD,GTD	55	11/91→08/97	1.896	D	M	4	8	AAZ	(-)COP, →07-1995	81522
	55	11/91→08/97	1.896	D	M	4	8	AAZ	08-1995→	81528
	55	11/91→08/97	1.896	D	M	4	8	AAZ	(+)COP, CR	82080
1.9 TDI	66	09/93→04/99	1.896	D	M	4	8	1Z, AHU, ALE	(-)COP, →07-1995, M: 1Z	81522
	66	09/93→04/99	1.896	D	M	4	8	1Z, AHU, ALE	07-1995→, 08-1995→, →12-1997, M: AHU	81528
	66	09/93→04/99	1.896	D	M	4	8	1Z, AHU, ALE	(+)COP, CR	82080
	81	04/96→04/99	1.896	D	M	4	8	AFN	(-)COP	81522
	81	04/96→04/99	1.896	D	M	4	8	AFN	(+)COP, CR	82080
1.9 TDI Syncro	66	07/95→04/99	1.896	D	M	4	8	1Z, AHU	(-)COP, →07-1995	81522
	66	07/95→04/99	1.896	D	M	4	8	1Z, AHU, ALE	08-1995→	81528
	66	07/95→04/99	1.896	D	M	4	8	1Z, AHU	(+)COP, CR	82080
2.0	85	11/91→04/99	1.984	B	M	4	8	2E, ADY, AGG, AKR	(-)COP, 08-1991→	81522
	85	11/91→04/99	1.984	B	M	4	8	2E, ADY, AGG, AKR	(+)COP, CR	82080
2.0 GTI 16V	110	08/92→08/97	1.984	B	M	4	16	ABF	(-)COP, 08-1991→	81522
	110	08/92→08/97	1.984	B	M	4	16	ABF	(+)COP, CR	82080
2.0 Syncro	85	08/95→04/99	1.984	B	M	4	8	AGG	(-)COP, 08-1991→	81522
	85	08/95→04/99	1.984	B	M	4	8	AGG	(+)COP, CR	82080

	kW		Cap. cm3	Fuel	Gear	No. of cyl.	No. of valves	Motor code		Short
--	----	--	----------	------	------	-------------	---------------	------------	--	-------

## VOLKSWAGEN

### GOLF III, CABRIO, VARIANT

2.8 VR6	128	01/92→08/97	2.792	B	M	6	12	AAA		81773
2.9 VR6	140	10/94→04/99	2.861	B	M	6	12	ABV		81773
2.9 VR6 Syncro	140	10/94→04/99	2.861	B	M	6	12	ABV	01-1993→	81773

### GOLF IV, CABRIO, VARIANT

1.4 16V	55	08/97→06/06	1.390	B	M	4	16	AHW, AKQ, APE, AXP, BCA	01-1997→	81777
1.6	68	12/98→05/02	1.595	B	M	4	8			81702
	74	06/98→06/02	1.595	B	M	4	8	AFT, AKS	(-)COP, 05-1996→	81522
	74	08/97→02/00	1.595	B	M	4	8	AEH, AKL, APF		81702
	74	06/98→06/02	1.595	B	M	4	8	AFT, AKS	(+)COP, CR	82080
	74	02/01→06/01	1.598	B	M	4	8	BAH		81702
	75	08/00→06/06	1.595	B	A	4	8	AVU, BFQ, BJH		81702
1.6 16V	77	02/00→06/06	1.598	B	M	4	16	ATN, AUS, AZD, BCB		81840
	78	08/03→06/05	1.595	B	M	4	8	AWB		81840
1.6 FSI	81	01/02→06/06	1.598	B	M	4	16	BAD	→09-2003	81840
1.8	55	06/98→06/02	1.781	B	M	4	8	AAM, ANN	(-)COP, 11-1991→	81522
	55	06/98→06/02	1.781	B	M	4	8	AAM, ANN	(+)COP, CR	82080
	66	06/98→06/02	1.781	B	M	4	8	ADZ, ANP	(-)COP, 11-1991→	81522
	66	06/98→06/02	1.781	B	M	4	8	ADZ, ANP	(+)COP, CR	82080
	92	08/97→06/05	1.781	B	M	4	20	AGN, BAF	10-1997→	81703
1.8 4motion	92	05/98→06/06	1.781	B	M	4	20	AGN		81703
1.8 T	110	08/97→06/06	1.781	B	M	4	20	AGU, ARZ, AUM	10-1997→	81703
1.8 T GTI	132	08/01→06/05	1.781	B	M	4	20	AUQ		81703
1.9 SDI	50	08/97→06/06	1.896	D	M	4	8	AGP, AQM	M: AQM, M: AGP	81706
1.9 TDI	66	06/98→06/02	1.896	D	M	4	8	AHU, ALE	(-)COP	81522
	66	10/97→05/06	1.896	D	M	4	8	AGR, ALH	M: ALH, M: AGR	81706
	66	06/98→06/02	1.896	D	M	4	8	AHU, ALE	(+)COP, CR	82080
	74	09/00→06/06	1.896	D	M	4	8	ATD, AXR		81816
	81	06/98→06/02	1.896	D	M	4	8	AFN, AVG	(-)COP	81522
	81	08/97→05/04	1.896	D	M	4	8	AHF, ASV	M: AHF, M: ASV, M: ASF, M: AHF	81706
	81	06/98→06/02	1.896	D	M	4	8	AFN, AVG	(+)COP, CR	82080
	85	12/98→06/01	1.896	D	AM	4	8	AJM, AUY		81816
	96	11/00→06/06	1.896	D	M	4	8	ASZ		81816
	110	05/00→06/05	1.896	D	M	4	8	ARL	M: ARL	81816
	1.9 TDI 4motion	66	07/98→04/02	1.896	D	M	4	8	AGR, ALH	M: ALH, M: AGR
74		09/00→06/06	1.896	D	M	4	8	ATD		81816
85		05/99→06/01	1.896	D	M	4	8	AJM, AUY		81816
96		11/00→06/06	1.896	D	M	4	8	ASZ		81816
110		02/00→06/05	1.896	D	M	4	8	ARL	M: ARL	81816
1.9 TDi GTi	110	06/01→06/06	1.896	D	M	4	8	ARL		81816
2.0	85	06/98→06/02	1.984	B	M	4	8	AGG, AKR, ATU, AWF, AWG	(-)COP, 08-1991→	81522
	85	07/98→06/06	1.984	B	M	4	8	APK, AQY, AZG, AZJ		81703
	85	06/98→06/02	1.984	B	M	4	8	AGG, AKR, ATU, AWF, AWG	(+)COP, CR	82080
2.0 4motion	85	10/00→06/06	1.984	B	M	4	8	AZH, AZJ		81703
2.0 Bi-Fuel	85	02/02→06/06	1.984	BF	M	4	8	BEH		81703

	kw		Cap. cm3	Fuel	Gear	No. of cyl.	No. of valves	Motor code		Short
--	----	--	----------	------	------	-------------	---------------	------------	--	-------

## VOLKSWAGEN

### GOLF IV, CABRIO, VARIANT

2.3 V5	110	08/97→06/06	2.324	B	M	5	10	AGZ		81856
	125	10/00→06/06	2.324	B	M	5	20	AQN		81856
2.3 V5 4motion	110	12/98→06/06	2.324	B	M	5	10	AGZ		81856
	125	10/00→06/06	2.324	B	M	5	20	AQN		81856
2.8 V6 4motion	150	03/99→06/06	2.792	B	M	6	24	AQP, AUE, BDE		81773
3.2 R32 4motion	177	09/02→06/05	3.189	B	M	6	24	BFH		81866

### GOLF V, PLUS, VARIANT

1.4	59	06/07→	1.390	B	M	4	16	BUD		81777
1.4 16V	55	10/03→	1.390	B	M	4	16	BCA		81777
	59	01/05→	1.390	B	M	4	16	BUD		81777
1.4 FSI	66	10/03→05/06	1.390	B	M	4	16	BKG, BLN		81865
1.4 TSI	90	05/07→	1.390	B	M	4	16	CAXA		82097
1.6	67	08/05→	1.595	B	M	4	8			81702
	75	01/04→	1.595	B	M	4	8	BGU, BSE, BSF		81702
1.6 BiFuel	75	05/09→	1.595	BF	M	4	8	CHGA		81702
1.6 FSI	74	02/06→	1.598		M	4	8			81865
	85	10/03→	1.598	B	M	4	16	BAG, BLF		81865
1.6 Multifuel	75	10/07→	1.595	FF	M	4	8	CCSA		81702
1.6 TDI	66	02/09→	1.598	D	M	4	16	CAYB		83000
	77	03/09→	1.598	D	M	4	16	CAYC		83000
1.9 SDi	47	12/05→	1.896	D	M	4	8	BGG		82013
1.9 TDI	66	05/04→	1.896	D	M	4	8	BRU, BXF		81791
	77	10/03→	1.896	D	M	4	8	BKC, BLS, BXE		81791
1.9 TDI 4motion	77	08/04→	1.896	D	M	4	8	BKC, BLS, BXE		81791
2.0	147	06/07→	1.984	B	M	4	16	BWA		82025
2.0 D	55	01/04→	1.968	D	M	4	16			81816
2.0 FSI	110	01/04→	1.984	B	M	4	16	AXW, BLR, BLX, BLY, BVX, BZY, BVZ		81702
2.0 FSI 4motion	110	08/04→	1.984	B	M	4	16	BLX, BLY, BVX, BZY, BVZ		81702
2.0 GTD	125	11/05→	1.968	D	M	4	16	BMN		81816
2.0 GTI	147	10/04→	1.984	B	M	4	16	AXX, BPY, BWA		82025
	169	09/06→	1.984	B	M	4	16	BYD		82025
2.0 SDI	55	01/04→	1.968	D	M	4	8	BDK		81791
2.0 TDI	81	03/09→	1.968	D	M	4	16	CBDC		81816
	100	10/03→	1.968	D	M	4	16	AZV		81816
	103	12/04→	1.968	D	M	4	8	BMM		81816
2.0 TDI 16V	103	10/03→	1.968	D	M	4	16	BKD		81816
2.0 TDI 16V 4motion	103	08/04→	1.968	D	M	4	16	BKD		81816
2.0 TDI 4motion	100	06/07→	1.968	D	M	4	16	AZV		81816
	103	08/04→	1.968	D	M	4	8	BMM		81816
2.0 TDi PF Sportline	96	11/05→	1.968	D	M	4	16	BVB		81816
2.5 TDi	120	10/03→02/06	2.496	D	M	6	24	BDG		81705
3.2	184	09/05→	3.189	B	M	6	24	BUB		81866
3.2 Fsi	184	09/05→	3.189	B	M	6	24	BUB		81866
3.2 R32 4motion	177	01/04→	3.189	B	M	6	24			81866
	184	11/05→	3.189	B	M	6	24	BUB		81866



	kw		Cap. cm3	Fuel	Gear	No. of cyl.	No. of valves	Motor code		MAGNETI MARELLI Short
--	----	--	----------	------	------	-------------	---------------	------------	--	-----------------------

## VOLKSWAGEN

### GOLF VI, VARIANT

1.4	59	10/08→	1.390	B	M	4	16	BUD, CGGA		81777
1.4 TSI	90	10/08→	1.390	B	M	4	16	CAXA		82097
1.6	75	10/08→	1.595	B	M	4	8	BSE, BSF, CCSA		81702
1.6 BiFuel	75	03/09→	1.595	BF	M	4	8	CHGA		81702
1.6 MultiFuel	75	10/08→	1.595	FF	M	4	8	CCSA		81702
1.6 TDI	66	02/09→	1.598	D	M	4	16	CAYB		83000
	77	02/09→	1.598	D	M	4	16	CAYC		83000
1.6 TDI 4motion	77	07/09→	1.598	D	M	4	16	CAYC		83000
1.8 TSI	118	06/09→	1.798	B	M	4	16	CDAA		82096
2.0 R 4motion	188	11/09→	1.984	B	M	4	16	CDLC		82025
	199	11/09→	1.984	B	M	4	16	CDLF		82025
2.0 TDI	81	10/08→	1.968	D	M	4	16	CBDC		81816
	100	10/08→	1.968	D	M	4	16	CBAA, CFFA		81816
	103	07/09→	1.968	D	M	4	8	BMM		81816
	103	10/08→	1.968	D	M	4	16	CBAB, CBDB		81816
	125	04/09→	1.968	D	M	4	16	CBBB		81816
2.0 TDI 4motion	103	05/09→	1.968	D	M	4	16	CBAB, CFFB		81816
2.0 TSI	147	07/09→	1.984	B	M	4	16	CBFA, CCTA		82096
	155	04/09→	1.984	B	M	4	16	CCZB		82096

### JETTA III

1.4 TSI	90	05/07→	1.390	B	M	4	16	CAXA		82097
1.6	75	10/05→	1.595	B	M	4	8	BSE, BSF		81702
1.6 FSI	85	09/05→	1.598	B	M	4	16	BLF		81865
1.6 MultiFuel	75	01/08→	1.595	FF	M	4	8	CCSA		81702
1.6 TDI	77	06/09→	1.598	D	M	4	16	CAYC		83000
1.9 TDI	77	08/05→	1.896	D	M	4	8	BKC, BLS		81791
2.0	147	08/05→06/08	1.984	B	M	4	16	BPY		82025
2.0 FSI	110	08/05→	1.984	B	M	4	16	BLR, BLY, BVY, BVZ		81702
2.0 TDI	100	09/05→	1.968	D	M	4	16	AZV		81816
	103	10/05→	1.968	D	M	4	8	BMM		81816
	125	10/06→	1.968	D	M	4	16	BMN		81816
2.0 TDI 16V	103	08/05→	1.968	D	M	4	16	CBDB		81816
2.0 TFSI	147	10/05→	1.984	B	M	4	16	BPY, BWA		82025

### LT I

2.0	55	04/75→09/83	1.984	B	M	4	8	CH	BC	81831
2.4	66	12/82→07/92	2.383	B	M	6	12	DL		81833
2.4 4WD	66	12/82→07/92	2.383	B	M	6	12	DL		81833
2.4 D	51	08/89→06/96	2.383	D	M	6	12	1S, ACT		81593
	55	12/78→07/92	2.383	D	M	6	12	CP, DW		81593
2.4 D 4WD	55	01/79→03/86	2.383	D	M	6	12	DW		81593
2.4 i	69	08/89→06/96	2.383	B	M	6	12	1E		81833
2.4 TD	68	08/88→08/92	2.383	D	M	6	12	1G		81593
	70	06/92→06/96	2.383	D	M	6	12	ACL		81701
	75	12/82→09/93	2.383	D	M	6	12	DV		81593
2.4 TD 4WD	75	08/78→03/86	2.383	D	M	6	12	DV		81593
2.7 D	48	11/75→01/80	2.710	D	M	4	8	CG	BC	81831

	kW		Cap. cm3	Fuel	Gear	No. of cyl.	No. of valves	Motor code		Short
--	----	--	----------	------	------	-------------	---------------	------------	--	-------

## VOLKSWAGEN

### LT II

2.3	105	05/96→07/06	2.295	B	M	4	16	AGL		81774
2.5 SDI	55	07/96→07/06	2.461	D	M	5	10	AGX		81701
2.5 TDI	61	05/01→07/06	2.461	D	M	5	10	BBE		81701
	66	05/99→07/06	2.461	D	M	5	10	APA		81701
	70	05/01→07/06	2.461	D	M	5	10	BBF		81701
	75	05/96→08/99	2.461	D	M	5	10	AHD		81701
	80	05/99→07/06	2.461	D	M	5	10	ANJ, AVR		81701

### LUPU

1.0	37	09/98→07/05	999	B	M	4	8	AER, ALD, ALL, ANV, AUC	M: ALD, M: AUD, M: AUC, M: ALD, M: AER, M: AUC, M: ALL, M: AER, M: AUD, M: AUC, M: ANV, M: ALL, M: ALD, M: AER	81775
	37	09/98→07/05	999	B	M	4	8	AER, ALD, ALL, ANV, AUC	M: AHT	81807
1.2 TDI 3L	45	07/99→07/05	1.191	D	M	3	6	ANY, AYZ		81791
1.4	44	10/00→07/05	1.390	B	M	4	8	AUD		81775
1.4 16V	55	09/98→07/05	1.390	B	M	4	16	AHW, AKQ, APE, AUA, BBY	11-1998→	81777
	74	08/99→07/05	1.390	B	M	4	16	AFK, ANM, AQQ, AUB		81777
1.4 FSI	77	02/01→07/05	1.390	B	M	4	16	ARR		81777
1.4 TDI	55	01/99→07/05	1.422	D	M	3	6	AMF		81791
1.6 GTI	92	09/00→07/05	1.598	B	M	4	16	AVY		81840
1.7 SDI	44	09/98→07/05	1.716	D	M	4	8	AKU	11-1998→	81528

### MULTIVAN

1.9 TDI	77	04/03→	1.896	D	M	4	8	AXB		81791
2.0	85	11/03→	1.984	B	M	4	8	AXA		81703
2.5 TDI	96	04/03→	2.461	D	M	5	10	AXD		82033
	128	04/03→	2.461	D	M	5	10	AXE		82033
2.5 TDI 4motion	96	07/04→	2.461	D	M	5	10	AXD		82033
	128	07/04→	2.461	D	M	5	10	AXE		82033
3.2 4motion	170	11/03→06/06	3.189	B	M	6	24	BDL		81866
3.2 V6	170	02/04→06/04	3.189	B	M	6	24	BDL		81866
	173	02/04→	3.189	B	M	6	24	BKK		81866
3.2 V6 4motion	173	07/04→	3.189	B	M	6	24	BKK		81866

### NEW BEETLE, CABRIO

1.4	55	11/01→	1.390	B	M	4	16	BCA		81777
1.6	74	10/99→09/00	1.595	B	M	4	8	AWH		81702
	75	06/00→	1.595	B	M	4	8	AYD, BFS		81702
1.8 T	110	10/99→	1.781	B	M	4	20	APH, AVC, AWU, AWV		81703
	132	11/01→06/05	1.781	B	M	4	20	AWP		81703
1.9 TDI	66	01/98→06/04	1.896	D	M	4	8	ALH		81706
	74	02/01→	1.896	D	M	4	8	ATD		81791
	74	06/03→	1.896	D	M	4	8	AXR		81816
	77	07/05→	1.896	D	M	4	8	BSW		81791
	77	07/05→	1.896	D	M	4	8	BSW		81816
2.0	85	01/98→	1.984	B	M	4	8	AEG, APK, AQY, AZG		81703
	85	09/02→	1.984	B	A	4	8	AZJ, BDC, BGD		81703

	kw		Cap. cm3	Fuel	Gear	No. of cyl.	No. of valves	Motor code		Short
--	----	--	----------	------	------	-------------	---------------	------------	--	-------

## VOLKSWAGEN

### NEW BEETLE, CABRIO

2.3 V5	125	10/00→	2.324	B	M	5	20	AQN		81856
RSI 3.2	165	04/00→05/01	3.188	B	M	6	24	AXJ		81866

### PASSAT III, VARIANT

1.6	53	02/88→09/91	1.595	B	M	4	8	1F, EZ	(-)COP	81522
	53	02/88→09/91	1.595	B	M	4	8	1F, EZ	(+)COP, CR	82080
	55	02/88→12/88	1.595	B	M	4	8	EZ	(-)COP	81522
	55	02/88→12/88	1.595	B	M	4	8	EZ	(+)COP, CR	82080
	74	07/94→08/96	1.595	B	M	4	8	AEK, AFT	(-)COP	81522
	74	07/94→08/96	1.595	B	M	4	8	AEK, AFT	(+)COP, CR	82080
1.6 TD	59	08/88→09/93	1.588	D	M	4	8	RA, SB	(-)COP	81522
	59	08/88→09/93	1.588	D	M	4	8	RA, SB	(+)COP, CR	82080
1.8	55	08/90→05/97	1.781	B	M	4	8	AAM	(-)COP	81522
	55	08/90→05/97	1.781	B	M	4	8	AAM	(+)COP, CR	82080
	66	02/88→05/97	1.781	B	M	4	8	ABS, ADZ, RP	(-)COP	81522
	66	02/88→05/97	1.781	B	M	4	8	ABS, ADZ, RP	(+)COP, CR	82080
	79	04/88→07/93	1.781	B	M	4	8	PF	(-)COP	81522
	79	04/88→07/93	1.781	B	M	4	8	PF	(+)COP, CR	82080
	82	04/88→07/92	1.781	B	M	4	8	PB	(-)COP	81522
	82	04/88→07/92	1.781	B	M	4	8	PB	(+)COP, CR	82080
	102	08/91→09/93	1.781	B	M	4	16	KR	(-)COP	81522
	102	08/91→09/93	1.781	B	M	4	16	KR	(+)COP, CR	82080
1.8 16V	100	04/88→12/89	1.781	B	M	4	16	KR	(-)COP	81522
	100	04/88→12/89	1.781	B	M	4	16	KR	(+)COP, CR	82080
1.8 G60 Syncro	79	09/89→07/93	1.781	B	M	4	8	PF	(-)COP	81522
	79	09/89→07/93	1.781	B	M	4	8	PF	(+)COP, CR	82080
	118	08/88→05/97	1.781	B	M	4	8	PG	(-)COP	81522
	118	08/88→05/97	1.781	B	M	4	8	PG	(+)COP, CR	82080
1.8 GL	102	08/91→09/93	1.781	B	M	4	16	KR	(-)COP	81522
	102	08/91→09/93	1.781	B	M	4	16	KR	(+)COP, CR	82080
1.9 D	50	05/89→10/93	1.896	D	M	4	8	1Y	(-)COP	81522
	50	05/89→10/93	1.896	D	M	4	8	1Y	(+)COP, CR	82080
1.9 TD	55	03/91→05/97	1.896	D	M	4	8	AAZ	(-)COP	81522
	55	03/91→05/97	1.896	D	M	4	8	AAZ	(+)COP, CR	82080
1.9 TDI	66	10/93→05/97	1.896	D	M	4	8	1Z, AHU	(-)COP	81522
	66	10/93→05/97	1.896	D	M	4	8	1Z, AHU	(+)COP, CR	82080
	81	03/96→05/97	1.896	D	M	4	8	AFN	(-)COP	81522
	81	03/96→05/97	1.896	D	M	4	8	AFN	(+)COP, CR	82080
2.0	79	03/95→08/96	1.984	B	M	4	8	AEP	(-)COP	81522
	79	03/95→08/96	1.984	B	M	4	8	AEP	(+)COP, CR	82080
	85	02/90→05/97	1.984	B	M	4	8	2E, ADY, AGG	(-)COP	81522
	85	02/90→05/97	1.984	B	M	4	8	2E, ADY, AGG	(+)COP, CR	82080
	125	04/88→07/91	1.984	B	M	4	8		(-)COP	81522
	125	04/88→07/91	1.984	B	M	4	8		(+)COP, CR	82080
2.0 16V	100	08/88→09/93	1.984	B	M	4	16	9A	(-)COP	81522
	100	08/88→09/93	1.984	B	M	4	16	9A	(+)COP, CR	82080

	kW		Cap. cm3	Fuel	Gear	No. of cyl.	No. of valves	Motor code		Short
--	----	--	----------	------	------	-------------	---------------	------------	--	-------

## VOLKSWAGEN

### PASSAT III, VARIANT

2.0 16V	110	01/94→05/97	1.984	B	M	4	16	ABF	(-)COP	81522
	110	01/94→05/97	1.984	B	M	4	16	ABF	(+)COP, CR	82080
2.0 Syncro	81	09/89→07/92	1.984	B	M	4	8		(-)COP	81522
	81	09/89→07/92	1.984	B	M	4	8		(+)COP, CR	82080
	85	10/90→05/97	1.984	B	M	4	8	2E, ADY, AGG	(-)COP	81522
	85	10/90→05/97	1.984	B	M	4	8	2E, ADY, AGG	(+)COP, CR	82080
2.8 CL Syncro	142	10/94→12/95	2.771	B	M	6	24	AHA		81773
2.8 VR6	128	06/91→05/97	2.792	B	M	6	12	AAA		81773
2.9 VR6 Syncro	135	01/94→05/97	2.861	B	M	6	12	ABV		81773

### PASSAT IV, VARIANT

1.6	74	10/96→11/00	1.595	B	M	4	8	ADP, AHL, ANA, ARM	(-)COP, →12-1997, M: ADP	81526
	74	10/96→11/00	1.595	B	M	4	8	ADP, AHL, ANA, ARM	(+)COP, →12-1997, M: ADP	81529
	74	10/96→11/00	1.595	B	M	4	8	ADP, AHL, ANA, ARM	01-1998→, M: ARM, M: ANA, M: ARM, M: AHL, M: ANA	81702
1.8	85	01/97→11/00	1.781	B	M	4	20	AFY	(-)COP	81526
	85	01/97→11/00	1.781	B	M	4	20	AFY	(+)COP	81529
	92	10/96→11/00	1.781	B	M	4	20	ADR, APT, ARG	(-)COP	81526
	92	10/96→11/00	1.781	B	M	4	20	ADR, APT, ARG	(+)COP	81529
1.8 Syncro/4motion	92	10/96→11/00	1.781	B	M	4	20	ADR, APT, ARG	(-)COP	81526
	92	10/96→11/00	1.781	B	M	4	20	ADR, APT, ARG	(+)COP	81529
1.8 T	110	10/96→11/00	1.781	B	M	4	20	AEB, ANB, APU	(-)COP, M: ANB, M: AEB, M: ANB	81526
	110	10/96→11/00	1.781	B	M	4	20	AEB, ANB, APU	(+)COP, M: ANB, M: AEB, M: ANB	81529
	110	10/96→11/00	1.781	B	M	4	20	AEB, ANB, APU	M: APU	81702
1.8 T Syncro	110	11/96→08/00	1.781	B	M	4	20	AEB	(-)COP	81526
	110	11/96→08/00	1.781	B	M	4	20	AEB	(+)COP	81529
1.9 TDI	66	10/96→11/00	1.896	D	M	4	8	AHH, AHU		81528
	74	02/00→11/00	1.896	D	M	4	8	AVB		81816
	81	10/96→11/00	1.896	D	M	4	8	AFN, AVG		81528
	85	08/98→11/00	1.896	D	M	4	8	AJM, ATJ		81816
1.9 TDI 4motion	85	08/99→11/00	1.896	D	M	4	8	AJM, ATJ		81816
1.9 TDI Syncro/4motion	81	10/96→11/00	1.896	D	M	4	8	AFN, AVG		81528
2.0	88	04/00→11/00	1.984	B	M	4	8	ASU, AUZ		81703
2.0 4motion	88	04/00→11/00	1.984	B	M	4	8	ASU, AUZ		81703
2.3 VR5	110	10/96→11/00	2.324	B	M	5	10	AGZ		81856
2.3 VR5 Syncro/4motion	110	10/97→11/00	2.324	B	M	5	10	AGZ		81856
2.5 TDI	110	07/98→11/00	2.496	D	M	6	24	AFB, AKN		81705
2.5 TDI Syncro/4motion	110	12/98→11/00	2.496	D	M	6	24	AFB, AKN		81705
2.8 Syncro	132	05/97→09/99	2.771	B	M	6	30	AGE		81842
2.8 V6	132	05/97→09/99	2.771	B	M	6	30	AGE		81842
	140	09/99→11/00	2.771	B	M	6	30	ATX, BBG		81842
	142	08/96→11/00	2.771	B	M	6	30	ACK, APR, AQD		81842

	kw		Cap. cm3	Fuel	Gear	No. of cyl.	No. of valves	Motor code		MAGNETI MARELLI Short
--	----	--	----------	------	------	-------------	---------------	------------	--	-----------------------

## VOLKSWAGEN

### PASSAT IV, VARIANT

2.8 V6 4motion	140	09/99→11/00	2.771	B	M	6	30	ATX		81842
2.8 V6 Syncro/4motion	142	10/96→11/00	2.771	B	M	6	30	ACK, ALG, APR, AQD		81842

### PASSAT V, VARIANT

1.6	75	11/00→05/05	1.595	B	AM	4	8	ALZ		81702
1.8	92	03/03→03/05	1.781	B	M	4	20	APT	(-)COP	81526
	92	03/03→03/05	1.781	B	M	4	20	APT	(+)COP	81529
1.8 4motion	125	03/01→05/05	1.781	B	M	4	20	AWM		81703
1.8 T	125	02/01→05/05	1.781	B	M	4	20	AWM		81703
1.8 T 20V	110	11/00→05/05	1.781	B	M	4	20	AWL, AWT		81703
1.9 TDI	74	11/00→05/05	1.896	D	M	4	8	AVB		81816
	96	11/00→05/05	1.896	D	AM	4	8	AVF, AWX		81816
	96	11/00→05/05	1.896	D	M	4	8	AVF, AWX		81816
1.9 TDI 4motion	96	11/00→05/05	1.896	D	AM	4	8	AVF		81816
	96	11/00→05/05	1.896	D	M	4	8	AVF		81816
2.0	85	11/00→05/05	1.984	B	M	4	8	AZM, BFF		81703
	96	11/01→05/05	1.984	B	M	4	20	ALT		81702
2.0 4motion	85	11/00→05/05	1.984	B	M	4	8	AZM		81703
2.0 TDI	100	12/03→05/05	1.968	D	M	4	8	BGW		81816
2.3 V5	125	11/00→05/05	2.324	B	M	5	20	AZX		81856
2.3 V5 4motion	125	11/00→05/05	2.324	B	M	5	20	AZX		81856
2.3 VR5	125	11/00→05/05	2.324	B	M	5	20	AZX		81856
2.3 VR5 4motion	125	11/00→05/05	2.324	B	M	5	20	AZX		81856
2.5 TDI	110	11/00→05/05	2.496	D	M	6	24	AFB, AKN		81705
	120	05/03→05/05	2.496	D	M	6	24	BDG		81705
2.5 TDI 4motion	110	11/00→05/05	2.496	D	M	6	24	AFB, AKN		81705
	132	01/03→05/05	2.496	D	M	6	24	BAU, BDH		81705
2.8	142	05/02→05/03	2.771	B	M	6	30	AMX		81842
2.8 4motion	142	11/00→05/05	2.771	B	M	6	30	AMX, ATQ		81842

### PASSAT VI, VARIANT, CC

1.4 TSI	90	05/07→	1.390	B	M	4	16	CAXA		82097
1.6	75	05/05→	1.595	B	M	4	8	BSE, BSF		81702
1.6 FSI	85	03/05→	1.598	B	M	4	16	BLF		81865
1.6 TDI	77	08/09→	1.598	D	M	4	16	CAYC		83000
1.8 TSI	112	11/09→	1.798	B	M	4	16	CDAB, CGYA		82096
	118	05/07→	1.798	B	M	4	16	BZB, CDAA		82096
1.9 TDI	77	03/05→	1.896	D	M	4	8	BKC, BLS		81791
2.0 BlueTDI	105	01/09→	1.968	D	M	4	16	CBAC		81816
2.0 FSI	110	03/05→	1.984	B	M	4	16	BLR, BLY		81702
	125	08/07→	1.984	B	M	4	16	CCTB		82096
2.0 FSI 4motion	110	09/05→	1.984	B	M	4	16	BLX, BLY, BVX		81702
2.0 TDI	81	11/08→	1.968	D	M	4	16	CBDC		81816
	88	11/05→05/06	1.968	D	M	4	16	BWV		81816
	90	08/05→07/06	1.968	D	M	4	16	BVE		81816
	100	03/05→	1.968	D	M	4	16	BMA, CBAA		81816

	kW		Cap. cm3	Fuel	Gear	No. of cyl.	No. of valves	Motor code		Short
--	----	--	----------	------	------	-------------	---------------	------------	--	-------

## VOLKSWAGEN

### PASSAT VI, VARIANT, CC

2.0 TDI	103	03/05→	1.968	D	M	4	8	BMP		81816
	103	06/08→	1.968	D	M	4	16	CBAB		81816
	120	08/05→	1.968	D	M	4	16	BUZ		81816
	125	08/05→	1.968	D	M	4	16	BMR, CBBB		81816
2.0 TDI 16V	103	03/05→	1.968	D	M	4	16	BKP		81816
2.0 TDI 16V 4motion	103	03/05→	1.968	D	M	4	16	BKP		81816
2.0 TDI 4motion	103	03/05→	1.968	D	M	4	8	BMP		81816
	103	08/09→	1.968	D	M	4	16	CBAB		81816
	125	05/09→	1.968	D	M	4	16	CBBB		81816
2.0 TFSI	147	07/05→	1.984	B	M	4	16	AXX, BPY, BWA		82025
2.0 TSI	147	06/08→	1.984	B	M	4	16	CAWB, CCTA		82025
3.2 FSI	184	11/05→	3.168	B	M	6	24	AXZ		81866
3.2 FSI 4motion	184	11/05→	3.168	B	M	6	24	AXZ		81866
3.6 4motion	220	06/08→	3.597	B	M	6	24	BWS		81866
3.6 FSI	206	06/05→07/07	3.597	B	M	6	24	BLV		81866
3.6 FSI 4motion	206	09/05→	3.597	B	M	6	24	BLV		81866
3.6 R36 4motion	220	04/07→	3.597	B	M	6	24	BWS		81866

### PHAETON

3.0 V6 TDI 4motion	165	09/04→	2.967	D	M	6	24	BMK		82015
	171	06/07→	2.967	D	M	6	24	CARA		82015
	176	11/08→	2.967	D	M	6	24	CEXA		82015
3.2 V6	177	04/02→	3.189	B	AM	6	24	AYT, BKL		81866
3.2 V6 4motion	177	02/04→	3.189	B	AM	6	24	BKL, BRK		81866
3.6 V6 4motion	206	11/08→	3.597	B	M	6	24	CHNA		81866
4.2 V8 4motion	246	05/03→	4.172	B	M	8	40	BGH, BGJ		82081

### POLO II, CLASSIC, COUPÉ, VAN

0.9	29	10/81→12/81	895	B	M	4	8	HA		81520
1.0	29	10/81→10/86	1.043	B	M	4	8	GL		81520
	33	01/85→09/94	1.043	B	M	4	8	AAK, AAU, HZ	→07-1992, →M: 015.867	81520
	33	01/85→09/94	1.043	B	M	4	8	AAK, AAU, HZ	08-1992→, M→: 015.868	81524
1.0 Cat.	33	08/89→09/94	1.043	B	M	4	8	AAK, AAU, ACM	→07-1992, →M: 015.867	81520
	33	08/89→09/94	1.043	B	M	4	8	AAK, AAU, ACM	08-1992→, M→: 015.868	81524
1.1	37	10/81→09/89	1.093	B	M	4	8	HB		81520
1.3	37	08/83→07/85	1.272	B	M	4	8	HW		81520
	40	08/83→07/88	1.272	B	M	4	8	HK, MH		81520
	40	08/92→07/94	1.272	B	M	4	8	AAV		81524
	43	10/81→07/82	1.272	B	M	4	8	HJ		81520
	44	10/81→07/83	1.272	B	M	4	8	HH		81520
	55	09/82→09/89	1.272	B	M	4	8	GK		81520
	57	03/91→09/94	1.272	B	M	4	8	3F	→M: 008.526	81520
	57	03/91→09/94	1.272	B	M	4	8	3F	M→: 008.527	81524
1.3 Cat.	40	07/87→09/94	1.272	B	M	4	8	2G, AAV, MH, NZ	→M: 200.000	81520
	40	07/87→09/94	1.272	B	M	4	8	2G, AAV, MH, NZ	M→: 200.001	81524
	55	10/89→09/94	1.272	B	M	4	8	3F	→M: 008.526	81520
	55	10/89→09/94	1.272	B	M	4	8	3F	M→: 008.527	81524

	kW		Cap. cm3	Fuel	Gear	No. of cyl.	No. of valves	Motor code		Short
--	----	--	----------	------	------	-------------	---------------	------------	--	-------

## VOLKSWAGEN

### POLO II, CLASSIC, COUPÉ, VAN

1.3 D	33	08/86→08/90	1.272	D	M	4	8	MN		81525
1.3 G40	83	08/90→09/94	1.272	B	M	4	8	PY	→08-1992, →M: 002.177	81520
	83	08/90→09/94	1.272	B	M	4	8	PY	09-1992→, M→: 002.178	81524
	85	01/87→08/90	1.272	B	M	4	8	PY		81520
1.4 D	35	08/90→09/94	1.398	D	M	4	8	1W		81525

### POLO III, CLASSIC, VARIANT, VAN

1.0	33	10/94→12/99	1.043	B	M	4	8	AAU		81524
	37	08/96→12/01	999	B	M	4	8	AER, ALD, AUC		81775
1.2	40	04/01→10/01	1.198	B	M	3	6	AWY		81867
1.4	40	12/98→09/01	1.390	B	M	4	8	AKP		81775
	44	05/97→09/01	1.390	B	M	4	8	AEX, AKK, AKV, ANW, APQ, AUD	M: AEX, M: ANX, M: AKV, M: AEX, M: APQ, M: ANX	81527
	44	05/97→09/01	1.390	B	M	4	8	AEX, AKK, AKV, ANW, APQ, AUD	M: AKK, M: AUD, M: ANW, M: AKK	81775
1.4 16V	55	10/99→09/01	1.390	B	M	4	16	AHW, APE, AUA		81777
	74	10/99→09/01	1.390	B	M	4	16	AFK, AQQ, AUB		81777
1.4 TDI	55	10/99→09/01	1.422	D	M	3	6	AMF		81791
	66	01/00→10/00	1.422	D	M	3	6	ATL		81791
1.6	55	09/94→09/01	1.598	B	M	4	8	AEA, AEE, ALM		81527
	74	05/97→09/01	1.595	B	M	4	8	AEH, AFT, AKL, APF, AUR	(-)COP, M: AFT	81522
	74	05/97→09/01	1.595	B	M	4	8	AEH, AFT, AKL, APF, AUR	M: AUR, M: AKL, M: AEH, M: AUR, M: APF, M: AKL	81702
	74	05/97→09/01	1.595	B	M	4	8	AEH, AFT, AKL, APF, AUR	(+)COP, CR	82080
1.6 16V GTI	92	10/99→09/01	1.598	B	M	4	16	ARC, AVY		81840
1.6 RC	74	05/96→07/02	1.595	B	M	4	8	AFT	(+)COP, CR	82080
1.7 SDI	42	08/97→09/01	1.716	D	M	4	8	AKW	(-)COP	81522
	42	04/97→10/99	1.716	D	M	4	8	AHG		81528
	42	08/97→09/01	1.716	D	M	4	8	AKW	(+)COP, CR	82080
	44	08/97→09/01	1.716	D	M	4	8	AKU		81528
1.8	66	05/97→09/01	1.781	B	M	4	8	ADZ	(-)COP	81522
	66	05/97→09/01	1.781	B	M	4	8	ADZ	(+)COP, CR	82080
1.9 D	47	10/94→09/01	1.896	D	M	4	8	AEF		81528
1.9 SDI	47	06/97→09/01	1.896	D	M	4	8	AEY	(-)COP	81522
	47	07/96→09/01	1.896	D	M	4	8	AGD, ASX		81528
	47	06/97→09/01	1.896	D	M	4	8	AEY	(+)COP, CR	82080
	50	08/99→09/01	1.896	D	M	4	8	AGP, AQM		81706
1.9 TDI	66	05/97→09/01	1.896	D	M	4	8	AGR, AHU, ALE, ALH	(-)COP, M: ALE	81522
	66	05/97→09/01	1.896	D	M	4	8	AGR, AHU, ALE, ALH	M: AHU	81528
	66	05/97→09/01	1.896	D	M	4	8	AGR, AHU, ALE, ALH	M: ALH, M: AGR	81706
	66	05/97→09/01	1.896	D	M	4	8	AGR, AHU, ALE, ALH	(+)COP, CR	82080
	81	06/98→09/01	1.896	D	M	4	8	AFN, ASV	M: AFN	81528
	81	06/98→09/01	1.896	D	M	4	8	AFN, ASV	M: ASV	81706
100 1.4 16V	74	04/96→10/99	1.390	B	M	4	16	AFH		81776
100 1.6	74	12/95→09/01	1.595	B	M	4	8	AEH, AFT, AKL, APF, AUR	(-)COP, M: AFT	81522
	74	12/95→09/01	1.595	B	M	4	8	AEH, AFT, AKL, APF, AUR		81702
	74	12/95→09/01	1.595	B	M	4	8	AEH, AFT, AKL, APF, AUR	(+)COP, CR	82080

	kw		Cap. cm3	Fuel	Gear	No. of cyl.	No. of valves	Motor code		Short
--	----	--	----------	------	------	-------------	---------------	------------	--	-------

## VOLKSWAGEN

### POLO III, CLASSIC, VARIANT, VAN

110 1.9 TDI	81	06/98→09/01	1.896	D	M	4	8	AFN, ASV	(-)COP	81522
	81	06/98→09/01	1.896	D	M	4	8	AFN, ASV	(+)COP, CR	82080
120 1.6 16V GTI	88	09/98→10/99	1.598	B	M	4	16	AJV		81840
45 1.0	33	10/94→09/96	1.043	B	M	4	8	AEV		81527
50 1.0	37	09/96→10/99	999	B	M	4	8	AER, ALL		81775
55 1.3	40	10/94→07/95	1.296	B	M	4	8	ADX		81527
55 1.4	40	08/95→10/99	1.390	B	M	4	8	AEX		81527
57 1.7 SDI	42	07/97→09/01	1.716	D	M	4	8	AKW	(-)COP	81522
	42	07/97→09/01	1.716	D	M	4	8	AKW	(+)COP, CR	82080
60 1.4	44	07/95→09/01	1.390	B	M	4	8	AEX, AKK, AKV, ANW, APQ, AUD	M: APQ, M: AKV, M: ANX, M: APQ, M: AEX, M: AKV	81527
	44	12/95→09/01	1.390	B	M	4	8	AEX, AKK, AKV, ANW, APQ, AUD	M: AUD, M: AKK, M: ANW, M: AUD	81775
60 1.7 SDI	44	08/97→10/99	1.716	D	M	4	8	AKU		81528
64 1.9 D	47	10/94→10/99	1.896	D	M	4	8	AEF		81528
	47	01/96→10/96	1.896	D	M	4	8	1Y	(-)COP	81522
	47	01/96→10/96	1.896	D	M	4	8	1Y	(+)COP, CR	82080
64 1.9 SDI	47	12/95→08/99	1.896	D	M	4	8	1Y, AEY	(-)COP	81522
	47	12/95→08/99	1.896	D	M	4	8	1Y, AEY	(+)COP, CR	82080
	47	07/96→10/99	1.896	D	M	4	8	AGD		81528
	50	08/99→09/01	1.896	D	M	4	8	AGP, AQM		81706
75 1.4 16V	55	10/99→09/01	1.390	B	M	4	16	APE, AUA		81777
75 1.6	55	11/95→09/97	1.595	B	M	4	8	1F	(-)COP	81522
	55	11/95→09/97	1.595	B	M	4	8	1F	(+)COP, CR	82080
	55	10/94→09/01	1.598	B	M	4	8	AEA, AEE, AHS, ALM		81527
90 1.8	66	01/97→09/01	1.781	B	M	4	8	ADD	(-)COP	81522
	66	01/97→09/01	1.781	B	M	4	8	ADD	(+)COP, CR	82080
90 1.9 TDI	66	09/96→09/01	1.896	D	M	4	8	AGR, AHU, ALE, ALH	(-)COP, M: ALE	81522
	66	09/96→09/01	1.896	D	M	4	8	AGR, AHU, ALE, ALH	M: AHU	81528
	66	09/96→09/01	1.896	D	M	4	8	AGR, AHU, ALE, ALH	M: ALH, M: AGR	81706
	66	09/96→09/01	1.896	D	M	4	8	AGR, AHU, ALE, ALH	(+)COP, CR	82080

### POLO IV

1.0	37	08/96→12/01	999	B	M	4	8	AER		81775
1.2	40	01/02→05/07	1.198	B	M	3	6	AWY, BMD		81867
	44	05/07→	1.198	B	M	3	6	BBM		81867
	47	10/01→07/07	1.198	B	M	3	12	AZQ, BME		81867
	51	05/07→	1.198	B	M	3	12	BZG		81867
1.4	55	07/03→	1.390	B	M	4	16	BBY		81777
	74	11/03→	1.390	B	M	4	16	BBZ		81777
1.4 16V	55	10/01→05/08	1.390	B	AM	4	16	AUA, BBY, BKY		81777
	59	05/06→	1.390	B	M	4	16	BUD		81777
	74	10/01→05/08	1.390	B	M	4	16	AUB, BBZ		81777
1.4 FSI	63	02/02→07/06	1.390	B	M	4	16	AXU		81865
1.4 TDI	51	04/05→	1.422	D	M	3	6	BNM		81791
	55	10/01→06/05	1.422	D	M	3	6	AMF, BAY		81791
	59	04/05→	1.422	D	M	3	6	BMS, BNV		81791



	kW		Cap. cm3	Fuel	Gear	No. of cyl.	No. of valves	Motor code		MAGNETI MARELLI Short
--	----	--	----------	------	------	-------------	---------------	------------	--	-----------------------

## VOLKSWAGEN

### POLO IV

1.6	74	09/02→	1.598	B	M	4	8	BAH		81527
1.6 16V	77	05/06→	1.598	B	M	4	16	BTS		81865
1.6 Sportline	74	08/02→05/05	1.598	B	M	4	8	BAH		81527
1.6 Total Flex	74	10/04→	1.598	FF	M	4	8	BPA		81527
1.8 GTI	110	09/05→	1.781	B	M	4	20	BJX		81703
1.9 SDI	47	10/01→	1.896	D	M	4	8	ASY		82013
1.9 TDI	74	10/01→	1.896	D	M	4	8	ATD, AXR		81791
	96	11/03→	1.896	D	M	4	8	ASZ, BLT		81791
2.0	85	09/02→	1.984	B	M	4	8	BBX		81703

### POLO V

1.2	44	06/09→	1.198	B	M	3	12	CGPB		81867
	51	06/09→	1.198	B	M	3	12	CGPA		81867
1.2 TDI	55	10/09→	1.199	D	M	3	12	CFWA		83000
1.4	63	06/09→	1.390	B	M	4	16	CGGB		81777
1.6 TDI	55	06/09→	1.598	D	M	4	16	CAYA		83000
	66	06/09→	1.598	D	M	4	16	CAYB		83000
	77	06/09→	1.598	D	M	4	16	CAYC		83000

### SAVEIRO I

1.6	55	08/90→07/96	1.595	B	M	4	8	1F, EW	(-)COP	81522
	55	08/90→07/96	1.595	B	M	4	8	1F, EW	(+)COP, CR	82080

### SAVEIRO II

1.6	55	08/96→02/02	1.595	B	M	4	8	1F, EW	(-)COP	81522
	55	08/96→02/02	1.595	B	M	4	8	1F, EW	(+)COP, CR	82080

### SCIROCCO II

1.6	51	08/83→07/84	1.595	B	M	4	8	EWA	(-)COP	81522
	51	08/83→07/84	1.595	B	M	4	8	EWA	(+)COP, CR	82080
	53	04/86→07/90	1.595	B	M	4	8	RE	(-)COP	81522
	53	04/86→07/90	1.595	B	M	4	8	RE	(+)COP, CR	82080
	55	01/83→12/89	1.595	B	M	4	8	EW	(-)COP	81522
	55	01/83→12/89	1.595	B	M	4	8	EW	(+)COP, CR	82080
1.8	66	08/83→07/92	1.781	B	M	4	8	EX	(-)COP	81522
	66	08/83→07/92	1.781	B	M	4	8	EX	(+)COP, CR	82080
	70	11/85→07/92	1.781	B	M	4	8	JH	(-)COP	81522
	70	11/85→07/92	1.781	B	M	4	8	JH	(+)COP, CR	82080
	82	08/82→12/89	1.781	B	M	4	8	DX, EV, JJ, PB	(-)COP	81522
	82	08/82→12/89	1.781	B	M	4	8	DX, EV, JJ, PB	(+)COP, CR	82080
1.8 16V	95	03/86→07/92	1.781	B	M	4	16	PL	(-)COP	81522
	95	03/86→07/92	1.781	B	M	4	16	PL	(+)COP, CR	82080
	102	10/85→07/89	1.781	B	M	4	16	KR	(-)COP	81522
	102	10/85→07/89	1.781	B	M	4	16	KR	(+)COP, CR	82080

### SCIROCCO III

1.4 TSI	90	09/08→	1.390	B	M	4	16	CAXA		82097
2.0 R	195	11/09→	1.984	B	M	4	16	CDLA		82025
2.0 TDI	103	09/08→	1.968	D	M	4	16	CBDB		81816
	125	05/09→	1.968	D	M	4	16	CBBB		81816

	kW		Cap. cm3	Fuel	Gear	No. of cyl.	No. of valves	Motor code		Short
--	----	--	----------	------	------	-------------	---------------	------------	--	-------

## VOLKSWAGEN

### SCIROCCO III

2.0 TSI	147	09/08→	1.984	B	M	4	16	CAWB		82096
	155	11/09→	1.984	B	M	4	16	CCZB		82096

### SHARAN I

1.8 T 20V	110	09/97→	1.781	B	M	4	20	AJH, AWC		81703
1.9 TDI	66	09/95→	1.896	D	M	4	8	1Z, AHU, ANU	(-)COP, 09-1995→, →03-2000, M: AHU, M: 1Z	81522
	66	09/95→	1.896	D	M	4	8	1Z, AHU, ANU	03-2000→, M: ANU	81816
	66	09/95→	1.896	D	M	4	8	1Z, AHU, ANU	(+)COP, CR	82080
	81	09/96→04/00	1.896	D	M	4	8	AFN, AVG	(-)COP	81522
	81	09/96→04/00	1.896	D	M	4	8	AFN, AVG	(+)COP, CR	82080
	85	04/00→	1.896	D	M	4	8	AUY		81816
	96	11/02→	1.896	D	M	4	8	ASZ		81791
	110	06/05→	1.896	D	M	4	8	BTB		81791
1.9 TDI 4motion	85	04/00→	1.896	D	M	4	8	AUY		81816
2.0	85	09/95→	1.984	B	M	4	8	ADY, ATM	(-)COP, 09-1995→, →02-2000, M: ADY	81522
	85	09/95→	1.984	B	M	4	8	ADY, ATM	03-2000→, M: ATM	81703
	85	09/95→	1.984	B	M	4	8	ADY, ATM	(+)COP, CR	82080
2.0 TDI	103	11/05→	1.968	D	M	4	8	BRT		81816
2.8 V6 24V	150	04/00→	2.792	B	M	6	24	AYL	→T: 035.000	81773
	150	04/00→	2.792	B	M	6	24	AYL	T→: 035.001	81866
2.8 V6 24V 4motion	150	04/00→	2.792	B	M	6	24	AYL	→T: 035.000	81773
	150	04/00→	2.792	B	M	6	24	AYL	T→: 035.001	81866
2.8 VR6	128	09/95→04/00	2.792	B	M	6	12	AAA, AMY	09-1995→	81773
2.8 VR6 Syncro	128	11/96→04/00	2.792	B	M	6	12	AAA, AMY	09-1995→	81773

### TIGUAN

1.4 TSI	90	08/10→	1.390	B	M	4	16	CAXA		82097
2.0 TDI	100	11/07→	1.968	D	M	4	16	CBAA		81816
	103	09/07→	1.968	D	M	4	16	CBAB		81816
	125	09/07→	1.968	D	M	4	16	CBBB		81816
2.0 TDI FWD	103	03/08→	1.968	D	M	4	16	CBAB		81816
2.0 TFSI	125	09/07→	1.984	B	M	4	16	CAWA		82096
	147	09/07→	1.984	B	M	4	16	CAWB		82096

### TOUAREG I

2.5 R5 TDI	120	08/03→05/10	2.461	D	M	5	10	BLK		82033
	128	01/03→05/10	2.461	D	M	5	10	BAC		82033
3.0 TDI	155	12/06→05/10	2.967	D	M	6	24	BUN		82015
3.0 Tdi 4motion	176	11/07→	2.967	D	M	6	24	CASA		82015
3.0 V6 TDI	165	11/04→05/10	2.967	D	M	6	24	BKS		82015
	176	11/07→05/10	2.967	D	M	6	24	CASA		82015
3.2 V6	162	10/02→11/06	3.189	B	M	6	24	AZZ, BKJ		81866
	177	11/04→11/06	3.189	B	M	6	24	BMX		81866
4.2 V8	228	12/02→11/06	4.172	B	M	8	40	AXQ, BHX		82081

### TOUAREG II

3.0 V6 TDI	176	04/10→	2.967	D	M	6	24	CASA		82015
------------	-----	--------	-------	---	---	---	----	------	--	-------

	kW		Cap. cm3	Fuel	Gear	No. of cyl.	No. of valves	Motor code		Short
--	----	--	----------	------	------	-------------	---------------	------------	--	-------

## VOLKSWAGEN

### TOURAN

1.6	75	07/03→	1.595	B	M	4	8	BGU, BSE, BSF		81702
1.6 FSI	85	02/03→	1.598	B	M	4	16	BAG, BLF, BLP		81865
1.6 TDI	66	05/10→	1.598	D	M	4	16	CAYB		83000
	77	05/10→	1.598	D	M	4	16	CAYC		83000
1.9 TDI	66	11/04→	1.896	D	M	4	8	BRU		81791
	74	02/03→	1.896	D	M	4	8	AVQ		81791
	77	08/03→	1.896	D	M	4	8	BKC		81791
2.0 EcoFuel	80	02/06→	1.984	M	M	4	16	BSX		81703
2.0 FSI	85	10/04→	1.984	B	M	4	16	BJZ		81702
	110	10/03→	1.984	B	M	4	16	AXW, BLR, BLX, BLY		81702
2.0 TDI	100	02/03→	1.968	D	M	4	16	AZV		81816
	103	12/05→	1.968	D	M	4	8	BMM		81816
	125	12/05→	1.968	D	M	4	16	BMN		81816
2.0 TDI 16V	103	08/03→	1.968	D	M	4	16	BKD		81816

### TRANSPORTER III

1.6	37	05/79→12/82	1.584	B	M	4	8	CT	(-)COP, →07-1981	81521
	37	05/79→12/82	1.584	B	M	4	8	CT	(-)COP, 08-1981→	81522
	37	05/79→12/82	1.584	B	M	4	8	CT	(+)COP, →07-1981	82001
	37	05/79→12/82	1.584	B	M	4	8	CT	(+)COP, CR	82080
1.6 D	37	01/81→07/87	1.588	D	M	4	8	CS	(-)COP, →M: 215.895	81521
	37	01/81→07/87	1.588	D	M	4	8	CS	(-)COP, M→: 215.896	81522
	37	01/81→07/87	1.588	D	M	4	8	CS	(+)COP, →M: 215.895	82001
	37	01/81→07/87	1.588	D	M	4	8	CS	(+)COP, CR	82080
1.6 TD	51	08/84→07/92	1.589	D	M	4	8	JX	(-)COP, →M: 012.052	81521
	51	08/84→07/92	1.589	D	M	4	8	JX	(-)COP, M→: 012.053	81522
	51	08/84→07/92	1.589	D	M	4	8	JX	(+)COP, →M: 012.052	82001
	51	08/84→07/92	1.589	D	M	4	8	JX	(+)COP, CR	82080
1.6 TD Syncro	51	03/86→07/92	1.589	D	M	4	8	JX	(-)COP, →M: 012.052	81521
	51	03/86→07/92	1.589	D	M	4	8	JX	(-)COP, M→: 012.053	81522
	51	03/86→07/92	1.589	D	M	4	8	JX	(+)COP, →M: 012.052	82001
	51	03/86→07/92	1.589	D	M	4	8	JX	(+)COP, CR	82080
1.7 D	42	08/85→07/87	1.715	D	M	4	8	KY	(-)COP	81522
	42	08/85→07/87	1.715	D	M	4	8	KY	(+)COP, CR	82080
	42	10/86→07/92	1.716	D	M	4	8	KY	(-)COP	81522
	42	10/86→07/92	1.716	D	M	4	8	KY	(+)COP, CR	82080
2.0	51	05/79→04/86	1.970	B	M	4	8	CU, CV	(-)COP	81522
	51	05/79→04/86	1.970	B	M	4	8	CU, CV	(+)COP, CR	82080
2.1	64	10/86→07/92	2.109	B	M	4	8	SR		81832
	70	08/85→07/92	2.110	B	M	4	8	MV		81832
	82	08/85→07/92	2.110	B	M	4	8	DJ		81832
2.1 i	68	07/89→07/92	2.110	B	M	4	8	SS		81832
2.1 Syncro	64	10/86→07/92	2.109	B	M	4	8	SR		81832
	70	08/85→07/92	2.110	B	M	4	8	MV		81832
	82	01/86→07/92	2.110	B	M	4	8	DJ		81832

	kw		Cap. cm3	Fuel	Gear	No. of cyl.	No. of valves	Motor code		Short
<b>VOLKSWAGEN</b>										
<b>TRANSPORTER IV</b>										
1.8	49	12/90→07/92	1.781	B	M	4	8	PD	(-)COP	81522
	49	12/90→07/92	1.781	B	M	4	8	PD	(+)COP, CR	82080
1.9 D	44	09/90→04/03	1.896	D	M	4	8	1X	(-)COP	81522
	44	09/90→04/03	1.896	D	M	4	8	1X	(+)COP, CR	82080
	45	07/90→04/03	1.896	D	M	4	8	1X	(-)COP	81522
	45	07/90→04/03	1.896	D	M	4	8	1X	(+)COP, CR	82080
1.9 TD	50	10/92→04/03	1.896	D	M	4	8	ABL	(-)COP	81522
	50	10/92→04/03	1.896	D	M	4	8	ABL	(+)COP, CR	82080
2.0	62	07/90→04/03	1.968	B	M	4	8	AAC	(-)COP, 09-1990→	81522
	62	07/90→04/03	1.968	B	M	4	8	AAC	(+)COP, CR	82080
2.4 D	55	08/97→04/03	2.370	D	M	5	10	AJA		81701
	57	07/90→04/98	2.370	D	M	5	10	AAB	08-1995→, T→: F70.N.014.001	81701
	57	07/90→04/98	2.370	D	M	5	10	AAB	09-1990→, →07-1995, T→: F70.N.014.000, →T: F70-N-014.000	81772
2.4 D Syncro	57	10/92→09/98	2.370	D	M	5	10	AAB	08-1995→, T→: F70.N.014.001	81701
	57	10/92→09/98	2.370	D	M	5	10	AAB	09-1990→, →07-1995, T→: F70.N.014.000	81772
2.5	81	11/90→04/03	2.461	B	M	5	10	AAF, ACU, AEN, AEU	T→: F70.N.014.001, M: AEN, M: AEU, M: AEN	81701
	81	11/90→04/03	2.461	B	M	5	10	AAF, ACU, AEN, AEU	→T: F70.N.014.000	81772
	85	08/96→04/03	2.461	B	M	5	10	AET, APL, AVT		81701
2.5 Syncro	81	10/92→04/03	2.461	B	M	5	10	AAF, ACU, AEN, AEU	T→: F70.N.014.001, M: AEU, M: AEN, M: AEU	81701
	81	10/92→04/03	2.461	B	M	5	10	AAF, ACU, AEN, AEU	→T: F70.N.014.000	81772
	85	07/96→04/03	2.461	B	M	5	10	AET, APL, AVT		81701
2.5 TDI	65	05/98→04/03	2.461	D	M	5	10	AJT, AYY		81701
	75	09/95→04/03	2.461	D	M	5	10	ACV, AUF, AXL, AYC		81701
	111	05/98→04/03	2.461	D	M	5	10	AHY, AXG		81701
2.5 TDI Syncro	75	09/95→04/03	2.461	D	M	5	10	ACV, AXL		81701
2.8	103	05/96→05/00	2.792	B	M	6	12	AES		81773
2.8 Syncro	103	01/96→04/96	2.792	B	M	6	12	AES		81773
2.8 V6	150	04/00→04/03	2.792	B	M	6	24	AMV		81773
2.8 VR 6	103	11/95→04/00	2.792	B	M	6	12	AES		81773
<b>TRANSPORTER V</b>										
1.9 TDI	62	01/06→	1.896	D	M	4	8	BRR		81791
	63	04/03→	1.896	D	M	4	8	AXC		81791
	75	06/06→	1.896	D	M	4	8	BRS		81791
	77	04/03→	1.896	D	M	4	8	AXB		81791
2.0	85	11/03→	1.984	B	M	4	8	AXA		81703
2.5	120	11/03→	2.461	D	M	5	10	BLJ		82033
	128	05/03→	2.459	D	M	5	10	AXE		82033
2.5 4motion	96	06/06→	2.459	D	M	5	10	AXD		82033
	128	08/04→	2.459	D	M	5	10	AXE		82033

	kW		Cap. cm3	Fuel	Gear	No. of cyl.	No. of valves	Motor code		Short
--	----	--	----------	------	------	-------------	---------------	------------	--	-------

## VOLKSWAGEN

### TRANSPORTER V

2.5 TDI	96	04/03→	2.461	D	M	5	10	AXD		82033
	128	04/03→	2.461	D	M	5	10	AXE		82033
2.5 TDi 4motion	96	10/03→	2.459	D	M	5	10			82033
	96	07/04→	2.461	D	M	5	10	AXD		82033
	128	05/03→	2.459	D	M	5	10			82033
	128	04/04→	2.461	D	M	5	10	AXE, BPC		82033
2.5 TDi PF	96	06/06→	2.459	D	M	5	10	AXD		82033
3.2 4motion	170	11/03→06/06	3.189	B	M	6	24	BDL		81866
	173	11/03→	3.189	B	M	6	24	BKK		81866
3.2 V6	170	04/03→06/04	3.189	B	M	6	24	BDL		81866
	173	08/03→	3.189	B	M	6	24	BKK		81866

### VENTO

1.4	40	11/91→09/98	1.390	B	M	4	8	ABD, AEX	M: ABD	81524
	40	11/91→09/98	1.390	B	M	4	8	ABD, AEX	M: AEX	81527
	44	11/91→09/98	1.390	B	M	4	8	ABD, AEX	M: ABD	81524
	44	11/91→09/98	1.390	B	M	4	8	ABD, AEX	M: AEX	81527
1.6	55	09/92→09/98	1.598	B	M	4	8	ABU, AEA, AEE	M: ABU	81524
	55	09/92→09/98	1.598	B	M	4	8	ABU, AEA, AEE	M: AEE, M: AEA	81527
	74	10/94→09/98	1.595	B	M	4	8	AEK, AFT	(-)COP	81522
	74	10/94→09/98	1.595	B	M	4	8	AEK, AFT	(+)COP, CR	82080
1.8	55	11/91→09/98	1.781	B	M	4	8	AAM	(-)COP	81522
	55	11/91→09/98	1.781	B	M	4	8	AAM	(+)COP, CR	82080
	66	11/91→09/98	1.781	B	M	4	8	ABS, ADZ	(-)COP	81522
	66	11/91→09/98	1.781	B	M	4	8	ABS, ADZ	(+)COP, CR	82080
1.9 D	48	11/91→09/98	1.896	D	M	4	8	1Y	(-)COP	81522
	48	11/91→09/98	1.896	D	M	4	8	1Y	(+)COP, CR	82080
1.9 SDI	47	04/97→09/98	1.896	D	M	4	8	AEY	(-)COP	81522
	47	04/97→09/98	1.896	D	M	4	8	AEY	(+)COP, CR	82080
1.9 TD	55	11/91→09/98	1.896	D	M	4	8	AAZ	(-)COP	81522
	55	11/91→09/98	1.896	D	M	4	8	AAZ	(+)COP, CR	82080
1.9 TDI	66	09/93→09/98	1.896	D	M	4	8	1Z, AHU, ALE	(-)COP	81522
	66	09/93→09/98	1.896	D	M	4	8	1Z, AHU, ALE	(+)COP, CR	82080
	81	04/96→09/98	1.896	D	M	4	8	AFN	(-)COP	81522
	81	04/96→09/98	1.896	D	M	4	8	AFN	(+)COP, CR	82080
2.0	85	11/91→09/98	1.984	B	M	4	8	2E, ADY, AGG, AKR	(-)COP	81522
	85	11/91→09/98	1.984	B	M	4	8	2E, ADY, AGG, AKR	(+)COP, CR	82080
2.0 GL	62	11/91→07/98	1.968	B	M	4	8	AAC	(-)COP	81522
	62	11/91→07/98	1.968	B	M	4	8	AAC	(+)COP, CR	82080
	79	05/96→12/97	1.984	B	M	4	8	AEP	(-)COP	81522
	79	05/96→12/97	1.984	B	M	4	8	AEP	(+)COP, CR	82080
2.8 VR6	120	08/95→04/96	2.792	B	M	6	12	AAA		81773
	128	01/92→09/98	2.792	B	M	6	12	AAA		81773

	kw		Cap. cm3	Fuel	Gear	No. of cyl.	No. of valves	Motor code		Short
--	----	--	----------	------	------	-------------	---------------	------------	--	-------

## VOLVO

### 240, STATION WAGON

2.0	60	08/74→07/76	1.986	B	M	4	8	B20A		81592
	66	08/76→01/82	1.986	B	M	4	8	B19A		81592
	71	09/78→12/84	1.986	B	M	4	8	B19A, B19K	01-1975→, →12-1982	81592
	76	08/84→07/85	1.986	B	M	4	8	B200K		81594
	86	08/83→07/93	1.986	B	M	4	8	B200E		81594
	100	10/82→08/84	1.986	B	M	4	8	B19ET		81592
2.1	71	08/74→07/75	2.127	B	M	4	8	B21A		81592
	74	08/75→07/80	2.127	B	M	4	8	B21A		81592
	79	08/80→07/84	2.127	B	M	4	8	B21A		81592
	80	08/80→07/84	2.127	B	M	4	8	B21F		81592
	86	01/77→08/78	2.127	B	M	4	8	B21E		81592
	90	08/74→07/80	2.127	B	M	4	8	B21E		81592
2.1 Turbo	114	08/80→07/85	2.127	B	M	4	8	B21ET		81592
2.3	81	08/84→07/86	2.315	B	M	4	8	B230A		81594
	82	08/80→07/84	2.315	B	M	4	8	B23A		81592
	83	08/86→07/87	2.315	B	M	4	8	B230F	09-1984→, →12-1993	81594
	83	08/86→07/87	2.316	B	M	4	8	B230F		81594
	85	08/86→12/88	2.316	B	M	4	8	B230K		81594
	96	08/83→07/85	2.316	B	M	4	8	B230E	09-1984→, →12-1993	81594
	98	08/84→12/89	2.316	B	M	4	8	B23E	01-1979→, →12-1984	81592
	98	08/84→12/88	2.316	B	M	4	8	B23E		81594
	100	08/80→12/84	2.316	B	M	4	8	B23E	01-1979→, →12-1984	81592
	103	08/78→07/80	2.316	B	M	4	8	B23E	01-1979→, →12-1984	81592
2.3 Cat.	100	08/91→07/92	2.316	B	M	4	8	B230F		81594
2.3 i Cat.	85	08/86→07/93	2.316	B	M	4	8	B230F	09-1984→, →12-1993	81594
2.4 Diesel	58	08/87→08/93	2.383	D	M	6	12	D24	01-1979→, →12-1993	81593
	60	08/78→08/93	2.383	D	M	6	12	D24	01-1979→, →12-1993	81593

### 440

1.6	61	09/88→12/96	1.596	B	M	4	8	B16F		81574
1.7	64	09/88→12/96	1.721	B	M	4	8	B18KP		81574
	70	08/88→07/89	1.721	B	M	4	8	B18F		81574
	75	08/89→12/96	1.721	B	M	4	8	B18FP		81574
	78	09/88→12/96	1.721	B	M	4	8	B18EP		81574
	88	08/88→07/96	1.721	B	M	4	8	B18FT		81574
1.7 Turbo	90	01/91→12/96	1.721	B	M	4	8	B18FT		81574
1.8	66	09/95→12/96	1.783	B	M	4	8	B18U		81574
	66	08/91→07/96	1.794	B	M	4	8	B18U		81574
1.9 Turbo-Diesel	66	07/94→12/96	1.870	D	M	4	8	D19T		81574
2.0	80	08/93→07/96	1.998	B	M	4	8	B20F		81574
	81	08/92→07/95	1.998	B	M	4	8	B20F		81574

### 460

1.6	61	07/92→07/96	1.596	B	M	4	8	B16F		81574
1.7	64	09/88→07/96	1.721	B	M	4	8	B18KP		81574
	66	09/90→07/96	1.721	B	M	4	8	B18KP		81574
	75	08/89→07/92	1.721	B	M	4	8	B18EP		81574
	80	08/89→07/92	1.721	B	M	4	8	B18EP		81574

	kw		Cap. cm3	Fuel	Gear	No. of cyl.	No. of valves	Motor code		MAGNETI MARELLI Short
<b>VOLVO</b>										
1.7 Turbo	88	08/89→07/96	1.721	B	M	4	8	B18FT		81574
	90	01/91→07/96	1.721	B	M	4	8	B18FT		81574
1.8	66	08/91→07/96	1.794	B	M	4	8	B18U		81574
1.9 Turbo-Diesel	66	07/94→07/96	1.870	D	M	4	8	D19T		81574
2.0	80	08/93→07/96	1.998	B	M	4	8	B20F		81574
	81	08/92→07/95	1.998	B	M	4	8	B20F		81574
<b>480</b>										
1.7	70	08/87→07/89	1.721	B	M	4	8	B18F		81574
	75	08/89→07/96	1.721	B	M	4	8	B18EP		81574
	78	04/86→07/89	1.721	B	M	4	8	B18E		81574
	80	08/86→07/88	1.721	B	M	4	8	B18E		81574
1.7 Turbo	88	08/87→07/96	1.721	B	M	4	8	B18FT		81574
	90	01/91→07/96	1.721	B	M	4	8	B18FT		81574
2.0	81	08/92→09/95	1.998	B	M	4	8	B20F		81574
<b>850, STATION WAGON</b>										
2.0	93	08/94→12/96	1.984	B	M	5	10	B5202S		82056
	105	06/91→12/96	1.984	B	M	5	10	B5204F		82056
2.0 Turbo	132	09/93→10/97	1.984	B	M	5	20	B5204T2		82056
	155	02/93→12/96	1.984	B	M	5	20	B5204FT, B5204T		82056
2.3	106	01/96→10/96	2.319	B	M	5	20	B5234FS		82056
2.3 T5	166	02/93→12/96	2.319	B	M	5	20	B5234FT		82056
2.3 T5 R	176	04/96→10/96	2.319	B	M	5	20	B5234T2		82056
	184	08/95→12/96	2.319	B	M	5	20	B5234T4		82056
2.3 Turbo R	177	06/95→10/97	2.319	B	M	5	20	B5234T5		82056
2.4 GLE	142	09/93→10/97	2.435	B	M	5	20	B5254T		82056
2.5	103	06/91→07/94	2.435	B	M	5	10	B5252		82056
	106	08/94→12/96	2.435	B	M	5	10	B5252S		82056
	125	08/91→12/96	2.435	B	M	5	20	B5254S		82056
2.5 AWD	142	04/96→12/96	2.435	B	M	5	20	B5254T		82056
2.5 TDI	103	08/95→12/96	2.461	D	M	5	10	D5252T		81701
<b>940 I, STATION WAGON</b>										
2.0	82	01/92→07/94	1.986	B	M	4	8	B200F		81594
	89	09/90→09/93	1.986	B	M	4	8	B200G		81594
	102	09/90→09/93	1.986	B	M	4	16	B204FT		81594
2.0 GL	103	09/90→04/92	1.986	B	M	4	16	B204E		81594
2.0 Turbo	114	08/90→07/95	1.986	B	M	4	8	B200FT		81594
2.3	85	08/92→07/94	2.316	B	M	4	8	B230FD		81594
	96	08/90→12/94	2.316	B	M	4	8	B230FB, B230G		81594
	114	08/90→07/91	2.316	B	M	4	16	B234F, B234G		81594
2.3 Turbo	121	08/90→07/94	2.316	B	M	4	8	B230FT		81594
	140	08/91→07/93	2.316	B	M	4	8	B230FT+		81594
2.4 D	60	08/90→07/95	2.383	D	M	6	12	D24		81593
2.4 TD Intercooler	90	08/90→12/94	2.383	D	M	6	12	D24TIC	→06-1992, →T: 30.003	81593
	90	08/90→12/94	2.383	D	M	6	12	D24TIC	07-1992→, T→: 30.004	81701
2.4 Turbo Diesel	80	08/90→12/94	2.383	D	M	6	12	D24T		81593

	kw		Cap. cm3	Fuel	Gear	No. of cyl.	No. of valves	Motor code		Short
--	----	--	----------	------	------	-------------	---------------	------------	--	-------

## VOLVO

### 940 II, STATION WAGON

2.0	89	11/94→12/95	1.986	B	M	4	8	B200G		81594
	102	10/94→05/97	1.986	B	M	4	16	B204FT		81594
2.0 GLT	139	10/94→05/97	1.986	B	M	4	8	B200GT		81594
2.0 Turbo	114	04/96→10/98	1.986	B	M	4	8	B200FT		81594
2.3	85	08/94→07/95	2.316	B	M	4	8	B230FD		81594
	96	08/94→10/98	2.316	B	M	4	8	B230FB		81594
	113	10/94→05/97	2.316	B	M	4	8	B230GK		81594
2.3 ti	99	01/95→10/98	2.316	B	M	4	8	B230FK		81594
2.3 Turbo	121	08/94→10/98	2.316	B	M	4	8	B230FT		81594
	126	08/95→10/98	2.316	B	M	4	8	B230FT		81594
2.4 TD Interc.	90	08/94→10/98	2.383	D	M	6	12	D24TIC		81701

### 960 I, STATION WAGON

2.0	103	09/90→08/93	1.986	B	M	4	16	B204E		81594
	140	08/90→09/93	1.986	B	M	4	16	B204FT		81594
2.3 Turbo	121	09/90→08/93	2.316	B	M	4	8	B230FT		81594
2.4 TD Interc.	85	09/91→07/94	2.383	D	M	6	12	D24TIC	→06-1992, →T: 30.003	81593
	85	09/91→07/94	2.383	D	M	6	12	D24TIC	07-1992→, T→: 30.004	81701
2.9	150	08/90→07/94	2.922	B	M	6	24	B6304F, B6304S		81857

### 960 II, STATION WAGON

2.5	125	07/94→12/96	2.473	B	M	6	24	B6254S	07-1994→, →10-1996	81857
2.9	150	07/94→12/96	2.922	B	M	6	24	B6304S		81857

### C30

1.6	74	10/06→	1.596	B	M	4	16	B4164S3		81598
1.6 D	80	10/06→	1.560	D	M	4	16	D4164T		81869
1.8	92	10/06→	1.798	B	M	4	16	B4184S11		81804
1.8 FlexFuel	92	01/07→	1.798	FF	M	4	16	B4184S8		81804
2.0	107	10/06→	1.999	B	M	4	16	B4204S3		81804
2.0 D	100	10/06→	1.998	D	M	4	16	D4204T		81800
2.0 FlexFuel	107	01/10→	1.999	FF	M	4	16	B4204S4		81804
2.4 D5	120	10/06→	2.400	D	M	5	20	D5244T9		81864
2.4 i	125	10/06→	2.435	B	M	5	20	B5244S4		82056
D5	132	10/06→	2.400	D	M	5	20	D5244T8		81864
T5	162	10/06→	2.521	B	M	5	20	B5254T3		82056
	169	03/07→	2.521	B	M	5	20	B5254T7		82056

### C70 I CABRIO, COUPÉ

2.0	132	03/97→10/05	1.984	B	M	5	20	B5204T2		82056
2.0 T	120	03/00→10/05	1.984	B	M	5	20	B5204T4		82056
	166	03/97→10/05	1.984	B	M	5	20	B5204T3		82056
2.3 T5	176	03/97→10/05	2.319	B	M	5	20	B5234T3		82056
	180	07/02→10/05	2.319	B	M	5	20	B5234T9		82056
2.4 T	147	07/02→10/05	2.435	B	M	5	20	B5244T7		82056
2.5	121	03/99→09/02	2.435	B	M	5	20	B5254S		82056
	125	06/98→10/05	2.435	B	M	5	20	B5254S		82056
2.5 T	142	03/97→10/05	2.435	B	M	5	20	B5244T, B5254T		82056



	kw		Cap. cm3	Fuel	Gear	No. of cyl.	No. of valves	Motor code		MAGNETI MARELLI Short
--	----	--	----------	------	------	-------------	---------------	------------	--	-----------------------

## VOLVO

### C70 II CABRIO

2.0 D	100	01/08→	1.997	D	M	4	16	D4204T		81800
2.4	103	03/06→	2.435	B	M	5	20	B5244S5		82056
2.4 i	125	03/06→	2.435	B	M	5	20	B5244S4		82056
D5	132	03/06→	2.400	D	M	5	20	D5244T8		81864
T5	162	03/06→	2.521	B	M	5	20	B5254T3		82056
	169	03/07→	2.521	B	M	5	20	B5254T7		82056

### S 40 I

1.6	77	09/95→08/99	1.588	B	M	4	16	B4164S		82056
	80	03/99→12/03	1.587	B	M	4	16	B4164S2		82056
1.8	85	07/95→08/99	1.731	B	M	4	16	B4184S, B4184S3		82056
	85	06/01→08/03	1.783	G	M	4	16			82056
	90	03/99→12/03	1.783	B	M	4	16	B4184S2, B4184S9		82056
1.8 i	90	06/01→12/03	1.834	B	M	4	16	B4184SJ		82056
1.9 DI	70	03/99→07/00	1.870	D	M	4	8	D4192T2		81574
	75	07/00→12/03	1.870	D	M	4	8	D4192T4		81814
	85	07/00→12/03	1.870	D	M	4	8	D4192T3		81814
1.9 T4	147	05/97→07/00	1.855	B	M	4	16	B4194T, B4194T2		82056
1.9 TD	66	07/95→08/99	1.870	D	M	4	8	D4192T	01-1997→	81574
2.0	100	07/95→12/03	1.948	B	M	4	16	B4204S, B4204S2		82056
	103	07/95→08/99	1.948	B	M	4	16	B4204S		82056
2.0 T	118	10/97→07/00	1.948	B	M	4	16	B4204T		82056
	120	06/01→12/03	1.948	B	M	4	16	B4204T3		82056
	121	07/00→06/01	1.948	B	M	4	16	B4204T3		82056
2.0 T4	147	07/00→12/03	1.948	B	M	4	16	B4204T5		82056

### S40 II

1.6	74	01/05→	1.596	B	M	4	16	B4164S3		82056
1.6 D	81	01/05→	1.560	D	M	4	16	D4164T		81869
1.8	92	04/04→	1.798	B	M	4	16	B4184S11		82056
1.8 FlexFuel	92	01/06→	1.798	FF	M	4	16	B4184S8		82056
2.0	107	03/06→	1.999	B	M	4	16	B4204S3		81804
2.0 D	100	01/04→	1.998	D	M	4	16	D4204T		81800
2.0 D4	96	07/05→	1.998	D	M	4	16	D4204T2		81800
2.4	103	01/04→	2.435	B	M	5	20	B5244S5		82056
	125	01/04→	2.435	B	M	5	20	B5244S		82056
	132	03/06→	2.400	D	M	5	20	D5244T8		81864
2.4 AWD	125	08/06→	2.435	B	M	5	20	B5244S4		82056
T5	162	01/04→	2.521	B	M	5	20	B5254T3		82056
	169	03/07→	2.521	B	M	5	20	B5254T7		82056
T5 AWD	162	04/04→	2.521	B	M	5	20	B5254T3		82056
	169	03/07→	2.521	B	M	5	20	B5254T7		82056

### S60 I

2.0 T	132	09/01→	1.984	B	M	5	20	B5204T5		82056
2.3 T5	195	07/00→09/02	2.319	B	M	5	20	B5234T7		82056
2.4	103	11/00→	2.435	B	AM	5	20	B5244S2		82056
	125	11/00→	2.435	B	AM	5	20	B5244S		82056

	kw		Cap. cm3	Fuel	Gear	No. of cyl.	No. of valves	Motor code		Short
--	----	--	----------	------	------	-------------	---------------	------------	--	-------

## VOLVO

### S60 I

2.4 AWD	191	02/04→	2.401	B	M	5	20	B5244T5		82056
2.4 Bifuel	103	06/02→	2.435	BF	M	5	20	B5244SG2		82056
2.4 D	93	09/05→	2.401	D	M	5	20	D5244T7		81864
	96	12/01→	2.401	D	M	5	20	D5244T2		81864
2.4 D5	120	07/01→	2.401	D	M	5	20	D5244T		81864
	136	09/05→	2.401	D	M	5	20	D5244T4		81864
2.4 T	147	11/00→	2.435	B	M	5	20	B5244T3		82056
2.4 T AWD	147	11/01→	2.435	B	M	5	20	B5244T3		82056
2.4 T5	191	04/04→	2.401	B	M	5	20	B5244T5		82056
2.5 T	154	02/04→	2.521	B	M	5	20	B5254T2		82056
2.5 T AWD	154	04/04→	2.521	B	M	5	20	B5254T2		82056
R 2,5 T AWD	221	03/03→	2.521	B	M	5	20	B5254T4		82056
T5	184	11/00→	2.319	B	AM	5	20	B5234T3		82056

### S60 II

2.0 T	149	04/10→	1.999	B	M	4	16	B4204T6		81804
D3	120	04/10→	1.984	D	M	5	20	D5204T2		81864
D5	151	04/10→	2.400	D	M	5	20	D5244T10		81864
D5 AWD	151	04/10→	2.400	D	M	5	20	D5244T10		81864
T6 AWD	224	04/10→	2.953	B	M	6	24	B6304T4		81804

### S70

2.0	93	01/97→11/00	1.984	B	M	5	10	B5202S		82056
	105	01/97→11/00	1.984	B	M	5	10	B5204F		82056
	120	01/97→11/00	1.984	B	M	5	20	B5204T4		82056
	132	01/97→11/00	1.984	B	M	5	20	B5204T2		82056
2.0 Turbo	155	01/97→11/00	1.984	B	M	5	20	B5204T		82056
	166	01/97→11/00	1.984	B	M	5	20	B5204T3		82056
2.3	195	04/99→09/00	2.319	B	M	5	20	B5234T7		82056
2.3 AWD	195	04/99→09/00	2.319	B	M	5	20	B5234T7		82056
2.3 T-5	176	01/97→11/00	2.319	B	M	5	20	B5234T3		82056
2.3 T5 GLT AWD	177	11/96→09/98	2.319	B	M	5	20	B5234T3		82056
2.3 T5 R AWD	176	11/96→09/98	2.319	B	M	5	20	B5234T2		82056
2.3 T5 Sport	177	11/96→09/98	2.319	B	M	5	20	B5234T3		82056
2.3 T5 Sport AWD	184	07/97→09/00	2.319	B	M	5	20	B5234T4		82056
2.3 Turbo	184	01/97→11/00	2.319	B	M	5	20	B5234FT+		82056
2.4	103	08/99→11/00	2.435	B	M	5	20	B5244S2		82056
	125	01/97→11/00	2.435	B	M	5	20	B5254S		82056
2.4 AWD	103	04/99→09/00	2.435	B	M	5	20	B5244S2		82056
	106	11/96→05/99	2.435	B	M	5	10	B5252FS		82056
	121	10/98→05/99	2.435	B	M	5	20			82056
	125	04/99→09/00	2.435	B	M	5	20	B5244S		82056
2.4 Blu-Fuel	103	07/97→09/00	2.435	G	M	5	20	B5244SG		82056
2.4 T5 Sport AWD	142	11/96→04/99	2.435	B	M	5	20	B5254T		82056
2.4 Turbo	142	01/97→11/00	2.435	B	M	5	20	B5244T, B5254T		82056
2.5	106	01/97→11/00	2.435	B	M	5	10	B5252S		82056
	121	06/98→11/00	2.435	B	M	5	20	B5254S		82056

	kW		Cap. cm3	Fuel	Gear	No. of cyl.	No. of valves	Motor code		Short
--	----	--	----------	------	------	-------------	---------------	------------	--	-------

## VOLVO

<b>S70</b>										
2.5 Bifuel	103	07/99→11/00	2.435	BF	A	5	20	B5244SG		82056
	106	10/98→11/00	2.435	BF	M	5	10	GB5252S		82056
2.5 TDI	103	01/97→11/00	2.461	D	M	5	10	D5252T		81701
<b>S80 I</b>										
2.0	120	06/98→07/06	1.984	B	M	5	20	B5204T4		82056
2.0 T	132	12/99→07/06	1.984	B	M	5	20	B5204T5		82056
	166	06/98→07/06	1.984	B	M	5	20	B5204T3		82056
2.3 R	195	04/00→08/05	2.319	B	M	5	20	B5234T7		82056
2.4	103	01/99→07/06	2.435	B	M	5	20	B5244S2		82056
	125	01/99→07/06	2.435	B	M	5	20	B5244S		82056
2.4 Bifuel	103	09/01→07/06	2.435	BF	M	5	20	B5244SG2		82056
2.4 D	96	10/01→07/06	2.401	D	M	5	20	D5244T2		81864
2.4 D5	120	08/01→07/06	2.401	D	M	5	20	D5244T		81864
2.4 LTP	132	06/04→07/06	2.435	B	M	5	20	B5244T4		82056
2.4 T	147	06/00→07/06	2.435	B	M	5	20	B5244T3		82056
2.4 T5 AWD	147	04/00→09/03	2.435	B	M	5	20	B5244T3		82056
2.5 T	154	03/03→07/06	2.521	B	M	5	20	B5254T2		82056
2.5 T AWD	154	07/03→07/06	2.521	B	M	5	20	B5254T2		82056
2.5 TDI	103	01/99→07/06	2.461	D	M	5	10	D5252T	→12-2002	81701
2.8 T6	200	05/98→07/06	2.783	B	M	6	24	B6284T	→12-2002	81779
	200	05/98→07/06	2.783	B	M	6	24	B6284T	01-2003→	81864
2.9	147	03/99→07/06	2.922	B	M	6	24	B6294S	→12-2002	81779
	147	03/99→07/06	2.922	B	M	6	24	B6294S	01-2003→	81864
	150	05/98→07/06	2.922	B	M	6	24	B6304S3	→12-2002	81779
	150	05/98→07/06	2.922	B	M	6	24	B6304S3	01-2003→	81864
3.0	144	06/01→07/06	2.922	B	M	6	24	B6294S2	→12-2002	81779
	144	06/01→07/06	2.922	B	M	6	24	B6294S2	01-2003→	81864
3.0 T6	200	06/01→07/06	2.922	B	M	6	24	B6294T	→12-2002	81779
	200	06/01→07/06	2.922	B	M	6	24	B6294T	01-2003→	81864
<b>S80 II</b>										
1.6 D DRIVe	80	01/10→	1.560	D	M	4	16	D4164T		81869
2.0	107	01/08→	1.999	B	M	4	16	B4204S3		81804
2.0 FlexFuel	107	01/08→	1.999	FF	M	4	16	B4204S4		81804
2.0 T	149	01/10→	1.999	B	M	4	16	B4204T6		81804
2.0 TDi	100	02/08→	1.998	D	M	4	16	D4204T		81800
2.4 D	120	03/06→	2.400	D	M	5	20	D5244T, D5244T5		81864
	129	01/10→	2.400	D	M	5	20	D5244T14		81864
2.4 D5	136	03/06→	2.400	D	M	5	20	D5244T4		81864
2.4 D5 AWD	136	01/07→	2.400	D	M	5	20	D5244T4		81864
2.5 T	147	03/06→	2.521	B	M	5	20	B5254T6		82056
	170	01/10→	2.521	B	M	5	20	B5254T10		82056
2.5 T AWD	147	10/06→	2.521	B	M	5	20	B5254T6		82056
2.5 T FlexFuel	147	05/08→	2.521	FF	M	5	20	B5254T8		82056
	170	01/10→	2.521	FF	M	5	20	B5254T11		82056
D5	151	01/10→	2.400	D	M	5	20	D5244T10		81864
D5 AWD	151	01/10→	2.400	D	M	5	20	D5244T10		81864

	kw		Cap. cm3	Fuel	Gear	No. of cyl.	No. of valves	Motor code		MAGNETI MARELLI Short
--	----	--	----------	------	------	-------------	---------------	------------	--	-----------------------

## VOLVO

### S90

2.9	132	01/97→05/98	2.922	B	M	6	24	B6304S2	11-1996→	81857
	150	01/97→05/98	2.922	B	M	6	24	B6304G		81857

### V40 STATION WAGON

1.6	77	12/95→08/99	1.588	B	M	4	16	B4164S		82056
	80	03/99→06/04	1.587	B	M	4	16	B4164S2		82056
1.8	85	07/95→08/99	1.731	B	M	4	16	B4184S, B4184S3		82056
	90	03/99→06/04	1.783	B	M	4	16	B4184S2, B4184S9		82056
1.8 Bi-Fuel	88	11/99→08/03	1.783	B	M	4	16	B4184S9		82056
1.8 Blu-Fuel	85	06/01→08/03	1.783	G	M	4	16			82056
1.8 i	90	06/01→06/04	1.834	B	M	4	16	B4184SJ		82056
1.9 DI	70	03/99→07/00	1.870	D	M	4	8	D4192T2		81574
	75	07/00→06/04	1.870	D	M	4	8	D4192T4		81814
	85	07/00→06/04	1.870	D	M	4	8	D4192T3		81814
1.9 T4	147	05/97→07/00	1.855	B	M	4	16	B4194T		82056
1.9 TD	66	07/95→08/99	1.870	D	M	4	8	D4192T		81574
2.0	100	07/95→06/04	1.948	B	M	4	16	B4204S		82056
	103	07/95→08/99	1.948	B	M	4	16	B4204S		82056
2.0 D	100	12/02→06/04	1.998	D	M	4	16	D4204T		81800
2.0 T	118	10/97→07/00	1.948	B	M	4	16	B4204T		82056
	120	06/01→06/04	1.948	B	M	4	16	B4204T3		82056
	121	07/99→06/01	1.948	B	M	4	16	B4204T2		82056
2.0 T4	147	07/00→06/04	1.948	B	M	4	16	B4204T5		82056

### V50

1.6	74	01/05→	1.596	B	M	4	16	B4164S3		81598
1.6 D	81	01/05→	1.560	D	M	4	16	D4164T		81869
1.8	92	04/04→	1.798	B	M	4	16	B4184S11		81804
1.8 FlexFuel	92	01/05→	1.798	FF	M	4	16	B4184S8		81804
2.0	107	10/06→	1.999	B	M	4	16	B4204S3		81804
2.0 D	100	04/04→	1.998	D	M	4	16	D4204T		81800
2.0 FlexFuel	107	01/10→	1.999	FF	M	4	16	B4204S4		81804
2.4	103	04/04→	2.435	B	M	5	20	B5244S5		82056
	125	04/04→	2.435	B	M	5	20	B5244S		82056
	132	03/06→	2.400	D	M	5	20	D5244T8		81864
2.4 AWD	125	08/06→	2.435	B	M	5	20	B5244S4		82056
2.4 Tdi	120	05/07→	2.400	D	M	5	20	D5244T9		81864
D2	84	01/10→	1.560	D	M	4	16	D4162T		81869
T5	162	04/04→	2.521	B	M	5	20	B5254T3		82056
	169	03/07→	2.521	B	M	5	20	B5254T7		82056
T5 AWD	162	04/04→	2.521	B	M	5	20	B5254T3		82056
	169	03/07→	2.521	B	M	5	20	B5254T7		82056

### V70 I STATION WAGON

2.0	93	01/97→03/00	1.984	B	M	5	10	B5202S		82056
	105	01/97→03/00	1.984	B	M	5	10			82056
	120	01/97→03/00	1.984	B	M	5	20	B5204T4		82056
	132	01/97→03/00	1.984	B	M	5	20	B5204T2		82056

	kw		Cap. cm3	Fuel	Gear	No. of cyl.	No. of valves	Motor code		MAGNETI MARELLI Short
--	----	--	----------	------	------	-------------	---------------	------------	--	-----------------------

## VOLVO

### V70 I STATION WAGON

2.0 Turbo	155	01/97→03/00	1.984	B	M	5	20	B5204T		82056
	166	01/97→03/00	1.984	B	M	5	20	B5204T3		82056
2.0 Turbo AWD	166	01/97→03/00	1.984	B	M	5	20	B5204T3		82056
2.3 AWD	195	12/98→02/00	2.319	B	M	5	20	B5234T7, B5234T8		82056
2.3 T AWD	184	04/97→03/00	2.319	B	M	5	20	B5234FT+		82056
2.3 T-5	176	01/97→03/00	2.319	B	M	5	20	B5234T3		82056
2.3 T-5 AWD	176	01/97→03/00	2.319	B	M	5	20	B5234T3		82056
2.3 Turbo	184	01/97→03/00	2.319	B	M	5	20	B5234FT+		82056
2.4	103	08/99→05/00	2.435	B	M	5	20	B5244S2		82056
	125	01/97→05/00	2.435	B	M	5	20	B5254S		82056
2.4 Bifuel	103	08/99→03/00	2.435	BF	M	5	20	B5244SG		82056
2.4 Turbo	142	01/97→03/00	2.435	B	M	5	20	B5244T, B5254T		82056
2.5	106	01/97→03/00	2.435	B	M	5	10	B5252S		82056
	121	06/98→03/00	2.435	B	M	5	20	B5254S		82056
2.5 AWD	195	03/99→03/00	2.435	B	M	5	10			82056
2.5 Bifuel	106	10/98→08/99	2.435	BF	M	5	10	GB5252S		82056
2.5 TDI	103	01/97→05/00	2.461	D	M	5	10	D5252T		81701
2.5 Turbo AWD	142	01/97→05/00	2.435	B	M	5	20	B5244T, B5254T		82056

### V70 II STATION WAGON

2.0 T	132	07/01→	1.984	B	M	5	20	B5204T5		82056
2.3 AWD	195	10/00→09/04	2.319	B	M	5	20	B5234T7, B5234T8		82056
2.3 T5	184	03/00→	2.319	B	M	5	20	B5234T3		82056
2.4	103	03/00→	2.435	B	M	5	20	B5244S2		82056
	121	03/00→09/03	2.435	B	M	5	20			82056
	125	03/00→	2.435	B	M	5	20	B5244S		82056
2.4 Bifuel	103	09/01→	2.435	BF	AM	5	20	B5244SG		82056
2.4 D	93	05/05→	2.400	D	M	5	25			81864
	96	12/01→	2.401	D	M	5	20	D5244T2		81864
2.4 D5	120	08/01→	2.401	D	M	5	20	D5244T		81864
	136	12/05→	2.401	D	M	5	20	D5244T4		81864
2.4 D5 AWD	120	03/03→	2.401	D	M	5	20	D5244T2		81864
	136	12/05→	2.401	D	M	5	20	D5244T4		81864
2.4 T	147	03/00→	2.435	B	M	5	20	B5244T3		82056
2.4 T AWD	147	09/01→	2.435	B	M	5	20	B5244T3		82056
2.4 T5	191	04/04→	2.401	B	M	5	20	B5244T5		82056
2.5 R Sport	221	12/02→	2.521	B	M	5	20	B5254T4		82056
2.5 T	154	04/04→	2.521	B	M	5	20	B5254T2		82056
2.5 T AWD	154	09/02→	2.521	B	M	5	20	B5254T2		82056
R 2,5 T AWD	221	03/03→	2.521	B	M	5	20	B5254T4		82056

### V70 III STATION WAGON

1.6 D	80	01/10→	1.560	D	M	4	16	D4164T		81869
2.0	107	10/07→	1.999	B	M	4	16	B4204S3		81804
2.0 D	100	10/07→	1.997	D	M	4	16	D4204T		81800
2.0 FlexFuel	107	01/08→	1.999	FF	M	4	16	B4204S4		81804
2.0 T	149	01/10→	1.999	B	M	4	16	B4204T6		81804

	kW		Cap. cm3	Fuel	Gear	No. of cyl.	No. of valves	Motor code		MAGNETI MARELLI Short
--	----	--	----------	------	------	-------------	---------------	------------	--	-----------------------

## VOLVO

### V70 III STATION WAGON

2.4 D	120	08/07→	2.400	D	M	5	20	D5244T5		81864
	129	10/09→	2.400	D	M	5	20	D5244T14		81864
2.4 D5	136	08/07→	2.400	D	M	5	20	D5244T4		81864
	151	12/09→	2.400	D	M	5	20	D5244T10		81864
2.4 D5 AWD	136	10/07→	2.400	D	M	5	20	D5244T4		81864
	151	12/09→	2.400	D	M	5	20	D5244T10		81864
2.5 T	147	08/07→	2.521	B	M	5	20	B5254T6		82056
	170	01/10→	2.521	B	M	5	20	B5254T10		82056
2.5 T FlexFuel	147	05/08→	2.521	FF	M	5	20	B5254T8		82056
	170	10/09→	2.521	FF	M	5	20	B5254T11		82056

### V90 STATION WAGON

2.9	132	01/97→12/98	2.922	B	M	6	24	B6304S2		81857
	150	01/97→12/98	2.922	B	M	6	24	B6304G		81857

### XC 60

2.0 T	149	03/10→	1.999	B	M	4	16	B4204T6		81804
2.4 D	120	05/08→	2.400	D	M	5	20	D5244T16		82056
2.4 D5	136	05/08→	2.400	D	M	5	20	D5244T4		82056
D5 AWD	151	07/09→	2.400	D	M	5	20	D5244T10		81864

### XC 70 I CROSS COUNTRY

2.4 AWD	121	03/00→09/03	2.435	B	M	5	20			82056
2.4 D5 AWD	136	12/05→	2.401	D	M	5	20	D5244T4		81864
2.4 D5 XC AWD	120	09/02→	2.401	D	M	5	20	D5244T		81864
2.4 T XC AWD	147	03/00→09/02	2.435	B	M	5	20	B5244T3		82056
2.5 T XC AWD	154	09/02→	2.521	B	M	5	20	B5254T2		82056

### XC 70 II

2.4 D	129	01/10→	2.400	D	M	5	20	D5244T14		81864
2.4 D AWD	120	08/07→	2.400	D	M	5	20	D5244T5		81864
2.4 D5 AWD	136	08/07→	2.401	D	M	5	20	D5244T4		81864
	151	12/09→	2.400	D	M	5	20	D5244T10		81864

### XC 90

2.5 T	154	10/02→	2.521	B	M	5	20	B5254T2		82056
D5	120	04/09→	2.400	D	M	5	20	D5244T5		81864
	120	10/02→	2.401	D	M	5	20	D5244T		81864
	136	05/06→	2.401	D	M	5	20	D5244T4		81864
T6	200	10/02→	2.922	B	M	6	24	B6294T		81864



***Applicazione per codice***  
***Buyers guide***  
***Zuordnung nach Bestellnummer***  
***Affectations par références***  
***Aplicación por código***  
***Aplicação por código***  
***Εφαρμογες ανα κωδικο***  
***Zastosowanie dla kodu***  
***Применение для кода***  
***Şifreye göre uygulama***

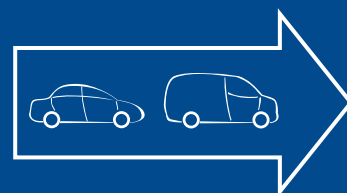





Short	Code
-------	------



Model

Version		Fuel	Motor code
---------	--	------	------------

10526/E			351052605000
---------	--	--	--------------



<b>PULEGGIA</b>	
Diametro Puleggia	Ø112
Numero Denti/Gole Puleggia	1
Posizione Puleggia	63.5
<b>GIRANTE</b>	
Diametro Girante	Ø65.5
N° Alette Girante	5
Distanza Girante	2.5

**ALFA ROMEO**

1750-2000	1968→1975	B	AR00548
GIULIA	1962→1980	B	AR00526 - AR00530
GT I	1963→1977	B	AR00530 - AR00536 - AR00538 - AR00548
GTA	1968→1976	B	AR00531 - AR00534
SPIDER I	1966→1977	B	AR00526 - AR00530 - AR00536 - AR00548 - AR01600
SPIDER II	1971→1993	B	AR00536

11701T	351170120000
--------	--------------



<b>FLANGIA</b>	
Numero Fori Flangia	3
Dimensione Fori Flangia	M6x1
Posizione Flangia	100
Diametro Mozzo	Ø27
Diametro Centraggio	Ø28
<b>GIRANTE</b>	
Diametro Girante	Ø65.5
N° Alette Girante	5
Distanza Girante	2.5

**ALFA ROMEO**

<b>75</b>			
16	05/1989→02/1992	B	AR61101
18	05/1989→12/1992	B	AR61202
18	08/1989→02/1992	B	AR61201
18	08/1989→02/1992	B	AR67101
2.0 T.S	05/1985→02/1992	B	AR06224
2.0 T.S.	01/1987→02/1992	B	AR06166, AR06224
<b>SPIDER II</b>			
1600	01/1990→12/1993	B	AR01563
2000	01/1990→12/1993	B	AR01588
2000 Veloce	01/1977→12/1993	B	AR00515, AR01590

Short	Code
-------	------



Model

Version		Fuel	Motor code
---------	--	------	------------

11706T			351170620000
--------	--	--	--------------



<b>FLANGIA</b>	
Numero Fori Flangia	3
Dimensione Fori Flangia	M6x1
Posizione Flangia	63.5
Diametro Mozzo	Ø27
Diametro Centraggio	Ø28
<b>GIRANTE</b>	
Diametro Girante	Ø66
N° Alette Girante	7
Distanza Girante	41.3

**ALFA ROMEO**

<b>145</b>			
1.4 i.e.	07/1994→12/1996	B	AR33501
1.6 i.e.	10/1994→12/1996	B	AR33201
1.7 i.e. 16V	10/1994→12/1996	B	AR33401
<b>146</b>			
1.4 i.e.	12/1994→12/1996	B	AR33501
1.6 i.e.	12/1994→12/1996	B	AR33201
1.7 i.e. 16V	12/1994→12/1996	B	AR33401
<b>33 I, Sportwagon</b>			
15	05/1983→12/1993	B	AR30182, AR30514
<b>33 II, Sportwagon</b>			
14	06/1991→09/1994	B	
1.4 i.e.	06/1991→09/1994	B	AR30753, AR30755
1.4 i.e.	06/1991→09/1994	B	AR30753, AR30755
1.4 i.e. 4x4	06/1991→09/1994	B	AR30587, AR30755
15	01/1990→04/1993	B	AR30734
1.5 i.e	01/1990→09/1994	B	AR30751
1.7 16V	01/1990→03/1992	B	AR30746
1.7 16V	01/1990→09/1994	B	AR30747
1.7 16V	01/1990→09/1994	B	AR30747
1.7 16V 4x4	01/1990→09/1994	B	AR30747
1.7 16V 4x4	01/1990→09/1994	B	AR30746
1.7 16V 4x4	01/1990→09/1994	B	AR30747
1.7 i.e.	01/1990→03/1992	B	AR30736, AR30737
1.7 i.e.	04/1992→09/1994	B	AR30737, AR30737A
1.7 i.e. 4x4	01/1990→03/1992	B	AR30736, AR30737

Short **MAGNETI MARELLI** Code



**Model**

Version		Fuel	Motor code
11707			350911707000



**PULEGGIA**  
 Diametro Puleggia Ø108  
 Numero Denti/Gole Puleggia 1  
 Posizione Puleggia 70.5  
**GIRANTE**  
 Diametro Girante Ø67  
 N° Alette Girante 7  
 Distanza Girante 4.6

**ALFA ROMEO**

**75**

3.0 V6	01/1987→02/1992	B	AR06120, AR06124
--------	-----------------	---	------------------

11708T 351170820000



**FLANGIA**  
 Numero Fori Flangia 3  
 Dimensione Fori Flangia M6x1  
 Posizione Flangia 87  
 Diametro Mozzo Ø27  
 Diametro Centraggio Ø28  
**GIRANTE**  
 Diametro Girante Ø65.5  
 N° Alette Girante 5  
 Distanza Girante 9.5

**ALFA ROMEO**

**155**

1.7 T.S.	04/1993→04/1996	B	AR67105
1.7 T.S.	04/1993→04/1996	B	AR67103
1.8 T.S.	02/1992→06/1993	B	AR67101
1.8 T.S.	02/1992→12/1997	B	AR67402
1.8 T.S. Sport	01/1992→12/1996	B	AR67101, AR67102
2.0 T.S.	02/1992→04/1993	B	AR67201
2.0 T.S.	02/1992→02/1995	B	AR67202

**164**

2.0 T.S.	09/1992→09/1998	B	AR64103
----------	-----------------	---	---------

Short **MAGNETI MARELLI** Code



**Model**

Version		Fuel	Motor code
11712			350911712000



**PULEGGIA**  
 Diametro Puleggia Ø108  
 Numero Denti/Gole Puleggia 1  
 Posizione Puleggia 63.5  
**GIRANTE**  
 Diametro Girante Ø65.5  
 N° Alette Girante 5  
 Distanza Girante 2.5

**ALFA ROMEO**

**Alfetta**

1.6	01/75→12/84	B	AR01600
1.8	10/79→12/84	B	AR01608
1.8	10/79→12/84	B	AR01678
2.0	03/77→01/86	B	AR01623
2.0	06/77→12/84	B	AR01655
2.0	07/78→12/84	B	AR01655, AR01713, AR10520

**Giulietta**

1.3	10/77→06/83	B	AR01644
1.6	10/77→04/85	B	AR01600
1.8	04/79→04/85	B	AR01678
2.0	06/80→04/85	B	AR01655, AR11671
2.0 Turbo	07/83→06/84	B	AR01699

**GTV I**

2.0	07/78→01/86	B	AR01655, AR06212
2.0 Turbodelta	01/78→12/80	B	AR11642

11713 350911713000



**FLANGIA**  
 Numero Fori Flangia 3  
 Diametro Mozzo Ø36  
 Posizione Flangia 100.5  
**GIRANTE**  
 Diametro Girante Ø71  
 N° Alette Girante 7  
 Distanza Girante 18.5

**ALFA ROMEO**

**75**

2.0 TD	05/1985→09/1992	D	VM80A
2.4 TD	01/1989→02/1992	D	VM81A

Short	Code
-------	------



Model

Version		Fuel	Motor code
---------	--	------	------------

19532/E		351953205000	
---------	--	--------------	--



**FLANGIA**

Numero Fori Flangia 3  
 Dimensione Fori Flangia M6x1  
 Posizione Flangia 90  
 Diametro Centraggio Ø44.8

**GIRANTE**

Diametro Girante Ø67  
 N° Alette Girante 7  
 Distanza Girante 4.6

**ALFA ROMEO**

**164**

2.0 V6 Turbo	03/1991→09/1992	B	AR64101
2.0 V6 Turbo	09/1992→09/1998	B	AR64102
2.5 V6	09/1992→09/1998	B	AR66201
3.0 i.e. QV	09/1990→09/1992	B	AR06430, AR64301
3.0 V6	06/1987→09/1992	B	AR06410
3.0 V6	06/1987→09/1992	B	AR06412
3.0 V6	09/1992→09/1998	B	AR64305, AR66303

**75**

3.0 V6	02/1990→02/1992	B	AR61503
--------	-----------------	---	---------

**FIAT**

**CROMA I**

2500 V6	06/1993→08/1996	B	834G.000
---------	-----------------	---	----------

81300		350981300000	
-------	--	--------------	--



**PULEGGIA**

Diametro Puleggia Ø104  
 Numero Denti/Gole Puleggia 1  
 Posizione Puleggia 163.6

**GIRANTE**

Diametro Girante Ø53.8  
 N° Alette Girante 6  
 Distanza Girante 40.3

**FIAT**

**CINQUECENTO**

0.9	07/1991→12/1993	B	170A1.000
0.9 i.e.	07/1991→12/1993	B	170A1.046

**PANDA I, Van**

900	04/1992→12/1996	B	1170A1.046
900	10/1980→06/1994	B	100GL3.000, 146A.000

**SEICENTO, Van**

0.9	01/1998→	B	1170A1.046
-----	----------	---	------------

Short	Code
-------	------



Model

Version		Fuel	Motor code
---------	--	------	------------

81301		350981301000	
-------	--	--------------	--



**PULEGGIA**

Diametro Puleggia Ø103  
 Numero Denti/Gole Puleggia 1  
 Posizione Puleggia 165

**GIRANTE**

Diametro Girante Ø53.8  
 N° Alette Girante 6  
 Distanza Girante 40.3

**FIAT**

**CINQUECENTO**

0.9	07/1991→12/1993	B	170A1.000
0.9 i.e.	07/1991→12/1993	B	170A1.046
0.9 i.e. S	07/1991→07/1999	B	1170A1.000, 1170A1.046

81302		350981302000	
-------	--	--------------	--



**FLANGIA**

Numero Fori Flangia 1  
 Dimensione Fori Flangia Ø4  
 Posizione Flangia 70  
 Diametro Mozzo M26x1.5  
 Diametro Centraggio Ø27

**GIRANTE**

Diametro Girante Ø70.5  
 N° Alette Girante 7  
 Distanza Girante 29

**ALFA ROMEO**

**155**

2.5 TD	04/1993→12/1997	D	VM07B, VM31B
--------	-----------------	---	--------------

**164**

2.5 TD	06/1987→09/1992	D	VM84A
--------	-----------------	---	-------

**33 II, Sportwagon**

1.8 TD	07/1990→09/1994	D	VM96A
--------	-----------------	---	-------

**CHRYSLER**

**VOYAGER I**

2.5 i	08/1984→09/1995	B	K00
2.5 i	08/1990→09/1995	B	K
2.5 TD	01/1992→09/1995	D	09B, M00



**FORD**

**SCORPIO I, Station Wagon**

2.5 TD	08/1993→09/1994	D	SCB
--------	-----------------	---	-----



**SCORPIO II, Station Wagon**

2.5 TD	10/1994→08/1998	D	SCC
--------	-----------------	---	-----

MAGNETI MARELLI			
Short	Code		
			
<b>Model</b>			
Version		Fuel	Motor code
<b>81302</b>	<b>350981302000</b>		
<b>ROVER</b>			
<b>800</b>			
825 D/SD	01/1990→02/1999	D	425SL1RR, 4924SHIRG
825 SD	09/1993→02/1999	D	425SL1RR, 4924SHIRG
825 Si	04/1996→02/1999	B	25K4F

MAGNETI MARELLI			
Short	Code		
<b>81303</b>	<b>350981303000</b>		
			
<b>PULEGGIA</b>			
Diametro Puleggia		Ø118.5	
Numero Denti/Gole Puleggia		6	
Posizione Puleggia		73.45	
<b>GIRANTE</b>			
Diametro Girante		Ø60	
N° Alette Girante		8	
Distanza Girante		41.5	

FIAT			
<b>ELBA</b>			
15	04/1986→10/1992	B	
<b>MAREA, Weekend</b>			
1.9 TD 75	09/1996→	D	182A8.000
<b>PALIO, Weekend</b>			
14	04/1996→	B	178B2.000
1.4 Cat.	04/1996→	B	178B2.016
1.4 EL	07/1997→01/2011	B	178B2.000
<b>PUNTO I, Cabrio, Van</b>			
1.4 GT Turbo	01/1994→09/1996	B	176A4.000
1.4 GT Turbo	09/1996→09/1999	B	176B6.000
90 1.6	01/1994→04/1997	B	176A9.000
<b>SIENA</b>			
14	04/1996→	B	178B2.000
1.4 Cat.	04/1996→	B	178B2.016
<b>TEMPRA, Station Wagon</b>			
1.4 i.e.	03/1991→08/1996	B	159A2.000
1.4 i.e.	03/1992→08/1996	B	160A1.046, 836A4.000
16	07/1993→07/1996	B	159A3.048
1.6 i.e.	06/1992→08/1996	B	159A3.048, 835C1.000
1.6 i.e.	06/1994→08/1996	B	159B9.000
1.6 i.e.	06/1994→08/1996	B	159B9.000
1.6 i.e.	10/1990→08/1996	B	159A3.046, 835C1.000
<b>LANCIA</b>			
<b>DEDRA, Station Wagon</b>			
16	10/1994→07/1999	B	159B9.000
1.6 16V	01/1996→07/1999	B	182A4.000

MAGNETI MARELLI			
Short	Code		
			
<b>Model</b>			
Version		Fuel	Motor code
<b>DEDRA, Station Wagon</b>			
1.6 i.e.	04/1993→07/1999	B	835C1.000
1.6 LE	07/1994→07/1999	B	159B9.000
<b>DELTA II</b>			
1.4 i.e.	10/1994→08/1999	B	160A1.046, 836A4.000
1.6 i.e.	06/1993→08/1999	B	835C1.000

MAGNETI MARELLI			
Short	Code		
<b>81304</b>	<b>350981304000</b>		
			
<b>FLANGIA</b>			
Numero Fori Flangia		3	
Dimensione Fori Flangia		M8x1.25	
Posizione Flangia		61.55	
<b>GIRANTE</b>			
Diametro Mozzo		Ø22	
Diametro Centraggio		Ø25.95	
Diametro Girante		Ø70	
N° Alette Girante		9	
Distanza Girante		28.4	

FIAT			
<b>PALIO, Weekend</b>			
1.7 TD	04/1996→01/2011	D	176A3.000
1.7 TD ED	07/1997→03/2011	D	176A5.000
<b>PUNTO I, Cabrio, Van</b>			
1.7 D	04/1994→02/2000	D	176B3.000
1.7 TD	01/1994→09/1999	D	176A3.000
1.7 TD	01/1994→02/2000	D	176A5.000
<b>STRADA</b>			
1.7 TD	06/1999→	D	176A3.000
<b>JEEP</b>			
<b>WRANGLER II</b>			
24	02/2011→	B	ED1

MAGNETI MARELLI			
Short	Code		
<b>81309</b>	<b>350981309000</b>		
			
<b>PULEGGIA</b>			
Diametro Puleggia		Ø100	
Numero Denti/Gole Puleggia		6	
Posizione Puleggia		80.6	
<b>GIRANTE</b>			
N° Alette Girante		7	
Diametro Girante		Ø70	
Distanza Girante		28	
<b>FIAT</b>			
<b>CROMA I</b>			
1900 Turbo D i.d.	05/1989→10/1992	D	154C6.000

Short Code



Model

Version		Fuel	Motor code
---------	--	------	------------

81314			350981314000
-------	--	--	--------------



**PULEGGIA**

Diametro Puleggia	Ø122.5
Numero Denti/Gole Puleggia	4
Posizione Puleggia	76.7

**GIRANTE**

Diametro Girante	Ø65
N° Alette Girante	7
Distanza Girante	50

**FIAT**

**ELBA**

14	10/1993→02/1995	B	146D5.000
16	01/1994→12/1996	B	

**FIORINO II**

14	05/1994→01/2011	B	146D5.000
14	11/1992→10/1996	B	146C5.000
16	01/1994→01/2011	B	146C6.000
70 i.e. 1.4	05/1994→01/2011	B	146C5.000, 146D5.000
75 i.e. 1.6	10/1993→01/2011	B	146C6.000, 146D6.000

**TEMPRA, Station Wagon**

1.4 i.e.	03/1991→08/1996	B	159A2.000
1.4 i.e.	03/1992→08/1996	B	160A1.046, 836A4.000
16	03/1990→04/1993	B	159A3.000
16	04/1990→06/1993	B	159A3.048
1.6 i.e.	06/1990→08/1996	B	159A3.046, 835C1.000

**TIPO**

1.4 i.e.	05/1989→04/1995	B	159A2.000
1.4 i.e.	05/1989→04/1995	B	160A1.046, 836A4.000
1.6 i.e.	07/1990→01/1993	B	159A3.046
1.6 i.e.	10/1992→04/1995	B	159A3.048, 835C1.000

**UNO**

70 i.e. 1.4	09/1989→12/1993	B	146C1.000
70 i.e. 1.4	09/1989→12/1993	B	160A1.046

**INNOCENTI**

**ELBA**

1.4 i.e.	09/1994→12/1996	B	146C5.000, 146D5.000
1.6 i.e.	09/1994→12/1996	B	146C6.000, 146D6.000

**LANCIA**

**DEDRA, Station Wagon**

1.6 i.e.	08/1989→06/1994	B	835A1.000
1.6 i.e.	08/1989→03/1993	B	835A1.046

Short Code



Model

Version		Fuel	Motor code
---------	--	------	------------

81315			350981315000
-------	--	--	--------------



**FLANGIA**

Numero Fori Flangia	3
Dimensione Fori Flangia	M8x1.25
Posizione Flangia	95.5
Diametro Centraggio	Ø57

**GIRANTE**

Diametro Girante	Ø68
N° Alette Girante	12
Distanza Girante	17.2

**FIAT**

**TEMPRA, Station Wagon**

1.8 i.e.	03/1990→08/1996	B	
1.8 i.e.	03/1992→08/1996	B	159A4.046
1.8 i.e.	09/1993→08/1996	B	835C4.000
1.8 i.e.	09/1993→08/1996	B	835C2.000
1.8 i.e.	10/1994→08/1996	B	836A5.000
2.0 i.e.	10/1990→08/1996	B	159A6.046
2.0 i.e. 4x4	03/1992→03/1995	B	159A6.046

**TIPO**

1.8 i.e.	03/1993→04/1995	B	836A5.000
1.8 i.e.	04/1993→04/1995	B	835C2.000
1.8 i.e.	09/1993→04/1995	B	835C4.000
1.8 i.e.	10/1990→06/1993	B	159A4.000
1.8 i.e.	10/1990→06/1993	B	159A4.046
1.8 i.e.	10/1994→04/1995	B	159A4.000
2.0 16V	07/1991→04/1995	B	160A8.046
2.0 i.e.	03/1990→04/1995	B	159A6.046
2.0 i.e.	06/1990→03/1992	B	159A5.046

**LANCIA**

**DEDRA, Station Wagon**

1.8 i.e.	07/1994→07/1999	B	836A5.000
1.8 i.e.	08/1993→07/1999	B	835C5.000
1.8 i.e.	09/1989→07/1999	B	835A2.046
2.0 HF integrale	11/1990→07/1994	B	835A7.046
2.0 i.e.	09/1989→07/1999	B	835A5.046
2.0 i.e. Turbo	04/1991→07/1999	B	835A8.046
2.0 i.e. Turbo integrale	05/1990→07/1994	B	835A7.000
2.0 Turbo	11/1990→06/1994	B	835A8.000

**DELTA II**

1.8 i.e.	06/1993→08/1999	B	835C2.000
1.8 i.e.	07/1994→08/1999	B	835C4.000, 836A6.000, 836C4.000

Short	Code
-------	------



### Model

Version	Fuel	Motor code
---------	------	------------

81316 350981316000



**FLANGIA**  
 Numero Fori Flangia 3  
 Dimensione Fori Flangia M8x1.25  
 Posizione Flangia 78  
 Diametro Centraggio Ø50

**GIRANTE**  
 Diametro Girante Ø93.5  
 N° Alette Girante 8  
 Distanza Girante 14.5

### CITROËN

#### JUMPER I

2.8 HDi	09/2000→02/2011	D	8140.43S
2.8 HDi	10/2000→02/2011	D	8140.43S
2.8 HDi 4x4	09/2000→02/2011	D	8140.43S

#### JUMPER II

2.8 HDi	02/2011→	D	8140.43S
2.8 HDi	04/2011→06/2011	D	8140.43N
2.8 HDi	04/2011→	D	8140.43N
2.8 HDi 4x4	02/2011→06/2011	D	8140.43S, F28TDCR

### FIAT

#### DUCATO III

2.5 D	03/1994→02/2011	D	814067
2.5 D 4x4	03/1994→02/2011	D	814067
2.5 D Combinato	08/1994→02/2011	D	814067
2.5 TD	06/1994→04/1998	D	814047
2.5 TD	06/1994→08/1998	D	814047
2.5 TD 4x4	11/1994→04/1998	D	814047
2.5 TD 4x4	11/1994→04/1998	D	814047
2.5 TDI	03/1994→02/2011	D	8140.47R
2.5 TDI	03/1994→02/2011	D	814047
2.5 TDI 4x4	04/1997→02/2011	D	814047
2.5 TDI Combinato	08/1994→02/2011	D	8140.47R
2.5 TDI Maxi	03/1994→02/2011	D	814047
2.5 TDI Panorama/ Combinato	03/1994→02/2011	D	814047
2.5 TDI Panorama/ Combinato	07/1994→02/2011	D	8140.47R
2.8 4x4	05/1998→01/2011	D	814043
2.8 D	02/1998→02/2011	D	814063
2.8 D 4x4	08/1998→02/2011	D	814063
2.8 JTD	01/2011→01/2011	D	8140.43S
2.8 JTD	11/2000→02/2011	D	8140.43S
2.8 JTD 4x4	11/2000→02/2011	D	8140.43S
2.8 TD 4x4	05/1998→01/2011	D	814063

Short	Code
-------	------



### Model

Version	Fuel	Motor code
---------	------	------------

#### DUCATO III

2.8 TDI	10/1997→02/2011	D	814043
2.8 TDI 4x4	06/1999→02/2011	D	814043

#### DUCATO IV

28	03/2011→06/2011	D	814043
2.8 4x4	03/2011→06/2011	D	814043
2.8 JTD	02/2011→	D	8140.43S
2.8 JTD	04/2011→06/2011	D	8140.43N
2.8 JTD 4x4	02/2011→	D	8140.43S
2.8 JTD Power	04/2011→	D	8140.43N

### PEUGEOT

#### BOXER I

2.5 D	03/1994→02/2011	D	T9A (DJ5)
2.5 D 4x4	07/1996→02/2011	D	T9A (DJ5)
2.5 TD 4x4	07/1996→02/2011	D	T8A (DJ5T)
2.8 HDi	10/2000→01/2011	D	8140.43S
2.8 HDI	11/2000→02/2011	D	8140.43S
2.8 HDi 4 ruote motrici	10/2000→01/2011	D	8140.43S

#### BOXER II

2.8 HDi	02/2011→	D	8140.43S
2.8 HDi	04/2011→	D	
2.8 HDi 4x4	02/2011→	D	8140.43S

81318 350981318000



**PULEGGIA**  
 Diametro Puleggia Ø99.5  
 Numero Denti/Gole Puleggia 6  
 Posizione Puleggia 80.6

**GIRANTE**  
 Diametro Girante Ø70  
 N° Alette Girante 9  
 Distanza Girante 28

### FIAT

#### DUCATO III

19	05/1998→01/2011	D	
1.9 TD	03/1994→02/2011	D	230A3.000
1.9 TD CAT	08/1994→02/2011	D	230A4.000
1.9 TD Combinato	08/1994→02/2011	D	230A4.000
1.9 TD Panorama/ Combinato	03/1994→02/2011	D	230A3.000

Short	Code
-------	------



Model

Version		Fuel	Motor code
---------	--	------	------------

81319 350981319000



**PULEGGIA**

Diametro Puleggia Ø99.5  
 Numero Denti/Gole Puleggia 7  
 Posizione Puleggia 84.15

**GIRANTE**

Diametro Girante Ø70  
 N° Alette Girante 9  
 Distanza Girante 28

FIAT

**DUCATO III**

1.9 TD	03/1994→02/2011	D	230A3.000
1.9 TD CAT	08/1994→02/2011	D	230A4.000
1.9 TD Combinato	08/1994→02/2011	D	230A4.000
1.9 TD Panorama/Combinato	03/1994→02/2011	D	230A3.000

81320 350981320000



**FLANGIA**

Numero Fori Flangia 3  
 Dimensione Fori Flangia M8x1.25  
 Posizione Flangia 78.5  
 Diametro Mozzo Ø22  
 Diametro Centraggio Ø25.95

**GIRANTE**

Diametro Girante Ø70  
 N° Alette Girante 7  
 Distanza Girante 28.4

FIAT

**DUCATO III**

1.9 D	03/1994→02/2011	D	230A2.000
1.9 D Combinato	06/1995→02/2011	D	230A2.000

81322 350981322000



**FLANGIA**

Numero Fori Flangia 3  
 Dimensione Fori Flangia M8x1.25  
 Posizione Flangia 95.5  
 Diametro Centraggio Ø57

**GIRANTE**

Diametro Girante Ø68  
 N° Alette Girante 12  
 Distanza Girante 17.2

ALFA ROMEO

**155**

2.0 16V Turbo Q4	01/1992→12/1997	B	AR67203
------------------	-----------------	---	---------

Short	Code
-------	------



Model

Version		Fuel	Motor code
---------	--	------	------------

**155**

2.0 16V Turbo Q4	01/1992→12/1997	B	AR67203
------------------	-----------------	---	---------

FIAT

**COUPE'**

2.0 16V	11/1993→08/1996	B	836A3.000
2.0 16V Turbo	11/1993→08/1996	B	175A1.000

**TIPO**

2.0 i.e. 16V Sport	03/1993→04/1995	B	836A3.000
--------------------	-----------------	---	-----------

LANCIA

**DEDRA, Station Wagon**

2.0 16V	07/1994→07/1999	B	836A3.000
2.0 INTEGRAle	07/1994→07/1999	B	836A3.000

**DELTA II**

20	11/1994→04/1998	B	
2.0 16V	06/1993→08/1999	B	836A3.000
2.0 16V Turbo	06/1993→08/1999	B	836A2.000
2.0 16V Turbo	07/1996→08/1999	B	175A4.000

81324 350981324000



**PULEGGIA**

Diametro Puleggia Ø131  
 Numero Denti/Gole Puleggia 1  
 Posizione Puleggia 64

**GIRANTE**

Diametro Girante Ø99  
 N° Alette Girante 7  
 Distanza Girante 17.35

FIAT

**CROMA I**



2500 TD	05/1989→08/1996	D	8144.97, 8144.97Y
2500 TDE	12/1991→08/1996	D	8144.97S



LANCIA



**THEMA, Station Wagon**

2500 Turbo DS	05/1988→07/1992	D	8144.97S
2500 Turbo DS	06/1988→05/1992	D	814497





MAGNETI MARELLI			
Short	Code		
			
<b>Model</b>			
Version		Fuel	Motor code
81325	350981325000		
		<b>FLANGIA</b> Numero Fori Flangia 3 Dimensione Fori Flangia M8x1.25 Posizione Flangia 62.6 Diametro Centraggio Ø50  <b>GIRANTE</b> Diametro Girante Ø95.5 N° Alette Girante 7 Distanza Girante 21.1	
<b>FIAT</b>			
<b>CROMA I</b>			
2500 TD	05/1989→08/1996	D	8144.97, 8144.97Y
2500 TDE	12/1991→08/1996	D	8144.97S
<b>LANCIA</b>			
<b>THEMA, Station Wagon</b>			
2500 Turbo DS	05/1992→07/1994	D	8144.97Y
<b>RENAULT</b>			
<b>SAFRANE I</b>			
2.5 dT	12/1992→07/1996	D	S8U762, S8U763

MAGNETI MARELLI			
Short	Code		
			
<b>Model</b>			
Version		Fuel	Motor code
81326	350981326000		
		<b>PULEGGIA</b> Diametro Puleggia Ø100 Numero Denti/Gole Puleggia 6 Posizione Puleggia 80.6  <b>GIRANTE</b> Diametro Girante Ø70 N° Alette Girante 7 Distanza Girante 28	
<b>ALFA ROMEO</b>			
<b>145</b>			
1.9 D	07/1994→02/1999	D	AR67501
1.9 TD	10/1994→02/1999	D	AR33601, AR67501
<b>146</b>			
1.9 D	05/1995→09/1996	D	AR67501
1.9 TD	12/1994→02/1999	D	AR33601, AR67501
<b>155</b>			
1.9 TD	04/1993→12/1997	D	AR67501
<b>FIAT</b>			
<b>TEMPRA, Station Wagon</b>			
1.9 D	07/1991→08/1996	D	160A7.000
<b>TIPO</b>			
1.7 D	01/1988→10/1994	D	149B4.000
1.7 D	01/1988→10/1995	D	
1.9 D	07/1991→08/1996	D	160A7.000
<b>LANCIA</b>			
<b>DEDRA, Station Wagon</b>			
1.9 TDS	04/1989→07/1999	D	160D1.000, 835A4.000, 835A4.046
<b>DELTA II</b>			
1.9 TD	10/1994→08/1999	D	160D1.000, 835A4.000

MAGNETI MARELLI			
Short	Code		
			
<b>Model</b>			
Version		Fuel	Motor code
<b>TIPO</b>			
1.9 TD	09/1990→04/1995	D	160A6.000, 160A6.046, 160D1.000
<b>LANCIA</b>			
<b>DEDRA, Station Wagon</b>			
1.9 TDS	04/1989→07/1999	D	160D1.000, 835A4.000, 835A4.046

MAGNETI MARELLI			
Short	Code		
			
<b>Model</b>			
Version		Fuel	Motor code
81327	350981327000		
		<b>FLANGIA</b> Numero Fori Flangia 3 Dimensione Fori Flangia M8x1.25 Posizione Flangia 95.6 Diametro Mozzo Ø26 Diametro Centraggio Ø57  <b>GIRANTE</b> Diametro Girante Ø68 N° Alette Girante 12 Distanza Girante 17.2	

MAGNETI MARELLI			
Short	Code		
			
<b>Model</b>			
Version		Fuel	Motor code
<b>ALFA ROMEO</b>			
<b>145</b>			
1.9 D	07/1994→02/1999	D	AR67501
1.9 TD	10/1994→02/1999	D	AR33601, AR67501
<b>146</b>			
1.9 D	05/1995→09/1996	D	AR67501
1.9 TD	12/1994→02/1999	D	AR33601, AR67501
<b>155</b>			
1.9 TD	04/1993→12/1997	D	AR67501
<b>FIAT</b>			
<b>TEMPRA, Station Wagon</b>			
1.9 D	07/1991→08/1996	D	160A7.000
<b>TIPO</b>			
1.7 D	01/1988→10/1994	D	149B4.000
1.7 D	01/1988→10/1995	D	
1.9 D	07/1991→08/1996	D	160A7.000
<b>LANCIA</b>			
<b>DEDRA, Station Wagon</b>			
1.9 TDS	04/1989→07/1999	D	160D1.000, 835A4.000, 835A4.046
<b>DELTA II</b>			
1.9 TD	10/1994→08/1999	D	160D1.000, 835A4.000

Short	Code
-------	------



Model

Version		Fuel	Motor code
---------	--	------	------------

81328 350981328000



<b>FLANGIA</b>	
Numero Fori Flangia	3
Dimensione Fori Flangia	M8x1.25
Posizione Flangia	78.5
Diametro Mozzo	Ø22
Diametro Centraggio	Ø25.95
<b>GIRANTE</b>	
Diametro Girante	Ø70
N° Alette Girante	9
Distanza Girante	28.4

ALFA ROMEO

145

1.9 D	07/94→02/99	D	AR67501
1.9 TD	10/94→02/99	D	AR33601, AR67501

146

1.9 D	05/95→09/96	D	AR67501
1.9 TD	12/94→02/99	D	AR33601, AR67501

155

1.9 TD	04/93→12/97	D	AR67501
--------	-------------	---	---------

FIAT

TEMPRA, Station Wagon

1.9 D	07/91→08/96	D	160A7.000
-------	-------------	---	-----------

TIPO

1.7 D	01/88→10/94	D	149B4.000
1.7 D	01/88→10/95	D	
1.9 D	07/91→08/96	D	160A7.000

LANCIA

DEDRA, Station Wagon

1.9 TDS	04/89→07/99	D	160D1.000, 835A4.000, 835A4.046
---------	-------------	---	---------------------------------

DELTA II

1.9 TD	10/94→08/99	D	160D1.000, 835A4.000
--------	-------------	---	----------------------

81329 350981329000



<b>PULEGGIA</b>	
Diametro Puleggia	Ø60.5
Altezza Puleggia	29
Posizione Puleggia	39
<b>GIRANTE</b>	
Diametro Girante	Ø76
N° Alette Girante	8
Distanza Girante	17.2

FIAT

BRAVA

20	09/1998→08/2000	B	182B7.000
----	-----------------	---	-----------

Short	Code
-------	------



Model

Version		Fuel	Motor code
---------	--	------	------------

BRAVO I

2.0 HGT 20V	07/1998→01/2011	B	182B7.000
2.0 HGT 20V	10/1995→07/1998	B	182A1.000

COUPE'

2.0 20V	04/1998→08/2000	B	182B3.000
2.0 20V	08/1996→04/1998	B	182A1.000
2.0 20V Turbo	08/1996→08/2000	B	175A3.000

MAREA, Weekend

2.0 150 20V	01/2011→	B	185A8.000
2.0 150 20V	09/1996→04/1999	B	182A1.000
2.0 155 20V	04/1999→01/2011	B	182B7.000

STILO, Station Wagon

2.4 20V	01/2011→	B	192A2.000
---------	----------	---	-----------

LANCIA

KAPPA, Station Wagon, Coupé

2.0 20V	07/1996→01/2011	B	838A6.000
2.0 20V	10/1994→01/2011	B	838A1.000
2.0 20V Turbo	06/1998→01/2011	B	175A3.000
2.4 20V	08/1994→01/2011	B	838A2.000, 838A2.027

LYBRA, Station Wagon

2.0 20V	07/1999→09/2000	B	182B7.000
2.0 20V	09/2000→	B	185A8.000

THESIS

2.0 Turbo	02/2011→	B	841E.000
24	02/2011→	B	841D.000

81330 350981330000



<b>PULEGGIA</b>	
Diametro Puleggia	Ø48
Altezza Puleggia	32
Posizione Puleggia	39.2
<b>GIRANTE</b>	
Diametro Girante	Ø76
N° Alette Girante	8
Distanza Girante	17.2

FIAT

BRAVA

1.9 JTD	09/2000→01/2011	D	182B9.000
1.9 TD 100 S	03/1996→01/2011	D	182A7.000

BRAVO I

1.9 JTD	09/2000→01/2011	D	182B9.000
1.9 TD 100 S	03/1996→01/2011	D	182A7.000

MAREA, Weekend

1.9 TD 100	09/1996→	D	182A7.000
------------	----------	---	-----------

Short **MAGNETI MARELLI** Code



Model

Version		Fuel	Motor code
<b>81330</b>			<b>350981330000</b>
<b>FIAT</b>			
<b>MAREA, Weekend</b>			
1.9 TD 75	09/1996→	D	182A8.000
2.4 JTD 130	04/1999→	D	185A6.000, 839A5.000
2.4 TD 125	09/1996→04/1999	D	185A2.000
<b>LANCIA</b>			
<b>KAPPA, Station Wagon, Coupé</b>			
2.4 T.DS	08/1994→01/2011	D	838A3.000, 838A7.000

**81331** **350981331000**



**PULEGGIA**  
 Diametro Puleggia Ø71.1  
 Altezza Puleggia 30.3  
 Posizione Puleggia 38.9

**GIRANTE**  
 Diametro Girante Ø76  
 N° Alette Girante 8  
 Distanza Girante 17.2

**ALFA ROMEO**

<b>145</b>			
1.4 i.e. 16V T.S.	12/1996→01/2011	B	AR33503, AR38501
1.8 i.e. 16V	03/1998→01/2011	B	AR32201
1.8 i.e. 16V T.S.	12/1996→12/1998	B	AR38401, AR67106
2.0 16V Quadrifoglio	03/1998→01/2011	B	AR32301
2.0 16V T.S.	10/1995→01/2011	B	AR67204
<b>146</b>			
1.4 i.e. 16V T.S.	11/1996→01/2011	B	AR33503, AR38501
1.8 i.e. 16V T.S.	03/1998→01/2011	B	AR32201
1.8 i.e. 16V T.S.	11/1996→01/2011	B	AR38401, AR67106
2.0 16V Quadrifoglio	03/1998→01/2011	B	AR32301
2.0 16V T.S.	10/1995→01/2011	B	AR67204
<b>147</b>			
1.6 16V T.SPARK	01/2011→	B	AR32104
1.6 16V T.SPARK ECO	01/2011→	B	AR37203
20	02/2011→05/2011	B	937A1.000
2.0 16V T.SPARK	01/2011→	B	AR32310
<b>155</b>			
2.0 T.S. 16V	03/1995→12/1997	B	AR67204
<b>156, Sportwagon</b>			
1.6 16V T.SPARK	09/1997→05/2011	B	AR32102, AR32103, AR32104, AR67601
1.6 16V T.SPARK.	05/2000→06/2011	B	AR32102, AR32103, AR32104, AR67601

Short **MAGNETI MARELLI** Code



Model

Version		Fuel	Motor code
<b>156, Sportwagon</b>			
1.8 16V T.SPARK	05/2000→10/2000	B	AR32201
2.0 16V T.SPARK	09/1997→10/2000	B	AR32301
2.0 16V T.SPARK	10/2000→02/2011	B	AR32310
2.0 GLX	11/1997→04/2000	B	AR32303
2.0 JTS	02/2011→06/2011	B	937A1.000
<b>159, Sportwagon</b>			
1.8 TBi	09/2011→	B	939B1.000
<b>166</b>			
2.0 T.SPARK	09/1998→10/2000	B	AR34103
2.0 T.SPARK	10/2000→	B	AR36301
<b>BRERA</b>			
1.8 TBi	09/2011→	B	939B1.000
<b>GIULIETTA</b>			
1.4 TB	10/2011→	B	940A2.000
1.8 TBi	10/2011→	B	940A1.000
<b>GT II</b>			
2.0 JTS	03/2011→	B	932A2.000, 937A1.000
<b>GTV II</b>			
1.8 16V	05/1998→	B	AR32201
2.0 JTS	03/2011→	B	937A1.000
2.0 T.SPARK 16V	05/1998→08/2000	B	AR32301
2.0 T.SPARK 16V	06/1995→	B	AR16201, AR32310
<b>SPIDER III</b>			
1.8 16V	05/1998→05/2011	B	AR32201
2.0 JTS	03/2011→05/2011	B	937A1.000
2.0 T.SPARK 16V	05/1998→08/2000	B	AR32301
2.0 T.SPARK 16V	06/1995→05/2011	B	AR16201, AR32310
<b>SPIDER IV</b>			
1.8 TBi	09/2011→	B	939B1.000
<b>FIAT</b>			
<b>BARCETTA</b>			
1.8 16V	04/1995→	B	183A1.000, 188A6.000
<b>BRAVA</b>			
1.8 GT 16V	10/1995→01/2011	B	182A2.000
<b>BRAVO I</b>			
1.8 GT	10/1995→01/2011	B	182A2.000
<b>COUPE'</b>			
1.8 16V	03/1996→08/2000	B	183A1.000
<b>MAREA, Weekend</b>			
1.8 115 16V	09/1996→	B	182A2.000
<b>PUNTO II, Van</b>			
1.8 130 HGT	09/1999→	B	183A1.000, 188A6.000

MAGNETI MARELLI			
Short	Code		
Model			
Version		Fuel	Motor code
LANCIA			
DEDRA, Station Wagon			
1.8 16V LE	03/1996→07/1999	B	182A2.000
1.8 GT 16V	03/1996→07/1999	B	183A1.000
DELTA II			
1.8 i.e. 16V	03/1996→08/1999	B	182A2.000
1.8 i.e. 16V GT	03/1996→08/1999	B	183A1.000
DELTA III			
1.8 16V	09/2011→	B	
1.8 Di	09/2011→	B	
LYBRA, Station Wagon			
1.8 16V	07/1999→	B	839A4.000, 839A7.000, 839A9.000
THEMA, Station Wagon			
3000 V6	08/1992→07/1994	B	834F.000

81332	350981332000		
	<b>GIRANTE</b> Diametro Alberino SX Tipo Filetto Alberino Lunghezza Alberino	M14x1.5 Maschio 130	
	<b>GIRANTE</b> Diametro Girante N° Alette Girante Distanza Girante	Ø93.5 8 14.5	

IVECO			
DAILY I			
12997	09/1998→	B	814063
13058	01/1996→	B	814023
13119	05/1996→	B	814043
18172	05/1996→	B	814023
18233	05/1996→	B	814043
40785	01/1992→08/1998	B	8140.07.2700, 8140.67F.
40785	01/1996→08/1998	B	8140.67F.
40785	09/1998→	B	814063
40846	01/1998→	B	814023
30-10 C	01/1997→	B	814023
30-10 V,30-10 C	01/1997→	B	814023
30-8 V	09/1998→	B	814063
30-8 V,30-8 C	01/1989→08/1998	B	8140.07.2700, 8140.07.2712, 8140.67F.
30-8 V,30-8 C	01/1996→08/1998	B	8140.67F.
30-8 V,30-8 C	09/1998→	B	814063
35-10 K	01/1997→	B	814023
35-10 V,35-10 C	01/1996→	B	814023

MAGNETI MARELLI			
Short	Code		
Model			
Version		Fuel	Motor code
DAILY I			
35-12 K	09/1996→08/1998	B	814043
35-8 K	09/1998→	B	814063
35-8 V,35-8 C	09/1998→	B	814063
49-10 K	05/1996→	B	814023
49-12 K	05/1996→	B	814043
49-12 V	05/1996→	B	814043
59-12 K	05/1996→	B	814043
59-12 V	05/1996→	B	814043

81333	350981333000		
	<b>PULEGGIA</b> Diametro Puleggia Numero Denti/Gole Puleggia Posizione Flangia	Ø113.5 6 70.7	
	<b>GIRANTE</b> Diametro Girante N° Alette Girante Distanza Girante	Ø62 7 58.9	

FIAT			
TEMPRA, Station Wagon			
1.4 i.e.	03/1991→08/1996	B	159A2.000
1.4 i.e.	03/1992→08/1996	B	160A1.046, 836A4.000
16	03/1990→04/1993	B	159A3.000
16	04/1990→06/1993	B	159A3.048
1.6 i.e.	06/1990→08/1996	B	159A3.046, 835C1.000
TIPO			
1.4 i.e.	05/1989→04/1995	B	160A1.046, 836A4.000
1.4 i.e.	05/1989→04/1995	B	159A2.000
1.6 i.e.	07/1990→01/1993	B	159A3.046
1.6 i.e.	10/1992→04/1995	B	159A3.048, 835C1.000
UNO			
70 i.e. 1.4	09/1989→12/1993	B	160A1.046
70 i.e. 1.4	09/1989→12/1993	B	146C1.000
LANCIA			
DEDRA, Station Wagon			
1.6 i.e.	08/1989→03/1993	B	835A1.046
1.6 i.e.	08/1989→06/1994	B	835A1.000
DELTA II			
1.4 i.e.	10/1994→08/1999	B	160A1.046, 836A4.000
1.6 i.e.	06/1993→08/1999	B	835C1.000

Short **MAGNETI MARELLI** Code



Model

Version	Fuel	Motor code
---------	------	------------

<b>81334</b>	<b>350981334000</b>	
	<b>FLANGIA</b> Numero Fori Flangia 3 Dimensione Fori Flangia M8x1.25 Posizione Flangia 82.75 Diametro Mozzo Ø27.88	
	<b>GIRANTE</b> Diametro Girante Ø93.5 N° Alette Girante 8 Distanza Girante 14.5	

**IVECO**

**DAILY I**

40785	01/1992→08/1998	8140.07.2700, 8140.67F.
13058	01/1989→12/1996	8140.47R.2790
40-10 V	01/1990→04/1996	8140272720
16711	01/1989→04/1996	8140272720
45-10 V	01/1989→04/1996	8140272720
18172	01/1989→04/1996	8140.27.2700, 8140.47R.2790
49-10 K	01/1989→04/1996	8140.27.2700, 8140.47R.2790
49-10 V	01/1989→04/1996	8140.27.2700, 8140.47R.2790
14885	01/1991→12/1996	8140272720
16711	01/1991→04/1996	8140272720

**RENAULT**

**MASTER I**

28-35 2,5 D	08/1989→07/1998	D 8140.67.2510, S8U742
28-35 2.5 D	08/1989→07/1998	D 8140.67.2510, S8U742
28-35 2.5 D	09/1980→07/1998	D 8140.61.2300, S8U731

**TRAFIC I**

2.5 D	03/1980→01/2011	D 8140.61.240, S8U720, S8U722
2.5 D	05/1989→01/2011	D 8140.67.2500, 8140.67.2550, 8140.67.2580, S8U750, S8U752, S8U758

**81335** **350981335000**

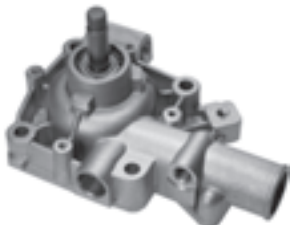
	<b>GIRANTE</b> Diametro Alberino M14x1.5 SX Maschio Tipo Filetto Alberino Lunghezza Alberino 119.05	
	<b>GIRANTE</b> Diametro Girante Ø93.5 N° Alette Girante 8 Distanza Girante 14.5	

**IVECO**

**DAILY I**

13119	01/1990→04/1996	8140472700
-------	-----------------	------------

Short **MAGNETI MARELLI** Code



Model

Version	Fuel	Motor code
---------	------	------------

<b>81339</b>	<b>350981339000</b>	
	<b>PULEGGIA</b> Diametro Puleggia Ø118.5 Numero Denti/Gole Puleggia 6 Posizione Puleggia 73.45	
	<b>GIRANTE</b> Diametro Girante Ø60 N° Alette Girante 8 Distanza Girante 41.5	

**FIAT**

**PALIO, Weekend**

14	04/1996→	B 178B2.000
1.4 Cat.	04/1996→	B 178B2.016
1.4 EL	07/1997→01/2011	B 178B2.000

**PUNTO I, Cabrio, Van**

1.4 GT Turbo	01/1994→09/1996	B 176A4.000
1.4 GT Turbo	09/1996→09/1999	B 176B6.000
90 1.6	01/1994→04/1997	B 176A9.000

**SIENA**

14	04/1996→	B 178B2.000
1.4 Cat.	04/1996→	B 178B2.016

**TEMPRA, Station Wagon**

1.4 i.e.	03/1991→08/1996	B 159A2.000
1.4 i.e.	03/1992→08/1996	B 160A1.046, 836A4.000
16	07/1993→07/1996	B 159A3.048
1.6 i.e.	06/1992→08/1996	B 159A3.048, 835C1.000
1.6 i.e.	06/1994→08/1996	B 159B9.000
1.6 i.e.	06/1994→08/1996	B 159B9.000
1.6 i.e.	10/1990→08/1996	B 159A3.046, 835C1.000

**LANCIA**

**DEDRA, Station Wagon**

16	10/1994→07/1999	B 159B9.000
1.6 16V	01/1996→07/1999	B 182A4.000
1.6 i.e.	04/1993→07/1999	B 835C1.000
1.6 LE	07/1994→07/1999	B 159B9.000

**DELTA II**

1.4 i.e.	10/1994→08/1999	B 160A1.046, 836A4.000
1.6 i.e.	06/1993→08/1999	B 835C1.000

Short	Code
-------	------



Model

Version		Fuel	Motor code
---------	--	------	------------

81340 350981340000



<b>PULEGGIA</b>	
Diametro Puleggia	Ø60.5
Altezza Puleggia	26
Posizione Puleggia	33.5
<b>GIRANTE</b>	
Diametro Girante	Ø66
N° Alette Girante	8
Distanza Girante	17.2

FIAT

**BRAVA**

14	10/1995→01/2011	B	182A5.000
1.4 12 V	10/1995→08/1998	B	182A3.000

**BRAVO I**

14	10/1995→01/2011	B	182A3.000
14	10/1995→01/2011	B	182A5.000

**MAREA, Weekend**

1.4 80 12V	09/1996→	B	182A3.000
------------	----------	---	-----------

LANCIA

Y

1.4 12V	03/1996→03/2011	B	840A4.000
1.4 12V	10/1996→03/2011	B	840A2.000

81341 350981341000



<b>PULEGGIA</b>	
Diametro Puleggia / Ø107	Ø118.5
Numero Denti/Gole Puleggia	5 / 3
Posizione Puleggia	84.9
<b>GIRANTE</b>	
Diametro Girante	Ø60
N° Alette Girante	8
Distanza Girante	41.5

FIAT

**BRAVA**

1.6 16V	02/1996→01/2011	B	182A4.000
1.6 16V	10/1995→01/2011	B	182A6.000

**BRAVO I**

16	09/2000→02/2011	B	182B6.000
1.6 16V	03/1996→01/2011	B	182A4.000
1.6 16V	10/1995→01/2011	B	182A6.000

**DOBLO' I, Cargo**

16	02/2011→	B	182B6.000
1.6 16V	01/2011→	B	182B6.000

Short	Code
-------	------



Model

Version		Fuel	Motor code
---------	--	------	------------

**DOBLO' I, Cargo**

1.6 Natural Power	02/2011→	BF	182B6.000
-------------------	----------	----	-----------

**MAREA, Weekend**

16	03/1999→08/2000	B	185A3.000
16	09/2000→02/2011	B	182B6.000
1.6 100 16V	09/1996→	B	182A4.000
1.6 100 16V Bipower	04/1999→	BF	185A3.000, 186A4.000
1.6 SX	09/2000→02/2011	B	182B5.098

**MULTIPLA**

16	01/2011→05/2011	G	182B6.000
16	04/2011→05/2011	G	182B6.000
16	09/2000→01/2011	B	182B6.000
1.6 100 16V	04/1999→	B	182A4.000
1.6 16V Bipower	04/1999→	BF	186A4.000
1.6 16V Bipower	01/2011→	BF	182B6.000
1.6 16V BLUPower	02/2011→	G	182B6.000
1.6 16V BLUPower	04/1999→	G	186A3.000

**PALIO, Weekend**

16	06/1999→	B	
16	07/1997→03/2011	B	178C7.098, 178D2..011
1.6 16V	01/2011→	B	182B6.000
1.6 16V	04/1996→01/2011	B	178B3.000

**SIENA**

16	11/2000→	B	182B6.000
1.6 16V	09/1998→	B	178B3.000

**STILO, Station Wagon**

1.6 16V	05/2011→	B	192B30
1.6 16V	01/2011→	B	182B6.000

**STRADA**

1.6 Trekking	05/2011→	B	
--------------	----------	---	--

LANCIA

DELTA II

1.6 i.e.	03/1996→08/1999	B	182A6.000
1.6 i.e. 16V	01/1996→08/1999	B	182A4.000

**LYBRA, Station Wagon**

1.6 16V	07/1999→	B	182A4.000, 182B6.000
---------	----------	---	----------------------



**Model**

Version		Fuel	Motor code
---------	--	------	------------

81342 350981342000



**PULEGGIA**  
 Diametro Puleggia Ø100  
 Numero Denti/Gole Puleggia 7  
 Posizione Puleggia 85.25

**GIRANTE**  
 Diametro Girante Ø70  
 N° Alette Girante 9  
 Distanza Girante 28.4

**FIAT**

**BRAVA**

1.9 D	10/1995→01/2011	D	160A7.000
-------	-----------------	---	-----------

**BRAVO I**

1.9 D	10/1995→01/2011	D	160A7.000
-------	-----------------	---	-----------

81343 350981343000



**PULEGGIA**  
 Diametro Puleggia Ø118.5  
 Numero Denti/Gole Puleggia 4  
 Posizione Puleggia 69.9

**GIRANTE**  
 Diametro Girante Ø60  
 N° Alette Girante 8  
 Distanza Girante 41.5

**FIAT**

**FIORINO II**

14	05/1994→01/2011	B	146D5.000
----	-----------------	---	-----------

14	11/1992→10/1996	B	146C5.000
----	-----------------	---	-----------

16	01/1994→01/2011	B	146C6.000
----	-----------------	---	-----------

70 i.e. 1.4	05/1994→01/2011	B	146C5.000, 146D5.000
-------------	-----------------	---	----------------------

75 i.e. 1.6	10/1993→01/2011	B	146C6.000, 146D6.000
-------------	-----------------	---	----------------------

**PALIO, Weekend**

14	04/1996→	B	178B2.000
----	----------	---	-----------

1.4 Cat.	04/1996→	B	178B2.016
----------	----------	---	-----------

1.4 EL	07/1997→01/2011	B	178B2.000
--------	-----------------	---	-----------

**SIENA**

14	04/1996→	B	178B2.000
----	----------	---	-----------

1.4 Cat.	04/1996→	B	178B2.016
----------	----------	---	-----------

**TEMPRA, Station Wagon**

1.4 i.e.	03/1991→08/1996	B	159A2.000
----------	-----------------	---	-----------

1.4 i.e.	03/1992→08/1996	B	160A1.046, 836A4.000
----------	-----------------	---	----------------------



**Model**

Version		Fuel	Motor code
---------	--	------	------------

**INNOCENTI**

**ELBA**

1.4 i.e.	09/1994→12/1996	B	146C5.000, 146D5.000
----------	-----------------	---	----------------------

81344 350981344000



**FLANGIA**  
 Numero Fori Flangia 3  
 Posizione Flangia 61.5  
 Diametro Mozzo Ø23  
 Diametro Centraggio Ø26

**GIRANTE**  
 Diametro Girante n.v.  
 N° Alette Girante n.v.  
 Distanza Girante n.v.

**FIAT**

**ELBA**

1.7 D	04/1989→12/1996	D	146B2.000
-------	-----------------	---	-----------

**FIORINO II**

17	01/1988→10/1999	D	146B2.000
----	-----------------	---	-----------

1.7 D	05/1988→10/1999	D	149B3.000
-------	-----------------	---	-----------

1.7 D	10/1993→10/1999	D	146B2.000
-------	-----------------	---	-----------

1.7 TD	01/1997→01/2011	D	146D7.000
--------	-----------------	---	-----------

1.7 TD S	11/1996→05/2000	D	146D7.000
----------	-----------------	---	-----------

60 1.7 D	05/1988→05/2000	D	149B3.000
----------	-----------------	---	-----------

60 1.7 D	05/1988→10/1996	D	146B2.000
----------	-----------------	---	-----------

65 1.7 TD	01/1997→01/2011	D	146D7.000
-----------	-----------------	---	-----------

**INNOCENTI**

**ELBA**

1.7 D	08/1991→12/1996	D	146B2.000
-------	-----------------	---	-----------

81346 350981346000



**PULEGGIA**  
 Diametro Puleggia Ø118.5  
 Numero Denti/Gole Puleggia 7  
 Posizione Puleggia 77

**GIRANTE**  
 Diametro Girante Ø60  
 N° Alette Girante 8  
 Distanza Girante 41.5

**CITROËN**

**JUMPY I**

16	10/1995→08/2000	B	220A2.000
----	-----------------	---	-----------

16	10/1995→	B	1580SPI, 220A2.000
----	----------	---	--------------------

1.6 i	10/1995→	B	1580SPI, 220A2.000
-------	----------	---	--------------------

Short	Code
-------	------



Model			
Version		Fuel	Motor code
81346		350981346000	
<b>FIAT</b>			
<b>SCUDO I</b>			
16	02/1996→	B	220A2.000
<b>PEUGEOT</b>			
<b>EXPERT I</b>			
16	02/1996→	B	222A2 (1580SPI)

Short	Code
-------	------



<b>PULEGGIA</b>	
Diametro Puleggia	Ø68
Altezza Puleggia	30.5
Posizione Puleggia	38.75
<b>GIRANTE</b>	
Diametro Girante	Ø76
N° Alette Girante	8
Distanza Girante	17.2

ALFA ROMEO			
------------	--	--	--

145			
1.6 i.e. 16V T.S.	12/1996→01/2011	B	AR38201, AR67601

146			
1.6 i.e. 16V T.S.	11/1996→01/2011	B	AR38201, AR67601

155			
1.6 16V T.S.	05/1996→12/1997	B	AR67601
1.7 T.S. 16V	05/1996→12/1997	B	AR67106

156, Sportwagon			
-----------------	--	--	--

1.6 16V T.SPARK	09/1997→05/2011	B	AR32102, AR32103, AR32104, AR67601
1.8 16V T.SPARK	09/1997→10/2000	B	AR32201
1.8 16V T.SPARK	10/2000→06/2011	B	AR32205

GT II			
1.8 TS	03/2011→	B	AR32205

FIAT			
------	--	--	--

BARCETTA			
1.8 16V	04/1995→	B	183A1.000, 188A6.000

PUNTO II, Van			
1.8 130 HGT	09/1999→	B	183A1.000, 188A6.000

STILO, Station Wagon			
1.8 16V	01/2011→	B	192A4.000

Short	Code
-------	------



Model			
Version		Fuel	Motor code
81351		350981351000	
<b>FIAT</b>			
<b>BRAVA</b>			
14	10/1995→01/2011	B	182A5.000
1.4 12 V	10/1995→08/1998	B	182A3.000
<b>BRAVO I</b>			
14	10/1995→01/2011	B	182A5.000
14	10/1995→01/2011	B	182A3.000
<b>MAREA, Weekend</b>			
1.4 80 12V	09/1996→	B	182A3.000
<b>LANCIA</b>			
<b>Y</b>			
1.4 12V	03/1996→03/2011	B	840A4.000
1.4 12V	10/1996→03/2011	B	840A2.000



<b>PULEGGIA</b>	
Diametro Puleggia	Ø60.5
Altezza Puleggia	26
Posizione Puleggia	33.2
<b>GIRANTE</b>	
Diametro Girante	Ø66
N° Alette Girante	8
Distanza Girante	17.2

FIAT			
------	--	--	--

BRAVA			
14	10/1995→01/2011	B	182A5.000
1.4 12 V	10/1995→08/1998	B	182A3.000

BRAVO I			
14	10/1995→01/2011	B	182A5.000
14	10/1995→01/2011	B	182A3.000

MAREA, Weekend			
1.4 80 12V	09/1996→	B	182A3.000

LANCIA			
--------	--	--	--

Y			
1.4 12V	03/1996→03/2011	B	840A4.000
1.4 12V	10/1996→03/2011	B	840A2.000

Short	Code
-------	------



<b>PULEGGIA</b>	
Diametro Puleggia	Ø48
Altezza Puleggia	34
Posizione Puleggia	41.2
<b>GIRANTE</b>	
Diametro Girante	Ø76
N° Alette Girante	8
Distanza Girante	17.2

ALFA ROMEO			
------------	--	--	--

145			
1.9 JTD	02/1999→01/2011	D	AR32302

146			
1.9 JTD	02/1999→01/2011	D	AR32302

147			
1.9 JTD	01/2011→	D	937A2.000
1.9 JTD	03/2011→	D	182B9.000

1.9 JTDM 16V	04/2011→	D	
1.9 JTDM 8V	05/2011→	D	937A3.000



MAGNETI MARELLI			
Short	Code		
<b>Model</b>			
Version		Fuel	Motor code
<b>81352</b>	<b>350981352000</b>		
<b>ALFA ROMEO</b>			
<b>156, Sportwagon</b>			
1.9 JTD	01/2011→06/2011	D	937A2.000
1.9 JTD	09/1997→10/2000	D	AR32302
1.9 JTD	10/2000→01/2011	D	AR37101
2.4 JTD	02/2011→06/2011	D	841C000
2.4 JTD	09/1997→10/2000	D	AR32501
2.4 JTD	10/2000→06/2011	D	839A6.000
<b>159, Sportwagon</b>			
1.9 JTDM 8V	05/2011→	D	937A7.000, 939A7.000
1.9 JTDM 8V	05/2011→	D	939A1.000
<b>166</b>			
2.4 JTD	02/2011→	D	841C000
2.4 JTD	09/1998→10/2000	D	AR34202
2.4 JTD	10/2000→	D	839A6.000
<b>FIAT</b>			
<b>BRAVA</b>			
1.9 JTD 105	12/1998→01/2011	D	182B4.000
1.9 TD 75 S	03/1996→01/2011	D	182A8.000
<b>BRAVO I</b>			
1.9 JTD 105	12/1998→01/2011	D	182B4.000
1.9 TD 75 S	03/1996→01/2011	D	182A8.000
<b>BRAVO II</b>			
1.9 D Multijet	07/2011→08/2011	D	192B5.000
1.9 D Multijet	07/2011→	D	192A8.000
<b>CROMA II</b>			
1.9 D Multijet	05/2011→	D	939A7.000
1.9 D Multijet	05/2011→	D	939A1.000
<b>DOBLO' I, Cargo</b>			
1.9 D	01/2011→	D	223A6.000
1.9 D Multijet	05/2011→	D	186A9.000
1.9 JTD	03/2011→	D	223A7.000
1.9 JTD	01/2011→	D	182B9.000
<b>GRANDe PUNTO</b>			
1.9 D Multijet	05/2011→	D	199A5.000
1.9 D Multijet	05/2011→	D	939A1.000
<b>IDEA</b>			
1.9 JTD	04/2011→	D	188B2.000
<b>MAREA, Weekend</b>			
1.9 JTD 105	04/1999→01/2011	D	182B4.000
1.9 JTD 110	01/2011→	D	186A6.000
1.9 TD 75	09/1996→	D	182A8.000
2.4 JTD 130	04/1999→	D	185A6.000, 839A5.000

MAGNETI MARELLI			
Short	Code		
<b>Model</b>			
Version		Fuel	Motor code
<b>MULTIPLA</b>			
1.9 JTD	02/2011→	D	186A9.000
1.9 JTD 105	04/1999→	D	182B4.000
1.9 JTD 110	01/2011→02/2011	D	186A6.000
1.9 JTD 115	02/2011→	D	186A8.000
<b>PALIO, Weekend</b>			
1.9 D	09/2000→	D	223A6.000
1.9 JTD EL	01/2011→	D	188A2.000
<b>PUNTO II, Van</b>			
1.9 D 60	02/2000→	D	188A3.000
1.9 DS 60	09/1999→	D	188A3.000
1.9 JTD	02/2000→	D	188A7.000
1.9 JTD	03/2011→	D	188B2.000
1.9 JTD 80	09/1999→	D	188A2.000
<b>SEDICI</b>			
1.9 D Multijet	06/2011→	D	D19AA
<b>SIENA</b>			
19	11/2000→	D	223A6.000
<b>STILO, Station Wagon</b>			
1.9 D	04/2011→	D	192B5.000
1.9 D Multijet	05/2011→	D	192A8.000
1.9 D Multijet	05/2011→	D	192A9.000
1.9 JTD	02/2011→	D	192A3.000
1.9 JTD	04/2011→	D	192B5.000
1.9 JTD	01/2011→	D	192A1.000, 937A7.000
<b>STRADA</b>			
1.9 D	12/2000→	D	223A6.000
1.9 JTD	03/2011→	D	188A2.000
<b>LANCIA</b>			
<b>KAPPA, Station Wagon, Coupé</b>			
2.4 JTD	06/1998→01/2011	D	838A8.000
2.4 T.DS	08/1994→01/2011	D	838A3.000, 838A7.000
<b>LYBRA, Station Wagon</b>			
1.9 JTD	01/2011→	D	937A2.000
1.9 JTD	07/1999→09/2000	D	AR32302
1.9 JTD	09/2000→01/2011	D	AR37101
2.4 JTD	02/2011→	D	841C.000
2.4 JTD	07/1999→09/2000	D	839A5.000, AR32501
2.4 JTD	09/2000→02/2011	D	839A6.000
<b>MUSA</b>			
1.9 Multijet	04/2011→	D	188B2.000
<b>THESIS</b>			
2.4 JTD	02/2011→	D	841C.000

Short	Code
-------	------



Model			
Version		Fuel	Motor code
<b>81352</b>		<b>350981352000</b>	
<b>OPEL</b>			
<b>ASTRA H, Station Wagon, Cabrio, HTC, TwinTop</b>			
1.9 CDTI	06/2011→	D	Z19DTL
1.9 CDTI	04/2011→	D	Z19DT
1.9 CDTI	05/2011→	D	Z19DT
<b>SIGNUM</b>			
1.9 CDTI	04/2011→	D	Z19DT
1.9 CDTI	05/2011→	D	Z19DT
<b>VECTRA C, Station Wagon, GTS</b>			
1.9 CDTI	04/2011→	D	Z19DT
1.9 CDTI	05/2011→	D	Z19DT
1.9 CDTI	05/2011→	D	Z19DT
<b>ZAFIRA B</b>			
1.9 CDTI	05/2011→	D	Z19DT
1.9 CDTI	05/2011→	D	Z19DT
<b>SAAB</b>			
<b>9-3 II, 9-3 X, Station Wagon, Cabrio</b>			
1.9 TiD	05/2011→	D	
1.9 TiD	04/2011→	D	Z19DT
<b>SUZUKI</b>			
<b>SX4</b>			
1.9 DDiS	06/2011→	D	D19AA
1.9 DDiS 4x4	06/2011→	D	D19AA

Short	Code
-------	------



<b>PULEGGIA</b>	
Diametro Puleggia	Ø59.26
Numero Denti/Gole Puleggia	20
Altezza Puleggia	33.5
Posizione Puleggia	64.6
<b>GIRANTE</b>	
Diametro Girante	Ø74
N° Alette Girante	8
Distanza Girante	20.25

CITROËN			
EVASION			
2.1 TD	05/1996→02/2011	D	P8C (XUD11BTE)
<b>XANTIA I, Break</b>			
2.1 Turbo D 12V	06/1995→01/1998	D	P8C (XUD11BTE)
<b>XANTIA II, Break</b>			
2.1 Turbo D 12V	01/1998→02/1999	D	P8C (XUD11BTE)
<b>XM I, Break</b>			
2.1 TD 12V	05/1989→06/1994	D	P8A (XUD11ATE), P8C (XUD11BTE), PHZ (XUD11ATE), PJZ (XUD11ATE)

Short	Code
-------	------





Model			
Version		Fuel	Motor code
<b>XM II, Break</b>			
2.1 TD 12V	05/1994→10/2000	D	P8A (XUD11ATE), P8C (XUD11BTE), PHZ (XUD11ATE), PJZ (XUD11ATE)
<b>FIAT</b>			
<b>ULYSSE I</b>			
2.1 TD	03/1996→10/1999	D	P8C
<b>LANCIA</b>			
<b>ZETA</b>			
2.1 TD	05/1996→09/1999	D	P8C
<b>PEUGEOT</b>			
<b>406, Break, Coupé</b>			
2.1 TD 12V	01/1996→04/2011	D	P8C (XUD11BTE)
<b>605</b>			
2.1 TD 12V	08/1994→09/1999	D	P8C (XUD11BTE)
2.1 Turbo Diesel	06/1989→09/1999	D	PHZ (XUD11ATE)
<b>806</b>			
2.1 td 12V	06/1996→08/1999	D	P8C (XUD11BTE)



Short	Code
-------	------





<b>FLANGIA</b>	
Numero Fori Flangia	3
Dimensione Fori Flangia	M6x1
Posizione Flangia	66.5
<b>GIRANTE</b>	
Diametro Centraggio	Ø48
Diametro Girante	Ø67.5
N° Alette Girante	7
Distanza Girante	9.7

ALFA ROMEO			
147			
3.2 GTA	03/2011→	B	932A.000
<b>156, Sportwagon</b>			
2.5 V6 24V	09/1997→10/2000	B	AR32401
2.5 V6 24V	10/2000→06/2011	B	AR32405
3.2 GTA	02/2011→06/2011	B	932A.000
<b>166</b>			
2.0 V6	09/1998→	B	AR34102
2.5 V6 24V	09/1998→10/2000	B	AR34201
2.5 V6 24V	10/2000→	B	AR36201
3.0 V6 24V	09/1998→10/2000	B	AR34301
3.0 V6 24V	10/2000→	B	AR36101
3.2 V6 24V	03/2011→	B	936A.000
<b>GT II</b>			
3.2 GTA	03/2011→	B	936A.000

MAGNETI MARELLI			
Short	Code		
			
<b>Model</b>			
Version		Fuel	Motor code
<b>81355</b>	<b>350981355000</b>		
<b>ALFA ROMEO</b>			
<b>GTV II</b>			
3.0 V6 24V	10/1996→10/2000	B	AR16102
3.2 V6 24V	03/2011→	B	936A6.000
<b>SPIDER III</b>			
3.0 V6 24V	01/1999→10/2000	B	AR16102
3.2 V6 24V	03/2011→05/2011	B	936A6.000
<b>LANCIA</b>			
<b>KAPPA, Station Wagon, Coupé</b>			
3.0 24V	08/1994→01/2011	B	838B.000
<b>THESIS</b>			
3.0 V6	02/2011→	B	841A.000
3.2 V6	03/2011→	B	841L.000

MAGNETI MARELLI			
Short	Code		
			
<b>Model</b>			
Version		Fuel	Motor code
<b>81360</b>	<b>350981360000</b>		
			
<b>FLANGIA</b>			
Numero Fori Flangia			3
Dimensione Fori Flangia			M8x1.25
Posizione Flangia			95.5
Diametro Mozzo			Ø25.95
<b>GIRANTE</b>			
Diametro Girante			Ø68
N° Alette Girante			12
Distanza Girante			17
<b>FIAT</b>			
<b>ROMA I</b>			
2000 i.e.	03/1987→09/1992	B	154C3.000, 834B.000
2000 i.e.	10/1987→08/1996	B	154C3.046, 834B.146
2000 i.e. Turbo	06/1987→08/1996	B	154C4.046, 834C.146
<b>TEMPRA, Station Wagon</b>			
2.0 i.e.	10/1990→08/1996	B	159A6.046
<b>TIPO</b>			
2.0 i.e.	03/1990→04/1995	B	159A6.046
2.0 i.e.	06/1990→03/1992	B	159A5.046
<b>LANCIA</b>			
<b>DEDRA, Station Wagon</b>			
1.8 i.e.	09/1989→07/1999	B	835A2.046
1.8 i.e.	09/1989→06/1994	B	835A2.000
2.0 i.e.	09/1989→07/1999	B	835A5.046
2.0 i.e.	09/1989→07/1992	B	835A5.000
<b>THEMA, Station Wagon</b>			
2000 i.e.	09/1988→05/1992	B	834B1.000
2000 i.e.	09/1987→05/1992	B	834B.146
2000 Turbo	01/1989→03/1992	B	834C.146

MAGNETI MARELLI			
Short	Code		
			
<b>Model</b>			
Version		Fuel	Motor code
<b>81362</b>	<b>350981362000</b>		
			
<b>FLANGIA</b>			
Numero Fori Flangia			3
Dimensione Fori Flangia			M8x1.25
Posizione Flangia			73.8
Diametro Mozzo			Ø36
Numero Fori Flangia (Serie 2)			3
Dimensione Fori Flangia (Serie 2)			M7x1
<b>GIRANTE</b>			
Diametro Girante			Ø70.5
N° Alette Girante			7
Distanza Girante			29
<b>ALFA ROMEO</b>			
<b>164</b>			
2.5 TD	09/1992→09/1998	D	VM08B, VM32B
<b>CHRYSLER</b>			
<b>VOYAGER II</b>			
2.5 TD	01/1995→01/2011	D	425CLIRS/X
<b>FORD</b>			
<b>SCORPIO II, Station Wagon</b>			
2.5 TD	09/1996→08/1998	D	VM
<b>JEEP</b>			
<b>CHEROKEE I</b>			
2.5 TD	01/1988→	D	
2.5 TD	10/1995→	B	
<b>GRAND CHEROKEE I</b>			
2.5 TD	10/1995→04/1999	D	M51, M52
2.5 TD Laredo	10/1996→09/1998	D	
<b>GRAND CHEROKEE II</b>			
3.1 TD	04/1999→	D	
<b>OPEL</b>			
<b>FRONTERA A</b>			
2.5 TDS	09/1996→10/1998	D	25TDS (VM41B)
<b>ROVER</b>			
<b>800</b>			
825 D/SD	01/1990→02/1999	D	425SL1RR, 4924SHIRG
825 SD	09/1993→02/1999	D	425SL1RR, 4924SHIRG

Short **MAGNETI MARELLI** Code



Model

Version		Fuel	Motor code
---------	--	------	------------

81363 350981363000



**FLANGIA**  
 Numero Fori Flangia 3  
 Dimensione Fori Flangia M8x1.25  
 Posizione Flangia 78.5  
 Diametro Mozzo Ø22  
 Diametro Centraggio Ø25.95

**GIRANTE**  
 Diametro Girante Ø70  
 N° Alette Girante 9  
 Distanza Girante 28.4

**ALFA ROMEO**

**145**

1.9 D	07/1994→02/1999	D	AR67501
1.9 TD	10/1994→02/1999	D	AR33601, AR67501

**146**

1.9 D	05/1995→09/1996	D	AR67501
1.9 TD	12/1994→02/1999	D	AR33601, AR67501

**155**

1.9 TD	04/1993→12/1997	D	AR67501
--------	-----------------	---	---------

**FIAT**

**TEMPRA, Station Wagon**

1.9 D	07/1991→08/1996	D	160A7.000
-------	-----------------	---	-----------

**TIPO**

1.7 D	01/1988→10/1995	D	
1.7 D	01/1988→10/1994	D	149B4.000
1.9 D	07/1991→08/1996	D	160A7.000

**LANCIA**

**DEDRA, Station Wagon**

1.9 TDS	04/1989→07/1999	D	160D1.000, 835A4.000, 835A4.046
---------	-----------------	---	---------------------------------

**DELTA II**

1.9 TD	10/1994→08/1999	D	160D1.000, 835A4.000
--------	-----------------	---	----------------------

81364 350981364000



**PULEGGIA**  
 Diametro Puleggia Ø118.5 / Ø107  
 Numero Denti/Gole Puleggia 5 / 3  
 Posizione Puleggia 84.9

**GIRANTE**  
 Diametro Girante Ø60  
 N° Alette Girante 8  
 Distanza Girante 41.5

**FIAT**

**BRAVA**

1.6 16V	02/1996→01/2011	B	182A4.000
---------	-----------------	---	-----------

Short **MAGNETI MARELLI** Code



Model

Version		Fuel	Motor code
---------	--	------	------------

**BRAVA**

1.6 16V	10/1995→01/2011	B	182A6.000
---------	-----------------	---	-----------

**BRAVO I**

16	09/2000→02/2011	B	182B6.000
1.6 16V	03/1996→01/2011	B	182A4.000
1.6 16V	10/1995→01/2011	B	182A6.000

**DOBLO' I, Cargo**

16	02/2011→	B	182B6.000
1.6 16V	01/2011→	B	182B6.000
1.6 Natural Power	02/2011→	BF	182B6.000

**MAREA, Weekend**

16	03/1999→08/2000	B	185A3.000
16	09/2000→02/2011	B	182B6.000
1.6 100 16V	09/1996→	B	182A4.000
1.6 100 16V Bipower	04/1999→	BF	185A3.000, 186A4.000
1.6 SX	09/2000→02/2011	B	182B5.098

**MULTIPLA**

16	01/2011→05/2011	G	182B6.000
16	04/2011→05/2011	G	182B6.000
16	09/2000→01/2011	B	182B6.000
1.6 100 16V	04/1999→	B	182A4.000
1.6 16V Bipower	04/1999→	BF	186A4.000
1.6 16V Bipower	01/2011→	BF	182B6.000
1.6 16V BLUPower	02/2011→	G	182B6.000
1.6 16V BLUPower	04/1999→	G	186A3.000

**PALIO, Weekend**

16	06/1999→	B	
16	07/1997→03/2011	B	178C7.098, 178D2..011
1.6 16V	01/2011→	B	182B6.000
1.6 16V	04/1996→01/2011	B	178B3.000

**SIENA**

16	11/2000→	B	182B6.000
1.6 16V	09/1998→	B	178B3.000

**STILO, Station Wagon**

1.6 16V	05/2011→	B	192B30
1.6 16V	01/2011→	B	182B6.000

**STRADA**

1.6 Trekking	05/2011→	B	
--------------	----------	---	--

**LANCIA**

**DELTA II**

1.6 i.e.	03/1996→08/1999	B	182A6.000
1.6 i.e. 16V	01/1996→08/1999	B	182A4.000

**LYBRA, Station Wagon**

1.6 16V	07/1999→	B	182A4.000, 182B6.000
---------	----------	---	----------------------

Short	Code
-------	------



### Model

Version	Fuel	Motor code
---------	------	------------

81365	350981365000	
-------	--------------	--



<b>FLANGIA</b>		
Numero Fori Flangia	3	
Dimensione Fori Flangia	M8x1.25	
Posizione Flangia	61.55	
Diametro Mozzo	Ø22	
Diametro Centraggio	Ø25.95	
<b>GIRANTE</b>		
Diametro Girante	Ø70	
N° Alette Girante	9	
Distanza Girante	28.4	

### FIAT

#### PALIO, Weekend

1.7 TD	D	176A3.000
1.7 TD ED	D	176A5.000

#### PUNTO I, Cabrio, Van

1.7 D	D	176B3.000
1.7 TD	D	176A3.000
1.7 TD	D	176A5.000

#### STRADA

1.7 TD	D	176A3.000
--------	---	-----------

### JEEP

#### WRANGLER II

24 ED1	B	
--------	---	--

81366	350981366000	
-------	--------------	--



<b>PULEGGIA</b>		
Diametro Puleggia	Ø118.5	
Numero Denti/Gole Puleggia	4	
Posizione Puleggia	69.9	
<b>GIRANTE</b>		
Diametro Girante	Ø60	
N° Alette Girante	8	
Distanza Girante	41.5	

### FIAT

#### FIORINO II

14	05/1994→01/2011	B	146D5.000
14	11/1992→10/1996	B	146C5.000
16	01/1994→01/2011	B	146C6.000
70 i.e. 1.4	05/1994→01/2011	B	146C5.000, 146D5.000
75 i.e. 1.6	10/1993→01/2011	B	146C6.000, 146D6.000

#### PALIO, Weekend

14	04/1996→	B	178B2.000
1.4 Cat.	04/1996→	B	178B2.016
1.4 EL	07/1997→01/2011	B	178B2.000

Short	Code
-------	------



### Model

Version	Fuel	Motor code
---------	------	------------

### SIENA

14	04/1996→	B	178B2.000
1.4 Cat.	04/1996→	B	178B2.016

### TEMPRA, Station Wagon

1.4 i.e.	03/1991→08/1996	B	159A2.000
1.4 i.e.	03/1992→08/1996	B	160A1.046, 836A4.000

### INNOCENTI

#### ELBA

1.4 i.e.	09/1994→12/1996	B	146C5.000, 146D5.000
----------	-----------------	---	----------------------

81367	350981367000	
-------	--------------	--



<b>GIRANTE</b>		
Diametro Alberino	M14x1.5	
Tipo Filetto Alberino	Maschio	
Lunghezza Alberino	105.5	
<b>GIRANTE</b>		
Diametro Girante	Ø56	
N° Alette Girante	6	
Distanza Girante	21	

### CITROËN

#### C 25

18	11/1981→01/1994	B	169 (XM7T)
1.8 E	07/1987→02/1994	B	169 (XM7T)
20	01/1987→03/1994	B	170C (XN1T)
2.0 1400 E	01/1987→01/1994	B	
2.0 4x4	01/1990→01/1994	B	
2.0 E	09/1981→03/1994	B	170A (XN1T), 170B (XN1T)

### FIAT

#### DUCATO II

20	06/1990→05/1994	B	170D
20	07/1990→03/1994	B	170D
2.0 4x4	06/1990→05/1994	B	170D

#### TALENTO

20	03/1989→03/1994	B	170B
----	-----------------	---	------

### PEUGEOT

#### J5 II

20	09/1990→01/1994	B	XN1TA
20	09/1990→01/1994	B	170D (XN1TACP), XN1TA

Short **MAGNETI MARELLI** Code



**Model**

Version		Fuel	Motor code
---------	--	------	------------

81368 350981368000



**PULEGGIA**  
 Diametro Puleggia Ø118.5  
 Numero Denti/Gole Puleggia 7  
 Posizione Puleggia 77  
**GIRANTE**  
 Diametro Girante Ø60  
 N° Alette Girante 8  
 Distanza Girante 41.5

**CITROËN**

**JUMPY I**

16	10/1995→08/2000	B	220A2.000
16	10/1995→	B	1580SPI, 220A2.000
1.6 i	10/1995→	B	1580SPI, 220A2.000

**FIAT**

**SCUDO I**

16	02/1996→	B	220A2.000
----	----------	---	-----------

**PEUGEOT**

**EXPERT I**

16	02/1996→	B	222A2 (1580SPI)
----	----------	---	-----------------

81369 350981369000



**PULEGGIA**  
 Diametro Puleggia Ø57  
 Numero Denti/Gole Puleggia 23  
 Altezza Puleggia 23.4  
 Posizione Puleggia 53.9  
**GIRANTE**  
 Diametro Girante Ø63  
 N° Alette Girante 8  
 Distanza Girante 34.5

**ALFA ROMEO**

**MITO**

14	08/2011→	B	955A1.000
14	08/2011→	B	199A1.000
14	08/2011→	B	198A4.000

**FIAT**

**500 II, Cabrio**

12	07/2011→	B	169A4.000
14	07/2011→	B	169A3.000
1.4 Abarth	08/2011→	B	312A1.000

**BRAVA**

1.2 16V 80	10/2000→01/2011	B	188A5.000
1.2 16V 80	12/1998→10/2000	B	182B2.000

Short **MAGNETI MARELLI** Code



**Model**

Version		Fuel	Motor code
---------	--	------	------------

**BRAVO I**

1.2 16V 80	10/2000→01/2011	B	188A5.000
1.2 16V 80	12/1998→10/2000	B	182B2.000

**BRAVO II**

14	07/2011→	B	192B2.000
1.4 T-Jet	07/2011→	B	198A4.000
1.4 T-Jet	07/2011→	B	198A1.000

**DOBLO' I, Cargo**

14	05/2011→	B	350A1.000
----	----------	---	-----------

**GRANDE PUNTO**

12	05/2011→	B	199A4.000
14	05/2011→	B	350A1.000
1.4 16V	05/2011→	B	199A6.000
1.4 Abarth	07/2011→	B	
1.4 Abarth	07/2011→	B	199A8.000
1.4 Natural Power	08/2011→	BF	350A1.000
1.4 T-Jet	07/2011→	B	198A4.000

**IDEA**

1.2 16V	04/2011→	B	188A5.000
14	05/2011→	B	350A1.000
14	03/2011→	B	192B2.000
1.4 16V	04/2011→	B	843A1.000

**LINEA**

14	07/2011→	B	350A1.000
1.4 T-Jet	07/2011→	B	198A4.000

**MAREA, Weekend**

1.2 16V	10/1998→	B	182B2.000
---------	----------	---	-----------

**PALIO, Weekend**

12	01/2011→	B	188A5.000
----	----------	---	-----------

**PANDA I, Van**

11	09/2000→04/2011	B	187A1.000
1.1 AWD	09/2000→04/2011	B	187A1.000

**PANDA II, Van**



11	03/2011→	B	187A1.000
12	03/2011→	B	188A4.000
1.2 4x4	04/2011→	B	188A4.000
1.2 Bi-Power	07/2011→	BF	188A4.000
1.2 LPG	09/2011→		188A4.000
1.2 X	04/2011→	B	188A4.000
14	06/2011→	B	169A3.000

**PUNTO I, Cabrio, Van**



85 16V 1.2	04/1997→06/2000	B	176B9.000
------------	-----------------	---	-----------

**PUNTO II, Van**

1.2 16V 80	09/1999→	B	188A5.000
14	03/2011→	B	843A1.000

MAGNETI MARELLI			
Short	Code		
			
<b>Model</b>			
Version		Fuel	Motor code
81369	350981369000		
<b>FIAT</b>			
<b>QUBO</b>			
1.4 Natural Power	09/2011→	M	
<b>SIENA</b>			
12	02/2011→	B	
12	01/2011→	B	188A5.000
<b>STILO, Station Wagon</b>			
1.2 16V	02/2011→	B	188A5.000
1.4 16V	04/2011→	B	843A1.000
1.4 16V	05/2011→	B	192B2.000
<b>STRADA</b>			
1.2 Trekking	05/2011→	B	
<b>FORD</b>			
<b>KA II</b>			
12	09/2011→	B	FP4
<b>LANCIA</b>			
<b>DELTA III</b>			
14	08/2011→	B	198A1.000
14	08/2011→	B	198A4.000
<b>MUSA</b>			
14	05/2011→	B	350A1.000
14	04/2011→	B	843A1.000
<b>Y</b>			
1.2 16V	04/1997→03/2011	B	176B9.000
1.2 16V	10/2000→03/2011	B	188A5.000
<b>YPSILON</b>			
12	03/2011→	B	188A5.000
14	06/2011→	B	350A1.000
14	03/2011→	B	843A1.000

81370 350981370000			
			
<b>PULEGGIA</b>			
Diametro Puleggia		Ø59.24	
Numero Denti/Gole Puleggia		24	
Altezza Puleggia		16	
Posizione Puleggia		46.6	
<b>GIRANTE</b>			
Diametro Girante		Ø63	
N° Alette Girante		8	
Distanza Girante		34.5	
<b>FIAT</b>			
<b>DOBLO' I, Cargo</b>			
12	01/2011→	B	223A5.000

MAGNETI MARELLI			
Short	Code		
			
<b>Model</b>			
Version		Fuel	Motor code
<b>PALIO, Weekend</b>			
12	04/1996→01/2011	B	178B5.000, 178E2.000
12	06/1999→10/2000	B	178E2.000
12	07/1997→02/2011	B	178B7.045, 188A4.000
12	01/2011→	B	188A5.000
<b>PANDA I, Van</b>			
11	09/2000→04/2011	B	187A1.000
1.1 AWD	09/2000→04/2011	B	187A1.000
<b>PANDA II, Van</b>			
11	03/2011→	B	187A1.000
12	03/2011→	B	188A4.000
1.2 4x4	04/2011→	B	188A4.000
1.2 X	04/2011→	B	188A4.000
<b>PUNTO II, Van</b>			
1.2 60	09/1999→	B	188A4.000
1.2 Natural Power	03/2011→	BF	188A4.000
<b>SEICENTO, Van</b>			
11	01/1998→	B	176B2.000, 187A1.000
<b>SIENA</b>			
12	01/2011→	B	188A4.000
12	09/1998→	B	178B5.000
<b>STRADA</b>			
12	03/2011→	B	188A4.000
<b>LANCIA</b>			
<b>Y</b>			
12	03/1996→03/2011	B	188A4.000, 840A3.000
<b>YPSILON</b>			
12	03/2011→	B	188A4.000

81372 350981372000			
			
<b>PULEGGIA</b>			
Diametro Puleggia		Ø100	
Numero Denti/Gole Puleggia		7	
Posizione Puleggia		85.25	
<b>GIRANTE</b>			
Diametro Girante		Ø70	
N° Alette Girante		9	
Distanza Girante		28.4	
<b>FIAT</b>			
<b>BRAVA</b>			
1.9 D	10/1995→01/2011	D	160A7.000
<b>BRAVO I</b>			
1.9 D	10/1995→01/2011	D	160A7.000

Short **MAGNETI MARELLI** Code



Model

Version		Fuel	Motor code
---------	--	------	------------

81415 350981415000



**PULEGGIA**  
 Diametro Puleggia Ø103  
 Numero Denti/Gole Puleggia 1  
 Posizione Puleggia 163.2

**GIRANTE**  
 Diametro Girante Ø53.8  
 N° Alette Girante 6  
 Distanza Girante 40.3

**FIAT**

**PANDA I, Van**

650	01/1982→04/2011	B	141A.000
650	01/1982→04/2011	B	
900	10/1980→06/1994	B	100GL3.000, 146A.000

**UNO**

45 0.9	03/1983→09/1992	B	146A.000, 146A.1000
--------	-----------------	---	---------------------

**SEAT**

**IBIZA I**

9	08/1986→05/1993	B	146A000
9	08/1990→05/1993	B	09NCA, 146A000

**MARBELLA, Van**

8	08/1986→12/1993	B	08NCA
9	01/1987→12/1993	B	09NCA
9	07/1997→10/1998	B	08NCB
0.9 Cat.	01/1987→11/1996	B	09NCB
0.9 Cat.	11/1996→10/1998	B	08NCB

**TERRA, Van**

9	01/1987→12/1996	B	09NCA
0.9 Cat.	01/1990→12/1995	B	09NCB

81419 350981419000



**FLANGIA**  
 Numero Fori Flangia 4  
 Dimensione Fori Flangia 1/4"x28 UNF  
 Posizione Flangia 94  
 Diametro Mozzo Ø23.75

**GIRANTE**  
 Diametro Girante Ø53.8  
 N° Alette Girante 6  
 Distanza Girante 14.5

**AUSTIN**

**MINI**

1000 Mayfair	08/1982→06/1993	B	99H997P, 99HA53P, 99HC20P
1000 Mayfair Sport	09/1988→06/1993	B	99HD81

Short **MAGNETI MARELLI** Code



Model

Version		Fuel	Motor code
---------	--	------	------------

**ROVER**

**MINI, Cabrio**

1000	01/1992→06/1993	B	99HD81
1300	01/1992→04/1995	B	12A2D
1300	01/1992→04/1995	B	12A2E, 12A2L
1300	10/1992→	B	12A2B

81423 350981423000



**GIRANTE**  
 Diametro Alberino M14x1.5  
 Tipo Filetto Alberino Maschio  
 Lunghezza Alberino 119.05

**GIRANTE**  
 Diametro Girante Ø93.5  
 N° Alette Girante 8  
 Distanza Girante 14.5

**IVECO**

**DAILY I**

13058	01/1989→12/1996		8140.47R.2790
-------	-----------------	--	---------------

81434 350981434000



**FLANGIA**  
 Numero Fori Flangia 3  
 Dimensione Fori Flangia M8x1.25  
 Posizione Flangia 56.8  
 Diametro Mozzo Ø23  
 Diametro Centraggio Ø26

**GIRANTE**  
 Diametro Girante Ø62  
 N° Alette Girante 7  
 Distanza Girante 44

**AUTOBIANCHI**

**Y 10**

10	03/1985→	B	156A.000
1.0 Turbo	03/1985→	B	156A1.000
1.3 i.e. GT	06/1989→	B	156B.000
1.3 i.e. GT	06/1989→	B	146A5.046

**FIAT**

**147, Panorama**

10	10/1976→12/1995	B	127A.000
----	-----------------	---	----------



**DUNA II, Weekend**



1.1 60 S	07/1991→07/1996	B	146A4.048
----------	-----------------	---	-----------

**ELBA**

13	04/1986→12/1993	B	
1.3 D	04/1986→10/1992	D	127A5.000





MAGNETI MARELLI			
Short	Code		
			
<b>Model</b>			
Version		Fuel	Motor code
81434	350981434000		
<b>FIAT</b>			
<b>FIORINO I</b>			
13	12/1987→08/1993	B	146A5.000
<b>FIORINO II</b>			
13	01/1988→12/1994	B	146A5.000
60 1.1	05/1988→12/1993	B	146A9.000
70 1.3	01/1988→12/1994	B	146A5.000
<b>PANDA I, Van</b>			
1300 D	04/1986→12/1992	D	156A5.000
<b>UNO</b>			
10	11/1994→08/2000	B	146A2.166
1.3 Super Diesel	06/1983→03/1992	D	127A5.000, 146B1.000
55 1.0	04/1994→08/2000	B	
<b>INNOCENTI</b>			
<b>ELBA</b>			
13	08/1991→	B	146A5.000
<b>LANCIA</b>			
<b>Y10</b>			
1.3 i.e. Fire	02/1989→12/1995	B	146A5.046, 156B.000
1.3 i.e. Fire	11/1987→05/1993	B	156B.000

MAGNETI MARELLI			
Short	Code		
81436	350981436000		
			
<b>Model</b>			
Version		Fuel	Motor code
<b>LANCIA</b>			
<b>DELTA I</b>			
1.6 GT i.e.	05/1987→08/1992	B	149C2.000
1.6 HF Turbo	08/1986→05/1993	B	
<b>PRISMA</b>			
16	08/1986→02/1992	B	831B6.000



**FLANGIA**  
 Numero Fori Flangia 3  
 Dimensione Fori Flangia M8x1.25  
 Posizione Flangia 65.5  
 Diametro Centraggio Ø25.95



**GIRANTE**  
 Diametro Girante Ø68  
 N° Alette Girante 12  
 Distanza Girante 17

MAGNETI MARELLI			
Short	Code		
			
<b>Model</b>			
Version		Fuel	Motor code
81441	350981441000		
<b>DAIHATSU</b>			
<b>CHARADE III</b>			
1.0 D	03/1987→12/1992	D	CL11
1.0 TD	03/1987→12/1992	D	CL, CL61
<b>HIJET II</b>			
10	12/1992→05/1998	B	CB41
1.0 i	07/1994→05/1998	B	CB42



**FLANGIA**  
 Numero Fori Flangia 4  
 Dimensione Fori Flangia M6x1  
 Posizione Flangia 98.5  
 Diametro Mozzo Ø24

**GIRANTE**  
 Diametro Girante Ø57  
 N° Alette Girante 6  
 Distanza Girante -0.5

MAGNETI MARELLI			
Short	Code		
81443	350981443000		
			
<b>Model</b>			
Version		Fuel	Motor code
<b>ALFA ROMEO</b>			
<b>164</b>			
2.0 Turbo	10/1987→09/1998	B	AR06476
<b>FIAT</b>			
<b>ROMA I</b>			
2000 CHT	01/1991→09/1992	B	
2000 i.e.	03/1987→09/1992	B	154C3.000, 834B.000
2000 i.e.	10/1987→08/1996	B	154C3.046, 834B.146
2000 i.e. Turbo	06/1987→08/1996	B	154C4.046, 834C.146



**FLANGIA**  
 Numero Fori Flangia 3  
 Dimensione Fori Flangia M8x1.25  
 Posizione Flangia 95.5  
 Diametro Mozzo Ø23  
 Diametro Centraggio Ø26

**GIRANTE**  
 Diametro Girante Ø68  
 N° Alette Girante 12  
 Distanza Girante 17

Short	Code
-------	------



Model

Version		Fuel	Motor code
---------	--	------	------------

81445 350981445000



<b>PULEGGIA</b>	
Diametro Puleggia	Ø131
Numero Denti/Gole Puleggia	1
Posizione Puleggia	64
<b>GIRANTE</b>	
Diametro Girante	Ø100
N° Alette Girante	7
Distanza Girante	17.3

FIAT

CROMA I

2500 TD 05/1989→08/1996 D 8144.97, 8144.97Y

LANCIA

THEMA, Station Wagon

2500 Turbo DS 05/1988→07/1992 D 8144.97S

2500 Turbo DS 06/1988→05/1992 D 814497

81452 350981452000

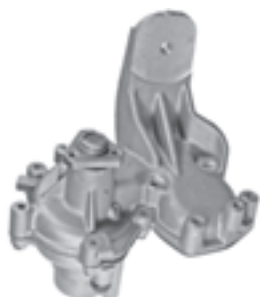

<b>FLANGIA</b>	
Numero Fori Flangia	3
Dimensione Fori Flangia	M8x1.25
Posizione Flangia	78.5
Diametro Mozzo	Ø25.95
<b>GIRANTE</b>	
Diametro Girante	Ø69
N° Alette Girante	7
Distanza Girante	28.5

LANCIA

PRISMA

1.9 Diesel 01/1983→02/1992 D 831D.000

81456 350981456000



<b>FLANGIA</b>	
Numero Fori Flangia	3
Dimensione Fori Flangia	M8x1.25
Posizione Flangia	61.5
Diametro Centraggio	Ø25.95
<b>GIRANTE</b>	
Diametro Girante	Ø70
N° Alette Girante	7
Distanza Girante	28

FIAT

ELBA

1.7 D 04/1989→12/1996 D 146B2.000

Short	Code
-------	------



Model

Version		Fuel	Motor code
---------	--	------	------------

FIORINO I

1.7 Diesel 01/1988→ D 149B2.000

FIORINO II

17 01/1988→10/1999 D 146B2.000

1.7 D 05/1988→10/1999 D 149B3.000

1.7 D 10/1993→10/1999 D 146B2.000

60 1.7 D 05/1988→10/1996 D 146B2.000

60 1.7 D 05/1988→05/2000 D 149B3.000

INNOCENTI

ELBA

1.7 D 08/1991→12/1996 D 146B2.000

81458 350981458000



<b>PULEGGIA</b>	
Diametro Puleggia	Ø103
Numero Denti/Gole Puleggia	1
Posizione Puleggia	163.5
<b>GIRANTE</b>	
Diametro Girante	Ø53.8
N° Alette Girante	6
Distanza Girante	40.3

FIAT

PANDA I, Van

750 01/1986→01/1995 B 141B.000

750 01/1986→07/1992 B 141B.000

81463 350981463000



<b>FLANGIA</b>	
Numero Fori Flangia	3
Dimensione Fori Flangia	M8x1.25
Posizione Flangia	78.5
Diametro Mozzo	Ø22
Diametro Centraggio	Ø25.95
<b>GIRANTE</b>	
Diametro Girante	Ø70
N° Alette Girante	7
Distanza Girante	28

FIAT

TIPO

1.7 D 01/1988→10/1994 D 149B4.000

1.7 D 01/1988→10/1995 D

1.9 D 07/1991→08/1996 D 160A7.000



**Model**

Version		Fuel	Motor code
---------	--	------	------------

81464 350981464000



**PULEGGIA**  
 Diametro Puleggia Ø100  
 Numero Denti/Gole Puleggia 6  
 Posizione Puleggia 80.6

**GIRANTE**  
 Diametro Girante Ø70  
 N° Alette Girante 7  
 Distanza Girante 28

**ALFA ROMEO**

**145**

1.9 D	07/1994→02/1999	D	AR67501
1.9 TD	10/1994→02/1999	D	AR33601, AR67501

**146**

1.9 D	05/1995→09/1996	D	AR67501
1.9 TD	12/1994→02/1999	D	AR33601, AR67501

**155**

1.9 TD	04/1993→12/1997	D	AR67501
--------	-----------------	---	---------

**FIAT**

**TEMPRA, Station Wagon**

1.9 TD	05/1990→08/1996	D	160A6.000, 160D1.000
--------	-----------------	---	----------------------

**TIPO**

1.9 TD	03/1992→06/1993	D	160B6.046
1.9 TD	09/1990→04/1995	D	160A6.000, 160A6.046, 160D1.000

**LANCIA**

**DEDRA, Station Wagon**

1.9 TDS	04/1989→07/1999	D	160D1.000, 835A4.000, 835A4.046
---------	-----------------	---	---------------------------------

81469 350981469000



**FLANGIA**  
 Numero Fori Flangia 3  
 Dimensione Fori Flangia M8x1.25  
 Posizione Flangia 61.5  
 Diametro Mozzo Ø22  
 Diametro Centraggio Ø25.95

**GIRANTE**  
 Diametro Girante Ø70  
 N° Alette Girante 7  
 Distanza Girante 28

**FIAT**

**UNO**

1.9 D	09/1989→03/1994	D	149B5.046
60 Diesel 1.7	09/1989→12/1993	D	146B2.000



**Model**

Version		Fuel	Motor code
---------	--	------	------------

81476 350981476000



**PULEGGIA**  
 Diametro Puleggia Ø122.5  
 Numero Denti/Gole Puleggia 4  
 Posizione Puleggia 76.7

**GIRANTE**  
 Diametro Girante Ø65  
 N° Alette Girante 7  
 Distanza Girante 50

**FIAT**

**ELBA**

14	10/1993→02/1995	B	146D5.000
16	01/1994→12/1996	B	

**FIORINO II**

14	05/1994→01/2011	B	146D5.000
14	11/1992→10/1996	B	146C5.000
16	01/1994→01/2011	B	146C6.000
70 i.e. 1.4	05/1994→01/2011	B	146C5.000, 146D5.000
75 i.e. 1.6	10/1993→01/2011	B	146C6.000, 146D6.000

**TEMPRA, Station Wagon**

1.4 i.e.	03/1991→08/1996	B	159A2.000
1.4 i.e.	03/1992→08/1996	B	160A1.046, 836A4.000
16	03/1990→04/1993	B	159A3.000
16	04/1990→06/1993	B	159A3.048
1.6 i.e.	06/1990→08/1996	B	159A3.046, 835C1.000

**TIPO**

1.4 i.e.	05/1989→04/1995	B	160A1.046, 836A4.000
1.4 i.e.	05/1989→04/1995	B	159A2.000
1.6 i.e.	07/1990→01/1993	B	159A3.046
1.6 i.e.	10/1992→04/1995	B	159A3.048, 835C1.000

**UNO**

70 i.e. 1.4	09/1989→12/1993	B	160A1.046
70 i.e. 1.4	09/1989→12/1993	B	146C1.000

**INNOCENTI**

<b>ELBA</b>			
1.4 i.e.	09/1994→12/1996	B	146C5.000, 146D5.000
1.6 i.e.	09/1994→12/1996	B	146C6.000, 146D6.000

**LANCIA**

**DEDRA, Station Wagon**

1.6 i.e.	08/1989→03/1993	B	835A1.046
1.6 i.e.	08/1989→06/1994	B	835A1.000

Short **MAGNETI MARELLI** Code



Model

Version		Fuel	Motor code
---------	--	------	------------

81477 350981477000



**FLANGIA**  
 Numero Fori Flangia 3  
 Dimensione Fori Flangia M8x1.25  
 Posizione Flangia 83.5  
 Diametro Mozzo Ø23  
 Diametro Centraggio Ø25.95  
**GIRANTE**  
 Diametro Girante Ø68  
 N° Alette Girante 12  
 Distanza Girante 17

FIAT

TEMPRA, Station Wagon

1.8 i.e. 03/1990→08/1996 B

TIPO

1.6 SX DGT 05/1989→10/1992 B 159A3.000

1.8 i.e.16V Sport 11/1989→06/1992 B 160A5.000

81481 350981481000



**PULEGGIA**  
 Diametro Puleggia Ø115  
 Numero Denti/Gole Puleggia 1  
 Posizione Puleggia 74  
**GIRANTE**  
 Diametro Girante Ø65  
 N° Alette Girante 7  
 Distanza Girante 50

FIAT

UNO

1.4 Turbo i.e. 09/1989→09/1993 B 146A8.046

1.4 Turbo i.e. 12/1989→12/1996 B 146A8.000

70 i.e. 1.4 09/1989→12/1993 B 146C1.000

70 i.e. 1.4 09/1989→12/1993 B 160A1.046

INNOCENTI

KORAL

55 01/1990→12/1992 B

LANCIA

DELTA I

13 09/1979→08/1992 B 831A2.000, 831B.000

13 09/1983→08/1992 B

15 09/1979→12/1992 B 831A1.000, 831B1.000

PRISMA

13 01/1983→02/1992 B

Short **MAGNETI MARELLI** Code



Model

Version		Fuel	Motor code
---------	--	------	------------

81482 350981482000



**PULEGGIA**  
 Diametro Puleggia Ø115  
 Numero Denti/Gole Puleggia 1  
 Posizione Puleggia 78.5  
**GIRANTE**  
 Diametro Girante Ø65  
 N° Alette Girante 7  
 Distanza Girante 50

FIAT

ELBA

15 01/1992→12/1996 B 149C1.000

15 04/1986→10/1992 B

FIORINO I

15 01/1988→08/1993 B 149C1.000

FIORINO II

1.5 iE 01/1988→10/1992 B 149C1.000

75 i.e. 1.5 05/1988→12/1993 B 149C1.000

UNO

75 i.e. 1.5 10/1985→12/1993 B 138C2.048, 149C1.000

INNOCENTI

ELBA

1.5 i.e. 08/1992→09/1994 B 149C1.000

LANCIA

DELTA I

15 09/1979→12/1992 B 831A1.000, 831B1.000

PRISMA

15 08/1986→02/1992 B 831B1.000

15 09/1985→02/1992 B 138C2.048, 831B1.048

81488 350981488000



**FLANGIA**  
 Numero Fori Flangia 3  
 Dimensione Fori Flangia M8x1.25  
 Posizione Flangia 82.75  
 Diametro Mozzo Ø27.88  
**GIRANTE**  
 Diametro Girante Ø93.5  
 N° Alette Girante 8  
 Distanza Girante 14.5

FIAT

DUCATO II

2.5 D 07/1990→03/1994 D 814467

2.5 D 4x4 07/1990→03/1994 D 814467

Short **MAGNETI MARELLI** Code



**Model**

Version		Fuel	Motor code
---------	--	------	------------

81488 350981488000

**FIAT**

**DUCATO II**

2.5 TD	07/1990→03/1994	D	814027
2.5 TD 4x4	06/1990→05/1994	D	814027
2.5 TD 4x4	07/1990→03/1994	D	814027

81489 350981489000



<b>FLANGIA</b>	
Numero Fori Flangia	3
Dimensione Fori Flangia	M8x1.25
Posizione Flangia	78.5
Diametro Mozzo	Ø22
Diametro Centraggio	Ø25.95
<b>GIRANTE</b>	
Diametro Girante	Ø70
N° Alette Girante	7
Distanza Girante	28.4

**FIAT**

**DUCATO II**

1.9 D	07/1990→03/1994	D	149B1.000
1.9 TD	03/1989→03/1994	D	280A1.000

**TALENTO**

1.9 D	03/1989→03/1994	D	149B1.000
-------	-----------------	---	-----------

81490 350981490000



<b>FLANGIA</b>	
Numero Fori Flangia	3
Dimensione Fori Flangia	M8x1.25
Posizione Flangia	95.5
Diametro Mozzo	Ø23
Diametro Centraggio	Ø25.95
<b>GIRANTE</b>	
Diametro Girante	Ø68
N° Alette Girante	12
Distanza Girante	17

**FIAT**

**CROMA I**

2000 16V	08/1992→08/1996	B	154E1.000
----------	-----------------	---	-----------

**LANCIA**

**DELTA I**

2.0 16V HF Evo INTEGRale	06/1993→01/1994	B	831E5.000, 831E5.046
--------------------------	-----------------	---	----------------------

2.0 HF INTEGRale	12/1986→12/1992	B	831C5.046
------------------	-----------------	---	-----------

**KAPPA, Station Wagon, Coupé**

2.0 16V Turbo	02/1995→01/2011	B	838A4.000
---------------	-----------------	---	-----------

Short **MAGNETI MARELLI** Code



**Model**

Version		Fuel	Motor code
---------	--	------	------------

**THEMA, Station Wagon**

2000 16V	05/1992→07/1994	B	834F1.000
2000 16V Turbo	10/1992→07/1994	B	834F2.000
2000 i.e. 16V	02/1989→05/1992	B	834B2.246
2000 i.e. 16V	05/1988→08/1992	B	834B2.000
2000 i.e. 16V Turbo	04/1989→03/1993	B	834C1.246
2000 Turbo 16V	11/1992→07/1994	B	834F2.000

81491 350981491000



<b>FLANGIA</b>	
Numero Fori Flangia	3
Dimensione Fori Flangia	M8x1.25
Posizione Flangia	82
Diametro Mozzo	Ø28
<b>GIRANTE</b>	
Diametro Girante	Ø93.5
N° Alette Girante	8
Distanza Girante	14.5

**IVECO**

**DAILY I**

13058	01/1989→12/1996		8140.47R.2790
-------	-----------------	--	---------------

**RENAULT**

**MASTER II**

2.5 D	07/1998→01/2011	D	S8U770
-------	-----------------	---	--------

81493 350981493000



<b>PULEGGIA</b>	
Diametro Puleggia	Ø145
Numero Denti/Gole Puleggia	1
Posizione Puleggia	73
<b>GIRANTE</b>	
Diametro Girante	Ø80
N° Alette Girante	10
Distanza Girante	-1

**CITROËN**

**C 35**

20	11/1973→01/1994	B	B20614
----	-----------------	---	--------

2.5 D	02/1980→01/1994	D	B25637
-------	-----------------	---	--------

Short	Code
-------	------



Model

Version		Fuel	Motor code
---------	--	------	------------

81497 350981497000



<b>PULEGGIA</b>	
Diametro Puleggia	Ø104
Numero Denti/Gole Puleggia	1
Posizione Puleggia	65.8
<b>GIRANTE</b>	
Diametro Girante	Ø69
N° Alette Girante	7
Distanza Girante	45.6

SEAT

IBIZA I

1.7 D	06/1984→05/1993	D	022A.5000
1.7 D	08/1990→05/1993	D	022A.5000

81498 350981498000



<b>PULEGGIA</b>	
Diametro Puleggia	Ø58
Posizione Puleggia	78.5
<b>GIRANTE</b>	
Diametro Girante	Ø67.5
N° Alette Girante	8
Distanza Girante	9.5

SEAT

IBIZA I

12	11/1984→12/1993	B	021A1000
12	11/1984→12/1993	B	021A1000
1.2 i	01/1989→05/1993	B	021C.1000
15	11/1984→05/1993	B	021A2000
1.5 i	10/1986→05/1993	B	021B.2000
1.5 i	10/1986→05/1993	B	021D.2000
1.5 i Cat.	10/1986→05/1993	B	021C.2000
17	01/1991→05/1993	B	021A.3000
17	01/1991→05/1993	B	021B.3000

MALAGA

12	05/1985→12/1993	B	021A1000
12	11/1984→12/1993	B	021A1000
1.2 i	12/1989→12/1993	B	021C.1000
15	05/1985→12/1993	B	021A2000
1.5 i	01/1987→12/1993	B	021B.2000
1.5 i Cat.	10/1986→12/1993	B	021A2000, 021C.2000, 021D.2000

Short	Code
-------	------



Model

Version		Fuel	Motor code
---------	--	------	------------

81499 350981499000



<b>FLANGIA</b>	
Numero Fori Flangia	4
Dimensione Fori Flangia	M6x1
Posizione Flangia	80
Diametro Mozzo	M30x1.5
SX	
Diametro Centraggio	Ø35
<b>GIRANTE</b>	
Diametro Girante	Ø77
N° Alette Girante	4
Distanza Girante	15.4

MERCEDES-BENZ

Cabriolet, Coupé III (124)

220 CE	10/1992→05/1993	B	M111.960
--------	-----------------	---	----------

cl. C I, Station Wagon (202)

C 180	03/1993→05/2000	B	M111.920, M111.921
C 180	11/1994→05/2000	B	M111.921
C 180 T	06/1996→09/2000	B	M111.920, M111.921
C 180 T	09/2000→01/2011	B	M111.952
C 200	01/1994→05/2000	B	M111.941, M111.945
C 200 CDI	03/1998→05/2000	D	OM611.960
C 200 Kompressor	10/1995→05/2000	B	M111.944
C 200 Kompressor	11/1996→05/2000	B	M111.944
C 200 T	06/1996→01/2011	B	M111.941, M111.945
C 200 T Kompressor	09/2000→01/2011	B	M111.956
C 200 T Kompressor	11/1996→01/2011	B	M111.944
C 220	03/1993→05/2000	B	M111.961
C 220 T D	06/1996→09/1998	D	OM604.910
C 230	06/1996→06/1997	B	M111.974
C 230 T	06/1996→06/1998	B	M111.974

cl. E I, Station Wagon, Cabrio, Coupé (124)

E 200	06/1993→03/1998	B	M111.940
E 200 T	06/1993→06/1996	B	M111.940
E 220	06/1993→03/1998	B	M111.960
E 220 T	06/1993→06/1996	B	M111.960

cl. E II, Station Wagon (210)



E 200	06/1995→08/2000	B	M111.942
E 200 Kompressor	08/2000→02/2011	B	M111.957
E 200 T	06/1996→08/2000	B	M111.942
E 200 T Kompressor	08/2000→03/2011	B	M111.957
E 230	06/1995→06/1997	B	M111.970
E 230 T	06/1996→06/1997	B	M111.970

cl. M I (163)

ML 230	02/1998→05/2011	B	M111.977
--------	-----------------	---	----------



cl. S V (220), Coupé (215)

S 500	10/1998→05/2011	B	M113.960
-------	-----------------	---	----------

Short		Code	
			
<b>Model</b>			
Version		Fuel	Motor code
81499			350981499000
<b>MERCEDES-BENZ</b>			
<b>CLK I, Cabrio (208)</b>			
200	06/1997→02/2011	B	M111.941, M111.945
<b>SLK I (170)</b>			
200	09/1996→03/2000	B	M111.946

81503		350981503000	
			
<b>FLANGIA</b>			
Numero Fori Flangia			4
Dimensione Fori Flangia			M8x1.25
Posizione Flangia			90
<b>GIRANTE</b>			
Diametro Girante			Ø68.5
N° Alette Girante			8
Distanza Girante			32
<b>MERCEDES-BENZ</b>			
<b>cl. G (460, 461, 463)</b>			
230 G	03/1979→07/1993	B	M115.973
230 GE	06/1990→06/1993	B	M102.989
<b>PUCH</b>			
<b>cl. G</b>			
230 GE	04/1982→08/1992	B	M102.981, M102.987
230 GE	06/1990→06/1993	B	M102.989
300 GD	09/1989→	D	OM603.931
G 300 TD	08/1996→	D	OM606.964

81504		350981504000	
			
<b>FLANGIA</b>			
Numero Fori Flangia			4
Dimensione Fori Flangia			M6x1
Posizione Flangia			115
Diametro Mozzo			Ø27
<b>GIRANTE</b>			
Diametro Girante			Ø69
N° Alette Girante			8
Distanza Girante			21.5
<b>MERCEDES-BENZ</b>			
<b>190</b>			
D 2.0	08/1989→08/1993	D	OM601.911
<b>cl. C I, Station Wagon (202)</b>			
C 200 D	10/1996→05/2000	D	OM604.915
<b>cl. E I, Station Wagon, Cabrio, Coupé (124)</b>			
E 200 D	06/1993→06/1995	D	OM601.912

Short		Code	
			
<b>Model</b>			
Version		Fuel	Motor code
81506			350981506000

		<b>FLANGIA</b>	
		Numero Fori Flangia	4
		Dimensione Fori Flangia	M6x1
		Posizione Flangia	106
		Numero Fori Flangia (Serie 2)	2
		Dimensione Fori Flangia (Serie 2)	Ø6
		Diametro Mozzo	Ø35
		<b>GIRANTE</b>	
		Diametro Girante	Ø69
		N° Alette Girante	8
		Distanza Girante	21.5



<b>DAEWOO</b>			
<b>KORANDO, Cabrio</b>			
2.9 D	01/1999→	D	MB-OM662
2.9 TD	01/1999→	D	MB-OM60129TD
<b>MUSSO</b>			
2.2 TD	09/1999→	D	MBOM601
2.9 D	01/1999→09/1999	D	MB-OM662
2.9 TD	01/1999→	D	MB-OM60129TD
<b>MERCEDES-BENZ</b>			
<b>190</b>			
D 2.5	04/1985→08/1993	D	OM602.911
D 2.5	08/1989→08/1993	D	OM602.911
Turbo-D 2.5	02/1988→08/1993	D	OM602.961
Turbo-D 2.5	02/1988→08/1993	D	OM602.961
<b>cl. C I, Station Wagon (202)</b>			
C 250 D	05/1993→05/2000	D	OM605.910
<b>cl. E I, Station Wagon, Cabrio, Coupé (124)</b>			
E 250 D	07/1993→06/1995	D	OM605.911
E 250 T D	06/1993→06/1996	D	OM605.911
E 250 Turbo-D	06/1993→06/1995	D	OM602.962
E 300 D	07/1993→06/1995	D	OM606.910
E 300 T D	06/1993→06/1996	D	OM606.910
E 300 T Turbo-D	06/1993→06/1996	D	OM603.960
E 300 T Turbo-D 4-matic	06/1993→06/1996	D	OM603.963
E 300 Turbo-D	06/1993→06/1995	D	OM603.960
E 300 Turbo-D 4-matic	06/1993→06/1995	D	OM603.963
<b>cl. E II, Station Wagon (210)</b>			
E 250 D	06/1995→07/1999	D	OM605.912
E 250 T D	06/1996→07/1999	D	OM605.912
E 250 T Turbo-D	06/1997→07/1999	D	OM605.962
E 250 Turbo-D	06/1997→07/1999	D	OM605.962
E 290 T Turbo-D	06/1996→07/1999	D	OM602.982
E 290 Turbo-D	03/1996→07/1999	D	OM602.982

MAGNETI MARELLI			
Short	Code		
<b>Model</b>			
Version		Fuel	Motor code
<b>MERCEDES-BENZ</b>			
<b>cl. E II, Station Wagon (210)</b>			
E 300 D	06/1995→06/1997	D	OM606.912
E 300 T Turbo-D	12/1996→07/1999	D	OM606.962
E 300 Turbo-D	12/1996→07/1999	D	OM606.962
<b>cl. G (460, 461, 463)</b>			
250 GD	06/1990→	D	OM602.931
250 GD	10/1987→12/1992	D	OM602.930
250 GD	12/1988→08/1992	D	OM602.930
290 GD/G 290 D	04/1992→	D	OM602.942
300 GD	12/1990→09/1997	D	OM603.931
350 G Turbo D	09/1991→	D	OM603.972
350 G Turbo-D	09/1991→09/1997	D	OM603.972
G 300 TD	08/1996→	D	OM606.964
<b>cl. S IV, Coupé (140)</b>			
S 300 Turbo-D	05/1996→10/1998	D	OM606.961
S 350 Turbo-D	01/1993→10/1998	D	OM603.971
<b>cl. V</b>			
V 230 TD	09/1996→03/2011	D	OM601.970
<b>SPRINTER I (904)</b>			
2.3 D 4x4	06/1997→12/1999	D	OM601.943
410 D	02/1996→06/2011	D	OM602.980
410 D 4x4	05/1997→06/2011	D	OM602.980
412 D	02/1996→06/2011	D	OM602.980
412 D	02/1996→06/2011	D	OM602.980
412 D 4x4	05/1997→06/2011	D	OM602.980
412 D 4x4	05/1997→06/2011	D	OM602.980
<b>SPRINTER II (905)</b>			
2.3 D 4x4	06/1997→12/1999	D	OM601.943
2.9 TDi	01/1997→12/1999	D	OM602.980
208 D	02/1995→04/2000	D	OM601.943
210 D	01/1997→04/2000	D	OM602.980
212 D	02/1995→04/2000	D	OM602.980
308 D 2.3	02/1995→04/2000	D	
310 D 2.9	02/1995→04/2000	D	OM602.980
310 D 4x4	05/1997→02/2011	D	OM602.980
312 D 2.9	02/1995→04/2000	D	OM602.980
312 D 2.9 4x4	05/1997→02/2011	D	OM602.980
<b>T1 I (601)</b>			
208 D 2.3	10/1988→02/1996	D	OM601.940
208 D 2.3	10/1988→02/1996	D	OM601.940
210 D 2.8	10/1988→02/1996	D	OM602.940
210 D 2.8	10/1988→02/1996	D	OM602.940
210 D 2.9	11/1988→02/1996	D	OM602.940

MAGNETI MARELLI			
Short	Code		
<b>Model</b>			
Version		Fuel	Motor code
<b>T1 II (602)</b>			
308 D 2.3	06/1989→02/1996	D	OM601.940
308 D 2.3	11/1988→02/1996	D	OM601.940
310 D 2.9	06/1989→02/1996	D	OM602.940
310 D 2.9	06/1989→02/1996	D	OM602.940
<b>VITO - Viano I (638)</b>			
108 D 2.3	02/1996→03/2011	D	OM601.942
108 D 2.3	03/1997→03/2011	D	OM601.942
110 D 2.3	03/1997→03/2011	D	OM601.970
110 TD 2.3	02/1996→03/2011	D	OM601.970
<b>PUCH</b>			
<b>G-MODELL</b>			
290 GD/G 290 D	04/1992→	D	OM602.942
350 G Turbo D	09/1991→	D	OM603.972
G 290 TD	07/1997→	D	OM602.983
<b>SSANGYONG</b>			
<b>KORANDO</b>			
2.3 D	12/1996→	D	OM601.940
2.9 D	12/1996→	D	MB-OM662
2.9 TD	04/1998→	D	
<b>MUSSO</b>			
2.3 D	10/1995→	D	MB-OM661, OM601.940
2.9 D	03/1996→	D	MB-OM662
2.9 TD	04/1998→	D	
<b>REXTON</b>			
29	02/2011→	D	



81507	350981507000
<b>FLANGIA</b>	
Numero Fori Flangia	3
Dimensione Fori Flangia	M8x1.25
Posizione Flangia	128.2
Diametro Mozzo	Ø30
<b>GIRANTE</b>	
Diametro Girante	Ø76
N° Alette Girante	4
Distanza Girante	22
<b>MERCEDES-BENZ</b>	
<b>190</b>	
E 2.6	09/1986→08/1993 B M103.942
<b>Cabriolet, Coupé III (124)</b>	
300 CE	03/1987→05/1993 B M103.983
<b>cl. E I, Station Wagon, Cabrio, Coupé (124)</b>	
E 300 4-matic	06/1993→06/1995 B M103.985
E 300 T 4-matic	06/1993→06/1996 B M103.985



MAGNETI MARELLI			
Short	Code		
			
<b>Model</b>			
Version		Fuel	Motor code
<b>81507</b>	<b>350981507000</b>		
<b>MERCEDES-BENZ</b>			
<b>cl. G (460, 461, 463)</b>			
300 GE	06/1990→	B	M103.987
300 GE	09/1989→09/1997	B	M103.987
<b>SL III (129)</b>			
300 SL	03/1989→08/1993	B	M103.984
<b>PUCH</b>			
<b>G-MODELL</b>			
300 GE	06/1990→	B	M103.987

MAGNETI MARELLI			
Short	Code		
<b>81508</b>	<b>350981508000</b>		
			
<b>GIRANTE</b>		M12x1.5 Femmina	
Diametro Alberino		M12x1.5 Femmina	
Tipo Filetto Alberino		M12x1.5 Femmina	
Lunghezza Alberino		98	
<b>GIRANTE</b>		Ø68.5	
Diametro Girante		8	
N° Alette Girante		32.5	
Distanza Girante			
<b>MERCEDES-BENZ</b>			
<b>100</b>			
D	02/1988→05/1992	D	OM616.963
D	12/1990→02/1996	D	OM616.963
D	12/1990→12/1994	D	OM616
<b>cl. G (460, 461, 463)</b>			
300 GD	09/1989→	D	OM603.931

MAGNETI MARELLI			
Short	Code		
<b>81509</b>	<b>350981509000</b>		
			
<b>FLANGIA</b>		4	
Numero Fori Flangia		M6x1	
Dimensione Fori Flangia		98	
Posizione Flangia		Ø27	
Diametro Mozzo			
<b>GIRANTE</b>		Ø80	
Diametro Girante		4	
N° Alette Girante		20.5	
Distanza Girante			
<b>DAEWOO</b>			
<b>KORANDO, Cabrio</b>			
23	01/1999→	B	
<b>MUSSO</b>			
23	01/1999→	B	M111.970

MAGNETI MARELLI			
Short	Code		
			
<b>Model</b>			
Version		Fuel	Motor code
<b>MERCEDES-BENZ</b>			
<b>190</b>			
2.0 E	10/1988→05/1993	B	M102.962
E 1.8	04/1990→08/1993	B	M102.910
E 2.0	01/1985→08/1993	B	M102.962
E 2.0	10/1982→06/1993	B	M102.961, M102.962
E 2.0	10/1982→06/1993	B	
E 2.3	10/1986→08/1993	B	M102.985
E 2.5-16	03/1989→08/1993	B	M102.991
E 2.5-16	09/1988→08/1993	B	M102.990
E Evolution II 2.5	05/1990→08/1993	B	M102.992
<b>Cabriolet, Coupé III (124)</b>			
230 CE	03/1987→12/1992	B	M102.982
230 CE	03/1987→12/1992	B	M102.982



MAGNETI MARELLI			
Short	Code		
<b>81512</b>	<b>350981512000</b>		
			
<b>PULEGGIA</b>		Ø59.26	
Diametro Puleggia		20	
Numero Denti/Gole Puleggia		33.5	
Altezza Puleggia		42.5	
Posizione Puleggia			
<b>GIRANTE</b>		Ø60	
Diametro Girante		6	
N° Alette Girante		40	
Distanza Girante			



MAGNETI MARELLI			
Short	Code		
<b>CITROËN</b>			
<b>BERLINGO I, Furgonato</b>			
1.8 i	05/1997→02/2011	B	LFX (XU7JB)
1.8 i 4WD	04/1997→	B	LFX (XU7JB)
<b>BX, Break</b>			
1.9 GTi 4x4	02/1992→06/1994	B	
1.9 TZi	02/1992→12/1994	B	
15	10/1987→05/1992	B	B1E (XU51C)
16	01/1987→12/1994	B	B1E (XU51C)
16	03/1986→12/1994	B	180Z
16	05/1989→12/1994	B	BDY (XU5M), BDZ (XU5M)
16	07/1985→12/1994	B	171D
16	09/1987→02/1993	B	B1A (XU51C/K)
16	09/1988→12/1994	B	BAY (XU5CP), BAZ (XU5CP)
16	10/1982→12/1992	B	XU52C
16 E	05/1989→02/1993	B	BDY (XU5M), BDZ (XU5M)
19	06/1988→12/1994	B	DDZ (XU9M)
19	06/1988→12/1994	B	DKZ (XU9JA)
19	07/1986→12/1994	B	D2A (XU92C)
19 Cat.	07/1986→12/1994	B	DFZ (XU9J1)

MAGNETI MARELLI			
Short	Code		
<b>Model</b>			
Version		Fuel	Motor code
<b>81512</b>	<b>350981512000</b>		
<b>CITROËN</b>			
<b>BX, Break</b>			
19 E	06/1988→02/1993	B	DDZ (XU9M)
19 E 4x4	04/1989→02/1993	B	D2F
19 GTi	06/1988→02/1993	B	DKZ (XU9JA)
19 GTi	07/1986→02/1993	B	D6A (XU9J2)
19 GTi 16V	03/1988→02/1993	B	DFW (XU9J4)
19 GTi 4x4	06/1988→02/1993	B	DKZ (XU9JA)
<b>EVASION</b>			
18	05/1997→02/2011	B	LFZ (XU7JP)
<b>XANTIA I, Break</b>			
1.6 i	03/1993→01/1998	B	BFZ (XU5JP)
1.8 i	03/1993→01/1998	B	LFZ (XU7JP)
1.8 i	04/1997→01/1998	B	LFX (XU7JB)
<b>XANTIA II, Break</b>			
1.8 i	01/1998→03/2011	B	LFX (XU7JB)
<b>XSARA, Break, Coupé, PICASSO</b>			
1.8 i	02/1998→09/2000	B	LFZ (XU7JP)
1.8 i	04/1997→09/2000	B	LFX (XU7JB)
1.8 i Aut.	04/1997→09/2000	B	LFZ (XU7JP)
1.8 SX	06/2000→05/2011	B	
<b>ZX, Break</b>			
1.6 i	03/1991→10/1997	B	BDY (XU5M), BFZ (XU5JP)
1.8 i	07/1992→10/1997	B	LFZ (XU7JP)
1.9 i	03/1991→06/1997	B	DKZ (XU9JA)
<b>FIAT</b>			
<b>ULYSSE I</b>			
18	05/1997→02/2011	B	LFW
<b>PEUGEOT</b>			
<b>205 I, Cabrio, Van</b>			
1.6 CJ	08/1992→12/1994	B	BDY (XU5M3Z)
1.9 CTI	10/1987→12/1994	B	DFZ (XU9J1)
<b>205 II, Van</b>			
1.6 Aut.	05/1990→09/1998	B	BDY (XU5M2Z), BDY (XU5M3Z)
1.6 Aut.	10/1987→09/1998	B	
1.9 GTI	10/1987→09/1998	B	D6B (XU9JA (G-KAT))
1.9 GTI	10/1987→10/1994	B	DKZ (XU9JAZ)
1.9 GTI Cat.	10/1987→07/1994	B	DFZ (XU9J1)
<b>306, Break, Cabrio</b>			
18	05/1993→02/2011	B	LFZ (XU7JP)
1.8 ST	06/1994→01/2011	B	LFZ (XU7JP)
<b>309 II</b>			
16	07/1989→12/1993	B	B2A (XU52C/K)
16	07/1989→12/1993	B	BDY (XU5M2Z), BDY (XU5M3Z), BDZ (XU5M)

MAGNETI MARELLI			
Short	Code		
<b>Model</b>			
Version		Fuel	Motor code
<b>309 II</b>			
16	07/1989→12/1993	B	B2A (XU52C/K)
1.6 GTi	09/1989→10/1993	B	
19	08/1989→12/1993	B	DFZ (XU9J1)
19	10/1990→12/1993	B	DDZ (XU9M)
1.9 GTI	07/1989→12/1993	B	DKZ (XU9JAZ)
1.9 GTI 16V	10/1990→12/1993	B	DFW (XU9J4Z)
<b>405 I, Break</b>			
1.9 4x4	06/1987→07/1992	B	D6C (XU9J4)
1.9 4x4	07/1990→07/1992	B	
1.9 Sport MI-16	04/1988→12/1992	B	DFW (XU9J4Z)
1.9 Sport MI-16 4x4	04/1988→12/1992	B	DFW (XU9J4Z)
<b>405 II, Break</b>			
16	08/1992→10/1996	B	BDY (XU5M2Z), BDY (XU5M3Z), BDZ (XU5M), BFZ (XU5JP)
18	08/1992→10/1996	B	LFZ (XU7JP)
1.9 D	06/1994→10/1996	D	DJY (XUD9A)
1.9 D	08/1992→10/1996	D	DJZ (XUD9Y)
1.9 TD	08/1992→10/1996	D	DHY (XUD9TE)
<b>406, Break, Coupé</b>			
16	11/1995→04/2011	B	BFZ (XU5JP)
18	05/1997→04/2011	B	LFX (XU7JB)
18	05/1997→04/2011	B	LFX (XU7JB)
18	10/1996→03/1999	B	LFZ (XU7JP)
<b>806</b>			
18	07/1995→02/2011	B	LFW (XU7JP)
<b>EXPERT I</b>			
18	10/1996→09/2000	B	LFZ (XU7JP)
<b>PARTNER - Ranch, I</b>			
18	05/1997→	B	LFX (XU7JB)
1.8 D	06/1996→	D	A9A (XUD7)

81513		350981513000	
<b>PULEGGIA</b>			
Diametro Puleggia			Ø59.21
Numero Denti/Gole Puleggia			20
Altezza Puleggia			33.5
Posizione Puleggia			43
<b>GIRANTE</b>			
Diametro Girante			Ø52.8
N° Alette Girante			6
Distanza Girante			41
<b>CITROËN</b>			
<b>AX</b>			
1.4 Allure	08/1992→04/1994	B	

MAGNETI MARELLI			
Short	Code		
			
<b>Model</b>			
Version		Fuel	Motor code
<b>81513</b>	<b>350981513000</b>		
<b>CITROËN</b>			
<b>AX</b>			
1.4 GTi	06/1991→12/1996	B	KFZ (TU3FJ2)
1.4 GTi	06/1991→12/1992	B	KFZ (TU3FJ2)
1.4 GTi	08/1991→12/1996	B	KFY (TU3FJ2)
14	04/1987→04/1997	B	KDX (TU3M/Z), KDY (TU3FM), KDY (TU3M), KDZ (TU3M/Z)
14 4x4	08/1991→12/1996	B	KDX (TU3M/Z), KDY (TU3FM), KDY (TU3M), KDZ (TU3M/Z)
15 D	08/1994→12/1997	D	VJZ (TUD5)
15 D	08/1994→12/1997	D	VJY (TUD5)
<b>BX, Break</b>			
14	01/1986→02/1993	B	150C
14	01/1989→02/1993	B	KDY (TU3M), KDZ (TU3M/Z)
14 E	04/1983→02/1993	B	150C
14 E	09/1985→02/1993	B	150F
<b>SAXO</b>			
1.5 D	09/1996→03/2011	D	VJY (TUD5)
1.5 D	09/1996→01/2011	D	VJZ (TUD5)
1.6 VTL,VTR	05/1996→03/2011	B	NFZ (TU5JP)
1.6 VTS	09/2000→03/2011	B	NFT
<b>XSARA, Break, Coupé, PICASSO</b>			
1.5 D	04/1997→09/2000	D	VJZ (TUD5)
16	02/2011→	B	
16	12/1999→	B	NFV (TU5JP)
16	12/1999→	B	NFZ (TU5JP)
1.6 16V	05/2011→	B	NFU (TU5JP4)
1.6 Chrono	01/2011→04/2011	B	
1.6 i	04/1997→09/2000	B	NFZ (TU5JP)
<b>MEGA</b>			
<b>CLUB I</b>			
1.4 i	01/1992→06/1999	B	
1.4 i 4x4	01/1992→06/1999	B	
1.5 D	01/1994→06/1999	B	
1.5 D 4x4	01/1994→06/1999	B	
<b>CLUB II</b>			
1.4 i	06/1999→	B	
<b>NISSAN</b>			
<b>MICRA II (K11)</b>			
1.5 D	02/1998→03/2011	D	TD15
<b>PEUGEOT</b>			
<b>106 I</b>			
1.5 D	06/1994→04/1996	D	VJY (TUD5)

MAGNETI MARELLI			
Short	Code		
			
<b>Model</b>			
Version		Fuel	Motor code
<b>106 I</b>			
1.5 D	06/1994→04/1996	D	
16	01/1994→04/1996	B	NFY (TU5J2)
<b>106 II</b>			
1.5 D	05/1996→	D	VJY (TUD5)
1.5 D	10/2000→	D	VJX (TUD5)
1.6 i	05/1996→	B	NFW (TU5J2), NFY (TU5J2)
<b>206, Station Wagon, CC, Plus</b>			
1.6 i	09/1998→12/2000	B	NFZ (TU5JP)
<b>306, Break, Cabrio</b>			
16	05/1993→10/2000	B	NFZ (TU5JP)
16	10/2000→02/2011	B	NFT
1.6 SR	06/1994→10/2000	B	NFZ (TU5JP)
<b>405 II, Break</b>			
14	08/1992→10/1996	B	KDX (TU3MC)

## 81520 350981520000



### PULEGGIA

Diametro Puleggia	Ø77.5
Numero Denti/Gole Puleggia	26
Altezza Puleggia	20.5
Posizione Puleggia	29

### GIRANTE

Diametro Girante	Ø60
N° Alette Girante	8
Distanza Girante	31.5

VOLKSWAGEN			
<b>GOLF II</b>			
1.3 Cat.	06/1986→12/1992	B	2G, MH, NZ
<b>POLO II, Classic, Coupé, Van</b>			
10	01/1985→09/1994	B	AAK, AAU, HZ
1.0 Cat.	08/1989→09/1994	B	AAK, AAU, ACM
13	03/1991→09/1994	B	3F
1.3 Cat.	07/1987→09/1994	B	2G, AAV, MH, NZ
1.3 Cat.	10/1989→09/1994	B	3F
1.3 G40	08/1990→09/1994	B	PY

Short **MAGNETI MARELLI** Code



Model

Version		Fuel	Motor code
---------	--	------	------------

81521		350981521000	
-------	--	--------------	--



**FLANGIA**  
 Numero Fori Flangia 3  
 Dimensione Fori Flangia M8x1.25  
 Posizione Flangia 66  
 Diametro Mozzo Ø40

**GIRANTE**  
 Diametro Girante Ø59  
 N° Alette Girante 6  
 Distanza Girante 29.5

**VOLKSWAGEN**

**TRANSPORTER III**

1.6 TD	08/1984→07/1992	D	JX
1.6 TD Syncro	03/1986→07/1992	D	JX

81522 350981522000



**FLANGIA**  
 Numero Fori Flangia 3  
 Dimensione Fori Flangia M8x1.25  
 Posizione Flangia 74  
 Diametro Mozzo Ø30

**GIRANTE**  
 Diametro Girante Ø59  
 N° Alette Girante 6  
 Distanza Girante 29.5

**AUDI**

**100 IV, Avant**

16	03/1992→07/1993	B	
20	08/1992→07/1993	B	ACE
20	12/1990→06/1994	B	AAE
2.0 E	09/1991→06/1994	B	AAE
2.0 E	12/1990→06/1994	B	AAD, ABK
2.0 E 16V	01/1992→06/1994	B	ACE
2.0 E 16V quattro	07/1992→06/1994	B	ACE
2.0 E quattro	12/1990→07/1992	B	AAD
2.0 quattro	08/1992→07/1993	B	ACE

**80 IV, Avant**

16	09/1991→12/1994	B	ABM
1.6 E	06/1993→01/1996	B	ADA
1.9 TD	09/1991→12/1994	D	AAZ
1.9 TDI	09/1991→01/1996	D	1Z
20	09/1991→01/1996	B	ABT
2.0 E	09/1991→01/1996	B	ABK
2.0 E 16V	08/1992→01/1996	B	ACE
2.0 E 16V quattro	04/1992→07/1995	B	ACE

Short **MAGNETI MARELLI** Code



Model

Version		Fuel	Motor code
---------	--	------	------------

**80 IV, Avant**

2.0 E quattro	09/1991→12/1994	B	ABK
2.0 quattro	11/1993→07/1996	B	ADW

**A6 I, Avant**

1.9 TDI	06/1994→12/1997	D	1Z, AHU
20	06/1994→12/1997	B	AAE
20	06/1994→12/1997	B	ABK
20	08/1995→07/1996	B	ADW
2.0 16V	06/1994→12/1997	B	ACE
2.0 16V quattro	06/1994→12/1997	B	ACE

**Cabrio**

1.9 TDI	06/1995→08/2000	D	1Z, AHU
2.0 16V	06/1995→07/1996	B	ACE
2.0 E	01/1993→07/1998	B	ABK

**Coupé II**

20	05/1989→12/1996	B	AAD, ABK
2.0 16 V	01/1992→07/1992	B	0,25
2.0 16 V	08/1992→12/1996	B	ACE

**FORD**

**GALAXY I**

1.9 TDI	03/1995→06/2011	D	1Z, AHU, ANU
1.9 TDI	08/1997→04/2000	D	AFN, AVG

**SEAT**

**ALHAMBRA I**

1.9 TDI	04/1996→	D	1Z, AHU, ANU
1.9 TDI	08/1996→06/2000	D	AFN, AVG
2.0 i	04/1996→	B	ADY, ATM

**CORDOBA I, Vario**

1.6 i	05/1994→06/1999	B	1F
1.6 i	07/1996→06/1999	B	AFT
1.6 i	09/1996→06/1999	B	AEE, ALM
1.7 SDI	07/1997→06/1999	D	
1.8 i	02/1993→06/1999	B	ABS, ADZ
1.8 i 16V	10/1993→08/1996	B	ADL
1.9 D	01/1996→08/1996	D	1Y
1.9 D	02/1993→08/1996	D	1Y
1.9 SDI	08/1996→06/1999	D	AEY
1.9 TD	02/1993→08/1996	D	AAZ
1.9 TDI	03/1997→06/1999	D	AFN
1.9 TDI	08/1996→06/1999	D	1Z, AHU
2.0 i	02/1993→06/1999	B	2E, AGG
2.0 i 16V	08/1996→06/1999	B	ABF

**IBIZA II**

1.6 i	03/1993→08/1999	B	ABU, AEE, ALM
1.6 i	04/1996→08/1999	B	AFT



MAGNETI MARELLI			
Short	Code		
<b>Model</b>			
Version		Fuel	Motor code
81522	350981522000		
<b>SEAT</b>			
<b>IBIZA II</b>			
1.6 i	09/1994→06/1999	B	1F
1.8 i	03/1993→08/1999	B	ABS, ADZ
1.8 i 16V	11/1993→08/1996	B	ADL
1.9 D	04/1993→08/1996	D	1Y
1.9 D	10/1994→08/1996	D	1Y
1.9 SDI	08/1996→08/1999	D	AEY
1.9 TD	03/1993→08/1996	D	AAZ
2.0 i	03/1993→08/1999	B	2E, AGG
2.0 i 16V	08/1996→08/1999	B	ABF
<b>INCA</b>			
1.6 i	11/1995→05/1998	B	1F
1.7 D	09/1996→03/2011	D	AHB
1.9 D	11/1995→03/2011	D	1Y
1.9 SDI	11/1995→03/2011	D	AEY, AYQ
<b>TOLEDO I</b>			
1.6 i	01/1993→03/1999	B	1F
1.6 i	05/1991→12/1993	B	1F
1.6 i	05/1991→03/1999	B	1F, ABN, EZ
1.6 i	11/1996→03/1999	B	AFT
1.8 16V	05/1991→03/1999	B	PL
1.8 16V	05/1991→03/1999	B	KR
1.8 GT	05/1991→11/1992	B	KR
1.8 i	05/1991→12/1996	B	RP
1.8 i	11/1993→12/1996	B	ABS, ADZ
1.9 D	05/1991→03/1999	D	1Y
1.9 D	12/1995→03/1999	D	1Y
1.9 SDI	12/1995→03/1999	D	1Y
1.9 TD	05/1991→03/1999	D	AAZ
1.9 TDI	08/1995→03/1999	D	1Z, AHU
1.9 TDI	11/1996→03/1999	D	AFN
2.0 i	05/1991→03/1999	B	2E, AGG
2.0 i 16V	11/1993→03/1999	B	ABF
<b>VOLKSWAGEN</b>			
<b>CADDY I</b>			
16	01/1983→07/1992	B	EW
1.6 D	08/1982→07/1992	D	JK, ME
18	08/1985→07/1992	B	JH
<b>CADDY II</b>			
16	11/1995→05/1997	B	1F
1.7 SDI	07/1996→09/2000	D	AHB
1.9 D	11/1995→04/2011	D	1Y
1.9 SDI	11/1995→04/2011	D	AEY, AYQ

MAGNETI MARELLI			
Short	Code		
<b>Model</b>			
Version		Fuel	Motor code
<b>CADDY II</b>			
1.9 TDI	09/1996→04/2011	D	1Z, AHU, ALE, ALH
75 1.6	11/1995→05/1997	B	1F
<b>CORRADO</b>			
1.8 16V	04/1989→07/1992	B	KR
1.8 G60	09/1988→09/1993	B	PG
2.0 i	04/1993→12/1995	B	2E, ADY
2.0 i 16V	08/1991→12/1995	B	0,375
<b>GOLF I, Cabrio</b>			
16	01/1983→04/1992	B	EW, HN
18	08/1983→04/1993	B	JH
18	08/1983→09/1992	B	EX
18	08/1989→03/1993	B	2H
<b>GOLF II</b>			
16	08/1983→07/1992	B	ABN, EZ, HM
16	10/1986→12/1992	B	PN
20	08/1985→07/1992	B	
<b>GOLF III, Cabrio, Variant</b>			
16	07/1994→04/1999	B	AEK, AFT, AKS
18	11/1991→04/1999	B	AAM, ANN
18	11/1991→04/1999	B	ABS, ACC, ADZ, ANP
1.8 Syncro	01/1993→04/1999	B	ABS, ADZ
1.9 D	11/1991→04/1999	D	1Y
1.9 SDI	07/1995→08/1997	D	AEY
1.9 TD	07/1993→04/1999	D	AAZ
1.9 TD,GTD	11/1991→08/1997	D	AAZ
1.9 TDI	04/1996→04/1999	D	AFN
1.9 TDI	09/1993→04/1999	D	1Z, AHU, ALE
1.9 TDI Syncro	07/1995→04/1999	D	1Z, AHU
20	11/1991→04/1999	B	2E, ADY, AGG, AKR
2.0 GTI 16V	08/1992→08/1997	B	ABF
2.0 Syncro	08/1995→04/1999	B	AGG
<b>GOLF IV, Cabrio, Variant</b>			
16	06/1998→02/2011	B	AFT, AKS
18	06/1998→02/2011	B	AAM, ANN
18	06/1998→02/2011	B	ADZ, ANP
1.9 TDI	06/1998→02/2011	D	AHU, ALE
1.9 TDI	06/1998→02/2011	D	AFN, AVG
20	06/1998→02/2011	B	AGG, AKR, ATU, AWF, AWG
<b>JETTA II</b>			
16	01/1984→07/1992	B	ABN, EZ, HM
<b>PASSAT III, Variant</b>			
16	07/1994→08/1996	B	AEK, AFT
1.6 TD	08/1988→09/1993	D	RA, SB
18	02/1988→05/1997	B	ABS, ADZ, RP



MAGNETI MARELLI			
Short	Code		
<b>Model</b>			
Version		Fuel	Motor code
<b>81522</b>	<b>350981522000</b>		
<b>VOLKSWAGEN</b>			
<b>PASSAT III, Variant</b>			
18	04/1988→07/1992	B PB	
18	04/1988→07/1993	B PF	
18	08/1990→05/1997	B AAM	
18	08/1991→09/1993	B KR	
1.8 G60 Syncro	08/1988→05/1997	B PG	
1.8 G60 Syncro	09/1989→07/1993	B PF	
1.8 GL	08/1991→09/1993	B KR	
1.9 D	05/1989→10/1993	D 1Y	
1.9 TD	03/1991→05/1997	D AAZ	
1.9 TDI	03/1996→05/1997	D AFN	
1.9 TDI	10/1993→05/1997	D 1Z, AHU	
20	02/1990→05/1997	B 2E, ADY, AGG	
20	03/1995→08/1996	B AEP	
2.0 16V	01/1994→05/1997	B ABF	
2.0 16V	08/1988→09/1993	B 0,375	
2.0 Syncro	09/1989→07/1992	B	
2.0 Syncro	10/1990→05/1997	B 2E, ADY, AGG	
<b>POLO III, Classic, Variant, Van</b>			
16	05/1997→01/2011	B AEH, AFT, AKL, APF, AUR	
1.7 SDI	08/1997→01/2011	D AKW	
18	05/1997→01/2011	B ADZ	
1.9 SDI	06/1997→01/2011	D AEY	
1.9 TDI	05/1997→01/2011	D AGR, AHU, ALE, ALH	
100 1.6	12/1995→01/2011	B AEH, AFT, AKL, APF, AUR	
110 1.9 TDI	06/1998→01/2011	D AFN, ASV	
57 1.7 SDI	07/1997→01/2011	D AKW	
64 1,9 D	01/1996→10/1996	D 1Y	
64 1.9 SDI	12/1995→08/1999	D 1Y, AEY	
75 1.6	11/1995→09/1997	B 1F	
90 1.8	01/1997→01/2011	B ADD	
90 1.9 TDI	09/1996→01/2011	D AGR, AHU, ALE, ALH	
<b>SAVEIRO I</b>			
16	08/1990→07/1996	B 1F, EW	
<b>SAVEIRO II</b>			
16	08/1996→02/2011	B 1F, EW	
<b>SCIROCCO II</b>			
18	08/1983→07/1992	B EX	
18	11/1985→07/1992	B JH	
1.8 16V	03/1986→07/1992	B PL	
<b>SHARAN I</b>			
1.9 TDI	09/1995→	D 1Z, AHU, ANU	
1.9 TDI	09/1996→04/2000	D AFN, AVG	

MAGNETI MARELLI			
Short	Code		
<b>Model</b>			
Version		Fuel	Motor code
<b>SHARAN I</b>			
20	09/1995→	B ADY, ATM	
<b>TRANSPORTER III</b>			
1.6 TD	08/1984→07/1992	D JX	
1.6 TD Syncro	03/1986→07/1992	D JX	
1.7 D	10/1986→07/1992	D KY	
<b>TRANSPORTER IV</b>			
18	12/1990→07/1992	B PD	
1.9 D	07/1990→03/2011	D 1X	
1.9 D	09/1990→03/2011	D 1X	
1.9 TD	10/1992→03/2011	D ABL	
20	07/1990→03/2011	B AAC	
<b>VENTO</b>			
16	10/1994→09/1998	B AEK, AFT	
18	11/1991→09/1998	B AAM	
18	11/1991→09/1998	B ABS, ADZ	
1.9 D	11/1991→09/1998	D 1Y	
1.9 SDI	04/1997→09/1998	D AEY	
1.9 TD	11/1991→09/1998	D AAZ	
1.9 TDI	04/1996→09/1998	D AFN	
1.9 TDI	09/1993→09/1998	D 1Z, AHU, ALE	
20	11/1991→09/1998	B 2E, ADY, AGG, AKR	
2.0 GL	05/1996→12/1997	B AEP	
2.0 GL	11/1991→07/1998	B AAC	

MAGNETI MARELLI			
Short	Code		
<b>81524</b>	<b>350981524000</b>		
<b>PULEGGIA</b>		Diametro Puleggia	Ø75
		Numero Denti/Gole Puleggia	30
		Altezza Puleggia	21
		Posizione Puleggia	53.4
<b>GIRANTE</b>		Diametro Girante	Ø60
		N° Alette Girante	8
		Distanza Girante	31.5
<b>SEAT</b>			
<b>CORDOBA I, Vario</b>			
1.4 i	06/1994→06/1999	B ABD, AEX, AKV, ANX, APQ	
1.6 i	02/1993→06/1999	B ABU, AEE, ALM	
<b>IBIZA II</b>			
10	03/1993→09/1996	B AAU	
1.3 i	03/1993→08/1999	B AAV	
1.4 i	09/1993→08/1999	B ABD, AEX, AKV, APQ	
1.6 i	03/1993→08/1999	B ABU, AEE, ALM	

MAGNETI MARELLI			
Short	Code		
			
<b>Model</b>			
Version		Fuel	Motor code
81524	350981524000		
<b>VOLKSWAGEN</b>			
<b>GOLF II</b>			
1.3 Cat.	06/1986→12/1992	B	2G, MH, NZ
<b>GOLF III, Cabrio, Variant</b>			
1.3 CL	08/1991→07/1992	B	2G
14	10/1991→04/1999	B	ABD, AEX, APQ
14	11/1991→04/1999	B	ABD, AEX
16	09/1992→12/1997	B	ABU, AEA, AEE
<b>POLO II, Classic, Coupé, Van</b>			
10	01/1985→09/1994	B	AAK, AAU, HZ
1.0 Cat.	08/1989→09/1994	B	AAK, AAU, ACM
13	03/1991→09/1994	B	3F
13	08/1992→07/1994	B	AAV
1.3 Cat.	07/1987→09/1994	B	2G, AAV, MH, NZ
1.3 Cat.	10/1989→09/1994	B	3F
1.3 G40	08/1990→09/1994	B	PY
<b>POLO III, Classic, Variant, Van</b>			
10	10/1994→12/1999	B	AAU
<b>VENTO</b>			
14	11/1991→09/1998	B	ABD, AEX
14	11/1991→09/1998	B	ABD, AEX
16	09/1992→09/1998	B	ABU, AEA, AEE

MAGNETI MARELLI			
Short	Code		
81525	350981525000		
			
<b>PULEGGIA</b>			
Diametro Puleggia			Ø53.3
Numero Denti/Gole Puleggia			18
Altezza Puleggia			22
Posizione Puleggia			53.5
<b>GIRANTE</b>			
Diametro Girante			Ø60
N° Alette Girante			8
Distanza Girante			31.5
<b>SEAT</b>			
<b>TERRA, Van</b>			
1.3 D	03/1990→12/1994	D	MN
1.4 D	10/1990→12/1995	D	1W
<b>VOLKSWAGEN</b>			
<b>POLO II, Classic, Coupé, Van</b>			
1.4 D	08/1990→09/1994	D	1W

MAGNETI MARELLI			
Short	Code		
			
<b>Model</b>			
Version		Fuel	Motor code
81526	350981526000		
			
<b>FLANGIA</b>			
Numero Fori Flangia			3
Dimensione Fori Flangia			M8x1.25
Posizione Flangia			74
Diametro Mozzo			Ø30
<b>GIRANTE</b>			
Diametro Girante			Ø64
N° Alette Girante			7
Distanza Girante			29.5
<b>AUDI</b>			
<b>A4 I, Avant</b>			
16	01/1995→07/2000	B	ADP, AHL, ANA, ARM
18	01/1995→01/2011	B	ADR, APT, ARG, AVV
18	01/1995→11/2000	B	
18	04/1995→01/2011	B	AFY
1.8 quattro	01/1995→01/2011	B	ADR, APT, ARG
1.8 quattro	07/1995→01/2011	B	AFY
1.8 T	01/1995→01/2011	B	AEB, ANB, APU, ARK, AWT
1.8 T	12/1997→01/2011	B	AJL
1.8 T quattro	01/1995→01/2011	B	AEB, ANB, APU, ARK, AWT
1.8 T quattro	12/1997→01/2011	B	AJL
<b>A6 I, Avant</b>			
18	12/1995→12/1997	B	ADR
1.8 quattro	12/1995→12/1997	B	ADR
<b>A6 II, Avant</b>			
18	05/1997→05/2011	B	AFY
1.8 T	01/1997→05/2011	B	AEB, ANB, APU, ARK, AWL, AWT
1.8 T	12/1997→05/2011	B	AJL
1.8 T quattro	02/1997→05/2011	B	AEB, ANB, APU, ARK, AWT
1.8 T quattro	12/1997→05/2011	B	AJL
<b>Cabrio</b>			
18	01/1997→08/2000	B	ADR
<b>VOLKSWAGEN</b>			
<b>PASSAT IV, Variant</b>			
16	10/1996→11/2000	B	ADP, AHL, ANA, ARM
18	01/1997→11/2000	B	AFY
18	10/1996→11/2000	B	ADR, APT, ARG
1.8 Syncro/4motion	10/1996→11/2000	B	ADR, APT, ARG
1.8 T	10/1996→11/2000	B	AEB, ANB, APU
1.8 T Syncro	11/1996→08/2000	B	AEB
<b>PASSAT V, Variant</b>			
18	03/2011→05/2011	B	APT

Short **MAGNETI MARELLI** Code



**Model**

Version		Fuel	Motor code
---------	--	------	------------

81527 350981527000



**PULEGGIA**

Diametro Puleggia Ø67.24  
 Numero Denti/Gole Puleggia 27  
 Altezza Puleggia 20.7  
 Posizione Puleggia 51.7

**GIRANTE**

Diametro Girante Ø63.6  
 N° Alette Girante 8  
 Distanza Girante 40.5

**SEAT**

**AROSA**

14 05/1997→04/2011 B AEX, AKK, AKV, ANW, APQ, AUD

**CORDOBA I, Vario**

1.4 i 06/1994→06/1999 B ABD, AEX, AKV, ANX, APQ

**CORDOBA II, Vario**

16 06/1999→02/2011 B ALM

**CORDOBA III, Vario**

16 03/2011→ B BAH

**IBIZA II**

1.4 i 09/1993→08/1999 B ABD, AEX, AKV, APQ

1.4 i 16V 09/1996→08/1999 B AFH

**IBIZA III**

16 08/1999→02/2011 B ALM

**IBIZA IV**

16 03/2011→ B BAH

**INCA**

1.4 i 11/1995→03/2011 B AEX, AKV, APQ, AUD

1.6 i 11/1995→05/1998 B AEE

**SKODA**

**FELICIA I, Station Wagon**

16 06/1997→ B AEE

1.6 GLX 08/1995→03/1998 B AEE

1.6 LX 08/1995→03/1998 B AEE

**FELICIA II, Station Wagon**

16 01/1998→01/2011 B AEE

**OCTAVIA I, Station Wagon**

16 09/1996→09/2000 B AEE

**VOLKSWAGEN**

**CADDY II**

14 11/1995→04/2011 B AEX, AKV, APQ, AUD

16 06/1996→12/2000 B AEE

60 1.4 11/1995→04/2011 B AEX, APQ, AUD

75 1.6 11/1995→09/2000 B AEE

Short **MAGNETI MARELLI** Code



**Model**

Version		Fuel	Motor code
---------	--	------	------------

**FOX**

14 05/2011→ B BKR

16 03/2011→ B BAH

16 05/2011→ B BAH, BLH, BPA, CCRA

1.6 Alcohol 03/2011→ B

1.6 Total Flex 03/2011→ FF BJA, BPA, CCRA

**GOLF III, Cabrio, Variant**

14 10/1991→04/1999 B ABD, AEX, APQ

14 11/1991→04/1999 B ABD, AEX

16 09/1992→12/1997 B ABU, AEA, AEE

**POLO III, Classic, Variant, Van**

14 05/1997→01/2011 B AEX, AKK, AKV, ANW, APQ, AUD

16 09/1994→01/2011 B AEA, AEE, ALM

45 1.0 10/1994→09/1996 B AEV

55 1.3 10/1994→07/1995 B ADX

55 1.4 08/1995→10/1999 B AEX

60 1.4 07/1995→01/2011 B AEX, AKK, AKV, ANW, APQ, AUD

75 1.6 10/1994→01/2011 B AEA, AEE, AHS, ALM

**POLO IV**

16 02/2011→ B BAH

1.6 Sportline 02/2011→05/2011 B BAH

1.6 Total Flex 04/2011→ FF BPA

**VENTO**

14 11/1991→09/1998 B ABD, AEX

14 11/1991→09/1998 B ABD, AEX

16 09/1992→09/1998 B ABU, AEA, AEE

81528 350981528000



**FLANGIA**

Numero Fori Flangia 3  
 Dimensione Fori Flangia M8x1.25  
 Posizione Flangia 74.4  
 Diametro Mozzo Ø30

**GIRANTE**

Diametro Girante Ø62  
 N° Alette Girante 6  
 Distanza Girante 25.8

**AUDI**

**A4 I, Avant**

1.9 DUO 03/1998→01/2011 D AHU

1.9 TDI 01/1995→01/2011 D 1Z, AHH, AHU

1.9 TDI 10/1995→01/2011 D AFN, AVG

1.9 TDI 12/1995→01/2011 D AFF

1.9 TDI quattro 09/1996→01/2011 D AFN, AVG



MAGNETI MARELLI			
Short	Code		
<b>Model</b>			
Version		Fuel	Motor code
81528	350981528000		
<b>AUDI</b>			
<b>A6 I, Avant</b>			
1.9 TDI	06/1994→12/1997	D	1Z, AHU
<b>A6 II, Avant</b>			
1.9 TDI	04/1997→01/2011	D	AFN, AVG
<b>SEAT</b>			
<b>AROSA</b>			
1.7 SDI	08/1997→04/2011	D	AKU
<b>IBIZA II</b>			
1.9 TDI	02/1997→08/1999	D	AFN
1.9 TDI	08/1996→08/1999	D	1Z, AHU
<b>SKODA</b>			
<b>FELICIA I, Station Wagon</b>			
1.9 D	10/1995→03/1998	D	AEF
<b>FELICIA II, Station Wagon</b>			
1.9 D	01/1998→01/2011	D	AEF
<b>VOLKSWAGEN</b>			
<b>CADDY II</b>			
1.9 D	06/1996→12/2000	D	AEF
<b>GOLF III, Cabrio, Variant</b>			
1.9 D	11/1991→04/1999	D	1Y
1.9 SDI	07/1995→04/1999	D	AEY
1.9 TD	07/1993→04/1999	D	AAZ
1.9 TD,GTD	11/1991→08/1997	D	AAZ
1.9 TDI	09/1993→04/1999	D	1Z, AHU, ALE
1.9 TDI Syncro	07/1995→04/1999	D	1Z, AHU, ALE
<b>LUPO</b>			
1.7 SDI	09/1998→05/2011	D	AKU
<b>PASSAT IV, Variant</b>			
1.9 TDI	10/1996→11/2000	D	AFN, AVG
1.9 TDI	10/1996→11/2000	D	AHH, AHU
1.9 TDI Syncro/4motion	10/1996→11/2000	D	AFN, AVG
<b>POLO III, Classic, Variant, Van</b>			
1.7 SDI	04/1997→10/1999	D	AHG
1.7 SDI	08/1997→01/2011	D	AKU
1.9 D	10/1994→01/2011	D	AEF
1.9 SDI	07/1996→01/2011	D	AGD, ASX
1.9 TDI	05/1997→01/2011	D	AGR, AHU, ALE, ALH
1.9 TDI	06/1998→01/2011	D	AFN, ASV
60 1.7 SDI	08/1997→10/1999	D	AKU
64 1.9 D	10/1994→10/1999	D	AEF
64 1.9 SDI	07/1996→10/1999	D	AGD
90 1.9 TDI	09/1996→01/2011	D	AGR, AHU, ALE, ALH

MAGNETI MARELLI			
Short	Code		
<b>Model</b>			
Version		Fuel	Motor code
81529	350981529000		
<b>AUDI</b>			
<b>A4 I, Avant</b>			
16	01/1995→07/2000	B	ADP, AHL, ANA, ARM
18	01/1995→01/2011	B	ADR, APT, ARG, AVV
18	01/1995→11/2000	B	
18	04/1995→01/2011	B	AFY
1.8 quattro	01/1995→01/2011	B	ADR, APT, ARG
1.8 quattro	07/1995→01/2011	B	AFY
1.8 T	01/1995→01/2011	B	AEB, ANB, APU, ARK, AWT
1.8 T	12/1997→01/2011	B	AJL
1.8 T quattro	01/1995→01/2011	B	AEB, ANB, APU, ARK, AWT
1.8 T quattro	12/1997→01/2011	B	AJL
<b>A6 I, Avant</b>			
18	12/1995→12/1997	B	ADR
1.8 quattro	12/1995→12/1997	B	ADR
26	06/1994→02/1997	B	ACZ
<b>A6 II, Avant</b>			
18	05/1997→05/2011	B	AFY
1.8 T	01/1997→05/2011	B	AEB, ANB, APU, ARK, AWL, AWT
1.8 T	12/1997→05/2011	B	AJL
1.8 T quattro	02/1997→05/2011	B	AEB, ANB, APU, ARK, AWT
1.8 T quattro	12/1997→05/2011	B	AJL
<b>Cabrio</b>			
18	01/1997→08/2000	B	ADR
<b>VOLKSWAGEN</b>			
<b>PASSAT IV, Variant</b>			
16	10/1996→11/2000	B	ADP, AHL, ANA, ARM
18	01/1997→11/2000	B	AFY
18	10/1996→11/2000	B	ADR, APT, ARG
1.8 Syncro/4motion	10/1996→11/2000	B	ADR, APT, ARG
1.8 T	10/1996→11/2000	B	AEB, ANB, APU
1.8 T Syncro	11/1996→08/2000	B	AEB
<b>PASSAT V, Variant</b>			
18	03/2011→05/2011	B	APT

Short **MAGNETI MARELLI** Code



Model

Version		Fuel	Motor code
---------	--	------	------------

81532 350981532000



**FLANGIA**  
 Numero Fori Flangia 4  
 Dimensione Fori Flangia M8x1.25  
 Posizione Flangia 95.5  
 Diametro Mozzo Ø23.5

**GIRANTE**  
 Diametro Girante Ø71  
 N° Alette Girante 7  
 Distanza Girante 12.5

**FORD**

**SIERRA II, Station Wagon**

16	05/1904→02/1993	M	LSE
16	05/1904→02/1993	M	LSF
1.6 i	05/1904→02/1993	M	L6B
1.6 i	05/1904→02/1993	M	L6B
20	06/1905→02/1993	M	N8C, NES
20	06/1905→12/1992	M	N8A
2.0 4x4	06/1905→02/1993	M	N9C
2.0 i	06/1905→02/1993	M	NE5, NEJ
2.0 i	06/1905→02/1993	M	N8A
2.0 i Cat.	06/1905→02/1993	M	N4B

**TRANSIT IV**

16	1593→09/1992	M	LAT
20	1994→09/1992	M	NAT, NAV
20	1993→09/1992	M	N6T

81538 350981538000



**PULEGGIA**  
 Diametro Puleggia Ø59.2  
 Numero Denti/Gole Puleggia 20  
 Altezza Puleggia 28  
 Posizione Puleggia 51.5

**GIRANTE**  
 Diametro Girante Ø71  
 N° Alette Girante 8  
 Distanza Girante 12

**FORD**

**ESCORT V, Station Wagon, Cabrio, Van**

14	07/1990→12/1992	B	F6F, F6G
14	07/1990→12/1994	B	F6F, F6G
16	07/1990→12/1992	B	LJF
16	07/1990→08/1992	B	LUJ, LUK

**ESCORT VI, Station Wagon, Cabrio, Van**

14	08/1993→01/1995	B	F4B, FUH
----	-----------------	---	----------

Short **MAGNETI MARELLI** Code



Model

Version		Fuel	Motor code
---------	--	------	------------

**ESCORT VI, Station Wagon, Cabrio, Van**

14	09/1992→01/1995	B	F6F, F6G
14	12/1992→04/1994	B	F6F, F6G
1.4 i	07/1993→01/1995	B	F4B

**ESCORT VII, Station Wagon, Cabrio, Van**

14	01/1995→02/1999	B	F4B, FUH
14	01/1995→	B	F4B

**FIESTA III, Van**

14	03/1989→12/1995	B	F6E
14	03/1989→12/1995	B	FUG, FUJ
1.4 Cat.	03/1989→12/1995	B	F4A
16	01/1989→01/1994	B	LUH
1.6 Turbo	03/1990→10/1992	B	LHA
1.6 XR2i	03/1989→01/1994	B	LJC
1.6 XR2i	03/1989→03/1993	B	LJD

**ORION III**

14	07/1990→12/1993	B	F6F, F6G
14	07/1990→12/1993	B	FUH
16	07/1990→12/1992	B	LUJ, LUK
1.6 i	07/1990→09/1992	B	LJF

81543 350981543000



**PULEGGIA**  
 Diametro Puleggia Ø62.2  
 Numero Denti/Gole Puleggia 19  
 Posizione Puleggia 59.5

**GIRANTE**  
 Diametro Girante Ø55  
 N° Alette Girante 9  
 Distanza Girante 35

**OPEL**

**CORSA A, Van**

1.3 GL	09/1982→03/1993	B	13S
--------	-----------------	---	-----

**KADETT E, Station Wagon, Van**

1.3 S	09/1984→02/1993	B	13S
-------	-----------------	---	-----

Short	Code
-------	------



### Model

Version	Fuel	Motor code
---------	------	------------

81544 350981544000



**FLANGIA**  
 Numero Fori Flangia 3  
 Dimensione Fori Flangia M6x1  
 Posizione Flangia 86.5  
 Diametro Mozzo Ø22

**GIRANTE**  
 Diametro Girante Ø60.9  
 N° Alette Girante 8  
 Distanza Girante -0.5

### OPEL

#### CORSA A, Van

10 09/1982→03/1993 B 10S

81546 350981546000



**PULEGGIA**  
 Diametro Puleggia Ø114  
 Numero Denti/Gole Puleggia 2  
 Posizione Puleggia 52.5

**GIRANTE**  
 Diametro Girante Ø81.5  
 N° Alette Girante 12  
 Distanza Girante 14.5

### OPEL

#### CAMPO

2.5 D 4x4 08/1991→06/1994 D 4JA1

3.1 TD 4x4 12/1992→ D 4JG2T

#### MONTEREY A

3.1 TD 09/1991→07/1998 D 4JG2TC

81548 350981548000



**PULEGGIA**  
 Diametro Puleggia Ø68  
 Numero Denti/Gole Puleggia 21  
 Altezza Puleggia 21  
 Posizione Puleggia 64.5

**GIRANTE**  
 Diametro Girante Ø65  
 N° Alette Girante 8  
 Distanza Girante 29

### DAEWOO

#### ESPERO

18 02/1995→06/1999 B C18LE

18 02/1995→09/1999 B C18LE

Short	Code
-------	------



### Model

Version	Fuel	Motor code
---------	------	------------

#### ESPERO

20 02/1995→06/1999 B C20LE

#### OPEL

##### KADETT E, Station Wagon, Van

1.8 i 08/1984→09/1992 B C18NT, C18NZ

81549 350981549000



**PULEGGIA**  
 Diametro Puleggia Ø56.3  
 Numero Denti/Gole Puleggia 19  
 Altezza Puleggia 20  
 Posizione Puleggia 59

**GIRANTE**  
 Diametro Girante Ø55  
 N° Alette Girante 9  
 Distanza Girante 35

### DAEWOO

#### CIELO

15 06/1994→07/1998 B V15L

#### ESPERO

15 10/1997→09/1999 B

#### NEXIA

15 02/1995→08/1997 B G15MF

15 02/1995→08/1997 B G15MF

15 08/1996→08/1997 B G15MF

### OPEL

#### ASTRA F Classic

1.4 i 01/1998→05/2011 B X14NZ

1.6 i 01/1998→05/2011 B X16SZR

#### ASTRA F, Station Wagon, Cabrio

14 09/1991→09/1993 B 14NV

14 09/1992→09/1998 B 14SE

1.4 i 09/1991→01/1999 B C14NZ

1.4 Si 03/1992→01/2011 B C14SE

1.6 i 02/1993→08/1996 B X16SZ

1.6 i 09/1991→01/2011 B C16NZ, X16SZR

1.6 Si 03/1992→12/1994 B C16SE

#### ASTRA G, Station Wagon, Cabrio

16 02/1998→09/2000 B X16SZR

16 09/2000→05/2011 B Z16SE

### COMBO I



12 07/1994→01/2011 B C12NZ, X12SZ



14 07/1994→01/2011 B C14SE

14 07/1994→01/2011 B C14NZ, X14SZ

MAGNETI MARELLI			
Short	Code		
<b>Model</b>			
Version		Fuel	Motor code
81549			350981549000
<b>OPEL</b>			
<b>CORSA A, Van</b>			
1.2 i	09/1989→03/1993	B	C12NZ
1.2 N	01/1990→03/1993	B	12NV
1.2 S	09/1982→03/1993	B	12ST
1.4 i	10/1989→03/1993	B	C14NZ
1.4 S	09/1989→03/1993	B	14NV
1.4 Si	09/1991→03/1993	B	C14SE
1.6 GSI	05/1988→03/1992	B	E16SE
1.6 GSI	08/1988→09/1992	B	C16NZ
1.6 GSI	09/1989→03/1993	B	C16SEI
1.6 GSI Cat.	02/1992→03/1993	B	C16SE
<b>CORSA B, Station Wagon, Van</b>			
1.2 i	03/1993→09/2000	B	12NZ, C12NZ, X12SZ
14	04/1993→08/1994	B	
1.4 i	03/1993→09/2000	B	C14NZ, X14SZ
1.4 Si	03/1993→09/2000	B	C14SE
<b>KADETT E, Station Wagon, Van</b>			
1.4 i	01/1990→07/1994	B	C14NZ
1.4 S	07/1989→02/1993	B	14NV
1.6 i	07/1989→02/1993	B	16SV
1.6 i	09/1986→07/1994	B	C16NZ, E16NZ
1.6 i Cat.	09/1986→02/1993	B	C16LZ, C16NZ
<b>VECTRA A</b>			
1.4 S	04/1988→06/1992	B	14NV
16	09/1988→05/1993	B	16SV
1.6 i	09/1988→11/1995	B	16LZ2, E16NZ
1.6 i	09/1993→11/1995	B	X16SZ
1.6 i Cat.	09/1988→11/1995	B	C16NZ, C16NZ2
1.6 S	09/1988→05/1993	B	16SV
<b>VECTRA B, Station Wagon</b>			
1.6 i	10/1995→03/2011	B	X16SZR
<b>VAUXHALL</b>			
<b>CORSA</b>			
1.2 16V	09/2000→04/2011	B	Z12XE

MAGNETI MARELLI			
Short	Code		
<b>Model</b>			
Version		Fuel	Motor code
81550			350981550000
		<b>PULEGGIA</b>	
		Diametro Puleggia	Ø62.3
		Numero Denti/Gole Puleggia	25
		Altezza Puleggia	26
		Posizione Puleggia	66.4
		<b>GIRANTE</b>	
		Diametro Girante	Ø65
		N° Alette Girante	8
		Distanza Girante	29
<b>CHEVROLET</b>			
<b>CAPTIVA</b>			
24	06/2011→	B	Z24SED
24	06/2011→	B	Z24SED
2.4 AWD	06/2011→	B	Z24SED
2.4 FWD	06/2011→	B	Z24SED
2.4 LPG	07/2011→		
2.4 LPG 4WD	07/2011→		
<b>EVANDA</b>			
20	05/2011→	B	X20SED
<b>REZZO</b>			
20	05/2011→	B	T20SED
20	05/2011→	B	T20SED
<b>DAEWOO</b>			
<b>EVANDA</b>			
20	02/2011→	B	L88
<b>LACETTI III</b>			
18	04/2011→	B	T18SED
1.8 CDX	03/2011→04/2011	B	T18SED
<b>LEGANZA</b>			
2.0 16V	06/1997→02/2011	B	X20SED
2.0 16V	07/2000→	B	T20SED
2.2 16V	04/1999→02/2011	B	T22SED
<b>NUBIRA I, Station Wagon</b>			
2.0 16V	05/1997→	B	X20SED
<b>REZZO</b>			
20	09/2000→	B	
20	01/2011→	B	X20SED
<b>LADA</b>			
<b>110</b>			
2.0 i	08/1996→	B	C20XE
<b>OPEL</b>			
<b>ANTARA</b>			
24	06/2011→	B	Z24XED
2.4 FWD	08/2011→	B	Z24XE

MAGNETI MARELLI			
Short	Code		
			
<b>Model</b>			
Version		Fuel	Motor code
81550	350981550000		
<b>OPEL</b>			
<b>ASTRA F, Station Wagon, Cabrio</b>			
1.7 D	07/1992→01/1999	D	17DR
1.7 TD	08/1994→01/1999	D	X17DTL
18	11/1991→07/1993	B	18SE
1.8 i 16V	06/1993→01/1998	B	C18XE
1.8 i 16V	07/1994→01/2011	B	C18XEL, X18XE
2.0 GSI 16V	09/1991→01/1998	B	C20XE
2.0 i 16V	02/1995→09/1998	B	X20XEV
2.0 i 16V	03/1993→01/1998	B	C20XE
<b>ASTRA G, Station Wagon, Cabrio</b>			
1.7 TD	02/1998→05/2011	D	X17DTL
1.8 16V	09/1998→09/2000	B	X18XE1
2.0 16V	02/1998→05/2011	B	X20XEV
2.0 16V OPC	11/1999→02/2011	B	X20XER
2.0 16V Turbo	01/2011→05/2011	B	Z20LET
2.0 16V Turbo	09/2000→01/2011	B	Z20LET
2.0 16V Turbo	02/2011→05/2011	B	Z20LER
2.0 OPC	02/2011→05/2011	B	Z20LET
2.0 OPC	02/2011→05/2011	B	Z20LER, Z20LET
<b>ASTRA H, Station Wagon, Cabrio, HTC, TwinTop</b>			
2.0 Turbo	04/2011→	B	Z20LEL
2.0 Turbo	05/2011→	B	Z20LEH
2.0 Turbo	04/2011→	B	Z20LER
<b>CALIBRA</b>			
2.0 i 16V	07/1997→B		X20XEV
2.0 i 16V	02/1994→B		C20XE
2.0 i 16V 4x4	07/1997→B		X20XEV
2.0 i 16V 4x4	02/1994→B		C20XE
2.0 i Turbo 4x4	07/1997→B		C20LET
<b>FRONTERA A</b>			
2.2 i	10/1998→B		X22XE
<b>FRONTERA B</b>			
2.2 i	→B		X22SE, Y22SE
<b>OMEGA B, Station Wagon</b>			
2.0 16V	09/1999→B		X20XEV
2.2 16V	03/2011→B		Y22XE, Z22XE
<b>SINTRA</b>			
2.2 i 16V	04/1999→B		X22XE
<b>OMEGA</b>			
2.0 Turbo	→B		Z20LET
<b>VECTRA A</b>			
1.7 D	11/1995→D		17DR
1.7 D	09/1992→D		17D

MAGNETI MARELLI			
Short	Code		
			
<b>Model</b>			
Version		Fuel	Motor code
<b>VECTRA A</b>			
2.0 i 16V	11/1995→B		X20XEV
2.0 i 16V 4x4	11/1995→B		X20XEV
2.0 i 16V Cat.	11/1995→B		C20XE
2.0 i Turbo 4x4	11/1995→B		C20LET
2000/GT 16V	06/1994→B		20XEJ
2000/GT 16V 4x4 Cat.	11/1995→B		C20XE
2000/GT 16V Cat.	11/1995→B		C20XE
<b>VECTRA B, Station Wagon</b>			
1.8 i 16V	09/2000→B		X18XE1
2.0 i 16V	09/2000→B		C20SEL, X20XEV
<b>ZAFIRA A</b>			
2.0 OPC	05/2011→B		Z20LET
2.0 OPC	05/2011→B		Z20LER
<b>ZAFIRA B</b>			
20	→B		Z20LEH
20	→B		Z20LER

81551 350981551000



#### PULEGGIA

Diametro Puleggia	Ø62.3
Numero Denti/Gole Puleggia	25
Altezza Puleggia	21
Posizione Puleggia	64.4

#### GIRANTE

Diametro Girante	Ø65
N° Alette Girante	8
Distanza Girante	29

<b>OPEL</b>			
<b>ASTRA F, Station Wagon, Cabrio</b>			
16	09/1995→09/1998	B	16LZ2, 16NZR
1.8 i	09/1991→09/1998	B	C18NZ
2.0 i	09/1991→09/1998	B	C20NE
<b>CALIBRA</b>			
2.0 i	06/1990→07/1997	B	C20NE
2.0 i 4x4	06/1990→07/1997	B	C20NE
<b>FRONTERA A</b>			
2.0 i	03/1992→10/1998	B	C20NE, X20SE
<b>OMEGA A, Station Wagon</b>			
20	09/1986→03/1994	B	20SE
20	09/1990→03/1994	B	C20NEF
20	09/1990→03/1994	B	C20NEJ
2.0 i	09/1986→03/1994	B	C20NE
2.0 i	09/1990→03/1994	B	C20NEJ

MAGNETI MARELLI			
Short	Code		
<b>Model</b>			
Version		Fuel	Motor code
81551	350981551000		
<b>OPEL</b>			
<b>OMEGA B, Station Wagon</b>			
20	03/1994→12/2000	B	20SE, X20SE
<b>VECTRA A</b>			
1.8 i Cat.	03/1990→11/1995	B	C18NZ
2.0 i	09/1988→09/1992	B	20SEH
2.0 i 4x4	01/1989→09/1992	B	20SEH
2.0 i 4x4 Cat.	01/1989→11/1995	B	C20NE
2.0 i Cat.	09/1988→11/1995	B	C20NE
2.0 i GT	09/1988→11/1995	B	20SEH
<b>VECTRA B, Station Wagon</b>			
1.6 i	10/1995→03/2011	B	16LZ2
2.0 i	10/1995→02/2011	B	20NEJ
<b>VAUXHALL</b>			
<b>OMEGA</b>			
20	09/1995→09/1996	B	20SE

81554 350981554000



**PULEGGIA**

Diametro Puleggia Ø59.26  
 Numero Denti/Gole Puleggia 20  
 Altezza Puleggia 33.5  
 Posizione Puleggia 42.5

**GIRANTE**

Diametro Girante Ø60  
 N° Alette Girante 6  
 Distanza Girante 40

CITROËN			
<b>BX, Break</b>			
16	01/1987→01/1992	B	B6D
1.8 D	10/1985→09/1993	D	161 (XUD7)
1.9 GTi	01/1990→01/1992	B	
16	01/1987→12/1994	B	B1E (XU51C)
16	03/1986→12/1994	B	180Z
16	05/1989→12/1994	B	BDY (XU5M), BDZ (XU5M)
16	07/1985→12/1994	B	171D
16	09/1987→02/1993	B	B1A (XU51C/K)
16	09/1988→12/1994	B	BAY (XU5CP), BAZ (XU5CP)
16	10/1982→12/1992	B	XU52C
16 E	05/1989→02/1993	B	BDY (XU5M), BDZ (XU5M)
18 D	10/1985→09/1993	D	161A (XUD7)
19	06/1988→12/1994	B	DKZ (XU9JA)
19	06/1988→12/1994	B	DDZ (XU9M)
19	07/1986→12/1994	B	159A, D2A (XU92C)

MAGNETI MARELLI			
Short	Code		
<b>Model</b>			
Version		Fuel	Motor code
<b>BX, Break</b>			
19 Cat.	07/1986→12/1994	B	DFZ (XU9J1)
19 E	06/1988→02/1993	B	DDZ (XU9M)
19 E 4x4	04/1989→02/1993	B	D2F
19 GTi	06/1988→02/1993	B	DKZ (XU9JA)
19 GTi	07/1986→02/1993	B	D6A (XU9J2)
19 GTi 16V	03/1988→02/1993	B	DFW (XU9J4)
19 GTi 4x4	06/1988→02/1993	B	DKZ (XU9JA)
<b>C 15, Station Wagon</b>			
1.8 D	07/1986→12/2000	D	161A (XUD7)
<b>ZX, Break</b>			
1.6 i	03/1991→06/1997	B	BDY (XU5M), BFZ (XU5JP)
1.8 i	07/1992→10/1997	B	LFZ (XU7JP)
1.9 i	03/1991→06/1997	B	DKZ (XU9JA)
<b>PEUGEOT</b>			
<b>205 I, Cabrio, Van</b>			
16	08/1987→07/1992	B	
1.9 CTi	08/1990→07/1992	B	
1.9 CTi	10/1987→12/1994	B	DFZ (XU9J1)
<b>205 II, Van</b>			
16	10/1987→09/1998	B	B1A (XU51C), BAZ (XU5CP)
16	10/1987→09/1998	B	B1E (XU51C)
1.6 Aut.	10/1987→09/1998	B	
1.9 GTi	10/1987→09/1998	B	D6B (XU9JA (G-KAT))
1.9 GTi	10/1987→10/1994	B	DKZ (XU9JAZ)
1.9 GTi Cat.	10/1987→07/1994	B	DFZ (XU9J1)
<b>309 II</b>			
16	07/1989→12/1993	B	B2A (XU52C/K)
16	07/1989→12/1993	B	B2A (XU52C/K)
16	07/1989→12/1993	B	BDY (XU5M2Z), BDY (XU5M3Z), BDZ (XU5M)
1.6 GTi	09/1989→10/1993	B	
19	08/1989→12/1993	B	DFZ (XU9J1)
19	10/1990→12/1993	B	DDZ (XU9M)
1.9 GTi	07/1989→12/1993	B	DKZ (XU9JAZ)
<b>405 I, Break</b>			
16	01/1987→12/1992	B	B2A (XU52C/K)
16	07/1987→12/1992	B	BDY (XU5M2Z), BDY (XU5M3Z), BDZ (XU5M)
16	07/1987→08/1992	B	B1E (XU51C), BAZ (XU5CP)
16	07/1987→12/1992	B	B1E (XU51C)
16	10/1988→12/1992	B	BDZ (XU5M)
1.6 4x4	04/1988→07/1992	B	BDZ (XU5M)
1.6 SRi 4x4	04/1988→07/1992	B	BDZ (XU5M)
19	07/1987→12/1993	B	

Short **MAGNETI MARELLI** Code



**Model**

Version		Fuel	Motor code
<b>81554</b>			<b>350981554000</b>
<b>PEUGEOT</b>			
<b>405 I, Break</b>			
19	07/1987→12/1992	B	D2C (XU92C (U-KAT))
19	07/1988→12/1992	B	DKZ (XU9JAZ)
19	07/1988→12/1992	B	DDZ (XU9M)
19	10/1988→08/1992	B	DFZ (XU9J1)
1.9 4x4	06/1987→07/1992	B	DKZ (XU9JAZ)
1.9 4x4	07/1988→12/1992	B	DDZ (XU9M)
1.9 4x4	07/1990→07/1992	B	
1.9 Injection	07/1987→12/1992	B	DFZ (XU9J1)

**81556** **350981556000**



**PULEGGIA**  
 Diametro Puleggia Ø59.26  
 Numero Denti/Gole Puleggia 20  
 Altezza Puleggia 33.5  
 Posizione Puleggia 43

**GIRANTE**  
 Diametro Girante Ø53.3  
 N° Alette Girante 6  
 Distanza Girante 41.85

**CITROËN**

**AX**

1.4 4x4	06/1991→07/1992	D	K9A (TUD3)
1.4 4x4	09/1986→07/1992	B	K2A
1.4 GTi	06/1991→12/1992	B	KFZ (TU3FJ2)
10	02/1987→12/1998	B	CDZ (TU9M)
10	07/1986→12/1998	B	CDY (TU9M)
10	09/1986→06/1992	B	C1A
11	09/1986→12/1997	B	H1B, HDZ (TU1M)
11	12/1986→04/1994	B	H1A, H1B
11 4x4	06/1991→07/1992	B	H1A
14	01/1988→12/1992	B	K2A, K2B
14	04/1987→04/1997	B	KDX (TU3M/Z), KDY (TU3FM), KDY (TU3M), KDZ (TU3M/Z)
14 D	08/1991→12/1997	D	K9Y (TUD3Y)
14 D	09/1988→06/1992	D	K9A (TUD3)

**BERLINGO I, Furgonato**

1.1 i	07/1996→	B	HDZ (TU1M), HFX (TU1JP)
1.4 i	07/1996→	B	KFW (TU3JP), KFX (TU3JP)

**BX, Break**

11	10/1986→06/1992	B	
11	10/1988→06/1992	B	HDZ (TU1M)
14	01/1986→02/1993	B	150C

Short **MAGNETI MARELLI** Code



**Model**

Version		Fuel	Motor code
<b>BX, Break</b>			
14	01/1989→02/1993	B	KDY (TU3M), KDZ (TU3M/Z)
14 E	04/1983→02/1993	B	150C
14 E	09/1985→02/1993	B	150F
<b>C 15, Station Wagon</b>			
10	10/1984→12/1997	B	TU9, XV8
1.0 E	11/1992→07/1996	B	
11	10/1984→12/1996	B	109K, E1A
11	11/1988→07/1996	B	H1A
1.1 i	07/1988→12/1996	B	HDZ (TU1M)
14	07/1987→12/1996	B	K1H (TU3A)
1.4 E	05/1987→12/1996	B	150D (XY7)
1.4 E	07/1987→12/1996	B	K3A
1.4 i	05/1991→12/1996	B	KDY (TU3FM), KDY (TU3M)

**SAXO**

1.0 X	05/1996→11/1998	B	CDZ (TU9M)
1.0 X	05/1998→03/2011	B	CDZ (TU9M)
1.1 X,SX	05/1996→03/2011	B	HDZ (TU1M), HFX (TU1JP)
1.1 X,SX	05/1996→03/2011	B	HDZ (TU1M)
1.4 VTS	05/1996→03/2011	B	KFW (TU3JP), KFX (TU3JP)

**XSARA, Break, Coupé, PICASSO**

1.4 i	04/1997→05/2011	B	KFW (TU3JP), KFX (TU3JP)
-------	-----------------	---	--------------------------

**ZX, Break**

1,1	03/1991→08/1993	B	H1A
11	03/1991→06/1997	B	HDZ (TU1M)
14	03/1991→06/1997	B	KDZ (TU3M/Z)
14	07/1994→10/1997	D	
1.4 i	03/1991→10/1997	B	KDX (TU3M/Z), KDY (TU3M), KDZ (TU3M/Z), KFX (TU3JP)

**MEGA**

**CLUB I**

1.1 i	01/1992→06/1999	B	
-------	-----------------	---	--

**PEUGEOT**

**106 I**

10	09/1991→04/1996	B	CDZ (TU9M)
10	09/1991→04/1996	B	CDY (TU9M)
11	09/1991→04/1996	B	HDZ (TU1M)
13	10/1993→04/1996	B	TU2J2
14	08/1991→03/1996	B	TU3
14	09/1991→04/1996	B	KDX (TU3MC), KDY (TU3M)
14	09/1991→04/1996	B	KFZ (TU3J2/Z)
1.4 D	09/1992→04/1996	D	K9Y (TUD3Y)
16	06/1993→04/1996	B	NFZ (TU5JP)

**106 II**

1.0 i	01/1997→	B	CDZ (TU9M)
-------	----------	---	------------

MAGNETI MARELLI			
Short	Code		
<b>Model</b>			
Version		Fuel	Motor code
81556	350981556000		
<b>PEUGEOT</b>			
<b>106 II</b>			
1.0 i	05/1996→	B	CDY (TU9M)
11	09/2000→02/2011	G	
1.1 i	01/1997→	B	HDY (TU1M)
1.1 i	05/1996→	B	HDZ (TU1M), HFX (TU1JP)
1.4 i	05/1996→	B	KFW (TU3JP), KFX (TU3JP)
1.6 i	05/1996→	B	NFZ (TU5JP)
<b>205 I, Cabrio, Van</b>			
11	08/1987→12/1994	B	H1B (TU1)
1.1 CJ	10/1989→12/1994	B	HDZ (TU1M)
1.4 CJ	03/1989→12/1994	B	K1D (TU3A)
1.4 CJ	05/1991→12/1994	B	KDY (TU3M), KDZ (TU3M)
<b>205 II, Van</b>			
10	08/1992→05/1997	B	CDZ (TU9M)
10	10/1987→09/1998	B	TU9
11	07/1989→09/1998	B	HDZ (TU1M)
14	07/1988→09/1998	B	KDY (TU3M), KDZ (TU3M), KFX (TU3JP)
1.4 Cat.	08/1987→09/1993	B	KAY (TU3CP)
<b>206, Station Wagon, CC, Plus</b>			
11	02/2011→	B	HFX (TU1JP)
11	08/1998→07/2000	B	
1.1 i	09/1998→	B	HFX (TU1JP), HFZ (TU1JP)
14	02/2011→	B	KFW (TU3JP)
1.4 i	09/1998→	B	KFW (TU3JP), KFX (TU3JP)
<b>306, Break, Cabrio</b>			
11	05/1993→01/2011	B	HDZ (TU1M)
14	05/1993→02/2011	B	KDX (TU3MC), KFW (TU3JP), KFX (TU3JP)
1.4 SL	06/1994→01/2011	B	KDX (TU3MC), KFW (TU3JP), KFX (TU3JP)
<b>307, Break, CC</b>			
14	08/2000→03/2011	B	KFW (TU3JP), TU3JP
<b>309 II</b>			
11	08/1990→12/1993	B	HDZ (TU1M)
14	07/1989→12/1993	B	KDY (TU3M), KDZ (TU3M)
14	07/1990→12/1993	B	K1D (TU3A)
<b>405 I, Break</b>			
14	01/1987→07/1992	B	TU3
<b>PARTNER - Ranch, I</b>			
11	06/1996→	B	HDZ (TU1M), HFX (TU1JP)
14	06/1996→	B	KFW (TU3JP), KFX (TU3JP)
1.4 BiFuel	03/2011→	BF	KFW (TU3JP)

MAGNETI MARELLI			
Short	Code		
<b>Model</b>			
Version		Fuel	Motor code
<b>ROVER</b>			
<b>100 (Metro), Cabrio</b>			
114 D	10/1992→12/1994	D	TUD3
115 D	12/1994→12/1998	D	TUD5
<b>81559 350981559000</b>			
		<b>FLANGIA</b>	
		Numero Fori Flangia	4
		Dimensione Fori Flangia	M6x1
		Posizione Flangia	83.5
		Diametro Mozzo	Ø28.05
		<b>GIRANTE</b>	
		Diametro Girante	Ø60
		N° Alette Girante	6
		Distanza Girante	14
<b>FORD</b>			
<b>TRANSIT IV</b>			
2.5 D	09/1988→09/1992	D	4BA, 4CA
2.5 DI	09/1988→09/1992	D	4BA, 4CA
<b>TRANSIT TOURNEO I</b>			
2.4 D	08/1994→06/2000	D	4HA
2.5 DI	11/1994→12/2000	D	4FA, 4FB, 4FC, 4FD
2.5 DI	11/1994→12/2000	D	4HA, 4HB, 4HC
2.5 TD	04/1998→12/2000	D	4EB, 4EC
2.5 TD	11/1994→12/2000	D	4GA, 4GB, 4GC
<b>TRANSIT V</b>			
2.5 DI	05/1991→08/1994	D	4DA
2.5 DI	05/1991→08/1994	D	4BC, 4CC, 4FA
2.5 DI	10/1992→06/1994	D	4GA
2.5 TD	05/1991→08/1994	D	4EA
2.5 TD	10/1992→08/1994	D	4GA, 4GB, 4GC
<b>TRANSIT VI</b>			
2.5 DI	06/1994→03/2000	D	4HB, 4HC
2.5 DI	06/1994→03/2000	D	4FA, 4FB, 4FC, 4FD
2.5 DI	08/1997→03/2000	D	4ED
2.5 TD	06/1994→03/2000	D	4GA, 4GB, 4GC, 4GD, 4GE, 4GF
2.5 TD	07/1994→03/2000	D	4EB, 4EC
2.5 TD	08/1994→06/2000	D	4HA, 4HD
2.5 TDI	06/1994→03/2000	D	4EB, 4EC



Short	Code
-------	------



### Model

Version	Fuel	Motor code
---------	------	------------

81560 350981560000



**FLANGIA**  
 Numero Fori Flangia 3  
 Dimensione Fori Flangia M7x1  
 Posizione Flangia 70

**GIRANTE**  
 Diametro Girante Ø51.5  
 N° Alette Girante 6  
 Distanza Girante 33

### CITROËN

#### C 15, Station Wagon

11	10/1984→12/1996	B	109K, E1A
----	-----------------	---	-----------

### PEUGEOT

#### 205 II, Van

13	08/1990→07/1992	B	G1A
----	-----------------	---	-----

#### 309 II

11	09/1989→10/1993	B	H1B (TU1)
----	-----------------	---	-----------

81572 350981572000



**PULEGGIA**  
 Diametro Puleggia Ø121  
 Numero Denti/Gole Puleggia 1  
 Posizione Puleggia 106

**GIRANTE**  
 Diametro Girante Ø53  
 N° Alette Girante 6  
 Distanza Girante 11.5

### CITROËN

#### BX, Break

11	10/1986→06/1992	B	
11	10/1988→06/1992	B	HDZ (TU1M)
14	01/1986→02/1993	B	150C
14	01/1989→02/1993	B	KDY (TU3M), KDZ (TU3M/Z)
14 E	04/1983→02/1993	B	150C
14 E	09/1985→02/1993	B	150F

#### C 15, Station Wagon

10	10/1984→12/1997	B	TU9, XV8
1.0 E	11/1992→07/1996	B	
11	10/1984→12/1996	B	109K, E1A
14	07/1987→12/1996	B	K1H (TU3A)
1.4 E	05/1987→12/1996	B	150D (XY7)
1.4 E	07/1987→12/1996	B	K3A
1.4 i	05/1991→12/1996	B	KDY (TU3FM), KDY (TU3M)

Short	Code
-------	------



### Model

Version	Fuel	Motor code
---------	------	------------

### PEUGEOT

#### 205 I, Cabrio, Van

14	08/1987→06/1994	B	K2B (TU3S)
1.4 CJ Cat.	01/1989→09/1993	B	KAY (TU3CP)

81573 350981573000



**PULEGGIA**  
 Diametro Puleggia Ø144  
 Numero Denti/Gole Puleggia 1  
 Posizione Puleggia 29.5

**GIRANTE**  
 Diametro Girante Ø67  
 N° Alette Girante 8  
 Distanza Girante 18

### RENAULT

#### 19 I, CHAMADE, Van, Cabrio

1.1 TR	07/1988→04/1992	B	C1E700
12	01/1988→12/1992	B	C1G730
14	07/1988→04/1992	B	C2J772, C3J710

#### 19 II, CHAMADE, Van, Cabrio

12	04/1992→12/1995	B	C1G730
14	04/1992→12/1995	B	C3J710

#### 21, Station Wagon, Van

	09/1989→05/1993	B	C2J770
14	06/1988→10/1993	B	C2J770

### CLIO I, Van

11	01/1991→09/1998	B	C1E700
11	04/1992→08/1992	B	C1E700

### RAPID, Express

10	02/1986→05/1992	B	
11	07/1985→04/1995	B	C1E750, C1E752, C1E754, C1E756, C1E760, C1E762, C1E792
12	09/1991→03/1998	B	C3G710, C3G712
14	07/1985→03/1998	B	C1J768, C1J780, C3J700, C3J702, C3J760, C3J762
1.4 RN	09/1991→08/1993	B	E6J734

### Super 5, Van

11	01/1986→03/1995	B	C1E750, C1E752, C1E756, C1E760
11	10/1984→12/1996	B	C1E750, C1E752, C1E754
12	01/1987→12/1996	B	
14	10/1984→12/1996	B	C1J768, C1J780, C3J700, C3J702, C3J760

Short	Code
-------	------



Model

Version		Fuel	Motor code
---------	--	------	------------

81574 350981574000



<b>FLANGIA</b>	
Numero Fori Flangia	3
Dimensione Fori Flangia	M8x1.25
Posizione Flangia	57
Diametro Mozzo	Ø28
Diametro Centraggio	Ø50
<b>GIRANTE</b>	
Diametro Girante	Ø61.8
N° Alette Girante	8
Distanza Girante	24

**DACIA**

**SOLENZA**

1.9 D 03/2011→ D F8Q630

**MITSUBISHI**

**CARISMA**

1.9 TD 10/1996→09/2000 D F8QT

**OPEL**

**MOVANO A**

1.9 DTI 09/2000→01/2011 D F9Q770

**RENAULT**

**19 I, CHAMADE, Van, Cabrio**

17	07/1988→04/1992	B	F3N742, F3N743
17	07/1991→04/1992	B	F3N742, F3N743
17	07/1991→04/1992	B	
17	08/1988→12/1992	B	F3N746
17	09/1988→04/1992	B	F3N740, F3N741
1.8 16V	06/1989→04/1992	B	F7P704
1.8 16V	07/1991→04/1992	B	F7P704
19	09/1990→04/1992	D	F8Q610
19	09/1990→04/1992	D	F8Q740
1.9 D	01/1988→12/1992	D	F8Q706, F8Q742
1.9 D	09/1988→04/1992	D	F8Q706, F8Q742
1.9 TD	09/1990→04/1992	D	F8Q740

**19 II, CHAMADE, Van, Cabrio**

17	04/1992→12/1995	B	F3N742, F3N743
17	04/1992→12/1995	B	F3N740, F3N741
18	04/1992→06/1996	B	F3P704, F3P705, F3P706, F3P707, F3P708, F3P760
18	04/1992→06/1996	B	F3P706, F3P760
18	04/1992→05/1994	B	F3P700
18	05/1994→12/1995	B	F3P682
18	05/1994→06/1996	B	F3P682, F3P764, F3P765
1.8 16V	04/1992→06/1996	B	F7P704
1.9 D	03/1992→12/1995	D	F8Q706, F8Q742
1.9 D	04/1992→12/1995	D	F8Q742

Short	Code
-------	------



Model

Version		Fuel	Motor code
---------	--	------	------------

**19 II, CHAMADE, Van, Cabrio**

1.9 dT	03/1992→12/1995	D	F8Q740
1.9 dT	04/1992→12/1995	D	F8Q744

**21, Station Wagon, Van**

17	03/1986→03/1993	B	F2N712
17	03/1986→02/1994	B	F3N722, F3N723
17	03/1986→04/1995	B	F2N710
17	06/1986→02/1994	B	F2N750, F3N726
17	09/1989→06/1994	B	F3N722, F3N723
1.9 D	03/1986→08/1994	D	F8Q710

**CLIO I, Van**

17	01/1991→12/1993	B	F2N770
18	01/1991→09/1998	B	F3P710
18	01/1991→09/1998	B	F3P710, F3P714
18	08/1994→09/1998	B	F3P754, F3P755
1.8 16V	01/1991→03/1996	B	F7P722
1.8 Rsi	01/1993→08/1995	B	F3P712
1.8 Rsi	08/1995→09/1998	B	F3P758
1.9 D	01/1991→09/1998	D	F8Q730, F8Q732
1.9 D	01/1991→09/1998	D	F8Q730, F8Q732
1.9 D	01/1997→09/1998	D	F8Q678
1.9 RND	04/1996→02/1998	D	F8Q678
Williams	01/1994→09/1998	B	F7R700

**CLIO II, Van**

1.9 D	02/2000→01/2011	D	F8Q632
1.9 D	03/1999→01/2000	D	F8Q662
1.9 D	09/1998→05/2011	D	F8Q630
1.9 dTi	12/1999→05/2011	D	F9Q780
2.0 16V Sport	04/2011→	B	F4R738
2.0 16V Sport	02/2000→	B	F4R730

**ESPACE III**

1.9 dTi	02/1999→02/2011	D	F9Q722
20	01/2011→02/2011	B	F4R700
20	11/1996→10/2000	B	F3R728, F3R729, F3R742, F3R768, F3R769
2.0 16V	10/1998→02/2011	B	F4R700, F4R701

**KANGOO I**

1.9 D	09/1999→03/2011	D	F8Q632
1.9 dCi	03/2011→	D	F9Q790
1.9 dCi 4x4	03/2011→	D	F9Q790
1.9 dCi 4x4	01/2011→	D	F9Q782, F9Q790
1.9 dTi	02/2000→	D	F9Q780, F9Q782
1.9 RXED	09/1999→01/2011	D	F8Q632
D 55 1.9	08/1997→	D	F8Q662
D 65 1.9	08/1997→	D	F8Q630, F8Q632

MAGNETI MARELLI			
Short	Code		
<b>Model</b>			
Version		Fuel	Motor code
81574	350981574000		
<b>RENAULT</b>			
<b>LAGUNA I, GRANDtour</b>			
18	06/1995→01/2011	B	F3P674
18	06/1995→06/1998	B	F3P676
18	06/1995→06/1998	B	F3P676
18	08/1995→01/2011	B	F3P670, F3P678
18	08/1995→01/2011	B	F3P720, F3P724
18	11/1993→01/2011	B	F3P720, F3P724
1.8 16V	04/1998→01/2011	B	F4P760
1.9 dTi	10/1997→01/2011	D	F9Q710, F9Q716
20	03/1999→01/2011	B	F3R611
20	06/1995→01/2011	B	F3R768
20	09/1999→01/2011	B	F4R780
20	11/1993→01/2011	B	F3R722, F3R723
20	11/1993→01/2011	B	
<b>MASTER II</b>			
1.9 dTi	09/2000→	D	F9Q770
<b>MEGANE I, Coach, Grantour, Scenic</b>			
1.8 16V	01/2011→	B	F4P720, F4P722
1.9 D	09/1996→09/1999	D	F8Q620, F8Q622, F8Q624, F8Q790
1.9 D Eco	01/1996→	D	F8Q620, F8Q624
1.9 dT	01/1996→09/1999	D	F8Q784, F8Q786
1.9 dTi	01/2011→	D	F9Q744
1.9 dTi	03/1997→01/2011	D	F9Q730, F9Q731, F9Q734, F9Q736
1.9 TDI	09/1996→	D	F8Q784
20	04/1997→	B	F3R750
2.0 16V	02/2011→03/2011	B	F4R770
2.0 16V	03/1996→11/1999	B	F7R710, F7R714
2.0 16V IDE	11/1999→03/2011	B	F5R740
2.0 i	01/1996→03/2011	B	F3R750, F3R751
2.0 i	01/1999→03/2011	B	F3R750, F3R752, F3R791, F3R796
2.0 RT	10/1996→02/1999	B	
2.0 RXE 4x4	05/1997→10/1999	B	F3R750
<b>RAPID, Express</b>			
1.6 D	03/1986→08/1998	D	F8M720, F8M730, F8M736, F8M760
1.6 D	09/1993→04/1995	D	F8M736
1.9 D	09/1991→03/1998	D	F8Q722, F8Q724, F8Q774, F8Q776
1.9 D	09/1994→03/1998	D	F8Q640, F8Q682
<b>SCENIC I, GRAND SCENIC</b>			
16	01/2011→03/2011	B	K4M708
1.8 16V	01/2011→03/2011	B	F4P720, F4P722
1.8 4x4	07/2000→01/2011	B	F4P722
1.9 dCi	09/1999→03/2011	D	F9Q732, F9Q733
1.9 dCi RX4	11/2000→03/2011	D	F9Q740

MAGNETI MARELLI			
Short	Code		
<b>Model</b>			
Version		Fuel	Motor code
<b>SCENIC I, GRAND SCENIC</b>			
1.9 dTi	01/2011→03/2011	D	F9Q744
1.9 dTi	09/1999→03/2011	D	F9Q731, F9Q734, F9Q736
2.0 16V	07/2000→03/2011	B	F4R740, F4R741
2.0 16V IDE	09/1999→03/2011	B	F4R740
2.0 16V RX4	06/2000→03/2011	B	F4R744
<b>Sport SPIDER</b>			
2.0 16V	03/1995→10/1999	B	F7R710
<b>Super 5, Van</b>			
1.6 D	08/1985→12/1996	D	F8M720, F8M730
1.6 D	10/1984→12/1996	D	F8M720
17	06/1987→03/1995	B	F2N740, F2N742
17	10/1986→03/1995	B	F3N716, F3N717
<b>THALIA</b>			
20	01/2011→	B	F4R738
<b>TRAFIC I</b>			
17	06/1986→08/1994	B	F1N720, F1N724
1.9 D	06/1997→01/2011	D	F8Q606
<b>VOLVO</b>			
<b>440</b>			
16	09/1988→12/1996	B	B16F
17	08/1989→12/1996	B	B18FP
17	09/1988→12/1996	B	B18KP
17	09/1988→12/1996	B	B18EP
1.7 Turbo	01/1991→12/1996	B	B18FT
1.7 Turbo	08/1988→07/1996	B	B18FT
18	08/1991→07/1996	B	B18U
18	09/1995→12/1996	B	B18U
1.9 Turbo-Diesel	07/1994→12/1996	D	D19T
20	08/1992→07/1995	B	B20F
20	08/1993→07/1996	B	B20F
<b>460</b>			
16	07/1992→07/1996	B	B16F
17	08/1989→07/1992	B	B18EP
17	08/1989→07/1992	B	
17	09/1988→07/1996	B	B18KP
17	09/1990→07/1996	B	B18KP
1.7 Turbo	01/1991→07/1996	B	B18FT
1.7 Turbo	08/1989→07/1996	B	B18FT
18	08/1991→07/1996	B	B18U
1.9 Turbo-Diesel	07/1994→07/1996	D	D19T
20	08/1992→07/1995	B	B20F
20	08/1993→07/1996	B	B20F
<b>480</b>			
17	08/1989→07/1996	B	B18EP

Short **MAGNETI MARELLI** Code

Version		Fuel	Motor code
<b>81574</b>			<b>350981574000</b>
<b>VOLVO</b>			
<b>480</b>			
1.7 Turbo	01/1991→07/1996	B	B18FT
1.7 Turbo	08/1987→07/1996	B	B18FT
20	08/1992→09/1995	B	B20F
<b>S40 I</b>			
1.9 DI	03/1999→07/2000	D	D4192T2
1.9 TD	07/1995→08/1999	D	D4192T
<b>V40 Station Wagon</b>			
1.9 DI	03/1999→07/2000	D	D4192T2
1.9 TD	07/1995→08/1999	D	D4192T

**81576** **350981576000**



**GIRANTE**  
 Diametro Alberino Ø18  
 Lunghezza Alberino 56.5  
**GIRANTE**  
 Diametro Girante Ø69  
 N° Alette Girante 9  
 Distanza Girante 17.3

<b>RENAULT</b>			
<b>ESPACE I</b>			
2.0 i Quadra	03/1988→12/1992	B	J7R760
<b>MASTER I</b>			
28-35 2.1 D	08/1980→07/1998	D	J8S330

**81578** **350981578000**



**PULEGGIA**  
 Diametro Puleggia Ø59.26  
 Numero Denti/Gole Puleggia 20  
 Altezza Puleggia 20.8  
 Posizione Puleggia 46.1  
**GIRANTE**  
 Diametro Girante Ø60  
 N° Alette Girante 6  
 Distanza Girante 19.5

<b>DACIA</b>			
<b>SOLENZA</b>			
14	03/2011→	B	
<b>RENAULT</b>			
<b>CLIO II, Van</b>			
14	09/1998→05/2011	B	E7J780

Short **MAGNETI MARELLI** Code

Version		Fuel	Motor code
<b>KANGOO I</b>			
14	08/1997→	B	E7J634, E7J635, E7J780, K7J700, K7J701
<b>MEGANE I, Coach, Grantour, Scenic</b>			
14	09/1996→	B	E7J626, E7J764
1.4 e	01/1996→	B	E7J626, E7J764
1.4 Eco	01/1996→03/1999	B	E7J624
1.4 i	01/1997→09/1999	B	E7J764
<b>RAPID, Express</b>			
14	09/1991→03/1998	B	E7J720, E7J724, E7J726, E7J773
<b>THALIA</b>			
14	08/2000→	B	K7J700

**81579** **350981579000**



**PULEGGIA**  
 Diametro Puleggia Ø59.26  
 Numero Denti/Gole Puleggia 20  
 Altezza Puleggia 20.8  
 Posizione Puleggia 40.6  
**GIRANTE**  
 Diametro Girante Ø60.5  
 N° Alette Girante 8  
 Distanza Girante 26

<b>DACIA</b>			
<b>LOGAN, Station Wagon, Van</b>			
14	04/2011→	B	K7J710
1.4 Bifuel	06/2011→	BF	K7J710
16	04/2011→	B	K7M710
1.6 LPG	08/2011→	B	K7M710



<b>SANDERO</b>			
14	08/2011→	B	K7J710
16	08/2011→	B	K7M710

<b>RENAULT</b>			
<b>CLIO II, Van</b>			
16	09/1998→05/2011	B	K7M744, K7M745

<b>KANGOO I</b>			
14	08/1997→	B	E7J634, E7J635, E7J780, K7J700, K7J701
16	09/1999→01/2011	B	K7M746

<b>KANGOO II, BePop</b>			
16	08/2011→	B	K7M750

<b>LOGAN, Station Wagon</b>			
14	04/2011→	B	K7J710
16	04/2011→	B	K7M710

MAGNETI MARELLI			
Short	Code		
			
<b>Model</b>			
Version		Fuel	Motor code
81579	350981579000		
<b>RENAULT</b>			
<b>MEGANE I, Coach, Grantour, Scenic</b>			
1.6 e	01/1996→09/1999	B	K7M702, K7M703, K7M790
1.6 i	01/1996→09/1999	B	K7M720
<b>SCENIC I, GRAND SCENIC</b>			
1.6 e	09/1999→	B	K7M702, K7M703
1.6 i	09/1999→	B	K7M720
<b>THALIA</b>			
16	03/1998→01/2011	B	K7M746

MAGNETI MARELLI			
Short	Code		
81585	350981585000		
			
<b>FLANGIA</b>			
Numero Fori Flangia			4
Dimensione Fori Flangia			M6x1
Posizione Flangia			107
Diametro Mozzo			M24x1.5
SX			
Diametro Centraggio			Ø40
<b>GIRANTE</b>			
Diametro Girante			Ø74
N° Alette Girante			7
Distanza Girante			11
<b>BMW</b>			
<b>3 II (E30), Touring, Cabrio</b>			
324 td	09/1987→06/1993	D	M21D24, M21D24WA

MAGNETI MARELLI			
Short	Code		
81586	350981586000		
			
<b>FLANGIA</b>			
Numero Fori Flangia			4
Dimensione Fori Flangia			M6x1
Posizione Flangia			106.5
Diametro Mozzo			M24x1.5
SX			
Diametro Centraggio			Ø40
<b>GIRANTE</b>			
Diametro Girante			Ø70
N° Alette Girante			7
Distanza Girante			10.5
<b>BMW</b>			
<b>3 II (E30), Touring, Cabrio</b>			
320 i	04/1986→10/1993	B	M20B20

MAGNETI MARELLI			
Short	Code		
			
<b>Model</b>			
Version		Fuel	Motor code
81587	350981587000		
			
<b>FLANGIA</b>			
Numero Fori Flangia			4
Dimensione Fori Flangia			M6x1
Posizione Flangia			54.5
Diametro Mozzo			M24x1.5
SX			
Diametro Centraggio			Ø38
<b>GIRANTE</b>			
Diametro Girante			Ø62
N° Alette Girante			7
Distanza Girante			64.3

MAGNETI MARELLI			
Short	Code		
<b>BMW</b>			
<b>3 II (E30), Touring, Cabrio</b>			
316 i	07/1988→06/1994	B	M40B16
316 i	09/1987→06/1994	B	M40B16 (Kat.)
318 i	09/1987→06/1994	B	M40B18
318i	06/1988→02/1992	B	M40B18C
<b>5 III (E34), Touring</b>			
518 i	08/1989→09/1995	B	M43B18
518 i	08/1989→09/1995	B	M40B18

MAGNETI MARELLI			
Short	Code		
81588	350981588000		
			
<b>FLANGIA</b>			
Numero Fori Flangia			4
Dimensione Fori Flangia			M6x1
Posizione Flangia			47.7
Diametro Mozzo			M24x1.5
SX			
Diametro Centraggio			Ø40
<b>GIRANTE</b>			
Diametro Girante			Ø74
N° Alette Girante			7
Distanza Girante			60.55

MAGNETI MARELLI			
Short	Code		
<b>BMW</b>			
<b>3 III (E36), Touring, Cabrio, Compact, Coupé</b>			
320 i	09/1990→10/1999	B	M50B (206S1), M50B (206S2)Vanos, M50B20TU, M52B (206S3)Vanos
323 i 2.5	03/1995→10/1999	B	M52B25 (Vanos)
323 ti	08/1997→08/2000	B	M52B25 (Vanos)
325 i	09/1990→04/1999	B	M50B25, M50B25 (Vanos)
328 i	01/1995→10/1999	B	M52B28
<b>3 IV (E46), Touring, Cabrio, Compact, Coupé</b>			
318 Ci	05/2011→	B	N46B20A
320 Ci	08/1999→09/2000	B	M52B (206S4)
320 Ci	09/2000→	B	M54226S1, M54B22
320 Ci	09/2000→	B	M54226S1
320 i	03/1998→09/2000	B	M52B (206S3)Vanos, M52B20
320 i	09/2000→05/2011	B	M54226S1

MAGNETI MARELLI			
Short	Code		
<b>Model</b>			
Version		Fuel	Motor code
<b>81588</b>	<b>350981588000</b>		
<b>BMW</b>			
<b>3 IV (E46), Touring, Cabrio, Compact, Coupé</b>			
323 Ci	04/1999→09/2000	B	M52B25 (Vanos)
323 i	03/1998→09/2000	B	M52B25 (Vanos)
325 Ci	09/2000→	B	M54256S5
325 Ci	09/2000→	B	M54256S5
325 i	09/2000→05/2011	B	M54256S5
325 ti	01/2011→05/2011	B	M54256S5
325 xi	09/2000→05/2011	B	M54256S5
328 Ci	04/1999→06/2000	B	M52B28
328 i	02/1998→06/2000	B	M52B28
330 Ci	06/2000→	B	M54306S3
330 Ci	06/2000→	B	M54306S3
330 i	06/2000→05/2011	B	M54306S3
330 xi	06/2000→05/2011	B	M54306S3
<b>5 III (E34), Touring</b>			
520 i	11/1991→01/1997	B	M50B (206S1), M50B (206S2)Vanos
520 i 24V	09/1989→09/1995	B	M50B (206S1), M50B (206S2)Vanos
525 i	11/1991→01/1997	B	M50B25
525 i 24V	09/1989→09/1995	B	M50B25, M52B25 (Vanos)
525 i X	02/1992→01/1997	B	M50B25, M52B25 (Vanos)
525 i X 24V	10/1991→09/1995	B	M52B25 (Vanos)
<b>5 IV (E39), Touring</b>			
520 i	01/1996→09/2000	B	M52B (206S3)Vanos, M52B (206S4)
520 i	04/1999→04/2011	B	M52B (206S3)Vanos
520 i	09/2000→04/2011	B	M54B22
523 i	11/1995→09/2000	B	M52B25 (Vanos)
525 i	09/2000→04/2011	B	M54256S5
528 i	11/1995→09/2000	B	M52B28
530 i	09/2000→04/2011	B	M54306S3
<b>5 V (E60), Touring (E61)</b>			
520i	03/2011→	B	M54226S1
525i	03/2011→	B	M54256S5
530i	03/2011→	B	M54306S3
<b>7 III (E38)</b>			
728 i,jL	08/1995→01/2011	B	M52B28
728i X	11/1995→01/2011	B	
<b>7 IV (E65, E66)</b>			
730 i,Li	03/2011→	B	M54306S3
<b>X3 I (E83)</b>			
2.5 i	04/2011→	B	M54256S5
3.0 i	04/2011→	B	M54306S3
<b>X5 (E53)</b>			
3.0 i	05/2000→	B	M54306S3

MAGNETI MARELLI			
Short	Code		
<b>Model</b>			
Version		Fuel	Motor code
<b>X5 (E53)</b>			
3.0 i	05/2000→	B	M54306S3
<b>Z3, Coupé</b>			
20	04/1999→03/2011	B	M52B (206S4)
22	08/2000→03/2011	B	M54226S1, M54B22
28	04/1997→06/2000	B	M52B28
30	06/2000→03/2011	B	M54306S3
<b>Z4 I, Coupé</b>			
2.2 i	03/2011→	B	M54226S1
2.5 i	03/2011→	B	M54256S5
3.0 i	03/2011→	B	M54306S3

81589 350981589000			
		<b>FLANGIA</b>	
		Numero Fori Flangia	4
		Dimensione Fori Flangia	M6x1
		Posizione Flangia	56
		Diametro Mozzo	M24x1.5
		SX	
		Diametro Centraggio	Ø38
		<b>GIRANTE</b>	
		Diametro Girante	Ø62
		N° Alette Girante	7
		Distanza Girante	59.5

BMW			
<b>3 III (E36), Touring, Cabrio, Compact, Coupé</b>			
316 i	09/1990→09/1993	B	M40B16 (Kat.)
316 i	09/1990→09/1993	B	M40B16, M43B16
318 i	12/1990→10/1993	B	M40B18
<b>5 III (E34), Touring</b>			
518 g	11/1995→06/1996	BF	M43B18
518 i	03/1993→09/1994	B	M40B18
518 i	08/1989→01/1997	B	M43B18

81590 350981590000			
		<b>FLANGIA</b>	
		Numero Fori Flangia	4
		Dimensione Fori Flangia	M6x1
		Posizione Flangia	56.5
		Diametro Mozzo	M24x1.5
		SX	
		Diametro Centraggio	Ø38
		<b>GIRANTE</b>	
		Diametro Girante	Ø62
		N° Alette Girante	7
		Distanza Girante	59.5

BMW			
<b>3 III (E36), Touring, Cabrio, Compact, Coupé</b>			
316 g	12/1995→08/2000	BF	

Short **MAGNETI MARELLI** Code



**Model**

Version		Fuel	Motor code
<b>81590</b>			<b>350981590000</b>
<b>BMW</b>			
<b>3 III (E36), Touring, Cabrio, Compact, Coupé</b>			
316 i	07/1993→08/2000	B	M43B16
316 i	09/1990→09/1993	B	M40B16 (Kat.)
316 i	12/1998→08/2000	B	M43164E3
318 i	10/1993→10/1999	B	M43B18
318 is	03/1992→09/1997	B	M42B18
318 is	09/1995→04/1999	B	M44B19
318 ti	07/1995→08/2000	B	M44B19
318 ti	11/1994→08/1995	B	M42B18
<b>3 IV (E46), Touring, Cabrio, Compact, Coupé</b>			
316 Ci	04/2000→	B	M43B16 (164E3)
316 i	04/2000→05/2011	B	M43B16 (164E3)
316 i	09/1998→05/2011	B	M43164E3, M43B19TU
318 Ci	11/1999→01/2011	B	M43B19
318 i	02/1998→01/2011	B	M43B19
<b>5 III (E34), Touring</b>			
518 i	08/1989→09/1995	B	M43B18
<b>Z3, Coupé</b>			
18	10/1995→10/1998	B	M43B18
19	01/1999→03/2011	B	M43194E1
19	07/1998→03/2011	B	M43194E1, M43B19
19	10/1995→03/1999	B	M44B19

**81593** **350981593000**



**PULEGGIA**  
 Diametro Puleggia 059.17  
 Numero Denti/Gole Puleggia 20  
 Altezza Puleggia 27.5  
 Posizione Puleggia 29

**GIRANTE**  
 Diametro Girante 072  
 N° Alette Girante 7  
 Distanza Girante 33

**VOLKSWAGEN**

**LT I**

2.4 D	08/1989→06/1996	D	1S, ACT
2.4 D	12/1978→07/1992	D	CP, DW
2.4 TD	08/1988→08/1992	D	1G
2.4 TD	12/1982→09/1993	D	DV

**VOLVO**

**240, Station Wagon**

2.4 Diesel	08/1978→08/1993	D	D24
2.4 Diesel	08/1987→08/1993	D	D24

Short **MAGNETI MARELLI** Code



**Model**

Version		Fuel	Motor code
<b>740, Station Wagon</b>			
2.4 Diesel	08/1984→07/1992	D	D24
2.4 Turbo-Diesel	09/1985→07/1992	D	D24T
<b>760, Station Wagon</b>			
2.4 D	01/1982→07/1992	D	D24
2.4 TD Interc.	08/1987→07/1992	D	D24TIC
2.4 Turbo Diesel	04/1987→07/1992	D	D24T
<b>940 I, Station Wagon</b>			
2.4 D	08/1990→07/1995	D	D24
2.4 TD Intercooler	08/1990→12/1994	D	D24TIC
2.4 Turbo Diesel	08/1990→12/1994	D	D24T
<b>960 I, Station Wagon</b>			
2.4 TD Interc.	09/1991→07/1994	D	D24TIC

**81594** **350981594000**



**FLANGIA**  
 Numero Fori Flangia 4  
 Dimensione Fori Flangia M6x1  
 Posizione Flangia 131

**GIRANTE**  
 Diametro Girante 070  
 N° Alette Girante 6  
 Distanza Girante -0.5

**VOLVO**

**240, Station Wagon**

20	08/1983→07/1993	B	B200E
2.3 Cat.	08/1991→07/1992	B	B230F
2.3 i Cat.	08/1986→07/1993	B	B230F

**740, Station Wagon**

20	08/1985→07/1992	B	B200G
20	08/1989→08/1992	B	B200F
23	08/1987→07/1992	B	B230F
23	08/1988→08/1992	B	B234F

**760, Station Wagon**

23	01/1988→07/1992	B	B230FT
----	-----------------	---	--------

**940 I, Station Wagon**

20	01/1992→07/1994	B	B200F
20	09/1990→09/1993	B	B200G
20	09/1990→09/1993	B	B204FT
2.0 GL	09/1990→04/1992	B	B204E
2.0 Turbo	08/1990→07/1995	B	B200FT
23	08/1990→12/1994	B	B230FB, B230G
23	08/1992→07/1994	B	B230FD
2.3 Turbo	08/1990→07/1994	B	B230FT

Short **MAGNETI MARELLI** Code



Model			
Version		Fuel	Motor code
<b>81594</b>	<b>350981594000</b>		
<b>VOLVO</b>			
<b>940 I, Station Wagon</b>			
2.3 Turbo	08/1991→07/1993	B	B230FT+
<b>940 II, Station Wagon</b>			
20	10/1994→05/1997	B	B204FT
20	11/1994→12/1995	B	B200G
2.0 GLT	10/1994→05/1997	B	B200GT
2.0 Turbo	04/1996→10/1998	B	B200FT
23	08/1994→10/1998	B	B230FB
23	08/1994→07/1995	B	B230FD
23	10/1994→05/1997	B	B230GK
2.3 ti	01/1995→10/1998	B	B230FK
2.3 Turbo	08/1994→10/1998	B	B230FT
2.3 Turbo	08/1995→10/1998	B	B230FT
<b>960 I, Station Wagon</b>			
20	08/1990→09/1993	B	B204FT
20	09/1990→08/1993	B	B204E
2.3 Turbo	09/1990→08/1993	B	B230FT

**81596** **350981596000**



**PULEGGIA**  
 Diametro Puleggia Ø144  
 Numero Denti/Gole Puleggia 1  
 Posizione Puleggia 29.5  
**GIRANTE**  
 Diametro Girante Ø67  
 N° Alette Girante 8  
 Distanza Girante 18

**RENAULT**

<b>CLIO I, Van</b>			
12	06/1994→02/1998	B	C3G720
<b>RAPID, Express</b>			
12	09/1991→03/1998	B	C3G710, C3G712
<b>TWINGO I, Van</b>			
12	03/1993→10/1996	B	C3G700, C3G702

Short **MAGNETI MARELLI** Code



Model					
Version		Fuel	Motor code		
<b>81597</b>	<b>350981597000</b>				
				<b>FLANGIA</b>	
				Numero Fori Flangia	4
		Dimensione Fori Flangia	M6x1		
		Posizione Flangia	55.85		
		Diametro Mozzo SX	M24x1.5		
		Diametro Centraggio	Ø40		
<b>GIRANTE</b>					
		Diametro Girante	Ø74		
		N° Alette Girante	7		
		Distanza Girante	60.55		

**BMW**

<b>3 III (E36), Touring, Cabrio, Compact, Coupé</b>			
318 tds	01/1995→08/2000	D	M41D18 (Inter.)
325 td	09/1991→02/1998	D	M51D25
325 tds	05/1993→10/1999	D	M51D25 (Inter.)

**5 III (E34), Touring**

525 td	03/1993→01/1997	D	M51D25
525 tds	09/1991→01/1997	D	M51D25 (Inter.)

**5 IV (E39), Touring**

525 td	01/1997→03/2011	D	M51D25
525 tds	01/1996→04/2011	D	M51D25 (Inter.)

**7 III (E38)**

725 tds	04/1996→01/2011	D	M51D25 (Inter.)
---------	-----------------	---	-----------------

**LAND ROVER**

**RANGE ROVER**

2.5 D	07/1994→02/2011	D	256T (BMW)
-------	-----------------	---	------------

**OPEL**

**OMEGA B, Station Wagon**

2.5 TD	04/1994→03/2011	D	25DT, X25DT, X25TD
--------	-----------------	---	--------------------

**81598** **350981598000**



**FLANGIA**  
 Numero Fori Flangia 4  
 Dimensione Fori Flangia M8x1.25  
 Posizione Flangia 93  
**GIRANTE**  
 Diametro Girante Ø55.5  
 N° Alette Girante 6  
 Distanza Girante 12.5

**FORD**

**FIESTA IV, Van**

1.25 i 16V	08/1995→02/2011	B	DHA, DHB, DHC, DHD, DHE, DHF, DHG
1.4 i	04/1996→10/1999	B	FHA
1.4 i 16V	04/1996→02/2011	B	FHA, FHE



MAGNETI MARELLI			
Short	Code		
<b>Model</b>			
Version		Fuel	Motor code
81598	350981598000		
<b>FORD</b>			
<b>FIESTA IV, Van</b>			
1.6 16V Sport	02/2000→02/2011	B	L1T, L1V
<b>FIESTA V, Van</b>			
1.25 16V	03/2011→	B	M7JA, M7JB
1.25 16V	02/2011→	B	FUJA, FUJB
1.4 16V	01/2011→	B	FXJA, FXJB
1.6 16V	01/2011→	B	FYJA
<b>FOCUS C-Max</b>			
16	03/2011→07/2011	B	HWDA
1.6 Ti	04/2011→07/2011	B	HXDA
<b>FOCUS I, Station Wagon</b>			
1.4 16V	10/1998→04/2011	B	FXDA, FXDB, FXDC, FXDD
16	09/2000→03/2011	B	
1.6 16V	10/1998→04/2011	B	FYDA, FYDB, FYDC, FYDD
1.6 16V Flexifuel	02/2011→04/2011	FF	
<b>FOCUS II, Station Wagon, Cabrio</b>			
14	04/2011→	B	ASDA, ASDB
16	04/2011→	B	HWDA, HWDB
1.6 Ti	04/2011→	B	HXDA
<b>FUSION</b>			
125	04/2011→	B	FUJA, FUJB
14	02/2011→	B	FXJA, FXJB
16	02/2011→	B	FYJA
<b>PUMA</b>			
1.4 16V	11/1997→10/2000	B	FHD, FHF
1.6 16V	08/2000→	B	L1W
1.7 16V	03/1997→	B	MHA, MHB
ST 160	06/1999→	B	
<b>MAZDA</b>			
<b>121 II</b>			
1.3 16V	11/1990→03/1996	B	B3 (16V)
<b>121 III</b>			
125	03/1996→	B	DHF, DHG
<b>2 I</b>			
125	03/2011→	B	FUJA
14	03/2011→	B	FXJA
16	03/2011→	B	FYJA
<b>VOLVO</b>			
<b>C30</b>			
16	06/2011→	B	B4164S3
<b>V50</b>			
16	05/2011→	B	B4164S3

MAGNETI MARELLI			
Short	Code		
<b>Model</b>			
Version		Fuel	Motor code
81601	350981601000		
Numero Fori Flangia			4
Dimensione Fori Flangia			M6x1
Posizione Flangia			51.5
Diametro Mozzo			Ø25
<b>GIRANTE</b>			
Diametro Girante			Ø70
N° Alette Girante			8
Distanza Girante			30.7
<b>SAAB</b>			
<b>900 I, Cabrio</b>			
2.0 -16	01/1989→06/1994	B	B202I
2.0 S Turbo-16	01/1992→12/1993	B	B202S
2.0 S Turbo-16	07/1991→06/1994	B	B202S
2.0 Turbo-16	01/1993→06/1994	B	B202L
2.0 Turbo-16	11/1985→06/1994	B	B202XL
2.0 Turbo-16 S	01/1984→06/1994	B	B202XL
2.0 Turbo-16 S Cat.	01/1989→12/1993	B	B202XL
2.0 Turbo-16 S Cat.	01/1989→12/1993	B	B202XL
2.1 -16	08/1990→06/1994	B	B212I
<b>81602</b> 350981602000			
Numero Fori Flangia			4
Dimensione Fori Flangia			M8x1.25
Posizione Flangia			95.5
Diametro Mozzo			M24x1.5
SX			
Diametro Centraggio			Ø32.2
<b>GIRANTE</b>			
Diametro Girante			Ø71
N° Alette Girante			7
Distanza Girante			12.5
<b>FORD</b>			
<b>P 100 II</b>			
20	10/1987→	B	NAE
<b>SCORPIO I, Station Wagon</b>			
18	04/1985→02/1992	B	REC
2.0 i	04/1985→02/1992	B	NRA, NRI
<b>SIERRA II, Station Wagon</b>			
16	01/1987→02/1993	B	LSE
16	01/1988→02/1993	B	LSF
1.6 i	10/1989→02/1993	B	L6B
1.6 i	10/1989→02/1993	B	L6B
20	01/1987→02/1993	B	N8C, NES
20	07/1989→12/1992	B	N8A

Short	Code
-------	------



Model			
Version		Fuel	Motor code
<b>81602</b>	<b>350981602000</b>		
<b>FORD</b>			
<b>SIERRA II, Station Wagon</b>			
2.0 16V Cosworth 4x4	01/1990→02/1993	B N5D	
2.0 16V Cosworth 4x4 Cat.	01/1990→02/1993	B N5C	
2.0 4x4	01/1990→02/1993	B N9C	
2.0 i	01/1987→02/1993	B N4A, N4I	
2.0 i	01/1987→02/1993	B NE5, NEJ	
2.0 i	06/1989→02/1993	B N8A	
2.0 i Cat.	01/1987→02/1993	B N4B	
<b>TRANSIT IV</b>			
16	09/1985→09/1992	B LAT	
20	09/1985→09/1992	B NAT, NAV	
20	11/1985→09/1992	B N6T	
<b>TRANSIT TOURNEO I</b>			
20	11/1994→12/2000	B NSH	
<b>TRANSIT V</b>			
20	09/1991→09/1994	B NBA	
20	09/1991→08/1994	B NCA	
2.0 i	09/1991→07/1994	B NCA	
<b>TRANSIT VI</b>			
20	06/1994→03/2000	B NSF, NSG	
2.0 CNG	06/1994→03/2000	BF NSH	

Short	Code
-------	------



<b>GIRANTE</b>	Diametro Alberino	M14x1.5
	Tipo Filetto Alberino	Maschio
	Lunghezza Alberino	90
<b>GIRANTE</b>	Diametro Girante	Ø64
	N° Alette Girante	6
	Distanza Girante	26

FORD			
<b>SCORPIO I, Station Wagon</b>			
2.5 D	12/1985→12/1994	D STR	
<b>SIERRA II, Station Wagon</b>			
2.3 D	01/1987→02/1993	D YTR, YTT	
<b>PEUGEOT</b>			
<b>505, Break</b>			
2.5 Diesel	06/1981→12/1993	D 155 (XD3)	
2.5 Diesel	10/1981→12/1993	D 155 (XD3)	

Short	Code
-------	------



Model			
Version		Fuel	Motor code
<b>81605</b>	<b>350981605000</b>		
<b>OPEL</b>			
<b>ASTRA F, Station Wagon, Cabrio</b>			
1.7 D	07/1992→01/1999	D 17DR	
1.7 D	12/1991→09/1992	D 17D	
<b>KADETT E, Station Wagon, Van</b>			
1.7 D	07/1992→07/1994	D 17DR	
1.7 D	08/1988→07/1994	D 17D	
<b>VECTRA A</b>			
1.7 D	07/1992→11/1995	D 17DR	
1.7 D	09/1988→09/1992	D 17D	





<b>PULEGGIA</b>	Diametro Puleggia	Ø62.3
	Numero Denti/Gole Puleggia	21
	Altezza Puleggia	26
	Posizione Puleggia	37
<b>GIRANTE</b>	Diametro Girante	Ø65
	N° Alette Girante	8
	Distanza Girante	29

Short	Code
-------	------





<b>PULEGGIA</b>	Diametro Puleggia	Ø62.3
	Numero Denti/Gole Puleggia	21
	Altezza Puleggia	21.5
	Posizione Puleggia	40
<b>GIRANTE</b>	Diametro Girante	Ø65
	N° Alette Girante	8
	Distanza Girante	29



DAEWOO			
<b>ESPERO</b>			
18	02/1995→09/1999	B C18LE	
18	02/1995→06/1999	B C18LE	
20	02/1995→06/1999	B C20LE	
20	10/1991→09/1993	B C20LZ	
20	10/1993→09/1994	B C20LE	
<b>OPEL</b>			
<b>ASTRA F, Station Wagon, Cabrio</b>			
1.8 i	09/1991→09/1998	B C18NZ	
2.0 i	09/1991→09/1998	B C20NE	
<b>CALIBRA</b>			
2.0 i	06/1990→07/1997	B C20NE	
2.0 i 4x4	06/1990→07/1997	B C20NE	

MAGNETI MARELLI			
Short	Code		
			
<b>Model</b>			
Version		Fuel	Motor code
<b>81606</b>	<b>350981606000</b>		
<b>OPEL</b>			
<b>FRONTERA A</b>			
2.0 i	03/1992→10/1998	B	C20NE, X20SE
<b>KADETT E, Station Wagon, Van</b>			
2.0 i	10/1986→02/1993	B	20NE
2.0 i Cat.	10/1986→02/1993	B	C20NE
<b>OMEGA A, Station Wagon</b>			
18	09/1986→03/1994	B	18SEH
18	09/1987→03/1994	B	E18NVR
1.8 S	09/1986→03/1994	B	18SV
20	09/1986→03/1994	B	20SE
2.0 i	09/1986→03/1994	B	C20NE
<b>VECTRA A</b>			
1.8 i Cat.	03/1990→11/1995	B	C18NZ
2.0 i	09/1988→09/1992	B	20SEH
2.0 i 4x4	01/1989→09/1992	B	20SEH
2.0 i 4x4 Cat.	01/1989→11/1995	B	C20NE
2.0 i Cat.	09/1988→11/1995	B	C20NE
2.0 i GT	09/1988→11/1995	B	20SEH

MAGNETI MARELLI			
Short	Code		
<b>81608</b>	<b>350981608000</b>		
			
<b>FLANGIA</b>			
Numero Fori Flangia	3		
Dimensione Fori Flangia	M8x1.25		
Posizione Flangia	71		
Diametro Centraggio	Ø51		
<b>GIRANTE</b>			
Diametro Girante	Ø69		
N° Alette Girante	9		
Distanza Girante	17.3		

MAGNETI MARELLI			
Short	Code		
<b>RENAULT</b>			
<b>21, Station Wagon, Van</b>			
20	02/1990→06/1994	B	J7R740
20	03/1986→10/1993	B	J6R758, J6R759, J6R792, J6R793
20	03/1986→12/1993	B	J7R746, J7R747
20	05/1991→10/1993	B	
2.0 4x4	03/1989→12/1993	B	J7R746, J7R747
2.0 4x4	12/1989→02/1994	B	J7R740
2.1 D	02/1992→09/1995	D	J8S784
2.1 D	05/1989→06/1994	D	J8S600, J8S740
2.1 D	06/1986→08/1994	D	J8S704
2.1 D 4x4	10/1988→05/1992	D	J8S704
2.1 Turbo-D	03/1986→06/1994	D	J8S714, J8S786, J8S788
22	06/1986→06/1994	B	J7T754, J7T755

MAGNETI MARELLI			
Short	Code		
			
<b>Model</b>			
Version		Fuel	Motor code
<b>21, Station Wagon, Van</b>			
2.2 4x4	06/1986→06/1994	B	J7T754, J7T755
<b>TRAFIC I</b>			
2.1 D	06/1994→10/1997	D	J8S620, J8S758

MAGNETI MARELLI			
Short	Code		
<b>81612</b>	<b>350981612000</b>		
			
			
<b>PULEGGIA</b>			
Diametro Puleggia	Ø50		
Numero Denti/Gole Puleggia	17		
Altezza Puleggia	32		
Posizione Puleggia	61.5		
<b>GIRANTE</b>			
Diametro Girante	Ø71.5		
N° Alette Girante	6		
Distanza Girante	16		
<b>ROVER</b>			
<b>Maestro</b>			
16	09/1990→01/1995	B	

MAGNETI MARELLI			
Short	Code		
<b>81613</b>	<b>350981613000</b>		
			
			
<b>PULEGGIA</b>			
Diametro Puleggia	Ø56.3		
Numero Denti/Gole Puleggia	19		
Altezza Puleggia	26.5		
Posizione Puleggia	53		
<b>GIRANTE</b>			
Diametro Girante	Ø62		
N° Alette Girante	7		
Distanza Girante	15		

MAGNETI MARELLI			
Short	Code		
<b>HONDA</b>			
<b>CIVIC III, Hatchback, SHUTTLE</b>			
1.4 i 16V	01/1988→12/1992	B	D14A1
1.6 4x4	01/1988→12/1992	B	D16A, D16A7
1.6 i 16V 4WD	01/1988→02/1995	B	D16A6
<b>CIVIC IV, Hatchback, SHUTTLE</b>			
1.3 16V	10/1991→11/1995	B	D13B2
1.4 i	09/1994→01/1997	B	D14A2
1.4 i	09/1995→01/1997	B	D14A5
15	01/1992→12/1992	B	D15B2
1.5 i 16V	10/1991→11/1995	B	D15B2, D15Z1
1.5 i 16V	10/1991→11/1995	B	D15B2
1.5 i LSi	01/1994→11/1995	B	D15B7
1.5 i Vtec-E	09/1994→01/1997	B	D15Z3
1.6 16V Vtec	10/1991→11/1995	B	D16Z6
1.6 4x4	01/1992→10/1995	B	D16Z7

Short Code



Model

Version		Fuel	Motor code
---------	--	------	------------

81613 350981613000

HONDA

CIVIC IV, Hatchback, SHUTTLE

1.6 EX	08/1993→10/1995	B	D16A7
1.6 i	01/1994→11/1995	B	D16Y7
1.6 i	09/1994→01/1997	B	D16Y3
1.6 i Vtec	01/1994→03/1996	B	D16Y6, D16Z9
1.6 i Vtec	09/1994→01/1997	B	D16Y2

CIVIC V, Aerodeck, Hatchback, SHUTTLE

14	11/1995→10/1998	B	D14A4
1.4 i	11/1995→01/2011	B	D14A4
1.4 i S	11/1995→01/2011	B	D14A4

CONCERTO

14	10/1989→10/1992	B	D14A1
1.5 i 16V	08/1989→05/1995	B	D15B2
16	10/1989→10/1992	B	D16A9
1.6 16V	08/1989→03/1995	B	D16Z2
1.6 i 16V	08/1989→03/1995	B	D16A8
1.6 i 16V	08/1989→03/1995	B	D16Z2

CRX II

1.6 i 16V	10/1987→02/1992	B	D16Z5
1.6 i 16V Vtec	10/1989→02/1992	B	B16A1
CRX III			
1.6 ESi	03/1992→12/1998	B	D16Z6
1.6 i VTi	03/1992→12/1998	B	B16A2

ROVER

200 II, Coupé

216	10/1992→06/1999	B	D16A8
216 GSi	10/1989→10/1995	B	D16Z2
216 GSi	10/1989→10/1995	B	D16A7
216 GTi	09/1990→10/1995	B	D16A9
216 GTi	09/1990→10/1995	B	D16A8

400 I

1.6 i	05/1994→11/1998	B	D16Z2
1.6 i	05/1994→11/1998	B	D16A8
416 GSi	04/1990→04/1995	B	D16Z2
416 GSi/GSE	04/1990→04/1995	B	D16A7
416 GTi	04/1990→04/1995	B	D16A8
416 GTi/GTE	04/1990→04/1995	B	D16A9

Cabriolet

216 1.6i	01/1992→11/1999	B	D16A8
216 1.6i 16V	01/1996→11/1999	B	16K4F

Short Code



Model

Version		Fuel	Motor code
---------	--	------	------------

81614 350981614000



<b>PULEGGIA</b>		
Diametro Puleggia		Ø59.45
Numero Denti/Gole Puleggia		24
Altezza Puleggia		32.5
Posizione Puleggia		45
<b>GIRANTE</b>		
Diametro Girante		Ø58.5
N° Alette Girante		6
Distanza Girante		16.5

ROVER

100 (Metro), Cabrio

111	04/1994→	B	11K2D
111 C/L/S	03/1990→12/1998	B	11K2A, 11K2D
114	04/1994→	B	14K2A, 14K2D
114 S/L/GTA	03/1990→12/1998	B	14K2A, 14K2D

200 II, Coupé

214	09/1993→10/1995	B	14K2A, 14K2D
-----	-----------------	---	--------------

200 III

211	01/1998→03/2000	B	11K2D
214 i	11/1995→03/2000	B	14K2F

81615 350981615000



<b>PULEGGIA</b>		
Diametro Puleggia		Ø59.45
Numero Denti/Gole Puleggia		24
Altezza Puleggia		32.5
Posizione Puleggia		45
<b>GIRANTE</b>		
Diametro Girante		Ø58.5
N° Alette Girante		6
Distanza Girante		16.5

LOTUS

ELISE I

1.8 16V	08/1995→11/2000	B	18K4F
111 S	03/1999→11/2000	B	18K4K

MG

MG TF

115	02/2011→	B	16K4F
120	02/2011→	B	18K4F
135	02/2011→	B	18K4F
160	02/2011→	B	18K4K

MG ZR

105	01/2011→	B	14K4F
120	01/2011→	B	18K4F

MAGNETI MARELLI			
Short	Code		
<b>Model</b>			
Version		Fuel	Motor code
<b>81615</b>	<b>350981615000</b>		
<b>MG</b>			
<b>MG ZR</b>			
160	01/2011→	B	18K4K
<b>MG ZS</b>			
120	01/2011→	B	18K4F
<b>MGF</b>			
1.8 i VVC	01/2011→02/2011	B	18K4K
16	02/2000→02/2011	B	16K4F
1.8 i 16V	03/1995→02/2011	B	18K4F
1.8 i VVC	03/1995→02/2011	B	18K4K
<b>ROVER</b>			
<b>25</b>			
1.1 16V	04/2011→	B	11K4F
1.4 16V	10/1999→	B	14K4F
1.4 16V	10/1999→	B	14K4M
1.6 16V	10/1999→	B	16K4F
1.8 16V	02/2000→	B	18K4K
1.8 16V	10/1999→	B	18K4F
<b>45</b>			
14	02/2000→	B	14K4F
16	02/2000→	B	16K4F
18	02/2000→	B	18K4F
<b>75, Tourer</b>			
18	02/1999→	B	K1.8
1.8 Turbo	03/2011→	B	
<b>100 (Metro), Cabrio</b>			
114	03/1997→10/1998	B	14K4F
114 GSi	10/1994→10/1995	B	14K4F
114 GTI 16V	08/1991→12/1998	B	14K4F
114 GTI/GT 16V Cat.	03/1990→12/1998	B	14K4C, 14K4D
<b>200 II, Coupé</b>			
214 GSi/Si	01/1990→10/1995	B	14K4C
214 GSi/Si	12/1992→10/1995	B	14K4F
214 Si/Gsi	10/1989→10/1995	B	14K4C, 14K4D
<b>200 III</b>			
214 Si	11/1995→03/2000	B	14K4F
216 Si	11/1995→03/2000	B	16K4F
218 K Vi	11/1995→03/2000	B	18K4K
<b>400 I</b>			
1.6 i	05/1994→11/1998	B	D16Z2
1.6 i	05/1994→11/1998	B	D16A8
1.8 i	06/1996→11/1998	B	18K4K
414	01/1993→04/1995	B	14K4C
414 GSi/SI	04/1990→04/1995	B	14K4C, 14K4D

MAGNETI MARELLI			
Short	Code		
<b>Model</b>			
Version		Fuel	Motor code
<b>400 I</b>			
414 GSi/SI Cat.	01/1993→04/1995	B	14K4F
<b>400 II</b>			
414 Si	05/1995→03/2000	B	14K4F
416 Si	05/1995→03/2000	B	D16Y2
416 Si	05/1995→03/2000	B	16K4F
<b>Cabriolet</b>			
214 1.4	01/1992→11/1999	B	14K4C, 14K4D
214 1.4	04/1990→09/1992	B	14K4C
214 1.4i 16V	01/1993→11/1999	B	14K4F
<b>Coupé</b>			
1.6 16 V	03/1996→11/1999	B	16K4F
1.8 16 V	03/1996→11/1999	B	18K4K
<b>STREETWISE</b>			
14	03/2011→	B	14K4F
14	03/2011→	B	14K4M

81616	350981616000		
<b>FLANGIA</b>			
Numero Fori Flangia			4
Dimensione Fori Flangia			M6x1
Posizione Flangia			106.8
Diametro Mozzo			M24x1.5
SX			
Diametro Centraggio			Ø40
<b>GIRANTE</b>			
Diametro Girante			Ø70
N° Alette Girante			7
Distanza Girante			10.5

BMW			
<b>3 II (E30), Touring, Cabrio</b>			
320 i	04/1986→10/1993	B	M20B20
325 i	12/1986→10/1993	B	M20B25
325 i X	12/1986→10/1993	B	M20B25

81617	350981617000		
<b>FLANGIA</b>			
Numero Fori Flangia			4
Dimensione Fori Flangia			M6x1
Posizione Flangia			107
Diametro Mozzo			M24x1.5
SX			
Diametro Centraggio			Ø40
<b>GIRANTE</b>			
Diametro Girante			Ø74
N° Alette Girante			7
Distanza Girante			11

BMW			
<b>5 III (E34), Touring</b>			
524 td	03/1988→09/1995	D	M21D24, M21D24WA

Short **MAGNETI MARELLI** Code



Model

Version		Fuel	Motor code
---------	--	------	------------

81618 350981618000



<b>FLANGIA</b>	
Numero Fori Flangia	4
Dimensione Fori Flangia	M6x1
Posizione Flangia	99.5
Diametro Mozzo	M24x1.5
SX	
Diametro Centraggio	Ø40
<b>GIRANTE</b>	
Diametro Girante	Ø75
N° Alette Girante	7
Distanza Girante	-0.5

**BMW**

**5 III (E34), Touring**

535 i	01/1988→09/1995	B	M30B35
M5 3.6	10/1988→05/1992	B	S38B36
M5 3.6 Cat.	10/1988→05/1992	B	S38B36 (Kat)

**7 II (E32)**

730 i,jL	12/1986→09/1994	B	M30B30
730 i,jL	12/1986→09/1994	B	M30B30
735 i,jL	09/1986→09/1992	B	M30B35

81619 350981619000



<b>PULEGGIA</b>	
Diametro Puleggia	Ø62.3
Numero Denti/Gole Puleggia	21
Altezza Puleggia	26.5
Posizione Puleggia	47
<b>GIRANTE</b>	
Diametro Girante	Ø63
N° Alette Girante	6
Distanza Girante	52.5

**LADA**

**SAMARA**

1100	02/1988→12/1994	B	BA321081
1300	01/1986→12/1994	B	BA32108
1300	01/1988→	B	BA32108
1300	09/1991→	B	BA32108 (KAT)
1500	01/1988→	B	BA321083
1500	09/1991→	B	BA321083 (KAT)

**SAMARA Forma**

1100	07/1991→	B	BA321081 (KAT)
1300	05/1989→07/1997	B	BA32108
1300	05/1990→	B	
1300	07/1991→	B	BA32108
1500	07/1991→	B	BA321083 (KAT)
1500	09/1991→	B	BA321083

Short **MAGNETI MARELLI** Code



Model

Version		Fuel	Motor code
---------	--	------	------------

81621 350981621000



<b>FLANGIA</b>	
Numero Fori Flangia	4
Dimensione Fori Flangia	M6x1
Posizione Flangia	91.5
Diametro Mozzo	Ø50
<b>GIRANTE</b>	
Diametro Girante	Ø70
N° Alette Girante	8
Distanza Girante	6.5

**SAAB**

**9000**

2.0 -16	12/1985→01/1993	B	B202I, B202XI
2.0 -16 CS	01/1989→12/1998	B	B202I
2.0 -16 Turbo	05/1988→08/1993	B	B202XL
2.0 -16 Turbo	06/1989→12/1992	B	B202
2.0 -16 Turbo	09/1984→08/1993	B	B202XL
2.0 -16 Turbo CD	09/1988→08/1993	B	B202XL
2.0 -16 Turbo CD	09/1989→12/1998	B	B202L
2.0 -16 Turbo CS	09/1988→12/1998	B	B202L

81642 350981642000



<b>PULEGGIA</b>	
Diametro Puleggia	Ø59.26
Numero Denti/Gole Puleggia	20
Altezza Puleggia	33.5
Posizione Puleggia	42.5
<b>GIRANTE</b>	
Diametro Girante	Ø69
N° Alette Girante	8
Distanza Girante	41.3

**CITROËN**

**BERLINGO I, Furgonato**

1.8 D	07/1996→	D	A9A (XUD7)
1.8 X	11/1996→10/1999	D	
1.9 D	07/1996→	D	D9B (XUD9A/L), DJY (XUD9A)
1.9 D	07/1996→10/1999	D	DJY (XUD9A)

**C 15, Station Wagon**

1.8 D	07/1986→12/2000	D	161A (XUD7)
-------	-----------------	---	-------------

**EVASION**

1.9 TD	10/1995→12/1998	D	D8B (XUD9TF)
1.9 TD	11/1994→02/2011	D	D8B (XUD9TF), DHX (XUD9TF/BTF)
20	06/1994→02/2011	B	RFU (XU10J2/C)
2.0 TD	05/1997→02/2011	D	
2.0 Turbo C.T.	06/1994→02/2011	B	RGX (XU10J2TE)

MAGNETI MARELLI			
Short	Code		
<b>Model</b>			
Version		Fuel	Motor code
81642	350981642000		
<b>CITROËN</b>			
<b>JUMPER I</b>			
1.9 D	02/1994→02/2011	D	D9B (XUD9A/U)
1.9 D	07/1999→02/2011	D	DJY (XUD9A)
1.9 TD	02/1994→02/2011	D	D8C (XUD9UTF)
1.9 TD	03/1994→02/2011	D	D8C (XUD9UTF), DHX (XUD9TF/BTF)
1.9 TD 4x4	08/1996→02/2011	D	D8C (XUD9UTF)
20	02/1994→02/2011	B	RFW (XU10J2U)
2.0 4x4	08/1996→02/2011	B	RFW (XU10J2U)
<b>JUMPER II</b>			
20	02/2011→	B	XU10J2
2.0 bivalent	03/2011→	BF	XU10J2
<b>JUMPY I</b>			
1.9 D	10/1995→08/1998	D	D9B (XUD9A/U)
1.9 DT	10/1995→08/2000	D	
1.9 TD	04/1996→	D	D8B (XUD9TF)
1.9 TD	10/1995→	D	DHX (XUD9TF/BTF)
<b>XANTIA I, Break</b>			
1.9 D	06/1994→01/1998	D	DJZ (XUD9Y)
1.9 D	06/1994→01/1998	D	D9B (XUD9A/L)
1.9 SD	02/1996→01/1998	D	DHW (XUD9SD)
1.9 Turbo D	10/1994→01/1998	D	D8B (XUD9TF), DHX (XUD9TF/BTF), DHY (XUD9TE/Y)
2.0 i	03/1993→01/1998	B	RFX (XU10J2C)
2.0 i 16V	03/1993→01/1998	B	RFY (XU10J4/Z)
2.0 i 16V	06/1994→01/1998	B	RFT (XU10J4/Z)
2.0 i 16V	06/1995→01/1998	B	RFV (XU10J4R)
2.0 Turbo	06/1995→01/1998	B	RGX (XU10J2TE)
<b>XANTIA II, Break</b>			
1.9 SD	01/1998→03/2011	D	DHW (XUD9SD)
1.9 Turbo D	01/1998→03/2011	D	D8B (XUD9TF), DHX (XUD9TF/BTF), DHY (XUD9TE/Y)
2.0 i	01/1998→03/2011	B	RFX (XU10J2C)
2.0 Turbo	01/1998→03/2011	B	RGX (XU10J2TE)
<b>XM I, Break</b>			
20	05/1989→04/1994	B	
2.0 i	05/1989→06/1994	B	RFZ (XU10J2)
2.0 i	05/1989→04/1994	B	RDZ (XU10MZ)
2.0 i Turbo	09/1992→06/1994	B	RGY (XU10J2TE/Z)
2.0 Turbo	09/1992→04/1994	B	RGY (XU10J2TE/Z)
2.1 D 12V	05/1989→06/1994	D	P9A (XUD11A)
<b>XM II, Break</b>			
2.0 Turbo	05/1994→10/2000	B	RGX (XU10J2TE), RGY (XU10J2TE/Z)
2.1 D12	07/1994→06/1996	D	P9A (XUD11A)

MAGNETI MARELLI			
Short	Code		
<b>Model</b>			
Version		Fuel	Motor code
<b>XM II, Break</b>			
2.1 D12 VSX	03/1996→08/1996	D	P9A (XUD11A)
<b>XSARA, Break, Coupé, PICASSO</b>			
1.8 D	04/1997→09/2000	D	161A (XUD7), A9A (XUD7)
1.8 TD	10/1997→09/2000	D	
1.9 D	01/1998→09/2000	D	DHV (XUD9BSD)
1.9 D	04/1997→09/2000	D	DJY (XUD9A)
1.9 SD	01/1998→09/2000	D	DHV (XUD9BSD)
1.9 TD	04/1997→09/2000	D	DHY (XUD9TE/Y)
<b>ZX, Break</b>			
1.8 D	06/1993→10/1997	D	161A (XUD7)
1.9 D	03/1991→10/1997	D	DJZ (XUD9Y)
1.9 D	06/1994→10/1997	D	D9B (XUD9A/U)
1.9 TD	07/1992→10/1997	D	DHY (XUD9TE/Y)
2.0 i	07/1992→06/1997	B	RFX (XU10J2C)
<b>FIAT</b>			
<b>DUCATO III</b>			
1.9 D	04/1998→02/2011	D	D9B, DJY
1.9 TD	04/1998→02/2011	D	DHX (XUD9TF/L)
1.9 TD	05/1998→01/2011	D	
20	03/1994→02/2011	B	RFW
20	06/1994→12/1995	B	
2.0 4x4	11/1994→02/2011	B	RFW
2.0 Panorama/Combinato	03/1994→02/2011	B	RFW
<b>DUCATO IV</b>			
20	02/2011→	B	RFL
2.0 4x4	02/2011→06/2011	B	
2.0 Bipower	02/2011→	BF	
<b>SCUDO I</b>			
1.9 D	02/1996→04/1998	D	D9B
1.9 D	04/1998→	D	WJZ (DW8)
1.9 TD	02/1996→	D	D8B
1.9 TD	02/1996→	D	DHX (XUD9TF/L)
1.9 TD Eco	02/1996→	D	DHX (XUD9TF/L)
<b>ULYSSE I</b>			
1.9 TD	02/1995→02/2011	D	DHX (XUD9TF/L)
20	06/1994→02/2011	B	RFU (XU10J2C)
2.0 Turbo	06/1994→02/2011	B	RGX (XU10J2CTE)
<b>HONDA</b>			
<b>CONCERTO</b>			
1.8 TD	08/1994→10/1996	D	XUD7T
1.8 TD	08/1994→10/1996	D	XUD7T

MAGNETI MARELLI			
Short	Code		
<b>Model</b>			
Version		Fuel	Motor code
<b>81642</b>	<b>350981642000</b>		
<b>HYUNDAI</b>			
<b>LANTRA II, Station Wagon</b>			
1.9 D	03/1998→09/2000	D	
<b>LANCIA</b>			
<b>ZETA</b>			
2.0 Turbo	05/1995→02/2011	B	RGX
<b>PEUGEOT</b>			
<b>205 I, Van</b>			
1.7 Diesel	03/1994→	D	161A (XUD7)
<b>306, Break, Cabrio</b>			
1.8 D	05/1993→01/2011	D	A9A (XUD7)
1.9 D	03/1998→02/2011	D	DHV (XUD9BSD)
1.9 D	05/1993→01/2011	D	DJZ (XUD9Y)
1.9 D	06/1994→02/2011	D	DJY (XUD9A)
1.9 DT	05/1993→01/2011	D	DHY (XUD9TE)
1.9 SLD	06/1994→01/2011	D	DJY (XUD9A)
1.9 SLD	06/1994→01/2011	D	DJZ (XUD9Y)
1.9 SRDT	06/1994→01/2011	D	DHY (XUD9TE)
1.9 TD	02/1997→02/2011	D	DHY (XUD9TE)
20	03/1994→02/2011	B	RFX (XU10J2)
2.0 S16	05/1993→01/2011	B	RFY (XU10J4Z)
2.0 S16	06/1994→01/2011	B	RFT (XU10J4)
2.0 ST	07/1994→01/2011	B	RFX (XU10J2)
2.0 XSi	05/1993→01/2011	B	RFX (XU10J2)
<b>405 II, Break</b>			
20	08/1992→10/1996	B	RFX (XU10J2)
2.0 16V	06/1994→10/1995	B	RFT (XU10J4)
2.0 4x4	08/1992→10/1996	B	RFX (XU10J2)
2.0 MI-16	08/1992→10/1995	B	RFY (XU10J4Z)
2.0 T 16 X4	08/1992→10/1995	B	RGZ (XU10J4TE/Z)
2.0 X4	08/1992→10/1995	B	RFX (XU10J2)
<b>406, Break, Coupé</b>			
1.9 D	10/1996→04/2011	D	DHW (XUD9SD)
1.9 TD	01/1996→04/2011	D	DHX (XUD9TE)
1.9 TD	01/1996→04/2011	D	DHY (XUD9TE)
2.0 Turbo	04/1996→04/2011	B	RGX (XU10J2TE)
<b>605</b>			
20	02/1990→09/1999	B	
20	06/1989→09/1999	B	RFZ (XU10J2Z)
20	06/1989→09/1999	B	R5A (XU102C)
2.0 Turbo	07/1991→09/1999	B	RGX (XU10J2TE)
2.0 Turbo	07/1992→09/1999	B	RGY (XU10J2TE)
2.1 D	06/1989→07/1995	D	P9A (XUD11A)

MAGNETI MARELLI			
Short	Code		
<b>Model</b>			
Version		Fuel	Motor code
<b>806</b>			
1.9 TD	05/1997→02/2011	D	DHY (XUD9TE)
1.9 TD	07/1995→02/2011	D	DHX (XUD9TE)
20	06/1994→02/2011	B	RFU (XU10J2)
2.0 Turbo	06/1994→02/2011	B	RGX (XU10J2TE)
<b>BOXER I</b>			
1.9 D	03/1994→02/2011	D	D8C (XUD9AU)
1.9 D	07/1999→02/2011	D	DJY (XUD9A)
1.9 TD	03/1994→02/2011	D	D8C (XUD9UTF)
1.9 TD	08/1994→02/2011	D	DHY (XUD9TE), XUD9TE
1.9 TD 4x4	07/1996→02/2011	D	D8C (XUD9UTF)
20	01/2011→	B	
2.0 4x4	03/1996→09/1998	B	
2.0 i	03/1994→02/2011	B	RFW (XU10J2)
2.0 i 4x4	08/1996→02/2011	B	RFW (XU10J2)
<b>BOXER II</b>			
20	02/2011→	B	RFL (XU10J2U)
<b>EXPERT I</b>			
1.9 D	02/1996→	D	D9B (XUD9AU)
1.9 D	06/1998→03/2011	D	WJZ (DW8)
1.9 TD	02/1996→	D	D8B (XUD9TE)
1.9 TD	02/1996→	D	DHX (XUD9TE)
<b>EXPERT II, Tepee</b>			
1.9 D	06/1998→03/2011	D	
<b>PARTNER - Ranch, I</b>			
1.9 D	05/1996→12/1998	D	DJY (XUD9A)
1.9 D	05/1996→12/1998	D	DJY (XUD9A), XUD9
1.9 D	12/1998→	D	WJY (DW8B), WJZ (DW8)
<b>SUZUKI</b>			
<b>BALENO, Station Wagon</b>			
1.9 TD	04/1998→02/2011	D	
<b>SAMURAI</b>			
1.9 TD	11/1998→	D	XUD9
<b>VITARA, Cabrio</b>			
1.9 D	01/1995→03/1998	D	XUD9A
1.9 D	08/1996→03/1999	D	XUD9SD



Short **MAGNETI MARELLI** Code



Model

Version		Fuel	Motor code
---------	--	------	------------

81650 350981650000



**FLANGIA**  
 Numero Fori Flangia 3  
 Dimensione Fori Flangia M6x1  
 Posizione Flangia 69.7  
 Diametro Mozzo Ø23.5

**GIRANTE**  
 Diametro Girante Ø57  
 N° Alette Girante 8  
 Distanza Girante 12

**FORD**

**ESCORT V, Station Wagon, Cabrio, Van**

13 07/1990→09/1992 B J4B, J6A

**FIESTA III, Van**

10 03/1989→12/1995 B TLB

11 03/1989→12/1995 B GUD, GUE

11 03/1989→12/1995 B G6A

13 03/1989→12/1992 B JBC

**ORION III**

13 07/1990→12/1993 B J4B, J6A

81651 350981651000



**PULEGGIA**  
 Diametro Puleggia Ø50  
 Altezza Puleggia 23  
 Posizione Puleggia 38.5

**GIRANTE**  
 Diametro Girante Ø71.5  
 N° Alette Girante 9  
 Distanza Girante 12.5

**FORD**

**ESCORT V, Station Wagon, Cabrio, Van**

1.8 D 07/1990→12/1994 D RTE, RTF, RTH

**ESCORT VI, Station Wagon, Cabrio, Van**

1.8 D 09/1992→01/1995 D RTE, RTF, RTH

**ESCORT VII, Station Wagon, Cabrio, Van**

1.8 D 01/1995→02/1999 D RTE, RTF, RTH

**FIESTA II, Van**

1.8 D 03/1989→12/1995 D RTC, RTD, RTG

**FIESTA III, Van**

1.8 D 03/1989→02/1996 D RTC, RTD, RTG

**FIESTA IV, Van**

1.8 D 08/1995→04/2000 D RTJ, RTK

Short **MAGNETI MARELLI** Code



Model

Version		Fuel	Motor code
---------	--	------	------------

**FIESTA V, Van**

D 1.8 05/1998→ D RTJ, RTK

**ORION III**

1.8 D 11/1990→12/1993 D RTE, RTF, RTH

**MAZDA**

**121 III**

1.8 D 03/1996→ D RTJ, RTK

81653 350981653000



**FLANGIA**  
 Numero Fori Flangia 3  
 Dimensione Fori Flangia M6x1  
 Posizione Flangia 76.25  
 Diametro Mozzo Ø23.5

**GIRANTE**  
 Diametro Girante Ø57  
 N° Alette Girante 8  
 Distanza Girante 12

**FORD**

**ESCORT V, Station Wagon, Cabrio, Van**

13 07/1990→09/1992 B J4B, J6A

13 07/1990→12/1994 B JBD

**ESCORT VI, Station Wagon, Cabrio, Van**

13 09/1992→01/1995 B J4B, J6A

**ESCORT VII, Station Wagon, Cabrio, Van**

13 01/1995→02/1999 B J4B, J6A

**FIESTA III, Van**

10 03/1989→12/1995 B TLB

11 03/1989→12/1995 B GUD, GUE

11 03/1989→12/1995 B G6A

13 03/1989→02/1996 B J6B, JBC

1.3 Cat. 05/1991→01/1997 B J6B

**FIESTA IV, Van**

13 02/1996→ B J4C

**ORION III**

13 07/1990→12/1993 B J4B, J6A

Short **MAGNETI MARELLI** Code



Model

Version		Fuel	Motor code
---------	--	------	------------

81654 350981654000



<b>FLANGIA</b>	
Numero Fori Flangia	4
Dimensione Fori Flangia	M8x1.25
Posizione Flangia	102.6
Diametro Mozzo	Ø23.4
<b>GIRANTE</b>	
Diametro Girante	Ø65
N° Alette Girante	8
Distanza Girante	34.25

**FORD**

**ESCORT V, Station Wagon, Cabrio, Van**

RS 2000 05/1991→12/1992 B N7A

**SCORPIO I, Station Wagon**

20 03/1990→08/1992 B N8B  
 20 11/1988→03/1993 B N8A, N8B  
 2.0 i 04/1985→02/1992 B NRA, NRI  
 2.0 i 05/1989→09/1994 B N9D  
 2.0 i 05/1989→02/1992 B

**SCORPIO II, Station Wagon**

2.3 i 16V 06/1996→08/1998 B Y5A

**SIERRA II, Station Wagon**

20 01/1987→02/1993 B N8C, NES  
 2.0 4x4 02/1990→02/1993 B N9C  
 2.0 4x4 05/1989→02/1993 B N9C  
 2.0 i 01/1987→02/1993 B N4A, N4I  
 2.0 i 05/1989→02/1993 B N9C  
 2.0 i 05/1989→02/1993 B N9B, N9C

**TRANSIT VII**

23 01/2011→06/2011 B E5FC  
 23 08/2000→06/2011 B E5FA  
 2.3 16V 08/2000→06/2011 B E5FA

**TRANSIT VIII**

2.3 16V 06/2011→ B GZFA

Short **MAGNETI MARELLI** Code



Model

Version		Fuel	Motor code
---------	--	------	------------

81655 350981655000



<b>FLANGIA</b>	
Numero Fori Flangia	4
Dimensione Fori Flangia	M6x1
Posizione Flangia	82.85
Diametro Centraggio	Ø58
<b>GIRANTE</b>	
Diametro Girante	Ø82
N° Alette Girante	6
Distanza Girante	9.5

**FORD**

**ESCORT V, Station Wagon, Cabrio, Van**

1.8 16V 02/1992→12/1992 B RDA  
 1.8 16V XR3i 02/1992→12/1992 B RQB  
 1.8 16V XR3i 02/1992→12/1992 B RDA

**ESCORT VI, Station Wagon, Cabrio, Van**

1.6 16V XR3i 12/1992→01/1995 B L1E  
 1.6 i 16V 01/1994→01/1995 B L1H  
 1.6 i 16V 09/1992→01/1995 B L1E, L1K  
 1.8 16V XR3i 09/1992→01/1995 B RQB  
 1.8 16V XR3i 12/1992→01/1995 B RDA  
 1.8 i 16V 02/1993→01/1995 B RQB  
 1.8 i 16V 09/1992→01/1995 B RDA  
 1.8 XR3i 16V 4x4 08/1993→01/1995 B RQB  
 1.8 XR3i 16V 4x4 08/1993→01/1995 B RDA

**ESCORT VII, Station Wagon, Cabrio, Van**

1.6 16V 01/1995→02/1999 B L1E  
 1.6 16V 4x4 01/1995→10/1998 B L1E  
 1.6 16V XR3i 02/1995→12/1996 B L1H  
 1.6 16V XR3i 02/1995→09/1999 B L1E  
 1.6 i 16V 01/1995→08/1995 B L1H  
 1.6 i 16V 01/1995→02/1999 B L1E, L1K  
 1.8 16V 01/1995→08/1995 B RDA  
 1.8 16V 01/1995→02/1999 B RKC  
 1.8 16V XR3i 02/1995→08/1998 B RDA  
 1.8 16V XR3i 02/1995→08/2000 B RQB  
 1.8 16V XR3i 10/1995→08/1998 B RKC

**FIESTA III, Van**

1.6 i 16V 01/1994→12/1995 B L1G  
 1.8 16V 02/1992→12/1995 B RDB  
 1.8 XR2i 16V 02/1992→12/1995 B RQC

**ORION III**

1.6 i 16V 07/1992→12/1993 B L1E, L1K  
 1.8 i 16V 01/1992→12/1993 B RQB  
 1.8 i 16V 02/1992→12/1993 B RDA

Short **MAGNETI MARELLI** Code



Model

Version		Fuel	Motor code
---------	--	------	------------

81656 350981656000



**PULEGGIA**  
 Diametro Puleggia Ø50  
 Altezza Puleggia 23  
 Posizione Puleggia 64.5  
**GIRANTE**  
 Diametro Girante Ø79  
 N° Alette Girante 9  
 Distanza Girante 11.5

FORD

**MONDEO I, Station Wagon**

1.8 TD	06/1993→08/1996	D	RFM, RFN
1.8 TD	10/1995→08/1996	D	RFM, RFN

**MONDEO II, Station Wagon**

1.8 TD	09/1996→11/2000	D	RFN
--------	-----------------	---	-----

81657 350981657000



**PULEGGIA**  
 Diametro Puleggia Ø50  
 Altezza Puleggia 23  
 Posizione Puleggia 64.5  
**GIRANTE**  
 Diametro Girante Ø79  
 N° Alette Girante 9  
 Distanza Girante 11.5

FORD

**ESCORT VI, Station Wagon, Cabrio, Van**

1.8 TD	02/1993→01/1995	D	RFD, RFK, RFS
--------	-----------------	---	---------------

**ESCORT VII, Station Wagon, Cabrio, Van**

1.8 TD	01/1995→02/1999	D	RFD, RFK
1.8 Turbo D	12/1995→01/2011	D	RVA

**ESCORT VIII, Station Wagon**

1.8 TD	10/1998→07/2000	D	RFD, RFK
--------	-----------------	---	----------

**FIESTA III, Van**

1.8 TD	03/1993→12/1995	D	RFL
--------	-----------------	---	-----

**ORION III**

1.8 TD	03/1992→12/1993	D	RFD, RFK
--------	-----------------	---	----------

Short **MAGNETI MARELLI** Code



Model

Version		Fuel	Motor code
---------	--	------	------------

81658 350981658000



**FLANGIA**  
 Numero Fori Flangia 3  
 Dimensione Fori Flangia M8x1.25  
 Posizione Flangia 69  
 Diametro Mozzo Ø23.5  
**GIRANTE**  
 Diametro Girante Ø65  
 N° Alette Girante 8  
 Distanza Girante 34.25

FORD

**ESCORT V, Station Wagon, Cabrio, Van**

RS 2000	05/1991→12/1992	B	N7A
---------	-----------------	---	-----

**ESCORT VI, Station Wagon, Cabrio, Van**

RS 2000	09/1992→01/1995	B	N7A
---------	-----------------	---	-----

**ESCORT VII, Station Wagon, Cabrio, Van**

RS 2000 4x4	08/1993→01/1995	B	N7A
-------------	-----------------	---	-----

**ESCORT VIII, Station Wagon, Cabrio, Van**

RS Cosworth 4x4	09/1992→01/1995	B	N5F
-----------------	-----------------	---	-----

**ESCORT VII, Station Wagon, Cabrio, Van**

RS 2000	02/1995→02/1998	B	N7A
---------	-----------------	---	-----

**ESCORT VII, Station Wagon, Cabrio, Van**

RS 2000 4x4	02/1995→10/1998	B	N7A
-------------	-----------------	---	-----

**ESCORT VII, Station Wagon, Cabrio, Van**

RS Cosworth 4x4	02/1995→10/1998	B	N5F
-----------------	-----------------	---	-----

**GALAXY I**

2.0 i	11/1995→06/2011	B	NSE, ZVSA
-------	-----------------	---	-----------

2.3 16V	01/1997→06/2011	B	E5SA, Y5B
---------	-----------------	---	-----------

2.3 16V	01/2011→06/2011	B	E5SB
---------	-----------------	---	------

2.3 4x4	09/1996→04/2000	B	Y5B
---------	-----------------	---	-----

**SCORPIO I, Station Wagon**

20	03/1990→08/1992	B	N8B
----	-----------------	---	-----

20	11/1988→03/1993	B	N8A, N8B
----	-----------------	---	----------

2.0 i	04/1985→09/1994	B	NRA, NRI
-------	-----------------	---	----------

2.0 i	05/1989→02/1992	B	
-------	-----------------	---	--

2.0 i	05/1989→09/1994	B	N9D
-------	-----------------	---	-----

2.0 i	09/1991→09/1994	B	N9F
-------	-----------------	---	-----

**SCORPIO II, Station Wagon**

2.0 i	10/1994→08/1998	B	NSD
-------	-----------------	---	-----

2.0 i 16V	10/1994→08/1998	B	N3A
-----------	-----------------	---	-----

**SIERRA II, Station Wagon**

20	01/1987→02/1993	B	N8C, NES
----	-----------------	---	----------

2.0 4x4	02/1990→02/1993	B	N9C
---------	-----------------	---	-----

2.0 4x4	05/1989→02/1993	B	N9C
---------	-----------------	---	-----

2.0 i	01/1987→02/1993	B	N4A, N4I
-------	-----------------	---	----------

2.0 i	05/1989→02/1993	B	N9B, N9C
-------	-----------------	---	----------

2.0 i	05/1989→02/1993	B	N9C
-------	-----------------	---	-----

2.0 i DOHC	12/1991→02/1993	B	N9E
------------	-----------------	---	-----

Short	Code
-------	------



Model

Version		Fuel	Motor code
---------	--	------	------------

81659		350981659000	
-------	--	--------------	--



**GIRANTE**  
 Diametro Alberino M14x1.5  
 Tipo Filetto Alberino Maschio  
 Lunghezza Alberino 90

**GIRANTE**  
 Diametro Girante Ø64  
 N° Alette Girante 6  
 Distanza Girante 26

**FORD**

**SCORPIO I, Station Wagon**

2.5 TD	06/1988→07/1993	D	SFA, SFB
--------	-----------------	---	----------

**SIERRA II, Station Wagon**

2.3 D	01/1987→02/1993	D	YTR, YTT
-------	-----------------	---	----------

**PEUGEOT**

**505, Break**

2.5 Turbo Diesel	10/1983→12/1993	D	152A (XD3T)
------------------	-----------------	---	-------------

2.5 Turbo Diesel	10/1986→12/1993	D	152B (XD3TE)
------------------	-----------------	---	--------------

81660		350981660000	
-------	--	--------------	--



**FLANGIA**  
 Numero Fori Flangia 3  
 Dimensione Fori Flangia M7x1  
 Posizione Flangia 113

**GIRANTE**  
 Diametro Girante Ø73  
 N° Alette Girante 8  
 Distanza Girante -0.5

**RENAULT**

**4, Van**

10	06/1987→12/1993	B	C1C708
----	-----------------	---	--------

10	12/1985→06/1993	B	689710
----	-----------------	---	--------

Short	Code
-------	------



Model

Version		Fuel	Motor code
---------	--	------	------------

81661		350981661000	
-------	--	--------------	--



**PULEGGIA**  
 Diametro Puleggia Ø59.26  
 Numero Denti/Gole Puleggia 20  
 Altezza Puleggia 20.8  
 Posizione Puleggia 46.1

**GIRANTE**  
 Diametro Girante Ø60  
 N° Alette Girante 6  
 Distanza Girante 19.5

**RENAULT**

**19 I, CHAMADE, Van, Cabrio**

14	01/1988→12/1992	B	E6J700, E6J701
----	-----------------	---	----------------

14	09/1990→04/1992	B	E7J700
----	-----------------	---	--------

**19 II, CHAMADE, Van, Cabrio**

12	03/1992→12/1995	B	C1G730
----	-----------------	---	--------

12	05/1992→09/1994	B	E7F730
----	-----------------	---	--------

14	01/1992→12/1995	B	E7J742
----	-----------------	---	--------

14	01/1992→12/1995	B	E6J700, E7J706
----	-----------------	---	----------------

**CLIO I, Van**

12	01/1991→09/1998	B	E7F706
----	-----------------	---	--------

12	05/1990→09/1998	B	E5F710, E7F750
----	-----------------	---	----------------

12	05/1990→09/1998	B	E7F700, E7F708, E7F750
----	-----------------	---	------------------------

14	01/1991→09/1998	B	E7J710
----	-----------------	---	--------

14	01/1991→09/1998	B	E7J718, E7J719, E7J754
----	-----------------	---	------------------------

14	01/1991→09/1998	B	E7J756, E7J757
----	-----------------	---	----------------

**RAPID, Express**

14	01/1994→03/1998	B	E7J728
----	-----------------	---	--------

14	09/1991→03/1998	B	E7J720, E7J724, E7J726, E7J773
----	-----------------	---	--------------------------------

**THALIA**

12	02/1998→03/2011	B	D7F744, D7F746
----	-----------------	---	----------------

81664		350981664000	
-------	--	--------------	--



**FLANGIA**  
 Numero Fori Flangia 4  
 Dimensione Fori Flangia M8x1.25  
 Posizione Flangia 90  
 Diametro Mozzo Ø23.8

**GIRANTE**  
 Diametro Girante Ø69  
 N° Alette Girante 9  
 Distanza Girante 17.3

**RENAULT**

**TRAFIC I**

2.1 D	03/1980→06/1994	D	852720, 852750
-------	-----------------	---	----------------



**Model**

Version		Fuel	Motor code
---------	--	------	------------

81666 350981666000



**FLANGIA**

Numero Fori Flangia	3
Dimensione Fori Flangia	M8x1.25
Posizione Flangia	71
Diametro Centraggio	Ø51

**GIRANTE**

Diametro Girante	Ø68
N° Alette Girante	8
Distanza Girante	17.3

**RENAULT**

**21, Station Wagon, Van**

20	02/1990→06/1994	B	J7R740
20	03/1986→10/1993	B	J6R758, J6R759, J6R792, J6R793
20	03/1986→12/1993	B	J7R746, J7R747
20	05/1991→10/1993	B	
2.0 4x4	03/1989→12/1993	B	J7R746, J7R747
2.0 4x4	12/1989→02/1994	B	J7R740
22	06/1986→06/1994	B	J7T754, J7T755
2.2 4x4	06/1986→06/1994	B	J7T754, J7T755

**25**

20	03/1987→12/1993	B	J7R722
2.0 12V	06/1988→12/1993	B	J7R720
2.0 12V	06/1989→12/1992	B	J7R726
22	09/1986→12/1992	B	J7T708, J7T732, J7T733

**ESPACE II**

20	01/1991→10/1996	B	J7R768
22	01/1991→10/1996	B	J7T772, J7T773, J7T776
2.2 4x4	03/1991→12/1996	B	J7T772, J7T773

**MASTER I**

10991	08/1980→07/1998	B	J7T782, J7T788
-------	-----------------	---	----------------

**TRAFIC I**

22	06/1994→10/1997	B	J7T600
----	-----------------	---	--------



**Model**

Version		Fuel	Motor code
---------	--	------	------------

81667 350981667000



**FLANGIA**

Numero Fori Flangia	3
Dimensione Fori Flangia	M8x1.25
Posizione Flangia	67.4
Diametro Mozzo	Ø29.9

**GIRANTE**

Diametro Girante	Ø69
N° Alette Girante	9
Distanza Girante	17.3

**RENAULT**

**ESPACE II**

2.1 RTDT Quadra	01/1991→05/1992	D	J8S772
2.1 TD	01/1991→10/1996	D	J8S610, J8S772, J8S776, J8S778
2.1 TD	11/1994→10/1996	D	J8S612

81672 350981672000



**GIRANTE**

Diametro Alberino	M14x1.5
Tipo Filetto Alberino	Maschio
Lunghezza Alberino	134

**GIRANTE**

Diametro Girante	Ø56
N° Alette Girante	6
Distanza Girante	12

**CITROËN**

**BX, Break**

1.8 D	10/1985→09/1993	D	161 (XUD7)
1.9 DT TXD	02/1992→12/1994	D	
1.9 RD 4x4	01/1987→01/1992	D	
18 D	10/1985→09/1993	D	161A (XUD7)
19 D	03/1987→12/1994	D	D9B (XUD9A/U)
TRD Turbo	03/1988→12/1994	D	A8A (XUD7TE), AJZ (XUD7TE)

**C 15, Station Wagon**

1.8 D	07/1986→12/2000	D	161A (XUD7)
-------	-----------------	---	-------------

**XANTIA I, Break**

1.9 D	06/1994→01/1998	D	DJZ (XUD9Y)
1.9 D	06/1994→01/1998	D	D9B (XUD9A/L)
1.9 SD	02/1996→01/1998	D	DHW (XUD9SD)
1.9 Turbo D	10/1994→01/1998	D	D8B (XUD9TF), DHX (XUD9TF/BTF), DHY (XUD9TE/Y)

**ZX, Break**

1.9 D	03/1991→10/1997	D	DJZ (XUD9Y)
1.9 TD	07/1992→10/1997	D	DHY (XUD9TE/Y)

MAGNETI MARELLI			
Short	Code		
<b>Model</b>			
Version		Fuel	Motor code
81672	350981672000		
<b>CITROËN</b>			
<b>ZX, Break</b>			
2.0 i 16V	05/1996→06/1997	B	RFS (XU10J4RS)
2.0 i 16V	06/1994→06/1997	B	RFT (XU10J4/Z)
2.0 i 16V	07/1992→10/1994	B	RFT (XU10J4/Z), RFY (XU10J4/Z)
<b>FIAT</b>			
<b>ULYSSE I</b>			
1.9 TD	02/1995→02/2011	D	DHX (XUD9TF/L)
<b>LADA</b>			
<b>NIVA I</b>			
1900 Diesel	01/1993→	D	XUD9A
1900 Diesel	01/1999→	D	XUD9SD
<b>PEUGEOT</b>			
<b>205 II, Van</b>			
1.7 Diesel	07/1987→09/1998	D	161A (XUD7)
1.7 TD	01/1990→09/1998	D	A8B (XUD7TE)
19	08/1987→06/1994	D	XUD9
1.9 Diesel	10/1987→09/1998	D	DJZ (XUD9Y)
<b>306, Break, Cabrio</b>			
1.8 D	05/1993→01/2011	D	A9A (XUD7)
1.9 D	03/1998→02/2011	D	DHV (XUD9BSD)
1.9 D	05/1993→01/2011	D	DJZ (XUD9Y)
1.9 D	06/1994→02/2011	D	DJY (XUD9A)
1.9 DT	05/1993→01/2011	D	DHY (XUD9TE)
1.9 SLD	06/1994→01/2011	D	DJY (XUD9A)
1.9 SLD	06/1994→01/2011	D	DJZ (XUD9Y)
1.9 SRDT	06/1994→01/2011	D	DHY (XUD9TE)
1.9 TD	02/1997→02/2011	D	DHY (XUD9TE)
<b>309 II</b>			
1.8 Diesel	07/1989→12/1993	D	161A (XUD7)
1.8 TD	08/1989→12/1993	D	A8B (XUD7TE)
1.9 Diesel	07/1989→12/1993	D	162 (XUD9), D9A (XUD9), DJZ (XUD9Y)
<b>405 I, Break</b>			
1.8 D 4x4	10/1987→07/1992	D	A8A (XUD7TE)
1.8 GLD	04/1990→07/1992	D	
1.8 TD	10/1988→08/1992	D	A8A (XUD7TE), AJZ (XUD7TEY)
1.8 Turbo Diesel	03/1988→12/1992	D	A8A (XUD7TE), AJZ (XUD7TEY)
1.9 D	10/1988→08/1992	D	D9B (XUD9A), DJY (XUD9A)
1.9 D	10/1988→08/1992	D	DJZ (XUD9Y)
1.9 Diesel	03/1988→12/1992	D	D9B (XUD9A)
1.9 Diesel	07/1988→09/1992	D	DJZ (XUD9Y)
<b>J5 II</b>			
1.9 D	10/1990→	D	D9B (XUD9A)

MAGNETI MARELLI			
Short	Code		
<b>Model</b>			
Version		Fuel	Motor code
<b>ROVER</b>			
<b>200 II, Coupé</b>			
218 D	09/1991→10/1995	D	
218 TD	09/1991→10/1995	D	XUD7TE
<b>400 I</b>			
1.8 TD	09/1993→11/1998	D	XUD7TE
418 D	09/1991→04/1995	D	
418 TD	09/1991→04/1995	D	XUD7TE

81680		350981680000	
<b>PULEGGIA</b>		Diametro Puleggia	Ø62.3
		Numero Denti/Gole Puleggia	21
		Altezza Puleggia	26
		Posizione Puleggia	65.5
<b>GIRANTE</b>		Diametro Girante	Ø65
		N° Alette Girante	8
		Distanza Girante	29

<b>OPEL</b>			
<b>ASTRA F, Station Wagon, Cabrio</b>			
2.0 GSI 16V	09/1991→01/1998	B	C20XE
<b>ASTRA G, Station Wagon, Cabrio</b>			
2.0 16V	09/1998→05/2011	B	X20XEV
<b>CALIBRA</b>			
2.0 i 16V	06/1990→02/1994	B	C20XE
2.0 i 16V 4x4	06/1990→02/1994	B	C20XE
2.0 i Turbo 4x4	03/1992→07/1997	B	C20LET
<b>VECTRA A</b>			
2.0 i 16V	06/1994→11/1995	B	X20XEV
2.0 i 16V 4x4	06/1994→11/1995	B	X20XEV
2.0 i 16V Cat.	02/1990→11/1995	B	C20XE
2.0 i Turbo 4x4	06/1994→11/1995	B	C20LET
2000/GT 16V	01/1989→06/1994	B	20XEJ
2000/GT 16V 4x4 Cat.	02/1990→11/1995	B	C20XE
2000/GT 16V Cat.	02/1990→11/1995	B	C20XE



**Model**

Version	Fuel	Motor code
---------	------	------------

81681 350981681000



**PULEGGIA**  
 Diametro Puleggia Ø56.3  
 Numero Denti/Gole Puleggia 19  
 Altezza Puleggia 20  
 Posizione Puleggia 36.3

**GIRANTE**  
 Diametro Girante Ø55  
 N° Alette Girante 9  
 Distanza Girante 35

**OPEL**

**CORSA A, Van**

1.4 i	10/1989→03/1993	B	C14NZ
1.4 S	09/1989→03/1993	B	14NV
1.6 GSI	05/1988→03/1992	B	E16SE
1.6 GSI	08/1988→09/1992	B	C16NZ
1.6 GSI	09/1989→03/1993	B	C16SEI

**KADETT E, Station Wagon, Van**

1.4 i	01/1990→07/1994	B	C14NZ
1.6 i	07/1989→02/1993	B	16SV
1.6 i	09/1986→07/1994	B	C16NZ, E16NZ
1.6 i Cat.	09/1986→02/1993	B	C16LZ, C16NZ

**VECTRA A**

1.4 S	04/1988→06/1992	B	14NV
16	09/1988→05/1993	B	16SV
1.6 i	09/1988→11/1995	B	16LZ2, E16NZ
1.6 i	09/1993→11/1995	B	X16SZ
1.6 i Cat.	09/1988→11/1995	B	C16NZ, C16NZ2
1.6 S	09/1988→05/1993	B	16SV

81682 350981682000



**PULEGGIA**  
 Diametro Puleggia Ø110  
 Numero Denti/Gole Puleggia 1  
 Posizione Puleggia 53

**GIRANTE**  
 Diametro Girante Ø82  
 N° Alette Girante 12  
 Distanza Girante 14.5

**OPEL**

**FRONTERA A**

2.3 TD	03/1992→10/1998	D	23DTR
2.4 i	03/1992→10/1998	B	C24NE



**Model**

Version	Fuel	Motor code
---------	------	------------

**OMEGA A, Station Wagon**

2.3 D	09/1986→03/1994	D	23YD
2.3 TD Interc.	08/1988→03/1994	D	23DTR
2.4 i	09/1988→03/1994	B	C24NE
30	03/1987→03/1994	B	30NE, C30NE
30	03/1987→03/1994	B	C30LE
3.0 Cat.	03/1987→03/1994	B	C30NE

**SENATOR B**

2.5 i	09/1990→09/1993	B	25NE
30	09/1987→09/1993	B	C30LE
3.0 i Cat.	01/1988→09/1993	B	C30NE

81683 350981683000



**PULEGGIA**  
 Diametro Puleggia Ø72.5  
 Numero Denti/Gole Puleggia 29  
 Altezza Puleggia 24.5  
 Posizione Puleggia 57

**GIRANTE**  
 Diametro Girante Ø72  
 N° Alette Girante 7  
 Distanza Girante 33

**AUDI**

**Coupé II**

23	03/1990→12/1996	B	NG
23	10/1988→07/1994	B	NG
2.3 20V quattro	05/1990→12/1996	B	0,292
2.3 quattro	05/1990→12/1996	B	NG
2.3 quattro	11/1988→12/1992	B	NG

81684 350981684000



**FLANGIA**  
 Numero Fori Flangia 4  
 Dimensione Fori Flangia M6x1  
 Posizione Flangia 70  
 Diametro Mozzo Ø32

**GIRANTE**  
 Diametro Girante Ø65  
 N° Alette Girante 6  
 Distanza Girante 5.7

**OPEL**

**CORSA A, Van**

1.5 D	06/1987→03/1993	D	15D (4EC1)
1.5 TD	10/1987→03/1993	D	15DT (T4EC1)

Short Code



Model

Version		Fuel	Motor code
---------	--	------	------------

81685 350981685000



**FLANGIA**  
 Numero Fori Flangia 4  
 Dimensione Fori Flangia M6x1  
 Posizione Flangia 70  
 Diametro Mozzo Ø32

**GIRANTE**  
 Diametro Girante Ø65  
 N° Alette Girante 6  
 Distanza Girante 5.8

OPEL

CORSA A, Van

1.5 D	09/1987→03/1993	D	15D (4EC1)
1.5 TD	10/1987→03/1993	D	15DT (T4EC1)

CORSA B, Station Wagon, Van

1.5 D	03/1993→09/2000	D	15D (4EC1)
1.5 TD	03/1993→09/2000	D	15DT (T4EC1), X15DT (T4EC1)

VAUXHALL

CORSA

1.5 D	03/1993→09/2000	D	15D
1.5 TD	03/1993→10/1996	D	15DT (T4EC1), X15DT (T4EC1)

81687 350981687000



**FLANGIA**  
 Numero Fori Flangia 4  
 Dimensione Fori Flangia M6x1  
 Posizione Flangia 70  
 Diametro Mozzo Ø32

**GIRANTE**  
 Diametro Girante Ø70  
 N° Alette Girante 6  
 Distanza Girante 7

OPEL

ASTRA F, Station Wagon, Cabrio

1.7 TDS	12/1991→09/1998	D	17DT (TC4EE1), X17DT (TC4EE1)
---------	-----------------	---	-------------------------------

ASTRA G, Station Wagon, Cabrio

1.7 TD	09/1998→08/2000	D	X17DTL
--------	-----------------	---	--------

COMBO I

1.7 D	07/1994→01/2011	D	17D (4EE1), X17D (4EE1)
-------	-----------------	---	-------------------------

CORSA A, Van

1.5 D	06/1987→03/1993	D	15D (4EC1)
1.5 TD	10/1987→03/1993	D	15DT (T4EC1)

CORSA B, Station Wagon, Van

1.7 D	02/1996→09/2000	D	17D (4EE1), X17D (4EE1)
-------	-----------------	---	-------------------------

Short Code



Model

Version		Fuel	Motor code
---------	--	------	------------

VECTRA A

1.7 TD	03/1990→11/1995	D	17DT (TC4EE1), X17DT (TC4EE1)
--------	-----------------	---	-------------------------------

VAUXHALL

CORSA

1.7 DI 16V	09/2000→	D	Y17DTL
1.7 DTI 16V	09/2000→	D	Y17DT

81700 350981700000



**PULEGGIA**  
 Diametro Puleggia Ø72.5  
 Posizione Puleggia 56.7

**GIRANTE**  
 Diametro Girante Ø71.5  
 N° Alette Girante 7  
 Distanza Girante 32.6

AUDI

100 IV, Avant

2.3 E	12/1990→06/1994	B	AAR
2.3 E quattro	12/1990→06/1994	B	AAR
S4 Turbo quattro	08/1991→06/1994	B	AAN

80 IV, Avant

2.3 E	09/1991→01/1996	B	NG
2.3 E quattro	09/1991→12/1994	B	NG
RS2 quattro	03/1994→05/1995	B	ADU
S2 quattro	02/1993→07/1995	B	ABY

A6 I, Avant

23	06/1994→12/1995	B	AAR
2.3 quattro	06/1994→12/1995	B	AAR
S6 Turbo quattro	06/1994→12/1997	B	AAN

Cabrio

2.3 E	05/1991→07/1994	B	NG
-------	-----------------	---	----

Coupé II

23	03/1990→12/1996	B	NG
23	10/1988→07/1994	B	NG
2.3 20V quattro	05/1990→12/1996	B	0,292
2.3 quattro	05/1990→12/1996	B	NG
2.3 quattro	11/1988→12/1992	B	NG
S2 quattro	09/1990→09/1992	B	3B
S2 quattro	10/1992→12/1996	B	ABY





**Model**

Version		Fuel	Motor code
---------	--	------	------------

**81701**      **350981701000**



**PULEGGIA**  
 Diametro Puleggia      Ø59.2  
 Numero Denti/Gole Puleggia      20  
 Altezza Puleggia      27.4  
 Posizione Puleggia      56.45

**GIRANTE**  
 Diametro Girante      Ø71.5  
 N° Alette Girante      7  
 Distanza Girante      32.6

**AUDI**

**100 IV, Avant**

2.4 D	12/1990→06/1994	D	AAS
2.5 TDi	08/1993→07/1994	D	AAT
2.5 TDI	12/1990→06/1994	D	AAT, ABP

**A6 I, Avant**

2.5 TDI	01/1995→12/1997	D	AAT
2.5 TDI	06/1994→12/1997	D	AAT
2.5 TDI	08/1994→12/1997	D	AEL
2.5 TDI quattro	07/1995→12/1997	D	AEL

**VOLKSWAGEN**

**LT I**

2.4 TD	06/1992→06/1996	D	ACL
--------	-----------------	---	-----

**LT II**

2.5 SDI	07/1996→06/2011	D	AGX
2.5 TDI	01/2011→06/2011	D	BBF
2.5 TDI	01/2011→06/2011	D	BBE
2.5 TDI	05/1996→08/1999	D	AHD
2.5 TDI	05/1999→06/2011	D	APA
2.5 TDI	05/1999→06/2011	D	ANJ, AVR

**TRANSPORTER IV**

2.4 D	07/1990→04/1998	D	AAB
2.4 D	08/1997→03/2011	D	AJA
2.4 D Syncro	10/1992→09/1998	D	AAB
25	08/1996→03/2011	B	AET, APL, AVT
25	11/1990→03/2011	B	AAF, ACU, AEN, AEU
2.5 Syncro	07/1996→03/2011	B	AET, APL, AVT
2.5 Syncro	10/1992→03/2011	B	AAF, ACU, AEN, AEU
2.5 TDI	05/1998→03/2011	D	AJT, AYY
2.5 TDI	05/1998→03/2011	D	AHY, AXG
2.5 TDI	09/1995→03/2011	D	ACV, AUF, AXL, AYC
2.5 TDI Syncro	09/1995→03/2011	D	ACV, AXL

**VOLVO**

**850, Station Wagon**

2.5 TDI	08/1995→12/1996	D	D5252T
---------	-----------------	---	--------



**Model**

Version		Fuel	Motor code
---------	--	------	------------

**940 I, Station Wagon**

2.4 TD Intercooler	08/1990→12/1994	D	D24TIC
--------------------	-----------------	---	--------

**940 II, Station Wagon**

2.4 TD Interc.	08/1994→10/1998	D	D24TIC
----------------	-----------------	---	--------

**960 I, Station Wagon**

2.4 TD Interc.	09/1991→07/1994	D	D24TIC
----------------	-----------------	---	--------

**S70**

2.5 TDI	01/1997→11/2000	D	D5252T
---------	-----------------	---	--------

**S80 I**

2.5 TDI	01/1999→06/2011	D	D5252T
---------	-----------------	---	--------

**V70 I Station Wagon**

2.5 TDI	01/1997→05/2000	D	D5252T
---------	-----------------	---	--------

**81702**      **350981702000**



**PULEGGIA**  
 Diametro Puleggia      Ø57.19  
 Numero Denti/Gole Puleggia      23  
 Altezza Puleggia      26.5  
 Posizione Puleggia      45.7

**GIRANTE**  
 Diametro Girante      Ø59.8  
 N° Alette Girante      8  
 Distanza Girante      48

**AUDI**

**A3 I**

16	08/2000→	B	AVU, BFQ
16	09/1996→08/2000	B	AEH, AKL, APF

**A3 II, Sportback, Cabriolét**

16	03/2011→	B	BGU, BSE
16	08/2011→	B	
1.8 T	06/2011→	B	BPU
2.0 FSI	03/2011→	B	AXW, BLR, BLX, BLY, BMB, BVY, BVZ

**A4 I, Avant**

16	01/1995→07/2000	B	ADP, AHL, ANA, ARM
16	07/2000→01/2011	B	ALZ

**A4 II, Avant**

16	11/2000→04/2011	B	ALZ
20	11/2000→05/2011	B	ALT
2.0 FSI	02/2011→04/2011	B	AWA

**A4 III, Avant**



16	04/2011→	B	ALZ
20	04/2011→	B	ALT
2.0 GL	05/2011→05/2011	B	AWA

**A6 II, Avant**



18	07/1997→05/2011	B	AJP, ANQ, AQE, ARH
----	-----------------	---	--------------------



MAGNETI MARELLI			
Short	Code		
<b>Model</b>			
Version		Fuel	Motor code
81702	350981702000		
<b>AUDI</b>			
<b>A6 II, Avant</b>			
20	01/2011→05/2011	B	ALT
<b>SEAT</b>			
<b>ALTEA, ALTEA XL</b>			
16	04/2011→	B	BGU, BSE, BSF
1.6 LPG	09/2011→		CHGA
1.6 Multifuel	06/2011→	FF	CCSA
2.0 FSI	04/2011→09/2011	B	BLR, BLY, BVY, BVZ
<b>CORDOBA II, Vario</b>			
16	06/1999→02/2011	B	AEH, AKL, APF, AUR
<b>EXEO, EXEO ST</b>			
16	09/2011→	B	ALZ
1.8 T	08/2011→	B	CFMA
<b>IBIZA III</b>			
16	08/1999→02/2011	B	AEH, AKL, APF, AUR
<b>LEON I</b>			
16	05/2011→06/2011	B	BFQ
16	11/1999→06/2011	B	AEH, AKL
<b>LEON II</b>			
16	05/2011→	B	BSE, BSF
1.6 16V	05/2011→	B	
1.6 LPG	09/2011→	BF	CHGA
2.0 FSI	05/2011→	B	BLR, BLY, BVY, BVZ
<b>TOLEDO II</b>			
16	04/1999→09/2000	B	AEH, AKL
<b>TOLEDO III</b>			
16	04/2011→09/2011	B	BGU, BSE, BSF
2.0 FSI	04/2011→	B	BLR, BLY
<b>SKODA</b>			
<b>OCTAVIA I, Station Wagon</b>			
16	02/1997→	B	AEH, AKL
16	07/1998→	B	AEH, AKL
16	09/2000→	B	AVU, BFQ
<b>OCTAVIA II, Station Wagon</b>			
16	04/2011→	B	BGU
1.6 GreenLine	08/2011→	FF	CCSA
1.6 LPG	09/2011→		CHGA
2.0 FSI	04/2011→05/2011	B	BLR, BLY
2.0 FSI 4x4	04/2011→	B	BLX
<b>VOLKSWAGEN</b>			
<b>BORA, Station Wagon</b>			
16	02/2011→04/2011	B	AWB
16	08/2000→05/2011	B	AVU, BFQ, BJH

MAGNETI MARELLI			
Short	Code		
<b>Model</b>			
Version		Fuel	Motor code
<b>BORA, Station Wagon</b>			
16	10/1998→05/2011	B	AEH, AKL, APF
<b>CADDY III</b>			
16	05/2011→	B	BRV
16	04/2011→	B	BGU
<b>EOS</b>			
2.0 FSI	06/2011→	B	BVY
<b>GOLF IV, Cabrio, Variant</b>			
16	01/2011→01/2011	B	BAH
16	08/2000→06/2011	B	AVU, BFQ, BJH
16	08/1997→02/2000	B	AEH, AKL, APF
16	12/1998→02/2011	B	
<b>GOLF V, Plus, Variant</b>			
16	04/2011→	B	BGU, BSE, BSF
16	05/2011→	B	
1.6 BiFuel	09/2011→	BF	CHGA
1.6 Multifuel	07/2011→	FF	CCSA
2.0 FSI	04/2011→	B	AXW, BLR, BLX, BLY, BVX, BVY, BVZ
2.0 FSI 4motion	04/2011→	B	BLX, BLY, BVX, BVY, BVZ
<b>GOLF VI, Variant</b>			
16	08/2011→	B	BSE, BSF, CCSA
1.6 BiFuel	09/2011→	BF	CHGA
1.6 MultiFuel	08/2011→	FF	CCSA
<b>JETTA III</b>			
16	05/2011→	B	BSE, BSF
1.6 MultiFuel	08/2011→	FF	CCSA
2.0 FSI	05/2011→	B	BLR, BLY, BVY, BVZ
<b>NEW BEETLE, Cabrio</b>			
16	06/2000→	B	AYD, BFS
16	10/1999→09/2000	B	AWH
<b>PASSAT IV, Variant</b>			
16	10/1996→11/2000	B	ADP, AHL, ANA, ARM
1.8 T	10/1996→11/2000	B	AEB, ANB, APU
<b>PASSAT V, Variant</b>			
16	11/2000→05/2011	B	ALZ
20	01/2011→05/2011	B	ALT
<b>PASSAT VI, Variant, CC</b>			
16	05/2011→	B	BSE, BSF
2.0 FSI	05/2011→	B	BLR, BLY
2.0 FSI 4motion	05/2011→	B	BLX, BLY, BVX
<b>POLO III, Classic, Variant, Van</b>			
16	05/1997→01/2011	B	AEH, AFT, AKL, APF, AUR
100 1.6	12/1995→01/2011	B	AEH, AFT, AKL, APF, AUR
<b>TOURAN</b>			
16	03/2011→	B	BGU, BSE, BSF

MAGNETI MARELLI			
Short	Code		
			
<b>Model</b>			
Version		Fuel	Motor code
81702	350981702000		
<b>VOLKSWAGEN</b>			
<b>TOURAN</b>			
2.0 FSI	03/2011→	B	AXW, BLR, BLX, BLY
2.0 FSI	04/2011→	B	BJZ

MAGNETI MARELLI			
Short	Code		
			
<b>Model</b>			
Version		Fuel	Motor code
81703	350981703000		
			
<b>PULEGGIA</b>			
Diametro Puleggia		Ø57.19	
Numero Denti/Gole Puleggia		23	
Altezza Puleggia		26.5	
Posizione Puleggia		45.7	
<b>GIRANTE</b>			
Diametro Girante		Ø60.1	
N° Alette Girante		8	
Distanza Girante		48	

MAGNETI MARELLI			
Short	Code		
			
<b>Model</b>			
Version		Fuel	Motor code
<b>AUDI</b>			
<b>A3 I</b>			
18	09/1996→	B	AGN, APG
1.8 quattro	08/1998→	B	AGN
1.8 T	12/1996→	B	AGU, AQA, ARZ, AUM
1.8 T	12/1998→	B	AJQ, APP, ARY, AUQ
1.8 T quattro	10/1998→	B	AJQ, ARY
1.8 T quattro	12/1996→	B	AGU, AQA, ARX
S3 quattro	03/1999→	B	AMK, APY, AUL
S3 quattro	01/2011→	B	BAM
<b>A4 II, Avant</b>			
18	02/2011→05/2011	B	AMB
1.8 T	01/2011→04/2011	B	AMB
1.8 T	02/2011→04/2011	B	BFB, BKB
1.8 T	11/2000→02/2011	B	AVJ
1.8 T	02/2011→04/2011	B	BEX
1.8 T quattro	01/2011→04/2011	B	AMB
1.8 T quattro	02/2011→04/2011	B	BFB
1.8 T quattro	11/2000→02/2011	B	AVJ
1.8 T quattro	02/2011→04/2011	B	BEX
<b>A4 III, Avant</b>			
1.8 T	04/2011→	B	BFB
1.8 T quattro	04/2011→	B	BFB
<b>A6 II, Avant</b>			
1.8 T	01/1997→05/2011	B	AEB, ANB, APU, ARK, AWL, AWT
1.8 T quattro	02/1997→05/2011	B	AEB, ANB, APU, ARK, AWT
<b>TT I, Coupé, Roadster</b>			
1.8 T	01/2011→06/2011	B	AUM
1.8 T	05/2011→06/2011	B	BVR

MAGNETI MARELLI			
Short	Code		
			
<b>Model</b>			
Version		Fuel	Motor code
<b>TT I, Coupé, Roadster</b>			
1.8 T	05/2011→06/2011	B	BVP
1.8 T	10/1998→06/2011	B	AJQ, APP, ARY, ATC, AUQ, AWP
1.8 T quattro	05/2011→06/2011	B	BVF
1.8 T quattro	05/2011→06/2011	B	BVR
1.8 T quattro	10/1998→06/2011	B	AMU, APX, BAM
1.8 T quattro	10/1998→06/2011	B	AJQ, ARY, ATC, AWP
<b>SEAT</b>			
<b>ALHAMBRA I</b>			
1.8 T 20V	10/1997→	B	AJH, AWC
2.0 i	04/1996→	B	ADY, ATM
<b>CORDOBA II, Vario</b>			
1.8 T 20V Cupra	07/2000→02/2011	B	AQX, AYP
<b>CORDOBA III, Vario</b>			
20	02/2011→	B	AZL, BBX
<b>IBIZA III</b>			
1.8 T 20V Cupra	07/2000→02/2011	B	AQX, AYP
<b>IBIZA IV</b>			
1.8 T Cupra R	04/2011→08/2011	B	BBU
1.8 T FR	03/2011→08/2011	B	BJX, BKV
20	02/2011→	B	AZL
<b>LEON I</b>			
1.8 20V	11/1999→06/2011	B	AGN, APG
1.8 20V T	11/1999→06/2011	B	APP, AUQ
1.8 20V T 4	11/1999→06/2011	B	AJQ, ARY
1.8 T Cupra R	02/2011→06/2011	B	AMK
1.8 T Cupra R	03/2011→06/2011	B	BAM
1.8 Turbo 4x4	02/2011→03/2011	B	AMK
<b>LEON II</b>			
1.8 T 20V	05/2011→	B	BAM
1.8 T 20V	05/2011→	B	AUQ
<b>TOLEDO II</b>			
1.8 20V	04/1999→06/2011	B	AGN, APG
1.8 20VT	01/2011→06/2011	B	AUQ
<b>SKODA</b>			
<b>FABIA I, Station Wagon</b>			
20	12/1999→08/2011	B	AQY, AZL
<b>OCTAVIA I, Station Wagon</b>			
18	09/1996→	B	AGN
1.8 20V	07/1998→	B	AGN
1.8 T	07/1998→	B	AGU, ARX, ARZ, AUM
1.8 T	08/1997→	B	AGU, ARX, ARZ, AUM
1.8 T 4x4	01/2011→	B	AGU, ARX, AUM
20	01/2000→	B	ATF
20	04/1999→	B	AEG, APK, AQY, AZH

Short		Code	
Model			
Version		Fuel	Motor code
<b>81703</b>	<b>350981703000</b>		
SKODA			
OCTAVIA I, Station Wagon			
20	04/1999→	B	AEG, APK, AQY, AZH, AZJ
2.0 4x4	01/2011→	B	AEG, AQY, AZH, AZJ
RS 1.8 T	01/2011→	B	AUQ
SUPERB I			
1.8 T	02/2011→08/2011	B	AWT
20	02/2011→08/2011	B	AZM
VOLKSWAGEN			
BORA, Station Wagon			
18	05/2000→05/2011	B	AGU, ARX, AUM
18	10/1998→05/2011	B	AGN, BAF
1.8 4motion	02/1999→05/2011	B	AGN
1.8 4motion	10/2000→01/2011	B	ARX
1.8 T	02/2011→05/2011	B	AUQ
1.8 T	05/2000→05/2011	B	AGU, ARX, AUM, BAE
20	10/1998→05/2011	B	APK, AQY, AZG, AZH, AZJ
2.0 4motion	04/2000→05/2011	B	AZH, AZJ
CADDY III			
2.0 EcoFuel	06/2011→	M	BSX
GOLF IV, Cabrio, Variant			
18	08/1997→05/2011	B	AGN, BAF
1.8 4motion	05/1998→06/2011	B	AGN
1.8 T	08/1997→06/2011	B	AGU, ARZ, AUM
1.8 T GTI	01/2011→05/2011	B	AUQ
20	07/1998→06/2011	B	APK, AQY, AZG, AZJ
2.0 4motion	10/2000→06/2011	B	AZH, AZJ
2.0 Bi-Fuel	02/2011→06/2011	BF	BEH
MULTIVAN			
20	03/2011→	B	AXA
NEW BEETLE, Cabrio			
1.8 T	10/1999→	B	APH, AVC, AWU, AWW
1.8 T	01/2011→05/2011	B	AWP
20	01/1998→	B	AEG, APK, AQY, AZG
20	02/2011→	B	AZJ, BDC, BGD
PASSAT IV, Variant			
20	04/2000→11/2000	B	ASU, AUZ
2.0 4motion	04/2000→11/2000	B	ASU, AUZ
PASSAT V, Variant			
1.8 4motion	01/2011→05/2011	B	AWM
1.8 T	01/2011→05/2011	B	AWM
1.8 T 20V	11/2000→05/2011	B	AWL, AWT
20	11/2000→05/2011	B	AZM, BFF
2.0 4motion	11/2000→05/2011	B	AZM



Short		Code	
Model			
Version		Fuel	Motor code
<b>POLO IV</b>			
1.8 GTI	05/2011→	B	BJX
20	02/2011→	B	BBX
SHARAN I			
1.8 T 20V	09/1997→	B	AJH, AWC
20	09/1995→	B	ADY, ATM
TOURAN			
2.0 EcoFuel	06/2011→	M	BSX
TRANSPORTER V			
20	03/2011→	B	AXA



**81705 350981705000**





<b>PULEGGIA</b>		
Diametro Puleggia		Ø57.1
Altezza Puleggia		33
Posizione Puleggia		61
<b>GIRANTE</b>		
Diametro Girante		Ø79
N° Alette Girante		5
Distanza Girante		29.4

AUDI			
A4 I, Avant			
2.5 TDI	09/1997→01/2011	D	AFB, AKN
2.5 TDI quattro	09/1997→01/2011	D	AFB, AKN
A4 II, Avant			
2.5 D	10/2000→03/2011	D	AKE
2.5 TDI	02/2011→05/2011	D	BCZ, BDG, BFC
2.5 TDI	01/2011→02/2011	D	AYM
2.5 TDi	10/2000→03/2011	D	AKE
2.5 TDI quattro	11/2000→04/2011	D	AKE, BAU, BDH
A4 III, Avant			
2.5 TDI	04/2011→06/2011	D	BDG
A6 II, Avant			
2.5 TDI	02/2000→05/2011	D	AKE, BAU, BDH, BND
2.5 TDI	02/2011→05/2011	D	BCZ, BDG, BFC
2.5 TDI	07/1997→05/2011	D	AFB, AKN
2.5 TDI	01/2011→05/2011	D	AYM
2.5 TDI quattro	02/2000→05/2011	D	AKE, BAU, BDH
2.5 TDI quattro	07/1997→05/2011	D	AFB, AKN
A6 II, Avant, Allroad			
2.5 TDI quattro	05/2000→05/2011	D	AKE, BAU
2.5 TDI quattro	03/2011→05/2011	D	BCZ
A8 I			
2.5 TDI	01/1997→04/2000	D	AFB, AKN

MAGNETI MARELLI			
Short	Code		
			
<b>Model</b>			
Version		Fuel	Motor code
<b>81705</b>	<b>350981705000</b>		
<b>AUDI</b>			
<b>A8 I</b>			
2.5 TDI	09/2000→02/2011	D AKE	
2.5 TDI quattro	07/1997→04/2000	D AFB, AKN	
2.5 TDI quattro	09/2000→02/2011	D AKE	
<b>SKODA</b>			
<b>SUPERB I</b>			
2.5 TDI	02/2011→03/2011	D AYM	
2.5 TDI	03/2011→08/2011	D BDG	
<b>VOLKSWAGEN</b>			
<b>GOLF V, Plus, Variant</b>			
2.5 TDi	03/2011→06/2011	D BDG	
<b>PASSAT IV, Variant</b>			
2.5 TDI	07/1998→11/2000	D AFB, AKN	
2.5 TDI Syncro/4motion	12/1998→11/2000	D AFB, AKN	
<b>PASSAT V, Variant</b>			
2.5 TDI	03/2011→05/2011	D BDG	
2.5 TDI	11/2000→05/2011	D AFB, AKN	
2.5 TDI 4motion	03/2011→05/2011	D BAU, BDH	
2.5 TDI 4motion	11/2000→05/2011	D AFB, AKN	

MAGNETI MARELLI			
Short	Code		
			
<b>Model</b>			
Version		Fuel	Motor code
<b>81706</b>	<b>350981706000</b>		
			
<b>PULEGGIA</b>		Diametro Puleggia	Ø56.1
		Numero Denti/Gole Puleggia	19
		Altezza Puleggia	28.5
		Posizione Puleggia	47.2
<b>GIRANTE</b>		Diametro Girante	Ø63.8
		N° Alette Girante	8
		Distanza Girante	46
<b>AUDI</b>			
<b>A3 I</b>			
1.9 TDI	08/1997→01/2011	D AHF, ASV	
1.9 TDI	09/1996→01/2011	D AGR, ALH	
<b>SEAT</b>			
<b>CORDOBA II, Vario</b>			
1.9 SDI	06/1999→02/2011	D AGP, AQM	
1.9 TDI	06/1999→02/2011	D AGR, ALH	
1.9 TDI	06/1999→02/2011	D ASK, ASV	
<b>IBIZA III</b>			
1.9 SDI	08/1999→02/2011	D AGP, AQM	
1.9 TDI	08/1999→02/2011	D AGR, ALH	

MAGNETI MARELLI			
Short	Code		
			
<b>Model</b>			
Version		Fuel	Motor code
<b>IBIZA III</b>			
1.9 TDI	08/1999→02/2011	D ASK, ASV	
<b>INCA</b>			
1.9 TDI	09/1996→03/2011	D ALH	
<b>LEON I</b>			
1.9 SDI	11/1999→06/2011	D AQM	
1.9 TDI	11/1999→06/2011	D AHF, ASV	
1.9 TDI	11/1999→06/2011	D AGR, ALH	
<b>LEON II</b>			
1.9 TDI	05/2011→	D	
1.9 TDI	05/2011→	D ASV	
<b>TOLEDO II</b>			
1.9 SDI	11/1999→04/2011	D AQM	
1.9 TDI	04/1999→06/2011	D AGR, ALH	
1.9 TDI	04/1999→06/2011	D AHF, ASV	
<b>SKODA</b>			
<b>OCTAVIA I, Station Wagon</b>			
1.9 SDI	06/1997→	D AGP, AQM	
1.9 TDI	07/1998→	D AGR, ALH	
1.9 TDI	08/1997→	D AHF, ASV	
1.9 TDI	09/1996→	D AGR, ALH	
1.9 TDI 4x4	11/1999→09/2000	D AGR	
<b>VOLKSWAGEN</b>			
<b>BORA, Station Wagon</b>			
1.9 SDI	10/1998→05/2011	D AGP, AQM	
1.9 TDI	10/1998→01/2011	D AHF, ASV	
1.9 TDI	10/1998→01/2011	D AGR, ALH	
1.9 TDI 4motion	02/1999→01/2011	D AGR	
<b>CADDY II</b>			
1.9 SDI	11/1995→04/2011	D AEY, AYQ	
<b>GOLF IV, Cabrio, Variant</b>			
1.9 SDI	08/1997→06/2011	D AGP, AQM	
1.9 TDI	08/1997→04/2011	D AHF, ASV	
1.9 TDI	10/1997→06/2011	D AGR, ALH	
1.9 TDI 4motion	07/1998→02/2011	D AGR, ALH	
<b>NEW BEETLE, Cabrio</b>			
1.9 TDI	01/1998→04/2011	D ALH	
<b>POLO III, Classic, Variant, Van</b>			
1.9 SDI	08/1999→01/2011	D AGP, AQM	
1.9 TDI	05/1997→01/2011	D AGR, AHU, ALE, ALH	
1.9 TDI	06/1998→01/2011	D AFN, ASV	
68 1.9 SDI	08/1999→01/2011	D AGP, AQM	
90 1.9 TDI	09/1996→01/2011	D AGR, AHU, ALE, ALH	

Short	Code
-------	------



Model

Version		Fuel	Motor code
---------	--	------	------------

81707 350981707000



**FLANGIA**

Posizione Flangia 65  
Diametro Mozzo Ø28

**GIRANTE**

Diametro Girante Ø85.5  
N° Alette Girante 6  
Distanza Girante 0

**HONDA**

**ACCORD VI, Aerodeck, Coupé**

2.0 TDi 04/1996→10/1998 D 20T2N

**ACCORD VII, Hatchback, Aerodeck, Coupé**

2.0 TDi 12/1999→10/2000 D 20T2N

2.0 Turbo DI 02/1999→02/2011 D 20T2N

**CIVIC IV, Hatchback, SHUTTLE**

2.0 i TD 01/1997→01/2011 D 20T2R

**CIVIC V, Aerodeck, Hatchback, SHUTTLE**

2.0 i D 04/1998→01/2011 D 20T2N

**LAND ROVER**

**DISCOVERY**

2.0 16 V 09/1993→10/1998 B

**FREELANDER**

2.0 DI 02/1998→11/2000 D

**MG**

**MG ZR**

Turbodiesel 01/2011→ D 20T2N

**MG ZS**

2.0 TD 04/2011→ D

2.0 TD 04/2011→ D 20T2N

**ROVER**

**25**

2.0 iDT 10/1999→ D 20T2N

**45**

2.0 iDT 02/2000→05/2011 D 20T2N

**200 II, Coupé**

20 10/1992→09/1997 B

220 GSi 05/1994→06/1999 B 20T4H

220 GTi 01/1993→10/1995 B 20T4H

220 GTi 09/1991→10/1995 B 20M4F

220 Turbo 10/1992→06/1999 B 20T4G

**200 III**

220 D/SD 11/1995→03/2000 D 20T2R

220 SDi 11/1995→03/2000 D 20T2N

Short	Code
-------	------



Model

Version		Fuel	Motor code
---------	--	------	------------

**400 I**

2.0 i 05/1994→11/1998 B 20T4H

2.0 Turbo GSi Sport 10/1992→04/1995 B

420 GSI/SLI/GTI/Vite 01/1993→04/1995 B 20T4H

420 GTI/GSI/Vitesse 02/1992→04/1995 B 20M4F

420 Turbo 01/1993→04/1995 B 20T4G

**400 II**

420 D 11/1995→03/2000 D 20T2R

420 Di 05/1995→03/2000 D 20T2N

420 Si Lux 12/1995→03/2000 B 20T4H

**600**

620 Sdi 12/1994→02/1999 D 20T2N

620 Ti Vitesse 07/1994→02/1999 B 20T4G

**800**

820 16V Turbo 01/1992→02/1999 B T16

820 I/SI 01/1992→02/1999 B 20T4H

820 Sport 04/1994→03/1996 B 20T4G

**STREETWISE**

2.0 TD 03/2011→ D 20T2N

81708 350981708000



**PULEGGIA**

Diametro Puleggia Ø59.26  
Numero Denti/Gole Puleggia 20  
Altezza Puleggia 28.5  
Posizione Puleggia 56

**GIRANTE**

Diametro Girante Ø56.5  
N° Alette Girante 7  
Distanza Girante 20.3

**HONDA**

**ACCORD IV, Aerodeck, Coupé**

2.0 16V 01/1990→03/1993 B F20A2

2.0 16V 01/1990→03/1993 B F20A6

2.0 i 16V 01/1990→12/1993 B F20A4, F20A7, F20A8, F20Z3

2.2 i 16V 01/1990→12/1993 B F22A3, F22A7

2.2 i 16V 01/1991→12/1993 B F22A8

2.2 i 16V Automatic 01/1990→03/1993 B F22A3

**ACCORD V, Aerodeck, Coupé**



20 09/1993→12/1997 B F20B3





2.0 i 03/1993→01/1996 B F20Z2

2.0 i LS 16V 09/1993→02/1998 B F20B3

2.0 i S 03/1993→01/1996 B F20Z1

2.2 i ES 09/1993→02/1998 B F22B5

MAGNETI MARELLI			
Short	Code		
			
<b>Model</b>			
Version		Fuel	Motor code
<b>81708</b>	<b>350981708000</b>		
<b>HONDA</b>			
<b>ACCORD VI, Aerodeck, Coupé</b>			
1.9 i	02/1996→10/1998	B	F18A3
2.0 i LS	02/1996→10/1998	B	F20Z1
2.2 i VTEC	02/1996→10/1998	B	F22Z2
<b>ACCORD VII, Hatchback, Aerodeck, Coupé</b>			
20	12/1999→02/2011	B	F20B6
2.0 i	10/1998→01/2011	B	F20B6
2.0 i 16V	02/1998→03/2011	B	F20B5, F20B7
23	11/2000→03/2011	B	F23Z5
2.3 16 V	02/1998→	B	F23A7
2.3 VTi	02/1998→02/2011	B	F23A3
<b>ACCORD VIII, Tourer</b>			
20	03/2011→	B	K20A
20	03/2011→	B	K20A
2.0 4 ruote motrici	03/2011→	B	K20A
<b>PRELUDE IV</b>			
2.0 i 16V	02/1992→09/1996	B	F20A4
2.2 i 16V Vtec	02/1993→09/1996	B	H22A2
<b>PRELUDE V</b>			
2.0 16V	10/1996→10/2000	B	F20A4
2.2 16V	10/1996→10/2000	B	H22A5
2.2 16V	10/1996→10/2000	B	H22A5
<b>SHUTTLE</b>			
2.2 16V	10/1994→02/1998	B	F22B8
2.2 4x4	06/1994→09/1997	B	
2.3 16V	10/1997→02/2011	B	F23A7
2.3 16V 4x4	10/1997→02/2011	B	F23A
<b>ROVER</b>			
<b>600</b>			
618 i/Si	03/1996→02/1999	B	F18A3
620 i	08/1993→06/1996	B	F20Z2
620 Si	08/1993→02/1999	B	F20Z1

MAGNETI MARELLI			
Short	Code		
			
<b>Model</b>			
Version		Fuel	Motor code
<b>81709</b>	<b>350981709000</b>		
			
<b>PULEGGIA</b>			
Diametro Puleggia		Ø56.3	
Numero Denti/Gole Puleggia		19	
Altezza Puleggia		26.5	
Posizione Puleggia		56	
<b>GIRANTE</b>			
Diametro Girante		Ø59.5	
N° Alette Girante		7	
Distanza Girante		20.2	
<b>HONDA</b>			
<b>ACCORD V, Aerodeck, Coupé</b>			
2.3 i SR	03/1993→01/1996	B	H23A3
<b>PRELUDE IV</b>			
2.3 i 16V	02/1992→09/1996	B	H23A2
<b>ROVER</b>			
<b>600</b>			
623 Si	08/1993→02/1999	B	H23A3
<b>81710</b>	<b>350981710000</b>		
			
<b>PULEGGIA</b>			
Diametro Puleggia		Ø59.31	
Numero Denti/Gole Puleggia		20	
Altezza Puleggia		33.8	
Posizione Puleggia		42.5	
<b>GIRANTE</b>			
Diametro Girante		Ø60	
N° Alette Girante		6	
Distanza Girante		40	
<b>CITROËN</b>			
<b>XANTIA I, Break</b>			
1.8 i 16V	06/1995→01/1998	B	LFY (XU7JP4)
<b>XANTIA II, Break</b>			
1.8 i 16V	01/1998→03/2011	B	LFY (XU7JP4)
<b>XSARA, Break, Coupé, PICASSO</b>			
1.8 i 16V	04/1997→09/2000	B	LFY (XU7JP4)
<b>ZX, Break</b>			
1.8 i 16V	01/1996→02/1998	B	LFY (XU7JP4)
<b>PEUGEOT</b>			
<b>306, Break, Cabrio</b>			
1.8 16V	03/1997→02/2011	B	LFY (XU7JP4)
<b>406, Break, Coupé</b>			
18	10/1997→03/1999	B	
1.8 16V	10/2000→04/2011	B	6FZ (EW7J4)
1.8 16V	11/1995→10/2000	B	LFY (XU7JP4)

Short	Code
-------	------



Model

Version		Fuel	Motor code
---------	--	------	------------

81711 350981711000



**PULEGGIA**

Diametro Puleggia Ø59.31  
 Numero Denti/Gole Puleggia 20  
 Altezza Puleggia 33.8  
 Posizione Puleggia 42.5

**GIRANTE**

Diametro Girante Ø69  
 N° Alette Girante 8  
 Distanza Girante 41.3

**CITROËN**

**EVASION**

2.0 16V 05/1998→04/2000 B RFV (XU10J4R)

**XANTIA I, Break**

2.0 i 16V 06/1995→01/1998 B RFV (XU10J4R)

**XANTIA II, Break**

2.0 i 16V 01/1998→03/2011 B RFV (XU10J4R)

**XM II, Break**

2.0 i 16V 05/1994→10/2000 B RFV (XU10J4R)

**XSARA, Break, Coupé, PICASSO**

2.0 16V 04/1997→09/2000 B RFS (XU10J4RS)

2.0 16V 07/1998→09/2000 B RFV (XU10J4R)

2.0 i 16V 02/1998→05/2011 B RFS (XU10J4RS)

**FIAT**

**ULYSSE I**

2.0 16V 05/1998→09/2000 B RFV

2.0 16V 09/2000→02/2011 B RFN

**LANCIA**

**ZETA**

2.0 16V 05/1998→07/2000 B RFV

**PEUGEOT**

**306, Break, Cabrio**

20 03/1997→02/2011 B RFV (XU10J4R)

2.0 16V 03/1997→02/2011 B RFV (XU10J4R)

2.0 S16 03/1996→01/2011 B RFS (XU10J4RS)

**406, Break, Coupé**

20 11/1996→03/1999 B RGY (XU10J2TE)

2.0 16V 11/1995→04/2011 B RFV (XU10J4R)

**605**

2.0 16V 07/1994→09/1999 B RFV (XU10J4R)

**806**

2.0 16V 05/1998→09/2000 B RFV (XU10J4R)

Short	Code
-------	------



Model

Version		Fuel	Motor code
---------	--	------	------------

81712 350981712000



**PULEGGIA**

Diametro Puleggia Ø75  
 Numero Denti/Gole Puleggia 3  
 Altezza Puleggia 19  
 Posizione Puleggia 60

**GIRANTE**

Diametro Girante Ø79.5  
 N° Alette Girante 8  
 Distanza Girante 29.25

**CITROËN**

**JUMPER I**

2.5 D 03/1994→02/2011 D T9A (DJ5)

2.5 D 4x4 08/1996→02/2011 D T9A (DJ5)

2.5 DT 4x4 10/1996→08/1997 D

2.5 TD 03/1994→02/2011 D T8A (DJ5T)

2.5 TD 4x4 08/1996→02/2011 D T8A (DJ5T)

2.5 TDi 12/1996→02/2011 D THX (DJ5TED)

2.5 TDi 4x4 12/1996→02/2011 D THX (DJ5TED)

**XM II, Break**

2.5 TD 05/1994→10/2000 D THY (DK5ATE)

**PEUGEOT**

**605**

2.5 Turbo Diesel 07/1994→09/1999 D THY (DK5ATE)

**BOXER I**

2.5 D 03/1994→02/2011 D T9A (DJ5)

2.5 D 4x4 07/1996→02/2011 D T9A (DJ5)

2.5 TD 03/1994→02/2011 D T8A (DJ5T)

2.5 TD 4x4 07/1996→02/2011 D T8A (DJ5T)

2.5 TDI 01/1997→02/2011 D THX (DJ5TED)

2.5 TDI 4x4 01/1997→02/2011 D THX (DJ5TED)

81713 350981713000



**PULEGGIA**

Diametro Puleggia Ø59.3  
 Numero Denti/Gole Puleggia 20  
 Altezza Puleggia 33.8  
 Posizione Puleggia 42.5

**GIRANTE**

Diametro Girante Ø69  
 N° Alette Girante 7  
 Distanza Girante 42

**CITROËN**

**BERLINGO I, Furgonato**

1.9 D 07/1998→ D WJY (DW8B), WJZ (DW8)



MAGNETI MARELLI			
Short	Code		
<b>Model</b>			
Version		Fuel	Motor code
81713	350981713000		
<b>CITROËN</b>			
<b>BERLINGO I, Furgonato</b>			
1.9 D 4WD	07/1998→	D	WJZ (DW8)
1.9 D 70	04/1999→	D	WJZ (DW8)
1.9 D 70 4WD	07/1998→	D	WJZ (DW8)
2.0 HDi	02/2011→05/2011	D	DW10TD
2.0 HDi 4x4	02/2011→05/2011	D	DW10TD
2.0 HDi 90	12/1999→	D	RHY (DW10TD)
2.0 HDi 90 4WD	11/2000→	D	RHY (DW10TD)
<b>C 15, Station Wagon</b>			
1.9 D	12/2000→05/2011	D	
<b>C 5 I, Break</b>			
2.0 HDi	01/2011→04/2011	D	RHY (DW10TD)
2.0 HDi	01/2011→04/2011	D	RHS (DW10ATED)
2.0 HDi	01/2011→04/2011	D	RHZ (DW10ATED)
<b>C 8</b>			
2.0 HDi	02/2011→	D	RHW (DW10ATED4)
<b>EVASION</b>			
2.0 HDi	08/1999→02/2011	D	RHZ (DW10ATED)
<b>JUMPER I</b>			
2.0 HDi	01/2011→02/2011	D	DW10UTD
<b>JUMPER II</b>			
2.0 HDi	02/2011→	D	DW10UTD
<b>JUMPY I</b>			
1.9 D 70	04/1998→	D	WJZ (DW8)
2.0 HDi	03/2011→06/2011	D	
2.0 HDi 110	03/2000→	D	RHZ (DW10ATED)
2.0 HDi 95	10/1999→	D	RHX, RHX (DW10BTED)
<b>XANTIA II, Break</b>			
2.0 HDi 109	02/1999→03/2011	D	RHZ (DW10ATED)
2.0 HDi 90	03/1999→03/2011	D	RHY (DW10TD)
<b>XSARA, Break, Coupé, PICASSO</b>			
1.9 D	07/1998→05/2011	D	WJY (DW8B), WJZ (DW8)
2.0 HDi	12/1999→	D	RHY (DW10TD)
2.0 HDi 109	01/2011→05/2011	D	RHZ (DW10ATED)
2.0 HDi 90	02/1999→05/2011	D	RHY (DW10TD)
<b>FIAT</b>			
<b>DUCATO III</b>			
2.0 JTD	01/2011→02/2011	D	RHV (DW10)
<b>DUCATO IV</b>			
2.0 JTD	02/2011→	D	RHV (DW10)
<b>SCUDO I</b>			
2.0 JTD	12/1999→	D	RHZ
2.0 JTD	12/1999→	D	RHX

MAGNETI MARELLI			
Short	Code		
<b>Model</b>			
Version		Fuel	Motor code
<b>ULYSSE I</b>			
2.0 JTD	10/1999→02/2011	D	RHZ
<b>ULYSSE II</b>			
2.0 JTD	03/2011→	D	RHM (DW10ATED4)
2.0 JTD	02/2011→	D	RHW (DW10ATED4)
<b>LANCIA</b>			
<b>PHEDRA</b>			
2.0 JTD	03/2011→	D	RHM
2.0 JTD	02/2011→	D	RHW (DW10ATED4)
<b>ZETA</b>			
2.0 JTD	09/1999→02/2011	D	RHW
<b>PEUGEOT</b>			
<b>206, Station Wagon, CC, Plus</b>			
1.9 D	09/1998→01/2011	D	WJZ (DW8)
2.0 HDi	02/2011→	D	RHY (DW10TD)
2.0 HDi 90	12/1999→	D	RHY (DW10TD)
<b>306, Break, Cabrio</b>			
1.9 D	09/1998→02/2011	D	WJY (DW8B), WJZ (DW8)
2.0 HDi 90	06/1999→02/2011	D	RHY (DW10TD)
<b>307, Break, CC</b>			
2.0 HDi 110 FAP	08/2000→	D	RHS (DW10ATED)
2.0 HDi 90	08/2000→	D	RHY (DW10TD)
<b>406, Break, Coupé</b>			
2.0 HDi 110	06/1998→04/2011	D	RHZ (DW10ATED)
2.0 HDi 110 FAP	01/2011→04/2011	D	RHS (DW10ATED)
2.0 HDi 90	02/1999→04/2011	D	RHY (DW10TD)
<b>607</b>			
2.0 HDi	01/2011→04/2011	D	RHS (DW10ATED)
2.0 HDi	05/2000→	D	RHZ (DW10ATED)
<b>806</b>			
2.0 HDi	08/1999→02/2011	D	RHZ (DW10ATED)
2.0 HDi 16V	08/1999→02/2011	D	RHW (DW10ATED4)
<b>807</b>			
2.0 HDi FAP	02/2011→	D	RHW (DW10ATED4)
<b>BOXER I</b>			
2.0 HDi	01/2011→02/2011	D	
<b>BOXER II</b>			
2.0 HDi	02/2011→	D	RHV (DW10UTD)
<b>EXPERT I</b>			
1.9 D 70	12/1998→	D	WJY (DW8B), WJZ (DW8)
2.0 HDi	07/2000→	D	RHZ (DW10ATED)
2.0 HDi	07/2000→03/2011	D	RHW (DW10ATED4)
2.0 HDi	10/2000→06/2011	D	RHX (DW10BTED)
2.0 HDi Comfort	10/2000→03/2011	D	RHX (DW10BTED)

Short Code



Model

Version		Fuel	Motor code
---------	--	------	------------

81713 350981713000

PEUGEOT

EXPERT II, Tepee

2.0 HDi	10/2000→03/2011	D	
2.0 HDi	10/2000→06/2011	D	

PARTNER - Ranch, I

1.9 D	06/1996→	D	WJY (DW8B), WJZ (DW8)
2.0 HDI	02/2000→	D	RHY (DW10TD)
2.0 HDi 4x4	04/2011→	D	RHY (DW10TD)

SUZUKI

GRAND VITARA I

2.0 HDI 110	01/2011→	D	RHW, RHZ
-------------	----------	---	----------

81714 350981714000



**FLANGIA**  
 Numero Fori Flangia 4  
 Dimensione Fori Flangia M6x1  
 Posizione Flangia 87.5  
 Diametro Mozzo Ø23.5

**GIRANTE**  
 Diametro Girante Ø61  
 N° Alette Girante 7  
 Distanza Girante 2

DAIHATSU

APPLAUSE I

1.6 16V	06/1989→07/1997	B	HD
1.6 16V	06/1989→07/1997	B	HD-E
1.6 16V 4WD	06/1989→07/1997	B	HD-E

APPLAUSE II

1.6 16V	07/1997→05/2000	B	HD-E
---------	-----------------	---	------

CHARADE III

13	09/1988→01/1992	B	HC-C
13	11/1990→02/1993	B	HCE
1.3 i	06/1988→12/1992	B	HCE
1.3 i 4WD	06/1988→01/1993	B	HCE

CHARADE IV

10	09/1994→03/1996	B	CB22
13	09/1996→11/1999	B	HC
1.3 16V	01/1993→11/1999	B	HC
1.3 16V	05/1996→11/1999	B	
15	10/1994→	B	HE
1.5 16V	08/1994→11/1999	B	HEE, HEEG
1.5 HG	06/1994→03/1996	B	HEE
1.6 GTi	03/1993→11/1999	B	HD-E

Short Code



Model

Version		Fuel	Motor code
---------	--	------	------------

GRAN MOVE

1.5 16V	10/1996→07/1998	B	HEEG
1.6 16V	05/1998→	B	HDEP

HIJET II

1.3 i 16V	05/1998→	B	HCE
-----------	----------	---	-----

ROCKY Hard Top

2.8 TD	09/1991→	D	DL52
2.8 TD	12/1987→04/1993	D	DL51

81715 350981715000



**FLANGIA**  
 Numero Fori Flangia 4  
 Dimensione Fori Flangia M6x1  
 Posizione Flangia 87.4  
 Diametro Mozzo Ø32

**GIRANTE**  
 Diametro Girante Ø61  
 N° Alette Girante 7  
 Distanza Girante 2

DAIHATSU

FEROZA Hard Top

1.6 16V	10/1988→	B	HDC
1.6 i 16V	10/1988→	B	HD-E

FEROZA Soft Top

1.6 16V	10/1988→	B	HDC
1.6 i 16V	10/1988→	B	HD-E

TERIOS I

1.3 4WD	10/1997→10/2000	B	HE-EJ
---------	-----------------	---	-------

81716 350981716000



**FLANGIA**  
 Numero Fori Flangia 3  
 Dimensione Fori Flangia M6x1  
 Posizione Flangia 76.3  
 Diametro Mozzo Ø23.5

**GIRANTE**  
 Diametro Girante Ø57  
 N° Alette Girante 8  
 Distanza Girante 12



FORD

FIESTA IV, Van

1.3 i	08/1995→02/2011	B	J4C, J4J, J4L, J4Q, J4R, J4T
1.3 i	08/1995→02/2011	B	JJA, JJC, JJE, JJJ, JJK, JJM



KA I, Street KA

1.0 i	07/1997→09/1999	B	ZH10JRB
-------	-----------------	---	---------

MAGNETI MARELLI			
Short	Code		
			
<b>Model</b>			
Version		Fuel	Motor code
81716	350981716000		
<b>FORD</b>			
<b>KA I, Street KA</b>			
1.0 i	09/1999→08/2011	B	
1.3 i	06/1998→08/2011	B	JJD, JJF, JJG, JJH, JJJ
1.3 i	09/1996→08/2011	B	BAA, J4D, J4K, J4M, J4N, J4P, J4S
1.3 i	09/1996→02/2011	B	JJB
<b>MAZDA</b>			
<b>121 III</b>			
13	03/1996→	B	
13	03/1996→	B	

81717 350981717000			
			
<b>PULEGGIA</b>			
Diametro Puleggia			Ø62.35
Numero Denti/Gole Puleggia			21
Altezza Puleggia			26.5
Posizione Puleggia			47
<b>GIRANTE</b>			
Diametro Girante			Ø63
N° Alette Girante			6
Distanza Girante			52.5

<b>LADA</b>			
<b>110</b>			
15	01/1995→	B	VAZ-2111
15	01/1995→	B	
15	10/2000→	B	VAZ-2111
<b>SAMARA</b>			
15	01/2000→	B	VAZ-2111
1100	02/1988→12/1994	B	BA321081
1100	02/1996→	B	BA321081 (KAT)
1300	01/1986→12/1994	B	BA32108
1300	01/1988→	B	BA32108
1300	02/1996→	B	BA321115
1300	09/1991→	B	BA32108 (KAT)
1500	01/1988→	B	BA321083
1500	02/1995→	B	BA32111
1500	09/1991→	B	BA321083 (KAT)
<b>SAMARA Forma</b>			
15	01/2000→	B	VAZ-2111
1100	07/1991→	B	BA321081 (KAT)
1300	02/1996→	B	
1300	05/1989→07/1997	B	BA32108
1300	05/1990→	B	
1300	07/1991→	B	BA32108

MAGNETI MARELLI			
Short	Code		
			
<b>Model</b>			
Version		Fuel	Motor code
<b>SAMARA Forma</b>			
1500	07/1991→	B	BA321083 (KAT)
1500	09/1991→	B	BA321083
1500	11/1994→	B	BA32111

81718 350981718000			
			
<b>FLANGIA</b>			
Numero Fori Flangia			3
Dimensione Fori Flangia			M6x1
Posizione Flangia			106.7
<b>GIRANTE</b>			
Diametro Girante			Ø52.5
N° Alette Girante			6
Distanza Girante			-0.85



<b>MAZDA</b>			
<b>323 C IV</b>			
13	09/1989→07/1994	B	B3E
<b>323 S VI</b>			
2.0 TD	09/1998→04/2011	D	RF3F
<b>SSANGYONG</b>			
<b>KORANDO</b>			
20	05/1997→	B	
23	01/1999→	B	
23	05/1997→	B	
<b>MUSSO</b>			
20	10/1996→	B	E20
23	03/2011→	B	
23	10/1996→	B	M111.970



81722 350981722000			
			
<b>FLANGIA</b>			
Numero Fori Flangia			3
Dimensione Fori Flangia			M8x1.25
Posizione Flangia			128.2
Diametro Mozzo			Ø30
<b>GIRANTE</b>			
Diametro Girante			Ø77
N° Alette Girante			4
Distanza Girante			22



<b>DAEWOO</b>			
<b>KORANDO, Cabrio</b>			
32	01/1999→	B	M104.995
<b>MUSSO</b>			
32	01/1999→	B	M104.992



MAGNETI MARELLI			
Short	Code		
<b>Model</b>			
Version		Fuel	Motor code
81722	350981722000		
<b>MERCEDES-BENZ</b>			
<b>Cabriolet, Coupé III (124)</b>			
320 CE	10/1992→05/1993	B	M104.992
<b>cl. C I, Station Wagon (202)</b>			
C 200 D	03/1993→05/2000	D	OM601.913
C 280	05/1993→05/2000	B	M104.941
C 280	06/1997→05/2000	B	M112.920
C 280 T	06/1997→01/2011	B	M112.920
C 36 AMG	05/1994→05/2000	B	M104.941 (AMG3.6)
<b>cl. E I, Station Wagon, Cabrio, Coupé (124)</b>			
E 280	06/1993→06/1995	B	M104.942
E 280 long	06/1993→06/1995	B	M104.942
E 280 T	06/1993→06/1996	B	M104.942
E 280 T	06/1993→06/1996	B	M104.942
E 320	06/1993→03/1998	B	M104.992, M104.995
E 320 T	06/1993→06/1996	B	M104.992
E 36 AMG	05/1994→03/1998	B	M104.992 (AMG3.6)
<b>cl. E II, Station Wagon (210)</b>			
E 280	01/1996→06/1997	B	M104.945
E 280	12/1996→02/2011	B	M112.921
E 280 4-matic	12/1996→02/2011	B	M112.921
E 280 T	12/1996→03/2011	B	M112.921
E 280 T 4-matic	12/1996→03/2011	B	M112.921
E 320	06/1995→06/1997	B	M104.995
E 320	06/1997→02/2011	B	M112.941
E 320 4-matic	06/1997→02/2011	B	M112.941
E 320 T	12/1996→03/2011	B	M112.941
E 320 T 4-matic	12/1996→03/2011	B	M112.941
<b>SL III (129)</b>			
280	05/1998→01/2011	B	M112.923, M112.925
280	08/1993→01/2011	B	M104.943

MAGNETI MARELLI			
Short	Code		
<b>Model</b>			
Version		Fuel	Motor code
81723	350981723000		
<b>MERCEDES-BENZ</b>			
<b>100</b>			
D	12/1990→02/1996	D	OM616, OM616.963
<b>cl. C I, Station Wagon (202)</b>			
C 220 D	07/1996→05/2000	D	OM604.910
C 220 D	08/1993→05/2000	D	OM604.910
<b>cl. E II, Station Wagon (210)</b>			
E 200 D	01/1996→02/2011	D	OM604.917
E 220 D	05/1996→02/2011	D	OM604.912
E 220 D	06/1995→07/1999	D	OM604.912
<b>81724 350981724000</b>			
		<b>FLANGIA</b> Numero Fori Flangia 4 Dimensione Fori Flangia M6x1 Posizione Flangia 106 Diametro Mozzo M30x1.5 SX Diametro Centraggio Ø35 <b>GIRANTE</b> Diametro Girante Ø69 N° Alette Girante 8 Distanza Girante 21.5	
<b>MERCEDES-BENZ</b>			
<b>cl. G (460, 461, 463)</b>			
320 GE	09/1994→11/1997	B	M104.996
G 320	07/1997→	B	M112.945
G 320	09/1994→12/1997	B	M104.996
<b>cl. S IV, Coupé (140)</b>			
300 SE 2.8	01/1993→10/1998	B	M104.944
300 SE,SEL/S320	03/1991→10/1998	B	M104.990, M104.994
S 280	02/1993→10/1998	B	M104.944
<b>cl. S V (220), Coupé (215)</b>			
S 320	10/1998→05/2011	B	M112.944
<b>CLK I, Cabrio (208)</b>			
200 Kompressor	03/1998→06/2000	B	M111.944

MAGNETI MARELLI			
Short	Code		
			
<b>Model</b>			
Version		Fuel	Motor code
81724	350981724000		
<b>MERCEDES-BENZ</b>			
<b>SL III (129)</b>			
320	09/1993→01/2011	B	M104.991
<b>SSANGYONG</b>			
<b>KORANDO</b>			
32	01/1999→	B	M104.995
32	06/1997→	B	
32	12/1996→	B	M104.995
<b>MUSSO</b>			
32	06/1996→	B	M104.992
<b>REXTON</b>			
32	02/2011→	B	

MAGNETI MARELLI			
Short	Code		
			
<b>Model</b>			
Version		Fuel	Motor code
81725	350981725000		
			
<b>FLANGIA</b>			
Numero Fori Flangia			4
Dimensione Fori Flangia			M6x1
Posizione Flangia			109
Diametro Mozzo			M30x1.5
SX			
Diametro Centraggio			Ø35
<b>GIRANTE</b>			
Diametro Girante			Ø77
N° Alette Girante			4
Distanza Girante			15.4
<b>MERCEDES-BENZ</b>			
<b>cl. C I, Station Wagon (202)</b>			
C 230 Kompressor	10/1995→05/2000	B	M111.975
C 230 T Kompressor	06/1997→09/2000	B	M111.975
<b>cl. E II, Station Wagon (210)</b>			
E 200 Kompressor	06/1997→02/2011	B	M111.947
E 200 T Kompressor	06/1997→03/2011	B	M111.947
<b>CLK I, Cabrio (208)</b>			
200	03/1998→02/2011	B	M111.941, M111.945
200 Kompressor	06/2000→02/2011	B	M111.956
200 Kompressor	06/1997→06/2000	B	M111.944
230 Kompressor	06/2000→02/2011	B	M111.982
230 Kompressor	06/1997→06/2000	B	M111.973, M111.975
<b>CLK II, Cabrio (209)</b>			
200 CGI	03/2011→	B	M271.942
<b>SLK I (170)</b>			
200 Kompressor	10/1996→03/2000	B	M111.943
230 Kompressor	09/1996→03/2000	B	M111.973

MAGNETI MARELLI			
Short	Code		
			
<b>Model</b>			
Version		Fuel	Motor code
81726	350981726000		
			
<b>FLANGIA</b>			
Numero Fori Flangia			4
Dimensione Fori Flangia			M6x1
Posizione Flangia			106
Numero Fori Flangia (Serie 2)			2
Dimensione Fori Flangia (Serie 2)			Ø6
Diametro Mozzo			Ø35
<b>GIRANTE</b>			
Diametro Girante			Ø70
N° Alette Girante			10
Distanza Girante			21.5
<b>MERCEDES-BENZ</b>			
<b>cl. C I, Station Wagon (202)</b>			
C 250 Turbo-D	10/1995→05/2000	D	OM605.960
<b>cl. E I, Station Wagon, Cabrio, Coupé (124)</b>			
E 250 D	07/1993→06/1995	D	OM605.911
<b>cl. G (460, 461, 463)</b>			
350 G Turbo-D	09/1991→09/1997	D	OM603.972
G 300 TD	09/1996→	D	OM606.964

MAGNETI MARELLI			
Short	Code		
			
<b>Model</b>			
Version		Fuel	Motor code
81728	350981728000		
			
<b>FLANGIA</b>			
Numero Fori Flangia			4
Dimensione Fori Flangia			M6x1
Posizione Flangia			59.6
Numero Fori Flangia (Serie 2)			2
Dimensione Fori Flangia (Serie 2)			Ø6
Diametro Mozzo			Ø35
<b>GIRANTE</b>			
Diametro Girante			Ø77
N° Alette Girante			4
Distanza Girante			15.4
<b>MERCEDES-BENZ</b>			
<b>cl. V</b>			
V 200	02/1997→03/2011	B	M111.948
V 230	10/1996→03/2011	B	M111.978
<b>VITO - Viano I (638)</b>			
113 2.0	02/1996→03/2011	B	M111.948
114 2.3	12/1996→03/2011	B	M111.978, M111.980

Short	Code
-------	------



Model

Version		Fuel	Motor code
---------	--	------	------------

81729			350981729000
-------	--	--	--------------



FLANGIA	
Numero Fori Flangia	4
Dimensione Fori Flangia	M6x1
Posizione Flangia	59.6
Numero Fori Flangia (Serie 2)	2
Dimensione Fori Flangia (Serie 2)	Ø6
Diametro Mozzo	Ø35
GIRANTE	
Diametro Girante	Ø77
N° Alette Girante	4
Distanza Girante	15.4

**MERCEDES-BENZ**

**cl. V**

V 200	02/1997→03/2011	B	M111.948
V 230	10/1996→03/2011	B	M111.978

**VITO - Viano I (638)**

113 2.0	02/1996→03/2011	B	M111.948
114 2.3	12/1996→03/2011	B	M111.978, M111.980

81730			350981730000
-------	--	--	--------------



FLANGIA	
Numero Fori Flangia	4
Dimensione Fori Flangia	M6x1
Posizione Flangia	83.5
Diametro Mozzo	M30x1.5
SX	
Diametro Centraggio	Ø35
GIRANTE	
Diametro Girante	Ø77.7
N° Alette Girante	6
Distanza Girante	13.35

**MERCEDES-BENZ**

**cl. C I, Station Wagon (202)**

C 240	06/1997→05/2000	B	M112.910
C 240 T	06/1997→09/2000	B	M112.910
C 240 T	09/2000→01/2011	B	M112.915
C 43 AMG	08/1997→01/2011	B	M113.944

**cl. C II, Station Wagon, Coupé (203)**

C 240	05/2000→	B	M112.912
C 240 4-matic	02/2011→	B	M112.916
C 320	05/2000→	B	M112.946

**cl. E II, Station Wagon (210)**

E 240	06/1997→08/2000	B	M112.911
E 240	08/2000→02/2011	B	M112.914
E 240 T	06/1997→03/2011	B	M112.911
E 240 T	08/2000→03/2011	B	M112.914
E 430	06/1997→02/2011	B	M113.940
E 430 4-matic	05/1999→02/2011	B	M113.940

Short	Code
-------	------



Model

Version		Fuel	Motor code
---------	--	------	------------

**cl. E II, Station Wagon (210)**

E 430 T	06/1997→03/2011	B	M113.940
E 430 T 4-matic	05/1999→03/2011	B	M113.940
E 55 AMG	08/1997→02/2011	B	M113.980
E 55 T AMG	08/1997→03/2011	B	M113.980

**cl. E II, Station Wagon (211)**

E 240	02/2011→	B	M112.913, M112.917
E 240 4-matic	03/2011→	B	M112.917
E 240 T	03/2011→	B	M112.913
E 240 T 4-matic	03/2011→	B	M112.917
E 320	02/2011→	B	M112.949
E 320 4-matic	03/2011→	B	M112.954
E 320 T	03/2011→	B	M112.949
E 320 T 4-matic	03/2011→	B	M112.954
E 500	02/2011→	B	M113.967
E 500	06/2011→	B	M273.960
E 500 4-matic	06/2011→	B	M273.962
E 500 4-matic	03/2011→	B	M113.969
E 500 T	06/2011→	B	M273.960
E 500 T	03/2011→	B	M113.967
E 500 T 4-matic	06/2011→	B	M273.962
E 500 T 4-matic	03/2011→	B	M113.969

**cl. G (460, 461, 463)**

G 320	11/1997→	B	M112.945
G 500	04/1998→	B	M113.962

**cl. M I (163)**

ML 320	02/1998→02/2011	B	M112.942
ML 350	03/2011→05/2011	B	M112.970
ML 350	02/2011→05/2011	B	M112.970
ML 430	02/1998→05/2011	B	M113.942
ML 55 AMG	02/2000→05/2011	B	M113.981

**cl. M II (164)**

ML 500 4-matic	05/2011→	B	M113.964
----------------	----------	---	----------

**cl. S V (220), Coupé (215)**



CL 500	03/1999→06/2011	B	M113.960
CL 55 AMG	10/1999→06/2011	B	M113.986
S 430	10/1998→05/2011	B	M113.941



**CLK I, Cabrio (208)**



320	03/1998→02/2011	B	M112.940
320	06/1997→02/2011	B	M112.940
430	07/1998→02/2011	B	M113.943

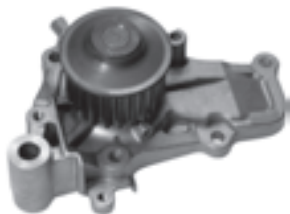

**CLK II, Cabrio (209)**

240	02/2011→	B	M112.912
320	03/2011→	B	M112.955
320	02/2011→	B	M112.955

MAGNETI MARELLI			
Short	Code		
			
<b>Model</b>			
Version		Fuel	Motor code
<b>81730 350981730000</b>			
<b>MERCEDES-BENZ</b>			
<b>CLK II, Cabrio (209)</b>			
500	03/2011→	B	M113.968
500	02/2011→	B	M113.968
<b>CLS I (219)</b>			
500	04/2011→	B	M113.967
<b>SL III (129)</b>			
320	05/1998→01/2011	B	M112.943
<b>SL IV (230)</b>			
350	03/2011→	B	M112.973
500	01/2011→	B	M113.963
<b>SLK I (170)</b>			
320	03/2000→04/2011	B	M112.947
<b>VITO - Viano II (639)</b>			
32	03/2011→	B	M112.951
32	03/2011→	B	M112.951
37	04/2011→	B	M112.976
119	03/2011→	B	M112.951
119 3.2	03/2011→	B	M112.951
122	03/2011→	B	M112.951
122 3.2	03/2011→	B	M112.951
123	04/2011→08/2011	B	
123	04/2011→	B	M112.976

MAGNETI MARELLI			
Short	Code		
			
<b>Model</b>			
Version		Fuel	Motor code
<b>81731 350981731000</b>			
			
<b>PULEGGIA</b>			
Diametro Puleggia			Ø59.8
Numero Denti/Gole Puleggia			24
Altezza Puleggia			32.5
Posizione Puleggia			65.7
<b>GIRANTE</b>			
Diametro Girante			Ø59
N° Alette Girante			8
Distanza Girante			1
<b>MITSUBISHI</b>			
<b>COLT IV</b>			
1.6 4x4	08/1993→08/1995	B	4G92
1.6 GLXi 16V	04/1992→04/1996	B	4G92
1.8 GTi 16V	04/1992→04/1996	B	4G93
<b>GALANT V, Station Wagon</b>			
18	02/1994→08/1996	B	4G93
1.8 GLSI	11/1992→08/1996	B	4G93
<b>LANCER III</b>			
1.8 4x4	08/1990→06/1992	B	4G37

MAGNETI MARELLI			
Short	Code		
			
<b>Model</b>			
Version		Fuel	Motor code
<b>LANCER IV</b>			
1.6 4x4	06/1992→11/1993	B	4G92
1.6 GLi 16V	06/1992→05/1994	B	4G92
1.8 GTi 16V	06/1992→12/1993	B	4G93
<b>LANCER V, Station Wagon, Coupé</b>			
16	02/1994→	B	4G92
1.6 16V	06/1992→	B	4G92
1.6 16V 4WD	06/1992→	B	4G92
1.6 GLXi 16V	12/1992→03/2011	B	4G92
1.6 GLXi 16V 4WD	12/1992→03/2011	B	4G92
1.8 16V	06/1992→12/1993	B	4G93
<b>SPACE RUNNER I</b>			
18	06/1996→08/1999	B	4G93
18	10/1991→08/1999	B	4G93
1.8 4x4	06/1996→08/1999	B	4G93
1.8 4x4	10/1991→08/1999	B	4G93
<b>SPACE WAGON II</b>			
18	10/1991→10/1998	B	4G93
1.8 4x4	10/1991→10/1998	B	4G93
<b>PROTON</b>			
<b>PERSONA 400</b>			
416 i	12/1995→	B	4G92

MAGNETI MARELLI			
Short	Code		
			
<b>Model</b>			
Version		Fuel	Motor code
<b>81733 350981733000</b>			
			
<b>PULEGGIA</b>			
Diametro Puleggia			Ø59.35
Numero Denti/Gole Puleggia			20
Altezza Puleggia			35
Posizione Puleggia			60
<b>GIRANTE</b>			
Diametro Girante			Ø68.3
N° Alette Girante			6
Distanza Girante			12
<b>CHRYSLER</b>			
<b>NEON I</b>			
1.8 16V	09/1997→08/1999	B	EBD
2.0 16V	04/1996→08/1999	B	420T
2.0 16V	05/1994→08/1999	B	420H
2.0 16V	06/1994→08/1999	B	ECC
<b>NEON II</b>			
16	01/2011→	B	EJD
2.0 16V	08/1999→	B	420H
2.0 16V R/T	01/2011→	B	ECH
<b>PT Cruiser, Cabrio</b>			
16	01/2011→	B	EJD

Short		Code	
<b>Model</b>			
Version		Fuel	Motor code
81733	350981733000		
<b>CHRYSLER</b>			
<b>PT Cruiser, Cabrio</b>			
20	06/2000→	B	ECC
20	04/2011→	B	ECC
<b>SEBRING II, Cabrio</b>			
20	01/2011→	B	ECC
<b>STRATUS, Cabrio</b>			
2.0 16V	12/1995→	B	ECB
2.0 LE	12/1995→01/2011	B	420X, C00
<b>VOYAGER II</b>			
2.0 i	01/1995→01/2011	B	C00
<b>MITSUBISHI</b>			
<b>ECLIPSE II, Cabrio</b>			
2.0 Turbo	04/1994→04/1999	B	
2.0 Turbo 4WD	04/1994→04/1999	B	
2.0 Turbo 4WD	12/1995→04/1999	B	
2000 GS 16V	12/1995→04/1999	B	4G63
2000 GT 16V	12/1995→04/1999	B	

Short		Code	
<b>Model</b>			
Version		Fuel	Motor code
81734	350981734000		
<b>PULEGGIA</b>			
Diametro Puleggia			Ø56.35
Numero Denti/Gole Puleggia			19
Altezza Puleggia			23
Posizione Puleggia			35
<b>GIRANTE</b>			
Diametro Girante			Ø57
N° Alette Girante			8
Distanza Girante			12.7
<b>NISSAN</b>			
<b>MICRA I (K10)</b>			
12	07/1986→07/1992	B	MA12S
12	07/1986→07/1992	B	MA12S

Short		Code	
<b>Model</b>			
Version		Fuel	Motor code
81736	350981736000		
<b>FLANGIA</b>			
Numero Fori Flangia			4
Dimensione Fori Flangia			M6x1
Posizione Flangia			51
Diametro Mozzo			Ø17.3
<b>GIRANTE</b>			
Diametro Girante			Ø72
N° Alette Girante			6
Distanza Girante			17.3
<b>NISSAN</b>			
<b>100 NX</b>			
20	10/1990→10/1994	B	SR20DE
2.0 GTI	03/1991→10/1994	B	SR20DE
<b>200 SX III</b>			
2.0 i 16V	10/1993→12/1999	B	SR20DE
<b>ALMERA I, Hatchback</b>			
2.0 D	11/1995→07/2000	D	CD20
2.0 GTi	07/1996→03/2000	B	SR20DE
<b>ALMERA Tino</b>			
20	08/2000→	B	SR20DE
<b>PRIMERA I</b>			
20	06/1990→04/1993	B	SR20DE
20	06/1990→01/1998	B	SR20DE
2.0 16V	06/1990→01/1996	B	SR20DI
2.0 16V 4x4	04/1991→06/1996	B	SR20DI
2.0 GT	06/1990→01/1996	B	SR20DE
2.0 GT 4x4	03/1991→04/1993	B	SR20DE
2.0 i	01/1995→06/1996	B	SR20DE
2.0 i	07/1990→03/1998	B	SR20DI
<b>PRIMERA II</b>			
2.0 16V	08/1999→02/2011	B	SR20DE
2.0 16V	09/1996→02/2011	B	SR20DE
2.0 16V	09/1996→02/2011	B	SR20De
2.0 16V	09/1996→02/2011	B	SR20DE
<b>SERENA I</b>			
2.0 16V	11/1992→	B	SR20DE
<b>SUNNY III</b>			
2.0 GTI 16V	10/1990→05/1995	B	SR20DE
2.0 GTI-R 4x4	10/1990→05/1995	B	SR20DET
2.0 i 16V	10/1990→05/1995	B	SR20DE



Short **MAGNETI MARELLI** Code



Model

Version		Fuel	Motor code
---------	--	------	------------

81740 350981740000



**FLANGIA**  
 Numero Fori Flangia 4  
 Dimensione Fori Flangia M6x1  
 Posizione Flangia 82.8  
 Diametro Mozzo Ø25

**GIRANTE**  
 Diametro Girante Ø69  
 N° Alette Girante 6  
 Distanza Girante 1

NISSAN

200 SX II

1.8 Turbo	07/1988→11/1993	B	CA18DET
-----------	-----------------	---	---------

81742 350981742000



**FLANGIA**  
 Numero Fori Flangia 3  
 Dimensione Fori Flangia M6x1  
 Posizione Flangia 51  
 Diametro Mozzo Ø17.2

**GIRANTE**  
 Diametro Girante Ø57  
 N° Alette Girante 8  
 Distanza Girante 19.5

NISSAN

MICRA II (K11)

1.0 i 16V	08/1992→09/2000	B	CG10DE
1.0 i 16V	09/2000→03/2011	B	CG10DE
1.3 i 16V	08/1992→09/2000	B	CG13DE
1.4 i 16V	09/2000→03/2011	B	CGA3DE

81743 350981743000



**PULEGGIA**  
 Diametro Puleggia Ø57.4  
 Numero Denti/Gole Puleggia 23  
 Posizione Puleggia 35

**GIRANTE**  
 Diametro Girante Ø57  
 N° Alette Girante 8  
 Distanza Girante 12.7

NISSAN

MICRA I (K10)

12	07/1986→07/1992	B	MA12S
12	07/1986→07/1992	B	MA12S

Short **MAGNETI MARELLI** Code



Model

Version		Fuel	Motor code
---------	--	------	------------

81744 350981744000



**FLANGIA**  
 Numero Fori Flangia 4  
 Dimensione Fori Flangia M6x1  
 Posizione Flangia 60.5  
 Diametro Mozzo Ø17.25

**GIRANTE**  
 Diametro Girante Ø58  
 N° Alette Girante 6  
 Distanza Girante 10.5

NISSAN

100 NX

16	03/1990→10/1994	B	GA16DS
1.6 SR	09/1993→10/1994	B	GA16DE

ALMERA I, Hatchback

14	09/1995→07/2000	B	GA14DE
1.4 GX,LX	09/1995→07/2000	B	GA14DE
1.4 S,GX,LX	09/1995→03/2000	B	GA14DE
16	09/1995→07/2000	B	GA16DE
1.6 SLX	09/1995→07/2000	B	GA16DE
1.6 SR,SLX	09/1995→03/2000	B	GA16DE

PRIMERA I

16	06/1990→01/1996	B	GA16DS
16	06/1990→01/1996	B	GA16DS
16	06/1993→01/1996	B	GA16DE
1.6 i	03/1994→03/1998	B	GA16DE
1.6 i	07/1990→03/1998	B	GA16DS

PRIMERA II

1.6 16V	06/1996→02/2011	B	QG16DE
1.6 16V	09/1996→02/2011	B	GA16DE
1.6 16V	09/1996→02/2011	B	GA16DE
1.6 Visia	04/1998→01/2011	B	QG16DE

SERENA I

16	10/1994→08/2000	B	GA16DE
1.6 16V	02/1993→	B	GA16DE

SUNNY III

14	10/1990→06/1995	B	GA14DS
1.4 i	10/1990→05/1995	B	GA14DE, GA14DS
1.4 i 16V	10/1990→06/1995	B	GA14DE
1.6 16V 4x4	11/1990→05/1995	B	GA16DS
1.6 i	10/1990→03/2000	B	GA16DE, GA16DS
1.6 i 16V	10/1992→03/2000	B	GA16DE
1.6 i 16V	10/1992→05/1995	B	GA16DE
1.6 i 16V 4WD	10/1990→05/1995	B	GA16DS
1.6 i 16V 4x4	10/1992→03/2000	B	GA16DE

MAGNETI MARELLI			
Short	Code		
<b>Model</b>			
Version		Fuel	Motor code
81744	350981744000		
<b>NISSAN</b>			
<b>SUNNY III</b>			
1.6 L	11/1992→04/1996	B	GA16DE
1.6 SR 4x4	01/1992→06/1995	B	GA16DEL
<b>VANETTE III, Cargo</b>			
1.6 i	01/1995→	B	GA16DE
1.6 i	01/1996→	B	GA16DE

MAGNETI MARELLI			
Short	Code		
81745	350981745000		
<b>FLANGIA</b>			
Numero Fori Flangia			4
Dimensione Fori Flangia			M6x1
Posizione Flangia			84.6
<b>GIRANTE</b>			
Diametro Girante			Ø70
N° Alette Girante			8
Distanza Girante			0.5

<b>NISSAN</b>			
<b>ALMERA I, Hatchback</b>			
2.0 D	11/1995→03/2000	D	CD20
<b>PRIMERA I</b>			
2.0 D	07/1990→01/1996	D	CD20
<b>PRIMERA II</b>			
2.0 TD	09/1996→02/2011	D	CD20T
<b>SUNNY III</b>			
2.0 D	10/1990→03/2000	D	CD20

MAGNETI MARELLI			
Short	Code		
81746	350981746000		
<b>FLANGIA</b>			
Numero Fori Flangia			4
Dimensione Fori Flangia			M6x1
Posizione Flangia			75
<b>GIRANTE</b>			
Diametro Girante			Ø70
N° Alette Girante			6
Distanza Girante			7

<b>OPEL</b>			
<b>ASTRA F, Station Wagon, Cabrio</b>			
1.7 TDS	12/1991→09/1998	D	17DT (TC4EE1), X17DT (TC4EE1)
<b>ASTRA G, Station Wagon, Cabrio</b>			
1.7 DTI 16V	02/2000→05/2011	D	Y17DT

MAGNETI MARELLI			
Short	Code		
<b>Model</b>			
Version		Fuel	Motor code
<b>COMBO I</b>			
1.7 D	07/1994→01/2011	D	17D (4EE1), X17D (4EE1)
<b>CORSA B, Station Wagon, Van</b>			
1.7 D	02/1996→09/2000	D	17D (4EE1), X17D (4EE1)
<b>VECTRA B, Station Wagon</b>			
1.7 TD	10/1995→12/1998	D	X17DT (TC4EE1)

MAGNETI MARELLI			
Short	Code		
81747	350981747000		
<b>FLANGIA</b>			
Numero Fori Flangia			3
Dimensione Fori Flangia			M8x1.25
Posizione Flangia			33
Diametro Mozzo			Ø30
<b>GIRANTE</b>			
Diametro Girante			Ø70
N° Alette Girante			8
Distanza Girante			52.3

<b>OPEL</b>			
<b>ASTRA G, Station Wagon, Cabrio</b>			
2.0 DI	02/1998→05/2011	D	X20DTL, Y20DTL
2.0 DTI 16V	08/1999→05/2011	D	X20DTH, Y20DTH
2.2 DTI	02/2011→05/2011	D	Y22DTR
<b>FRONTERA B</b>			
2.2 DTI	02/2011→	D	Y22DTH
2.2 DTI	10/1998→02/2011	D	X22DTH, Y22DTH
<b>OMEGA B, Station Wagon</b>			
2.0 DTI 16V	09/1997→09/2000	D	X20DTH
2.2 DTI 16V	09/2000→03/2011	D	Y22DTH
2.2 DTI 16V	09/2000→03/2011	D	Y22DTH
<b>SIGNUM</b>			
2.0 DTI	03/2011→	D	Y20DTH
2.2 DTI	03/2011→	D	Y22DTR
<b>SINTRA</b>			
2.2 DTI	07/1997→04/1999	D	X22DTH
<b>VECTRA B, Station Wagon</b>			
2.0 DI 16V	11/1996→02/2011	D	X20DTL
2.0 DTI 16V	06/1997→03/2011	D	X20DTH, Y20DTH
2.2 DTI 16V	09/2000→03/2011	D	Y22DTR
<b>VECTRA C, Station Wagon, GTS</b>			
2.0 DTI	03/2011→	D	Y20DTH
2.0 DTI 16V	02/2011→	D	Y20DTH
2.2 DTI	03/2011→	D	Y22DTR
2.2 DTI 16V	02/2011→	D	Y22DTR
<b>ZAFIRA A</b>			
2.0 DI 16V	10/1999→05/2011	D	X20DTL

Short Code			
MAGNETI MARELLI			
Model			
Version	Fuel	Motor code	
81747	350981747000		
<b>OPEL</b>			
<b>ZAFIRA A</b>			
2.0 DTI 16V	09/2000→05/2011	D	Y20DTH
2.2 DTI 16V	02/2011→05/2011	D	Y22DTR
<b>SAAB</b>			
<b>9-3 I, Cabrio</b>			
2.2 TiD	02/1998→11/2000	D	D223L, X22DTH
2.2 TiD	11/2000→02/2011	D	D223L
<b>9-3 II, 9-3 X, Station Wagon, Cabrio</b>			
2.2 TiD	02/2011→	D	D223L
<b>9-5 I, Station Wagon</b>			
2.2 TiD	02/2011→	D	D223L
<b>VAUXHALL</b>			
<b>ZAFIRA</b>			
2.0 GSI Turbo	01/2011→05/2011	B	Z20LET

81748 350981748000			
			
<b>FLANGIA</b> Numero Fori Flangia 4 Dimensione Fori Flangia M6x1 Posizione Flangia 75 <b>GIRANTE</b> Diametro Girante Ø64.5 N° Alette Girante 6 Distanza Girante 5.8			
<b>OPEL</b>			
<b>CORSA B, Station Wagon, Van</b>			
1.5 D	03/1993→09/2000	D	15D (4EC1)
1.5 TD	03/1993→09/2000	D	15DT (T4EC1), X15DT (T4EC1)
<b>VAUXHALL</b>			
<b>CORSA</b>			
1.5 D	03/1993→09/2000	D	15D
1.5 TD	03/1993→10/1996	D	15DT (T4EC1), X15DT (T4EC1)

Short Code			
MAGNETI MARELLI			
Model			
Version	Fuel	Motor code	
81749	350981749000		
			
<b>FLANGIA</b> Numero Fori Flangia 3 Dimensione Fori Flangia M8x1.25 Posizione Flangia 55.6 Diametro Mozzo Ø29.9 <b>GIRANTE</b> Diametro Girante Ø50 N° Alette Girante 8 Distanza Girante 21.45			
<b>OPEL</b>			
<b>AGILA A</b>			
1.0 12V	09/2000→	B	Z10XE
1.2 16V	09/2000→	B	Z12XE
<b>ASTRA G, Station Wagon, Cabrio</b>			
1.2 16V	02/1998→09/2000	B	X12XE
1.2 16V	09/2000→05/2011	B	Z12XE
<b>CORSA B, Station Wagon, Van</b>			
1.0 i 12V	11/1996→09/2000	B	X10XE
1.2 i 16V	03/1998→09/2000	B	X12XE
<b>CORSA C, Van</b>			
10	09/2000→	B	Z10XE
12	09/2000→	B	Z12XE
1.2 16V	09/2000→	B	Z12XE
<b>VAUXHALL</b>			
<b>CORSA</b>			
1.0 12V	09/2000→03/2011	B	Z10XE
1.0 i 12V	11/1996→09/2000	B	X10XE

81750 350981750000			
			
<b>FLANGIA</b> Numero Fori Flangia 4 Dimensione Fori Flangia M6x1 Posizione Flangia 75 <b>GIRANTE</b> Diametro Girante Ø64.5 N° Alette Girante 6 Distanza Girante 6.5			
<b>OPEL</b>			
<b>CORSA B, Station Wagon, Van</b>			
1.5 TD	03/1993→09/2000	D	15DT (T4EC1), X15DT (T4EC1)

Short	Code
-------	------



Model

Version		Fuel	Motor code
---------	--	------	------------

81751 350981751000



**PULEGGIA**

Diametro Puleggia Ø57.2  
 Numero Denti/Gole Puleggia 23  
 Altezza Puleggia 21  
 Posizione Puleggia 60.5

**GIRANTE**

Diametro Girante Ø56  
 N° Alette Girante 8  
 Distanza Girante 35.45

**OPEL**

**ASTRA G, Station Wagon, Cabrio**

1.8 16V	02/1998→10/2000	B	X18XE1
1.8 16V	09/2000→05/2011	B	Z18XE

**CORSA C, Van**

18	09/2000→	B	Z18XE
----	----------	---	-------

**MERIVA A**

18	03/2011→	B	Z18XE
----	----------	---	-------

**SIGNUM**

18	03/2011→	B	Z18XE
----	----------	---	-------

**TIGRA TwinTop**

18	04/2011→	B	Z18XE
----	----------	---	-------

**VECTRA B, Station Wagon**

1.8 i 16V	09/2000→03/2011	B	Z18XE
1.8 i 16V	10/1995→09/2000	B	X18XE1

**VECTRA C, Station Wagon, GTS**

18	02/2011→	B	Z18XEL
18	03/2011→	B	Z18XE
1.8 16V	02/2011→	B	Z18XE

**ZAFIRA A**

18	03/2011→05/2011	B	Z18XEL
1.8 16V	04/1999→09/2000	B	X18XE1
1.8 16V	09/2000→05/2011	B	Z18XE

**SAAB**

**9-3 II, 9-3 X, Station Wagon, Cabrio**

1.8 i	04/2011→	B	Z18XE
-------	----------	---	-------

**VAUXHALL**

**VECTRA**

1.8 16V	02/2011→08/2011	B	Z18XE
---------	-----------------	---	-------

Short	Code
-------	------



Model

Version		Fuel	Motor code
---------	--	------	------------

81752 350981752000



**PULEGGIA**

Diametro Puleggia Ø76  
 Numero Denti/Gole Puleggia 4  
 Posizione Puleggia 56.1

**GIRANTE**

Diametro Girante Ø79.5  
 Distanza Girante 29.25

**CITROËN**

**JUMPER I**

2.5 D	03/1994→02/2011	D	T9A (DJ5)
2.5 TD	03/1994→02/2011	D	T8A (DJ5T)

**XM II, Break**

2.5 TD	05/1994→10/2000	D	THY (DK5ATE)
--------	-----------------	---	--------------

**PEUGEOT**

**605**

2.5 Turbo Diesel	07/1994→09/1999	D	THY (DK5ATE)
------------------	-----------------	---	--------------

**BOXER I**

2.5 D	03/1994→02/2011	D	T9A (DJ5)
2.5 TD	03/1994→02/2011	D	T8A (DJ5T)

81753 350981753000



**PULEGGIA**

Diametro Puleggia Ø56.24  
 Numero Denti/Gole Puleggia 19  
 Altezza Puleggia 34  
 Posizione Puleggia 43

**GIRANTE**

Diametro Girante Ø53  
 N° Alette Girante 6  
 Distanza Girante 42.3

**CITROËN**

**BERLINGO I, Furgonato**

16	02/2011→	B	NFU (TU5JP4)
1.6 16V	10/2000→	B	NFU (TU5JP4)

**BERLINGO II, Furgonato**

16	08/2011→	B	NFR (TU5JP4B)
16	08/2011→	B	NFU (TU5JP4)

**C 2, Enterprise**

16	03/2011→	B	NFU (TU5JP4)
1.6 VTS	05/2011→	B	NFS (TU5JP4S)

**C 3, PICASSO, Pluriel**

16	03/2011→	B	NFU (TU5JP4)
----	----------	---	--------------

MAGNETI MARELLI			
Short	Code		
<b>Model</b>			
Version		Fuel	Motor code
<b>81753</b>	<b>350981753000</b>		
<b>CITROËN</b>			
<b>C 3, PICASSO, Pluriel</b>			
1.6 16V	02/2011→	B	NFU (TU5JP4)
C 4 I, Coupé			
1.6 16V	04/2011→	B	NFU (TU5JP4)
1.6 16V Bio-Flex	07/2011→	FF	NFU (TU5JP4)
<b>SAXO</b>			
1.6 VTS	06/1996→03/2011	B	NFX (TU5JP4)
<b>XSARA, Break, Coupé, PICASSO</b>			
1.6 16V	09/2000→05/2011	B	NFU (TU5JP4)
1.6 16V	09/2000→05/2011	B	NFU (TU5JP4)
<b>PEUGEOT</b>			
<b>1007</b>			
1.6 16V	05/2011→	B	NFU (TU5JP4)
<b>106 II</b>			
1.6 S16	05/1996→	B	NFX (TU5J4)
<b>206, Station Wagon, CC, Plus</b>			
1.6 16V	02/2011→	B	NFU (TU5JP4)
1.6 16V	09/2000→	B	NFU (TU5JP4)
<b>207, Station Wagon, CC</b>			
1.6 16V	06/2011→	B	NFU (TU5JP4)
<b>307, Break, CC</b>			
1.6 16V	08/2000→	B	NFU (TU5JP4)
<b>PARTNER - Ranch, I</b>			
16	09/2000→02/2011	B	
1.6 16V	01/2011→	B	NFU (TU5JP4)
<b>PARTNER - Ranch, II, Tepee</b>			
16	08/2011→	B	
16	08/2011→	B	

MAGNETI MARELLI			
Short	Code		
<b>81754</b>	<b>350981754000</b>		
<b>FLANGIA</b>			
Numero Fori Flangia	3		
Dimensione Fori Flangia	M8x1.25		
Posizione Flangia	74		
Diametro Centraggio	Ø51		
<b>GIRANTE</b>			
Diametro Girante	Ø69		
N° Alette Girante	9		
Distanza Girante	14.3		
<b>RENAULT</b>			
<b>21, Station Wagon, Van</b>			
2.0 Turbo	02/1990→10/1992	B	J7R756
2.0 Turbo 4x4	02/1990→10/1992	B	J7R756

MAGNETI MARELLI			
Short	Code		
<b>Model</b>			
Version		Fuel	Motor code
<b>21, Station Wagon, Van</b>			
2.0 Turbo 4x4	08/1989→10/1993	B	J7R752
<b>25</b>			
20	04/1984→12/1992	B	J6R706, J6R707, J6R760, J6R762, J6R763
<b>MASTER I</b>			
28-35 2.0	10/1986→07/1998	B	J5R718, J5R728

MAGNETI MARELLI			
Short	Code		
<b>81755</b>	<b>350981755000</b>		
<b>FLANGIA</b>			
Numero Fori Flangia	3		
Dimensione Fori Flangia	M8x1.25		
Posizione Flangia	63		
Diametro Mozzo	M24x1.5		
SX			
Diametro Centraggio	Ø54		
<b>GIRANTE</b>			
Diametro Girante	Ø69		
N° Alette Girante	9		
Distanza Girante	17		
<b>RENAULT</b>			
<b>25</b>			
2.1 Turbo-D	04/1984→12/1992	D	J8S708, J8S738

MAGNETI MARELLI			
Short	Code		
<b>81756</b>	<b>350981756000</b>		
<b>PULEGGIA</b>			
Diametro Puleggia	Ø147.2		
Numero Denti/Gole Puleggia	6		
Posizione Puleggia	40		
<b>GIRANTE</b>			
Diametro Girante	Ø67		
N° Alette Girante	8		
Distanza Girante	18		
<b>RENAULT</b>			
<b>RAPID, Express</b>			
10	02/1986→05/1992	B	
11	07/1985→04/1995	B	C1E750, C1E752, C1E754, C1E756, C1E760, C1E762, C1E792
12	09/1991→03/1998	B	C3G710, C3G712
14	07/1985→03/1998	B	C1J768, C1J780, C3J700, C3J702, C3J760, C3J762
1.4 RN	09/1991→08/1993	B	E6J734
<b>Super 5, Van</b>			
11	01/1986→03/1995	B	C1E750, C1E752, C1E756, C1E760
11	10/1984→12/1996	B	C1E750, C1E752, C1E754
12	01/1987→12/1996	B	

Short	Code
-------	------



Model			
Version		Fuel	Motor code
81756			350981756000
RENAULT			
Super 5, Van			
14	10/1984→12/1996	B	C1J768, C1J780, C3J700, C3J702, C3J760

81757	350981757000
-------	--------------



<b>FLANGIA</b>	
Numero Fori Flangia	3
Dimensione Fori Flangia	M8x1.25
Posizione Flangia	71.6
Diametro Centraggio	Ø51
<b>GIRANTE</b>	
Diametro Girante	Ø68
N° Alette Girante	8
Distanza Girante	18.6

RENAULT		
SAFRANE I		
2.1 dT	11/1993→07/1996	D J8S760

81758	350981758000
-------	--------------



<b>FLANGIA</b>	
Numero Fori Flangia	3
Dimensione Fori Flangia	M8x1.25
Posizione Flangia	73.3
Diametro Centraggio	Ø51
<b>GIRANTE</b>	
Diametro Girante	Ø68
N° Alette Girante	8
Distanza Girante	17.3

RENAULT		
SAFRANE I		
2.1 dT	11/1993→07/1996	D J8S760

Short	Code
-------	------



Model			
Version		Fuel	Motor code
81759			350981759000



<b>FLANGIA</b>	
Numero Fori Flangia	3
Dimensione Fori Flangia	M8x1.25
Posizione Flangia	74.5
Diametro Mozzo	Ø30
<b>GIRANTE</b>	
Diametro Girante	Ø68
N° Alette Girante	8
Distanza Girante	18.6

RENAULT			
SAFRANE I			
20	11/1992→07/1996	B	J7R732, J7R733
2.0 12V	04/1992→07/1996	B	J7R734, J7R735
22	04/1992→07/1996	B	J7T760, J7T761
22	04/1992→07/1996	B	J7T762
SAFRANE II			
2.0 16V	07/1996→12/2000	B	N7Q710, N7Q711

81760	350981760000
-------	--------------



<b>FLANGIA</b>	
Numero Fori Flangia	3
Dimensione Fori Flangia	M8x1.25
Posizione Flangia	98.9
Diametro Centraggio	Ø51
<b>GIRANTE</b>	
Diametro Girante	Ø60
N° Alette Girante	8
Distanza Girante	20.5

RENAULT			
LAGUNA I, GRANDtour			
2.2 D	11/1993→01/2011	D	G8T706, G8T752, G8T790, G8T794

Short **MAGNETI MARELLI** Code



Model

Version		Fuel	Motor code
---------	--	------	------------

81761 350981761000



**PULEGGIA**  
 Diametro Puleggia Ø56.24  
 Numero Denti/Gole Puleggia 19  
 Altezza Puleggia 36  
 Posizione Puleggia 50.2

**GIRANTE**  
 Diametro Girante Ø70  
 N° Alette Girante 6  
 Distanza Girante 22.3

RENAULT

ESPACE III

2.2 12V TD	11/1996→10/2000	D	G8T714, G8T716
2.2 D	11/1997→01/2000	D	G8T716

LAGUNA I, GRANDtour

2.2 dT	03/1996→01/2011	D	G8T760
--------	-----------------	---	--------

SAFRANE II

2.2 dT	07/1996→12/2000	D	G8T740
--------	-----------------	---	--------

81762 350981762000

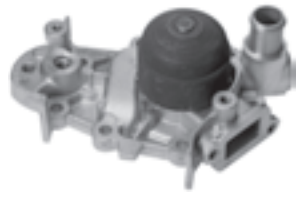

**PULEGGIA**  
 Diametro Puleggia Ø56.2  
 Altezza Puleggia 26  
 Posizione Puleggia 52.6

**GIRANTE**  
 Diametro Girante Ø60  
 N° Alette Girante 6  
 Distanza Girante 5

NISSAN

KUBISTAR			
12	03/2011→	B	D7F764

RENAULT

CLIO I, Van

12	01/1996→09/1998	B	D7F730
12	01/1996→09/1998	B	D7F730

CLIO II, Van

11	09/1998→	B	D7F720, D7F722
12	03/1999→03/2011	B	D7F722, D7F726
12	01/2011→03/2011	B	
12	09/1998→	B	D7F710, D7F720, D7F726

KANGOO I

12	07/1998→01/2011	B	D7F764
12	08/1997→	B	D7F710, D7F720, D7F722, D7F726, D7F744, D7F746

Short **MAGNETI MARELLI** Code



Model

Version		Fuel	Motor code
---------	--	------	------------

TWINGO I, Van

12	05/1996→	B	D7F700, D7F701
12	05/1996→	B	D7F700, D7F701, D7F702, D7F703, D7F704, D7F706
12	09/1998→08/2000	B	D7F702

81763 350981763000



**FLANGIA**  
 Numero Fori Flangia 4  
 Dimensione Fori Flangia M6x1  
 Posizione Flangia 114  
 Diametro Mozzo Ø25

**GIRANTE**  
 Diametro Girante Ø69  
 N° Alette Girante 8  
 Distanza Girante -1

SAAB

9000

2.0 -16 CD	09/1993→12/1998	B	B204E
2.0 -16 CD	09/1993→12/1998	B	B204I
2.0 -16 CS	09/1993→12/1998	B	B204I
2.0 -16 ND Turbo	09/1993→12/1998	B	B202S, B204E
2.0 -16 Turbo CD	09/1989→12/1998	B	B202L
2.0 -16 Turbo CD	09/1992→12/1998	B	B202S, B204E
2.0 -16 Turbo CS	09/1988→12/1998	B	B202L
2.3	09/1990→10/1998	B	B234R
2.3 -16 Aero CS	02/1993→12/1998	B	B234R
2.3 -16 Aero CS	02/1993→12/1998	B	B234R
2.3 -16 CD	08/1989→12/1998	B	B234I
2.3 -16 CD Turbo	07/1990→12/1998	B	B234L
2.3 -16 CDE	09/1993→12/1998	B	B234I
2.3 -16 CDE Eco-Power	09/1993→12/1998	B	B234E
2.3 -16 CS	09/1989→12/1998	B	B234I
2.3 -16 CSE	09/1993→12/1998	B	B234I
2.3 -16 CSE Eco Power	09/1993→12/1998	B	B234E
2.3 -16 Turbo	09/1990→12/1998	B	B234L
2.3 -16 Turbo CSE	09/1993→12/1998	B	B234L

Short **MAGNETI MARELLI** Code



Model

Version		Fuel	Motor code
---------	--	------	------------

81764 350981764000



**PULEGGIA**

Diametro Puleggia Ø131.8  
Altezza Puleggia 25  
Posizione Puleggia 104.9

**GIRANTE**

Diametro Girante Ø70  
N° Alette Girante 8  
Distanza Girante 6.9

**RENAULT**

**SAFRANE I**

3.0 Biturbo 4x4	02/1993→07/1996	B	Z7X726
3.0 V6	12/1992→07/1996	B	Z7X721, Z7X722, Z7X723
3.0 V6 4x4	12/1992→07/1996	B	Z7X721, Z7X722, Z7X723

**SAAB**

**900 II, Cabrio, Coupé**

2.0 -16 Turbo	07/1993→02/1998	B	B204L
2.0 i	07/1993→07/1994	B	B206I
2.0 i	12/1993→02/1998	B	B204I
2.3 -16	07/1993→02/1998	B	B234I

**9-3 I, Cabrio**

2.0 i	02/1998→03/2011	B	B204I
2.0 SE Turbo	02/1998→03/2011	B	B204R
2.0 Turbo	01/2011→03/2011	B	B205E
2.0 Turbo	02/1998→03/2011	B	B204L
2.0 Turbo	10/1998→03/2011	B	B204E
2.0 Turbo	10/1999→03/2011	B	B205R
23	09/1999→02/2011	B	B235R
2.3 i	02/1998→03/2011	B	B234I
2.3 Turbo	10/1998→03/2011	B	B235R

**9-5 I, Station Wagon**

20	07/2000→01/2011	B	B205L
2.0 t	09/1997→	B	B205E
2.0 t	10/1998→	B	B204R
2.0 T Biopower	05/2011→	B	
2.0 Turbo SE	10/1998→07/2000	B	
23	03/2011→05/2011	B	
2.3 t	01/2011→	B	B235E
2.3 t	09/1997→	B	B235E
2.3 Turbo	03/2011→	B	B235L
2.3 Turbo	01/2011→	B	B235R
2.3 Turbo	10/1999→01/2011	B	B235R
2.3 Turbo	05/2011→	B	B235R

Short **MAGNETI MARELLI** Code



Model

Version		Fuel	Motor code
---------	--	------	------------

81766 350981766000



**FLANGIA**

Numero Fori Flangia 4  
Dimensione Fori Flangia M6x1  
Posizione Flangia 76.5  
Diametro Mozzo Ø28

**GIRANTE**

Diametro Girante Ø58  
N° Alette Girante 7  
Distanza Girante 10

**TOYOTA**

**CARINA E (T19), Station Wagon**

16	01/1993→09/1997	B	4A-FE
16	12/1993→09/1997	B	4A-FE
16	12/1993→09/1997	B	4A-FE
1.6 GLI	04/1992→09/1997	B	4A-FE

**CELICA V, Cabrio, Coupé**

1.6 STI	10/1989→01/1994	B	4A-FE
---------	-----------------	---	-------

**COROLLA V, Station Wagon, Liftback, Compact**

1.6 GLI	07/1992→04/1997	B	4A-FE
1.6 Si	07/1992→04/1997	B	4A-FE

**COROLLA VI, Station Wagon, Liftback, Compact**

16	04/1997→02/2000	B	4A-FE
1.6 Aut.	04/1997→02/2000	B	4A-FE
1.6 Aut.	04/1997→02/2000	B	4A-FE

81767 350981767000



**FLANGIA**

Numero Fori Flangia 4  
Dimensione Fori Flangia M6x1  
Posizione Flangia 76.5  
Diametro Mozzo Ø28

**GIRANTE**

Diametro Girante Ø60  
N° Alette Girante 6  
Distanza Girante 8

**TOYOTA**



**AVENSIS I, Liftback, Station Wagon**

16	09/1997→10/2000	B	4A-FE
16	09/1997→10/2000	B	4A-FE

**CARINA E (T19), Station Wagon**



16	01/1993→09/1997	B	4A-FE
16	10/1995→09/1997	B	4A-FE
16	12/1993→09/1997	B	4A-FE
16	12/1993→09/1997	B	4A-FE



MAGNETI MARELLI			
Short	Code		
			
<b>Model</b>			
Version		Fuel	Motor code
81767	350981767000		
<b>TOYOTA</b>			
<b>CARINA E (T19), Station Wagon</b>			
1.6 16V	10/1995→09/1997	B	4A-FE
1.6 16V	12/1994→09/1997	B	4A-FE
1.6 GLI	04/1992→09/1997	B	4A-FE
1.6 i	02/1995→09/1997	B	4A-FE

81768 350981768000			
			
<b>FLANGIA</b>			
Numero Fori Flangia	4		
Dimensione Fori Flangia	M6x1		
Posizione Flangia	76.5		
Diametro Mozzo	Ø28		
<b>GIRANTE</b>			
Diametro Girante	Ø60		
N° Alette Girante	6		
Distanza Girante	8		
<b>TOYOTA</b>			
<b>AVENSIS I, Liftback, Station Wagon</b>			
18	09/1997→10/2000	B	7A-FE
<b>CARINA E (T19), Station Wagon</b>			
18	01/1995→09/1997	B	7A-FE
18	04/1992→09/1997	B	7A-FE
1.8 GL	10/1994→09/1997	B	
1.8 i	02/1995→09/1997	B	7A-FE
1.8 i 16V	01/1995→09/1997	B	7A-FE

81769 350981769000			
			
<b>FLANGIA</b>			
Numero Fori Flangia	4		
Dimensione Fori Flangia	M6x1		
Posizione Flangia	76.5		
Diametro Mozzo	Ø28		
<b>GIRANTE</b>			
Diametro Girante	Ø58		
N° Alette Girante	7		
Distanza Girante	10		
<b>TOYOTA</b>			
<b>AVENSIS I, Liftback, Station Wagon</b>			
18	09/1997→10/2000	B	7A-FE
<b>CARINA E (T19), Station Wagon</b>			
18	01/1995→09/1997	B	7A-FE
18	04/1992→09/1997	B	7A-FE
1.8 GL	10/1994→09/1997	B	

MAGNETI MARELLI			
Short	Code		
			
<b>Model</b>			
Version		Fuel	Motor code
<b>CARINA E (T19), Station Wagon</b>			
1.8 i 16V	01/1995→09/1997	B	7A-FE
<b>CELICA V, Cabrio, Coupé</b>			
1.8 i 16V	11/1993→11/1999	B	7A-FE
<b>COROLLA V, Station Wagon, Liftback, Compact</b>			
1.8 16V 4WD	09/1995→04/1997	B	7A-FE
1.8 GT	11/1992→05/1995	B	7A-FE
<b>COROLLA VI, Station Wagon, Liftback, Compact</b>			
1.8 AWD	04/1997→02/2011	B	7A-FE
1.8 LINEA TERRA	10/1997→01/2011	B	7A-FE

81770 350981770000			
			
<b>PULEGGIA</b>			
Diametro Puleggia	Ø56.8		
Numero Denti/Gole Puleggia	23		
Altezza Puleggia	29		
Posizione Puleggia	48		
<b>GIRANTE</b>			
Diametro Girante	Ø67		
N° Alette Girante	8		
Distanza Girante	17		
<b>TOYOTA</b>			
<b>AVENSIS I, Liftback, Station Wagon</b>			
20	09/1997→10/2000	B	3S-FE
<b>CAMRY III, Station Wagon</b>			
22	06/1991→08/1996	B	5S-FE
<b>CAMRY IV, Station Wagon</b>			
22	08/1996→01/2011	B	5S-FE
22	11/2000→01/2011	B	5S-FE
<b>CARINA E (T19), Station Wagon</b>			
18	04/1992→09/1997	B	7A-FE
20	01/1993→09/1997	B	3S-FE
2.0 GLI	04/1992→09/1997	B	3S-FE
2.0 GTi	04/1992→02/1994	B	3S-GE
2.0 GTi 16V	03/1994→09/1997	B	3S-GE
2.0 i	12/1992→09/1997	B	3S-FE
<b>PICNIC I</b>			
20	01/2011→01/2011	B	3S-FE
2.0 16V	05/1996→01/2011	B	3S-FE
<b>RAV 4 I</b>			
2.0 16V	06/1994→06/2000	B	3S-FE
2.0 16V	12/1997→06/2000	B	3S-FE

Short	Code
-------	------



Model

Version		Fuel	Motor code
81771		350981771000	



**PULEGGIA**

Diametro Puleggia Ø102  
 Numero Denti/Gole Puleggia 4  
 Posizione Puleggia 70.6

**GIRANTE**

Diametro Girante Ø55  
 N° Alette Girante 7  
 Distanza Girante 16.3

**TOYOTA**

**CARINA E (T19), Station Wagon**

1.5 SG 04/1992→09/1997 B

**COROLLA V, Station Wagon, Liftback, Compact**

1.3 XLI 07/1992→04/1997 B 4E-FE

1.3 XLI 09/1995→04/1997 B 4E-FE

1.3 XLI 16V 07/1992→09/1995 B 4E-FE

**COROLLA VI, Station Wagon, Liftback, Compact**

14 01/04/97→02/2000 B 4E-FE

**PASEO II, Cabrio**

1.5 16V 01/08/95→07/1999 B 5E-FE

**STARLET IV**

13 01/04/96→03/1999 B 4E-FE

81772 350981772000



**PULEGGIA**

Diametro Puleggia Ø53.05  
 Numero Denti/Gole Puleggia 18  
 Altezza Puleggia 28  
 Posizione Puleggia 60.4

**GIRANTE**

Diametro Girante Ø72  
 N° Alette Girante 7  
 Distanza Girante 33

**VOLKSWAGEN**

**TRANSPORTER IV**

2.4 D 07/1990→04/1998 D AAB

2.4 D Syncro 10/1992→09/1998 D AAB

25 11/1990→03/2011 B AAF, ACU, AEN, AEU

2.5 Syncro 10/1992→03/2011 B AAF, ACU, AEN, AEU

Short	Code
-------	------



Model

Version		Fuel	Motor code
81773		350981773000	



**FLANGIA**

Numero Fori Flangia 3  
 Dimensione Fori Flangia M8x1.25  
 Posizione Flangia 31.6  
 Diametro Mozzo Ø30

**GIRANTE**

Diametro Girante Ø65  
 N° Alette Girante 8  
 Distanza Girante 63

**FORD**

**GALAXY I**

2.8 i V6 11/1995→04/2000 B AAA, AMY

2.8 i V6 4x4 04/1996→04/2000 B AAA, AMY

2.8 V6 04/2000→06/2011 B AYL

**MERCEDES-BENZ**

**cl. V**

V 280 08/1997→03/2011 B M104.900

**SEAT**

**LEON I**

2.8 Cupra 4 01/2011→06/2011 B AUE

**VOLKSWAGEN**

**BORA, Station Wagon**

2.8 V6 4motion 03/1999→05/2011 B AQP, AUE, BDE

**CORRADO**

2.9 VR6 08/1991→12/1995 B ABV

**GOLF III, Cabrio, Variant**

2.8 VR6 01/1992→08/1997 B AAA

2.9 VR6 10/1994→04/1999 B ABV

2.9 VR6 Syncro 10/1994→04/1999 B ABV

**GOLF IV, Cabrio, Variant**

2.8 V6 4motion 03/1999→06/2011 B AQP, AUE, BDE

**PASSAT III, Variant**

2.8 CL Syncro 10/1994→12/1995 B AHA

2.8 VR6 06/1991→05/1997 B AAA

2.9 VR6 Syncro 01/1994→05/1997 B ABV

**SHARAN I**

2.8 V6 24V 04/2000→ B AYL

2.8 V6 24V 4motion 04/2000→ B AYL

2.8 VR6 09/1995→04/2000 B AAA, AMY

2.8 VR6 Syncro 11/1996→04/2000 B AAA, AMY

**TRANSPORTER IV**

28 05/1996→05/2000 B AES

2.8 Syncro 01/1996→04/1996 B AES

2.8 V6 04/2000→03/2011 B AMV

Short **MAGNETI MARELLI** Code



**Model**

Version		Fuel	Motor code
81773	350981773000		
<b>VOLKSWAGEN</b>			
<b>TRANSPORTER IV</b>			
2.8 VR 6	11/1995→04/2000	B AES	
<b>VENTO</b>			
2.8 VR6	01/1992→09/1998	B AAA	
2.8 VR6	08/1995→04/1996	B AAA	

81774 350981774000

	<b>FLANGIA</b>	
	Numero Fori Flangia	4
	Dimensione Fori Flangia	M6x1
	Posizione Flangia	80
	Diametro Mozzo	M30x1.5
	SX	
	Diametro Centraggio	Ø35
	<b>GIRANTE</b>	
	Diametro Girante	Ø76
	N° Alette Girante	4
	Distanza Girante	15.4

**MERCEDES-BENZ**

**SPRINTER I (904)**

408 D	02/1996→06/2011	D OM601.943
414	02/1996→06/2011	B M111.979, M111.984
414 4x4	05/1997→06/2011	B M111.979, M111.984

**SPRINTER II (905)**

208 D	01/1995→04/2000	D OM601.943
208 D	09/1996→04/2000	D
208 D	10/1996→04/2000	D
214	02/1995→06/2011	B M111.979, M111.984
214 NGT	04/2000→06/2011	G
214 NGT	04/2000→06/2011	G M111.984
308 D	02/1995→04/2000	D OM601.943
308 D 2.3	02/1995→04/2000	D OM601.943
308 D 2.3	11/1996→04/2000	D
314	02/1995→06/2011	B M111.979, M111.984
314 4x4	02/2011→06/2011	B M111.979, M111.984
314 NGT	04/2000→06/2011	G M111.984
314 NGT	04/2000→06/2011	G

**VOLKSWAGEN**

**LT II**

23	05/1996→06/2011	B AGL
----	-----------------	-------

Short **MAGNETI MARELLI** Code



**Model**

Version		Fuel	Motor code
81775	350981775000		

81775 350981775000

	<b>PULEGGIA</b>	
	Diametro Puleggia	Ø67.3
	Numero Denti/Gole Puleggia	27
	Altezza Puleggia	20.7
	Posizione Puleggia	50.8
	<b>GIRANTE</b>	
	Diametro Girante	Ø63.6
	N° Alette Girante	8
	Distanza Girante	41

**SEAT**

**AROSA**

10	05/1997→04/2011	B AER, ALD, ALL, ANV, AUC
14	05/1997→04/2011	B AEX, AKK, AKV, ANW, APQ, AUD

**CORDOBA I, Vario**

1.0 CL	02/1993→06/1996	B AAU
1.0 i	09/1996→06/1999	B AER

**CORDOBA II, Vario**

10	06/1999→02/2011	B ALD, ANV, AUC
14	06/1999→02/2011	B AKK, ANW, AUD

**IBIZA II**

1.0 i	09/1996→08/1999	B AER
-------	-----------------	-------

**IBIZA III**

10	08/1999→02/2011	B ALD, ANV, AUC
14	08/1999→02/2011	B AKK, ANW, AUD

**VOLKSWAGEN**

**LUPO**

10	09/1998→05/2011	B AER, ALD, ALL, ANV, AUC
14	10/2000→05/2011	B AUD

**POLO III, Classic, Variant, Van**

10	08/1996→01/2011	B AER, ALD, AUC
14	05/1997→01/2011	B AEX, AKK, AKV, ANW, APQ, AUD
14	12/1998→01/2011	B AKP
50 1.0	09/1996→10/1999	B AER, ALL
60 1.4	12/1995→01/2011	B AEX, AKK, AKV, ANW, APQ, AUD

**POLO IV**

10	08/1996→01/2011	B AER
----	-----------------	-------

Short **MAGNETI MARELLI** Code



Model

Version		Fuel	Motor code
---------	--	------	------------

81776 350981776000



**PULEGGIA**

Diametro Puleggia Ø67.3  
 Numero Denti/Gole Puleggia 27  
 Altezza Puleggia 27  
 Posizione Puleggia 56.8

**GIRANTE**

Diametro Girante Ø63.6  
 N° Alette Girante 8  
 Distanza Girante 40.5

SEAT

**CORDOBA I, Vario**

1.4 i 16V 09/1996→06/1999 B AFH

**CORDOBA II, Vario**

1.0 16V 05/2000→02/2011 B AST, AVZ

**IBIZA III**

1.0 16V 05/2000→02/2011 B AST, AVZ

VOLKSWAGEN

**POLO III, Classic, Variant, Van**

100 1.4 16V 04/1996→10/1999 B AFH

81777 350981777000



**PULEGGIA**

Diametro Puleggia Ø67.3  
 Numero Denti/Gole Puleggia 27  
 Altezza Puleggia 21  
 Posizione Puleggia 55.4

**GIRANTE**

Diametro Girante Ø63.6  
 N° Alette Girante 8  
 Distanza Girante 41

AUDI

**A2**

14 02/2000→05/2011 B AUA, BBY

SEAT

**ALTEA, ALTEA XL**

14 06/2011→ B BXW

1.4 16V 06/2011→ B BXW

**AROSA**

1.4 16V 01/2000→04/2011 B AFK, ANM, AQQ, AUB

**CORDOBA II, Vario**

1.4 16V 02/2000→02/2011 B AQQ, AUB

1.4 16V 06/1999→02/2011 B APE, AUA

**CORDOBA III, Vario**

1.4 16V 02/2011→ B BBY

Short **MAGNETI MARELLI** Code



Model

Version		Fuel	Motor code
---------	--	------	------------

**CORDOBA III, Vario**

1.4 16V 02/2011→ B BBZ

**IBIZA III**

1.4 16V 05/2000→02/2011 B APE, AUA

1.4 16V 08/1999→02/2011 B AQQ, AUB

**IBIZA IV**

1.4 16V 02/2011→ B AUB, BBZ

1.4 16V 02/2011→07/2011 B BBY

**IBIZA V, SportCoupé, ST**

14 08/2011→ B BXW, CGGB

16 08/2011→ B BTS

**INCA**

1.4 16V 04/2000→03/2011 B AUA

**LEON I**

1.4 16V 11/1999→06/2011 B AHW, APE, AXP, BCA

**LEON II**

1.4 16V 06/2011→ B BXW

1.4 16V 05/2011→ B BCA

**TOLEDO II**

1.4 16V 07/1999→06/2011 B AHW, AXP

SKODA

**FABIA I, Station Wagon**

1.4 16V 04/2000→07/2011 B AUB, BBZ

1.4 16V 06/2011→07/2011 B BUD

1.4 16V 10/1999→08/2011 B AUA, BBY, BKY

1.4 16V 12/1999→08/2011 B AUB, BBZ

**FABIA II, Station Wagon**

14 07/2011→ B BXW

**OCTAVIA I, Station Wagon**

1.4 16V 08/2000→ B AXP, BCA

**OCTAVIA II, Station Wagon**

14 04/2011→ B BCA

14 04/2011→ B BUD

**PRAKTIK**

14 07/2011→ B BXW

**ROOMSTER**

14 06/2011→ B BXW

VOLKSWAGEN

**BORA, Station Wagon**

1.4 16V 03/2000→05/2011 B AHW, AKQ, APE, AXP, BCA

**CADDY II**

14 08/2000→04/2011 B AUA

1.4 16V 08/2000→04/2011 B AUA

**CADDY III**

14 04/2011→ B BCA

MAGNETI MARELLI			
Short	Code		
<b>Model</b>			
Version		Fuel	Motor code
<b>81777</b>	<b>350981777000</b>		
<b>VOLKSWAGEN</b>			
<b>CADDY III</b>			
1.4 16V	06/2011→	B	BUD
<b>GOLF IV, Cabrio, Variant</b>			
1.4 16V	08/1997→06/2011	B	AHW, AKQ, APE, AXP, BCA
<b>GOLF V, Plus, Variant</b>			
14	07/2011→	B	BUD
1.4 16V	05/2011→	B	BUD
1.4 16V	03/2011→	B	BCA
<b>GOLF VI, Variant</b>			
14	08/2011→	B	BUD, CGGA
<b>LUPO</b>			
1.4 16V	08/1999→05/2011	B	AFK, ANM, AQQ, AUB
1.4 16V	09/1998→05/2011	B	AHW, AKQ, APE, AUA, BBY
1.4 FSI	01/2011→05/2011	B	ARR
<b>NEW BEETLE, Cabrio</b>			
14	01/2011→	B	BCA
<b>POLO III, Classic, Variant, Van</b>			
1.4 16V	10/1999→01/2011	B	AFK, AQQ, AUB
1.4 16V	10/1999→01/2011	B	AHW, APE, AUA
75 1.4 16V	10/1999→01/2011	B	APE, AUA
<b>POLO IV</b>			
14	03/2011→	B	BBY
14	03/2011→	B	BBZ
1.4 16V	06/2011→	B	BUD
1.4 16V	01/2011→08/2011	B	AUB, BBZ
1.4 16V	01/2011→08/2011	B	AUA, BBY, BKY
<b>POLO V</b>			
14	09/2011→	B	CGGB
<b>81779 350981779000</b>			
		<b>PULEGGIA</b> Diametro Puleggia Ø62.3 Numero Denti/Gole Puleggia 14 Altezza Puleggia 31.5 Posizione Puleggia 59.1  <b>GIRANTE</b> Diametro Girante Ø71 N° Alette Girante 7 Distanza Girante 21	
<b>VOLVO</b>			
<b>S80 I</b>			
2.8 T6	05/1998→06/2011	B	B6284T
29	03/1999→06/2011	B	B6294S

MAGNETI MARELLI			
Short	Code		
<b>Model</b>			
Version		Fuel	Motor code
<b>S80 I</b>			
29	05/1998→06/2011	B	B6304S3
30	01/2011→06/2011	B	B6294S2
3.0 T6	01/2011→06/2011	B	B6294T
<b>81780 350981780000</b>			
		<b>PULEGGIA</b> Diametro Puleggia Ø56.3 Numero Denti/Gole Puleggia 19 Altezza Puleggia 29.5 Posizione Puleggia 68  <b>GIRANTE</b> Diametro Girante Ø55 N° Alette Girante 11 Distanza Girante 35.6	
<b>DAEWOO</b>			
<b>ESPERO</b>			
1.5 16V	02/1995→06/1999	B	A15MF
1.5 16V	10/1993→09/1994	B	
<b>LANOS</b>			
1.6 16V	05/1997→	B	A16DMS
<b>NEXIA</b>			
1.5 16V	02/1995→08/1997	B	A15MF
<b>81781 350981781000</b>			
		<b>PULEGGIA</b> Diametro Puleggia Ø56.3 Numero Denti/Gole Puleggia 19 Altezza Puleggia 20 Posizione Puleggia 58.5  <b>GIRANTE</b> Diametro Girante Ø55 N° Alette Girante 11 Distanza Girante 35.6	
<b>CHEVROLET</b>			
<b>AVEO</b>			
15	05/2011→	B	F15S3
<b>KALOS</b>			
12	05/2011→	B	B12S1
<b>DAEWOO</b>			
<b>KALOS</b>			
12	03/2011→	B	
14	02/2011→	B	
<b>LANOS</b>			
14	05/1997→	B	A14SMS

Short	Code
-------	------



Model			
Version		Fuel	Motor code
81781			350981781000
<b>DAEWOO</b>			
<b>KALOS</b>			
15	05/1997→	B	A15SMS

Short	Code
-------	------



<b>PULEGGIA</b>	
Diametro Puleggia	Ø56.3
Numero Denti/Gole Puleggia	19
Altezza Puleggia	29.5
Posizione Puleggia	68
<b>GIRANTE</b>	
Diametro Girante	Ø55
N° Alette Girante	11
Distanza Girante	35.6

<b>CHEVROLET</b>			
<b>AVEO</b>			
14	06/2011→	B	F14D3
16	04/2011→06/2011	B	A16DMS
<b>KALOS</b>			
14	05/2011→	B	F14S3
1.4 16V	05/2011→	B	F14D3
<b>LACETTI</b>			
1.4 16V	05/2011→	B	F14D3
16	05/2011→	B	F16D3
18	05/2011→	B	T18SED
18	05/2011→	B	F18D3
<b>NUBIRA, Station Wagon</b>			
14	05/2011→	B	F14D3
16	05/2011→	B	F16D3
18	05/2011→	B	T18SED
18	05/2011→	B	F18D3
<b>REZZO</b>			
16	05/2011→	B	A16DMS
16	05/2011→	B	A16DMS
<b>DAEWOO</b>			
<b>KALOS</b>			
1.4 16V	03/2011→	B	F14D3
<b>LACETTI III</b>			
14	04/2011→	B	F14D3
16	04/2011→	B	F16D3
<b>NUBIRA I, Station Wagon</b>			
1.6 16V	05/1997→	B	A16DMS
1.6 16V	06/1997→	B	
1.6 16V	07/2000→	B	A16DMS

Short	Code
-------	------



Model			
Version		Fuel	Motor code
<b>NUBIRA II, Station Wagon</b>			
16	03/2011→	B	F16D3
18	03/2011→	B	T18SED
<b>REZZO</b>			
16	09/2000→	B	A16DMS
1.6 SX	01/2011→04/2011	B	

Short	Code
-------	------



<b>PULEGGIA</b>	
Diametro Puleggia	Ø54.66
Numero Denti/Gole Puleggia	22
Altezza Puleggia	28
Posizione Puleggia	58.9
<b>GIRANTE</b>	
Diametro Girante	Ø58
N° Alette Girante	7
Distanza Girante	3.75

<b>CHEVROLET</b>			
<b>AVEO</b>			
12	06/2011→	B	F12S3
<b>KALOS</b>			
12	05/2011→	B	F12S3
<b>MATIZ</b>			
8	05/2011→	B	F8CV
0.8 LPG	05/2011→	B	F8CV
10	05/2011→	B	B10S
10	05/2011→	B	B10S1
1.0 LPG	05/2011→	B	B10S1
<b>SPARK I</b>			
8	09/2000→	B	F8CV
10	02/2011→	B	G10CV
<b>SPARK II</b>			
8	05/2011→	B	F8CV
1.0 SX	05/2011→	B	
<b>DAEWOO</b>			
<b>MATIZ</b>			
8	09/1998→	B	F8CV
10	03/2011→	B	
<b>TICO</b>			
8	01/1996→12/2000	B	F8CV
8	02/1995→12/2000	B	F8C
<b>SUZUKI</b>			
<b>CAPPUCINO</b>			
7	02/1992→08/1995	B	F6A

Short Code



Model

Version		Fuel	Motor code
---------	--	------	------------

81784 350981784000



**FLANGIA**  
 Numero Fori Flangia 4  
 Dimensione Fori Flangia M6x1  
 Posizione Flangia 92.5  
 Diametro Mozzo Ø20

**GIRANTE**  
 Diametro Girante Ø54.5  
 N° Alette Girante 6  
 Distanza Girante -1

HYUNDAI

ACCENT II

13	10/1994→01/2000	B	G4EH
13	10/1994→01/2000	B	G4EH
1.3 i 12V	10/1994→01/2000	B	G4EH
1.5 i 12V	10/1994→01/2000	B	G4EK

ACCENT III

13	01/2000→	B	G4E-A
13	01/2000→	B	
13	01/2000→	B	G4E-A
13	02/2011→	B	

GETZ

13	02/2011→	B	G4E-A
13	03/2011→	B	G4E-A

LANTRA I

1.5 i.e.	10/1990→11/1995	B	G15B, G4DJ
----------	-----------------	---	------------

LANTRA II, Station Wagon

1.5 12V	12/1996→09/2000	B	G4EK
---------	-----------------	---	------

PONY III, Excel

13	10/1989→01/1995	B	G4DG
13	10/1989→01/1995	B	
15	10/1989→01/1995	B	G15B, G4DJ
1.5 i	10/1989→01/1995	B	G15B, G4DJ
1.5 i	10/1989→01/1995	B	G15B, G4DJ

S Coupé

1.5 GS	03/1990→12/1992	B	
1.5 i	02/1990→05/1996	B	G15B, G4DJ
1.5 i	04/1992→05/1996	B	G4EK
1.5 i Turbo	04/1991→05/1996	B	G4EK-TC

MITSUBISHI

COLT III

13	04/1988→05/1992	B	
1.3 12V	04/1988→05/1992	B	4G13 (12V)
15	07/1990→05/1992	B	4G15
1.5 GLXi	04/1988→05/1992	B	4G15

Short Code



Model

Version		Fuel	Motor code
---------	--	------	------------

COLT IV

1.3 GLi 12V	04/1992→04/1996	B	4G13 (BJ92-.,12V)
-------------	-----------------	---	-------------------

COLT V

1500	11/1995→05/2011	B	4G15 (16V)
------	-----------------	---	------------

LANCER III

1.3 GL	07/1990→08/1992	B	4G13 (12V)
--------	-----------------	---	------------

1.5 GLS	08/1989→08/1992	B	
---------	-----------------	---	--

LANCER IV

1.2 GL	05/1988→08/1992	B	4G16
--------	-----------------	---	------

13	04/1988→05/1992	B	4G13
----	-----------------	---	------

13	08/1988→05/1992	B	G13B
----	-----------------	---	------

1.3 12V	07/1990→05/1994	B	4G13 (12V)
---------	-----------------	---	------------

1.3 GL	07/1990→05/1992	B	4G13 (12V)
--------	-----------------	---	------------

1.3 GL	07/1990→07/1993	B	4G13 (12V)
--------	-----------------	---	------------

15	04/1988→05/1992	B	4G15
----	-----------------	---	------

15	06/1988→05/1992	B	4G15
----	-----------------	---	------

1.5 12V	05/1989→05/1992	B	4G15 (12V)
---------	-----------------	---	------------

1.5 GLS	08/1989→08/1992	B	4G15 (12V)
---------	-----------------	---	------------

LANCER V, Station Wagon, Coupé

13	06/1992→	B	4G13 (BJ92-.,12V)
----	----------	---	-------------------

13	06/1992→02/1995	B	4G13 (12V)
----	-----------------	---	------------

LANCER VI, Station Wagon, Coupé

1.5 16V	12/1995→03/2011	B	4G15 (16V)
---------	-----------------	---	------------

SPACE STAR

1.3 16V	06/1998→	B	4G13 (16V)
---------	----------	---	------------

1.3 16V	09/2000→	B	4G13 (16V)
---------	----------	---	------------

1.3 16V	12/1998→	B	4G13 (16V)
---------	----------	---	------------

81785 350981785000



**FLANGIA**  
 Numero Fori Flangia 4  
 Dimensione Fori Flangia M6x1  
 Posizione Flangia 86.5  
 Diametro Mozzo Ø23.9

**GIRANTE**  
 Diametro Girante Ø63  
 N° Alette Girante 6  
 Distanza Girante 6

HYUNDAI

Coupé I

1.6 16V	03/1998→02/2011	B	G4GR
---------	-----------------	---	------

1.6 i 16V	12/1996→02/2011	B	4G61
-----------	-----------------	---	------

20	08/1999→02/2011	B	G4DF
----	-----------------	---	------

2.0 16V	01/2011→02/2011	B	G4DF
---------	-----------------	---	------

2.0 16V	08/1996→02/2011	B	G4GF
---------	-----------------	---	------



MAGNETI MARELLI			
Short	Code		
<b>Model</b>			
Version		Fuel	Motor code
81785	350981785000		
<b>HYUNDAI</b>			
<b>Coupé II</b>			
20	02/2011→	B	G4GC-G
20	01/2011→	B	G4GC-G
2.0 GLS	03/2011→	B	G4GC-G
<b>ELANTRA I</b>			
18	06/2000→	B	G4BB
20	06/2000→	B	G4GC-G
20	06/2000→	B	G4GC
20	03/2011→	B	G4GC
<b>ELANTRA II</b>			
2.0 CVVT	06/2011→	B	G4GC
<b>i 30, Station Wagon</b>			
20	07/2011→	B	G4GC-G
<b>LANTRA I</b>			
1.6 i.e. 16V	10/1990→11/1995	B	G4CR
1.6 i.e. 16V	10/1990→11/1995	B	G4CR
<b>LANTRA II, Station Wagon</b>			
1.6 16V	11/1995→09/2000	B	4G61
1.6 i	11/1995→09/2000	B	G4GR
1.8 16V	11/1995→09/2000	B	G4GM
2.0 16V	08/1996→09/2000	B	G4GF
<b>MATRIX</b>			
18	01/2011→	B	G4GB-G
<b>TIBURON</b>			
2.0 CVVT	06/2011→	B	G4GC
<b>TRAJET</b>			
20	04/2011→	B	G4GC-G
20	03/2011→	B	G4GC
<b>TUCSON</b>			
20	04/2011→	B	G4GC
2.0 4 ruote motrici	04/2011→	B	G4GC
<b>KIA</b>			
<b>CARENS II</b>			
2.0 CVVT	04/2011→	B	G4GC
<b>Cee'D, Station Wagon, Pro Cee'D</b>			
20	06/2011→	B	G4GC
<b>CERATO I, Station Wagon</b>			
20	04/2011→	B	G4GC
<b>SPORTAGE II</b>			
2.0 16V	04/2011→	B	G4GC
2.0 16V 4WD	04/2011→	B	G4GC



MAGNETI MARELLI			
Short	Code		
<b>Model</b>			
Version		Fuel	Motor code
81786	350981786000		
<b>HYUNDAI</b>			
<b>LANTRA I</b>			
1.8 i.e. 16V	10/1990→11/1995	B	G4CN
<b>SONATA I</b>			
2.0 i 16V	01/1991→10/1993	B	G4CP-D
<b>SONATA II</b>			
2.0 i 16V	05/1993→06/1998	B	G4CP-D
2.0 i 16V	06/1996→06/1998	B	G4CP-DM
<b>KIA</b>			
<b>Joice</b>			
20	02/2000→	B	
20	01/2011→	B	
<b>MITSUBISHI</b>			
<b>COLT III</b>			
1.8 GTi 16V	06/1990→05/1992	B	4G67
<b>ECLIPSE I, Cabrio</b>			
2.0 i 16V	04/1991→11/1995	B	4G63
2.0 i 16V 4x4	04/1991→11/1995	B	4G63
<b>GALANT IV, Station Wagon</b>			
2.0 GTi 16V	11/1987→10/1992	B	4G63
2.0 GTi 16V	11/1988→10/1992	B	4G63
2.0 GTi 16V 4x4	06/1988→12/1992	B	4G63
2.0 GTi 16V 4x4 Cat.	09/1991→10/1992	B	4G63
<b>LANCER IV</b>			
1.8 GTi 16V	11/1989→05/1992	B	4G67
<b>SANTAMO</b>			
2.0 16V	05/1999→	B	
2.0 16V 4x4	05/1999→	B	



<b>FLANGIA</b>	
Numero Fori Flangia	4
Dimensione Fori Flangia	M6x1
Posizione Flangia	92
Diametro Mozzo	Ø23.9
<b>GIRANTE</b>	
Diametro Girante	Ø75
N° Alette Girante	8
Distanza Girante	-1



MAGNETI MARELLI			
Short	Code		
			
Model			
Version		Fuel	Motor code
81787	350981787000		
		<p><b>FLANGIA</b>            Numero Fori Flangia 4            Dimensione Fori Flangia M6x1            Posizione Flangia 130            Diametro Mozzo Ø23.9</p> <p><b>GIRANTE</b>            Diametro Girante n.v.            N° Alette Girante n.v.            Distanza Girante n.v.</p>	
HYUNDAI			
Galloper I			
2.5 TD	08/1991→07/1998	D	4D56T
2.5 TD intercooler	08/1991→07/1998	D	4D56T
Galloper II			
2.5 Tci D	08/1998→	D	D4BH
H - 1 I			
2.5 D	10/1997→	D	D4BB
2.5 TD	10/1997→	D	D4BF
H - 100			
2.5 D	07/1993→12/1994	D	D4BA, D4BX
2.5 D	12/1994→03/2000	D	D4BB
2.5 TD	07/1993→03/2000	D	D4BF
STAREX			
2.5 TD	06/1997→	D	D4BF
2.5 TD 4WD	02/1998→	D	D4BF
MITSUBISHI			
L 200 II			
2.5 D	11/1986→08/1996	D	4E+56
2.5 D 4WD	12/1987→05/1993	D	4E+56
L 200 III			
2.5 D	06/1996→	D	4E+56
L 300 I			
2.5 D	11/1986→04/1994	D	4E+56
L 300 II			
2.5 D	11/1986→	D	4E+56
2.5 D	11/1994→	D	4D56T
2.5 TD	02/1987→03/2011	D	4D56T
2.5 TD 4WD	11/1988→	D	4D56T
L 400 I			
2500 TD	06/1996→	D	4D56T
2500 TD 4x4	09/1996→	D	4D56T
SPACE GEAR			
2.5 TD	05/1995→05/2000	D	4D56TD
2.5 TD 4x4	05/1995→05/2000	D	4D56TD

MAGNETI MARELLI			
Short	Code		
			
Model			
Version		Fuel	Motor code
81788	350981788000		
		<p><b>FLANGIA</b>            Numero Fori Flangia 4            Dimensione Fori Flangia M6x1            Posizione Flangia 100.5</p> <p><b>GIRANTE</b>            Diametro Girante Ø70            N° Alette Girante 7            Distanza Girante -2</p>	
HYUNDAI			
H - 1 I			
24	10/1997→	B	G4CS
2.4 4WD	10/1997→	B	G4CS
H - 100			
24	01/1997→03/2000	B	G4CS
24	07/1993→03/2000	B	G4CS
SONATA II			
3.0 i V6	05/1993→06/1998	B	G6AT
STAREX			
24	06/1997→	B	G4CS
2.4 4WD	02/1998→	B	G4CS
MITSUBISHI			
L 300 II			
20	06/1994→08/1995	B	4G63
20	06/1994→04/2000	B	4G63
20	07/1994→	B	4G63
20	11/1986→	B	4G63
20	11/1986→	B	G63B
2.0 4WD	11/1986→	B	4G63
2.0 4WD	12/1986→	B	4G63
2.0 4x4	06/1994→03/2011	B	4G63
2.0 GLS	06/1994→05/1996	B	4G63
24	09/1997→03/2011	B	4G64
24	11/1986→08/1997	B	4G64, G64B
2.4 4WD	11/1990→	B	4G64
2.4 4x4	11/1986→08/1997	B	G64B
2.4 GLX 4x4	11/1986→08/1997	B	4G64
Pajero II			
24	04/1991→04/2000	B	4G64

Short	Code
-------	------



Model

Version		Fuel	Motor code
---------	--	------	------------

81789 350981789000



FLANGIA	
Numero Fori Flangia	4
Dimensione Fori Flangia	M6x1
Posizione Flangia	79
Diametro Mozzo	Ø24
GIRANTE	
Diametro Girante	Ø60
N° Alette Girante	7
Distanza Girante	9.5

SUZUKI

JIMNY

1.3 16V	09/1998→	B	G13BB
1.3 16V 4WD	09/1998→	B	G13BB
1.3 4x4	09/1998→08/2000	B	G13BB

SAMURAI

13	11/1988→	B	G13BA
13	11/1988→	B	G13A
13	11/1988→	B	G13A

81790 350981790000



FLANGIA	
Numero Fori Flangia	4
Dimensione Fori Flangia	M6x1
Posizione Flangia	79.8
Diametro Mozzo	Ø24
GIRANTE	
Diametro Girante	Ø58.5
N° Alette Girante	7
Distanza Girante	9

SUZUKI

BALENO, Station Wagon

1.6 i 16V	07/1995→02/2011	B	G16B
1.6 i 16V 4x4	07/1995→02/2011	B	G16B
1.8 GT	03/1996→02/2011	B	J18A
1.8 i 16V	08/1996→02/2011	B	J18A

SWIFT II, Cabrio

1.6 i	01/1990→01/2011	B	G16B
1.6 i 4WD	01/1990→01/2011	B	G16B

VITARA, Cabrio

16	07/1988→03/1998	B	G16A
1.6 16V	07/1990→03/1999	B	G16B
2.0 V6 24V	12/1994→03/1998	B	H20A

X-90

1.6 i 16V	09/1995→	B	G16B
-----------	----------	---	------

Short	Code
-------	------



Model

Version		Fuel	Motor code
---------	--	------	------------

X-90

1.6 i 16V 4x4	09/1995→	B	G16B
---------------	----------	---	------

81791 350981791000



PULEGGIA	
Diametro Puleggia	Ø56.21
Numero Denti/Gole Puleggia	19
Altezza Puleggia	33.5
Posizione Puleggia	52.2
GIRANTE	
Diametro Girante	Ø59.8
N° Alette Girante	8
Distanza Girante	48.2

AUDI

A2

1.2 TDI	01/2011→05/2011	D	ANY
1.4 TDI	02/2000→05/2011	D	AMF, BHC
1.4 TDI	03/2011→05/2011	D	ATL

A3 II, Sportback, Cabriolet

1.9 TDI	03/2011→	D	BKC, BLS
---------	----------	---	----------

FORD

GALAXY I

1.9 TDI	03/2011→06/2011	D	ASZ
1.9 TDI	05/2011→06/2011	D	BTB

SEAT

ALHAMBRA I

1.9 TDI	02/2011→	D	ASZ
1.9 Tdi 4x4	05/2011→	D	ASZ

ALTEA, ALTEA XL

1.9 TDI	04/2011→	D	BJB, BKC, BLS, BXE
1.9 TDI	09/2011→	D	BXF

AROSA

1.4 TDI	01/2000→04/2011	D	AMF
---------	-----------------	---	-----

CORDOBA III, Vario

1.4 TDI	05/2011→	D	BNM
1.4 TDI	05/2011→	D	BMS, BNV
1.4 TDI	02/2011→	D	AMF
1.9 TDI	02/2011→	D	ATD
1.9 TDI	02/2011→	D	ASZ

IBIZA IV

1.4 TDI	02/2011→05/2011	D	AMF
1.4 TDI	05/2011→	D	BNM
1.4 TDI	05/2011→	D	BMS, BNV
1.9 TDI	02/2011→	D	ASZ
1.9 TDI	02/2011→	D	ATD

MAGNETI MARELLI			
Short	Code		
<b>Model</b>			
Version		Fuel	Motor code
81791	350981791000		
<b>SEAT</b>			
<b>IBIZA V, SportCoupé, ST</b>			
1.4 TDI	08/2011→	D BMS	
1.9 TDI	08/2011→	D BLS	
1.9 TDI	08/2011→	D BXJ	
<b>LEON II</b>			
1.9 TDI	07/2011→	D BXF	
1.9 TDI	05/2011→	D BKC, BLS	
1.9 TDi	05/2011→	D ASV	
<b>TOLEDO III</b>			
1.9 TDI	04/2011→	D BJB, BKC	
<b>SKODA</b>			
<b>FABIA I, Station Wagon</b>			
1.4 TDI	03/2011→08/2011	D AMF	
1.4 TDI	05/2011→08/2011	D BNV	
1.4 TDI	05/2011→08/2011	D BNM	
1.9 TDI	01/2000→08/2011	D ATD	
1.9 TDI RS	03/2011→08/2011	D ASZ	
<b>FABIA II, Station Wagon</b>			
1.4 TDI	07/2011→	D BMS	
1.4 TDI	07/2011→	D BNM	
1.9 TDI	07/2011→	D BLS, BSW	
<b>OCTAVIA II, Station Wagon</b>			
1.9 TDI	04/2011→	D BJB, BKC	
1.9 TDI 4x4	04/2011→	D BKC	
<b>PRAKTIK</b>			
1.4 TDI	07/2011→	D BNM	
1.4 TDI	07/2011→	D BMS	
<b>ROOMSTER</b>			
1.4 TDI	06/2011→	D BNM	
1.4 TDI	06/2011→	D BMS	
1.9 TDI	06/2011→	D BLS	
<b>SUPERB II, Station Wagon</b>			
1.9 TDI	08/2011→	D BLS, BXE	
<b>VOLKSWAGEN</b>			
<b>CADDY III</b>			
1.9 TDI	04/2011→	D BJB	
1.9 TDI	05/2011→	D BSU	
1.9 TDI 4motion	08/2011→	D BLS	
2.0 SDI	04/2011→	D BDJ	
<b>CRAFTER</b>			
2.5 TDI	06/2011→	D BJJ	
<b>FOX</b>			
1.4 TDI	05/2011→	D BNM	

MAGNETI MARELLI			
Short	Code		
<b>Model</b>			
Version		Fuel	Motor code
<b>GOLF V, Plus, Variant</b>			
1.9 TDI	04/2011→	D BRU, BXF	
1.9 TDI	03/2011→	D BKC, BLS, BXE	
1.9 TDI 4motion	04/2011→	D BKC, BLS, BXE	
2.0 SDI	04/2011→	D BDK	
<b>JETTA III</b>			
1.9 TDI	05/2011→	D BKC, BLS	
<b>LUPO</b>			
1.2 TDI 3L	07/1999→05/2011	D ANY, AYZ	
1.4 TDI	01/1999→05/2011	D AMF	
<b>MULTIVAN</b>			
1.9 TDI	03/2011→	D AXB	
<b>NEW BEETLE, Cabrio</b>			
1.9 TDI	01/2011→	D ATD	
1.9 TDI	05/2011→	D BSW	
<b>PASSAT VI, Variant, CC</b>			
1.9 TDI	05/2011→	D BKC, BLS	
<b>POLO III, Classic, Variant, Van</b>			
1.4 TDi	01/2000→10/2000	D ATL	
1.4 TDI	10/1999→01/2011	D AMF	
<b>POLO IV</b>			
1.4 TDI	05/2011→	D BMS, BNV	
1.4 TDI	05/2011→	D BNM	
1.4 TDI	01/2011→05/2011	D AMF, BAY	
1.9 TDI	01/2011→	D ATD, AXR	
1.9 TDI	03/2011→	D ASZ, BLT	
<b>SHARAN I</b>			
1.9 TDI	05/2011→	D BTB	
1.9 TDI	02/2011→	D ASZ	
<b>TOURAN</b>			
1.9 TDI	03/2011→	D AVQ	
1.9 TDI	03/2011→	D BKC	
1.9 TDI	04/2011→	D BRU	
<b>TRANSPORTER V</b>			
1.9 TDI	06/2011→	D BRR	
1.9 TDI	03/2011→	D AXB	
1.9 TDI	03/2011→	D AXC	
1.9 TDI	06/2011→	D BRS	

Short Code



Model

Version		Fuel	Motor code
---------	--	------	------------

81793 350981793000



**PULEGGIA**

Diametro Puleggia Ø94.8  
 Numero Denti/Gole Puleggia 5  
 Altezza Puleggia 25  
 Posizione Puleggia 74.2

**GIRANTE**

Diametro Girante Ø53.5  
 N° Alette Girante 7  
 Distanza Girante 10.5

BMW

**3 IV (E46), Touring, Cabrio, Compact, Coupé**

318 d	01/2011→05/2011	D	M47204D1
320 d	04/1998→01/2011	D	M47204D1, M47D20

81794 350981794000



**PULEGGIA**

Diametro Puleggia Ø94.8  
 Numero Denti/Gole Puleggia 5  
 Altezza Puleggia 25  
 Posizione Puleggia 74.25

**GIRANTE**

Diametro Girante Ø61.5  
 N° Alette Girante 7  
 Distanza Girante 10.75

BMW

**3 IV (E46), Touring, Cabrio, Compact, Coupé**

320 d	04/1998→01/2011	D	M47204D1, M47D20
-------	-----------------	---	------------------

**5 IV (E39), Touring**

520 d	02/2000→03/2011	D	M47204D1, M47D20
-------	-----------------	---	------------------

81795 350981795000



**PULEGGIA**

Diametro Puleggia Ø95.5  
 Numero Denti/Gole Puleggia 5  
 Altezza Puleggia 25  
 Posizione Puleggia 88.5

**GIRANTE**

Diametro Girante Ø64.5  
 N° Alette Girante 6  
 Distanza Girante -0.7

BMW

**3 IV (E46), Touring, Cabrio, Compact, Coupé**

330 d	10/1999→05/2011	D	M57D30
330 xd	06/2000→05/2011	D	M57D30

Short Code



Model

Version		Fuel	Motor code
---------	--	------	------------

**5 IV (E39), Touring**

525 d	02/2000→04/2011	D	M57256D1
530 d	08/1998→09/2000	D	M57D30
530 d	09/2000→04/2011	D	M57D30

**7 III (E38)**

730 d	04/2000→01/2011	D	M57306D1
730 d	08/1998→04/2000	D	M57D30

**X5 (E53)**

3.0 d	01/2011→	D	M57306D1
-------	----------	---	----------

LAND ROVER

RANGE ROVER

3.0 Td 6	02/2011→	D	
----------	----------	---	--

OPEL

OMEGA B, Station Wagon

2.5 DTI	01/2011→03/2011	D	Y25DT
---------	-----------------	---	-------

81796 350981796000



**PULEGGIA**

Diametro Puleggia Ø95.52  
 Numero Denti/Gole Puleggia 5  
 Altezza Puleggia 25  
 Posizione Puleggia 88.5

**GIRANTE**

Diametro Girante Ø64.5  
 N° Alette Girante 6  
 Distanza Girante -0.7

BMW

**5 IV (E39), Touring**

530 d	08/1998→09/2000	D	M57D30
540 i	01/1997→04/2011	B	M62448S2, M62B44



**7 III (E38)**



730 d	08/1998→04/2000	D	M57D30
-------	-----------------	---	--------

LANCIA

LYBRA, Station Wagon

2.4 JTD	02/2011→	D	841C.000
---------	----------	---	----------

MAGNETI MARELLI			
Short	Code		
			
<b>Model</b>			
Version		Fuel	Motor code
81797	350981797000		
			
<b>PULEGGIA</b>		Diametro Puleggia	Ø53.1
		Numero Denti/Gole Puleggia	18
		Altezza Puleggia	25
		Posizione Puleggia	37
<b>GIRANTE</b>		Diametro Girante	Ø52.8
		N° Alette Girante	6
<b>CITROËN</b>			
<b>BERLINGO I, Furgonato</b>			
1.1 i	07/1996→	B	HDZ (TU1M), HFX (TU1JP)
14	05/2011→		
14	02/2011→	G	
14	02/2011→05/2011	BF	
14	02/2011→05/2011	B	
1.4 bivalent	02/2011→	BF	
1.4 GNC	02/2011→	G	
1.4 i	07/1996→	B	KFW (TU3JP), KFX (TU3JP)
1.4 i bivalent	03/2011→	BF	KFW (TU3JP)
<b>C 2, Enterprise</b>			
11	03/2011→	B	HFX (TU1JP)
14	03/2011→	B	KFW (TU3JP)
14	06/2011→	B	TU3JP
<b>C 3, PICASSO, Pluriel</b>			
11	09/2011→	B	
1.1 i	02/2011→	B	HFX (TU1JP)
14	03/2011→	B	KFW (TU3JP)
1.4 i	02/2011→	B	KFW (TU3JP)
1.4 i Bivalent	02/2011→	BF	KFW (TU3JP)
<b>NEMO, Station Wagon</b>			
14	08/2011→	B	
<b>SAXO</b>			
1.1 X,SX	05/1996→03/2011	B	HDZ (TU1M), HFX (TU1JP)
1.1 X,SX	05/1996→03/2011	B	HDZ (TU1M)
1.4 VTS	05/1996→03/2011	B	KFW (TU3JP), KFX (TU3JP)
<b>XSARA, Break, Coupé, PICASSO</b>			
1.4 i	04/1997→05/2011	B	KFW (TU3JP), KFX (TU3JP)
<b>FIAT</b>			
<b>FIORINO III</b>			
14	08/2011→	B	
<b>QUBO</b>			
14	08/2011→	B	

MAGNETI MARELLI			
Short	Code		
			
<b>Model</b>			
Version		Fuel	Motor code
<b>PEUGEOT</b>			
<b>1007</b>			
14	05/2011→	B	KFV (TU3JP)
1.4 16V	05/2011→	B	KFU (ET3J4)
<b>206, Station Wagon, CC, Plus</b>			
11	02/2011→	B	HFX (TU1JP)
11	08/1998→07/2000	B	
1.1 i	09/1998→	B	HFX (TU1JP), HFZ (TU1JP)
14	02/2011→	B	KFW (TU3JP)
1.4 i	09/1998→	B	KFV (TU3A), KFW (TU3JP), KFX (TU3JP)
<b>207, Station Wagon, CC</b>			
14	06/2011→	B	KFV (TU3A)
14	07/2011→	B	KFV (TU3A)
<b>306, Break, Cabrio</b>			
14	05/1993→02/2011	B	KDX (TU3MC), KFW (TU3JP), KFX (TU3JP)
1.4 SL	06/1994→01/2011	B	KDX (TU3MC), KFW (TU3JP), KFX (TU3JP)
<b>307, Break, CC</b>			
14	08/2000→03/2011	B	KFW (TU3JP), TU3JP
<b>BIPPER, Tepee</b>			
14	08/2011→	B	
<b>PARTNER - Ranch, I</b>			
11	06/1996→	B	HDZ (TU1M), HFX (TU1JP)
14	06/1996→	B	KFW (TU3JP), KFX (TU3JP)
1.4 BiFuel	03/2011→	BF	KFW (TU3JP)
<b>81798 350981798000</b>			
			
<b>PULEGGIA</b>		Diametro Puleggia	Ø62
		Numero Denti/Gole Puleggia	21
		Altezza Puleggia	30
		Posizione Puleggia	39.1
<b>GIRANTE</b>		Diametro Girante	Ø72
		N° Alette Girante	20
		Distanza Girante	29
<b>CITROËN</b>			
<b>C 1</b>			
1.4 HDi	05/2011→	D	DV4D
<b>C 2, Enterprise</b>			
1.4 HDi	03/2011→	D	8HX (DV4TD)
<b>C 3, PICASSO, Pluriel</b>			
1.4 16V HDi	02/2011→	D	8HY (DV4TED4)
1.4 HDi	02/2011→	D	8HX (DV4TD), 8HZ (DV4TD)

MAGNETI MARELLI			
Short	Code		
<b>Model</b>			
Version		Fuel	Motor code
81798		350981798000	
<b>CITROËN</b>			
<b>C 3, PICASSO, Pluriel</b>			
1.4 HDi	05/2011→	D	
<b>NEMO, Station Wagon</b>			
1.4 HDi	08/2011→	D	
<b>XSARA, Break, Coupé, PICASSO</b>			
1.4 HDi	03/2011→05/2011	D	8HX (DV4TD)
<b>FORD</b>			
<b>FIESTA V, Van</b>			
1.4 TDCi	01/2011→	D	F6JA, F6JB
<b>FIESTA VI, Van</b>			
1.4 TDCi	09/2011→	D	
1.4 TDCi	09/2011→	D	F6JB
1.6 TDCi	09/2011→	D	
<b>FUSION</b>			
1.4 TDCi	02/2011→	D	F6JA
<b>MAZDA</b>			
<b>2 I</b>			
1.4 CD	03/2011→	D	F6JA
<b>2 II</b>			
1.4 MZR	08/2011→	D	
<b>PEUGEOT</b>			
<b>1007</b>			
1.4 HDi	05/2011→	D	8HX (DV4TD), 8HZ (DV4TD)
<b>107</b>			
1.4 HDi	05/2011→	D	
<b>206, Station Wagon, CC, Plus</b>			
1.4 HDi	02/2011→	D	8HX (DV4TD)
1.4 HDi eco 70	01/2011→	D	8HX (DV4TD), 8HZ (DV4TD)
<b>207, Station Wagon, CC</b>			
1.4 HDi	06/2011→	D	
<b>307, Break, CC</b>			
1.4 HDi	01/2011→	D	8HX (DV4TD), 8HZ (DV4TD)
<b>BIPPER, Tepee</b>			
1.4 HDi	08/2011→	D	
<b>SUZUKI</b>			
<b>LIANA, Station Wagon</b>			
1.4 DDiS	04/2011→	D	8HY
<b>TOYOTA</b>			
<b>AYGO</b>			
1.4 HDi	05/2011→	D	

MAGNETI MARELLI			
Short	Code		
<b>Model</b>			
Version		Fuel	Motor code
81799		350981799000	
<b>CITROËN</b>			
<b>C 4 I, Coupé</b>			
2.0 16V	04/2011→	B	RFN (EW10J4)
2.0 16V	04/2011→	B	EW10J4S
2.0 16V	04/2011→	B	EW10A
<b>C 4 PICASSO, Gran PICASSO</b>			
1.8 16V	07/2011→	B	6FY-EW7A
1.8 i 16V	06/2011→	B	6FY-EW7A
2.0 16V	07/2011→	B	RFJ-EW10A
2.0 i 16V	06/2011→	B	RFJ-EW10A
<b>C 5 I, Break</b>			
1.8 16V	01/2011→04/2011	B	6FZ (EW7J4)
2.0 16V	01/2011→04/2011	B	RFN (EW10J4)
2.0 16V HPi	01/2011→04/2011	B	RLZ (EW10D)
<b>C 5 II, Break</b>			
1.8 16V	04/2011→	B	6FZ (EW7J4)
1.8 16V	05/2011→	B	6FY-EW7A
2.0 16V	04/2011→	B	EW10A, RFJ-EW10A
<b>C 5 III, Break</b>			
1.8 16V	08/2011→	B	6FY-EW7A
2.0 16V	08/2011→	B	EW10A
2.0 16V BioFlex	08/2011→	FF	RFJ-EW10A
<b>C 8</b>			
20	02/2011→	B	RFN (EW10J4)
2.0 16V	05/2011→	B	RFJ-EW10A
22	02/2011→	B	3FZ (EW12J4)
<b>EVASION</b>			
2.0 16V	05/2000→02/2011	B	RFN (EW10J4)
<b>JUMPY I</b>			
20	04/2000→06/2011	B	RFN (EW10J4)
2.0 i 16V	03/2000→	B	
<b>JUMPY II</b>			
2.0 i	07/2011→	B	RFH (EW10A)
<b>XSARA, Break, Coupé, PICASSO</b>			
1.8 16V	02/2000→	B	6FZ (EW7J4), LFY (XU7JP4)



<b>PULEGGIA</b>	
Diametro Puleggia	Ø59.85
Numero Denti/Gole Puleggia	20
Altezza Puleggia	32.3
Posizione Puleggia	62
<b>GIRANTE</b>	
Diametro Girante	Ø61.5
N° Alette Girante	8
Distanza Girante	22.2



MAGNETI MARELLI			
Short	Code		
<b>Model</b>			
Version		Fuel	Motor code
<b>81799</b>	<b>350981799000</b>		
<b>CITROËN</b>			
<b>XSARA, Break, Coupé, PICASSO</b>			
1.8 VTS	09/2000→04/2011	B	6FZ (EW7J4)
2.0 16V	09/2000→05/2011	B	RFN (EW10J4)
<b>FIAT</b>			
<b>SCUDO I</b>			
20	05/2000→	B	RFN
2.0 16V	06/2000→	B	RFN
<b>ULYSSE II</b>			
20	02/2011→	B	RFN (EW10J4)
<b>LANCIA</b>			
<b>PHEDRA</b>			
20	02/2011→	B	RFN (EW10J4)
<b>ZETA</b>			
2.0 16V	07/2000→02/2011	B	RFN
<b>PEUGEOT</b>			
<b>206, Station Wagon, CC, Plus</b>			
2.0 16V	02/2011→	B	RFN (EW10J4)
2.0 RC	03/2011→	B	RFK (EW10J4S)
2.0 S16	04/1999→10/2000	B	RFR (DEW10J4)
2.0 S16	09/2000→	B	RFN (EW10J4)
<b>307, Break, CC</b>			
20	02/2011→	B	RFN (EW10J4)
2.0 16V	05/2011→	B	RFJ (EW10A)
2.0 16V	08/2000→	B	RFN (EW10J4)
2.0 16V	03/2011→	B	RFK (EW10J4S)
<b>406, Break, Coupé</b>			
2.0 16V	01/1999→10/2000	B	RFR (DEW10J4)
2.0 16V	08/2000→04/2011	B	RFN (EW10J4)
2.0 16V	11/1995→04/2011	B	RFV (XU10J4R)
2.0 16V HPI	01/2011→04/2011	B	RLZ (EW10D)
22	07/2000→04/2011	B	3FZ (EW12J4)
<b>407, Break, Coupé</b>			
18	04/2011→	B	6FZ (EW7J4)
1.8 16V	05/2011→	B	6FY (EW7A)
20	04/2011→	B	RFN (EW10J4)
2.0 16V	05/2011→	B	RFJ (EW10A)
22	04/2011→	B	3FZ (EW12J4)
22	05/2011→	B	3FY (EW12J4)
2.2 16V	05/2011→	B	3FY (EW12J4)
<b>607</b>			
20	02/2000→	B	RFN (EW10J4)
2.2 16V	02/2000→	B	3FZ (EW12J4)
2.2 16V	05/2011→	B	3FY (EW12J4)

MAGNETI MARELLI			
Short	Code		
<b>Model</b>			
Version		Fuel	Motor code
<b>806</b>			
2.0 16V	09/2000→02/2011	B	RFN (EW10J4)
<b>807</b>			
20	02/2011→	B	RFN (EW10J4)
2.0 16V	05/2011→	B	RFJ (EW10A)
22	02/2011→	B	3FZ (EW12J4)
<b>EXPERT I</b>			
20	07/2000→	B	RFN (EW10J4)
<b>EXPERT II, Tepee</b>			
2.0 16V	07/2011→	B	RFJ (EW10A)
<b>81800</b>			
<b>350981800000</b>			
		<b>PULEGGIA</b>	
		Diametro Puleggia	Ø56
		Numero Denti/Gole Puleggia	19
		Altezza Puleggia	33.5
		Posizione Puleggia	42.3
		<b>GIRANTE</b>	
		Diametro Girante	Ø74
		N° Alette Girante	8
		Distanza Girante	34.2
<b>CITROËN</b>			
<b>C 4 I, Coupé</b>			
2.0 HDi	08/2011→	D	
2.0 HDi 135 FAP	04/2011→	D	DW10BTED4
2.0 HDi 135 FFAP	04/2011→	D	DW10BTED4
<b>C 4 PICASSO, Gran PICASSO</b>			
2.0 HDi 135 FAP	06/2011→	D	RHJ-DW10BTED4
2.0 HDi 138 FAP	07/2011→	D	RHJ-DW10BTED4
<b>C 5 I, Break</b>			
2.2 HDi	01/2011→04/2011	D	4HX (DW12TED4/FAP)
<b>C 5 II, Break</b>			
2.0 HDi	04/2011→	D	DW10BTED4, RHR (DW10BTED4)
2.2 HDi	04/2011→	D	4HX (DW12TED4/FAP)
<b>C 5 III, Break</b>			
2.0 HDi	08/2011→	D	DW10BTED4
2.0 HDi	09/2011→	D	
2.0 HDi	09/2011→	D	
<b>C 8</b>			
2.0 HDi	07/2011→	D	RHK (DW10UTED4)
2.0 HDi	06/2011→	D	
2.0 HDi	06/2011→	D	RHR (DW10BTED4)
2.2 HDi	02/2011→	D	4HW (DW12TED4)
<b>JUMPER II</b>			
2.2 HDi	02/2011→06/2011	D	

MAGNETI MARELLI			
Short	Code		
<b>Model</b>			
Version		Fuel	Motor code
81800		350981800000	
<b>CITROËN</b>			
<b>JUMPER II</b>			
2.2 HDi	02/2011→	D	DW12TED
<b>JUMPY I</b>			
2.2 HDi	03/2011→06/2011	D	
<b>JUMPY II</b>			
2.0 HDi 120	07/2011→	D	RHK (DW10UTED4)
2.0 HDi 140	07/2011→	D	RHR (DW10BTED4)
<b>FIAT</b>			
<b>SCUDO II</b>			
2.0 D Multijet	07/2011→	D	RHR
2.0 D Multijet	07/2011→	D	RHK
<b>ULYSSE II</b>			
2.0 D Multijet	06/2011→	D	RHK
2.0 D Multijet	06/2011→	D	RHR
2.2 JTD	02/2011→	D	4HW (DW12ATED4)
<b>FORD</b>			
<b>C-Max I</b>			
2.0 TDCi	07/2011→	D	G6DA
2.0 TDCi	08/2011→	D	IXDA
<b>FOCUS C-Max</b>			
2.0 TDCi	03/2011→07/2011	D	G6DD
<b>FOCUS II, Station Wagon, Cabrio</b>			
2.0 TDCi	08/2011→	D	IXDA
2.0 TDCi	04/2011→	D	G6DA, G6DB
<b>GALAXY I</b>			
2.0 TDCi	06/2011→	D	QXWA
2.0 TDCi	06/2011→	D	AZWA
2.0 TDCi	07/2011→	D	TYWA
<b>KUGA</b>			
2.0 TDCi	08/2011→	D	G6DG
2.0 TDCi AWD	08/2011→	D	G6DG
<b>MONDEO IV, Station Wagon</b>			
2.0 TDCi	07/2011→	D	
2.0 TDCi	07/2011→	D	QXBB
2.0 TDCi	07/2011→	D	AZBA
2.0 TDCi	07/2011→	D	KLBA
<b>S-Max</b>			
2.0 TDCi	06/2011→	D	AZWA
2.0 TDCi	06/2011→	D	
2.0 TDCi	06/2011→	D	QXWA
2.0 TDCi	07/2011→	D	KLWA

MAGNETI MARELLI			
Short	Code		
<b>Model</b>			
Version		Fuel	Motor code
<b>LANCIA</b>			
<b>PHEDRA</b>			
2.0 D Multijet	06/2011→	D	RHR
2.0 JTD	06/2011→	D	RHK
2.2 JTD	02/2011→	D	4HW (DW12ATED4)
<b>PEUGEOT</b>			
<b>307, Break, CC</b>			
2.0 HDi 135 FAP	03/2011→	D	RHR (DW10BTED4)
<b>308, Station Wagon, CC</b>			
2.0 D	09/2011→	D	
2.0 HDi	07/2011→	D	
2.0 HDi	07/2011→	D	RHR (DW10BTED4)
<b>406, Break, Coupé</b>			
2.2 HDi FAP	03/2000→04/2011	D	4HX (DW12TED4/FAP)
<b>407, Break, Coupé</b>			
2.0 HDi	10/2011→	D	
2.0 HDi	04/2011→08/2011	D	
2.0 HDi	09/2011→	D	
2.0 HDi	08/2011→	D	
2.0 HDi	05/2011→	D	RHR (DW10BTED4)
2.0 HDi 135 FAP	04/2011→	D	RHR (DW10BTED4)
<b>607</b>			
2.0 HDi	05/2011→	D	RHR (DW10BTED4)
2.2 HDi	02/2000→	D	4HX (DW12TED4/FAP)
<b>807</b>			
2.0 HDi	04/2011→06/2011	D	
2.0 HDi	06/2011→	D	RHR (DW10BTED4)
2.0 HDi	06/2011→	D	RHK (DW10UTED4)
2.2 HDi FAP	02/2011→	D	4HX (DW12TED4/FAP)
<b>BOXER II</b>			
2.2 HDi	02/2011→	D	4HY (DW12UTED)
<b>EXPERT I</b>			
2.0 HDi	07/2000→	D	RHX (DW10BTED)
2.0 HDi	07/2000→	D	RHZ (DW10ATED)
2.0 HDi	07/2000→	D	RHW (DW10ATED4)
<b>EXPERT II, Tepee</b>			
2.0 HDi 120	07/2011→	D	RHK (DW10UTED4)
2.0 HDi 140	07/2011→	D	RHR (DW10BTED4)
<b>PARTNER - Ranch, I</b>			
2.0 HDi 4x4	04/2011→05/2011	D	RHY (DW10TD)
<b>VOLVO</b>			
<b>C30</b>			
2.0 D	06/2011→	D	D4204T
<b>C70 II Cabrio</b>			
2.0 D	08/2011→	D	D4204T





MAGNETI MARELLI			
Short	Code		
			
<b>Model</b>			
Version		Fuel	Motor code
<b>81800</b>	<b>350981800000</b>		
<b>VOLVO</b>			
<b>S40 II</b>			
2.0 D	04/2011→	D	D4204T
2.0 D4	05/2011→	D	D4204T2
<b>S80 II</b>			
2.0 TDi	08/2011→	D	D4204T
<b>V40 Station Wagon</b>			
2.0 D	02/2011→04/2011	D	D4204T
<b>V50</b>			
2.0 D	04/2011→	D	D4204T
<b>V70 III Station Wagon</b>			
2.0 D	07/2011→	D	D4204T

81801	350981801000		
-------	--------------	--	--



<b>PULEGGIA</b>		
Diametro Puleggia	Ø59.27	
Numero Denti/Gole Puleggia	20	
Altezza Puleggia	16	
Posizione Puleggia	46.5	
<b>GIRANTE</b>		
Diametro Girante	Ø63	
N° Alette Girante	8	
Distanza Girante	34	

<b>AUTOBIANCHI</b>			
<b>Y 10</b>			
10	03/1985→	B	156A2.000
1.0 4WD	12/1986→	B	156A3.000
1.0 Cat.	10/1987→	B	156A2.246
11	06/1989→	B	156C.000
1.1 4WD	06/1989→	B	156C.000
1.1 i.e. Cat.	09/1990→	B	156C.046
<b>FIAT</b>			
<b>CINQUECENTO</b>			
1.1 Sporting	10/1994→01/1998	B	176B2.000
<b>FIORINO II</b>			
1.0 iE	11/1992→04/1996	B	156A2.246
<b>PALIO, Weekend</b>			
11	07/1997→03/2011	B	
12	04/1996→01/2011	B	178B5.000, 178E2.000
12	06/1999→10/2000	B	178E2.000
12	01/2011→	B	188A5.000
<b>PANDA I, Van</b>			
1000	01/1985→12/1992	B	156A3.000
1000	01/1986→04/1992	B	156A2.100, 156A3.100

MAGNETI MARELLI			
Short	Code		
			
<b>Model</b>			
Version		Fuel	Motor code
<b>PANDA I, Van</b>			
1000 4x4	01/1986→12/1992	B	156A3.000
1000 4x4	05/1986→12/1994	B	141C2.000, 156A2.246
1000 i.e.	08/1992→04/2011	B	156A2.246
1000 i.e. Cat.	10/1987→08/1998	B	141C2.000, 156A2.246
1100	02/1995→03/2011	B	176B2.000, 187A1.000
1100	05/1991→12/1999	B	156C.046
1100 4x4	02/1995→04/2011	B	176B2.000
1100 Trekking 4x4	10/1991→04/2011	B	156C.046
750	01/1986→12/1997	B	156A4.000, 156A4.048
<b>PUNTO I, Cabrio, Van</b>			
11	04/1996→02/2000	B	176B2.000
55 1.1	09/1993→09/1999	B	176A6.000, 176B2.000
60 1.2	01/1994→06/2000	B	176A7.000
60 1.2	03/1994→06/2000	B	176B1.000, 176B4.000
75 1.2	10/1993→09/1999	B	176A8.000
<b>SEICENTO, Van</b>			
11	01/1998→	B	176B2.000, 187A1.000
<b>SIENA</b>			
12	09/1998→	B	178B5.000
<b>STRADA</b>			
12	06/1999→	B	178B5.000
<b>UNO</b>			
1.0 iE	05/1998→08/2000	B	156A2.246
45 1.0	06/1986→12/1993	B	
45 1.0	06/1986→12/1993	B	156A2.048, 156A2.100
45 i.e. 1.0	04/1984→10/1995	B	156A2.246
50 1.1	01/1990→12/1993	B	156C.046
50 i.e. 1.1	06/1992→12/1993	B	146C3.000
60 1.1	04/1989→12/1992	B	160A3.000
<b>LANCIA</b>			
<b>Y</b>			
11	11/1995→03/2011	B	176B2.000
12	03/1996→03/2011	B	188A4.000, 840A3.000
<b>Y10</b>			
1.0 Fire	03/1985→02/1992	B	156A2.000, 156A2.246
1.0 Fire 4WD	12/1987→02/1992	B	156A2.246
1.1 Avenue	01/1995→12/1995	B	176B2.000
1.1 Avenue 4WD	01/1995→12/1995	B	176B2.000
1.1 i.e.	08/1989→06/1992	B	156C.000
1.1 i.e. 4WD	08/1989→06/1992	B	156C.000
1.1 i.e. Fire	07/1989→09/1995	B	156C.046
1.1 i.e. Fire 4WD	09/1992→12/1995	B	156C.046

Short Code



Model

Version		Fuel	Motor code
---------	--	------	------------

81802		350981802000	
-------	--	--------------	--



<b>FLANGIA</b>	
Numero Fori Flangia	4
Dimensione Fori Flangia	M8x1.25
Diametro Centraggio	Ø58
Posizione Flangia	59.8
<b>GIRANTE</b>	
Diametro Girante	Ø79
N° Alette Girante	6
Distanza Girante	28

FORD

FIESTA IV, Van

1.8 DI	04/2000→02/2011	D	RTN, RTP, RTQ
--------	-----------------	---	---------------

FIESTA V, Van

TD 1.8	03/2000→	D	RTN
--------	----------	---	-----

FOCUS C-Max

1.8 TDCi	05/2011→07/2011	D	KKDA
----------	-----------------	---	------

FOCUS I, Station Wagon

1.8 DI / TDDi	08/1999→04/2011	D	BHDA, BHDB
---------------	-----------------	---	------------

1.8 TDCi	01/2011→04/2011	D	F9DA, F9DB
----------	-----------------	---	------------

1.8 TDCi	02/2011→04/2011	D	FFDA
----------	-----------------	---	------

1.8 TDDi	01/2011→05/2011	D	
----------	-----------------	---	--

1.8 Turbo DI / TDDi	10/1998→04/2011	D	C9DA, C9DB, C9DC
---------------------	-----------------	---	------------------

FOCUS II, Station Wagon, Cabrio

1.8 TDCi	04/2011→	D	KKDA
----------	----------	---	------

GALAXY I

1.8 TDCi	06/2011→	D	QYWA
----------	----------	---	------

1.8 TDCi	06/2011→	D	FFWA
----------	----------	---	------

MONDEO IV, Station Wagon

1.8 TDCi	07/2011→	D	FFBA
----------	----------	---	------

1.8 TDCi	07/2011→	D	KHBA, QYBA
----------	----------	---	------------

S-Max

1.8 TDCi	07/2011→	D	FFWA
----------	----------	---	------

1.8 TDCi	06/2011→	D	QYWA
----------	----------	---	------

TOURNEO Connect

1.8 Di	02/2011→	D	BHPA
--------	----------	---	------

1.8 TDCi	06/2011→	D	RWPA
----------	----------	---	------

1.8 Turbo Di	02/2011→	D	HCPA
--------------	----------	---	------

TRANSIT Connect

1.8 Di	02/2011→	D	BHPA
--------	----------	---	------

1.8 TDCi	02/2011→	D	HCPA
----------	----------	---	------

1.8 TDCi DPF	06/2011→	D	RWPA
--------------	----------	---	------

Short Code



Model

Version		Fuel	Motor code
---------	--	------	------------

81803		350981803000	
-------	--	--------------	--



<b>FLANGIA</b>	
Numero Fori Flangia	3
Dimensione Fori Flangia	M8x1.25
Diametro Mozzo	Ø23.4
Posizione Flangia	40.25
<b>GIRANTE</b>	
Diametro Girante	Ø70
N° Alette Girante	6
Distanza Girante	40.4

FORD

COUGAR

2.0 16V	08/1998→01/2011	B	EDBA, EDBB, EDBC, EDBD
---------	-----------------	---	------------------------

ESCORT VIII, Station Wagon

1.6 16V	10/1998→07/2000	B	L1E
---------	-----------------	---	-----

FOCUS I, Station Wagon

18	02/2011→03/2011	B	
----	-----------------	---	--

1.8 16V	10/1998→04/2011	B	EYDB, EYDC, EYDD, EYDE, EYDF, EYDG, EYDI, EYDJ, EYDL
---------	-----------------	---	--

1.8 BiFuel	03/2011→05/2011	B	
------------	-----------------	---	--

2.0 16V	10/1998→04/2011	B	EDDB, EDDC, EDDD, EDDF
---------	-----------------	---	------------------------

RS	02/2011→04/2011	B	HMDA
----	-----------------	---	------

ST170	02/2011→04/2011	B	ALDA
-------	-----------------	---	------

TOURNEO Connect

1.8 16V	02/2011→	B	EYPA, EYPC
---------	----------	---	------------

TRANSIT Connect

1.8 16V	02/2011→	B	EYPA, EYPC
---------	----------	---	------------

MAZDA

TRIBUTE

20	03/2000→	B	
----	----------	---	--

2.0 4WD	03/2000→	B	
---------	----------	---	--

81804 350981804000



<b>FLANGIA</b>	
Numero Fori Flangia	3
Dimensione Fori Flangia	M8x1.25
Posizione Flangia	50.5
<b>GIRANTE</b>	
Diametro Girante	Ø67
N° Alette Girante	6
Distanza Girante	43.4

FORD

C-Max I

18	07/2011→	B	QQDA
----	----------	---	------

MAGNETI MARELLI			
Short	Code		
<b>Model</b>			
Version		Fuel	Motor code
81804	350981804000		
<b>FORD</b>			
<b>C-Max I</b>			
1.8 Flexifuel	07/2011→	FF	Q7DA
20	07/2011→	B	AODA
2.0 CNG	09/2011→	M	SYDA
2.0 LPG	08/2011→		SYDA
<b>FIESTA V, Van</b>			
ST150	05/2011→	B	N4JB
<b>FOCUS C-Max</b>			
18	04/2011→07/2011	B	Q7DA, QQDA, QQDB
18	03/2011→07/2011	B	CSDA, CSDB
1.8 Flexifuel	06/2011→07/2011	FF	Q7DA
20	04/2011→07/2011	B	AODA, AODB
<b>FOCUS II, Station Wagon, Cabrio</b>			
18	06/2011→	B	
1.8 Flexifuel	06/2011→	FF	Q7DA
1.8 Ghia FFV Flexifuel	05/2011→	B	
1.8 Ghia Flexifuel	05/2011→	B	
20	04/2011→	B	AODA, AODB
2.0 CNG	09/2011→	M	
2.0 LPG	08/2011→		
<b>GALAXY I</b>			
20	06/2011→	B	AOWB
2.0 Flexifuel	06/2011→	FF	TBWA
2.0 SCTi	10/2011→	B	TNWA
23	07/2011→	B	SEWA
<b>MAVERICK II</b>			
2.3 16V	04/2011→	B	GZ
<b>MONDEO III, Station Wagon</b>			
1.8 16V	11/2000→07/2011	B	CHBA, CHBB
1.8 16V	11/2000→07/2011	B	CGBA, CGBB
1.8 SCi	03/2011→07/2011	B	CFBA
2.0 16V	11/2000→07/2011	B	CJBA, CJBB
<b>MONDEO IV, Station Wagon</b>			
20	07/2011→	B	AOBA
2.0 Flexifuel	07/2011→	FF	TBBA
2.0 LPG	09/2011→		
2.0 SCTi	10/2011→	B	TNBA
23	07/2011→	B	SEBA
<b>S-Max</b>			
20	06/2011→	B	AOWA
2.0 Flexifuel	06/2011→	FF	TBWA
2.0 SCTi	10/2011→	B	TNWA
23	07/2011→	B	SEWA

MAGNETI MARELLI			
Short	Code		
<b>Model</b>			
Version		Fuel	Motor code
<b>MAZDA</b>			
<b>3 I</b>			
20	03/2011→	B	LF17
23	04/2011→09/2011	B	
23	06/2000→03/2011	B	
2.3 DiSi Turbo MPS	06/2011→	B	
2.3 MPS	06/2011→	B	
2.3 MZR	04/2011→09/2011	B	
2.3 MZR Sport	03/2011→	B	
<b>3 II</b>			
2.0 MZR	09/2011→	B	
2.0 MZR DISI	09/2011→	B	
2.3 MPS Turbo	09/2011→	B	
<b>5</b>			
18	05/2011→	B	L823
20	05/2011→	B	LFF7
20	10/2011→	B	
23	05/2011→	B	
<b>6 I, Hatchback, Station Wagon</b>			
18	02/2011→	B	L813
20	05/2011→	B	LFF7
20	02/2011→	B	LF17, LF18
23	02/2011→	B	L3C1
2.3 AWD	02/2011→	B	
2.3 MPS	05/2011→	B	
<b>6 II, Hatchback, Station Wagon</b>			
1.8 MRZ	07/2011→	B	L813
2.0 MRZ	07/2011→	B	
2.5 MRZ	07/2011→	B	
<b>CX-7</b>			
2.3 MZR DISI Turbo	09/2011→	B	
2.3 MZR DISI Turbo	06/2011→	B	
MZR DISI Turbo	07/2011→	B	L3-VDT
<b>MPV II</b>			
23	02/2011→	B	
<b>MX-5 III</b>			
18	05/2011→	B	
20	05/2011→	B	
<b>Premacy</b>			
2.3 SVT	05/2011→	B	
<b>TRIBUTE</b>			
2.3 AWD	04/2011→	B	L3-VE
2.3 GX	03/2011→04/2011	B	L3-VE

Short **MAGNETI MARELLI** Code



**Model**

Version		Fuel	Motor code
---------	--	------	------------

**VOLVO**

**C30**

18	06/2011→	B	B4184S11
1.8 FlexFuel	07/2011→	FF	B4184S8
20	06/2011→	B	B4204S3
2.0 FlexFuel	10/2011→	FF	B4204S4

**S40 II**

20	06/2011→	B	B4204S3
----	----------	---	---------

**S60 II**

2.0 T	10/2011→	B	B4204T6
T6 AWD	10/2011→	B	B6304T4

**S80 II**

20	08/2011→	B	B4204S3
2.0 FlexFuel	08/2011→	FF	B4204S4
2.0 T	10/2011→	B	B4204T6

**V50**

18	04/2011→	B	B4184S11
1.8 FlexFuel	05/2011→	FF	B4184S8
20	06/2011→	B	B4204S3
2.0 FlexFuel	10/2011→	FF	B4204S4

**V70 III Station Wagon**

20	07/2011→	B	B4204S3
2.0 FlexFuel	08/2011→	FF	B4204S4
2.0 T	10/2011→	B	B4204T6

**XC 60**

2.0 T	10/2011→	B	B4204T6
-------	----------	---	---------

**81805 350981805000**



<b>GIRANTE</b>	
Diametro Alberino	10.8
Lunghezza Alberino	66.7
<b>GIRANTE</b>	
Diametro Girante	Ø80
N° Alette Girante	8
Distanza Girante	16.2

**FORD**

**MONDEO III, Station Wagon**

2.0 16V DI / TDDi / TDCi	11/2000→07/2011	D	D5BA, SDBA
2.0 16V TDDi / TDCi	11/2000→07/2011	D	D6BA, HJBA, HJBB, HJBC
2.0 TDCi	03/2011→05/2011	D	
2.0 TDCi	01/2011→07/2011	D	FMBA, N7BA
2.2 TDCi	04/2011→07/2011	D	QJBA, QJBB

Short **MAGNETI MARELLI** Code



**Model**

Version		Fuel	Motor code
---------	--	------	------------

**TRANSIT VII**

2.0 DI	08/2000→06/2011	D	D3FA
2.0 DI	08/2000→06/2011	D	F3FA
2.0 DI	08/2000→06/2011	D	ABFA
2.0 TDCi	02/2011→06/2011	D	FIFA
2.4 TD	08/2000→03/2011	D	F4FA

**JAGUAR**

**X-Type, Estate**

2.0 D	03/2011→05/2011	D	R4-X404
2.2 D	07/2011→	D	LJ46G
2.2 D	05/2011→	D	LJ46G

**81806 350981806000**

	<b>PULEGGIA</b>	
	Diametro Puleggia	Ø59.26
	Numero Denti/Gole Puleggia	20
	Altezza Puleggia	30.5
	Posizione Puleggia	49.7
	<b>GIRANTE</b>	
	Diametro Girante	Ø59.5
	N° Alette Girante	8
	Distanza Girante	24.8

**DACIA**

**DUSTER**

1.6 16V	10/2011→	B	K4M690
1.6 16V 4x4	10/2011→	B	

**LOGAN, Station Wagon, Van**

1.6 16V	06/2011→	B	K4M690, K7M690
---------	----------	---	----------------

**NISSAN**

**KUBISTAR**

1.6 16V	03/2011→	B	K4M752
---------	----------	---	--------

**RENAULT**

**CLIO II, Van**

1.4 16V	08/2000→	B	K4J700, K4J712, K4J713
1.4 16V	10/1999→08/2000	B	K4J712, K4J713
1.6 16V	09/1998→	B	K4M708, K4M748
1.6 X	03/2011→	B	K4M746

**CLIO III, GRANDtour**

1.4 16V	05/2011→	B	K4J780
1.6 16V	05/2011→	B	K4M804
1.6 16V	05/2011→	B	K4M800, K4M801
1.6 16V GT	09/2011→	B	K4M862

**KANGOO I**

1.6 16V	01/2011→	B	K4M750, K4M752, K4M753
1.6 16V 4x4	01/2011→	B	K4M750, K4M752, K4M753

MAGNETI MARELLI			
Short	Code		
<b>Model</b>			
Version		Fuel	Motor code
<b>81806</b>	<b>350981806000</b>		
<b>RENAULT</b>			
<b>KANGOO I</b>			
1.6 16V bivalent	05/2011→	BF	
<b>KANGOO II, BePop</b>			
16	09/2011→	B	K4M830
1.6 16V	08/2011→	B	
1.6 16V Hi-Flex	08/2011→	FF	
1.6 16V LPG	08/2011→		
<b>LAGUNA I, GRANDtour</b>			
1.6 16V	11/1997→01/2011	B	K4M720, K4M724
<b>LAGUNA II, GRANDtour</b>			
1.6 16V	05/2011→	B	K4M716
1.6 16V	01/2011→	B	K4M710, K4M711
1.6 FlexFuel	01/2011→03/2011	B	K4M718
1.8 16V	01/2011→	B	F4P770, F4P771, F4P773, F4P774, F4P775
<b>LAGUNA III, GRANDtour</b>			
1.6 16V	07/2011→	B	K4M824
<b>LOGAN, Station Wagon</b>			
16	07/2011→	B	K4M690, K7M690
<b>MEGANE I, Coach, Grantour, Scenic</b>			
1.4 16V	03/1999→03/2011	B	K4J714, K4J750
1.6 16V	03/1999→03/2011	B	K4M700, K4M701, K4M704, K4M708
<b>MEGANE II, Station Wagon, C-C, Scenic</b>			
14	03/2011→	B	K4J730
14	03/2011→	B	K4J732
1.4 16V	03/2011→	B	K4J732
1.4 16V	02/2011→	B	K4J730
16	05/2011→	B	K4M762
16	03/2011→	B	K4M760
16	03/2011→	B	K4M768
1.6 16V	07/2011→	B	K4M760, K4M812
1.6 16V	02/2011→	B	K4M760
1.6 Flex-Fuel	07/2011→	FF	K4M762, K4M788
1.6 GL	05/2011→	B	K4M788
1.6 Turbo Sport	05/2011→	B	K4M788
<b>MEGANE III, Station Wagon, C-C, Scenic</b>			
16	08/2011→	B	
1.6 16V	09/2011→	B	
1.6 16V	09/2011→	B	
1.6 16V	08/2011→	B	K4M858
1.6 16V Bifuel	08/2011→	BF	K4M866
<b>MODUS</b>			
14	04/2011→	B	K4J770

MAGNETI MARELLI			
Short	Code		
<b>Model</b>			
Version		Fuel	Motor code
<b>MODUS</b>			
16	04/2011→	B	K4M792
16	04/2011→	B	K4M790, K4M791
<b>SCENIC I, GRAND SCENIC</b>			
1.4 16V	09/1999→03/2011	B	K4J714, K4J750
16	04/2011→	B	K4M761
16	06/2011→	B	K4M788
1.6 16V	09/1999→03/2011	B	K4M700, K4M701, K4M704, K4M708
<b>SCENIC II, GRAND SCENIC</b>			
14	03/2011→	B	K4J730
16	03/2011→	B	K4M761, K4M782
16	06/2011→	B	K4M788
1.6 16V	07/2011→	B	K4M812
<b>SCENIC III, GRAND SCENIC</b>			
1.6 16V	09/2011→	B	K4M9766
<b>THALIA</b>			
1.4 16V	08/2000→	B	K4J712
1.6 16V	02/2011→	B	K4M740
<b>TWINGO II</b>			
1.6 RS	08/2011→	B	K4M754
<b>WIND</b>			
16	10/2011→	B	K4M854

## 81807 350981807000



### FLANGIA

Numero Fori Flangia	3
Dimensione Fori Flangia	M6x1
Posizione Flangia	61.6
Diametro Centraggio	Ø40
Numero Fori Flangia (Serie 2)	3
Dimensione Fori Flangia (Serie 2)	Ø6

### GIRANTE

Diametro Girante	Ø60
N° Alette Girante	8
Distanza Girante	30.6

### SEAT

### AROSA

10	05/1997→04/2011	B	AER, ALD, ALL, ANV, AUC
----	-----------------	---	-------------------------

### VOLKSWAGEN

### LUPO

10	09/1998→05/2011	B	AER, ALD, ALL, ANV, AUC
----	-----------------	---	-------------------------

Short **MAGNETI MARELLI** Code



Model

Version		Fuel	Motor code
---------	--	------	------------

81808 350981808000



**FLANGIA**  
 Numero Fori Flangia 3  
 Dimensione Fori Flangia M6x1  
 Posizione Flangia 56.5  
 Diametro Mozzo Ø28  
**GIRANTE**  
 Diametro Girante Ø60  
 N° Alette Girante 6  
 Distanza Girante 10.2

**DAIHATSU**

**COPEN**

13 06/2011→ B K3-VE

**MATERIA**

13 06/2011→ B K3-VE

1.3 DVVT Turbo 06/2011→ B

15 06/2011→ B 3SZ-VE

1.5 ECO 4WD 06/2011→ B 3SZ-VE

**SIRION I**

1.3 DVVT 16V 01/2011→05/2011 B K3-VE

1.3 DVVT CX 16V 4x4 01/2011→02/2011 B K3-VE

1.3 Sport 08/2000→05/2011 B K3-VE2

1.3 Sport 4WD 08/2000→05/2011 B K3-VE2

**SIRION II**

13 05/2011→ B K3-VE

13 08/2011→ B K3-VE

1.3 4WD 08/2011→ B K3-VE

1.3 DVVT Executive 4x4 05/2011→ B K3-VE

15 08/2011→ B 3SZ-VE

1.5 4WD 06/2011→08/2011 B 3SZ-VE

**TERIOS II**

1.3 DVVT 05/2011→ B

1.3 DVVT 4x4 05/2011→ B K3-VE

1.5 16V 06/2011→ B 3SZ-VE

1.5 DVVT 05/2011→ B 3SZ-VE

**YRV**

13 01/2011→ B K3-VE

1.3 4WD 01/2011→ B K3-VE

1.3 GTi 02/2011→ B K3-VET

**TOYOTA**

**YARIS I**

1.0 16V 03/2011→ B 1SZ-FE

1.0 16V 04/1999→ B 1SZ-FE

Short **MAGNETI MARELLI** Code



Model

Version		Fuel	Motor code
---------	--	------	------------

81809 350981809000



**FLANGIA**  
 Numero Fori Flangia 3  
 Dimensione Fori Flangia M6x1  
 Diametro Mozzo Ø28  
 Posizione Flangia 50.5  
**GIRANTE**  
 Diametro Girante Ø56.5  
 N° Alette Girante 6  
 Distanza Girante 21.2

**TOYOTA**

**COROLLA VII, Station Wagon, Liftback**

1.4 D 04/2011→ D 1ND-TV

**PRIUS I**

15 05/2000→04/2011 B 1NZ-FXE

**PRIUS II**

15 03/2011→ B 1NZ-FXE

**YARIS I**

13 02/2011→ B 2SZ-FE

1.3 16V 11/1999→ B 2NZ-FE

1.4 D-4D 01/2011→ D 1ND-TV

1.5 TS 03/2011→ B 1NZ-FE

1.5 VVT-i TS 03/2011→05/2011 B

1.5 VVT-i TS 01/2011→ B 1NZ-FE

**YARIS II**

15 05/2011→ B 1NZ-FE

**YARIS Verso**



13 11/1999→ B 2NZ-FE



13 11/1999→ B 2NZ-FE

1.4 D-4D 01/2011→ D 1ND-TV

15 03/2000→ B 1NZ-FE

15 03/2011→ B 1NZ-FE

MAGNETI MARELLI			
Short	Code		
			
Model			
Version		Fuel	Motor code
81810	350981810000		
		<p><b>PULEGGIA</b>            Diametro Puleggia Ø52            Altezza Puleggia 32.8            Posizione Puleggia 50.5</p> <p><b>GIRANTE</b>            Diametro Girante Ø70.3            N° Alette Girante 10            Distanza Girante 7.8</p>	
DACIA			
DUSTER			
1.5 dCi	10/2011→	D	K9K796
1.5 dCi	10/2011→	D	
1.5 dCi	10/2011→	D	
1.5 dCi 4x4	10/2011→	D	
1.5 dCi 4x4	10/2011→	D	
1.5 dCi 4x4	10/2011→	D	
LOGAN, Station Wagon, Van			
1.5 dCi	06/2011→	D	K9K792
1.5 dCi	05/2011→	D	K9K790
1.5 dCi	07/2011→	D	K9K796
SANDERO			
1.5 dCi	08/2011→	D	K9K792
1.5 dCi	08/2011→	D	K9K796
NISSAN			
ALMERA II, Hatchback			
1.5 dCi	03/2011→	D	K9K722
KUBISTAR			
1.5 dCi	03/2011→	D	K9K722
1.5 dCi	03/2011→	D	K9K704
MICRA III (K12), MICRA C+C			
1.5 dCi	03/2011→	D	K9K704
1.5 dCi	05/2011→	D	
1.5 dCi	05/2011→	D	
1.5 dCi	03/2011→	D	K9K722
NOTE			
1.5 dCi	06/2011→	D	K9K700
1.5 dCi	06/2011→	D	K9K276
1.5 dCi	08/2011→	D	
QASHQAI			
1.5 dCi	07/2011→	D	
1.5 dCi	08/2011→	D	

MAGNETI MARELLI			
Short	Code		
			
Model			
Version		Fuel	Motor code
RENAULT			
CLIO II, Van			
1.5 D	04/2011→	D	K9K714
1.5 dCi	04/2011→	D	K9K712
1.5 dCi	07/2011→	D	K9K718
1.5 DCi	04/2011→	D	K9K714
1.5 dCi	01/2011→	D	K9K700, K9K704
1.5 DCi	01/2011→04/2011	D	K9K702
1.5 dCi	01/2011→	D	K9K702, K9K710
1.5 dCi	05/2011→	D	K9K740
CLIO III, GRANDtour			
1.5 D	07/2011→	D	K9K750
1.5 DCi	05/2011→06/2011	D	K9K752
1.5 dCi	05/2011→	D	K9K766
1.5 dCi	05/2011→	D	K9K764
1.5 dCi	05/2011→	D	K9K772
1.5 dCi	05/2011→	D	
1.5 dCi	05/2011→	D	K9K768
KANGOO I			
1.5 dCi	05/2011→	D	K9K714
1.5 dCi	05/2011→	D	K9K718
1.5 dCi	02/2011→	D	K9K702, K9K710
1.5 dCi	01/2011→	D	K9K700, K9K704
1.5 dCi	02/2011→	D	K9K704
KANGOO II, BePop			
1.5 dCi	08/2011→	D	K9K802
1.5 dCi	08/2011→	D	K9K804, K9K806
1.5 dCi	08/2011→	D	K9K840
LAGUNA III, GRANDtour			
1.5 dCi	07/2011→	D	K9K780
LOGAN, Station Wagon			
1.5 DCi	07/2011→	D	K9K792
MEGANE II, Station Wagon, C-C, Scenic			
1.5 dCi	07/2011→	D	K9K728
1.5 dCi	05/2011→	D	K9K724
1.5 dCi	05/2011→	D	K9K732
1.5 dCi	03/2011→	D	K9K729
1.5 dCi	02/2011→	D	K9K722
MEGANE III, Station Wagon, C-C, Scenic			
1.5 dCi	09/2011→	D	K9KG832
MODUS			
1.5 dCi	05/2011→	D	K9K764
1.5 dCi	07/2011→	D	K9K772
1.5 dCi	05/2011→	D	
1.5 dCi	04/2011→	D	K9K752

Short	Code
-------	------



Model			
Version		Fuel	Motor code
<b>81810</b>			<b>350981810000</b>
<b>RENAULT</b>			
<b>MODUS</b>			
1.5 dCi	04/2011→	D	K9K768
1.5 dCi	04/2011→	D	K9K766
1.5 dCi 75	10/2011→	D	
1.5 dCi 90	10/2011→	D	
<b>SCENIC I, GRAND SCENIC</b>			
1.5 dCi	04/2011→	D	K9K728
1.5 dCi	05/2011→	D	K9K728
<b>SCENIC II, GRAND SCENIC</b>			
1.5 dCi	07/2011→	D	K9K728
1.5 dCi	05/2011→	D	K9K722
1.5 dCi	05/2011→	D	K9K732
1.5 dCi	03/2011→	D	K9K722
1.5 dCi	03/2011→	D	K9K728
<b>SCENIC III, GRAND SCENIC</b>			
1.5 dCi	09/2011→	D	K9K832
<b>THALIA</b>			
1.5 dCi	03/2011→	D	
1.5 dCi	02/2011→	D	K9K700
1.5 dCi	01/2011→	D	K9K702
1.5 DCi RT	01/2011→03/2011	D	K9K702
<b>TWINGO II</b>			
1.5 dCi	07/2011→	D	K9K740
1.5 dCi	08/2011→	D	K9K718
<b>SUZUKI</b>			
<b>JIMNY</b>			
1.5 DDiS	05/2011→	D	
1.5 DDiS 4WD	03/2011→	D	K9K700

81811	350981811000
-------	--------------



<b>PULEGGIA</b>	
Diametro Puleggia	Ø144
Numero Denti/Gole Puleggia	1
Posizione Puleggia	29.5
<b>GIRANTE</b>	
Diametro Girante	Ø67
N° Alette Girante	8
Distanza Girante	18

RENAULT			
19 I, CHAMADE, Van, Cabrio			
1.1 TR	07/1988→04/1992	B	C1E700
12	01/1988→12/1992	B	C1G730

Short	Code
-------	------



Model			
Version		Fuel	Motor code
<b>19 I, CHAMADE, Van, Cabrio</b>			
14	07/1988→04/1992	B	C2J772, C3J710
<b>19 II, CHAMADE, Van, Cabrio</b>			
12	04/1992→12/1995	B	C1G730
14	04/1992→12/1995	B	C3J710
<b>21, Station Wagon, Van</b>			
	09/1989→05/1993	B	C2J770
14	06/1988→10/1993	B	C2J770
<b>CLIO I, Van</b>			
11	01/1991→09/1998	B	C1E700
11	04/1992→08/1992	B	C1E700
<b>RAPID, Express</b>			
10	02/1986→05/1992	B	
11	07/1985→04/1995	B	C1E750, C1E752, C1E754, C1E756, C1E760, C1E762, C1E792
12	09/1991→03/1998	B	C3G710, C3G712
14	07/1985→03/1998	B	C1J768, C1J780, C3J700, C3J702, C3J760, C3J762
1.4 RN	09/1991→08/1993	B	E6J734
<b>Super 5, Van</b>			
11	01/1986→03/1995	B	C1E750, C1E752, C1E756, C1E760
11	10/1984→12/1996	B	C1E750, C1E752, C1E754
12	01/1987→12/1996	B	
14	10/1984→12/1996	B	C1J768, C1J780, C3J700, C3J702, C3J760



81812	350981812000
-------	--------------





<b>FLANGIA</b>	
Numero Fori Flangia	3
Dimensione Fori Flangia	M6x1
Posizione Flangia	74
<b>GIRANTE</b>	
Diametro Girante	Ø66.8
N° Alette Girante	8
Distanza Girante	16.7

ALFA ROMEO			
159, Sportwagon			
1.9 JTS	05/2011→	B	939A6.000
2.2 JTS	05/2011→	B	939A5.000
<b>BRERA</b>			
2.2 JTS	06/2011→	B	939A5.000
<b>SPIDER IV</b>			
2.2 JTS	06/2011→	B	939A5.000



MAGNETI MARELLI			
Short	Code		
			
<b>Model</b>			
Version		Fuel	Motor code
<b>81812 350981812000</b>			
<b>FIAT</b>			
<b>CROMA II</b>			
2.2 16V	05/2011→	B	194A1.000
<b>OPEL</b>			
<b>ASTRA G, Station Wagon, Cabrio</b>			
2.2 16V	09/2000→05/2011	B	Z22SE
<b>GT II</b>			
20	07/2011→	B	Z20NHH
<b>INSIGNA, Station Wagon</b>			
2.0 Turbo	08/2011→	B	A20NHT
2.0 Turbo 4x4	08/2011→	B	A20NHT
<b>SIGNUM</b>			
2.0 Turbo	03/2011→	B	Z20NET
2.2 direct	03/2011→	B	Z22YH
<b>OMEGA</b>			
22	09/2000→	B	Z22SE
<b>VECTRA B, Station Wagon</b>			
2.2 i 16V	09/2000→03/2011	B	Z22SE
<b>VECTRA C, Station Wagon, GTS</b>			
2.0 16V Turbo	03/2011→	B	Z20NET
2.0 Turbo	03/2011→	B	Z20NET
2.2 16V	02/2011→	B	Z22SE
2.2 direct	03/2011→	B	Z22YH
<b>ZAFIRA A</b>			
2.2 16V	09/2000→05/2011	B	Z22SE
<b>ZAFIRA B</b>			
22	05/2011→	B	Z22YH
<b>SAAB</b>			
<b>9-3 II, 9-3 X, Station Wagon, Cabrio</b>			
1.8 t	02/2011→	B	B207E
1.8 t BioPower	07/2011→	FF	B207L
1.8 t BioPower	07/2011→	FF	B207E
20	06/2011→07/2011	B	
2.0 T	09/2011→	B	
2.0 t	05/2011→	B	B207E
2.0 T	09/2011→	B	
2.0 t	02/2011→	B	B207L
2.0 T	02/2011→	B	B207R
2.0 t BioPower	07/2011→	FF	B207L
2.0 T BioPower	09/2011→	BF	B207R
2.0 t BioPower	07/2011→	FF	
2.0 t BioPower	07/2011→	FF	
2.0 T BioPower	02/2011→	FF	B207R
2.0 T XWD	08/2011→	B	B207R

MAGNETI MARELLI			
Short	Code		
			
<b>Model</b>			
Version		Fuel	Motor code
<b>9-3 II, 9-3 X, Station Wagon, Cabrio</b>			
2.0 Turbo Performance	04/2011→	B	
2.0 Turbo XWD	02/2011→	B	B207R
<b>9-5 II, Station Wagon</b>			
2.0 T	10/2011→	B	A20NHT
2.0 T BioPower	10/2011→	FF	A20NHT
2.0 T BioPower XWD	10/2011→	FF	A20NHT
2.0 T XWD	10/2011→	B	A20NHT
<b>VAUXHALL</b>			
<b>ASTRA</b>			
2.2 16V	01/2011→	B	Z22SE
<b>SIGNUM</b>			
2.2 i	03/2011→	B	Z22YH
<b>ZAFIRA</b>			
2.2 16V	09/2000→05/2011	B	Z22SE

**81813 350981813000**



<b>PULEGGIA</b>	
Diametro Puleggia	Ø69.7
Numero Denti/Gole Puleggia	28
Altezza Puleggia	36.1
Posizione Puleggia	54.15
<b>GIRANTE</b>	
Diametro Girante	Ø59.5
N° Alette Girante	8
Distanza Girante	49.4

<b>CITROËN</b>			
<b>C 5 I, Break</b>			
3.0 Carlsson HP	01/2011→04/2011	B	
3.0 V6	01/2011→04/2011	B	XFX (ES9J4S)
Carlsson	03/2011→04/2011	B	
<b>C 5 II, Break</b>			
30	04/2011→	B	
3.0 Carlsson HP	04/2011→	B	
3.0 V6	04/2011→	B	XFV (ES9A), XFX (ES9J4S)
<b>C 5 III, Break</b>			
30	08/2011→	B	XFV (ES9A)
3.0 V6	08/2011→	B	XFU (ES9A)
<b>C 6</b>			
3.0 V6	05/2011→	B	ES9J4S
<b>C 8</b>			
3.0 V6	02/2011→	B	XFX (ES9J4S)
<b>FIAT</b>			
<b>ULYSSE II</b>			
3.0 V6	02/2011→	B	XFW

Short	Code
-------	------



Model			
Version		Fuel	Motor code
<b>81813</b>	<b>350981813000</b>		
<b>LANCIA</b>			
<b>PHEDRA</b>			
3.0 V6	02/2011→	B	ES9J4S
<b>PEUGEOT</b>			
<b>406, Break, Coupé</b>			
3.0 V6	03/2000→04/2011	B	AFX (ES9J4S)
<b>407, Break, Coupé</b>			
30	04/2011→	B	XFV (ES9A)
3.0 V6	05/2011→	B	XFV (ES9A)
<b>607</b>			
3.0 V6 24V	02/2000→	B	AFX (ES9J4S)
3.0 V6 24V	04/2011→	B	XFV (ES9A)
<b>807</b>			
3.0 V6	02/2011→	B	AFX (ES9J4S)
<b>RENAULT</b>			
<b>AVANTIME</b>			
3.0 V6	01/2011→03/2011	B	L7X720, L7X721
<b>CLIO II, Van</b>			
3.0 V6 Sport	11/2000→02/2011	B	L7X760
3.0 V6 Sport	02/2011→	B	L7X762
<b>LAGUNA II, GRANDtour</b>			
3.0 V6 24V	01/2011→	B	L7X731
3.0 V6 24V	01/2011→	B	L7X731

Short	Code
-------	------



**PULEGGIA**

Diametro Puleggia Ø54  
 Altezza Puleggia 37  
 Posizione Puleggia 48.5

**GIRANTE**



Diametro Girante Ø70.3  
 N° Alette Girante 10  
 Distanza Girante 7.8



<b>MITSUBISHI</b>			
<b>CARISMA</b>			
1.9 DI-D	09/2000→06/2011	D	F9Q2
1.9 DI-D	09/2000→06/2011	D	F9Q1
<b>SPACE STAR</b>			
1.9 DI-D	01/2011→	D	F9Q1
1.9 DI-D	02/2011→	D	F9Q2
<b>NISSAN</b>			
<b>INTERSTAR</b>			
dCi 80	02/2011→	D	F9Q772

Short	Code
-------	------



Model			
Version		Fuel	Motor code
<b>PRIMASTAR</b>			
20	01/2011→	B	F4R720, F4R722
dCi 100	01/2011→	D	F9Q760
dCi 80	01/2011→	D	F9Q762
<b>OPEL</b>			
<b>MOVANO A</b>			
1.9 DTI	01/2011→	D	F9Q774
<b>VIVARO</b>			
1.9 DI	01/2011→	D	F9Q762, F9Q774
1.9 DTI	01/2011→	D	F9Q760
2.0 16V	01/2011→	B	F4R720
2.0 ECOTEC	06/2011→	B	F4R820
<b>RENAULT</b>			
<b>AVANTIME</b>			
2.0 16V Turbo	01/2011→03/2011	B	F4R760, F4R761
<b>CLIO III, GRANDtour</b>			
2.0 16V Sport	06/2011→	B	F4R830
2.0 16V Sport	08/2011→	B	F4R830
<b>ESPACE IV</b>			
1.9 dCi	02/2011→	D	F9Q680, F9Q820, F9Q826
1.9 DCi Expression	03/2011→05/2011	D	F9Q820
20	05/2011→	B	F4R897
20	02/2011→05/2011	B	F4R790
20	02/2011→	B	F4R790, F4R792
2.0 Turbo	02/2011→	B	F4R794, F4R795, F4R797
<b>LAGUNA I, GRANDtour</b>			
1.9 dCi	09/1999→01/2011	D	F9Q718
2.0 16V	09/1999→01/2011	B	F4R780
<b>LAGUNA II, GRANDtour</b>			
1.8 16V	01/2011→	B	F4P770, F4P771, F4P773, F4P774, F4P775
1.8 16V	01/2011→	B	F4P770, F4P773
1.8 16V	01/2011→	B	F4P770, F4P774
1.8 16V	01/2011→	B	F4P770, F4P774
1.9 dCi	01/2011→	D	F9Q750, F9Q756
1.9 dCi	01/2011→	D	F9Q718
1.9 dCi	01/2011→	D	F9Q752
1.9 dCi	01/2011→	D	F9Q754
20	02/2011→05/2011		F4R713
2.0 16V	05/2011→	B	F4R886
2.0 16V	05/2011→	B	F4R786, F4R787
2.0 16V	02/2011→	B	F4R712, F4R713, F4R714, F4R715
2.0 16V IDE	01/2011→	B	F5R700
2.0 16V Turbo	03/2011→	B	F4R764, F4R765, F4R786, F4R787

MAGNETI MARELLI			
Short	Code		
			
<b>Model</b>			
Version		Fuel	Motor code
<b>81814</b>	<b>350981814000</b>		
<b>RENAULT</b>			
<b>LAGUNA III, GRANDtour</b>			
2.0 16V Turbo	07/2011→	B	F4R811
2.0 GT	08/2011→	B	F4R800, F4Rt800
<b>MASTER II</b>			
1.9 dCi 80	01/2011→	D	F9Q772
<b>MEGANE I, Coach, Grantour, Scenic</b>			
1.9 dCi	01/2011→03/2011	D	F9Q732, F9Q733, F9Q738
<b>MEGANE II, Station Wagon, C-C, Scenic</b>			
20	03/2011→	B	F4R770
20	06/2011→	B	
2.0 16V	02/2011→	B	F4R770
2.0 16V Turbo	04/2011→	B	F4R776
2.0 Renault Sport	04/2011→	B	F4R774
<b>MEGANE III, Station Wagon, C-C, Scenic</b>			
20	08/2011→	B	F4R870
2.0 16V	08/2011→	B	F4R870
2.0 TCe	10/2011→	B	
<b>SCENIC I, GRAND SCENIC</b>			
20	04/2011→	B	F4R770
20	04/2011→	B	F4R776
<b>SCENIC II, GRAND SCENIC</b>			
20	03/2011→	B	F4R770, F4R771
2.0 16V Turbo	04/2011→	B	F4R776
<b>TRAFIC II</b>			
1.9 DCi	01/2011→03/2011	D	F9Q762
1.9 dCi 100	01/2011→	D	F9Q760
1.9 dCi 80	01/2011→	D	F9Q762
20	01/2011→	B	F4R720, F4R722
2.0 16V	06/2011→	B	F4R820
dCi 100	01/2011→	D	F9Q760
dCi 80	01/2011→	D	F9Q762
<b>VEL SATIS</b>			
20	05/2011→	B	F4R867
2.0 16 V Turbo	04/2011→	B	F4R766
2.0 16V Turbo	02/2011→	B	F4R762, F4R763
<b>VAUXHALL</b>			
<b>MOVANO</b>			
1.9 DTI	09/2000→01/2011	D	F9Q770
1.9 DTI	01/2011→	D	F9Q774
<b>VIVARO</b>			
1.9 DI	01/2011→	D	
1.9 DTI	01/2011→	D	F9Q760

MAGNETI MARELLI			
Short	Code		
			
<b>Model</b>			
Version		Fuel	Motor code
<b>VOLVO</b>			
<b>S40 I</b>			
1.9 DI	07/2000→03/2011	D	D4192T3
1.9 DI	07/2000→03/2011	D	D4192T4
<b>V40 Station Wagon</b>			
1.9 DI	07/2000→04/2011	D	D4192T3
1.9 DI	07/2000→04/2011	D	D4192T4

81815	350981815000		
-------	--------------	--	--



#### FLANGIA

Numero Fori Flangia	4
Dimensione Fori Flangia	M6x1
Posizione Flangia	76.5
Diametro Mozzo	Ø28

#### GIRANTE

Diametro Girante	Ø58
N° Alette Girante	7
Distanza Girante	10

TOYOTA			
<b>CARINA E (T19), Station Wagon</b>			
16	01/1993→09/1997	B	4A-FE
16	12/1993→09/1997	B	4A-FE
16	12/1993→09/1997	B	4A-FE
1.6 GLI	04/1992→09/1997	B	4A-FE
<b>CELICA V, Cabrio, Coupé</b>			
1.6 STI	10/1989→01/1994	B	4A-FE
<b>COROLLA V, Station Wagon, Liftback, Compact</b>			
1.6 GLI	07/1992→04/1997	B	4A-FE
1.6 Si	07/1992→04/1997	B	4A-FE
<b>COROLLA VI, Station Wagon, Liftback, Compact</b>			
16	04/1997→02/2000	B	4A-FE
1.6 Aut.	04/1997→02/2000	B	4A-FE
1.6 Aut.	04/1997→02/2000	B	4A-FE

Short	Code
-------	------



### Model

Version		Fuel	Motor code
---------	--	------	------------

81816 350981816000



#### PULEGGIA

Diametro Puleggia Ø56  
 Numero Denti/Gole Puleggia 19  
 Altezza Puleggia 33.5  
 Posizione Puleggia 52.2

#### GIRANTE

Diametro Girante Ø64  
 N° Alette Girante 8  
 Distanza Girante 47.5

### AUDI

#### A3 I

1.9 TDI	08/2000→	D	ASZ
1.9 TDI	10/2000→	D	ATD, AXR
1.9 TDI quattro	08/2000→	D	ASZ

#### A3 II, Sportback, Cabriolé

2.0 TDI	06/2011→	D	BMN
2.0 TDI	08/2011→	D	CBAB
2.0 TDI	03/2011→	D	AZV, CBAA
2.0 TDI	05/2011→	D	BMM
2.0 TDI	06/2011→08/2011	D	BUY
2.0 TDI 16V	03/2011→	D	BKD
2.0 TDI 16V quattro	04/2011→	D	BKD
2.0 TDI quattro	06/2011→	D	BMM
2.0 TDI quattro	06/2011→	D	BMN
2.0 TDI quattro	03/2011→	D	AZV

#### A4 I, Avant

1.9 TDI	03/2000→01/2011	D	AJM
1.9 TDI quattro	03/2000→01/2011	D	AJM, ATJ

#### A4 II, Avant

1.9 TDI	01/2011→04/2011	D	AVB
1.9 TDI	04/2011→04/2011	D	BKE
1.9 TDI	11/2000→04/2011	D	AVF, AWX
1.9 TDI quattro	01/2011→04/2011	D	AVF
2.0 TDI	06/2011→	D	BPW
2.0 TDi	05/2011→07/2011	D	BVF

#### A4 III, Avant

1.9 TDI	04/2011→	D	BKE
2.0 TDI	06/2011→	D	BVA
2.0 TDI	06/2011→	D	BRD
2.0 TDI	05/2011→06/2011	D	BVG
2.0 TDI	04/2011→	D	BPW
2.0 TDI	04/2011→	D	BNA
2.0 TDi	05/2011→08/2011	D	BVF
2.0 TDI 16V	04/2011→	D	BLB, BRE

Short	Code
-------	------



### Model

Version		Fuel	Motor code
---------	--	------	------------

#### A4 III, Avant

2.0 TDI quattro	06/2011→	D	BPW
2.0 TDI quattro	06/2011→	D	BRD
2.0 TDI quattro	06/2011→	D	BVA

#### A4 IV, Avant

2.0 TDI	08/2011→	D	CAHA
2.0 TDi	08/2011→	D	CAGC
2.0 TDI	08/2011→	D	CAHB
2.0 TDI	07/2011→	D	CAGA
2.0 TDI	07/2011→	D	CAGB
2.0 TDi quattro	08/2011→	D	CAHA
2.0 TDI quattro	08/2011→	D	CAGA

#### A4 IV, Avant, Allroad

2.0 TDI quattro	09/2011→	D	
2.0 TDI quattro	09/2011→	D	CAHB
2.0 TDI quattro	09/2011→	D	CAHA
2.0 TDI quattro	09/2011→	D	CAGA
2.0 TDI quattro	09/2011→	D	CAGB

#### A5, Cabriolé

2.0 TDI	08/2011→	D	CAHB
2.0 TDI	08/2011→	D	CAHA
2.0 TDI	08/2011→	D	
2.0 TDI quattro	08/2011→	D	CAHA
2.0 TDI quattro	08/2011→	D	

#### A5, Cabriolet, Sportback

2.0 TDI	09/2011→	D	CAGA, CMEA
2.0 TDI	09/2011→	D	CAGB
2.0 TDI	09/2011→	D	CAHA
2.0 TDI	09/2011→	D	CAHB
2.0 TDI quattro	09/2011→	D	CAHA

#### A6 II, Avant

1.9 TDI	07/2000→05/2011	D	AJM
1.9 TDI	01/2011→05/2011	D	AVF, AWX

#### A6 III, Avant, Allroad

2.0 TDI	09/2011→	D	CAHB
2.0 TDI	04/2011→	D	BNA, BRF
2.0 TDI	04/2011→08/2011	D	BLB, BRE
2.0 TDI	05/2011→06/2011	D	BVG
2.0 TDI	08/2011→	D	CAHA

#### Q5

2.0 TDI	09/2011→	D	CAGB
2.0 TDI	09/2011→	D	CAGA

#### TT II, Coupé, Roadster



2.0 TDI quattro	08/2011→	D	CBBB
-----------------	----------	---	------

MAGNETI MARELLI			
Short	Code		
<b>Model</b>			
Version		Fuel	Motor code
81816			350981816000
<b>CHRYSLER</b>			
<b>SEBRING III, Cabrio</b>			
2.0 CRD	07/2011→	D	
<b>DODGE</b>			
<b>AVENGER</b>			
2.0 CRD	07/2011→	D	ECD
<b>CALIBER</b>			
2.0 CRD	06/2011→	D	ECD
<b>JOURNEY</b>			
2.0 CRD	08/2011→	D	ECE
<b>FORD</b>			
<b>GALAXY I</b>			
1.9 TDI	03/1995→06/2011	D	1Z, AHU, ANU
1.9 TDI	04/2000→06/2011	D	AUY
<b>JEEP</b>			
<b>COMPASS</b>			
2.0 CRD	06/2011→	D	
2.0 D	06/2011→	D	
<b>Patriot</b>			
2.0 TD	08/2011→	D	ECD
<b>MITSUBISHI</b>			
<b>GRANDis II</b>			
2.0 DI-D	07/2011→	D	BWC
2.0 DI-D	05/2011→	D	BSY
<b>LANCER Sportback</b>			
2.0 DI-D	08/2011→	D	BKD
<b>LANCER VIII, Station Wagon</b>			
2.0 DI-D	08/2011→	D	BKD
<b>OUTLANDER II</b>			
2.0 DI-D	07/2011→	D	BSY
<b>SEAT</b>			
<b>ALHAMBRA I</b>			
1.9 TDI	04/1996→	D	1Z, AHU, ANU
1.9 TDI	05/2011→	D	ARL
1.9 TDI	06/2000→	D	AUY
1.9 TDI 4motion	01/2011→	D	AUY, BVK
2.0 TDI	05/2011→	D	BRT
<b>ALTEA, ALTEA XL</b>			
2.0 TDI	04/2011→09/2011	D	AZV
2.0 TDI	04/2011→	D	BKD
2.0 TDI	06/2011→	D	BMN
2.0 TDI	05/2011→	D	BMM
2.0 TDI 16V	06/2011→	D	BKD
2.0 TDI 16V	06/2011→09/2011	D	AZV

MAGNETI MARELLI			
Short	Code		
<b>Model</b>			
Version		Fuel	Motor code
<b>ALTEA, ALTEA XL</b>			
2.0 TDI 4WD	07/2011→	D	BMM
2.0 TDI 4WD	07/2011→	D	BMN
<b>EXEO, EXEO ST</b>			
2.0 TDI	09/2011→	D	CAGA
2.0 TDI	09/2011→	D	CAHA
2.0 TDI	08/2011→	D	CAGC
<b>IBIZA IV</b>			
1.9 TDI Cupra R	04/2011→	D	ARL
1.9 TDI Cupra R	04/2011→08/2011	D	BPX
<b>LEON I</b>			
1.9 TDI	01/2011→06/2011	D	ARL
1.9 TDI	03/2011→06/2011	D	ASZ
1.9 TDI	05/2011→06/2011	D	AXR
1.9 TDI Syncro	02/2011→06/2011	D	ARL
<b>LEON II</b>			
2.0 D	05/2011→	D	AZV
2.0 TDI	06/2011→	D	BMN
2.0 TDI	05/2011→	D	AZV
2.0 TDI	05/2011→	D	BMM
2.0 TDI 16V	05/2011→	D	BKD
<b>TOLEDO II</b>			
1.9 TDI	03/2011→06/2011	D	ASZ
1.9 TDI	10/2000→06/2011	D	ARL
<b>TOLEDO III</b>			
2.0 TDI	04/2011→09/2011	D	BKD
<b>SKODA</b>			
<b>OCTAVIA I, Station Wagon</b>			
1.9 TDI	03/2011→	D	ASZ
1.9 TDI 4x4	09/2000→	D	ATD
<b>OCTAVIA II, Station Wagon</b>			
2.0 TDI	06/2011→	D	BMN
2.0 TDI	05/2011→	D	BMM
2.0 TDI 16V	04/2011→	D	AZV
2.0 TDI 16V	04/2011→	D	BKD
2.0 TDI 16V 4x4	06/2011→	D	BMM
<b>SUPERB I</b>			
1.9 TDI	02/2011→08/2011	D	AVF, AWX
1.9 TDI	02/2011→05/2011	D	AVB
1.9 TDI	05/2011→07/2011	D	BSV
2.0 TDI	05/2011→08/2011	D	BSS
<b>SUPERB II, Station Wagon</b>			
2.0 TDI	08/2011→	D	BMP
2.0 TDI	08/2011→	D	CBBB, CFGB
2.0 TDI 16V	09/2011→	D	BKD, CFFB, CLJA



MAGNETI MARELLI			
Short	Code		
<b>Model</b>			
Version		Fuel	Motor code
81816	350981816000		
<b>SKODA</b>			
<b>SUPERB II, Station Wagon</b>			
2.0 TDI 4x4	08/2011→	D	CBBB, CFGB
<b>YETI</b>			
2.0 TDI 4x4	09/2011→	D	CBDB, CFHC
2.0 TDI 4x4	09/2011→	D	CEGA, CFJA
<b>VOLKSWAGEN</b>			
<b>BORA, Station Wagon</b>			
1.9 TDI	05/2000→05/2011	D	ARL
1.9 TDI	09/2000→05/2011	D	ATD, AXR
1.9 TDI	11/2000→05/2011	D	ASZ
1.9 TDI	12/1998→01/2011	D	AJM, AUY
1.9 TDI 4motion	02/1999→01/2011	D	AJM, AUY
1.9 TDI 4motion	05/2000→05/2011	D	ARL
1.9 TDI 4motion	09/2000→05/2011	D	ATD
1.9 TDI 4motion	11/2000→05/2011	D	ASZ
<b>CADDY III</b>			
2.0 TDI	07/2011→	D	BMM
<b>EOS</b>			
2.0 TDI	06/2011→08/2011	D	BMM
2.0 TDI 16V	08/2011→	D	CBAB
<b>GOLF IV, Cabrio, Variant</b>			
1.9 TDI	05/2000→05/2011	D	ARL
1.9 TDI	09/2000→06/2011	D	ATD, AXR
1.9 TDI	11/2000→06/2011	D	ASZ
1.9 TDI	12/1998→01/2011	D	AJM, AUY
1.9 TDI 4motion	02/2000→05/2011	D	ARL
1.9 TDI 4motion	05/1999→01/2011	D	AJM, AUY
1.9 TDI 4motion	09/2000→06/2011	D	ATD
1.9 TDI 4motion	11/2000→06/2011	D	ASZ
1.9 TDI GTI	01/2011→06/2011	D	ARL
<b>GOLF V, Plus, Variant</b>			
2.0 D	04/2011→	D	
2.0 GTD	05/2011→	D	BMN
2.0 TDI	09/2011→	D	CBDC
2.0 TDI	03/2011→	D	AZV
2.0 TDI	04/2011→	D	BMM
2.0 TDI 16V	03/2011→	D	BKD
2.0 TDI 16V 4motion	04/2011→	D	BKD
2.0 TDI 4motion	07/2011→	D	AZV
2.0 TDI 4motion	04/2011→	D	BMM
2.0 TDi PF Sportline	05/2011→	D	BVB
<b>GOLF VI, Variant</b>			
2.0 TDI	09/2011→	D	CBBB

MAGNETI MARELLI			
Short	Code		
<b>Model</b>			
Version		Fuel	Motor code
<b>GOLF VI, Variant</b>			
2.0 TDI	09/2011→	D	BMM
2.0 TDI	08/2011→	D	CBAA, CFFA
2.0 TDI	08/2011→	D	CBDC
2.0 TDI	08/2011→	D	CBAB, CBDB
2.0 TDI 4motion	09/2011→	D	CBAB, CFFB
<b>JETTA III</b>			
2.0 TDI	05/2011→	D	AZV
2.0 TDI	05/2011→	D	BMM
2.0 TDI	06/2011→	D	BMN
2.0 TDI 16V	05/2011→	D	CBDB
<b>NEW BEETLE, Cabrio</b>			
1.9 TDI	03/2011→	D	AXR
1.9 TDI	05/2011→	D	BSW
<b>PASSAT IV, Variant</b>			
1.9 TDI	02/2000→11/2000	D	AVB
1.9 TDI	08/1998→11/2000	D	AJM, ATJ
1.9 TDI 4motion	08/1999→11/2000	D	AJM, ATJ
<b>PASSAT V, Variant</b>			
1.9 TDI	11/2000→05/2011	D	AVF, AWX
1.9 TDI	11/2000→05/2011	D	AVB
1.9 TDI	11/2000→05/2011	D	AVF, AWX
1.9 TDI 4motion	11/2000→05/2011	D	AVF
1.9 TDI 4motion	11/2000→05/2011	D	AVF
2.0 TDI	03/2011→05/2011	D	BGW
<b>PASSAT VI, Variant, CC</b>			
2.0 BlueTDI	09/2011→	D	CBAC
2.0 TDI	05/2011→	D	BMP
2.0 TDI	05/2011→	D	BMA, CBAA
2.0 TDI	08/2011→	D	CBAB
2.0 TDI	05/2011→	D	BUZ
2.0 TDI	05/2011→06/2011	D	BVE
2.0 TDI	05/2011→	D	BMR, CBBB
2.0 Tdi	05/2011→06/2011	D	BWV
2.0 TDI	08/2011→	D	CBDC
2.0 TDI 16V	05/2011→	D	BKP
2.0 TDI 16V 4motion	05/2011→	D	BKP
2.0 TDI 4motion	05/2011→	D	BMP
2.0 TDI 4motion	09/2011→	D	CBBB
2.0 TDI 4motion	09/2011→	D	CBAB
<b>SCIROCCO III</b>			
2.0 TDI	09/2011→	D	CBBB
2.0 TDI	08/2011→	D	CBDB
<b>SHARAN I</b>			
1.9 TDI	04/2000→	D	AUY

MAGNETI MARELLI			
Short	Code		
			
<b>Model</b>			
Version		Fuel	Motor code
<b>81816</b>	<b>350981816000</b>		
<b>VOLKSWAGEN</b>			
<b>SHARAN I</b>			
1.9 TDI	09/1995→	D	1Z, AHU, ANU
1.9 TDI 4motion	04/2000→	D	AUY
2.0 TDI	05/2011→	D	BRT
<b>TIGUAN</b>			
2.0 TDI	07/2011→	D	CBBB
2.0 TDI	07/2011→	D	CBAB
2.0 TDI	07/2011→	D	CBAA
2.0 TDI FWD	08/2011→	D	CBAB
<b>TOURAN</b>			
2.0 TDI	03/2011→	D	AZV
2.0 TDI	05/2011→	D	BMM
2.0 TDI	05/2011→	D	BMN
2.0 TDI 16V	03/2011→	D	BKD

MAGNETI MARELLI			
Short	Code		
<b>81817</b>	<b>350981817000</b>		
			
<b>PULEGGIA</b>		Diametro Puleggia	Ø57.2
		Numero Denti/Gole Puleggia	23
		Altezza Puleggia	21
		Posizione Puleggia	60.5
<b>GIRANTE</b>		Diametro Girante	Ø56
		N° Alette Girante	8
		Distanza Girante	35

HYUNDAI			
<b>ELANTRA I</b>			
CRDi	06/2011→	D	D4FB
<b>OPEL</b>			
<b>ASTRA G, Station Wagon, Cabrio</b>			
1.4 16V	02/1998→05/2011	B	X14XE, Z14XE
1.6 16V	02/1998→05/2011	B	X16XEL, Z16XE
1.6 CNG	03/2011→04/2011	G	Z16YNG
<b>COMBO II</b>			
1.6 16V	06/2011→	M	Z16YNG
1.6 16V	06/2011→		Z16YNG
<b>CORSA C, Van</b>			
14	09/2000→	B	Z14XE
<b>MERIVA A</b>			
1.6 16V	03/2011→	B	Z16XE
<b>VECTRA B, Station Wagon</b>			
1.6 i 16V	10/1995→02/2011	B	X16XEL, Y16XE, Z16XE

MAGNETI MARELLI			
Short	Code		
			
<b>Model</b>			
Version		Fuel	Motor code
<b>VECTRA C, Station Wagon, GTS</b>			
16	05/2011→	B	Z16XE
1.6 16V	04/2011→	B	Z16XE
<b>ZAFIRA A</b>			
16	02/2011→05/2011	BF	Z16YNG
1.6 16V	04/1999→05/2011	B	X16XEL, Z16XE
1.6 CNG	01/2011→05/2011	G	Z16YNG
<b>ZAFIRA B</b>			
16	06/2011→	M	Z16YNG
1.6 CNG Turbo	09/2011→		Z16XNT
<b>VAUXHALL</b>			
<b>ASTRA</b>			
1.4 16V	02/1998→	B	X14XE, Z14XE
1.6 16V	02/1998→	B	X16XEL, Z16XE
<b>CORSA</b>			
1.4 16V	09/2000→	B	Z14XE
1.4 i 16V	01/1998→	B	X14XE
<b>MERIVA</b>			
1.6 i 16V	03/2011→	B	Z16XE
<b>ZAFIRA</b>			
1.6 16V	04/1999→	B	X16XEL

MAGNETI MARELLI			
Short	Code		
<b>81818</b>	<b>350981818000</b>		
			
<b>PULEGGIA</b>		Diametro Puleggia	Ø56.3
		Numero Denti/Gole Puleggia	19
		Altezza Puleggia	20
		Posizione Puleggia	58.2
<b>GIRANTE</b>		Diametro Girante	Ø56
		N° Alette Girante	8
		Distanza Girante	35

OPEL			
<b>ASTRA G, Station Wagon, Cabrio</b>			
1.4 16V	09/1998→05/2011	B	X14XE, Z14XE
16	09/2000→05/2011	B	Z16SE
16	02/2011→05/2011	B	Z16XEP
1.6 16V	09/1998→05/2011	B	X16XEL, Z16XE
<b>COMBO II</b>			
16	01/2011→	B	Z16SE
16	01/2011→	B	Z16SE
<b>CORSA C, Van</b>			
16	05/2011→06/2011	B	
1.6 X	05/2011→	B	

Short Code



Model			
Version		Fuel	Motor code
81818	350981818000		
<b>OPEL</b>			
<b>MERIVA A</b>			
16	03/2011→	B	Z16SE
<b>VECTRA B, Station Wagon</b>			
1.6 i	10/1995→03/2011	B	X16SZR
<b>VAUXHALL</b>			
<b>ASTRA</b>			
16	09/2000→05/2011	B	Z16SE
<b>MERIVA</b>			
1.6 i	03/2011→	B	Z16SE

81819 350981819000



<b>PULEGGIA</b>		
Diametro Puleggia	Ø74	
Altezza Puleggia	31.5	
Posizione Puleggia	60	
<b>GIRANTE</b>		
Diametro Girante	Ø79	
N° Alette Girante	5	
Distanza Girante	28.8	

AUDI			
<b>A4 II, Avant</b>			
30	01/2011→04/2011	B	BBJ
30	11/2000→05/2011	B	ASN, AVK
3.0 quattro	01/2011→04/2011	B	BBJ
3.0 quattro	01/2011→04/2011	B	ASN, AVK
3.0 quattro	11/2000→05/2011	B	ASN, AVK
<b>A4 III, Avant</b>			
30	04/2011→06/2011	B	BBJ
3.0 quattro	04/2011→06/2011	B	BBJ
<b>A6 II, Avant</b>			
30	01/2011→05/2011	B	ASN
3.0 quattro	01/2011→04/2011	B	BBJ
3.0 quattro	01/2011→05/2011	B	ASN
<b>A6 III, Avant, Allroad</b>			
30	04/2011→06/2011	B	BBJ
3.0 quattro	04/2011→06/2011	B	BBJ
<b>A8 I</b>			
30	03/2011→10/2011	B	BBJ
30	03/2011→10/2011	B	ASN
3.0 Long quattro	03/2011→05/2011	B	ASN
3.0 Long quattro	03/2011→06/2011	B	BBJ

Short Code



Model			
Version		Fuel	Motor code
81820	350981820000		
<b>DACIA</b>			
<b>SANDERO</b>			
1.2 16V	08/2011→	B	D4F732
<b>NISSAN</b>			
<b>KUBISTAR</b>			
1.2 16V	06/2011→	B	D4F712
<b>RENAULT</b>			
<b>CLIO II, Van</b>			
1.2 16V	01/2011→	B	D4F712, D4F714
<b>KANGOO I</b>			
1.2 16V	01/2011→	B	D4F712, D4F714, D4F716
<b>MODUS</b>			
12	05/2011→	B	D4F740
12	04/2011→	B	D4F740
12	04/2011→	B	D4F764
1.2 16V	07/2011→	B	D4F784
1.2 16V Hi-Flex	08/2011→	FF	D4F740
<b>THALIA</b>			
1.2 16V	02/2011→	B	D4F712
<b>TWINGO I, Van</b>			
1.2 16V	01/2011→	B	D4F702, D4F704
1.2 16V	04/2011→	B	D4F708



<b>PULEGGIA</b>		
Diametro Puleggia	Ø56.2	
Altezza Puleggia	27	
Posizione Puleggia	53.4	
<b>GIRANTE</b>		
Diametro Girante	Ø60	
N° Alette Girante	6	
Distanza Girante	5.5	





**Model**

Version		Fuel	Motor code
---------	--	------	------------

81821 350981821000



**FLANGIA**  
 Numero Fori Flangia 4  
 Dimensione Fori Flangia M6x1  
 Posizione Flangia 58.2  
 Diametro Mozzo Ø35.8

**GIRANTE**  
 Diametro Girante Ø56.5  
 N° Alette Girante 6  
 Distanza Girante 21.2

**MINI**

**MINI**

One D	03/2011→	D	1ND
One D	03/2011→	D	

**TOYOTA**

**AURIS**

1.4 D-4D	07/2011→	D	
----------	----------	---	--

**COROLLA Verso II**

1.4 D4d	04/2011→	D	1ND-TV
---------	----------	---	--------

**COROLLA VIII, Station Wagon**

1.4 D-4D	09/2011→	D	1ND-TV
----------	----------	---	--------

**YARIS II**

D-4D	06/2011→	D	1ND-TV
------	----------	---	--------

81822 350981822000



**PULEGGIA**  
 Diametro Puleggia Ø150  
 Numero Denti/Gole Puleggia 3  
 Posizione Puleggia 76

**GIRANTE**  
 Diametro Girante Ø80  
 N° Alette Girante 10  
 Distanza Girante -1

**CITROËN**

**C 25**

1.9 1400	01/1988→01/1994	D	DJY (XUD9A)
1.9 4x4	01/1988→01/1994	D	DJY (XUD9A)
1.9 D	07/1987→02/1994	D	D9B (XUD9A/U)
1.9 TD	04/1992→02/1994	D	M705
2.5 D	10/1985→02/1994	D	CRD93L (U25-661)
2.5 D 4x4	01/1987→02/1994	D	CRD93L (U25-661)
2.5 D Turbo	08/1987→02/1994	D	CRD93LS (U25-673)
2.5 D Turbo 4x4	08/1987→02/1994	D	CRD93LS (U25-673)
2.5 DT 1400	01/1987→01/1994	D	CRD93LS (U25-673)



**Model**

Version		Fuel	Motor code
---------	--	------	------------

**CX II, Break**

25 D	08/1985→12/1992	D	M25-660
25 D Turbo	01/1987→12/1992	D	M25-669
25 D Turbo 2	01/1987→12/1992	D	M25-669
25 GTi	05/1986→12/1992	B	M25-668
25 GTi Turbo 2	08/1985→12/1992	B	M25-662
25 GTi Turbo 2	09/1986→12/1992	B	M25-667
25 i	05/1986→12/1992	B	M25-668
25 TRi	08/1985→12/1992	B	M25-659

**PEUGEOT**

**J5 II**

2.5 D	09/1990→01/1994	D	CRD93
2.5 D	10/1990→	D	CRD93 (U25/661)
2.5 D 4x4	10/1990→	D	CRD93 (U25/661)
2.5 DT	09/1990→01/1994	D	CRD93L
2.5 TD	10/1990→	D	CRD93LS (U25/673)
2.5 TD 4x4	10/1990→	D	CRD93LS (U25/673)

81828 350981828000



**FLANGIA**  
 Numero Fori Flangia 3  
 Dimensione Fori Flangia M8x1.25  
 Posizione Flangia 83  
 Diametro Mozzo Ø28

**GIRANTE**  
 Diametro Girante Ø69  
 N° Alette Girante 9  
 Distanza Girante 17.3

**RENAULT**

**25**

20	04/1984→12/1992	B	J6R706, J6R707, J6R760, J6R762, J6R763
----	-----------------	---	--

**MASTER I**

28-35 2.0	10/1986→07/1998	B	J5R718, J5R728
10991	08/1980→07/1998	B	J7T782, J7T788

**TRAFIC I**

22	05/1989→06/1994	B	J7T780
22	06/1994→10/1997	B	J7T600

Short **MAGNETI MARELLI** Code



Model

Version		Fuel	Motor code
---------	--	------	------------

81832 350981832000



<b>FLANGIA</b>	
Numero Fori Flangia	3
Dimensione Fori Flangia	M8x1.25
Posizione Flangia	94.5
Diametro Mozzo	Ø40
<b>GIRANTE</b>	
Diametro Girante	Ø68
N° Alette Girante	8
Distanza Girante	-0.5

**VOLKSWAGEN**

**TRANSPORTER III**

21	08/1985→07/1992	B	MV
21	08/1985→07/1992	B	DJ
21	10/1986→07/1992	B	SR
2.1 i	07/1989→07/1992	B	SS
2.1 Syncro	01/1986→07/1992	B	DJ
2.1 Syncro	08/1985→07/1992	B	MV
2.1 Syncro	10/1986→07/1992	B	SR

81833 350981833000



<b>PULEGGIA</b>	
Diametro Puleggia	Ø59.3
Numero Denti/Gole Puleggia	20
Altezza Puleggia	21
Posizione Puleggia	32.5
<b>GIRANTE</b>	
Diametro Girante	Ø72
N° Alette Girante	7
Distanza Girante	33

**VOLKSWAGEN**

**LT I**

24	12/1982→07/1992	B	DL
2.4 4WD	12/1982→07/1992	B	DL
2.4 i	08/1989→06/1996	B	1E

Short **MAGNETI MARELLI** Code



Model

Version		Fuel	Motor code
---------	--	------	------------

81834 350981834000



<b>FLANGIA</b>	
Numero Fori Flangia	3
Dimensione Fori Flangia	M8x1.25
Posizione Flangia	78
Diametro Centraggio	Ø50
<b>GIRANTE</b>	
Diametro Girante	Ø93.5
N° Alette Girante	8
Distanza Girante	14.5

**OPEL**

**MOVANO A**

2.5 D	07/1998→09/2000	D	S8U770
2.8 DTI	01/1999→01/2011	D	S9W702

**RENAULT**

**MASTER II**

2.5 D	07/1998→01/2011	D	S8U770
2.8 dTI	07/1998→01/2011	D	S9W702

**VAUXHALL**

**MOVANO**

2.5 D	10/1998→09/2000	D	S8U770
-------	-----------------	---	--------

81835 350981835000



<b>FLANGIA</b>	
Numero Fori Flangia	3
Dimensione Fori Flangia	M8x1.25
Posizione Flangia	82.6
Diametro Mozzo	Ø27.88
<b>GIRANTE</b>	
Diametro Girante	Ø93.5
N° Alette Girante	8
Distanza Girante	14.5

**OPEL**

**MOVANO A**

2.8 DTI	07/1998→01/2011	D	S9W702
---------	-----------------	---	--------

**RENAULT**



**MASTER II**





2.8 dTI	07/1998→01/2011	D	S9W702
---------	-----------------	---	--------

**VAUXHALL**

**MOVANO**

2.8 DTI	10/1998→01/2011	D	S9W702
2.8 TDI	10/1998→01/2011	D	S9W702

MAGNETI MARELLI			
Short	Code		
			
<b>Model</b>			
Version		Fuel	Motor code
81836	350981836000		
		<b>FLANGIA</b> Numero Fori Flangia 3 Dimensione Fori Flangia M6x1 Posizione Flangia 74.9 <b>GIRANTE</b> Diametro Girante Ø70 N° Alette Girante 7 Distanza Girante 4.3	
<b>OPEL</b>			
<b>ASTRA G, Station Wagon, Cabrio</b>			
1.7 CDTI	03/2011→05/2011	D	Z17DTL
1.7 DTI 16V	02/2000→05/2011	D	Y17DT
<b>ASTRA H, Station Wagon, Cabrio, HTC, TwinTop</b>			
1.7 CDTI	07/2011→	D	A17DTR, Z17DTR
1.7 CDTI	07/2011→	D	A17DTJ, Z17DTJ
1.7 CDTI	04/2011→	D	Z17DTH
1.7 CDTI	04/2011→	D	Z17DTL
<b>COMBO II</b>			
14	04/2011→	B	Z14XEP
1.7 CDTI 16V	04/2011→	D	Z17DTH
1.7 DI 16V	01/2011→	D	Y17DTL
1.7 DTI 16V	01/2011→	D	Y17DT
1.7 DTI 16V	04/2011→	D	Z17DTH
<b>CORSA B, Station Wagon, Van</b>			
1.7 DTI	01/2011→	D	Y17DT
<b>CORSA C, Van</b>			
1.7 CDTI	03/2011→	D	Z17DTH
1.7 DI	09/2000→	D	Y17DTL
1.7 DI 16V	09/2000→	D	Y17DTL
1.7 DTI	09/2000→	D	Y17DT
1.7 DTI 16V	09/2000→	D	Y17DT
<b>CORSA D</b>			
1.7 CDTI	10/2011→	D	A17DTS
1.7 CDTI	06/2011→	D	Z17DTR
<b>MERIVA A</b>			
1.7 CDTI	03/2011→	D	Z17DTH
1.7 CDTI	06/2011→	D	Z17DTR
1.7 DTI	03/2011→	D	Y17DT
<b>ZAFIRA B</b>			
1.7 CDTI	08/2011→	D	A17DTJ
1.7 CDTI	08/2011→	D	A17DTR

MAGNETI MARELLI			
Short	Code		
			
<b>Model</b>			
Version		Fuel	Motor code
<b>VAUXHALL</b>			
<b>COMBO</b>			
1.7 DI 16V	01/2011→	D	Y17DTL
<b>81837 350981837000</b>			
		<b>FLANGIA</b> Numero Fori Flangia 4 Dimensione Fori Flangia M6x1 Posizione Flangia 80 Diametro Mozzo Ø24 <b>GIRANTE</b> Diametro Girante Ø55 N° Alette Girante 6 Distanza Girante 5.5	
<b>HYUNDAI</b>			
<b>ATOS, ATOS Prime</b>			
8	04/1999→03/2011	B	
1.0 i	02/1998→02/2011	B	G4HC
1.0 i	01/2011→	B	G4HC-E
11	04/2011→	B	G4HG
11	03/2011→05/2011	B	G4HD
<b>GETZ</b>			
11	02/2011→	B	G4HD
<b>KIA</b>			
<b>PICANTO</b>			
10	05/2011→	B	G4HE
11	04/2011→	B	G4HG
<b>81838 350981838000</b>			
		<b>PULEGGIA</b> Diametro Puleggia Ø56 Numero Denti/Gole Puleggia 19 Altezza Puleggia 44.5 Posizione Puleggia 61 <b>GIRANTE</b> Diametro Girante Ø61 N° Alette Girante 7 Distanza Girante 14	
<b>HONDA</b>			
<b>ACCORD VII, Hatchback, Aerodeck, Coupé</b>			
16	10/1998→02/2011	B	A16A5
1.6 i	10/1998→02/2011	B	D16B6
1.6 LS	10/1998→02/2011	B	D16B7
<b>CIVIC IV, Hatchback, SHUTTLE</b>			
1.4 16V	01/1997→01/2011	B	D14A7

Short Code



Model			
Version		Fuel	Motor code
<b>81838</b>	<b>350981838000</b>		
<b>HONDA</b>			
<b>CIVIC IV, Hatchback, SHUTTLE</b>			
1.4 16V	01/1997→01/2011	B	D14A8
1.5 16V	01/1997→01/2011	B	D15Z8
16	11/1998→10/2000	B	D16W4
1.6 16V	01/1997→01/2011	B	D16B2
<b>CIVIC V, Aerodeck, Hatchback, SHUTTLE</b>			
1.4 16V	04/1998→01/2011	B	D14A8
1.4 16V	04/1998→01/2011	B	D14A7
1.4 i	11/1995→01/2011	B	D14A3
1.5 16V	04/1998→01/2011	B	D15Z8
1.5 i	11/1995→01/2011	B	D15Z6
16	11/1998→10/2000	B	D16W4
1.6 16V	04/1998→01/2011	B	D16B2
1.6 i	03/1996→03/2000	B	D16Y7
1.6 i	11/1995→01/2011	B	D16Y5
1.6 i Vtec	11/1995→01/2011	B	D16Y6, D16Y8
<b>CIVIC VI, Coupé, Hatchback</b>			
1.4 i	01/2011→05/2011	B	
<b>HR-V</b>			
1.6 16V	03/1999→	B	D16W1
1.6 16V 4WD	03/1999→	B	D16W1
1.6 16V 4WD	10/1999→	B	D16W5

**81839** **350981839000**



<b>PULEGGIA</b>		
Diametro Puleggia	Ø65	
Numero Denti/Gole Puleggia	22	
Altezza Puleggia	30	
Posizione Puleggia	47	
<b>GIRANTE</b>		
Diametro Girante	Ø55	
N° Alette Girante	7	
Distanza Girante	18	

HONDA			
CIVIC IV, Hatchback, SHUTTLE			
1.6 i Vtec	01/1994→11/1995	B	B16A2
1.6 VTi	10/1991→01/2011	B	B16A2
1.6 VTi 16V	10/1991→11/1995	B	B16A2
1.8 16V	01/1997→01/2011	B	B18C4
<b>CIVIC V, Aerodeck, Hatchback, SHUTTLE</b>			
1.6 i Vtec	04/1999→12/2000	B	B16A2
1.6 VTi	11/1995→01/2011	B	B16A2
1.8 16V	04/1998→01/2011	B	B18C4

Short Code



Model			
Version		Fuel	Motor code
<b>INTEGRA II</b>			
1.8 Type-R	11/1997→01/2011	B	B18C6

**81840** **350981840000**



<b>PULEGGIA</b>		
Diametro Puleggia	Ø67.3	
Numero Denti/Gole Puleggia	27	
Altezza Puleggia	21	
Posizione Puleggia	56	
<b>GIRANTE</b>		
Diametro Girante	Ø63.6	
N° Alette Girante	8	
Distanza Girante	35.1	

AUDI			
A2			
1.6 FSI	02/2011→05/2011	B	BAD
<b>SEAT</b>			
<b>LEON I</b>			
1.6 16 V	09/2000→06/2011	B	AUS, AZD, BCB
<b>TOLEDO II</b>			
1.6 16V	09/2000→06/2011	B	AUS, AZD
<b>VOLKSWAGEN</b>			
<b>BORA, Station Wagon</b>			
1.6 16V	02/2000→05/2011	B	ATN, AUS, AZD, BCB
1.6 FSI	02/2011→05/2011	B	BAD
<b>GOLF IV, Cabrio, Variant</b>			
1.6 16V	02/2000→06/2011	B	ATN, AUS, AZD, BCB
1.6 16V	03/2011→05/2011	B	AWB
1.6 FSI	02/2011→06/2011	B	BAD
<b>LUPO</b>			
1.6 GTI	09/2000→05/2011	B	AVY
<b>POLO III, Classic, Variant, Van</b>			
1.6 16V GTI	10/1999→01/2011	B	ARC, AVY
120 1.6 16V GTI	09/1998→10/1999	B	AJV

Short	Code
-------	------



### Model

Version		Fuel	Motor code
---------	--	------	------------

81842 350981842000

	<b>PULEGGIA</b> Diametro Puleggia Ø74 Altezza Puleggia 31.5 Posizione Puleggia 60.2
	<b>GIRANTE</b> Diametro Girante Ø79 N° Alette Girante 5 Distanza Girante 29.4

### AUDI

#### A4 I, Avant

24	03/1997→01/2011	B	AGA, ALF, AML, APS, ARJ
24	07/1995→07/1997	B	AFM
24	08/1997→01/2011	B	AJG, AMM, APZ
2.4 quattro	03/1997→01/2011	B	AGA, ALF, AML, APS, ARJ
2.4 quattro	08/1997→01/2011	B	APZ
26	01/1995→01/2011	B	ABC
26	01/1996→07/1997	B	ACZ
2.6 quattro	01/1995→01/2011	B	ABC
2.7 Turbo quattro	02/1999→09/2000	B	AJK
28	09/1995→07/1997	B	AAH
28	10/1996→01/2011	B	ACK, ALG, AMX, APR, AQD
2.8 quattro	01/1995→07/1997	B	AAH
2.8 quattro	10/1996→01/2011	B	ACK, ALG, AMX, APR, AQD
RS4 quattro	05/2000→01/2011	B	ASJ, AZR
S4 quattro	09/1997→01/2011	B	AGB

#### A4 II, Avant

24	01/2011→05/2011	B	BDV
24	01/2011→05/2011	B	AMM

#### A6 I, Avant

24	07/1995→12/1997	B	AFM
26	06/1994→12/1997	B	ABC
26	06/1994→10/1997	B	ACZ
2.6 quattro	06/1994→12/1997	B	ABC
28	06/1994→12/1997	B	AAH, AEJ, AFC
28	12/1995→12/1997	B	ACK
2.8 quattro	06/1994→12/1997	B	AAH, AEJ
2.8 quattro	12/1995→12/1997	B	ACK

#### A6 II, Avant

24	02/1997→05/2011	B	AGA, ALF, AML, APS, ARJ
24	02/1997→05/2011	B	AJG, AMM, APZ
24	02/1997→05/2011	B	APC
24	07/1998→05/2011	B	ALW, ARN, ASM
24	01/2011→05/2011	B	BDV

Short	Code
-------	------



### Model

Version		Fuel	Motor code
---------	--	------	------------

#### A6 II, Avant

2.4 quattro	02/1997→05/2011	B	AJG, APZ
2.4 quattro	02/1997→05/2011	B	AGA, ALF, AML, APS, ARJ
2.4 quattro	01/2011→05/2011	B	BDV
2.4 quattro	08/1998→01/2011	B	APC
27	01/2011→04/2011	B	APB
2.7 quattro	01/2011→04/2011	B	APB
2.7 quattro	03/2011→04/2011	B	BEL
2.7 T	02/1999→05/2011	B	AJK
2.7 T quattro	01/2011→05/2011	B	ARE, BES
2.7 T quattro	12/1997→05/2011	B	AJK, AZA
28	02/1997→05/2011	B	ACK, ALG, AMX, APR, AQD
28	07/1999→05/2011	B	ATX, BBG
28	10/1997→07/1998	B	AGE
2.8 24V	05/1997→07/1999	B	
2.8 quattro	01/1998→04/2000	B	AGE
2.8 quattro	02/1997→05/2011	B	ACK, ALG, AMX, APR, AQD
2.8 quattro	07/1999→01/2011	B	ATX

#### A6 II, Avant, Allroad

2.7 quattro	09/2000→05/2011	B	APB
2.7 T quattro	05/2000→05/2011	B	ARE, BES

#### A8 I

28	04/1996→02/2011	B	ACK, ALG, AMX, APR, AQD
2.8 quattro	04/1996→02/2011	B	ACK, AMX, APR, AQD

### SKODA

#### SUPERB I

2.8 V6	02/2011→08/2011	B	AMX
--------	-----------------	---	-----

### VOLKSWAGEN

#### PASSAT IV, Variant

2.8 Syncro	05/1997→09/1999	B	AGE
2.8 V6	05/1997→09/1999	B	AGE
2.8 V6	08/1996→11/2000	B	ACK, APR, AQD
2.8 V6	09/1999→11/2000	B	ATX, BBG
2.8 V6 4motion	09/1999→11/2000	B	ATX
2.8 V6 Syncro/4motion	10/1996→11/2000	B	ACK, ALG, APR, AQD

#### PASSAT V, Variant

2.8	02/2011→03/2011	B	AMX
2.8 4motion	11/2000→05/2011	B	AMX, ATQ

Short	Code
-------	------

**Model**

Version		Fuel	Motor code
---------	--	------	------------

81843			350981843000
-------	--	--	--------------



<b>PULEGGIA</b>	
Diametro Puleggia	Ø53.25
Numero Denti/Gole Puleggia	18
Altezza Puleggia	31.5
Posizione Puleggia	64
<b>GIRANTE</b>	
Diametro Girante	Ø70
N° Alette Girante	6
Distanza Girante	18.5

**ROVER**
**400 I**

420 GTI/GSI/Vitesse	02/1992→04/1995	B	20M4F
---------------------	-----------------	---	-------

81844			350981844000
-------	--	--	--------------



<b>PULEGGIA</b>	
Diametro Puleggia	Ø69.7
Numero Denti/Gole Puleggia	28
Altezza Puleggia	36.1
Posizione Puleggia	54.2
<b>GIRANTE</b>	
Diametro Girante	Ø69
N° Alette Girante	8
Distanza Girante	57.8

**CITROËN**
**XANTIA I, Break**

3.0 i 24V	01/1997→01/1998	B	XFZ (ES9J4)
-----------	-----------------	---	-------------

**XANTIA II, Break**

3.0 V6	01/1998→03/2011	B	XFZ (ES9J4)
--------	-----------------	---	-------------

**XM II, Break**

3.0 V6	04/1997→10/2000	B	XFZ (ES9J4)
--------	-----------------	---	-------------

**PEUGEOT**
**406, Break, Coupé**

3.0 24V	10/1996→04/2011	B	XFZ (ES9J4)
---------	-----------------	---	-------------

3.0 V6 24V	03/1997→04/2011	B	XFZ (ES9J4)
------------	-----------------	---	-------------

**RENAULT**
**ESPACE III**

3.0 V6 24V	10/1998→02/2011	B	L7X727
------------	-----------------	---	--------

**LAGUNA I, GRANDtour**

3.0 24V	03/1997→01/2011	B	L7X700, L7X701
---------	-----------------	---	----------------

**SAFRANE II**

2.9 24V	03/1999→12/2000	B	L7X713
---------	-----------------	---	--------

3.0 V6	07/1996→12/2000	B	Z7X721, Z7X722, Z7X723
--------	-----------------	---	------------------------

**THALIA**

3.0 V6 Turbo Sport	04/2000→01/2011	B	L7X732
--------------------	-----------------	---	--------

Short	Code
-------	------

**Model**

Version		Fuel	Motor code
---------	--	------	------------

<b>THALIA</b>			
3.0 V6 Turbo Sport	02/2011→	B	L7X762

81845			350981845000
-------	--	--	--------------



<b>PULEGGIA</b>	
Diametro Puleggia	Ø54.55
Numero Denti/Gole Puleggia	3
Posizione Puleggia	33.3
<b>GIRANTE</b>	
Diametro Girante	Ø78.5
N° Alette Girante	6
Distanza Girante	32.2

**FORD**
**COUGAR**

2.5 ST 200	01/2000→01/2011	B	SGA
------------	-----------------	---	-----

2.5 V6 24V	06/2000→01/2011	B	LCBB, LCBC, LCBE
------------	-----------------	---	------------------

2.5 V6 24V	08/1998→01/2011	B	LCBA
------------	-----------------	---	------

**MAVERICK II**

3.0 V6 24V	01/2011→	B	AJ
------------	----------	---	----

**MONDEO I, Station Wagon**

2.5 i 24V	07/1994→08/1996	B	SEA
-----------	-----------------	---	-----

**MONDEO II, Station Wagon**

2.5 24V	09/1996→11/2000	B	SEA
---------	-----------------	---	-----

2.5 24V	10/1999→11/2000	B	SEB
---------	-----------------	---	-----

2.5 ST 200	05/1999→11/2000	B	SGA
------------	-----------------	---	-----

**JAGUAR**
**X-Type, Estate**

2.0 V6	02/2011→05/2011	B	
--------	-----------------	---	--

25	04/2011→	B	
----	----------	---	--

2.5 V6	01/2011→	B	
--------	----------	---	--

30	04/2011→	B	
----	----------	---	--

3.0 V6	01/2011→	B	
--------	----------	---	--

Short **MAGNETI MARELLI** Code



Model

Version Fuel Motor code

81846 350981846000



**FLANGIA**  
 Numero Fori Flangia 3  
 Dimensione Fori Flangia M6x1  
 Posizione Flangia 72.5  
 Diametro Mozzo Ø36  
 Diametro Centraggio Ø39

**GIRANTE**  
 Diametro Girante Ø55  
 N° Alette Girante 6  
 Distanza Girante 29.8

OPEL

**CALIBRA**

2.5 i V6 04/1993→07/1997 B C25XE, X25XE

**OMEGA B, Station Wagon**

2.5 V6 03/1994→09/2000 B X25XE

2.6 V6 09/2000→03/2011 B Y26SE

3.0 V6 04/1994→01/2011 B X30XE

3.2 V6 01/2011→03/2011 B Y32SE

**SIGNUM**

3.2 V6 03/2011→ B Z32SE

**SINTRA**

3.0 i 24V 11/1996→04/1999 B X30XE

**VECTRA A**

2.5 V6 02/1993→11/1995 B C25XE

**VECTRA B, Station Wagon**

2.5 i V6 10/1995→09/2000 B X25XE

2.6 i V6 09/2000→03/2011 B Y26SE

i 500 2.5 05/1998→09/2000 B X25XE

**VECTRA C, Station Wagon, GTS**

3.2 V6 02/2011→ B Z32SE

RENAULT

SAFRANE II

2.5 20V 07/1996→12/2000 B N7U700, N7U701

SAAB

**900 II, Cabrio, Coupé**

2.5 -24 V6 07/1993→02/1998 B B258I

**9000**

3.0 -24 V6 CD/CDE 07/1994→12/1998 B B308I

3.0 -24 V6 CS/CSE 07/1994→12/1998 B B308I

**9-5 I, Station Wagon**

3.0 V6t 01/1998→ B B308E

Short **MAGNETI MARELLI** Code



Model

Version Fuel Motor code

81848 350981848000



**PULEGGIA**  
 Diametro Puleggia Ø70  
 Altezza Puleggia 33.7  
 Posizione Puleggia 63.5

**GIRANTE**  
 Diametro Girante Ø75.5  
 N° Alette Girante 6  
 Distanza Girante 23

OPEL

**FRONTERA B**

3.2 i 10/1998→ B 6VD1, Y32NE

**MONTEREY B**

3.5 V6 24V 07/1998→08/1999 B 6VE1

81851 350981851000



**FLANGIA**  
 Numero Fori Flangia 4  
 Dimensione Fori Flangia M8x1.25  
 Posizione Flangia 90.7  
 Diametro Mozzo Ø23.9

**GIRANTE**  
 Diametro Girante Ø69  
 N° Alette Girante 9  
 Distanza Girante 17.3

RENAULT

**25**

2.1 Diesel 06/1989→12/1992 D J8S736

81852 350981852000



**PULEGGIA**  
 Diametro Puleggia Ø142  
 Numero Denti/Gole Puleggia 4  
 Altezza Puleggia 20  
 Posizione Puleggia 80

**GIRANTE**  
 Diametro Girante Ø67  
 N° Alette Girante 8  
 Distanza Girante 18

RENAULT

**TWINGO I, Van**

12 03/1993→10/1996 B C3G700, C3G702

Short	Code
-------	------



Model

Version		Fuel	Motor code
---------	--	------	------------

81853 350981853000



<b>PULEGGIA</b>	
Diametro Puleggia	Ø147.2
Numero Denti/Gole Puleggia	6
Posizione Puleggia	40.4
<b>GIRANTE</b>	
Diametro Girante	Ø67
N° Alette Girante	8
Distanza Girante	18

RENAULT

RAPID, Express

10	02/1986→05/1992	B	
11	07/1985→04/1995	B	C1E750, C1E752, C1E754, C1E756, C1E760, C1E762, C1E792
12	09/1991→03/1998	B	C3G710, C3G712
14	07/1985→03/1998	B	C1J768, C1J780, C3J700, C3J702, C3J760, C3J762
1.4 RN	09/1991→08/1993	B	E6J734

Super 5, Van

11	01/1986→03/1995	B	C1E750, C1E752, C1E756, C1E760
11	10/1984→12/1996	B	C1E750, C1E752, C1E754
12	01/1987→12/1996	B	
14	10/1984→12/1996	B	C1J768, C1J780, C3J700, C3J702, C3J760

81854 350981854000



<b>PULEGGIA</b>	
Diametro Puleggia	Ø144
Numero Denti/Gole Puleggia	1
Posizione Puleggia	29.5
<b>GIRANTE</b>	
Diametro Girante	Ø67
N° Alette Girante	8
Distanza Girante	18

RENAULT

CLIO I, Van

12	06/1994→02/1998	B	C3G720
----	-----------------	---	--------

RAPID, Express

12	09/1991→03/1998	B	C3G710, C3G712
----	-----------------	---	----------------

TWINGO I, Van

12	03/1993→10/1996	B	C3G700, C3G702
----	-----------------	---	----------------

Short	Code
-------	------



Model

Version		Fuel	Motor code
---------	--	------	------------

81855 350981855000



<b>FLANGIA</b>	
Posizione Flangia	43.15
Diametro Mozzo	M22x1
<b>GIRANTE</b>	
Diametro Girante	Ø70
N° Alette Girante	8
Distanza Girante	45

NISSAN

INTERSTAR

dCi 90	02/2011→	D	G9T722
--------	----------	---	--------

PRIMASTAR

dCi 140	03/2011→	D	G9U730
---------	----------	---	--------

OPEL

MOVANO A

2.2 DTI	09/2000→	D	G9T720
2.5 CDTI	06/2011→	D	
2.5 CDTI	06/2011→	D	G9U632, G9U650
2.5 CDTI	06/2011→	D	G9U650
2.5 DTI	01/2011→	D	G9U720, G9U754
2.5 DTi	03/2011→	D	G9U754
2.5 DTi	03/2011→	D	G9U754

VIVARO

2.5 CDTI	06/2011→	D	G9MB6, G9U630
2.5 CDTI	06/2011→	D	G9U630
2.5 DTI	03/2011→	D	G9U730

RENAULT

AVANTIME

2.2 dCi	02/2011→03/2011	D	G9T712
---------	-----------------	---	--------

ESPACE III

2.2 dCi	07/2000→02/2011	D	G9T710
2.2 dCi	10/2000→02/2011	D	G9T710

ESPACE IV

2.2 dCi	06/2011→	D	G9T645
2.2 dCi	02/2011→	D	G9T742, G9T743



LAGUNA II, GRANDtour

2.2 dCi	05/2011→	D	G9T600
2.2 dCi	01/2011→	D	G9T702
2.2 DCi Authentique	04/2011→05/2011	D	G9T600



MASTER II

2.2 dCi 90	09/2000→	D	G9T722
2.5 dCi 120	01/2011→	D	G9U720, G9U754



MAGNETI MARELLI			
Short	Code		
			
<b>Model</b>			
Version		Fuel	Motor code
<b>81855</b>	<b>350981855000</b>		
<b>RENAULT</b>			
<b>MASTER III</b>			
2.5 dCi 100	03/2011→	D	G9U754
<b>TRAFIC II</b>			
2.5 dCi	03/2011→	D	G9U730
2.5 dCi	06/2011→	D	G9U630
2.5 Dci	07/2011→	D	G9U630
2.5 dCi 115	08/2011→	D	
2.5 dCi 135	01/2011→	D	G9U730
2.5 DTi	03/2011→03/2011	D	G9U730
<b>VEL SATIS</b>			
2.2 dCi	04/2011→	D	G9T600
2.2 dCi	02/2011→	D	G9T702
2.2 dCi	04/2011→	D	G9T600
<b>VAUXHALL</b>			
<b>MOVANO</b>			
2.2 DTI	09/2000→	D	G9T720

MAGNETI MARELLI			
Short	Code		
<b>81856</b>	<b>350981856000</b>		
			
<b>FLANGIA</b>			
Numero Fori Flangia			3
Dimensione Fori Flangia			M8x1.25
Posizione Flangia			31.5
Diametro Mozzo			Ø30
<b>GIRANTE</b>			
Diametro Girante			Ø50
N° Alette Girante			7
Distanza Girante			61.6
<b>SEAT</b>			
<b>LEON I</b>			
2.3 VR5	09/2000→03/2011	B	AQN
<b>TOLEDO II</b>			
2.3 V5	04/1999→01/2011	B	AGZ
2.3 V5 20V	01/2011→06/2011	B	AQN
<b>VOLKSWAGEN</b>			
<b>BORA, Station Wagon</b>			
2.3 V5	10/2000→05/2011	B	AQN
2.3 V5	10/1998→10/2000	B	AGZ
2.3 V5 4motion	10/2000→05/2011	B	AQN
2.3 V5 4motion	12/1998→10/2000	B	AGZ
<b>GOLF IV, Cabrio, Variant</b>			
2.3 V5	08/1997→06/2011	B	AGZ
2.3 V5	10/2000→06/2011	B	AQN
2.3 V5 4motion	10/2000→06/2011	B	AQN

MAGNETI MARELLI			
Short	Code		
			
<b>Model</b>			
Version		Fuel	Motor code
<b>GOLF IV, Cabrio, Variant</b>			
2.3 V5 4motion	12/1998→06/2011	B	AGZ
<b>NEW BEETLE, Cabrio</b>			
2.3 V5	10/2000→	B	AQN
<b>PASSAT IV, Variant</b>			
2.3 VR5	10/1996→11/2000	B	AGZ
2.3 VR5 Syncro/4motion	10/1997→11/2000	B	AGZ
<b>PASSAT V, Variant</b>			
2.3 V5	11/2000→05/2011	B	AZX
2.3 V5 4motion	11/2000→05/2011	B	AZX
2.3 VR5	11/2000→05/2011	B	AZX
2.3 VR5 4motion	11/2000→05/2011	B	AZX

MAGNETI MARELLI			
Short	Code		
<b>81857</b>	<b>350981857000</b>		
			
<b>PULEGGIA</b>			
Diametro Puleggia			Ø62.3
Numero Denti/Gole Puleggia			14
Altezza Puleggia			31.5
Posizione Puleggia			63.5
<b>GIRANTE</b>			
Diametro Girante			Ø71
N° Alette Girante			7
Distanza Girante			14

MAGNETI MARELLI			
Short	Code		
<b>VOLVO</b>			
<b>960 I, Station Wagon</b>			
29	08/1990→07/1994	B	B6304F, B6304S
<b>960 II, Station Wagon</b>			
25	07/1994→12/1996	B	B6254S
29	07/1994→12/1996	B	B6304S
<b>S90</b>			
29	01/1997→05/1998	B	B6304S2
29	01/1997→05/1998	B	B6304G
<b>V90 Station Wagon</b>			
29	01/1997→12/1998	B	B6304S2
29	01/1997→12/1998	B	B6304G

Short	Code
-------	------



Model

Version		Fuel	Motor code
---------	--	------	------------

81858		350981858000	
-------	--	--------------	--

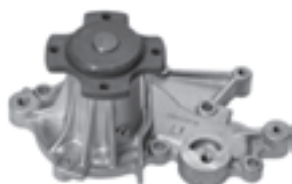

FLANGIA	
Numero Fori Flangia	4
Dimensione Fori Flangia	M6x1
Posizione Flangia	72.2
Diametro Mozzo	Ø43.8
GIRANTE	
Diametro Girante	Ø60
N° Alette Girante	7
Distanza Girante	9.5

**SUBARU**

**JUSTY II**

1.3 4x4	01/2011→03/2011	B	G13BB
1.3 GX 4x4	10/1995→03/2011	B	EF13

**SUZUKI**

**ALTO III**

10	01/2000→	B	G10B
10	09/1994→02/2011	B	G10B

**ALTO IV**

11	02/2011→	B	
----	----------	---	--

**BALENO, Station Wagon**

13	09/1996→02/2011	B	G13BA
1.3 16V	03/1997→02/2011	B	G13BB
1.3 i 16V	07/1995→02/2011	B	G13B

**SWIFT II, Cabrio**

10	03/1989→01/2011	B	G10A
1.0 i	09/1991→01/2011	B	G10A
13	03/1989→01/2011	B	G13A
13	03/1989→01/2011	B	G13A, G13BA
1.3 4WD	03/1989→01/2011	B	G13A
1.3 GTi	03/1989→01/2011	B	G13B

**WAGON R, R+ III**

13	05/2000→	B	G13BB
1.3 4WD	01/2011→	B	

Short	Code
-------	------



Model

Version		Fuel	Motor code
---------	--	------	------------

81861		350981861000	
-------	--	--------------	--



PULEGGIA	
Diametro Puleggia	Ø131
Numero Denti/Gole Puleggia	6
Altezza Puleggia	29
Posizione Puleggia	163
GIRANTE	
Diametro Girante	Ø60
N° Alette Girante	6
Distanza Girante	16

**MINI**

**MINI**

14	03/2011→06/2011	B	
Cooper	01/2011→	B	W10B16A
Cooper S	04/2011→	B	W11B16A
One	01/2011→	B	W10B16A

81862		350981862000	
-------	--	--------------	--



PULEGGIA	
Diametro Puleggia	Ø115
Numero Denti/Gole Puleggia	6
Altezza Puleggia	23
Posizione Puleggia	77.5
GIRANTE	
Diametro Girante	Ø62
N° Alette Girante	6
Distanza Girante	24.5

**ALFA ROMEO**

**MITO**

1.3 JTDM	08/2011→	D	199A3.000
1.3 JTDM	09/2011→	D	

**FIAT**

**500 II, Cabrio**

1.3 D Multijet	09/2011→	D	199B1.000
1.3 D Multijet	07/2011→	D	169A1.000

**DOBLO' I, Cargo**

1.3 D Multijet	05/2011→	D	199A2.000
1.3 D Multijet	05/2011→	D	223A9.000
1.3 JTD	05/2011→	D	199A2.000
1.3 JTD 16V	04/2011→	D	188A9.000
1.3 JTD 16V Multijet	06/2011→	D	

**DOBLO' II, Cargo**

1.3 D Multijet	10/2011→	D	199A3.000
----------------	----------	---	-----------

**FIORINO III**

1.3 D Multijet	08/2011→	D	199A2.000
----------------	----------	---	-----------

MAGNETI MARELLI			
Short	Code		
<b>Model</b>			
Version		Fuel	Motor code
81862	350981862000		
<b>FIAT</b>			
<b>GRANDe PUNTO</b>			
1.3 D Multijet	05/2011→	D	199A3.000
1.3 D Multijet	05/2011→	D	199A2.000
<b>IDEA</b>			
1.3 D Multijet	05/2011→	D	199A3.000
1.3 JTD	04/2011→	D	188A9.000
<b>LINEA</b>			
1.3 D Multijet	07/2011→	D	199A3.000
<b>PALIO, Weekend</b>			
1.3 JTD Multijet	03/2011→	D	188A9.000
<b>PANDA II, Van</b>			
1.3 D 16V Multijet 4x4	03/2011→	D	
1.3 D Multijet	06/2011→	D	169A1.000
1.3 JTD	06/2011→	D	169A1.000
1.3 JTD	03/2011→	D	188A9.000
1.3 JTD 4x4	04/2011→	D	188A9.000
<b>PUNTO Evo</b>			
1.3 16V Multijet	09/2011→	D	
1.3 D Multijet	09/2011→	D	199A2.000, 199A9.000
1.3 D Multijet	09/2011→	D	199B1.000
1.3 D Multijet	09/2011→	D	199A3.000
<b>PUNTO II, Van</b>			
1.3 JTD	03/2011→05/2011	D	188A9.000
1.3 JTD 16V	03/2011→	D	188A9.000
<b>QUBO</b>			
1.3 D Multijet	10/2011→	D	199B1.000
1.3 D Multijet	08/2011→	D	199A2.000
<b>STRADA</b>			
1.3 D Multijet	06/2011→	D	223A9.000
<b>FORD</b>			
<b>KA II</b>			
1.3 TDCi	09/2011→	D	FD4
<b>LANCIA</b>			
<b>MUSA</b>			
1.3 D Multijet	09/2011→	D	
1.3 Multijet	06/2011→	D	199A3.000
1.3 Multijet	04/2011→	D	188A9.000
<b>YPSILON</b>			
1.3 JTD	03/2011→	D	188A9.000
1.3 Multijet	07/2011→	D	
1.3 Multijet	06/2011→	D	199A3.000
1.3 Multijet	06/2011→	D	199A2.000

MAGNETI MARELLI			
Short	Code		
<b>Model</b>			
Version		Fuel	Motor code
<b>OPEL</b>			
<b>AGILA A</b>			
1.3 CDTI	03/2011→	D	Z13DT
<b>AGILA B</b>			
1.3 CDTI	07/2011→	D	Z13DTJ
<b>ASTRA H, Station Wagon, Cabrio, HTC, TwinTop</b>			
1.3 CDTI	05/2011→	D	Z13DTH
<b>ASTRA J</b>			
1.3 CDTI	10/2011→	D	
1.3 CDTI ecoFLEX	09/2011→	D	A13DTE
<b>COMBO II</b>			
1.3 CDTI 16V	04/2011→	D	Z13DT
1.3 CDTI 16V	05/2011→	D	Z13DTJ
<b>CORSA C, Van</b>			
1.3 CDTI	03/2011→	D	Z13DT
1.3 CDTI 16V	05/2011→	D	Z13DT
<b>CORSA D</b>			
1.3 CDTI	10/2011→	D	A13DTR, Z13DTE
1.3 CDTI	06/2011→	D	Z13DTH
1.3 CDTI	06/2011→	D	Z13DTJ
<b>MERIVA A</b>			
1.3 CDTI	05/2011→	D	Z13DT
1.3 CDTI	03/2011→	D	Z13DTJ
<b>MERIVA B</b>			
1.3 CDTI	10/2011→	D	A13DTC
1.3 CDTI	10/2011→	D	A13DTE
<b>TIGRA TwinTop</b>			
1.3 CDTI	04/2011→	D	Z13DT
<b>SUZUKI</b>			
<b>IGNIS II</b>			
1.3 DDiS	03/2011→	D	Z13DT
<b>SPLASH</b>			
1.3 CDTI	08/2011→	D	D13A
<b>SWIFT III</b>			
1.3 DDiS	05/2011→	D	D13A
1.3 DDiS	05/2011→	D	Z13DT
<b>WAGON R, R+ III</b>			
1.3 DDiS	03/2011→	D	Z13DT
<b>TATA (TELCO)</b>			
<b>INDICA VISTA</b>			
13	08/2011→	D	
<b>INDIGO MANZA</b>			
1.3 D	09/2011→	D	169A1.000

Short Code



Model			
Version		Fuel	Motor code
<b>VAUXHALL</b>			
<b>AGILA</b>			
1.3 CDTI	08/2011→	D	Z13DTJ
<b>ASTRA</b>			
1.3 CDTI 16V	09/2011→	D	A13DTE
<b>CORSA</b>			
1.3 CDTI 16V	04/2011→	D	Z13DT
<b>CORSAVAN</b>			
1.3 CDTI 16V	04/2011→	D	Z13DT
<b>TIGRA</b>			
1.3 CDTI	04/2011→	D	Z13DT

81864 350981864000



**PULEGGIA**  
 Diametro Puleggia Ø56.24  
 Numero Denti/Gole Puleggia 19  
 Altezza Puleggia 32  
 Posizione Puleggia 59.6  
**GIRANTE**  
 Diametro Girante Ø71  
 N° Alette Girante 7  
 Distanza Girante 21

VOLVO			
<b>C30</b>			
Version		Fuel	Motor code
2.4 D5	06/2011→	D	D5244T9
D5	06/2011→	D	D5244T8
<b>C70 II Cabrio</b>			
D5	06/2011→	D	D5244T8
<b>S40 II</b>			
24	06/2011→	D	D5244T8
<b>S60 I</b>			
2.4 D	05/2011→	D	D5244T7
2.4 D	01/2011→	D	D5244T2
2.4 D5	01/2011→	D	D5244T
2.4 D5	05/2011→	D	D5244T4
<b>S60 II</b>			
D3	10/2011→	D	D5204T2
D5	10/2011→	D	D5244T10
D5 AWD	10/2011→	D	D5244T10
<b>S80 I</b>			
2.4 D	01/2011→06/2011	D	D5244T2
2.4 D5	01/2011→06/2011	D	D5244T
2.8 T6	05/1998→06/2011	B	B6284T
29	03/1999→06/2011	B	B6294S
29	05/1998→06/2011	B	B6304S3

Short Code



Model			
Version		Fuel	Motor code
<b>S80 I</b>			
30	01/2011→06/2011	B	B6294S2
3.0 T6	01/2011→06/2011	B	B6294T
<b>S80 II</b>			
2.4 D	10/2011→	D	D5244T14
2.4 D	06/2011→	D	D5244T, D5244T5
2.4 D5	06/2011→	D	D5244T4
2.4 D5 AWD	07/2011→	D	D5244T4
D5	10/2011→	D	D5244T10
D5 AWD	10/2011→	D	D5244T10
<b>V50</b>			
24	06/2011→	D	D5244T8
2.4 Tdi	07/2011→	D	D5244T9
<b>V70 II Station Wagon</b>			
2.4 D	05/2011→	D	
2.4 D	01/2011→	D	D5244T2
2.4 D5	01/2011→	D	D5244T
2.4 D5	05/2011→	D	D5244T4
2.4 D5 AWD	03/2011→	D	D5244T2
2.4 D5 AWD	05/2011→	D	D5244T4
<b>V70 III Station Wagon</b>			
2.4 D	07/2011→	D	D5244T5
2.4 D	09/2011→	D	D5244T14
2.4 D5	07/2011→	D	D5244T4
2.4 D5	09/2011→	D	D5244T10
2.4 D5 AWD	07/2011→	D	D5244T4
2.4 D5 AWD	09/2011→	D	D5244T10
<b>XC 60</b>			
D5 AWD	09/2011→	D	D5244T10
<b>XC 70 I Cross Country</b>			
2.4 D5 AWD	05/2011→	D	D5244T4
2.4 D5 XC AWD	02/2011→	D	D5244T
<b>XC 70 II</b>			
2.4 D	10/2011→	D	D5244T14
2.4 D AWD	07/2011→	D	D5244T5
2.4 D5 AWD	07/2011→	D	D5244T4
2.4 D5 AWD	09/2011→	D	D5244T10
<b>XC 90</b>			
D5	09/2011→	D	D5244T5
D5	06/2011→	D	D5244T4
D5	02/2011→	D	D5244T
T6	02/2011→	B	B6294T



**Model**

Version		Fuel	Motor code
---------	--	------	------------

81865 350981865000



**FLANGIA**  
 Numero Fori Flangia 3  
 Dimensione Fori Flangia M8x1.25  
 Posizione Flangia 76.25  
 Diametro Mozzo Ø30  
**GIRANTE**  
 Diametro Girante Ø60  
 N° Alette Girante 7  
 Distanza Girante 4

**AUDI**

**A3 II, Sportback, Cabriolet**

1.6 FSI 03/2011→ B BAG, BLP

**SEAT**

**IBIZA V, SportCoupé, ST**

16 08/2011→ B BTS

**SKODA**

**FABIA II, Station Wagon**

16 07/2011→ B BTS

**OCTAVIA II, Station Wagon**

1.6 FSI 04/2011→ B BLF

**ROOMSTER**

16 06/2011→ B BTS

**VOLKSWAGEN**

**EOS**

1.6 FSI 06/2011→ B BLF

**GOLF V, Plus, Variant**

1.4 FSI 03/2011→06/2011 B BKG, BLN

1.6 FSI 06/2011→

1.6 FSI 03/2011→ B BAG, BLF

**JETTA III**

1.6 FSI 05/2011→ B BLF

**PASSAT VI, Variant, CC**

1.6 FSI 05/2011→ B BLF

**POLO IV**

1.4 FSI 02/2011→06/2011 B AXU

1.6 16V 06/2011→ B BTS

**TOURAN**

1.6 FSI 03/2011→ B BAG, BLF, BLP



**Model**

Version		Fuel	Motor code
---------	--	------	------------

81866 350981866000



**FLANGIA**  
 Numero Fori Flangia 3  
 Dimensione Fori Flangia M8x1.25  
 Posizione Flangia 31.5  
 Diametro Mozzo Ø30  
**GIRANTE**  
 Diametro Girante Ø66.5  
 N° Alette Girante 7  
 Distanza Girante 63.8

**AUDI**

**A3 II, Sportback, Cabriolet**

32 05/2011→ B BMJ, BUB

3.2 V6 quattro 03/2011→ B BDB, BMJ

**TT I, Coupé, Roadster**

3.2 VR6 quattro 03/2011→06/2011 B BHE

**TT II, Coupé, Roadster**

3.2 V6 quattro 06/2011→ B BUB

**SEAT**

**ALHAMBRA I**

2.8 V6 06/2000→ B AYL

2.8 V6 4motion 01/2011→ B AYL

**LEON I**

28 02/2011→04/2011 B BDE

2.8 Cupra 4 01/2011→06/2011 B AUE

**SKODA**

**SUPERB II, Station Wagon**

3.6 4x4 08/2011→ B CDVA

3.6 FSI 4x4 09/2011→ B

3.6 V6 4x4 09/2011→ B CDVA

**VOLKSWAGEN**

**BORA, Station Wagon**

2.8 V6 4motion 03/1999→05/2011 B AQP, AUE, BDE

**EOS**

3.2 V6 06/2011→ B BUB

3.6 V6 09/2011→ B CDVA

**GOLF IV, Cabrio, Variant**

3.2 R32 4motion 02/2011→05/2011 B BFH

**GOLF V, Plus, Variant**

32 05/2011→ B BUB

3.2 Fsi 05/2011→ B BUB

3.2 R32 4motion 04/2011→ B

3.2 R32 4motion 05/2011→ B BUB

**MULTIVAN**

3.2 4motion 03/2011→06/2011 B BDL

Short		Code	
<b>Model</b>			
Version		Fuel	Motor code
81866	350981866000		
<b>VOLKSWAGEN</b>			
<b>GOLF V, Plus, Variant</b>			
3.2 V6	04/2011→04/2011	B BDL	
3.2 V6	04/2011→	B BKK	
3.2 V6 4motion	04/2011→	B BKK	
<b>NEW BEETLE, Cabrio</b>			
RSI 3.2	04/2000→01/2011	B AXJ	
<b>PASSAT VI, Variant, CC</b>			
3.2 FSI	05/2011→	B AXZ	
3.2 FSI 4motion	05/2011→	B AXZ	
3.6 4motion	08/2011→	B BWS	
3.6 FSI	05/2011→07/2011	B BLV	
3.6 FSI 4motion	05/2011→	B BLV	
3.6 R36 4motion	07/2011→	B BWS	
<b>PHAETON</b>			
3.2 V6	02/2011→	B AYT, BKL	
3.2 V6 4motion	04/2011→	B BKL, BRK	
3.6 V6 4motion	08/2011→	B CHNA	
<b>SHARAN I</b>			
2.8 V6 24V	04/2000→	B AYL	
2.8 V6 24V 4motion	04/2000→	B AYL	
<b>TOUAREG I</b>			
3.2 V6	02/2011→06/2011	B AZZ, BKJ	
3.2 V6	04/2011→06/2011	B BMX	
<b>TRANSPORTER V</b>			
3.2 4motion	03/2011→	B BKK	
3.2 4motion	03/2011→06/2011	B BDL	
3.2 V6	03/2011→04/2011	B BDL	
3.2 V6	03/2011→	B BKK	

81867 350981867000



**FLANGIA**  
 Numero Fori Flangia 3  
 Dimensione Fori Flangia M8x1.25  
 Posizione Flangia 69  
 Diametro Mozzo Ø30  
**GIRANTE**  
 Diametro Girante Ø64  
 N° Alette Girante 8  
 Distanza Girante 20.6

SEAT

**CORDOBA III, Vario**

12 02/2011→ B AZQ

Short		Code	
<b>Model</b>			
Version		Fuel	Motor code
<b>IBIZA IV</b>			
12	02/2011→06/2011	B AZQ	
<b>IBIZA V, SportCoupé, ST</b>			
12	08/2011→	B BZG, CGPA	
12	09/2011→	B CGPB	
<b>SKODA</b>			
<b>FABIA I, Station Wagon</b>			
12	03/2011→08/2011	B AZQ, BME	
12	01/2011→08/2011	B AWY, BMD	
<b>FABIA II, Station Wagon</b>			
12	07/2011→	B BZG	
12	06/2011→	B BBM	
<b>PRAKTIK</b>			
12	07/2011→	B BZG	
<b>ROOMSTER</b>			
12	07/2011→	B BZG	
12	06/2011→07/2011	B BME	
<b>VOLKSWAGEN</b>			
<b>FOX</b>			
12	05/2011→	B BMD	
<b>POLO III, Classic, Variant, Van</b>			
12	01/2011→01/2011	B AWY	
<b>POLO IV</b>			
12	02/2011→07/2011	B AWY, BMD	
12	07/2011→	B BZG	
12	07/2011→	B BBM	
12	01/2011→07/2011	B AZQ, BME	
<b>POLO V</b>			
12	09/2011→	B CGPB	
12	09/2011→	B CGPA	

81868 350981868000





**PULEGGIA**  
 Diametro Puleggia Ø52  
 Altezza Puleggia 37  
 Posizione Puleggia 48.5  
**GIRANTE**  
 Diametro Girante Ø70.3  
 N° Alette Girante 10  
 Distanza Girante 7.8



NISSAN

**PRIMERA III**

1.9 dCi 03/2011→ D

MAGNETI MARELLI			
Short	Code		
			
<b>Model</b>			
Version		Fuel	Motor code
<b>81868</b>	<b>350981868000</b>		
<b>RENAULT</b>			
<b>LAGUNA II, GRANDtour</b>			
1.9 dCi	05/2011→	D	F9Q674
1.9 dCi	04/2011→	D	F9Q664
1.9 dCi	05/2011→	D	F9Q758
<b>MEGANE II, Station Wagon, C-C, Scenic</b>			
1.9 dCi	04/2011→	D	F9Q808
1.9 dCi	05/2011→	D	F9Q803
1.9 dCi	05/2011→	D	F9Q816, F9Q818
1.9 dCi	02/2011→	D	F9Q750, F9Q800
1.9 dCi	02/2011→05/2011	D	F9Q808
<b>SCENIC I, GRAND SCENIC</b>			
1.9 dCi	04/2011→	D	F9Q812
1.9 dCi	05/2011→	D	F9QE804
1.9 dCi	05/2011→	D	F9Q816
<b>SCENIC II, GRAND SCENIC</b>			
1.9 D	06/2011→	D	F9Q812
1.9 dCi	05/2011→	D	F9Q803
1.9 dCi	05/2011→	D	F9Q804
1.9 dCi	03/2011→	D	F9Q812
<b>SUZUKI</b>			
<b>GRAND VITARA II</b>			
1.9 DDiS	05/2011→	D	

MAGNETI MARELLI			
Short	Code		
<b>81869</b>	<b>350981869000</b>		
			
<b>PULEGGIA</b>		Diametro Puleggia	Ø56
		Numero Denti/Gole Puleggia	19
		Altezza Puleggia	30
		Posizione Puleggia	39
<b>GIRANTE</b>		Diametro Girante	Ø72
		N° Alette Girante	20
		Distanza Girante	29
<b>CITROËN</b>			
<b>BERLINGO I, Furgonato</b>			
1.6 HDi	05/2011→	D	DV6TED4
1.6 HDI 75	05/2011→	D	DV6B
1.6 HDI 90	05/2011→	D	DV6ATED4
<b>BERLINGO II, Furgonato</b>			
1.6 HDi	08/2011→	D	9HX (DV6ATED4)
1.6 HDi	08/2011→	D	9HZ-DV6TED4
1.6 HDi	08/2011→	D	9HT (DV6BTED4), 9HT (DV6BUTED4)
1.6 HDi 110	10/2011→	D	

MAGNETI MARELLI			
Short	Code		
			
<b>Model</b>			
Version		Fuel	Motor code
<b>C 2, Enterprise</b>			
1.6 HDi	05/2011→	D	9HZ-DV6TED4
<b>C 3, PICASSO, Pluriel</b>			
1.6 16V HDi	05/2011→	D	DV6TED4
1.6 16V HDi	05/2011→	D	9HX (DV6ATED4)
1.6 HDi	09/2011→	D	9HX (DV6ATED4), DV6ATED4
1.6 HDi	09/2011→	D	9HZ-DV6TED4
1.6 HDi	09/2011→	D	
1.6 HDi	09/2011→	D	
1.6 HDI 90	10/2011→	D	
<b>C 4 I, Coupé</b>			
1.6 HDi	06/2011→	D	DV6TED4
1.6 HDi 110 FAP	04/2011→	D	DV6TED4
1.6 HDi 90	04/2011→	D	9HX (DV6ATED4)
<b>C 4 II</b>			
1.6 HDi	09/2011→	D	
1.6 HDi	09/2011→	D	
<b>C 4 PICASSO, Gran PICASSO</b>			
1.6 HDi 110FAP	06/2011→	D	9HZ-DV6TED4
<b>C 5 II, Break</b>			
1.6 HDi	04/2011→	D	9HY (DV6TED4), DV6TED4
<b>C 5 III, Break</b>			
1.6 HDi	08/2011→	D	DV6TED4
1.6 HDi	10/2011→	D	
<b>JUMPY II</b>			
1.6 HDi 90	07/2011→	D	
<b>XSARA, Break, Coupé, PICASSO</b>			
1.6 HDi	04/2011→	D	DV6TED4
1.6 HDi	05/2011→	D	
<b>FIAT</b>			
<b>SCUDO II</b>			
1.6 D Multijet	07/2011→	D	
<b>FORD</b>			
<b>C-Max I</b>			
1.6 TDCi	07/2011→	D	HHDA
1.6 TDCi	07/2011→	D	G8DA
FIESTA V, Van			
1.6 TDCi	04/2011→	D	HHJA, HHJB
<b>FIESTA VI, Van</b>			
1.6 TDCi	10/2011→	D	TZJA
1.6 TDCi	08/2011→	D	HHJD
1.6 TDCi	08/2011→	D	HHJF
<b>FOCUS C-Max</b>			
1.6 TDCi	05/2011→07/2011	D	HHDA, HHDB
1.6 TDCi	03/2011→07/2011	D	G8DA

Short	MAGNETI MARELLI			Code
<b>Model</b>				
Version		Fuel	Motor code	
81869		350981869000		
<b>FORD</b>				
<b>FOCUS II, Station Wagon, Cabrio</b>				
1.6 TDCi	04/2011→	D	HHDA, HHDB	
1.6 TDCi	04/2011→	D	G8DA, G8DB	
<b>FUSION</b>				
1.6 TDCi	04/2011→	D	HHJA, HHJB	
<b>MAZDA</b>				
<b>2 II</b>				
1.6 MZ-CD	08/2011→	D		
<b>3 I</b>				
1.6 DI Turbo	04/2011→	D	Y601	
<b>3 II</b>				
1.6 MZR-CD	09/2011→	D		
<b>5</b>				
1.6 CD	10/2011→	D		
<b>MINI</b>				
<b>MINI</b>				
Cooper D	07/2011→	D	9HZ (DV6TED4)	
One D	10/2011→	D		
<b>MINI CLUBMAN</b>				
1.6 D	07/2011→	D	9HZ (DV6TED4)	
<b>PEUGEOT</b>				
<b>1007</b>				
1.6 HDi	07/2011→	D	9HZ (DV6TED4)	
<b>206, Station Wagon, CC, Plus</b>				
1.6 HDi FAP 110	04/2011→	D	9HY (DV6TED4), 9HZ (DV6TED4)	
<b>207, Station Wagon, CC</b>				
1.6 HDi	06/2011→	D	9HX (DV6ATED4)	
1.6 HDi	06/2011→	D	9HY (DV6TED4), 9HZ (DV6TED4)	
1.6 HDi	09/2011→	D		
1.6 HDi	09/2011→	D		
<b>3008</b>				
1.6 HDi	09/2011→	D	9HZ (DV6TED4)	
1.6 HDi	10/2011→	D		
<b>307, Break, CC</b>				
1.6 HDi	05/2011→	D	9HX (DV6ATED4)	
1.6 HDi 110 FAP	04/2011→	D	9HY (DV6TED4)	
<b>308, Station Wagon, CC</b>				
1.6 HDi	09/2011→	D		
1.6 HDi	07/2011→	D		
1.6 HDi	07/2011→	D	9HZ (DV6TED4)	
1.6 HDi	09/2011→	D		
<b>407, Break, Coupé</b>				
1.6 HDi 110 FAP	04/2011→	D	9HY (DV6TED4)	

Short	MAGNETI MARELLI			Code
<b>Model</b>				
Version		Fuel	Motor code	
5008				
1.6 HDi	10/2011→	D		
1.6 HDi	09/2011→	D		
<b>508, Station Wagon</b>				
1.6 HDi	10/2011→	D		
<b>EXPERT II, Tepee</b>				
1.6 HDi 90	07/2011→	D		
<b>PARTNER - Ranch, I</b>				
1.6 HDi 75	06/2011→	D		
1.6 HDi 90	06/2011→	D	9HX (DV6ATED4)	
<b>PARTNER - Ranch, II, Tepee</b>				
1.6 HDi	08/2011→	D		
1.6 HDi	08/2011→	D	9HX (DV6ATED4)	
1.6 HDi	08/2011→	D		
1.6 HDi	10/2011→	D		
<b>SUZUKI</b>				
<b>SX4</b>				
1.6 DDIS	07/2011→	D	9HX	
<b>VOLVO</b>				
<b>C30</b>				
1.6 D	06/2011→	D	D4164T	
<b>S40 II</b>				
1.6 D	05/2011→	D	D4164T	
<b>S80 II</b>				
1.6 D DRIVE	10/2011→	D	D4164T	
<b>V50</b>				
1.6 D	05/2011→	D	D4164T	
D2	10/2011→	D	D4162T	
<b>V70 III Station Wagon</b>				
1.6 D	10/2011→	D	D4164T	

81871 350981871000

NEW





<b>PULEGGIA</b>	
Diametro Puleggia	Ø82.6
Numero Denti/Gole Puleggia	50
Altezza Puleggia	12
Posizione Puleggia	34.5
<b>GIRANTE</b>	
Diametro Girante	Ø95.7
N° Alette Girante	6
Distanza Girante	16.5



OPEL



SIGNUM

3.0 V6 CDTI	03/2011→	D	Y30DT
3.0 V6 CDTI	05/2011→	D	Z30DT



MAGNETI MARELLI			
Short	Code		
			
<b>Model</b>			
Version		Fuel	Motor code
81871	350981871000	<b>NEW</b>	
<b>OPEL</b>			
<b>VECTRA C, Station Wagon, GTS</b>			
3.0 CDTi	03/2011→	D	Y30DT
3.0 CDTi	05/2011→	D	Z30DT
3.0 V6 CDTi	05/2011→	D	Z30DT
3.0 V6 CDTi	03/2011→	D	Y30DT
<b>RENAULT</b>			
<b>ESPACE IV</b>			
3.0 dCi	06/2011→	D	P9X715
3.0 dCi	02/2011→	D	P9X701
<b>VEL SATIS</b>			
3.0 dCi	02/2011→	D	P9X701
3.0 dCi	06/2011→	D	P9X715
<b>VAUXHALL</b>			
<b>SIGNUM</b>			
3.0 CDTi	03/2011→	D	Y30DT



MAGNETI MARELLI			
Short	Code		
			
<b>Model</b>			
Version		Fuel	Motor code
81872	350981872000	<b>NEW</b>	
			
<b>PULEGGIA</b>			
Diametro Puleggia		Ø48	
Altezza Puleggia		37	
Posizione Puleggia		44.5	
<b>GIRANTE con CUSCINETTO RULLO-SFERA</b>			
Diametro Girante		Ø75.9	
N° Alette Girante		8	
Distanza Girante		17.5	
<b>ALFA ROMEO</b>			
<b>147</b>			
1.9 JTD 16V	03/2011→04/2011	D	937A4.000
1.9 JTD 16V	04/2011→	D	192B1.000
1.9 JTD 16V	02/2011→	D	192A5.000
1.9 JTDM 16V	08/2011→	D	
1.9 JTDM 16V	05/2011→	D	937A5.000
<b>156, Sportwagon</b>			
1.9 JTD	05/2011→06/2011	D	937A5.000
1.9 JTD 16V	02/2011→06/2011	D	192A5.000
1.9 JTD 16V Q4	04/2011→06/2011	D	937A5.000
2.4 JTD	03/2011→06/2011	D	841G.000
<b>159, Sportwagon</b>			
1.9 JTDM 16V	05/2011→	D	937A8.000, 939A8.000
1.9 JTDM 16V	05/2011→	D	939A2.000
2.0 JTDM	09/2011→	D	939B3.000
2.0 JTDM	10/2011→	D	



MAGNETI MARELLI			
Short	Code		
			
<b>Model</b>			
Version		Fuel	Motor code
<b>159, Sportwagon</b>			
2.4 JTDM	07/2011→	D	939A9.000
2.4 JTDM	05/2011→	D	939A3.000
2.4 JTDM Q4	07/2011→	D	939A9.000
<b>166</b>			
2.4 JTD	05/2011→	D	936B.000
2.4 JTD	06/2011→	D	841M.000
2.4 JTD	03/2011→	D	841G.000, 841H.000
<b>BRERA</b>			
2.0 JTDM	09/2011→	D	939B3.000
2.4 JTDM 20V	06/2011→	D	939A3.000
2.4 JTDM 20V	07/2011→	D	939A9.000
<b>GIULIETTA</b>			
1.6 JTDM	10/2011→	D	940A3.000
2.0 JTDM	10/2011→	D	
2.0 JTDM	10/2011→	D	940A4.000
<b>GT II</b>			
1.9 JTD	08/2011→	D	
1.9 JTD	03/2011→	D	937A5.000
<b>MITO</b>			
1.6 JTDM	08/2011→	D	198A2.000
1.6 JTDM	08/2011→	D	955A4.000
<b>SPIDER IV</b>			
2.0 JTDM	09/2011→	D	939B3.000
2.4 JTDM	08/2011→	D	939A3.000
2.4 JTDM	07/2011→	D	939A3.000
<b>CADILLAC</b>			
<b>BLS, Station Wagon</b>			
1.9 D	06/2011→	D	Z19DTH
1.9 D	07/2011→	D	Z19DTR
<b>FIAT</b>			
<b>BRAVO II</b>			
1.6 D Multijet	08/2011→	D	
1.6 D Multijet	08/2011→	D	
1.6 D Multijet	08/2011→	D	198A2.000
1.9 D Multijet	07/2011→	D	937A5.000
2.0 D Multijet	08/2011→	D	198A5.000
<b>CROMA II</b>			
1.9 D Multijet	05/2011→	D	939A2.000
2.4 D Multijet	05/2011→	D	939A3.000
<b>DOBLO' II, Cargo</b>			
1.6 D 16V Multijet	10/2011→	D	
1.6 D 16V Multijet	10/2011→	D	
1.6 D Multijet	10/2011→	D	
1.6 D Multijet	10/2011→	D	



MAGNETI MARELLI			
Short	Code		
<b>Model</b>			
Version		Fuel	Motor code
81872	350981872000	<b>NEW</b>	
<b>FIAT</b>			
<b>DOBLO' II, Cargo</b>			
2.0 D Multijet	10/2011→	D	
<b>LINEA</b>			
1.6 D Multijet	09/2011→	D	198A3.000
<b>PUNTO Evo</b>			
1.6 D Multijet	09/2011→	D	955A3.000
<b>SEDICI</b>			
2.0 D Multijet	06/2011→	D	
2.0 D Multijet 4x4	06/2011→	D	
<b>STILO, Station Wagon</b>			
1.9 D Multijet	05/2011→	D	937A5.000
1.9 JTD	04/2011→	D	192A5.000
1.9 JTD	04/2011→	D	192B1.000
1.9 JTD	03/2011→	D	937A4.000
<b>LANCIA</b>			
<b>DELTA III</b>			
1.6 MULTIJET	08/2011→	D	198A2.000
1.9 MULTIJET	09/2011→	D	844A1.000
2.0 MULTIJET	08/2011→	D	198A5.000
<b>MUSA</b>			
1.6 D Multijet	08/2011→	D	
1.6 D Multijet	08/2011→	D	350A2.000
<b>THESIS</b>			
2.4 JTD	03/2011→	D	841G.000
2.4 Multijet	06/2011→	D	841P.000
<b>OPEL</b>			
<b>ASTRA H, Station Wagon, Cabrio, HTC, TwinTop</b>			
1.9 CDTI	04/2011→	D	Z19DTH
1.9 CDTi	04/2011→	D	
1.9 CDTI 16V	04/2011→	D	Z19DTJ
<b>ASTRA J</b>			
2.0 CDTI	09/2011→	D	A20DTH
<b>INSIGNA, Station Wagon</b>			
2.0 Biturbo CDTI 4x4	08/2011→	D	A20DTR
2.0 CDTI	08/2011→	D	A20DTC
2.0 CDTI	08/2011→	D	A20DTJ
2.0 CDTI	08/2011→	D	A20DTH
2.0 CDTI	08/2011→	D	A20DTR
2.0 CDTI 4x4	10/2011→	D	A20DTH
<b>SIGNUM</b>			
1.9 CDTI	04/2011→	D	Z19DTH
<b>VECTRA C, Station Wagon, GTS</b>			
1.9 CDTI	04/2011→	D	Z19DTH



MAGNETI MARELLI			
Short	Code		
<b>Model</b>			
Version		Fuel	Motor code
<b>ZAFIRA B</b>			
1.9 CDTI	05/2011→	D	Z19DTH
<b>SAAB</b>			
<b>9-3 II, 9-3 X, Station Wagon, Cabrio</b>			
1.9 TiD	04/2011→	D	Z19DTH
1.9 TTiD	07/2011→	D	Z19DTR
<b>9-5 I, Station Wagon</b>			
1.9 TiD	06/2011→	D	Z19DTH
<b>9-5 II, Station Wagon</b>			
2.0 TiD	10/2011→	D	A20DTH
2.0 TTiD	10/2011→	D	A20DTR
2.0 TTiD XWD	10/2011→	D	A20DTR
<b>SUZUKI</b>			
<b>SX4</b>			
2.0 DDIS	09/2011→	D	D20AA
2.0 DDIS 4x4	09/2011→	D	D20AA
<b>VAUXHALL</b>			
<b>ASTRA</b>			
2.0 CDTI	09/2011→	D	A20DTH

81999 350981999000			
		<b>FLANGIA</b>	
		Numero Fori Flangia	3
		Dimensione Fori Flangia	M8x1.25
		Posizione Flangia	85
		Diametro Mozzo	Ø23
		Diametro Centraggio	Ø26
		<b>GIRANTE</b>	
		Diametro Girante	Ø65
		N° Alette Girante	7
		Distanza Girante	49.3
<b>LADA</b>			
<b>NIVA I</b>			
1600	01/1987→03/1995	B	BA32121
1700 i	06/1996→	B	BA321214
1700 i 4x4	10/2000→	B	
<b>NOVA I, Station Wagon</b>			
1200 Junior/L	09/1981→	B	BA32101
1300 Spezial/L	05/1981→	B	BA32105
1500	08/1994→	B	BA32103 (KAT)
1500	09/1985→02/1993	B	BA32103
1500 S	06/1989→	B	BA321083
1500 Special	03/1985→	B	BA32103
1600	01/1988→	B	BA32106
1700	08/1994→	B	
1700 i Classic	06/1996→	B	



MAGNETI MARELLI			
Short	Code		
			
<b>Model</b>			
Version		Fuel	Motor code
81999	350981999000		
<b>LADA</b>			
<b>TOSCANA</b>			
1300	12/1985→	B	BA32105
1500	09/1983→02/1993	B	BA32103

MAGNETI MARELLI			
Short	Code		
			
<b>Model</b>			
Version		Fuel	Motor code
82001	350982001000		
			
<b>FLANGIA</b>			
Numero Fori Flangia			3
Dimensione Fori Flangia			M8x1.25
Posizione Flangia			66
Diametro Mozzo			Ø40
<b>GIRANTE</b>			
Diametro Girante			Ø59
N° Alette Girante			6
Distanza Girante			29.5
<b>VOLKSWAGEN</b>			
<b>TRANSPORTER III</b>			
1.6 TD	08/1984→07/1992	D	JX
1.6 TD Syncro	03/1986→07/1992	D	JX

MAGNETI MARELLI			
Short	Code		
			
<b>Model</b>			
Version		Fuel	Motor code
82004	350982004000		
			
<b>FLANGIA</b>			
Numero Fori Flangia			4
Dimensione Fori Flangia			M6x1
Posizione Flangia			82.85
Diametro Centraggio			Ø58
<b>GIRANTE</b>			
Diametro Girante			Ø77
N° Alette Girante			7
Distanza Girante			9.5
<b>FORD</b>			
<b>MONDEO I, Station Wagon</b>			
1.6 i 16V	02/1993→08/1996	B	L1F
1.6 i 16V	07/1994→08/1996	B	L1J
1.8 4x4	02/1993→08/1996	B	RKA
1.8 i 16V	01/1994→08/1996	B	RKB
1.8 i 16V	02/1993→08/1996	B	RKA
1.8 i 16V 4x4	02/1993→08/1996	B	RKA
2.0 i 16V	01/1993→08/1996	B	
2.0 i 16V	02/1993→08/1996	B	NGA
2.0 i 16V 4x4	04/1993→08/1996	B	NGA
2.0 i 16V 4x4	12/1994→08/1996	B	NGA
<b>MONDEO II, Station Wagon</b>			
1.6 i	09/1996→11/2000	B	L1J

MAGNETI MARELLI			
Short	Code		
			
<b>Model</b>			
Version		Fuel	Motor code
<b>MONDEO II, Station Wagon</b>			
1.6 i 16V	05/1998→11/2000	B	L1L, L1N, L1Q
1.8 i	09/1996→11/2000	B	RKB, RKF, RKH, RKJ, RKK
2.0 i	09/1996→11/2000	B	NGA, NGB, NGC, NGD

MAGNETI MARELLI			
Short	Code		
			
<b>Model</b>			
Version		Fuel	Motor code
82005	350982005000		
			
<b>PULEGGIA</b>			
Diametro Puleggia			Ø57.2
Numero Denti/Gole Puleggia			23
Altezza Puleggia			19.5
Posizione Puleggia			61.3
<b>GIRANTE</b>			
Diametro Girante			Ø55
N° Alette Girante			9
Distanza Girante			35

MAGNETI MARELLI			
Short	Code		
			
<b>Model</b>			
Version		Fuel	Motor code
<b>OPEL</b>			
<b>ASTRA F Classic</b>			
1.4 i	03/1998→08/2000	B	X14XE
1.6 i 16V	01/1998→05/2011	B	X16XEL
<b>ASTRA F, Station Wagon, Cabrio</b>			
1.4 i 16V	01/1996→01/2011	B	X14XE
1.6 i 16V	08/1994→09/1998	B	X16XEL
<b>ASTRA G, Station Wagon, Cabrio</b>			
1.4 16V	02/1998→05/2011	B	X14XE, Z14XE
1.6 16V	02/1998→05/2011	B	X16XEL, Z16XE
<b>CORSA B, Station Wagon, Van</b>			
1.4 i 16V	08/1997→09/2000	B	C14SEL
1.4 i 16V	09/1994→09/2000	B	X14XE
1.6 GSI 16V	03/1993→09/2000	B	C16XE
1.6 i 16V	08/1997→09/2000	B	C16SEL
1.6 i 16V	09/1994→09/2000	B	X16XE
<b>TIGRA</b>			
1.4 16V	07/1994→12/2000	B	X14XE
1.4 16V	08/1997→12/2000	B	X14XE
1.6 16V	07/1994→08/1998	B	X16XE
1.6 16V	08/1997→08/1998	B	C16SEL
<b>VECTRA B, Station Wagon</b>			
1.6 i 16V	10/1995→02/2011	B	X16XEL, Y16XE, Z16XE
<b>ZAFIRA A</b>			
1.6 16V	04/1999→05/2011	B	X16XEL, Z16XE

Short Code



Model

Version		Fuel	Motor code
---------	--	------	------------

82010		350982010000	
-------	--	--------------	--



<b>FLANGIA</b>	
Diametro Centraggio	Ø28
Posizione Flangia	56.5
<b>GIRANTE</b>	
Diametro Girante	Ø60
N° Alette Girante	6
Distanza Girante	10

**BMW**

**1, Cabrio, Coupé**

116 i	04/2011→	B	N45B16A
116i	07/2011→	B	N45B16TU2
118i	07/2011→	B	N43B20A
118i	04/2011→	B	N42B20B
120 i	04/2011→	B	N42B20A
120i	07/2011→	B	N43B20A
20	07/2011→	B	N43B20A
20	07/2011→	B	
20	07/2011→	B	

**3 IV (E46), Touring, Cabrio, Compact, Coupé**

316 Ci	04/2000→	B	M43B16 (164E3)
316 Ci	02/2011→	B	N45B16A
316 i	02/2011→05/2011	B	N42B18
316 i	04/2000→05/2011	B	M43B16 (164E3)
316 i	02/2011→05/2011	B	N45B16A
316 ti	01/2011→05/2011	B	N42B18
318 Ci	05/2011→	B	N46B20B
318 Ci	01/2011→	B	N42B20, N46B20
318 i	01/2011→05/2011	B	N42B20, N46B20
318 ti	01/2011→05/2011	B	N42B20

**3 V (E90), Touring (E91), Coupé (E92), Cabrio (E93)**

19	07/2011→07/2011	B	N46NB20B
20	06/2011→07/2011	B	N46NB20B
316i	06/2011→	B	N45B16A
318i	05/2011→07/2011	B	N46B20B
320 si	06/2011→	B	N45B20A
320i	05/2011→07/2011	B	N46B20A, N46B20C
320i	07/2011→	B	N43B20A

**X3 I (E83)**

2.0 i	05/2011→	B	N46B20A
xDrive20i	08/2011→	B	

**Z4 I, Coupé**

2.0 i	05/2011→	B	N46B20A
-------	----------	---	---------

Short Code



Model

Version		Fuel	Motor code
---------	--	------	------------

82011		350982011000	
-------	--	--------------	--



<b>FLANGIA</b>	
Numero Fori Flangia	3
Dimensione Fori Flangia	M8x1.25
Posizione Flangia	55
Diametro Mozzo	Ø30
<b>GIRANTE</b>	
Diametro Girante	Ø49
N° Alette Girante	8
Distanza Girante	15.5

**OPEL**

**AGILA A**

10	03/2011→	B	Z10XEP
1.2 16V Twinport	04/2011→	B	Z12XEP

**ASTRA F Classic**

1.4 Comfort	03/2011→05/2011	B	Z14XEP
-------------	-----------------	---	--------

**ASTRA H, Station Wagon, Cabrio, HTC, TwinTop**

12	05/2011→	B	Z12XEP
12	06/2011→	B	X12XE
14	04/2011→	B	Z14XEP
14	04/2011→04/2011	B	Z14XEL

**COMBO II**

1.4 16V	05/2011→	B	Z14XEP
---------	----------	---	--------

**CORSA C, Van**

10	03/2011→	B	Z10XEP
12	05/2011→	B	Z12XEP
1.2 Twinport	04/2011→	B	Z12XEP
14	03/2011→	B	Z14XEP
1.4 Twinport	03/2011→	B	Z14XEP

**CORSA D**

10	06/2011→	B	Z10XEP
12	06/2011→	B	Z12XEP
1.2 ecoFLEX	09/2011→	BF	Z12XEP
14	06/2011→	B	Z14XEP

**MERIVA A**

1.4 16V Twinport	04/2011→	B	Z14XEP
1.4 16V Twinport LPG	04/2011→10/2011		



**TIGRA TwinTop**





14	04/2011→	B	Z14XEP
----	----------	---	--------

**VAUXHALL**

**ASTRA**

14	04/2011→	B	Z14XEP
----	----------	---	--------

MAGNETI MARELLI			
Short	Code		
			
<b>Model</b>			
Version		Fuel	Motor code
82012	350982012000		
			
<b>PULEGGIA</b>		Diametro Puleggia	Ø90
		Altezza Puleggia	27
		Posizione Puleggia	57
<b>GIRANTE</b>		Diametro Girante	Ø60
		N° Alette Girante	6
		Distanza Girante	25.5
<b>TOYOTA</b>			
<b>AURIS</b>			
1.4 VVTi	07/2011→	B	4ZZ-FE
<b>AVENSIS I, Liftback, Station Wagon</b>			
1.6 VVT-i	10/2000→03/2011	B	3ZZ-FE
1.8 VVT-i	10/2000→03/2011	B	1ZZ-FE
<b>AVENSIS II, Station Wagon</b>			
1.6 VVT-i	03/2011→	B	3ZZ-FE
18	03/2011→	B	1ZZ-FE
<b>CELICA VII</b>			
1.8 16V VT-i	11/1999→	B	1ZZ-FE
<b>COROLLA Verso I</b>			
1.4 VVT-i	02/2011→04/2011	B	4ZZ-FE
1.6 VVT-i	02/2011→04/2011	B	3ZZ-FE
1.8 VVT-i	02/2011→04/2011	B	1ZZ-FE
<b>COROLLA Verso II</b>			
16	04/2011→	B	3ZZ-FE
18	04/2011→	B	1ZZ-FE
<b>COROLLA VI, Station Wagon, Liftback, Compact</b>			
14	02/2000→02/2011	B	4ZZ-FE
1.4 16V	02/2000→02/2011	B	4ZZ-FE
16	02/2000→02/2011	B	3ZZ-FE
1.6 16V	02/2000→02/2011	B	3ZZ-FE
<b>COROLLA VII, Station Wagon, Liftback</b>			
1.4 VVT-i	02/2011→	B	4ZZ-FE
1.6 VVT-i	02/2011→	B	3ZZ-FE
18	02/2011→04/2011	B	1ZZ-FE
18	04/2011→	B	1ZZ-FE
18	04/2011→	B	1ZZ-FE
1.8 4 ruote motrici	01/2011→	B	1ZZ-FE
1.8 4x4	07/2011→	B	
<b>MR 2 III</b>			
1.8 16V VT-i	04/2000→	B	1ZZ-FE
<b>RAV 4 II</b>			
1.8 VVTi	01/2011→	B	1ZZ-FE

MAGNETI MARELLI			
Short	Code		
			
<b>Model</b>			
Version		Fuel	Motor code
82013	350982013000		
			
<b>PULEGGIA</b>		Diametro Puleggia	Ø56
		Numero Denti/Gole Puleggia	19
		Altezza Puleggia	33.5
		Posizione Puleggia	52
<b>GIRANTE</b>		Diametro Girante	Ø60
		N° Alette Girante	8
		Distanza Girante	49
<b>SEAT</b>			
<b>CORDOBA III, Vario</b>			
1.9 SDI	02/2011→	D	ASY
<b>IBIZA IV</b>			
1.9 SDI	02/2011→05/2011	D	ASY
<b>SKODA</b>			
<b>FABIA I, Station Wagon</b>			
1.9 SDI	11/1999→08/2011	D	ASY
<b>VOLKSWAGEN</b>			
<b>FOX</b>			
1.9 D	07/2011→	D	ASY
<b>GOLF V, Plus, Variant</b>			
1.9 SDi	05/2011→	D	BGG
<b>POLO IV</b>			
1.9 SDI	01/2011→	D	ASY
<b>82014 350982014000</b>			
			
<b>FLANGIA</b>		Numero Fori Flangia	3
		Dimensione Fori Flangia	M6x1
		Posizione Flangia	61
<b>GIRANTE</b>		Diametro Girante	Ø56
		N° Alette Girante	6
		Distanza Girante	13.3
<b>NISSAN</b>			
<b>MICRA III (K12), MICRA C+C</b>			
1.0 16V	03/2011→	B	CG10DE
1.2 16V	03/2011→	B	CR12DE
1.2 16V	03/2011→	B	CR12DE
1.4 16V	03/2011→	B	CR14DE
1.6 160 SR	05/2011→	B	HR16DE
160 SR	05/2011→	B	HR16DE

Short	Code
-------	------



Model			
Version		Fuel	Motor code
82014			350982014000
NISSAN			
NOTE			
14	06/2011→	B	CR14DE

Short	Code
-------	------



<b>FLANGIA</b>		
Numero Fori Flangia	3	
Dimensione Fori Flangia	M8x1.25	
Posizione Flangia	55.5	
Diametro Mozzo	Ø30	
<b>GIRANTE</b>		
Diametro Girante	Ø66	
N° Alette Girante	7	
Distanza Girante	16.5	

AUDI			
------	--	--	--

A4 II, Avant			
--------------	--	--	--

2.7 TDI	06/2011→	D	BPP
3.0 TDI quattro	06/2011→	D	ASB
3.0 TDI quattro	06/2011→	D	BKN
3.2 FSI	06/2011→	B	AUK
3.2 FSI quattro	06/2011→	B	AUK

A4 III, Avant			
---------------	--	--	--

2.7 TDI	06/2011→	D	BPP
2.7 Tdi	05/2011→08/2011	D	BSG
3.0 TDI quattro	06/2011→	D	ASB
3.0 TDI quattro	04/2011→	D	BKN
3.2 FSI	05/2011→	B	AUK
3.2 FSI quattro	05/2011→	B	AUK, BKH

A4 IV, Avant			
--------------	--	--	--

2.7 TDI	07/2011→	D	CAMB
2.7 TDI	07/2011→	D	CAMA, CGKA
3.0 TDI quattro	08/2011→	D	CCWB
3.0 TDI quattro	07/2011→	D	CAPA, CCWA

A4 IV, Avant, Allroad			
-----------------------	--	--	--

3.0 TDI quattro	09/2011→	D	CCWA
3.0 TDI quattro	09/2011→	D	

A5, Cabriolét			
---------------	--	--	--

2.7 TDI	07/2011→	D	CAMA, CGKA
2.7 TDI	07/2011→	D	CAMB, CGKB
3.0 TDI quattro	08/2011→	D	CCWB
3.0 TDI quattro	07/2011→	D	CAPA, CCWA

A5, Cabriolet, Sportback			
--------------------------	--	--	--

2.7 TDI	09/2011→	D	CGKB
2.7 TDI	09/2011→	D	CGKA

Short	Code
-------	------



Model			
Version		Fuel	Motor code
<b>A5, Cabriolet, Sportback</b>			
3.0 TDI quattro	09/2011→	D	CCWA

A6 III, Avant, Allroad			
------------------------	--	--	--

24	04/2011→08/2011	B	BDW
2.4 quattro	05/2011→08/2011	B	BDW
2.7 TDI	08/2011→	D	CANA
2.7 TDI	04/2011→	D	BSG
2.7 TDI	04/2011→08/2011	D	BPP
2.7 TDI quattro	05/2011→	D	BSG
2.7 TDI quattro	08/2011→	D	CANA
2.7 TDI quattro	04/2011→08/2011	D	BPP
3.0 Tdi PF	06/2011→	D	ASB
3.0 TDI quattro	04/2011→	D	BNG
3.0 TDI quattro	04/2011→06/2011	D	BMK
3.0 TDI quattro	06/2011→08/2011	D	ASB
3.0 TDI quattro	08/2011→	D	CDYA
3.0 TFSI quattro	08/2011→	B	CAJA
3.2 FSI	04/2011→08/2011	B	AUK
3.2 FSI quattro	04/2011→08/2011	B	AUK, BKH
3.2 FSI quattro	06/2011→08/2011	B	BYU

A8 I			
------	--	--	--

3.0 TDI quattro	03/2011→10/2011	D	ASB
3.0 TDI quattro	03/2011→10/2011	D	BNG
3.2 FSI	05/2011→10/2011	B	BPK
3.2 FSI quattro	05/2011→10/2011	B	BPK

Q5			
----	--	--	--

3.0 TDI	08/2011→	D	CCWA
3.0 TDI	08/2011→	D	CCWB

Q7			
----	--	--	--

3.0 TDI	07/2011→	D	CASA
3.0 Tdi quattro	06/2011→	D	BUN
3.0 TDI quattro	06/2011→	D	BUG

VOLKSWAGEN			
------------	--	--	--

PHAETON			
---------	--	--	--

3.0 V6 TDI 4motion	07/2011→	D	CARA
3.0 V6 TDI 4motion	04/2011→	D	BMK
3.0 V6 TDI 4motion	08/2011→	D	CEXA

TOUAREG I			
-----------	--	--	--

3.0 TDI	06/2011→10/2011	D	BUN
3.0 Tdi 4motion	07/2011→	D	CASA
3.0 V6 TDI	04/2011→10/2011	D	BKS
3.0 V6 TDI	07/2011→10/2011	D	CASA

TOUAREG II			
------------	--	--	--

3.0 V6 TDI	10/2011→	D	CASA
------------	----------	---	------

Short	Code
-------	------



### Model

Version	Fuel	Motor code
---------	------	------------

82016 350982016000



<b>PULEGGIA</b>	
Diametro Puleggia	Ø53.25
Numero Denti/Gole Puleggia	18
Altezza Puleggia	30
Posizione Puleggia	41.5
<b>GIRANTE</b>	
Diametro Girante	Ø53.6
N° Alette Girante	6
Distanza Girante	40.6

### CITROËN

#### C 2, Enterprise

1.4 16V	06/2011→	B	KFU (ET3J4)
---------	----------	---	-------------

#### C 3, PICASSO, Pluriel

1.4 16V	03/2011→	B	KFU (ET3J4)
---------	----------	---	-------------

#### C 4 I, Coupé

1.4 16V	04/2011→	B	KFU (ET3J4)
---------	----------	---	-------------

### PEUGEOT

#### 206, Station Wagon, CC, Plus

1.4 16V	03/2011→	B	KFU (ET3J4)
---------	----------	---	-------------

#### 207, Station Wagon, CC

1.4 16V	06/2011→	B	KFU (ET3J4)
---------	----------	---	-------------

1.4 16V	07/2011→	B	EP3
---------	----------	---	-----

#### 307, Break, CC

1.4 16V	03/2011→	B	KFU (ET3J4)
---------	----------	---	-------------

82017 350982017000



<b>FLANGIA</b>	
Numero Fori Flangia	4
Dimensione Fori Flangia	M6x1
Posizione Flangia	61.5
Diametro Mozzo	Ø22
<b>GIRANTE</b>	
Diametro Girante	Ø58
N° Alette Girante	6
Distanza Girante	14

### MERCEDES-BENZ

#### cl. A I (W169)

A 150	04/2011→	B	M266.920
-------	----------	---	----------

A 160	09/2011→	B	M266.920
-------	----------	---	----------

A 160 CDI	04/2011→	D	OM640.942
-----------	----------	---	-----------

A 170	04/2011→	B	M266.940
-------	----------	---	----------

A 180	09/2011→	B	M266.940
-------	----------	---	----------

A 180 CDI	04/2011→	D	OM640.940
-----------	----------	---	-----------

A 200	04/2011→	B	M266.960
-------	----------	---	----------

Short	Code
-------	------



### Model

Version	Fuel	Motor code
---------	------	------------

#### cl. A I (W169)

A 200 CDI	04/2011→	D	OM640.941
-----------	----------	---	-----------

A 200 TURBO	05/2011→	B	M266.980
-------------	----------	---	----------

#### cl. B (W245)

B 150	05/2011→	B	M266.920
-------	----------	---	----------

B 160	09/2011→	B	M266.920
-------	----------	---	----------

B 170	05/2011→	B	M266.940
-------	----------	---	----------

B 170 NGT	08/2011→	BF	
-----------	----------	----	--

B 180	09/2011→	B	M266.940
-------	----------	---	----------

B 180 CDI	05/2011→	D	OM640.940
-----------	----------	---	-----------

B 180 NGT	08/2011→	BF	
-----------	----------	----	--

B 200	05/2011→	B	M266.960
-------	----------	---	----------

B 200 CDI	05/2011→	D	OM640.941
-----------	----------	---	-----------

B 200 TURBO	05/2011→	B	M266.980
-------------	----------	---	----------

### MITSUBISHI

#### COLT VI, CZC

1.5 DI-D	04/2011→	D	OM639
----------	----------	---	-------

1.5 DI-D	04/2011→	D	
----------	----------	---	--

### SMART

#### FORFOUR

1.5 CDI	04/2011→	D	OM639.939
---------	----------	---	-----------

1.5 CDI	04/2011→	D	OM639.939
---------	----------	---	-----------

82018 350982018000



<b>FLANGIA</b>	
Numero Fori Flangia	3
Dimensione Fori Flangia	M6x1
Posizione Flangia	43.7
Diametro Centraggio	Ø23.3
<b>GIRANTE</b>	
Diametro Girante	Ø49.6
N° Alette Girante	6
Distanza Girante	81

### FORD

#### FIESTA V, Van

13	01/2011→	B	A9JA, A9JB
----	----------	---	------------

13	01/2011→	B	BAJA
----	----------	---	------

#### FUSION

13	02/2011→	B	
----	----------	---	--

#### KA I, Street KA

1.3 i	02/2011→08/2011	B	A9A, A9B
-------	-----------------	---	----------

1.3 i	09/1996→08/2011	B	BAA, J4D, J4K, J4M, J4N, J4P, J4S
-------	-----------------	---	-----------------------------------

16	03/2011→05/2011	B	CDRA, CDRB
----	-----------------	---	------------

1.6 i	03/2011→08/2011	B	CDB, CDC
-------	-----------------	---	----------

Short	Code
-------	------



Model

Version		Fuel	Motor code
---------	--	------	------------

82020 350982020000



FLANGIA	
Numero Fori Flangia	4
Dimensione Fori Flangia	M6x1
Posizione Flangia	92.4
Diametro Centraggio	Ø20
GIRANTE	
Diametro Girante	Ø59.6
N° Alette Girante	6
Distanza Girante	4.9

**HYUNDAI**

**ACCENT II**

13	09/1995→05/1998	B	
1.5 i 16V	10/1995→01/2000	B	G4ER

**ACCENT III**

15	01/2000→	B	G4EB
15	09/2000→	B	G4EC-G
15	09/1999→02/2011	B	
16	02/2011→	B	G4ED-G

**ACCENT IV**

1.4 GL	05/2011→	B	G4EE
1.6 GLS	05/2011→	B	G4ED

**Coupé II**

1.6 16V	02/2011→	B	G4ED-G
1.6 16V	02/2011→	B	G4ED-G

**ELANTRA I**

16	03/2011→	B	G4ED-G
16	06/2000→06/2011	B	
16	06/2000→	B	G4ED-G
16	03/2011→	B	G4GA

**GETZ**

11	05/2011→	B	
14	05/2011→	B	G4EE
16	05/2011→	B	G4ED-G
16	02/2011→	B	G4ED-G

**MATRIX**

16	02/2011→05/2011	B	G4ED-L
16	01/2011→	B	G4ED-G

**TIBURON**

1.6 CVVT	06/2011→	B	G4ED-G
----------	----------	---	--------

**KIA**

**CERATO I, Station Wagon**

16	04/2011→	B	G4ED
16	06/2011→	B	G4FC

Short	Code
-------	------



Model

Version		Fuel	Motor code
---------	--	------	------------

**PRIDE I**

1.6 CVVT LX	05/2011→	B	G4ED
-------------	----------	---	------

**Rio II**

1.4 16V	05/2011→	B	G4EE
1.6 16V	05/2011→	B	G4ED

82021 350982021000



PULEGGIA	
Diametro Puleggia	Ø65
Altezza Puleggia	32.3
Posizione Puleggia	59
GIRANTE	
Diametro Girante	Ø68.6
N° Alette Girante	6
Distanza Girante	18.9

**HYUNDAI**

**Coupé II**

2.7 V6	02/2011→	B	G6BA-G
--------	----------	---	--------

**SANTA Fé I**

2.7 V6 4x4	01/2011→	B	G6BA-G
------------	----------	---	--------

**SONATA III**

2.5 V6 24V	06/1998→01/2011	B	G6BV-G
2.7 V6	01/2011→04/2011	B	G6BA-G
2.7 V6	02/2011→04/2011	B	G6BA

**TRAJET**

2.7 V6	09/2000→	B	G6BA-G
--------	----------	---	--------

**TUCSON**

2.7 4 ruote motrici	04/2011→	B	G6BA-G
---------------------	----------	---	--------

**KIA**

**MAGENTIS I**

2.5 V6	01/2011→	B	
--------	----------	---	--

**SPORTAGE II**

2.7 V6 4WD	04/2011→	B	G6BA
------------	----------	---	------



Short **MAGNETI MARELLI** Code



Model

Version		Fuel	Motor code
---------	--	------	------------

82022 350982022000



**PULEGGIA**  
 Diametro Puleggia Ø62  
 Altezza Puleggia 35  
 Posizione Puleggia 58

**GIRANTE**  
 Diametro Girante Ø73  
 N° Alette Girante 7  
 Distanza Girante 19

**TOYOTA**

**AVENSIS I, Liftback, Station Wagon**

2.0 D-4D 10/1999→03/2011 D 1CD-FTV

**AVENSIS II, Station Wagon**

2.0 D-4D 03/2011→ D 1CD-FTV

**AVENSIS Verso**

2.0 D-4D 01/2011→ D 1CD-FTV

**COROLLA Verso I**

2.0 D4d 04/2011→ D 1CD-FTV

2.0 D-4D 02/2011→04/2011 D 1CD-FTV

**COROLLA VI, Station Wagon, Liftback, Compact**

2.0 D-4D 09/2000→02/2011 D 1CD-FTV

**COROLLA VII, Station Wagon, Liftback**

20 04/2011→ D 1CD-FTV

2.0 D-4D 02/2011→ D 1CD-FTV

2.0 D-4D 02/2011→ D 1CD-FTV

2.0 D-4D 03/2011→ D 1CD-FTV

**Previa II**

2.0 D-4D 01/2011→ D 1CD-FTV

**RAV 4 II**

2.0 D-4D 4WD 01/2011→ D 1CD-FTV

82023 350982023000

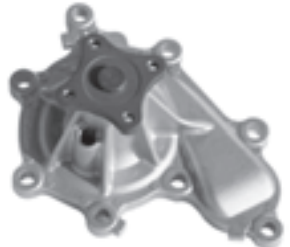

**FLANGIA**  
 Numero Fori Flangia 4  
 Dimensione Fori Flangia M6x1  
 Posizione Flangia 72.3

**GIRANTE**  
 Diametro Girante Ø78  
 N° Alette Girante 8  
 Distanza Girante 7

**NISSAN**

**ALMERA II, Hatchback**

2.2 dCi 03/2011→ D YD22DDTi

Short **MAGNETI MARELLI** Code



Model

Version		Fuel	Motor code
---------	--	------	------------

**ALMERA II, Hatchback**

2.2 dCi 03/2011→ D YD22DDT

2.2 Di 03/2000→ D YD22DDT

**ALMERA Tino**

2.2 dCi 03/2011→ D YD22DDT

2.2 dCi 03/2011→ D YD22DDTi

2.2 Di 08/2000→ D YD22DDTi

**PRIMERA III**

2.2 dCi 03/2011→ D YD22DDT

2.2 Di 02/2011→ D YD22DDT

**X-TRAIL I**

2.2 DCi 04/2011→ D YD22DDTi

2.2 dCi 03/2011→ D YD22DDTi

2.2 dCi 4x4 03/2011→ D YD22DDTi

2.2 DCi FWD 01/2011→03/2011 D YD22DDTi

2.2 Di 4x4 01/2011→ D YD22ETI

82024 350982024000



**PULEGGIA**  
 Diametro Puleggia Ø63  
 Altezza Puleggia 39  
 Posizione Puleggia 69.4

**GIRANTE**  
 Diametro Girante Ø93.8  
 N° Alette Girante 7  
 Distanza Girante 34.3

**FIAT**

**DUCATO IV**

2.3 JTD 02/2011→ D F1AE0481C

**DUCATO V**

120 Multijet 2,3 D 07/2011→ D

120 Multijet 2,3 D 06/2011→ D F1AE0481D

130 Multijet 2,3 D 07/2011→ D

**IVECO**

**DAILY II**

29 L 12 02/2011→ F1AE0481B

29 L 12 V 02/2011→ F1AE0481B

Short	Code
-------	------



### Model

Version		Fuel	Motor code
---------	--	------	------------

82025 350982025000



<b>PULEGGIA</b>	
Diametro Puleggia	Ø57
Numero Denti/Gole Puleggia	23
Altezza Puleggia	30
Posizione Puleggia	45.7
<b>GIRANTE</b>	
Diametro Girante	Ø60
N° Alette Girante	8
Distanza Girante	48.5

### AUDI

#### A3 II, Sportback, Cabriolét

2.0 TFSI	04/2011→	B	AXX
2.0 TFSI quattro	04/2011→	B	AXX
S3 quattro	07/2011→	B	BZC
S3 quattro	06/2011→	B	BHZ

#### A4 II, Avant

20	05/2011→	B	
2.0 TFSI	06/2011→	B	BWE
2.0 TFSI quattro	05/2011→	B	

#### A4 III, Avant

2.0 FSI	06/2011→	B	BYK
2.0 TFSI	05/2011→	B	BUL
2.0 TFSI	04/2011→	B	BGB
2.0 TFSI quattro	05/2011→	B	BUL
2.0 TFSI quattro	04/2011→	B	BGB, BWE, BWT

#### A6 III, Avant, Allroad

2.0 TFSI	05/2011→	B	BPJ
----------	----------	---	-----

#### TT II, Coupé, Roadster

2.0 quattro	08/2011→	B	CDLA
2.0 TFSI	06/2011→	B	BWA
2.0 TFSI quattro	08/2011→	B	CCZA
2.0 TFSI quattro	08/2011→	B	CDLB

### SEAT

#### ALTEA, ALTEA XL

2.0 TFSI	06/2011→09/2011	B	BWA
2.0 TFSI 4WD	07/2011→09/2011	B	BWA

#### EXEO, EXEO ST

2.0 TFSI	09/2011→	B	BWE
----------	----------	---	-----

#### LEON II

2.0 TFSI	05/2011→	B	BWA
2.0 TFSI	05/2011→06/2011	B	BWA1
2.0 TFSI	06/2011→	B	BWJ

Short	Code
-------	------



### Model

Version		Fuel	Motor code
---------	--	------	------------

### SKODA

#### OCTAVIA II, Station Wagon

2.0 RS	05/2011→	B	BWA
--------	----------	---	-----

### VOLKSWAGEN

#### EOS

2.0 TFSI	06/2011→	B	BWA
----------	----------	---	-----

#### GOLF V, Plus, Variant

20	07/2011→	B	BWA
2.0 GTI	06/2011→	B	BYD
2.0 GTI	04/2011→	B	AXX, BPY, BWA

#### GOLF VI, Variant

2.0 R 4motion	09/2011→	B	CDLF
2.0 R 4motion	09/2011→	B	CDLC

### JETTA III

20	05/2011→08/2011	B	BPY
2.0 TFSI	05/2011→	B	BPY, BWA

#### PASSAT VI, Variant, CC

2.0 TFSI	05/2011→	B	AXX, BPY, BWA
2.0 TSI	08/2011→	B	CAWB, CCTA

### SCIROCCO III

2.0 R	09/2011→	B	CDLA
-------	----------	---	------

82026 350982026000



<b>FLANGIA</b>	
Numero Fori Flangia	4
Dimensione Fori Flangia	M6x1
Posizione Flangia	57
Diametro Mozzo	Ø24
<b>GIRANTE</b>	
Diametro Girante	Ø59
N° Alette Girante	8
Distanza Girante	23.3

### FIAT

#### SEDICI

1.6 16V	06/2011→	B	
1.6 16V	06/2011→	B	M16A
1.6 16V 4x4	06/2011→	B	

### SUBARU

#### JUSTY III

13	03/2011→	B	
15	03/2011→	B	M15A

### SUZUKI

#### IGNIS I

13	10/2000→03/2011	B	M13A
1.3 4WD	10/2000→03/2011	B	M13A

MAGNETI MARELLI			
Short	Code		
<b>Model</b>			
Version		Fuel	Motor code
82026	350982026000		
<b>SUZUKI</b>			
<b>IGNIS II</b>			
13	03/2011→	B	M13A
1.3 4x4	03/2011→	B	M13A
15	03/2011→	B	M15A
1.5 4x4	03/2011→	B	M15A
1.5 Sport	03/2011→	B	M15A
<b>JIMNY</b>			
1.3 16V	01/2011→	B	M13A
1.3 16V	05/2011→	B	M13A
1.3 16V 4WD	01/2011→	B	M13A
1.3 4x4	09/2000→02/2011	B	M13A
<b>LIANA, Station Wagon</b>			
13	02/2011→	B	M13A
13	01/2011→	B	
16	02/2011→	B	
16	02/2011→	B	M16A
16	01/2011→	B	
1.6 4WD	02/2011→	B	
1.6 4WD	02/2011→	B	M16A
1.6 4WD	01/2011→	B	
<b>SWIFT III</b>			
13	05/2011→	B	M13A
1.3 4x4	06/2011→	B	M13A
1.3 4x4	05/2011→	B	M13A
15	05/2011→	B	M15A
1.5 4x4	05/2011→	B	M15A
16	06/2011→	B	M16A
<b>SX4</b>			
15	06/2011→	B	M15A
16	06/2011→	B	M16A
16	07/2011→	B	M16A
16	07/2011→	B	M16A
1.6 VVT	06/2011→	B	M16A
1.6 VVT	09/2011→	B	M16A
1.6 VVT 4x4	06/2011→	B	M16A
1.6 VVT 4x4	09/2011→	B	M16A
<b>WAGON R, R+ III</b>			
13	01/2011→	B	M13A
13	03/2011→	B	M13A
1.3 4WD	03/2011→	B	M13A

MAGNETI MARELLI			
Short	Code		
<b>Model</b>			
Version		Fuel	Motor code
82027	350982027000		
		<b>FLANGIA</b>	
		Numero Fori Flangia	4
		Dimensione Fori Flangia	M8x1.25
		Posizione Flangia	93.3
		<b>GIRANTE</b>	
		Diametro Girante	Ø56.1
		N° Alette Girante	6
		Distanza Girante	12.3
<b>FORD</b>			
<b>C-Max I</b>			
16	07/2011→	B	HWDA
<b>FIESTA V, Van</b>			
1.25 16V	03/2011→	B	M7JA, M7JB
1.25 16V	02/2011→	B	FUJA, FUJB
1.4 16V	01/2011→	B	FXJA, FXJB
1.6 16V	01/2011→	B	FYJA
<b>FIESTA VI, Van</b>			
125	08/2011→	B	SNJA
125	08/2011→	B	STJA
14	08/2011→	B	SPJA
1.4 LPG	09/2011→		RTJA
16	08/2011→	B	HXJA
<b>FOCUS C-Max</b>			
16	03/2011→07/2011	B	HWDA
1.6 Ti	04/2011→07/2011	B	HXDA
<b>FOCUS II, Station Wagon, Cabrio</b>			
14	04/2011→	B	ASDA, ASDB
16	04/2011→	B	HWDA, HWDB
1.6 Ti	04/2011→	B	HXDA
<b>FUSION</b>			
125	04/2011→	B	FUJA, FUJB
14	02/2011→	B	FXJA, FXJB
16	02/2011→	B	FYJA
<b>MONDEO IV, Station Wagon</b>			
1.6 Ti	07/2011→	B	PNBA
1.6 Ti	07/2011→	B	RHBA

Short Code



Model

Version		Fuel	Motor code
---------	--	------	------------

82028 350982028000



**FLANGIA**  
 Numero Fori Flangia 4  
 Dimensione Fori Flangia M6x1  
 Posizione Flangia 69.5  
 Diametro Mozzo Ø25

**GIRANTE**  
 Diametro Girante Ø56  
 N° Alette Girante 6  
 Distanza Girante 5.5

NISSAN

ALMERA II, Hatchback

15	03/2000→	B	QG15DE
15	02/2011→	B	QG15DE
1.5 XL	01/2011→	B	QG15DE
18	01/2000→	B	QG18DE
18	02/2011→	B	QG18DE

ALMERA Tino

18	08/2000→	B	QG18DE
18	02/2011→	B	QG18DE

PRIMERA II

1.8 16V	08/1999→02/2011	B	QG18DE
---------	-----------------	---	--------

PRIMERA III

16	02/2011→	B	QG16DE
1.6 Visia	02/2011→	B	QG16DE
18	02/2011→	B	QG18DE

82029 350982029000



**PULEGGIA**  
 Diametro Puleggia Ø66  
 Altezza Puleggia 34  
 Posizione Puleggia 57

**GIRANTE**  
 Diametro Girante Ø74  
 N° Alette Girante 7  
 Distanza Girante 36.5

LAND ROVER

FREELANDER

2.5 V6	11/2000→	B	25K4F
--------	----------	---	-------

MG

MG ZS

180	01/2011→	B	25K4F
-----	----------	---	-------

Short Code



Model

Version		Fuel	Motor code
---------	--	------	------------

ROVER

45

2.0 V6	02/2000→	B	20K4F
--------	----------	---	-------

75, Tourer

2.0 V6	02/1999→	B	20K4F
--------	----------	---	-------

2.5 V6	02/1999→01/2011	B	KV6
--------	-----------------	---	-----

2.5 V6	01/2011→	B	25K4F, KV6
--------	----------	---	------------

82030 350982030000



**PULEGGIA**  
 Diametro Puleggia Ø90  
 Altezza Puleggia Ø30.9  
 Posizione Puleggia 79.8

**GIRANTE**  
 Diametro Girante Ø74  
 N° Alette Girante 6  
 Distanza Girante 13.3

MERCEDES-BENZ

cl. V

V 200 CDI	03/1999→03/2011	D	OM611.980
-----------	-----------------	---	-----------

V 220 CDI	03/1999→03/2011	D	OM611.980
-----------	-----------------	---	-----------

VITO - Viano I (638)

108 CDI 2.2	03/1999→03/2011	D	OM611A (60KWCDI)
-------------	-----------------	---	------------------

108 CDI 2.2	03/1999→03/2011	D	OM611A (60KWCDI)
-------------	-----------------	---	------------------

110 CDI 2.2	03/1999→03/2011	D	OM611LA (75KWCDI)
-------------	-----------------	---	-------------------

110 CDI 2.2	03/1999→03/2011	D	OM611LA (75KWCDI)
-------------	-----------------	---	-------------------

112 CDI 2.2	03/1999→03/2011	D	OM611.980
-------------	-----------------	---	-----------

82031 350982031000



**FLANGIA**  
 Numero Fori Flangia 4  
 Dimensione Fori Flangia M6x1  
 Posizione Flangia 91.2  
 Diametro Centraggio Ø23.9

**GIRANTE**  
 Diametro Girante Ø74.6  
 N° Alette Girante 8  
 Distanza Girante 0.7

HYUNDAI



HIGHWAY Van



2.0 16V	03/2000→	B	
---------	----------	---	--



SANTA Fé I

20	01/2011→	B	G4BP
----	----------	---	------

2.4 16V	01/2011→	B	G4JS-G
---------	----------	---	--------

MAGNETI MARELLI			
Short	Code		
			
<b>Model</b>			
Version		Fuel	Motor code
<b>82031</b>	<b>350982031000</b>		
<b>HYUNDAI</b>			
<b>SANTA Fé I</b>			
2.4 16V	01/2011→	B	G4JS-G
2.4 16V 4x4	01/2011→	B	G4JS-G
2.4 16V 4x4	01/2011→	B	G4JS-G
<b>SANTAMO</b>			
2.0 16V	05/1999→	B	
2.0 16V 4x4	05/1999→	B	
<b>SONATA III</b>			
20	01/2011→04/2011	B	G4JP-EG
2.0 16V	06/1998→01/2011	B	G4JP-G
2.4 16V	03/1998→01/2011	B	
<b>TRAJET</b>			
20	03/2000→	B	G4JP-G
20	03/2011→	B	G4GC
<b>KIA</b>			
<b>MAGENTIS I</b>			
20	01/2011→	B	

MAGNETI MARELLI			
Short	Code		
			
<b>Model</b>			
Version		Fuel	Motor code
<b>82032</b>	<b>350982032000</b>		
			
<b>FLANGIA</b>			
Numero Fori Flangia			3
Dimensione Fori Flangia			M6x1
Posizione Flangia			47
Diametro Centraggio			Ø20
<b>GIRANTE</b>			
Diametro Girante			Ø59.6
N° Alette Girante			5
Distanza Girante			23.3
<b>CITROËN</b>			
<b>BERLINGO II, Furgonato</b>			
16	09/2011→	B	
<b>C 3, PICASSO, Pluriel</b>			
14	09/2011→	B	
16	09/2011→	B	
1.6 16V	09/2011→	B	
<b>C 4 I, Coupé</b>			
1.6 THP 140	08/2011→	B	
1.6 THP 150	08/2011→	B	5FX (EP6DT)
1.6 VTi 120	08/2011→	B	
<b>C 4 II</b>			
1.6 16V	09/2011→	B	
1.6 16V	09/2011→	B	

MAGNETI MARELLI			
Short	Code		
			
<b>Model</b>			
Version		Fuel	Motor code
<b>C 4 PICASSO, Gran PICASSO</b>			
1.6 16V	08/2011→	B	5FX (EP6DT)
1.6 THP 140	08/2011→	B	
1.6 VTi 120	08/2011→	B	
<b>C 5 III, Break</b>			
1.6 16V	09/2011→	B	
<b>DS 3</b>			
1.4 16V	10/2011→	B	
1.6 16V	10/2011→	B	
1.6 16V	10/2011→	B	
<b>MINI</b>			
<b>MINI</b>			
16	07/2011→	B	
1.6 Cooper	09/2011→	B	N12B16A
1.6 Cooper S	09/2011→	B	N14B16A
Cooper	10/2011→	B	
Cooper	06/2011→	B	N12B16A
Cooper S	10/2011→	B	
Cooper S	06/2011→	B	
John Cooper Works	08/2011→	B	
One	07/2011→	B	N12B14A
One	09/2011→	B	N12B14A
One	10/2011→	B	
One	10/2011→	B	
<b>MINI CLUBMAN</b>			
16	07/2011→	B	N12B16A
16	07/2011→	B	N14B16A
16	07/2011→	B	N14B16A
Cooper	10/2011→	B	
Cooper S	10/2011→	B	
John Cooper Works	08/2011→	B	
One	10/2011→	B	N12B14A
One	10/2011→	B	
<b>MINI COUNTRYMAN</b>			
COOPER	10/2011→	B	
COOPER S	10/2011→	B	
COOPER S ALL4	10/2011→	B	
ONE	10/2011→	B	
<b>PEUGEOT</b>			
<b>207, Station Wagon, CC</b>			
1.4 16V	07/2011→	B	EP3
1.6 16V	07/2011→	B	EP6
1.6 16V RC	07/2011→	B	
1.6 16V Turbo	06/2011→	B	EP6DT
1.6 16V Turbo	09/2011→	B	

Short **MAGNETI MARELLI** Code



Model			
Version		Fuel	Motor code
<b>82032</b>		<b>350982032000</b>	
<b>PEUGEOT</b>			
<b>207, Station Wagon, CC</b>			
1.6 16V VTi	07/2011→	B EP6	
<b>3008</b>			
1.6 THP	09/2011→	B 5FX (EP6DT)	
1.6 THP	09/2011→	B	
1.6 VTi	09/2011→	B EP6	
<b>308, Station Wagon, CC</b>			
1.4 16V	07/2011→	B	
1.4 16V	09/2011→	B	
1.6 16V	08/2011→	B EP6DTS	
1.6 16V	09/2011→	B EP6CDT	
1.6 16V	07/2011→	B EP6	
1.6 16V	07/2011→	B EP6DT	
1.6 16V	07/2011→	B	
1.6 Bioflex	09/2011→	FF	
1.6 GTi	10/2011→	B EP6CDTX	
<b>5008</b>			
1.6 16V	09/2011→	B EP6	
1.6 16V	09/2011→	B EP6CDT	
<b>508, Station Wagon</b>			
1.6 THP	10/2011→	B	
1.6 VTi	10/2011→	B	
<b>RCZ</b>			
1.6 16V	10/2011→	B EP6CDT	
1.6 16V	10/2011→	B EP6CDTX	

**82033** **350982033000**



**GIRANTE**  
 Diametro Alberino Ø11.9  
 Tipo Filetto Alberino  
 M12x1.25  
 Lunghezza Alberino 26.5  
**GIRANTE**  
 Diametro Girante Ø71.7  
 N° Alette Girante 7  
 Distanza Girante 71.3

**VOLKSWAGEN**  
**MULTIVAN**

2.5 TDI	03/2011→	D AXE	
2.5 TDI	03/2011→	D AXD	
2.5 TDI 4motion	04/2011→	D AXE	
2.5 TDI 4motion	04/2011→	D AXD	

Short **MAGNETI MARELLI** Code



Model			
Version		Fuel	Motor code
<b>TOUAREG I</b>			
2.5 R5 TDI	03/2011→10/2011	D BAC	
2.5 R5 TDI	03/2011→10/2011	D BLK	
<b>TRANSPORTER V</b>			
25	05/03/11→	D AXE	
25	11/03/11→	D BLJ	
2.5 4motion	06/06/11→	D AXD	
2.5 4motion	08/04/11→	D AXE	
2.5 TDI	04/03/11→	D AXE	
2.5 TDI	04/03/11→	D AXD	
2.5 TDI 4motion	04/04/11→	D AXE, BPC	
2.5 Tdi 4motion	05/03/11→	D	
2.5 TDI 4motion	07/04/11→	D AXD	
2.5 Tdi 4motion	10/03/11→	D	
2.5 Tdi PF	06/06/11→	D AXD	

**82034** **350982034000**



**PULEGGIA**  
 Diametro Puleggia Ø94.3  
 Numero Denti/Gole Puleggia 6  
 Altezza Puleggia 25  
 Posizione Puleggia 90.8  
**GIRANTE**  
 Diametro Girante Ø64.9  
 N° Alette Girante 6  
 Distanza Girante -0.7

**BMW**

<b>3 IV (E46), Touring, Cabrio, Compact, Coupé</b>			
320 Cd	03/2011→	D M47N204D4	
320 d	01/2011→05/2011	D M47N204D4	
330 Cd	03/2011→	D M57N306D2	
330 d	03/2011→05/2011	D M57N306D2	
330 xd	03/2011→05/2011	D M57N306D2	
<b>7 IV (E65, E66)</b>			
730 d	02/2011→	D M57N2306D2	
730 Ld	05/2011→	D N57N306D2	
<b>X5 (E53)</b>			
3.0 d	03/2011→	D M57N306D4	

Short **MAGNETI MARELLI** Code



Model

Version		Fuel	Motor code
---------	--	------	------------

82035 350982035000

**FLANGIA**

Numero Fori Flangia 4

Dimensione Fori Flangia M6x1

Posizione Flangia 53.3

Diametro Centraggio Ø50

**GIRANTE**

Diametro Girante Ø62

N° Alette Girante 9

Distanza Girante 24.5

**TOYOTA**

**CELICA VII**

1.8 16V TS	11/1999→	B	2ZZ-GE
------------	----------	---	--------

**COROLLA VII, Station Wagon, Liftback**

1.8 VTL-i TS	02/2011→	B	2ZZ-GE
--------------	----------	---	--------

1.8 VTL-i TS	05/2011→	B	2ZZ-GE
--------------	----------	---	--------

82036 350982036000

**PULEGGIA**

Diametro Puleggia Ø53.2

Numero Denti/Gole Puleggia 3

Altezza Puleggia 10.6

Posizione Puleggia 33.5

**GIRANTE**

Diametro Girante Ø78.5

N° Alette Girante 6

Distanza Girante 24.6

**FORD**

**MAVERICK II**

3.0 24V	04/2011→	B	AJ
---------	----------	---	----

3.0 V6 24V	01/2011→	B	AJ
------------	----------	---	----

**MONDEO III, Station Wagon**

2.5 V6 24V	11/2000→07/2011	B	LCBD
------------	-----------------	---	------

3.0 V6 24V	04/2011→07/2011	B	REBA
------------	-----------------	---	------

ST220	02/2011→07/2011	B	MEBA
-------	-----------------	---	------

Short **MAGNETI MARELLI** Code



Model

Version		Fuel	Motor code
---------	--	------	------------

82037 350982037000

**FLANGIA**

Numero Fori Flangia 3

Dimensione Fori Flangia M8x1.25

Posizione Flangia 56.6

Diametro Centraggio Ø30

**GIRANTE**

Diametro Girante Ø65.6

N° Alette Girante 7

Distanza Girante 16.9

**AUDI**

**A4 IV, Avant**

3.2 FSI	08/2011→	B	CALA
---------	----------	---	------

3.2 FSI	08/2011→	B	
---------	----------	---	--

3.2 FSI quattro	07/2011→	B	CALA
-----------------	----------	---	------

**A5, Cabriolét**

3.2 FSI	07/2011→	B	CALA
---------	----------	---	------

3.2 FSI quattro	07/2011→	B	CALA
-----------------	----------	---	------

**A5, Cabriolet, Sportback**

3.2 FSI quattro	09/2011→	B	CALA
-----------------	----------	---	------

**A6 III, Avant, Allroad**

2.8 FSI	08/2011→	B	CCEA
---------	----------	---	------

2.8 FSI	08/2011→	B	CCDA
---------	----------	---	------

2.8 FSI	06/2011→08/2011	B	BDX
---------	-----------------	---	-----

2.8 FSI quattro	07/2011→08/2011	B	BDX
-----------------	-----------------	---	-----

2.8 FSI quattro	08/2011→	B	CCEA
-----------------	----------	---	------

2.8 FSI quattro	08/2011→	B	CCDA
-----------------	----------	---	------

**A8 I**

2.8 FSI	07/2011→10/2011	B	BDX
---------	-----------------	---	-----

**Q5**

3.2 FSI	08/2011→	B	CALB
---------	----------	---	------

82038 350982038000

**FLANGIA**

Numero Fori Flangia 4

Dimensione Fori Flangia M8x1.25

Posizione Flangia 59.2

Diametro Centraggio Ø32

**GIRANTE**

Diametro Girante Ø76.5

N° Alette Girante 6

Distanza Girante 5.1

**KIA**

**CARNIVAL I**

2.9 TD	08/1999→01/2011	D	
--------	-----------------	---	--

Short Code



Model

Version		Fuel	Motor code
82038		350982038000	
<b>KIA</b>			
<b>CARNIVAL II</b>			
2.9 TD	01/2011→	D	

82039 350982039000



**PULEGGIA**

Diametro Puleggia Ø56.1  
 Numero Denti/Gole Puleggia 19  
 Altezza Puleggia 41  
 Posizione Puleggia 56.4

**GIRANTE**

Diametro Girante Ø62.3  
 N° Alette Girante 7  
 Distanza Girante 14.5

**HONDA**

**CIVIC VI, Coupé, Hatchback**

14	01/2011→05/2011	B	D14Z5
1.4 iS	01/2011→05/2011	B	D14Z6
16	01/2011→05/2011	B	D16V1
16	05/2011→05/2011	B	R16A1
1.6 i	01/2011→05/2011	B	D16V1
17	01/2011→05/2011	B	D17A6
1.7 i	01/2011→05/2011	B	D17A8
1.7 i VTEC	01/2011→05/2011	B	D17A5

**FR-V**

17	05/2011→	B	D17A2
----	----------	---	-------

**STREAM I**

1.7 16V	01/2011→	B	D17A2
2.0 16V	01/2011→	B	K20A

82040 350982040000

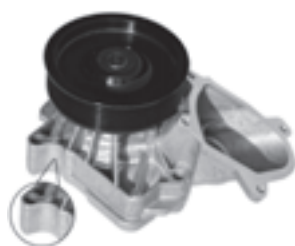

**PULEGGIA**

Diametro Puleggia Ø94.15  
 Numero Denti/Gole Puleggia 6  
 Altezza Puleggia 27.8  
 Posizione Puleggia 93.4

**GIRANTE**

Diametro Girante Ø64.5  
 N° Alette Girante 6  
 Distanza Girante -1.5

**BMW**

**1, Cabrio, Coupé**

118 d	04/2011→	D	M47N204D4
120 d	04/2011→	D	M47N204D4

Short Code



Model

Version		Fuel	Motor code
<b>3 IV (E46), Touring, Cabrio, Compact, Coupé</b>			
318 d	03/2011→05/2011	D	M47N204D4
318 td	03/2011→05/2011	D	M47N204D4
320 Cd	03/2011→	D	M47N204D4
320 d	01/2011→05/2011	D	M47N204D4
320 td	01/2011→05/2011	D	M47N204D4

**3 V (E90), Touring (E91), Coupé (E92), Cabrio (E93)**

318d	05/2011→	D	N47D20A
318d	05/2011→	D	M47N204D4
320d	05/2011→	D	M47N204D4, M47N204D5
320d	05/2011→	D	M47N204D4
325d	06/2011→	D	M57306D3, N57306D3, N57N306D3
330d	05/2011→	D	M57306D3, N57N306D3
330xd	05/2011→	D	M57306D3
335d	06/2011→	D	M57N306D5

**5 V (E60), Touring (E61)**

520d	05/2011→	D	M47N204D5
520d	05/2011→	D	M47N204D4
525d	07/2011→	D	M57306D3
525d	04/2011→	D	M57N256D4
525d	04/2011→	D	M57256D1, M57N256D4
525d xDrive	08/2011→	D	N57306D3
525xd	07/2011→	D	M57306D3
530d	07/2011→	D	M57306D3
530d	03/2011→	D	N57306D2
530d	03/2011→	D	M57306D3
530d xDrive	08/2011→	D	
530xd	07/2011→	D	M57306D3
530xd	05/2011→	D	M57306D3
535d	07/2011→	D	M57N306D5
535d	04/2011→	D	M57306D4

**6 II (E63), Cabrio (E64)**

635d	07/2011→	D	M57N306D5, N57N306D5
------	----------	---	----------------------



**X3 I (E83)**

2.0 d	04/2011→	D	M47N204D4
3.0 d	04/2011→	D	M57N2306D2
3.0 d	04/2011→	D	M54N306D2
3.0 sd	06/2011→	D	M57306D5
xDrive35d	08/2011→	D	N57N306D5

**X5 (E70)**

3.0 d	07/2011→	D	M57306D3
3.0 sd	07/2011→	D	M57N306D5
xDrive30d	08/2011→	D	
xDrive35d	08/2011→	D	





MAGNETI MARELLI			
Short	Code		
			
<b>Model</b>			
Version		Fuel	Motor code
82040	350982040000		
<b>BMW</b>			
<b>X6</b>			
30d	08/2011→	D	
35d	08/2011→	D	N57N306D5
XDrive30d	08/2011→	D	
xDrive35d	08/2011→	D	N57N306D5

MAGNETI MARELLI			
Short	Code		
82041	350982041000		
			
<b>PULEGGIA</b>		Diametro Puleggia	Ø57.2
		Altezza Puleggia	33
		Posizione Puleggia	25.5
<b>GIRANTE</b>		Diametro Girante	Ø80.6
		N° Alette Girante	7
		Distanza Girante	31.8
<b>AUDI</b>			
<b>A8 I</b>			
3.3 TDI quattro	06/2000→02/2011	D	AKF

MAGNETI MARELLI			
Short	Code		
82042	350982042000		
			
<b>PULEGGIA</b>		Diametro Puleggia	Ø69.8
		Numero Denti/Gole Puleggia	28
		Altezza Puleggia	36
		Posizione Puleggia	54.2
<b>GIRANTE</b>		Diametro Girante	Ø69.5
		N° Alette Girante	8
		Distanza Girante	58.4

MAGNETI MARELLI			
Short	Code		
<b>CITROËN</b>			
<b>XANTIA I, Break</b>			
3.0 i 24V	01/1997→01/1998	B	XFZ (ES9J4)
<b>XANTIA II, Break</b>			
3.0 V6	01/1998→03/2011	B	XFZ (ES9J4)
<b>XM II, Break</b>			
3.0 V6	04/1997→10/2000	B	XFZ (ES9J4)
<b>PEUGEOT</b>			
<b>406, Break, Coupé</b>			
3.0 24V	10/1996→04/2011	B	XFZ (ES9J4)
3.0 V6 24V	03/1997→04/2011	B	XFZ (ES9J4)

MAGNETI MARELLI			
Short	Code		
			
<b>Model</b>			
Version		Fuel	Motor code
<b>RENAULT</b>			
<b>ESPACE III</b>			
3.0 V6 24V	10/1998→02/2011	B	L7X727
<b>LAGUNA I, Grandtour</b>			
3.0 24V	03/1997→01/2011	B	L7X700, L7X701
<b>SAFRANE II</b>			
2.9 24V	03/1999→12/2000	B	L7X713

MAGNETI MARELLI			
Short	Code		
82043	350982043000		
			
<b>PULEGGIA</b>		Diametro Puleggia	Ø128.2
		Altezza Puleggia	35.5
		Posizione Puleggia	57.8
<b>GIRANTE</b>		Diametro Girante	Ø53.4
		N° Alette Girante	7
		Distanza Girante	11.3
<b>BMW</b>			
<b>5 V (E60), Touring (E61)</b>			
530d xDrive	08/2011→	D	

MAGNETI MARELLI			
Short	Code		
<b>HONDA</b>			
<b>CIVIC VI, Coupé, Hatchback</b>			
2.0 i Sport	04/2011→05/2011	B	K20A3
<b>CR-V II</b>			
20	02/2011→06/2011	B	K20A4
<b>FR-V</b>			
20	05/2011→	B	K20A9
<b>INTEGRA III</b>			
20	02/2011→	B	K20A3
2.0 16V Type-R	02/2011→	B	

MAGNETI MARELLI			
Short	Code		
82044	350982044000		
			
<b>PULEGGIA</b>		Diametro Puleggia	Ø62
		Altezza Puleggia	35.2
		Posizione Puleggia	58
<b>GIRANTE</b>		Diametro Girante	Ø74
		N° Alette Girante	7
		Distanza Girante	19.2
<b>TOYOTA</b>			
<b>AVENSIS II, Station Wagon</b>			
2.0 D-4D	03/2011→	D	1CD-FTV

Short	Code
-------	------



Model			
Version		Fuel	Motor code
82044		350982044000	
<b>TOYOTA</b>			
<b>COROLLA Verso II</b>			
2.0 D-4D	04/2011→	D	1CD-FTV
<b>COROLLA VII, Station Wagon, Liftback</b>			
2.0 D-4D	02/2011→	D	1CD-FTV
2.0 D-4D	04/2011→	D	1CD-FTV

Short	Code
-------	------



<b>FLANGIA</b>	
Numero Fori Flangia	3
Dimensione Fori Flangia	M6x1
Posizione Flangia	70.2
<b>GIRANTE</b>	
Diametro Girante	Ø48.3
N° Alette Girante	7
Distanza Girante	5.2

HONDA			
<b>CIVIC VII, Hatchback</b>			
14	06/2011→	B	L13A7
<b>JAZZ II</b>			
12	02/2011→	B	L12A1
14	02/2011→08/2011	B	L13A1
14	05/2011→	B	L13A5
<b>JAZZ III</b>			
14	08/2011→	B	L13Z1
14	08/2011→	B	L12B1

Short	Code
-------	------



<b>GIRANTE</b>	
Diametro Alberino	Ø12
Lunghezza Alberino	65
<b>GIRANTE</b>	
Diametro Girante	Ø68
N° Alette Girante	8
Distanza Girante	5.5

AUDI			
<b>A4 II, Avant</b>			
S4 quattro	03/2011→04/2011	B	BBK
<b>A4 III, Avant</b>			
S4 quattro	04/2011→	B	BBK, BHF

Short	Code
-------	------



Model			
Version		Fuel	Motor code
<b>A6 II, Avant, Allroad</b>			
4.2 V8 quattro	02/2011→05/2011	B	BAS
<b>A6 III, Avant, Allroad</b>			
4.2 quattro	04/2011→06/2011	B	BAT
<b>A8 I</b>			
4.0 TDI quattro	03/2011→10/2011	D	ASE
4.2 TDI quattro	05/2011→10/2011	D	BVN
4.2 TDI quattro	05/2011→10/2011	D	BMC
<b>Q7</b>			
4.2 TDI quattro	07/2011→	D	BTR

Short	Code
-------	------



<b>FLANGIA</b>	
Numero Fori Flangia	4
Dimensione Fori Flangia	M6x1
Posizione Flangia	90.6
Numero Fori Flangia (Serie 2)	2
Dimensione Fori Flangia (Serie 2)	Ø6
Diametro Centraggio	Ø35
<b>GIRANTE</b>	
Diametro Girante	Ø82.2
N° Alette Girante	8
Distanza Girante	13,2

MERCEDES-BENZ			
---------------	--	--	--

<b>cl. G (460, 461, 463)</b>			
G 270 CDI	01/2011→	D	OM612.966
<b>SPRINTER I (904)</b>			
408 CDI	04/2000→06/2011	D	OM611.987
411 CDI	04/2000→06/2011	D	OM611.981
411 CDI 4x4	04/2000→06/2011	D	OM611.981
413 CDI	04/2000→06/2011	D	OM611.981
413 CDI 4x4	04/2000→06/2011	D	OM611.981
416 CDI	04/2000→06/2011	D	OM612.981
416 CDI 4x4	04/2000→06/2011	D	OM612.981
<b>SPRINTER II (905)</b>			
208 CDI	04/2000→06/2011	D	OM611.987
211 CDI	04/2000→06/2011	D	OM611.981
213 CDI	04/2000→06/2011	D	OM611.981
216 CDI	04/2000→06/2011	D	OM612.981
308 CDI	04/2000→06/2011	D	OM611.987
311 CDI	04/2000→06/2011	D	OM611.981
311 CDI 4x4	02/2011→06/2011	D	OM611.981
313 CDI	04/2000→06/2011	D	OM611.981
313 CDI 4x4	02/2011→06/2011	D	OM611.981
316 CDI	04/2000→06/2011	D	OM612.981
316 CDI 4x4	02/2011→06/2011	D	OM612.981

Short **MAGNETI MARELLI** Code



Model

Version		Fuel	Motor code
---------	--	------	------------

82048		350982048000	
-------	--	--------------	--



**FLANGIA**  
 Numero Fori Flangia 4  
 Dimensione Fori Flangia M6x1  
 Posizione Flangia 65.2  
 Diametro Centraggio Ø28

**GIRANTE**  
 Diametro Girante Ø59.5  
 N° Alette Girante 6  
 Distanza Girante 5

**TOYOTA**

**YARIS I**

1.0 16V	03/2011→	B	1SZ-FE
1.0 16V	04/1999→	B	1SZ-FE

**YARIS II**

1.3 VVT-i	06/2011→	B	2SZ-FE
-----------	----------	---	--------

82049 350982049000



**FLANGIA**  
 Numero Fori Flangia 4  
 Dimensione Fori Flangia M6x1  
 Posizione Flangia 52.3  
 Diametro Centraggio Ø28

**GIRANTE**  
 Diametro Girante Ø56.1  
 N° Alette Girante 6  
 Distanza Girante 23.9

**MITSUBISHI**

**COLT VI, CZC**

11	04/2011→	B	3A91
13	04/2011→	B	4A90
15	04/2011→	B	4A91

**COLT VII**

13	08/2011→	B	
----	----------	---	--

**LANCER Sportback**

15	08/2011→	B	4A91
----	----------	---	------

**LANCER VIII, Station Wagon**

15	08/2011→	B	4A91
----	----------	---	------

**SMART**

**FORFOUR**

11	04/2011→	B	
11	05/2011→	B	
13	04/2011→	B	
15	04/2011→	B	M135.950
15	04/2011→	B	

Short **MAGNETI MARELLI** Code



Model

Version		Fuel	Motor code
---------	--	------	------------

**FORFOUR**

1.5 BRABUS	05/2011→	B	
------------	----------	---	--

82050 350982050000



**FLANGIA**  
 Numero Fori Flangia 4  
 Dimensione Fori Flangia M6x1  
 Posizione Flangia 80.1  
 Diametro Centraggio Ø24

**GIRANTE**  
 Diametro Girante Ø57.5  
 N° Alette Girante 7  
 Distanza Girante 9.2

**SUZUKI**

**GRAND VITARA I**

16	03/1998→	B	G16B
1.6 4 ruote motrici	02/2000→02/2011	B	

**GRAND VITARA II**

16	05/2011→	B	M16A
1.6 4 ruote motrici	05/2011→	B	M16A

82051 350982051000



**PULEGGIA**  
 Diametro Puleggia Ø60  
 Altezza Puleggia 36  
 Posizione Puleggia 61.7

**GIRANTE**  
 Diametro Girante Ø72.1  
 N° Alette Girante 10  
 Distanza Girante 17.1

**LEXUS**

**RX II**

3.3 4x4	03/2011→	B	3MZ-FE
3.3 FWD	03/2011→06/2011	B	3MZ-FE
300	03/2011→	B	1MZ-FE
400h	04/2011→	B	3MZ-FE
400h FWD	05/2011→	B	3MZ-FE

**TOYOTA**

**CAMRY IV, Station Wagon**

3.0 24V	08/1996→01/2011	B	1MZ-FE
3.0 V6	08/1996→01/2011	B	1MZ-FE

**CAMRY V, Station Wagon**

3.0 V6	01/2011→	B	1MZ-FE
--------	----------	---	--------

Short **MAGNETI MARELLI** Code



Model

Version		Fuel	Motor code
---------	--	------	------------

82052 350982052000



FLANGIA	
Numero Fori Flangia	4
Dimensione Fori Flangia	M6x1
Posizione Flangia	90.9
Numero Fori Flangia (Serie 2)	2
Dimensione Fori Flangia (Serie 2)	Ø5.9
Diametro Centraggio	Ø35
GIRANTE	
Diametro Girante	Ø78
N° Alette Girante	8
Distanza Girante	13.3

MERCEDES-BENZ

SPRINTER III (906)

209 CDI	06/2011→	D	OM646.984
211 CDI	06/2011→	D	OM646.985
213 CDI	06/2011→	D	OM646.986
215 CDI	06/2011→	D	OM646.990
218 CDI	06/2011→	D	OM642.992
224	06/2011→	B	M272.979
309 CDI	06/2011→	D	OM646.984
311 CDI	06/2011→	D	OM646.985
311 CDI 4x4	08/2011→	D	OM646.985
313 CDI	06/2011→	D	OM646.986
315 CDI	06/2011→	D	OM646.990
315 CDI 4x4	08/2011→	D	OM646.990
318 CDI	06/2011→	D	OM642.992
324	06/2011→	B	M272.979
415 CDI	06/2011→	D	
509 CDI	06/2011→	D	OM646.984
511 CDI	06/2011→	D	OM646.985
515 CDI	06/2011→	D	OM646.986, OM646.990
518 CDI	06/2011→	D	OM642.992
VITO - Viano II (639)			
109 CDi	06/2011→	D	OM646.981
109 CDI 2.2	03/2011→	D	OM646.983
109 CDI 2.2	06/2011→	D	OM646.980, OM646.981
111 CDI 2.2	03/2011→	D	OM646.982
111 CDI 2.2	07/2011→	D	OM646.982
111 CDI 2.2 4x4	07/2011→	D	OM646.982
115 CDI 2.2	03/2011→	D	OM646.982
115 CDI 2.2 4x4	07/2011→	D	OM646.982
2.2 Cdi	05/2011→	D	
CDI 2.0 4-matic	05/2011→	D	OM646.982
CDI 2.2	03/2011→	D	OM646.982
CDI 2.2	03/2011→	D	OM646.982
CDI 2.2	03/2011→	D	OM646.982
CDI 2.2 4-matic	05/2011→	D	OM646.982

Short **MAGNETI MARELLI** Code



Model

Version		Fuel	Motor code
---------	--	------	------------

82053 350982053000



FLANGIA	
Numero Fori Flangia	4
Dimensione Fori Flangia	M6x1
Posizione Flangia	106.2
Diametro Centraggio	Ø31.6
GIRANTE	
Diametro Girante	Ø74.7
N° Alette Girante	8
Distanza Girante	-1.8

NISSAN

SERENA I

2.3 D	01/1995→	D	LD23
-------	----------	---	------

VANETTE III, Cargo

2.3 D	01/1995→	D	LD23
-------	----------	---	------

82054 350982054000



FLANGIA	
Numero Fori Flangia	4
Dimensione Fori Flangia	M6x1
Posizione Flangia	105.8
Diametro Centraggio	Ø31.6
GIRANTE	
Diametro Girante	Ø74.2
N° Alette Girante	8
Distanza Girante	-1.1

NISSAN

SERENA I

2.0 D	11/1992→	D	LD20
-------	----------	---	------



VANETTE II



2.0 D	10/1986→12/1995	D	LD20, LD20II
-------	-----------------	---	--------------

2.0 D	10/1986→12/1995	D	LD20
-------	-----------------	---	------

VANETTE III, Cargo



2.0 D	01/1995→	D	LD20
-------	----------	---	------





MAGNETI MARELLI			
Short	Code		
			
Model			
Version		Fuel	Motor code
82056	350982056000		
	<b>PULEGGIA</b>		
	Diametro Puleggia		56.24
	Numero Denti/Gole Puleggia		19
	Altezza Puleggia		30
	Posizione Puleggia		62.2
	<b>GIRANTE</b>		
	Diametro Girante		71
	N° Alette Girante		7
	Distanza Girante		14
FORD			
FOCUS II, Station Wagon, Cabrio			
2.5 RS	09/2011→	B	
2.5 ST	05/2011→	B	HYDA
KUGA			
25	09/2011→	B	
2.5 4x4	09/2011→	B	HYDB
MONDEO IV, Station Wagon			
25	07/2011→	B	HUBA
S-Max			
2.5 ST	06/2011→	B	HUWA
RENAULT			
LAGUNA I, GRANDtour			
20	06/1995→01/2011	B	N7Q700
2.0 16V	06/1995→01/2011	B	N7Q700, N7Q704
VOLVO			
850, Station Wagon			
20	06/1991→12/1996	B	B5204F
20	08/1994→12/1996	B	B5202S
2.0 Turbo	02/1993→12/1996	B	B5204FT, B5204T
2.0 Turbo	09/1993→10/1997	B	B5204T2
23	01/1996→10/1996	B	B5234FS
2.3 T5	02/1993→12/1996	B	B5234FT
2.3 T5 R	04/1996→10/1996	B	B5234T2
2.3 T5-R	08/1995→12/1996	B	B5234T4
2.3 Turbo R	06/1995→10/1997	B	B5234T5
2.4 GLE	09/1993→10/1997	B	B5254T
25	06/1991→07/1994	B	B5252
25	08/1991→12/1996	B	B5254S
25	08/1994→12/1996	B	B5252S
2.5 AWD	04/1996→12/1996	B	B5254T
C30			
2.4 i	06/2011→	B	B5244S4
T5	07/2011→	B	B5254T7
T5	06/2011→	B	B5254T3

MAGNETI MARELLI			
Short	Code		
			
Model			
Version		Fuel	Motor code
S40 I			
16	03/1999→03/2011	B	B4164S2
16	09/1995→08/1999	B	B4164S
18	03/1999→03/2011	B	B4184S2, B4184S9
18	01/2011→03/2011	G	
18	07/1995→08/1999	B	B4184S, B4184S3
1.8 i	01/2011→03/2011	B	B4184SJ
1.9 T4	05/1997→07/2000	B	B4194T, B4194T2
20	07/1995→03/2011	B	B4204S, B4204S2
20	07/1995→08/1999	B	B4204S
2.0 T	01/2011→03/2011	B	B4204T3
2.0 T	07/2000→01/2011	B	B4204T3
2.0 T	10/1997→07/2000	B	B4204T
2.0 T4	07/2000→03/2011	B	B4204T5
V40 Station Wagon			
16	03/1999→04/2011	B	B4164S2
16	12/1995→08/1999	B	B4164S
18	03/1999→04/2011	B	B4184S2, B4184S9
18	07/1995→08/1999	B	B4184S, B4184S3
1.8 Bi-Fuel	11/1999→03/2011	B	B4184S9
1.8 Blu-Fuel	01/2011→03/2011	G	
1.8 i	01/2011→04/2011	B	B4184SJ
1.9 T4	05/1997→07/2000	B	B4194T
20	07/1995→08/1999	B	B4204S
20	07/1995→04/2011	B	B4204S
2.0 T	01/2011→04/2011	B	B4204T3
2.0 T	07/1999→01/2011	B	B4204T2
2.0 T	10/1997→07/2000	B	B4204T
2.0 T4	07/2000→04/2011	B	B4204T5
S40 II			
16	05/2011→	B	B4164S3
18	04/2011→	B	B4184S11
1.8 FlexFuel	06/2011→	FF	B4184S8
24	04/2011→	B	B5244S
24	04/2011→	B	B5244S5
2.4 AWD	06/2011→	B	B5244S4
T5	04/2011→	B	B5254T3
T5	07/2011→	B	B5254T7
T5 AWD	07/2011→	B	B5254T7
T5 AWD	04/2011→	B	B5254T3
V50			
24	04/2011→	B	B5244S
24	04/2011→	B	B5244S5
2.4 AWD	06/2011→	B	B5244S4
T5	07/2011→	B	B5254T7

MAGNETI MARELLI			
Short	Code		
<b>Model</b>			
Version		Fuel	Motor code
<b>82056</b>	<b>350982056000</b>		
<b>VOLVO</b>			
<b>V50</b>			
T5	04/2011→	B	B5254T3
T5 AWD	07/2011→	B	B5254T7
T5 AWD	04/2011→	B	B5254T3
<b>S60 I</b>			
2.0 T	01/2011→	B	B5204T5
2.3 T5	07/2000→02/2011	B	B5234T7
24	11/2000→	B	B5244S
24	11/2000→	B	B5244S2
2.4 AWD	04/2011→	B	B5244T5
2.4 Bifuel	02/2011→	BF	B5244SG2
2.4 T	11/2000→	B	B5244T3
2.4 T AWD	01/2011→	B	B5244T3
2.4 T5	04/2011→	B	B5244T5
2.5 T	04/2011→	B	B5254T2
2.5 T AWD	04/2011→	B	B5254T2
R 2,5 T AWD	03/2011→	B	B5254T4
T5	11/2000→	B	B5234T3
<b>XC 60</b>			
2.4 D	08/2011→	D	D5244T16
2.4 D5	08/2011→	D	D5244T4
<b>C70 I Cabrio, Coupé</b>			
20	03/1997→05/2011	B	B5204T2
2.0 T	03/2000→05/2011	B	B5204T4
2.0 T	03/1997→05/2011	B	B5204T3
2.3 T5	02/2011→05/2011	B	B5234T9
2.3 T-5	03/1997→05/2011	B	B5234T3
2.4 T	02/2011→05/2011	B	B5244T7
25	03/1999→02/2011	B	B5254S
25	06/1998→05/2011	B	B5254S
2.5 T	03/1997→05/2011	B	B5244T, B5254T
<b>C70 II Cabrio</b>			
24	06/2011→	B	B5244S5
2.4 i	06/2011→	B	B5244S4
T5	06/2011→	B	B5254T3
T5	07/2011→	B	B5254T7
<b>S70</b>			
20	01/1997→11/2000	B	B5204F
20	01/1997→11/2000	B	B5204T2
20	01/1997→11/2000	B	B5204T4
20	01/1997→11/2000	B	B5202S
2.0 Turbo	01/1997→11/2000	B	B5204T
2.0 Turbo	01/1997→11/2000	B	B5204T3

MAGNETI MARELLI			
Short	Code		
<b>Model</b>			
Version		Fuel	Motor code
<b>S70</b>			
23	04/1999→09/2000	B	B5234T7
2.3 AWD	04/1999→09/2000	B	B5234T7
2.3 T-5	01/1997→11/2000	B	B5234T3
2.3 T5 GLT AWD	11/1996→09/1998	B	B5234T3
2.3 T5 R AWD	11/1996→09/1998	B	B5234T2
2.3 T5 Sport	11/1996→09/1998	B	B5234T3
2.3 T5 Sport AWD	07/1997→09/2000	B	B5234T4
2.3 Turbo	01/1997→11/2000	B	B5234FT+
24	01/1997→11/2000	B	B5254S
24	08/1999→11/2000	B	B5244S2
2.4 AWD	04/1999→09/2000	B	B5244S
2.4 AWD	04/1999→09/2000	B	B5244S2
2.4 AWD	10/1998→05/1999	B	
2.4 AWD	11/1996→05/1999	B	B5252FS
2.4 Blu-Fuel	07/1997→09/2000	G	B5244SG
2.4 T5 Sport AWD	11/1996→04/1999	B	B5254T
2.4 Turbo	01/1997→11/2000	B	B5244T, B5254T
25	01/1997→11/2000	B	B5252S
25	06/1998→11/2000	B	B5254S
2.5 Bifuel	07/1999→11/2000	BF	B5244SG
2.5 Bifuel	10/1998→11/2000	BF	GB5252S
<b>V70 I Station Wagon</b>			
20	01/1997→03/2000	B	B5202S
20	01/1997→03/2000	B	
20	01/1997→03/2000	B	B5204T4
20	01/1997→03/2000	B	B5204T2
2.0 Turbo	01/1997→03/2000	B	B5204T
2.0 Turbo	01/1997→03/2000	B	B5204T3
2.0 Turbo AWD	01/1997→03/2000	B	B5204T3
2.3 AWD	12/1998→02/2000	B	B5234T7, B5234T8
2.3 T AWD	04/1997→03/2000	B	B5234FT+
2.3 T-5	01/1997→03/2000	B	B5234T3
2.3 T-5 AWD	01/1997→03/2000	B	B5234T3
2.3 Turbo	01/1997→03/2000	B	B5234FT+
24	01/1997→05/2000	B	B5254S
24	08/1999→05/2000	B	B5244S2
2.4 Bifuel	08/1999→03/2000	BF	B5244SG
2.4 Turbo	01/1997→03/2000	B	B5244T, B5254T
25	01/1997→03/2000	B	B5252S
25	06/1998→03/2000	B	B5254S
2.5 AWD	03/1999→03/2000	B	
2.5 Bifuel	10/1998→08/1999	BF	GB5252S
2.5 Turbo AWD	01/1997→05/2000	B	B5244T, B5254T

MAGNETI MARELLI			
Short	Code		
			
<b>Model</b>			
Version		Fuel	Motor code
<b>82056</b>	<b>350982056000</b>		
<b>VOLVO</b>			
<b>V70 II Station Wagon</b>			
2.0 T	01/2011→	B	B5204T5
2.3 AWD	10/2000→04/2011	B	B5234T7, B5234T8
2.3 T5	03/2000→	B	B5234T3
24	03/2000→03/2011	B	
24	03/2000→	B	B5244S
24	03/2000→	B	B5244S2
2.4 Bifuel	01/2011→	BF	B5244SG
2.4 T	03/2000→	B	B5244T3
2.4 T AWD	01/2011→	B	B5244T3
2.4 T5	04/2011→	B	B5244T5
2.5 R Sport	02/2011→	B	B5254T4
2.5 T	04/2011→	B	B5254T2
2.5 T AWD	02/2011→	B	B5254T2
R 2,5 T AWD	03/2011→	B	B5254T4
<b>V70 III Station Wagon</b>			
2.5 T	10/2011→	B	B5254T10
2.5 T	07/2011→	B	B5254T6
2.5 T FlexFuel	08/2011→	FF	B5254T8
2.5 T FlexiFuel	09/2011→	FF	B5254T11
<b>XC 70 I Cross Country</b>			
2.4 AWD	03/2000→03/2011	B	
2.4 T XC AWD	03/2000→02/2011	B	B5244T3
2.5 T XC AWD	02/2011→	B	B5254T2
<b>S80 I</b>			
20	06/1998→06/2011	B	B5204T4
2.0 T	06/1998→06/2011	B	B5204T3
2.0 T	12/1999→06/2011	B	B5204T5
2.3 R	04/2000→05/2011	B	B5234T7
24	01/1999→06/2011	B	B5244S
24	01/1999→06/2011	B	B5244S2
2.4 Bifuel	01/2011→06/2011	BF	B5244SG2
2.4 LTP	04/2011→06/2011	B	B5244T4
2.4 T	06/2000→06/2011	B	B5244T3
2.4 T5 AWD	04/2000→03/2011	B	B5244T3
2.5 T	03/2011→06/2011	B	B5254T2
2.5 T AWD	03/2011→06/2011	B	B5254T2
<b>S80 II</b>			
2.5 T	10/2011→	B	B5254T10
2.5 T	06/2011→	B	B5254T6
2.5 T AWD	06/2011→	B	B5254T6
2.5 T FlexFuel	10/2011→	FF	B5254T11
2.5 T FlexFuel	08/2011→	FF	B5254T8

MAGNETI MARELLI			
Short	Code		
			
<b>Model</b>			
Version		Fuel	Motor code
<b>XC 90</b>			
2.5 T	02/2011→	B	B5254T2
<b>82057 350982057000</b>			
		<p><b>PULEGGIA</b></p> <p>Diametro Puleggia Ø137.5            Numero Denti/Gole Puleggia 7            Altezza Puleggia 27.3            Posizione Puleggia 130.9</p> <p><b>GIRANTE</b></p> <p>Diametro Girante Ø78.6            N° Alette Girante 8            Distanza Girante 12.1</p>	
<b>FORD</b>			
<b>TRANSIT VII</b>			
24	10/2000→06/2011	D	D2FE
2.4 DI	01/2000→06/2011	D	D4FA
2.4 DI	01/2000→06/2011	D	D4FA
2.4 DI	01/2000→06/2011	D	D2FA, D2FB, D2FE
2.4 DI	01/2000→06/2011	D	F4FA
2.4 TD	08/2000→03/2011	D	F4FA
2.4 TD 4 ruote motrici	08/2000→03/2011	D	F4FA
2.4 TDCi	04/2011→06/2011	D	H9FA
2.4 TDdi	08/2000→03/2011	D	D4FA
2.4 TDdi	01/2011→06/2011	D	D2FE
2.4 TDE	04/2011→06/2011	D	FXFA
2.4 TDE	01/2011→06/2011	D	DOFA
<b>TRANSIT VIII</b>			
2.4 TDCi	06/2011→	D	PHFA
2.4 TDCi	06/2011→	D	JXFA
2.4 TDCi	06/2011→	D	H9FB, H9FD
2.4 TDCi 4 ruote motrici	06/2011→	D	H9FB
<b>82058 350982058000</b>			
		<p><b>PULEGGIA</b></p> <p>Diametro Puleggia Ø88            Numero Denti/Gole Puleggia 7            Altezza Puleggia 26.4            Posizione Puleggia 92</p> <p><b>GIRANTE</b></p> <p>Diametro Girante Ø71.6            N° Alette Girante 6            Distanza Girante 11.8</p>	
<b>CHRYSLER</b>			
<b>300 C, Touring</b>			
3.0 CRD		D	M664

MAGNETI MARELLI			
Short	Code		
<b>Model</b>			
Version		Fuel	Motor code
<b>82058</b>	<b>350982058000</b>		
<b>MERCEDES-BENZ</b>			
<b>cl. C II, Station Wagon, Coupé (203)</b>			
C 320 CDI	05/2011→	D	OM642.910
<b>cl. C III, Station Wagon (204)</b>			
C 320 CDI	07/2011→	D	OM642.960
C 320 CDI 4-matic	07/2011→	D	OM642.961
C 350 CDI	09/2011→	D	OM642.832
C 350 CDI	09/2011→	D	OM642.830
C 350 CDI 4-matic	09/2011→	D	OM642.832
C 350 CDI 4-matic	09/2011→	D	
<b>cl. E II, Station Wagon (211)</b>			
E 280 CDI	05/2011→	D	OM642.920
E 280 CDI 4-matic	05/2011→	D	OM642.921
E 280 T CDI	05/2011→	D	OM642.920
E 280 T CDI 4-matic	05/2011→	D	OM642.921
E 300 BLUETEC	07/2011→	D	OM642.920
E 320 CDI	05/2011→	D	OM642.920
E 320 CDI 4-matic	05/2011→	D	OM642.910
E 320 T CDI	05/2011→	D	OM642.920
E 320 T CDI 4-matic	05/2011→	D	OM642.920
<b>cl. E III, Station Wagon (212), Cabrio, Coupé (207)</b>			
E 350 BlueTEC	09/2011→	D	OM642.850
E 350 CDI	09/2011→	D	OM642.836, OM642.850, OM642.852
E 350 CDI 4-matic	09/2011→	D	OM642.856, OM642.858
<b>cl. GL</b>			
GL 350 CDI BlueTEC	09/2011→	D	OM642.820
<b>cl. GLK</b>			
320 CDI 4-matic	08/2011→	D	OM642.961
350 CDI 4-matic	09/2011→	D	OM642.832
<b>cl. M II (164)</b>			
ML 300 CDI 4-matic	10/2011→	D	
ML 350 CDI BlueTEC 4-matic	09/2011→	D	OM642.820
<b>cl. R (251)</b>			
R 280 CDI	06/2011→	D	OM642.950
R 320 CDI	06/2011→	D	OM642.950
<b>CLK II, Cabrio (209)</b>			
320 CDI	05/2011→	D	OM642.910
<b>CLS I (219)</b>			
320 CDI	05/2011→	D	OM642.910
350 CDI	09/2011→	D	OM642.920
<b>SPRINTER III (906)</b>			
218 CDI	06/2011→	D	OM642.992
219 CDI	09/2011→	D	OM642.992

MAGNETI MARELLI			
Short	Code		
<b>Model</b>			
Version		Fuel	Motor code
<b>SPRINTER III (906)</b>			
318 CDI	08/2011→	D	
318 CDI 4x4	08/2011→	D	OM642.992
319 CDI	09/2011→	D	OM642.992
319 CDI 4x4	09/2011→	D	
418 CDI	06/2011→	D	
419 CDI	09/2011→	D	OM642.992
518 CDI	06/2011→	D	OM642.992
519 CDI	09/2011→	D	OM642.992
<b>VITO - Viano II (639)</b>			
120 CDI	07/2011→	D	OM642.990
3.0 CDI	06/2011→	D	OM642.990

82059 350982059000			
		<b>PULEGGIA</b>	
		Diametro Puleggia	Ø88
		Numero Denti/Gole Puleggia	8
		Altezza Puleggia	29.9
		Posizione Puleggia	62
		<b>GIRANTE</b>	
		Diametro Girante	Ø71.5
		N° Alette Girante	6
		Distanza Girante	11.4
<b>MERCEDES-BENZ</b>			
<b>cl. G (460, 461, 463)</b>			
G 320 CDI	06/2011→	D	OM642.970
<b>cl. GL</b>			
GL 320 CDI	06/2011→09/2011	D	OM642.940
GL 350 CDI	09/2011→	D	OM642.940
<b>cl. M II (164)</b>			
ML 280 CDI 4-matic	05/2011→09/2011	D	OM642.940
ML 300 CDI 4-matic	09/2011→	D	OM642.940
ML 320 CDI 4-matic	05/2011→09/2011	D	OM642.940
ML 350 CDI 4-matic	10/2011→	D	
ML 350 CDI 4-matic	09/2011→	D	OM642.940
<b>cl. R (251)</b>			
R 280 CDI	06/2011→	D	OM642.950
R 300 CDI	09/2011→	D	OM642.950
R 300 CDI 4-matic	09/2011→	D	OM642.950
R 320 CDI	06/2011→	D	OM642.950
R 350 BlueTEC 4-matic	09/2011→	D	OM642.950
R 350 CDI 4-matic	09/2011→	D	OM642.950
<b>cl. S V (221), Coupé (216)</b>			
S 320 CDI	05/2011→	D	OM642.930
S 320 CDI 4-matic	06/2011→	D	OM642.930



Short **MAGNETI MARELLI** Code



Model

Version		Fuel	Motor code
---------	--	------	------------

82060 350982060000



**PULEGGIA**  
 Diametro Puleggia Ø115  
 Numero Denti/Gole Puleggia 1  
 Posizione Puleggia 74

**GIRANTE**  
 Diametro Girante Ø65  
 N° Alette Girante 7  
 Distanza Girante 50

FIAT

UNO

1.4 Turbo i.e.	09/1989→09/1993	B	146A8.046
1.4 Turbo i.e.	12/1989→12/1996	B	146A8.000
70 i.e. 1.4	09/1989→12/1993	B	160A1.046
70 i.e. 1.4	09/1989→12/1993	B	146C1.000

LANCIA

DELTA I

13	09/1979→08/1992	B	831A2.000, 831B.000
13	09/1983→08/1992	B	
15	09/1979→12/1992	B	831A1.000, 831B1.000

PRISMA

13	01/1983→02/1992	B	
----	-----------------	---	--

82063 350982062300



**PULEGGIA**  
 Diametro Puleggia Ø99  
 Altezza Puleggia 30  
 Posizione Puleggia 39.4

**GIRANTE**  
 Diametro Girante Ø44.8  
 N° Alette Girante 6  
 Distanza Girante 21.4

CITROËN

C 1

10	05/2011→	B	1KR-FE
----	----------	---	--------

DAIHATSU

CUORE VIII

10	07/2011→	B	1KR-FE
----	----------	---	--------

SIRION II

10	05/2011→	B	1KR-FE
1.0 DVVT Executive 4x4	05/2011→	B	1KR-FE

Short **MAGNETI MARELLI** Code



Model

Version		Fuel	Motor code
---------	--	------	------------

STORIA

10	05/2011→	B	
----	----------	---	--

PEUGEOT

107

10	05/2011→	B	1KR (384F)
----	----------	---	------------

SUBARU

JUSTY IV

10	07/2011→	B	
----	----------	---	--

TOYOTA

AYGO

10	05/2011→	B	1KR-FE
1.0 GPL	05/2011→		

YARIS II

1.0 GPL	06/2011→		
1.0 VVT-i	06/2011→	B	1KR-FE

82066 350982066000



**FLANGIA**  
 Numero Fori Flangia 1  
 Dimensione Fori Flangia M8x1.25  
 Posizione Flangia 71.6

**GIRANTE**  
 Diametro Girante Ø94.5  
 N° Alette Girante 5  
 Distanza Girante 17.7

CITROËN

JUMPER III

2.2 HDi 100	06/2011→	D	
2.2 HDi 120	06/2011→	D	

FIAT

DUCATO V

100 Multijet 2,2 D	06/2011→	D	4HV
--------------------	----------	---	-----

FORD

TRANSIT TOURNEO II

2.2 TDCi	06/2011→	D	QWFA
2.2 TDCi	06/2011→	D	QVFA
2.2 TDCi	07/2011→	D	PGFA
2.2 TDCi	08/2011→	D	SRFA

TRANSIT VIII

2.2 TDCi	06/2011→	D	QWFA
2.2 TDCi	06/2011→	D	QVFA
2.2 TDCi	06/2011→	D	P8FA
2.2 TDCi	07/2011→	D	PGFA
2.2 TDCi	08/2011→	D	SRFA

Short	Code
-------	------



Model			
Version		Fuel	Motor code
82066		350982066000	
<b>PEUGEOT</b>			
<b>BOXER III</b>			
2.2 HDi 100	06/2011→	D 4HV	
2.2 HDi 120	06/2011→	D 4HU	

Short	Code
-------	------



<b>FLANGIA</b>	
Numero Fori Flangia	3
Dimensione Fori Flangia	M8x1.25
Posizione Flangia	81
Numero Fori Flangia (Serie 2)	3
Dimensione Fori Flangia (Serie 2)	7x12.5
Diametro Centraggio	Ø28
<b>GIRANTE</b>	
Diametro Girante	Ø65
N° Alette Girante	7
Distanza Girante	30

<b>CITROËN</b>			
<b>C 5 III, Break</b>			
2.7 HDi	08/2011→	D DT17ED4	
<b>C 6</b>			
2.7 HDi 205 FAP	05/2011→	D DT17ED4	
<b>PEUGEOT</b>			
<b>407, Break, Coupé</b>			
2.7 HDi	05/2011→	D UHZ (DT17)	
<b>607</b>			
2.7 HDi 24V	04/2011→	D DT17TED4	

Short	Code
-------	------





<b>PULEGGIA</b>	
Diametro Puleggia	Ø56.2
Numero Denti/Gole Puleggia	19
Altezza Puleggia	32.2
Posizione Puleggia	41.5
<b>GIRANTE</b>	
Diametro Girante	Ø90.5
N° Alette Girante	8
Distanza Girante	34.5



<b>CITROËN</b>			
<b>C 5 II, Break</b>			
2.2 HDi	06/2011→	D 4HT (DW12BTED4)	
<b>C 5 III, Break</b>			
2.2 HDi	08/2011→	D 4HT (DW12BTED4)	
<b>C 6</b>			
2.2 HDi 173 FAP	06/2011→	D 4HT (DW12BTED4)	

Short	Code
-------	------



Model			
Version		Fuel	Motor code
<b>C 8</b>			
2.2 HDi	06/2011→	D 4HT (DW12BTED4)	
<b>C-Crosser, Enterprise</b>			
2.2 HDi	07/2011→	D	
<b>FIAT</b>			
<b>ULYSSE II</b>			
2.2 D Multijet	08/2011→	D	
<b>FORD</b>			
<b>GALAXY I</b>			
2.2 TDCi	08/2011→	D Q4WA	
<b>MONDEO IV, Station Wagon</b>			
2.2 TDCi	08/2011→	D Q4BA	
<b>S-MAX</b>			
2.2 TDCi	08/2011→	D Q4WA	
<b>LANCIA</b>			
<b>PHEDRA</b>			
2.2 D Multijet	08/2011→	D	
<b>LAND ROVER</b>			
<b>FREELANDER 2</b>			
22	06/2011→	D	
2.2 SD4	10/2011→	D	
2.2 TD4	07/2011→	D	
2.2 TD4	10/2011→	D	
2.2 TD4 4x4	06/2011→	D	
2.2 TD4 4x4	06/2011→	D	
<b>MITSUBISHI</b>			
<b>OUTLANDER II</b>			
2.2 DI-D	07/2011→	D 4HN	
<b>PEUGEOT</b>			
<b>4007</b>			
2.2 HDi	07/2011→	D	
<b>407, Break, Coupé</b>			
2.2 HDi	08/2011→	D	
2.2 HDi 170 FAP	06/2011→	D 4HT (DW12BTED4)	
<b>508, Station Wagon</b>			
2.2 HDi	10/2011→	D	
<b>607</b>			
2.2 HDi	06/2011→	D 4HT (DW12BTED4)	
<b>807</b>			
2.2 HDi	06/2011→	D 4HT (DW12BTED4)	

MAGNETI MARELLI			
Short	Code		
			
<b>Model</b>			
Version		Fuel	Motor code
82069	350982069000		
		<b>FLANGIA</b> Numero Fori Flangia 3 Dimensione Fori Flangia M8x1.25 Diametro Centraggio Ø28.3 Posizione Flangia 43.6  <b>GIRANTE</b> Diametro Girante Ø67.2 N° Alette Girante 16 Distanza Girante 55	
<b>NISSAN</b>			
<b>PRIMASTAR</b>			
dCi 120	06/2011→	D	
dCi 90	06/2011→	D	
<b>QASHQAI</b>			
2.0 dCi	07/2011→	D	M1D
2.0 dCi 4 ruote motrici	07/2011→	D	M1D
<b>X-TRAIL II</b>			
2.0 dCi	07/2011→	D	M9R760
2.0 dCi	07/2011→	D	M9R
2.0 dCi FWD	07/2011→	D	
<b>OPEL</b>			
<b>MOVANO A</b>			
2.3 CDTI [RWD]	10/2011→	D	
2.3 CDTI [RWD]	10/2011→	D	
2.3 CDTI [RWD]	10/2011→	D	
2.3 CDTI FWD	10/2011→	D	
2.3 CDTI FWD	10/2011→	D	
2.3 CDTI FWD	10/2011→	D	
<b>MOVANO B</b>			
2.3 CDTI FWD	10/2011→	D	
2.3 CDTI FWD	10/2011→	D	
2.3 CDTI FWD	10/2011→	D	
<b>VIVARO</b>			
2.0 CDTI	06/2011→	D	
2.0 CDTI	06/2011→	D	M9R780
<b>RENAULT</b>			
<b>ESPACE IV</b>			
2.0 dCi	06/2011→	D	M9R760
2.0 dCi	06/2011→	D	
2.0 dCi	06/2011→	D	M9R740
<b>KoEIOS</b>			
2.0 dCi	08/2011→	D	M9R832
2.0 dCi	08/2011→	D	
2.0 dCi 4x4	08/2011→	D	M9R832

MAGNETI MARELLI			
Short	Code		
			
<b>Model</b>			
Version		Fuel	Motor code
<b>KoEIOS</b>			
2.0 dCi 4x4	08/2011→	D	M9R830
<b>LAGUNA II, GRANDtour</b>			
2.0 dCi	06/2011→	D	M9R760
2.0 dCi	05/2011→	D	M9R740
<b>LAGUNA III, GRANDtour</b>			
2.0 dCi	08/2011→	D	M9R800, M9R816
2.0 dCi	07/2011→	D	M9R740, M9Ra742
2.0 dCi	07/2011→	D	M9R802
2.0 dCi GT	08/2011→	D	M9R816, M9Rk816
3.0 dCi	08/2011→	D	M9R891
<b>MEGANE II, Station Wagon, C-C, Scenic</b>			
2.0 dCi	07/2011→	D	M9R724
2.0 dCi	05/2011→	D	M9R700
2.0 DCi Dynamic	05/2011→	D	M9R700
<b>MEGANE III, Station Wagon, C-C, Scenic</b>			
2.0 16V	09/2011→	B	M4RF713
2.0 dCi	09/2011→	D	M9R610
<b>SCENIC I, GRAND SCENIC</b>			
2.0 dCi	05/2011→	D	M9R700
<b>SCENIC II, GRAND SCENIC</b>			
2.0 dCi	05/2011→	D	M9R700
<b>SCENIC III, GRAND SCENIC</b>			
2.0 dCi	09/2011→	D	M9R615
2.0 dCi	09/2011→	D	M9R610
<b>TRAFIC II</b>			
2.0 dCi	06/2011→	D	M9R780
2.0 dCi	06/2011→	D	M9R780, M9R782
<b>VEL SATIS</b>			
2.0 dCi	06/2011→	D	M9R760
2.0 dCi	05/2011→	D	M9R760
<b>82070 350982070000</b>			
		<b>PULEGGIA</b> Diametro Puleggia Ø57 Numero Denti/Gole Puleggia 23 Altezza Puleggia 23.5 Posizione Puleggia 53.8  <b>GIRANTE</b> Diametro Girante Ø63 N° Alette Girante 9 Distanza Girante 34	
<b>ALFA ROMEO</b>			
<b>GIULIETTA</b>			
1.4 TB	10/2011→	B	198A4.000

MAGNETI MARELLI			
Short	Code		
<b>Model</b>			
Version		Fuel	Motor code
82070	350982070000		
<b>ALFA ROMEO</b>			
<b>MITO</b>			
14	10/2011→	B	
14	08/2011→	B	199A1.000
14	08/2011→	B	198A4.000
14	08/2011→	B	955A1.000
1.4 TB	08/2011→	B	199A8.000
1.4 TB	09/2011→	B	940A2.000
1.4 TB	09/2011→	B	
1.4 Turbo	08/2011→	B	198A1.000
<b>FIAT</b>			
<b>500 II, Cabrio</b>			
12	07/2011→	B	169A4.000
14	07/2011→	B	169A3.000
1.4 Abarth	08/2011→	B	
1.4 Abarth	08/2011→	B	
1.4 Abarth	08/2011→	B	
1.4 Abarth	09/2011→	B	
<b>BRAVO II</b>			
14	07/2011→	B	192B2.000
1.4 T-Jet	07/2011→	B	198A4.000
1.4 T-Jet	07/2011→	B	198A1.000
<b>DOBLO' I, Cargo</b>			
14	05/2011→	B	350A1.000
<b>GRANDe PUNTO</b>			
12	10/2011→	B	
12	05/2011→	B	199A4.000
14	05/2011→	B	350A1.000
1.4 16V	05/2011→	B	199A6.000
1.4 T-Jet	07/2011→	B	198A4.000
<b>IDEA</b>			
1.2 16V	04/2011→	B	188A5.000
14	05/2011→	B	350A1.000
1.4 16V	04/2011→	B	843A1.000
<b>LINEA</b>			
14	07/2011→	B	350A1.000
1.4 T-Jet	07/2011→	B	198A4.000
<b>PANDA II, Van</b>			
12	10/2011→	B	169A4.000
12	03/2011→	B	188A4.000
1.2 4x4	04/2011→	B	188A4.000
1.2 4x4	04/2011→	B	169A4.000
1.2 LPG	09/2011→	B	188A4.000
14	06/2011→	B	169A3.000

MAGNETI MARELLI			
Short	Code		
<b>Model</b>			
Version		Fuel	Motor code
<b>PANDA II, Van</b>			
1.4 Bi-Power / Natural Power	07/2011→	BF	
<b>PUNTO Evo</b>			
12	09/2011→	B	199A4.000
12	09/2011→	B	
14	09/2011→	B	350A1.000
1.4 16V	09/2011→	B	955A6.000
1.4 16V	09/2011→	B	955A2.000
1.4 Abarth	09/2011→	B	
1.4 Natural Power	09/2011→	BF	
<b>PUNTO II, Van</b>			
1.2 Natural Power	03/2011→	BF	188A4.000
<b>QUBO</b>			
14	09/2011→	B	
1.4 Natural Power	09/2011→	M	
<b>STILO, Station Wagon</b>			
1.4 16V	04/2011→	B	843A1.000
1.4 16V	05/2011→	B	192B2.000
<b>STRADA</b>			
12	03/2011→	B	188A4.000
12	06/1999→	B	178B5.000
<b>LANCIA</b>			
<b>DELTA III</b>			
14	08/2011→	B	198A1.000
14	08/2011→	B	198A4.000
1.4 16V	10/2011→	B	
<b>MUSA</b>			
14	05/2011→	B	350A1.000
14	04/2011→	B	843A1.000
<b>YPSILON</b>			
12	03/2011→	B	188A5.000
12	03/2011→	B	188A4.000
14	06/2011→	B	350A1.000
14	03/2011→	B	843A1.000
<b>TATA (TELCO)</b>			
<b>INDICA VISTA</b>			
12	08/2011→	B	
<b>INDIGO MANZA</b>			
14	09/2011→	B	350A1.000

Short **MAGNETI MARELLI** Code



Model

Version		Fuel	Motor code
---------	--	------	------------

82071		350982071000	
-------	--	--------------	--

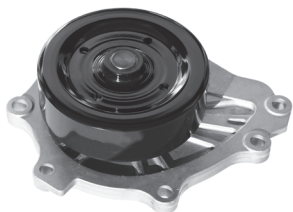

**PULEGGIA**  
 Diametro Puleggia Ø109.9  
 Altezza Puleggia 31.5  
 Posizione Puleggia 54

**GIRANTE**  
 Diametro Girante Ø74  
 N° Alette Girante 7  
 Distanza Girante 18.9

**LEXUS**

**IS**

220 d	05/2011→	D	2AD-FHV
-------	----------	---	---------

**TOYOTA**

**AURIS**

2.0 D-4D	07/2011→	D	1AD-FTV
----------	----------	---	---------

2.2 D	07/2011→	D	2AD-FHV
-------	----------	---	---------

**AVENSIS II, Station Wagon**

2.0 D-4D	06/2011→	D	1AD-FTV
----------	----------	---	---------

2.2 D-4D	05/2011→	D	2AD-FTV
----------	----------	---	---------

2.2 D-CAT	05/2011→	D	2AD-FHV
-----------	----------	---	---------

**AVENSIS III, Station Wagon**

2.0 D	09/2011→	D	1AD-FTV
-------	----------	---	---------

2.2 D	09/2011→	D	2AD-FTV
-------	----------	---	---------

2.2 D	09/2011→	D	2AD-FHV
-------	----------	---	---------

**COROLLA Verso II**

2.2 D-4D	05/2011→	D	2AD-FTV
----------	----------	---	---------

2.2 D-4D	05/2011→	D	2AD-FHV
----------	----------	---	---------

**COROLLA VII, Station Wagon, Liftback**

2.2 D4d	06/2011→	D	2AD-FHV
---------	----------	---	---------

**RAV 4 III**

2.2 D-4D	06/2011→	D	2AD-FTV
----------	----------	---	---------

2.2 D-4D	08/2011→	D	2AD-FTV
----------	----------	---	---------

2.2 D-CAT	06/2011→	D	2AD-FHV
-----------	----------	---	---------

**VERSO**

2.0 D-4D	09/2011→	D	1AD-FTV
----------	----------	---	---------

2.2 D-4D	09/2011→	D	2AD-FHV
----------	----------	---	---------

2.2 D-CAT	09/2011→	D	2AD-FHV
-----------	----------	---	---------

Short **MAGNETI MARELLI** Code



Model

Version		Fuel	Motor code
---------	--	------	------------

82072		350982072000	<b>NEW</b>
-------	--	--------------	------------

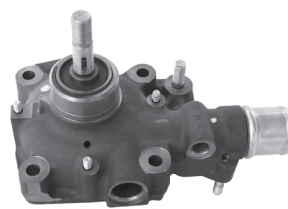

**GIRANTE**  
 Diametro Alberino M14x1.5  
 Tipo Filetto Alberino Maschio  
 Lunghezza Alberino 131.5

**GIRANTE**  
 Diametro Girante Ø94  
 N° Alette Girante 8  
 Distanza Girante 19.7

**IVECO**

**DAILY II**

29 L 11	05/1999→		8140.43B, 8140.43C
---------	----------	--	--------------------

29 L 11 V	05/1999→		8140.43C
-----------	----------	--	----------

29 L 9	05/1999→		814063
--------	----------	--	--------

29 L 9 V	05/1999→		814063
----------	----------	--	--------

35 S 13 V,35 C 13 V	05/1999→		8140.43S
---------------------	----------	--	----------

35 S 13,35 C 13	05/1999→		8140.43S
-----------------	----------	--	----------

50 C 11	05/1999→		8140.43C
---------	----------	--	----------

50 C 13	05/1999→		8140.43S
---------	----------	--	----------

82080 350982080000

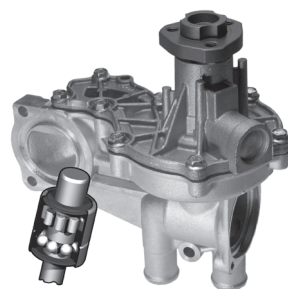

**FLANGIA**  
 Numero Fori Flangia 3  
 Dimensione Fori Flangia M8x1.25  
 Posizione Flangia 74  
 Diametro Mozzo Ø30

**GIRANTE con CUSCINETTO RULLO-SFERA**  
 Diametro Girante Ø59  
 N° Alette Girante 6  
 Distanza Girante 29.5

**AUDI**

**100 IV, Avant**

16	03/1992→07/1993	B	
----	-----------------	---	--

20	08/1992→07/1993	B	ACE
----	-----------------	---	-----

20	12/1990→06/1994	B	AAE
----	-----------------	---	-----

2.0 E	09/1991→06/1994	B	AAE
-------	-----------------	---	-----

2.0 E	12/1990→06/1994	B	AAD, ABK
-------	-----------------	---	----------

2.0 E 16V	01/1992→06/1994	B	ACE
-----------	-----------------	---	-----

2.0 E 16V quattro	07/1992→06/1994	B	ACE
-------------------	-----------------	---	-----

2.0 E quattro	12/1990→07/1992	B	AAD
---------------	-----------------	---	-----

2.0 quattro	08/1992→07/1993	B	ACE
-------------	-----------------	---	-----

**80 IV, Avant**

16	09/1991→12/1994	B	ABM
----	-----------------	---	-----

1.6 E	06/1993→01/1996	B	ADA
-------	-----------------	---	-----

MAGNETI MARELLI			
Short	Code		
<b>Model</b>			
Version		Fuel	Motor code
82080	350982080000		
<b>AUDI</b>			
<b>80 IV, Avant</b>			
1.9 TD	09/1991→12/1994	D	AAZ
1.9 TDI	09/1991→01/1996	D	1Z
20	09/1991→01/1996	B	ABT
2.0 E	09/1991→01/1996	B	ABK
2.0 E 16V	08/1992→01/1996	B	ACE
2.0 E 16V quattro	04/1992→07/1995	B	ACE
2.0 E quattro	09/1991→12/1994	B	ABK
2.0 quattro	11/1993→07/1996	B	ADW
<b>A6 I, Avant</b>			
1.9 TDI	06/1994→12/1997	D	1Z, AHU
20	06/1994→12/1997	B	AAE
20	06/1994→12/1997	B	ABK
20	08/1995→07/1996	B	ADW
2.0 16V	06/1994→12/1997	B	ACE
2.0 16V quattro	06/1994→12/1997	B	ACE
<b>Cabrio</b>			
1.9 TDI	06/1995→08/2000	D	1Z, AHU
2.0 16V	06/1995→07/1996	B	ACE
2.0 E	01/1993→07/1998	B	ABK
<b>Coupé II</b>			
20	05/1989→12/1996	B	AAE, ABK
2.0 16 V	01/1992→07/1992	B	0,25
2.0 16 V	08/1992→12/1996	B	ACE
<b>FORD</b>			
<b>GALAXY I</b>			
1.9 TDI	03/1995→06/2011	D	1Z, AHU, ANU
1.9 TDI	08/1997→04/2000	D	AFN, AVG
<b>SEAT</b>			
<b>ALHAMBRA I</b>			
1.9 TDI	04/1996→	D	1Z, AHU, ANU
1.9 TDI	08/1996→06/2000	D	AFN, AVG
2.0 i	04/1996→	B	ADY, ATM
<b>CORDOBA I, Vario</b>			
1.6 i	05/1994→06/1999	B	1F
1.6 i	07/1996→06/1999	B	AFT
1.6 i	09/1996→06/1999	B	AEE, ALM
1.7 SDI	07/1997→06/1999	D	
1.8 i	02/1993→06/1999	B	ABS, ADZ
1.8 i 16V	10/1993→08/1996	B	ADL
1.9 D	01/1996→08/1996	D	1Y
1.9 D	02/1993→08/1996	D	1Y
1.9 SDI	08/1996→06/1999	D	AEY

MAGNETI MARELLI			
Short	Code		
<b>Model</b>			
Version		Fuel	Motor code
<b>CORDOBA I, Vario</b>			
1.9 TD	02/1993→08/1996	D	AAZ
1.9 TDI	03/1997→06/1999	D	AFN
1.9 TDI	08/1996→06/1999	D	1Z, AHU
2.0 i	02/1993→06/1999	B	2E, AGG
2.0 i 16V	08/1996→06/1999	B	ABF
<b>IBIZA II</b>			
1.6 i	03/1993→08/1999	B	ABU, AEE, ALM
1.6 i	04/1996→08/1999	B	AFT
1.6 i	09/1994→06/1999	B	1F
1.8 i	03/1993→08/1999	B	ABS, ADZ
1.8 i 16V	11/1993→08/1996	B	ADL
1.9 D	04/1993→08/1996	D	1Y
1.9 D	10/1994→08/1996	D	1Y
1.9 SDI	08/1996→08/1999	D	AEY
1.9 TD	03/1993→08/1996	D	AAZ
2.0 i	03/1993→08/1999	B	2E, AGG
2.0 i 16V	08/1996→08/1999	B	ABF
<b>INCA</b>			
1.6 i	11/1995→05/1998	B	1F
1.7 D	09/1996→03/2011	D	AHB
1.9 D	11/1995→03/2011	D	1Y
1.9 SDI	11/1995→03/2011	D	AEY, AYQ
<b>TOLEDO I</b>			
1.6 i	01/1993→03/1999	B	1F
1.6 i	05/1991→12/1993	B	1F
1.6 i	05/1991→03/1999	B	1F, ABN, EZ
1.6 i	11/1996→03/1999	B	AFT
1.8 16V	05/1991→03/1999	B	KR
1.8 16V	05/1991→03/1999	B	PL
1.8 GT	05/1991→11/1992	B	KR
1.8 i	05/1991→12/1996	B	RP
1.8 i	11/1993→12/1996	B	ABS, ADZ
1.9 D	05/1991→03/1999	D	1Y
1.9 D	12/1995→03/1999	D	1Y
1.9 SDI	12/1995→03/1999	D	1Y
1.9 TD	05/1991→03/1999	D	AAZ
1.9 TDI	08/1995→03/1999	D	1Z, AHU
1.9 TDI	11/1996→03/1999	D	AFN
2.0 i	05/1991→03/1999	B	2E, AGG
2.0 i 16V	11/1993→03/1999	B	ABF
<b>VOLKSWAGEN</b>			
<b>CADDY I</b>			
16	01/1983→07/1992	B	EW
1.6 D	08/1982→07/1992	D	JK, ME

MAGNETI MARELLI			
Short	Code		
<b>Model</b>			
Version		Fuel	Motor code
82080	350982080000		
<b>VOLKSWAGEN</b>			
<b>CADDY I</b>			
18	08/1985→07/1992	B JH	
<b>CADDY II</b>			
16	11/1995→05/1997	B 1F	
1.7 SDI	07/1996→09/2000	D AHB	
1.9 D	11/1995→04/2011	D 1Y	
1.9 SDI	11/1995→04/2011	D AEY, AYQ	
1.9 TDI	09/1996→04/2011	D 1Z, AHU, ALE, ALH	
75 1.6	11/1995→05/1997	B 1F	
<b>CORRADO</b>			
1.8 16V	04/1989→07/1992	B KR	
1.8 G60	09/1988→09/1993	B PG	
2.0 i	04/1993→12/1995	B 2E, ADY	
2.0 i 16V	08/1991→12/1995	B 0,375	
<b>GOLF I, Cabrio</b>			
16	01/1983→04/1992	B EW, HN	
18	08/1983→04/1993	B JH	
18	08/1983→09/1992	B EX	
18	08/1989→03/1993	B 2H	
<b>GOLF II</b>			
16	08/1983→07/1992	B ABN, EZ, HM	
16	10/1986→12/1992	B PN	
20	08/1985→07/1992	B	
<b>GOLF III, Cabrio, Variant</b>			
16	07/1994→04/1999	B AEK, AFT, AKS	
18	11/1991→04/1999	B ABS, ACC, ADZ, ANP	
18	11/1991→04/1999	B AAM, ANN	
1.8 Syncro	01/1993→04/1999	B ABS, ADZ	
1.9 D	11/1991→04/1999	D 1Y	
1.9 SDI	07/1995→08/1997	D AEY	
1.9 TD	07/1993→04/1999	D AAZ	
1.9 TD,GTD	11/1991→08/1997	D AAZ	
1.9 TDI	04/1996→04/1999	D AFN	
1.9 TDI	09/1993→04/1999	D 1Z, AHU, ALE	
1.9 TDI Syncro	07/1995→04/1999	D 1Z, AHU	
20	11/1991→04/1999	B 2E, ADY, AGG, AKR	
2.0 GTI 16V	08/1992→08/1997	B ABF	
2.0 Syncro	08/1995→04/1999	B AGG	
<b>GOLF IV, Cabrio, Variant</b>			
16	06/1998→02/2011	B AFT, AKS	
18	06/1998→02/2011	B AAM, ANN	
18	06/1998→02/2011	B ADZ, ANP	
1.9 TDI	06/1998→02/2011	D AHU, ALE	

MAGNETI MARELLI			
Short	Code		
<b>Model</b>			
Version		Fuel	Motor code
<b>GOLF IV, Cabrio, Variant</b>			
1.9 TDI	06/1998→02/2011	D AFN, AVG	
20	06/1998→02/2011	B AGG, AKR, ATU, AWF, AWG	
<b>JETTA II</b>			
16	01/1984→07/1992	B ABN, EZ, HM	
<b>PASSAT III, Variant</b>			
16	07/1994→08/1996	B AEK, AFT	
1.6 TD	08/1988→09/1993	D RA, SB	
18	02/1988→05/1997	B ABS, ADZ, RP	
18	04/1988→07/1993	B PF	
18	04/1988→07/1992	B PB	
18	08/1990→05/1997	B AAM	
18	08/1991→09/1993	B KR	
1.8 G60 Syncro	08/1988→05/1997	B PG	
1.8 G60 Syncro	09/1989→07/1993	B PF	
1.8 GL	08/1991→09/1993	B KR	
1.9 D	05/1989→10/1993	D 1Y	
1.9 TD	03/1991→05/1997	D AAZ	
1.9 TDI	03/1996→05/1997	D AFN	
1.9 TDI	10/1993→05/1997	D 1Z, AHU	
20	02/1990→05/1997	B 2E, ADY, AGG	
20	03/1995→08/1996	B AEP	
2.0 16V	01/1994→05/1997	B ABF	
2.0 16V	08/1988→09/1993	B 0,375	
2.0 Syncro	09/1989→07/1992	B	
2.0 Syncro	10/1990→05/1997	B 2E, ADY, AGG	
<b>POLO III, Classic, Variant, Van</b>			
16	05/1997→01/2011	B AEH, AFT, AKL, APF, AUR	
1.6 RC	05/1996→02/2011	B AFT	
1.7 SDI	08/1997→01/2011	D AKW	
18	05/1997→01/2011	B ADZ	
1.9 SDI	06/1997→01/2011	D AEY	
1.9 TDI	05/1997→01/2011	D AGR, AHU, ALE, ALH	
100 1.6	12/1995→01/2011	B AEH, AFT, AKL, APF, AUR	
110 1.9 TDI	06/1998→01/2011	D AFN, ASV	
57 1.7 SDI	07/1997→01/2011	D AKW	
64 1,9 D	01/1996→10/1996	D 1Y	
64 1.9 SDI	12/1995→08/1999	D 1Y, AEY	
75 1.6	11/1995→09/1997	B 1F	
90 1.8	01/1997→01/2011	B ADD	
90 1.9 TDI	09/1996→01/2011	D AGR, AHU, ALE, ALH	
<b>SAVEIRO I</b>			
16	08/1990→07/1996	B 1F, EW	
<b>SAVEIRO II</b>			
16	08/1996→02/2011	B 1F, EW	

Short **MAGNETI MARELLI** Code



Model

Version		Fuel	Motor code
<b>82080</b>	<b>350982080000</b>		
<b>VOLKSWAGEN</b>			
<b>SCIROCCO II</b>			
18	08/1983→07/1992	B EX	
18	11/1985→07/1992	B JH	
1.8 16V	03/1986→07/1992	B PL	
<b>SHARAN I</b>			
1.9 TDI	09/1995→	D 1Z, AHU, ANU	
1.9 TDI	09/1996→04/2000	D AFN, AVG	
20	09/1995→	B ADY, ATM	
<b>TRANSPORTER III</b>			
1.6 TD	08/1984→07/1992	D JX	
1.6 TD Syncro	03/1986→07/1992	D JX	
1.7 D	10/1986→07/1992	D KY	
<b>TRANSPORTER IV</b>			
18	12/1990→07/1992	B PD	
1.9 D	07/1990→03/2011	D 1X	
1.9 D	09/1990→03/2011	D 1X	
1.9 TD	10/1992→03/2011	D ABL	
20	07/1990→03/2011	B AAC	
<b>VENTO</b>			
16	10/1994→09/1998	B AEK, AFT	
18	11/1991→09/1998	B ABS, ADZ	
18	11/1991→09/1998	B AAM	
1.9 D	11/1991→09/1998	D 1Y	
1.9 SDI	04/1997→09/1998	D AEY	
1.9 TD	11/1991→09/1998	D AAZ	
1.9 TDI	04/1996→09/1998	D AFN	
1.9 TDI	09/1993→09/1998	D 1Z, AHU, ALE	
20	11/1991→09/1998	B 2E, ADY, AGG, AKR	
2.0 GL	05/1996→12/1997	B AEP	
2.0 GL	11/1991→07/1998	B AAC	

**82081** **350982081000** NEW

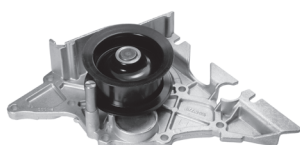

**PULEGGIA**  
 Diametro Puleggia 066  
 Altezza Puleggia 30.5  
 Posizione Puleggia 60.8

**GIRANTE**  
 Diametro Girante 079  
 N° Alette Girante 5  
 Distanza Girante 29.4

**AUDI**

**A6 II, Avant**

37	03/1999→05/2011	B AQG	
----	-----------------	-------	--

Short **MAGNETI MARELLI** Code



Model

Version		Fuel	Motor code
<b>A6 II, Avant</b>			
3.7 quattro	03/1999→05/2011	B AQG	
4.2 quattro	11/1998→05/2011	B ARS, ASG, AWN	
RS6	02/2011→05/2011	B BCY	
RS6 plus	04/2011→05/2011	B BRV	
S6 quattro	09/1999→05/2011	B ANK, AQJ	
<b>A8 I</b>			
37	11/1998→02/2011	B AKC, AQG	
3.7 quattro	02/2011→10/2011	B BFL	
3.7 quattro	11/1998→02/2011	B AKC, AQG	
4.2 quattro	02/1999→04/2000	B ARU	
4.2 quattro	02/2011→10/2011	B BFM	
4.2 quattro	11/1998→02/2011	B AQF, AUW, AUX	
S 8 quattro	06/1999→02/2011	B AQH, AVP	
<b>VOLKSWAGEN</b>			
<b>PHAETON</b>			
4.2 V8 4motion	03/2011→	B BGH, BGJ	
<b>TOUAREG I</b>			
4.2 V8	02/2011→06/2011	B AXQ, BHX	

**82082** **350982082000** NEW



**PULEGGIA**  
 Diametro Puleggia 090  
 Altezza Puleggia 34.5  
 Posizione Puleggia 74.8

**GIRANTE**  
 Diametro Girante 073.5  
 N° Alette Girante 6  
 Distanza Girante 12.45

**MERCEDES-BENZ**

**cl. C III, Station Wagon (204)**

C 200 CDI	07/2011→	D OM646.811	
C 220 CDI	07/2011→	D OM646.811	
C 220 CDI	09/2011→	D	
C 220 CDI	08/2011→	D OM651.911	



**cl. CLC**

CLC 200 CDI	08/2011→	D OM646.962	
CLC 220 CDI	08/2011→	D OM646.963	

**cl. E II, Station Wagon (211)**



200 CDI	06/2011→	D OM646.820	
220 CDI	02/2011→	D OM646.961	
E 200 CDI	06/2011→	D OM646.821	
E 200 CDI	02/2011→	D OM646.951	
E 200 CDI	02/2011→	D OM646.951	
E 220 CDI	02/2011→	D OM646.961	



MAGNETI MARELLI			
Short	Code		
			
<b>Model</b>			
Version		Fuel	Motor code
<b>82082</b>	<b>350982082000</b>	<b>NEW</b>	
<b>MERCEDES-BENZ</b>			
<b>cl. E II, Station Wagon (211)</b>			
E 220 CDI	06/2011→	D	OM646.821
E 220 T CDI	03/2011→	D	OM646.961
E 220 T CDI	06/2011→	D	OM646.821
<b>CLK II, Cabrio (209)</b>			
220 CDI	05/2011→	D	OM646.966

MAGNETI MARELLI			
Short	Code		
<b>82083</b>	<b>350982083000</b>	<b>NEW</b>	
			
<b>FLANGIA</b>			
Numero Fori Flangia			3
Dimensione Fori Flangia			M8x1.25
Posizione Flangia			46.5
Diametro Mozzo			Ø30
<b>GIRANTE</b>			
Diametro Girante			Ø54
N° Alette Girante			8
Distanza Girante			27

<b>ALFA ROMEO</b>			
<b>159, Sportwagon</b>			
1.8 MPI	07/2011→	B	939A4.000
<b>CHEVROLET</b>			
<b>CRUZE</b>			
16	09/2011→	B	
16	09/2011→	B	
18	09/2011→	B	
18	09/2011→	B	
<b>FIAT</b>			
<b>CROMA II</b>			
1.8 16V	05/2011→	B	939A4.000
<b>STILO, Station Wagon</b>			
16	05/2011→	B	
<b>OPEL</b>			
<b>ASTRA G, Station Wagon, Cabrio</b>			
16	02/2011→05/2011	B	Z16XEP
1.6 16V	03/2000→05/2011	B	Z16XEP
<b>ASTRA H, Station Wagon, Cabrio, HTC, TwinTop</b>			
16	07/2011→	B	Z16XER
16	04/2011→	B	Z16XEP
16	06/2011→	B	Z16XER
1.6 CNG	05/2011→		Z16YNG
1.6 CNG	05/2011→	B	Z16YNG
1.6 Turbo	07/2011→	B	Z16LET
18	04/2011→	B	Z18XE

MAGNETI MARELLI			
Short	Code		
			
<b>Model</b>			
Version		Fuel	Motor code
<b>ASTRA H, Station Wagon, Cabrio, HTC, TwinTop</b>			
18	05/2011→	B	Z18XER
<b>ASTRA J</b>			
16	09/2011→	B	A16XER
1.6 Turbo	09/2011→	B	A16LET
<b>CORSA D</b>			
1.6 Turbo	07/2011→	B	Z16LEL
1.6 Turbo	07/2011→	B	Z16LER
<b>INSIGNA, Station Wagon</b>			
16	08/2011→	B	A16XER
1.6 Turbo	08/2011→	B	A16LET
18	08/2011→	B	A18XER
<b>MERIVA A</b>			
16	06/2011→	B	Z16XEP
1.6 Turbo	05/2011→	B	Z16LET
<b>SIGNUM</b>			
18	05/2011→	B	Z18XER
<b>VECTRA C, Station Wagon, GTS</b>			
16	06/2011→	B	Z16XEP
18	06/2011→	B	Z18XER
<b>ZAFIRA B</b>			
16	08/2011→	B	Z16XER
16	05/2011→	B	Z16XEP
18	05/2011→	B	Z18XEP, Z18XER
<b>SAAB</b>			
<b>9-5 II, Station Wagon</b>			
1.6 T	10/2011→	B	
<b>VAUXHALL</b>			
<b>ASTRA</b>			
1.6 16V	02/1998→	B	X16XEL, Z16XE
1.6 i 16v Turbo	09/2011→	B	A16LET
1.6 i 16v VVT	09/2011→	B	A16XER

Short	Code
-------	------



### Model

Version		Fuel	Motor code
---------	--	------	------------

82084	350982084000	<b>NEW</b>	
-------	--------------	------------	--



<b>PULEGGIA</b>	
Diametro Puleggia	Ø105
Altezza Puleggia	31
Posizione Puleggia	70.7
<b>GIRANTE</b>	
Diametro Girante	Ø78
N° Alette Girante	8
Distanza Girante	13.5

### MERCEDES-BENZ

#### cl. E II, Station Wagon (210)

E 320 CDI	07/1999→02/2011	D	OM613.961
E 320 T CDI	07/1999→03/2011	D	OM613.961

82085	350982085000	<b>NEW</b>	
-------	--------------	------------	--

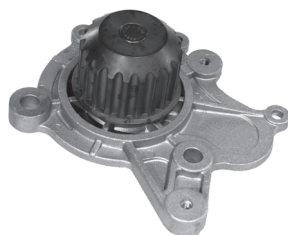

<b>PULEGGIA</b>	
Diametro Puleggia	Ø59
Numero Denti/Gole Puleggia	20
Altezza Puleggia	30
Posizione Puleggia	48
<b>GIRANTE</b>	
Diametro Girante	Ø77
N° Alette Girante	6
Distanza Girante	21

### HYUNDAI

#### ACCENT III

1.5 CRDi	02/2011→	D	D3-EA
----------	----------	---	-------

#### ELANTRA I

2.0 CRDi	01/2011→	D	D4EA
----------	----------	---	------

#### GETZ

1.5 CRDi	03/2011→	D	D3-EA
----------	----------	---	-------

#### MATRIX

1.5 CRDi	01/2011→	D	D3-EA
----------	----------	---	-------

#### SANTA Fé I

2.0 CRDi	01/2011→	D	D4EA
----------	----------	---	------

2.0 CRDi 4 ruote motrici	03/2011→06/2011	D	
--------------------------	-----------------	---	--

2.0 CRDi 4x4	01/2011→	D	D4EA
--------------	----------	---	------

2.0 CRDi 4x4	03/2011→	D	D4EA
--------------	----------	---	------

#### TRAJET

20	05/2011→	D	D4EA
----	----------	---	------

2.0 CRDi	01/2011→	D	D4EA
----------	----------	---	------

#### TUCSON

2.0 CRDi	04/2011→	D	D4EA
----------	----------	---	------

Short	Code
-------	------



### Model

Version		Fuel	Motor code
---------	--	------	------------

#### TUCSON

2.0 CRDi 4 ruote motrici	04/2011→	D	D4EA
--------------------------	----------	---	------

#### KIA

#### CARENS II

2.0 CRDi	02/2011→	D	D4EA
----------	----------	---	------

#### CEE'D, Station Wagon, Pro Cee'D

2.0 CRDi	07/2011→	D	D4EA-F
----------	----------	---	--------

#### CERATO I, Station Wagon

2.0 CRDi	04/2011→	D	D4EA
----------	----------	---	------

#### SPORTAGE II

2.0 CRDi	06/2011→	D	D4EA-V
----------	----------	---	--------

2.0 CRDi	05/2011→	D	D4EA
----------	----------	---	------

2.0 CRDi 4WD	06/2011→	D	D4EA-V
--------------	----------	---	--------

2.0 CRDi 4WD	04/2011→	D	D4EA
--------------	----------	---	------

82086	350982086000	<b>NEW</b>	
-------	--------------	------------	--



<b>FLANGIA</b>	
Numero Fori Flangia	3
Dimensione Fori Flangia	M8x1.25
Posizione Flangia	65.3
Diametro Mozzo	Ø22
Diametro Centraggio	Ø25.95
<b>GIRANTE</b>	
Diametro Girante	Ø70
N° Alette Girante	9
Distanza Girante	28.4

### FIAT

#### PALIO, Weekend

1.7 TD	04/1996→01/2011	D	176A3.000
--------	-----------------	---	-----------

1.7 TD ED	07/1997→03/2011	D	176A5.000
-----------	-----------------	---	-----------

1.7 TD HL	01/2011→	D	176A5.000
-----------	----------	---	-----------

#### PUNTO I, Cabrio, Van

1.7 TD	01/1994→09/1999	D	176A5.000
--------	-----------------	---	-----------

1.7 TD	01/1994→09/1999	D	176A3.000
--------	-----------------	---	-----------

60 TD 1.7	09/1996→09/1999	D	176B7.000
-----------	-----------------	---	-----------

#### SIENA

1.7 GL	06/2011→	D	176A3.000
--------	----------	---	-----------

#### STRADA

1.7 TD	06/1999→	D	176A3.000
--------	----------	---	-----------

Short	Code
-------	------



### Model

Version	Fuel	Motor code
---------	------	------------

82087 350982087000 **NEW**

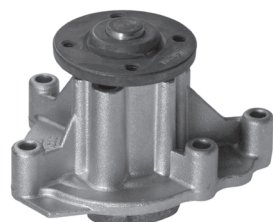

**FLANGIA**  
 Numero Fori Flangia 4  
 Dimensione Fori Flangia M6x1  
 Posizione Flangia 61.45  
 Diametro Mozzo Ø30

**GIRANTE**  
 Diametro Girante Ø58  
 N° Alette Girante 6  
 Distanza Girante 18.5

### MERCEDES-BENZ

#### cl. A I (W168)

A 140	01/2011→04/2011	B	M166.960
A 140	07/1997→04/2011	B	M166.940
A 160	07/1997→04/2011	B	M166.960
A 160 CDI	01/2011→04/2011	D	OM668.940
A 160 CDI	07/1998→01/2011	D	OM668.941
A 170 CDI	01/2011→04/2011	D	OM668.942
A 170 CDI	07/1998→01/2011	D	OM668.940
A 190	03/1999→04/2011	B	M166.990
A 210	02/2011→04/2011	B	M166.995

#### VANEO

16	02/2011→	B	M166.961
16	02/2011→	B	M166.961
1.7 CDI	02/2011→	D	OM668.914
1.7 CDI	02/2011→	D	OM668.914
19	02/2011→	B	M166.991

82088 350982088000 **NEW**

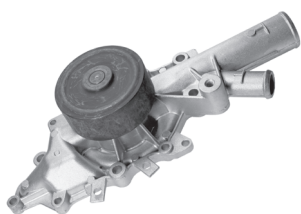

**PULEGGIA**  
 Diametro Puleggia Ø90  
 Altezza Puleggia 34.5  
 Posizione Puleggia 74.4

**GIRANTE**  
 Diametro Girante Ø73.5  
 N° Alette Girante 6  
 Distanza Girante 12.5

### MERCEDES-BENZ

#### cl. C I, Station Wagon (202)

C 200 T CDI	03/1998→01/2011	D	OM611.960
C 220 CDI	09/1997→05/2000	D	OM611.960
C 220 T CDI	09/1997→01/2011	D	OM611.960
C 220 T D	06/1996→01/2011	D	OM604.910
C 250 T Turbo-D	06/1996→01/2011	D	OM605.960

Short	Code
-------	------



### Model

Version	Fuel	Motor code
---------	------	------------

#### cl. C II, Station Wagon, Coupé (203)

C 200 CDI	01/2011→	D	OM646.962
C 200 CDI	01/2011→	D	OM611.962
C 200 CDI	03/2011→	D	OM646.962
C 200 CDI	09/2000→	D	OM611.962
C 220 CDI	04/2011→	D	OM646.963
C 220 CDI	01/2011→	D	OM611.962
C 220 CDI	05/2000→	D	OM611.962
C 270 CDI	01/2011→	D	OM612.962
C 270 CDI	12/2000→	D	OM612.962

#### cl. E II, Station Wagon (210)

E 200 CDI	06/1998→02/2011	D	OM611.961
E 200 CDI	07/1999→02/2011	D	OM611.961
E 220 CDI	06/1998→07/1999	D	OM611.961
E 220 CDI	07/1999→02/2011	D	OM611.961
E 220 T CDI	06/1998→07/1999	D	OM611.961
E 220 T CDI	07/1999→03/2011	D	OM611.961
E 270 CDI	07/1999→02/2011	D	OM612.961
E 270 T CDI	07/1999→03/2011	D	OM612.961

#### cl. M I (163)

ML 270 CDI	12/1999→05/2011	D	OM612.963
------------	-----------------	---	-----------

#### CLK II, Cabrio (209)

270 CDI	02/2011→	D	OM612.962, OM612.967
---------	----------	---	----------------------

82089 350982089000 **NEW**



**PULEGGIA**  
 Diametro Puleggia Ø59.85  
 Numero Denti/Gole Puleggia 20  
 Altezza Puleggia 32.3  
 Posizione Puleggia 62

**GIRANTE**  
 Diametro Girante Ø61.5  
 N° Alette Girante 8  
 Distanza Girante 22.2

### CITROËN

#### C 4 I, Coupé

2.0 16V	04/2011→	B	RFN (EW10J4)
2.0 16V	04/2011→	B	EW10A
2.0 16V	04/2011→	B	EW10J4S

#### C 4 PICASSO, Gran PICASSO

1.8 16V	07/2011→	B	6FY-EW7A
1.8 i 16V	06/2011→	B	6FY-EW7A
2.0 16V	07/2011→	B	RFJ-EW10A
2.0 i 16V	06/2011→	B	RFJ-EW10A

MAGNETI MARELLI			
Short	Code		
<b>Model</b>			
Version		Fuel	Motor code
82089	350982089000	<b>NEW</b>	
<b>CITROËN</b>			
<b>C 5 I, Break</b>			
1.8 16V	01/2011→04/2011	B	6FZ (EW7J4)
2.0 16V	01/2011→04/2011	B	RFN (EW10J4)
2.0 16V HPi	01/2011→04/2011	B	RLZ (EW10D)
<b>C 5 II, Break</b>			
1.8 16V	04/2011→	B	6FZ (EW7J4)
1.8 16V	05/2011→	B	6FY-EW7A
2.0 16V	04/2011→	B	EW10A, RFJ-EW10A
<b>C 5 III, Break</b>			
1.8 16V	08/2011→	B	6FY-EW7A
2.0 16V	08/2011→	B	EW10A
2.0 16V BioFlex	08/2011→	FF	RFJ-EW10A
<b>C 8</b>			
20	02/2011→	B	RFN (EW10J4)
2.0 16V	05/2011→	B	RFJ-EW10A
22	02/2011→	B	3FZ (EW12J4)
<b>EVASION</b>			
2.0 16V	05/2000→02/2011	B	RFN (EW10J4)
<b>JUMPY I</b>			
20	04/2000→06/2011	B	RFN (EW10J4)
2.0 i 16V	03/2000→	B	
<b>JUMPY II</b>			
2.0 i	07/2011→	B	RFH (EW10A)
<b>XSARA, Break, Coupé, PICASSO</b>			
1.8 16V	02/2000→	B	6FZ (EW7J4), LFY (XU7JP4)
1.8 VTS	09/2000→04/2011	B	6FZ (EW7J4)
2.0 16V	09/2000→05/2011	B	RFN (EW10J4)
<b>FIAT</b>			
<b>SCUDO I</b>			
20	05/2000→	B	RFN
2.0 16V	06/2000→	B	RFN
<b>ULYSSE II</b>			
20	02/2011→	B	RFN (EW10J4)
<b>LANCIA</b>			
<b>PHEDRA</b>			
20	02/2011→	B	RFN (EW10J4)
<b>ZETA</b>			
2.0 16V	07/2000→02/2011	B	RFN
<b>PEUGEOT</b>			
<b>206, Station Wagon, CC, Plus</b>			
2.0 16V	02/2011→	B	RFN (EW10J4)
2.0 RC	03/2011→	B	RFK (EW10J4S)
2.0 S16	04/1999→10/2000	B	RFR (DEW10J4)

MAGNETI MARELLI			
Short	Code		
<b>Model</b>			
Version		Fuel	Motor code
<b>206, Station Wagon, CC, Plus</b>			
2.0 S16	09/2000→	B	RFN (EW10J4)
<b>307, Break, CC</b>			
20	02/2011→	B	RFN (EW10J4)
2.0 16V	05/2011→	B	RFJ (EW10A)
2.0 16V	08/2000→	B	RFN (EW10J4)
2.0 16V	03/2011→	B	RFK (EW10J4S)
<b>308, Station Wagon, CC</b>			
2.0 Bioflex	08/2011→	FF	
<b>406, Break, Coupé</b>			
2.0 16V	01/1999→10/2000	B	RFR (DEW10J4)
2.0 16V	08/2000→04/2011	B	RFN (EW10J4)
2.0 16V	11/1995→04/2011	B	RFV (XU10J4R)
2.0 16V HPi	01/2011→04/2011	B	RLZ (EW10D)
22	07/2000→04/2011	B	3FZ (EW12J4)
<b>407, Break, Coupé</b>			
18	04/2011→	B	6FZ (EW7J4)
1.8 16V	05/2011→	B	6FY (EW7A)
20	04/2011→	B	RFN (EW10J4)
2.0 16V	05/2011→	B	RFJ (EW10A)
2.0 Bioflex	08/2011→	FF	
22	04/2011→	B	3FZ (EW12J4)
22	05/2011→	B	3FY (EW12J4)
2.2 16V	05/2011→	B	3FY (EW12J4)
<b>607</b>			
20	02/2000→	B	RFN (EW10J4)
2.2 16V	02/2000→	B	3FZ (EW12J4)
2.2 16V	05/2011→	B	3FY (EW12J4)
<b>806</b>			
2.0 16V	09/2000→02/2011	B	RFN (EW10J4)
<b>807</b>			
20	02/2011→	B	RFN (EW10J4)
2.0 16V	05/2011→	B	RFJ (EW10A)
22	02/2011→	B	3FZ (EW12J4)
<b>EXPERT I</b>			
20	07/2000→	B	RFN (EW10J4)
<b>EXPERT II, Tepee</b>			
2.0 16V	07/2011→	B	RFJ (EW10A)

Short **MAGNETI MARELLI** Code



Model

Version Fuel Motor code

82090 350982090000 **NEW**

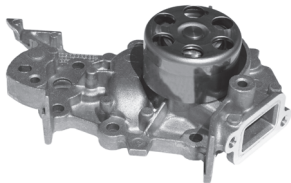

**PULEGGIA**  
 Diametro Puleggia Ø56.2  
 Altezza Puleggia 30.5  
 Posizione Puleggia 56  
**GIRANTE**  
 Diametro Girante Ø60  
 N° Alette Girante 6  
 Distanza Girante 5.4

**RENAULT**

**CLIO II, Van**

1.2 16V 01/2011→ B D4F712, D4F714

**CLIO III, GRANDtour**

1.2 16V 07/2011→ B D4F784

1.2 16V 05/2011→ B D4F764

1.2 16V 05/2011→ B D4F740

1.2 16V 05/2011→ B D4F740

1.2 16V Hi-Flex 08/2011→ FF D4F740

1.2 SL 05/2011→ B D4F764

16V Hi-Flex 08/2011→ FF D4F740

**TWINGO II**

1.2 16V 07/2011→ B D4F772

1.2 Turbo 07/2011→ B D4F780

82091 350982091000 **NEW**

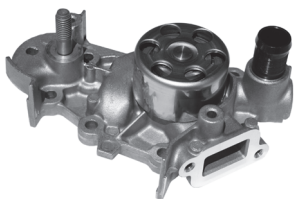

**PULEGGIA**  
 Diametro Puleggia Ø56.2  
 Altezza Puleggia Ø30.3  
 Posizione Puleggia 56  
**GIRANTE**  
 Diametro Girante Ø60  
 N° Alette Girante 6  
 Distanza Girante 4.5

**RENAULT**

**CLIO II, Van**

12 09/1998→ B D7F710, D7F720, D7F726

**CLIO III, GRANDtour**

12 06/2011→ B D7F726

**TWINGO II**

12 07/2011→ B D7F800

Short **MAGNETI MARELLI** Code



Model

Version Fuel Motor code

82092 350982092000 **NEW**

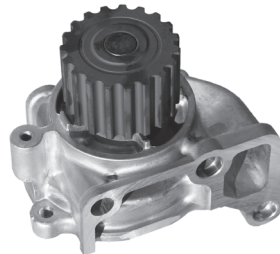

**PULEGGIA**  
 Diametro Puleggia Ø56.4  
 Numero Denti/Gole Puleggia 19  
 Altezza Puleggia 34.8  
 Posizione Puleggia 89.6  
**GIRANTE**  
 Diametro Girante Ø68.8  
 N° Alette Girante 6  
 Distanza Girante 4.5

**MAZDA**

**3 I**

2.0 MZR-CD 06/2011→ D RF7J

**323 F VI**

2.0 TD 01/2011→04/2011 D RF4F

2.0 TD 09/1998→01/2011 D

**323 S VI**

20 10/2000→02/2011 D RF4F

2.0 TD 09/1998→04/2011 D RF3F

**5**

2.0 CD 05/2011→ D

2.0 CD 05/2011→ D RF7J

**6 I, Hatchback, Station Wagon**

2.0 DI 02/2011→ D RF5C

2.0 DI 05/2011→ D RF7J

2.0 DI 02/2011→ D RF5C

**6 II, Hatchback, Station Wagon**

2.0 MRZ-CD 07/2011→ D

**626 V, Station Wagon, Hatchback**

2.0 DITD 04/1998→02/2011 D RF3F

2.0 TD 10/2000→02/2011 D

2.0 Turbo DI 04/1998→02/2011 D RF4F

2.0 Turbo DI 04/1998→02/2011 D

**MPV II**

2.0 DI 02/2011→ D RF5C

**PREMACY**

2.0 TD 07/2000→ D RF4F

2.0 TD 10/1999→07/2000 D RF3F

Short Code



Model

Version		Fuel	Motor code
---------	--	------	------------

82093 350982093000



PULEGGIA	
Diametro Puleggia	Ø102.6
Altezza Puleggia	32.5
Posizione Puleggia	51.6
GIRANTE	
Diametro Girante	Ø62
N° Alette Girante	7
Distanza Girante	23.5

HONDA

ACCORD VIII, Tourer

2.2 i-CTDi	04/2011→	D	N22A1
------------	----------	---	-------

CIVIC VII, Hatchback

2.2 CTDi	06/2011→	D	N22A2
----------	----------	---	-------

CR-V II

2.2 CTDi	05/2011→06/2011	D	N22A2
----------	-----------------	---	-------

CR-V III

2.2 i-CTDi	07/2011→	D	N22A2
------------	----------	---	-------

FR-V

2.2 i CTDi	05/2011→	D	N22A1
------------	----------	---	-------

82094 350982094000

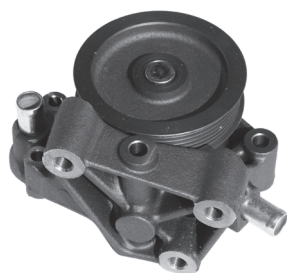

PULEGGIA	
Diametro Puleggia	Ø105.1
Numero Denti/Gole Puleggia	6
Altezza Puleggia	22.8
Posizione Puleggia	83.9
GIRANTE	
Diametro Girante	Ø83
N° Alette Girante	7
Distanza Girante	18.2

CITROËN

JUMPER III

3.0 HDi 160	06/2011→	D	
-------------	----------	---	--

FIAT

DUCATO V

140 Natural Power	09/2011→	D	
-------------------	----------	---	--

140 Natural Power 3,0	09/2011→	M	
-----------------------	----------	---	--

160 Multijet Power 3,0 D	06/2011→	D	F1CE0481D
--------------------------	----------	---	-----------

PEUGEOT

BOXER III

3.0 D	06/2011→	D	
-------	----------	---	--

3.0 HDi	10/2011→	D	
---------	----------	---	--

Short Code



Model

Version		Fuel	Motor code
---------	--	------	------------

BOXER III

3.0 HDi 160	06/2011→	D	
-------------	----------	---	--

3.0 HDi 160	06/2011→	D	
-------------	----------	---	--

82095 350982095000

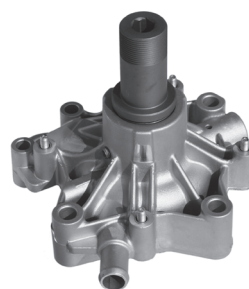

GIRANTE	
Diametro Alberino	M30x1.5
Tipo Filetto Alberino	Maschio
Lunghezza Alberino	144.9
GIRANTE	
Diametro Girante	Ø83.8
N° Alette Girante	7
Distanza Girante	17.2

IVECO

DAILY II

35 C 14	04/2011→06/2011	F1CE0481A
---------	-----------------	-----------

35 C 14, 35 S 14	05/2011→06/2011	F1AE0481M
------------------	-----------------	-----------

35 C 17, 35 S 17	05/2011→06/2011	F1CE0481B
------------------	-----------------	-----------

40 C 14	04/2011→06/2011	F1CE0481A
---------	-----------------	-----------

40 C 17, 40 S 17	05/2011→06/2011	F1CE0481B
------------------	-----------------	-----------

50 C 14	04/2011→06/2011	F1CE0481A
---------	-----------------	-----------

50 C 17	04/2011→06/2011	F1CE0481B
---------	-----------------	-----------

65 C 14	04/2011→06/2011	F1CE0481A
---------	-----------------	-----------

65 C 17	04/2011→06/2011	F1CE0481B
---------	-----------------	-----------

DAILY III

35C15 K, 35C15 DK		F1CE0481FA
-------------------	--	------------

35C15 V, 35C15 V/P		F1CE0481FA
--------------------	--	------------

35C15, 35C15 /P, 35C15 D, 35C15 D/P		F1CE0481FA
-------------------------------------	--	------------

35C18 K, 35C18 DK	06/2011→	F1CE0481HA
-------------------	----------	------------

35C18 V, 35C18 V/P, 35S18 V, 35S18 V/P	06/2011→	F1CE0481HA
--	----------	------------

35C18, 35C18 /P, 35C18 D, 35C18 D/P, 35S18, 35S18 /P	06/2011→	F1CE0481HA
--	----------	------------

40C15 V, 40C15 V/P	06/2011→	F1CE0481FA
--------------------	----------	------------

40C15, 40C15 /P, 40C15 D, 40C15 D/P	06/2011→	F1CE0481FA
-------------------------------------	----------	------------

40C18 V, 40C18 V/P	06/2011→	F1CE0481HA
--------------------	----------	------------



40C18, 40C18 /P, 40C18 D, 40C18 D/P	06/2011→	F1CE0481HA
-------------------------------------	----------	------------



40C18, 40C18 /P, 40C18 D, 40C18 D/P	06/2011→	F1CE0481HA
-------------------------------------	----------	------------

DAILY III

45C15 V, 45C15 V/P	06/2011→	F1CE0481FA
--------------------	----------	------------

45C15, 45C15 /P, 45C15 D, 45C15 D/P	06/2011→	F1CE0481FA
-------------------------------------	----------	------------

MAGNETI MARELLI			
Short	Code		
			
Model			
Version		Fuel	Motor code
<b>82095</b>	<b>350982095000</b>	<b>NEW</b>	
IVECO			
DAILY III			
45C18 V, 45C18 V/P	06/2011→		F1CE0481HA
45C18, 45C18 /P, 45C18 D, 45C18 D/P	06/2011→		F1CE0481HA
50C15 K, 50C15 DK	06/2011→		F1CE0481FA
50C15 V, 50C15 V/P	06/2011→		F1CE0481FA
50C15, 50C15 /P, 50C15 D, 50C15 D/P, 50C15 CCS, 50C15 CCS/P	06/2011→		F1CE0481FA
50C18 K, 50C18 DK	06/2011→		F1CE0481HA
50C18 V, 50C18 V/P	06/2011→		F1CE0481HA
50C18, 50C18 /P, 50C18 D, 50C18 D/P, 50C18 CCS, 50C18 CCS/P	06/2011→		F1CE0481HA
60C15 K, 60C15 KK, 60C15 DK	06/2011→		F1CE0481FA
60C15 V, 60C15 V/P	06/2011→		F1CE0481FA
60C15, 60C15 /P, 60C15 D, 60C15 D/P	06/2011→		F1CE0481FA
60C18, 60C18 V/P	06/2011→		F1CE0481HC
60C18 K, 60C18 KK, 60C18 DK	06/2011→		F1CE0481HC
60C18, 60C18 /P, 60C18 D, 60C18 D/P, 60C18 CCS, 60C18 CCS/P	06/2011→		F1CE0481HC
65C15 V, 65C15 V/P	06/2011→		F1CE0481FA
65C15, 65C15 /P, 65C15 D, 65C15 D/P	06/2011→		F1CE0481FA
65C18 V, 65C18 V/P	06/2011→		F1CE0481HC
65C18, 65C18 /P, 65C18 D, 65C18 D/P, 65C18 CCS, 65C18 CCS/P	06/2011→		F1CE0481HC

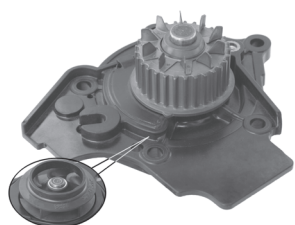
MAGNETI MARELLI			
Short	Code		
			
Model			
Version		Fuel	Motor code
<b>82096</b>	<b>350982096000</b>	<b>NEW</b>	
			
		<b>PULEGGIA</b>	
		Diametro Puleggia	Ø45
		Numero Denti/Gole Puleggia	29
		Altezza Puleggia	18.1
		Posizione Puleggia	32.8
		<b>GIRANTE</b>	
		Diametro Girante	Ø61
		N° Alette Girante	6
		Distanza Girante	18.5
AUDI			
A3 II, Sportback, Cabriolet			
1.8 TFSI	08/2011→	B	BZB
1.8 TFSI quattro	08/2011→	B	CDA
2.0 TFSI	08/2011→	B	CAWB
A4 IV, Avant			
1.8 FSi	08/2011→	B	CDHA
1.8 TFSI	08/2011→	B	CABA
1.8 TFSI	07/2011→	B	CABB
1.8 TFSI quattro	08/2011→	B	CDHB
2.0 TFSI	08/2011→	B	CDNC
2.0 TFSI	08/2011→	B	CDNB
2.0 TFSI flexible fuel	09/2011→	B	CFKA
2.0 TFSI flexible fuel quattro	09/2011→	B	CFKA
2.0 TFSI quattro	08/2011→	B	CDNC
A4 IV, Avant, Allroad			
2.0 TFSI quattro	09/2011→	B	CDNC
2.0 TFSI quattro	09/2011→	B	
A5, Cabriolet			
1.8 TFSI	09/2011→	B	CDHB
1.8 TFSI	07/2011→	B	CABD
2.0 TFSI	08/2011→	B	CDNC
2.0 TFSI	08/2011→	B	CAEA, CDNB
2.0 TFSI quattro	08/2011→	B	CDNC
A5, Cabriolet, Sportback			
1.8 TFSI	09/2011→	B	CDHB
2.0 TFSI	09/2011→	B	CDNB
2.0 TFSI	09/2011→	B	CDNC
2.0 TFSI quattro	09/2011→	B	CDNC
Q5			
2.0 TFSI	09/2011→	B	CDNB
2.0 TFSI	08/2011→	B	CDNC
TT II, Coupé, Roadster			
1.8 TFSI	08/2011→	B	CDA

MAGNETI MARELLI			
Short	Code		
<b>Model</b>			
Version		Fuel	Motor code
82096	350982096000	<b>NEW</b>	
<b>SEAT</b>			
<b>ALTEA, ALTEA XL</b>			
1.8 TFSI	07/2011→	B	BYT
2.0 TFSI 4x4	09/2011→	B	CCZB
<b>EXEO, EXEO ST</b>			
1.8 TSI	10/2011→	B	CDHB
1.8 TSI	10/2011→	B	CDHA
2.0 TFSI	10/2011→	B	CDND
<b>LEON II</b>			
1.8 TSI	07/2011→	B	BZB
2.0 TFSI	09/2011→	B	CCZB
2.0 TFSI	09/2011→	B	CDLA
<b>SKODA</b>			
<b>OCTAVIA II, Station Wagon</b>			
18	07/2011→	B	
1.8 TSI	07/2011→	B	BZB
1.8 TSI 4x4	08/2011→	B	CDAА
<b>SUPERB II, Station Wagon</b>			
1.8 TSI	08/2011→	B	BZB, CDAА
1.8 TSI 4x4	08/2011→	B	CDAА
<b>YETI</b>			
1.8 TSI 4x4	09/2011→	B	CDAА
<b>VOLKSWAGEN</b>			
<b>EOS</b>			
2.0 TSI	09/2011→	B	CCZB
<b>GOLF VI, Variant</b>			
1.8 TSI	09/2011→	B	CDAА
2.0 TSI	09/2011→	B	CCZB
2.0 TSI	09/2011→	B	CBFA, CCTA
<b>PASSAT VI, Variant, CC</b>			
1.8 TSI	07/2011→	B	BZB, CDAА
1.8 TSI	09/2011→	B	CDAB, CGYA
2.0 FSI	07/2011→	B	CCTB
<b>SCIROCCO III</b>			
2.0 TSI	08/2011→	B	CAWB
2.0 TSI	09/2011→	B	CCZB
<b>TIGUAN</b>			
2.0 TFSI	07/2011→	B	CAWB
2.0 TFSI	07/2011→	B	CAWA

MAGNETI MARELLI			
Short	Code		
<b>Model</b>			
Version		Fuel	Motor code
82097	350982097000	<b>NEW</b>	
		<b>FLANGIA</b>	
		Numero Fori Flangia	3
		Dimensione Fori Flangia	M8x1.25
		Diametro Centraggio	Ø30
		Posizione Flangia	76.2
		<b>GIRANTE</b>	
		Diametro Girante	Ø59.5
		N° Alette Girante	7
		Distanza Girante	-1
<b>AUDI</b>			
<b>A1</b>			
1.4 TFSI	10/2011→	B	CAXA
<b>A3 II, Sportback, Cabriolet</b>			
1.4 FSi	08/2011→	B	CAXC
1.4 TFSI	07/2011→	B	CAXC
<b>SEAT</b>			
<b>ALTEA, ALTEA XL</b>			
1.4 TSI	07/2011→	B	CAXC
<b>LEON II</b>			
1.4 TSI	07/2011→	B	CAXC
<b>SKODA</b>			
<b>OCTAVIA II, Station Wagon</b>			
1.4 TSI	08/2011→	B	CAXA
<b>SUPERB II, Station Wagon</b>			
1.4 TSI	08/2011→	B	CAXC
<b>YETI</b>			
1.4 TSI	10/2011→	B	CAXA
<b>VOLKSWAGEN</b>			
<b>EOS</b>			
1.4 TSI	08/2011→	B	CAVD
<b>GOLF V, Plus, Variant</b>			
1.4 TSI	07/2011→	B	CAXA
<b>GOLF VI, Variant</b>			
1.4 TSI	08/2011→	B	CAXA
<b>JETTA III</b>			
1.4 TSI	07/2011→	B	CAXA
<b>PASSAT VI, Variant, CC</b>			
1.4 TSI	07/2011→	B	CAXA
<b>SCIROCCO III</b>			
1.4 TSI	08/2011→	B	CAXA
<b>TIGUAN</b>			
1.4 TSI	10/2011→	B	CAXA



Short **MAGNETI MARELLI** Code



Model

Version		Fuel	Motor code
---------	--	------	------------

82098 350982098000 **NEW**

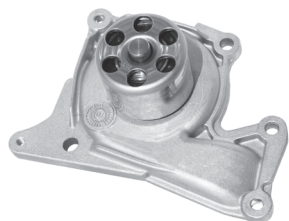

**PULEGGIA**  
 Diametro Puleggia Ø52  
 Altezza Puleggia 33.5  
 Posizione Puleggia 52.3  
**GIRANTE**  
 Diametro Girante Ø67  
 N° Alette Girante 12  
 Distanza Girante 9.5

NISSAN

CUBE

1.5 dCi 10/2011→ D

JUKE

1.5 dCi 10/2011→ D

RENAULT

KANGOO II, BePop

1.5 dCi 09/2011→ D

MEGANE III, Station Wagon, C-C, Scenic

1.5 dCi 09/2011→ D K9K836, K9KJ836

1.5 dCi 08/2011→ D

1.5 dCi 08/2011→ D K9K834, K9KH834

82099 350982099000 **NEW**

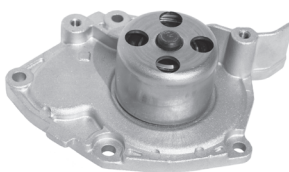

**PULEGGIA**  
 Diametro Puleggia Ø52  
 Altezza Puleggia 33.5  
 Posizione Puleggia 45  
**GIRANTE**  
 Diametro Girante Ø72.5  
 N° Alette Girante 20  
 Distanza Girante 14.7

RENAULT

MEGANE III, Station Wagon, C-C, Scenic

1.9 dCi 08/2011→ D F9Q870, F9Q872

SCENIC III, GRAND SCENIC

1.9 dCi 09/2011→ D F9Q870

Short **MAGNETI MARELLI** Code



Model

Version		Fuel	Motor code
---------	--	------	------------

83000 350983000000 **NEW**



**PULEGGIA**  
 Diametro Puleggia Ø56.2  
 Numero Denti/Gole Puleggia 19  
 Altezza Puleggia 28.6  
 Posizione Puleggia 47.5  
**GIRANTE**  
 Diametro Girante Ø63.8  
 N° Alette Girante 7  
 Distanza Girante 48.1

AUDI

A1

1.6 TDI 10/2011→ D CAYC

A3 II, Sportback, Cabriolèt

1.6 TDI 09/2011→ D CAYB

1.6 TDI 09/2011→ D CAYC

SEAT

ALHAMBRA II

2.0 TDI 10/2011→ D CFFB

2.0 TDI 10/2011→ D CFGB

ALTEA, ALTEA XL

1.6 TDI 09/2011→ D CAYC

1.6 TDI 10/2011→ D CAYB

IBIZA V, SportCoupé, ST

1.2 TDI 10/2011→ D CFWA

1.6 TDI 09/2011→ D CAYB

1.6 TDI 09/2011→ D CAYC, CLNA

2.0 TDI 10/2011→ D CFHD

LEON II

1.6 TDI 10/2011→ D CAYC

1.6 TDI 10/2011→ D CAYB

SKODA

FABIA II, Station Wagon

1.2 TDI 10/2011→ D CFWA

1.6 TDI 10/2011→ D CAYC

1.6 TDI 10/2011→ D CAYB

1.6 TDI 10/2011→ D CAYA

OCTAVIA II, Station Wagon

1.6 TDI 09/2011→ D CAYC

1.6 TDI 4x4 09/2011→ D CAYC

ROOMSTER

1.6 TDI 10/2011→ D CAYB

1.6 TDI 10/2011→ D CAYC

YETI

2.0 TDI 09/2011→ D CFHA

Short **MAGNETI MARELLI** Code



**Model**

Version Fuel Motor code

83000 350983000000 **NEW**

**SKODA**

**YETI**

2.0 TDI 4x4	09/2011→	D	CBDB, CFHC
2.0 TDI 4x4	09/2011→	D	CEGA, CFJA
2.0 TDI 4x4	09/2011→	D	CFHF

**VOLKSWAGEN**

**CADDY III**

1.6 TDI	10/2011→	D	CAYD
1.6 TDI	10/2011→	D	CAYE
2.0 TDI 16V	10/2011→	D	CFHC
2.0 TDI 4motion	10/2011→	D	CFHF

**GOLF V, Plus, Variant**

1.6 TDI	09/2011→	D	CAYB
1.6 TDI	09/2011→	D	CAYC

**GOLF VI, Variant**

1.6 TDI	09/2011→	D	CAYB
1.6 TDI	09/2011→	D	CAYC
1.6 TDI 4motion	09/2011→	D	CAYC

**JETTA III**

1.6 TDI	09/2011→	D	CAYC
---------	----------	---	------

**PASSAT VI, Variant, CC**

1.6 TDI	09/2011→	D	CAYC
---------	----------	---	------

**POLO V**

1.2 TDI	09/2011→	D	CFWA
1.6 TDI	09/2011→	D	CAYA
1.6 TDI	09/2011→	D	CAYB
1.6 TDI	09/2011→	D	CAYC

**TOURAN**

1.6 TDI	10/2011→	D	CAYC
1.6 TDI	10/2011→	D	CAYB

83002 350983002000 **NEW**

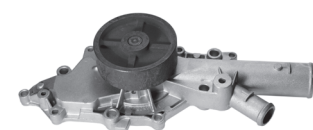

**PULEGGIA**  
 Diametro Puleggia Ø90  
 Altezza Puleggia 30.5  
 Posizione Puleggia 70.9

**GIRANTE**  
 Diametro Girante Ø78  
 N° Alette Girante 8  
 Distanza Girante 13.4

**MERCEDES-BENZ**

**cl. E II, Station Wagon (211)**

E 270 CDI	02/2011→	D	OM647.961
-----------	----------	---	-----------

Short **MAGNETI MARELLI** Code



**Model**

Version Fuel Motor code

**cl. E II, Station Wagon (211)**

E 270 T CDI	03/2011→	D	OM647.961
E 280	05/2011→	B	M272.943
E 280 4-matic	06/2011→	B	M272.943
E 280 CDI	04/2011→	D	OM648.961
E 280 T	05/2011→	B	M272.943
E 280 T 4-matic	05/2011→	B	M272.943
E 280 T CDI	04/2011→	D	OM648.961
E 320 CDI	02/2011→	D	OM648.961
E 320 T CDI	03/2011→	D	OM648.961



***Tavole di comparazione  
Cross reference guide  
Gegenüberstellung  
Table de correspondance  
Tabla de equivalencias  
Tabela de equivalências  
Πίνακας αντιστοιχιών  
Tabela porównawcza  
Кросс-таблица  
Karşılaştırma***





O.E.	MAGNETI MARELLI
------	-----------------

ACURA	
19200P72003	81839
19200P72013	81839
19200P72A01	81839
19200POA003	81708

ALFA ROMEO	
------------	--

105260702400	10526/E
105440702400	10526/E
116460702400	11707
116550702400	11712
119000702400	11707
119000702402	11707
162060702401	11713
162060702402	11713
195150702400	11707
195150702401	11707
195320702402	19532/E
46432248	81352
46515970	81352
46515972	81352
4714636	81334
4754850	81334
4764761	81334
55198358	81355
5896818	81464
5896819	81464
5973319	81443
60513151	19532/E
60533509	11713
60534334	11707
60534335	11707
60534336	11707
60555345	11707
60555347	19532/E
60555348	19532/E
60561800	19532/E
60561806	11713
60562567	81302
60564004	81302
60564048	19532/E
60586222	81331
60604181	81355
60608898	81348
60630271	81355
60668487	81355
60700439	11707
60703264	11707

O.E.	MAGNETI MARELLI
------	-----------------

ALFA ROMEO	
60712573	10526/E
60730469	11712
60778982	81362
60778983	81362
60800169	81443
60808116	19532/E
60808756	81464
60809209	81322
60810426	81322
60811328	81331
60812263	81328
60812263	81363
60813207	81355
60814609	81352
60815559	81352
60816018	81355
7072641	81302
71739401	81812
71739779	82083
71751273	81812
7303009	81334
7629033	81464
7631379	81464
7693570	81326
7693570	81464
7696226	81464
7708187	81322
7747388	81322
99440726	81334

AUDI	
------	--

026121005	81522
026121005A	81522
026121005C	81522
026121005E	81522
026121005F	81526
026121005G	81522
026121005H	81522
026121005K	81526
026121010	82080
026121010A	82001
026121010AV	82001
026121010AX	82001
026121010C	82080
026121010CV	82080
026121010CX	82080
026121010D	82001

O.E.	MAGNETI MARELLI
------	-----------------

AUDI	
026121010DV	82001
026121010DX	82001
026121010E	82080
026121010F	82080
026121010FV	82080
026121010FX	82080
026121010V	82080
026121010X	82080
028121004	81528
028121004V	81528
028121004X	81528
034121004	81683
034121004A	81683
034121004B	81700
034121004V	81683
034121004X	81683
034121005D	81683
036 121 008K	81777
036 121 008L	81777
036121005E	81777
036121005EV	81777
036121005EX	81777
036121005F	81840
036121005G	81840
036121005GX	81840
036121005P	81840
036121005Q	81777
036121005QX	81777
036121005S	81777
036121005SV	81777
036121005SX	81777
036121008G	81840
036121008GX	81840
037121010	82080
037121010A	82080
037121010AV	82080
037121010AX	82080
037121010BX	82080
037121010C	82080
038 121 011JX	81816
038 121 011K	81816
038 121 011KX	81816
038121011	81706
038121011A	81706
038121011AV	81706
038121011AX	81706
038121011C	81816

O.E.	MAGNETI MARELLI
------	-----------------

AUDI	
038121011CX	81816
038121011D	81816
038121011G	81816
038121011GX	81816
038121011H	81816
038121011HX	81816
038121011J	81816
03C 121 005N	82097
03C 121 005NX	82097
03C 121 005R	82097
03C 121 005RX	82097
03C 121 008 B	82097
03C121005S	81777
03L 121 011	83000
03L 121 011G	81816
03L 121 011GX	81816
03L 121 011X	83000
045 121 011HX	81791
045121011	81791
045121011B	81791
045121011F	81791
045121011FX	81791
045121011H	81791
046121004D	81701
046121004DV	81701
046121004DX	81701
050121010	81529
050121010A	81529
050121010AV	81529
050121010AX	81529
050121010C	81529
050121010V	81529
050121010X	81529
052121004	81520
052121004AV	81520
052121004AX	81520
052121004V	81520
052121004X	81520
052121005	81520
052121005A	81520
052121019	81520
054121004	81700
054121004A	81700
054121004AV	81700
054121004AX	81700
054121004V	81700
054121004X	81700

O.E.	MAGNETI MARELLI
------	-----------------

AUDI	
055121010	82001
055121010X	82001
056121005A	81521
056121011	82001
056121013A	82001
059121004B	81705
059121004C	81705
059121004CX	81705
059121004D	81705
059121004E	81705
059121004EV	81705
059121004EX	81705
068121005	81521
068121005A	81522
068121005B	81521
068121005C	81521
068121005X	81521
068121010	82001
068121010A	82080
068121010AX	82080
069121004	81593
069121004V	81593
069121004X	81593
069121005D	81593
06A121011C	81703
06A121011E	81703
06A121011EV	81703
06A121011EX	81703
06A121011F	81703
06A121011G	81703
06A121011H	81703
06A121011HV	81703
06A121011HX	81703
06A121011L	81703
06A121011LV	81703
06A121011LX	81703
06A121011T	81703
06A121011TX	81703
06A121012	81703
06A121012X	81703
06B121011	81702
06B121011A	81702
06B121011B	81702
06B121011BV	81702
06B121011BX	81702
06B121011C	81702
06B121011CV	81702

O.E.	MAGNETI MARELLI
------	-----------------

AUDI	
06B121011CX	81702
06B121011E	81702
06B121011EV	81702
06B121011EX	81702
06B121011H	81702
06B121011L	81702
06B121011LX	81702
06B121011M	81702
06B121011N	81702
06B121011NX	81702
06C121004C	81819
06C121004G	81819
06C121004H	81819
06C121004HX	81819
06H 121 026AB	82096
06H 121 026AF	82096
06H 121 026AG	82096
06H 121 026N	82096
06J 121 026A	82096
06J 121 026F	82096
06J 121 026G	82096
074121004	81701
074121004A	81701
074121004AV	81701
074121004AX	81701
074121004BX	81701
074121004N	81701
074121004NX	81701
074121004V	81701
074121004X	81701
074121005MV	81701
074121005N	81701
077121004M	82081
077121004MX	82081
077121004N	82081
077121004PX	82081
078121004H	81842
078121004HX	81842
078121004J	81842
078121004JV	81842
078121004JX	81842
078121004L	81842
078121004Q	81842
078121004QX	81842
078121004R	81842
078121006	81842
078121006A	81842

<b>O.E.</b>	<b>MAGNETI MARELLI</b>
-------------	------------------------

<b>AUDI</b>	
078121006X	81842
145121011BX	81791

<b>BEDFORD</b>	
----------------	--

1334004	81543
1334008	81606
1334011	81681
1334013	81548
1334014	81605
1334023	81543
1334024	81681
1334025	81549
1334027	81544
1334041	81550
1334045	81546
1334050	81550
1334053	81550
1334070	81543
1334071	81544
1334074	81546
1334084	81548
1334087	81546
1334098	81549
1334119	81550
1334137	81550
3469874	81546
90076952	81543
90091035	81544
90096415	81546
90106656	81548
90108739	81546
90136382	81546
90144227	81549
90183273	81543
90220568	81606
90234200	81681
90272361	81606
90273361	81606
90273924	81548
90284802	81548
90284813	81605
90284913	81605
90295078	81605
90325660	81549
90325661	81681
90349239	81549
90349241	81543

<b>O.E.</b>	<b>MAGNETI MARELLI</b>
-------------	------------------------

<b>BEDFORD</b>	
90409912	81544
90443549	81550
90444311	81550
9192370	81550
96351969	81549
97062796	81546
R1160012	81549
R1160024	81605
R1160032	81550

<b>BMW</b>	
------------	--

11510007039	81589
11511271435	81586
11511271436	81618
11511272613	81618
11511272616	81586
11511284247	81585
11511284694	81618
11511285510	81585
11511286417	81618
11511287367	81618
11511287580	81585
11511312129	81618
11511312539	81618
11511433712	81588
11511433828	81588
11511706564	81586
11511706588	81586
11511706624	81586
11511707190	81618
11511707191	81618
11511707192	81618
11511711492	81586
11511715292	81587
11511719836	81616
11511720292	81618
11511720609	81616
11511720892	81618
11511720893	81618
11511721337	81587
11511721872	81590
11511722536	81588
11511727123	81589
11511727468	81590
11511730414	81588
11511734269	81589
11511734595	81590

<b>O.E.</b>	<b>MAGNETI MARELLI</b>
-------------	------------------------

<b>BMW</b>	
11511734602	81590
11511740241	81588
11511744243	81588
11512241641	81585
11512242176	81617
11512242675	81585
11512242677	81617
11512243003	81597
11512244333	81597
11512245687	81597
11512247552	81793
11512248996	81796
11512354055	81795
11517503884	81588
11517504040	81588
11517527799	81588
11517527910	81588
11517786192	81795
11517786736	81794
11519058996	81586
11519068606	81597
11519069529	81597
11519070759	81616
11519070761	81618
11519070765	81585

<b>BUGATTI</b>	
----------------	--

PA0010	81415
PA0011S	81481
PA0015	81493
PA0018	81434
PA0020	81423
PA0026	81822
PA0035	81443
PA0038	81445
PA0039	81491
PA0040	81999
PA0042	81619
PA0057	81572
PA0071	81554
PA0075	81603
PA0083	81546
PA0091	81543
PA0092	81544
PA0095	81548
PA0099	81549
PA0105	81560





O.E.	MAGNETI MARELLI
------	-----------------

BUGATTI	
PA5115	81705
PA5116	81706
PA5117	81842
PA5117	81842
PA5201	81613
PA5202	81614
PA5203	81615
PA5204	81707
PA5205	81708
PA5206	81709
PA5207	81843
PA5401	81588
PA5402	81589
PA5403	81590
PA5404	81597
PA5413	81796
PA5414	81793
PA5418	81795
PA5418	81795
PA5418	81795
PA5419	81794
PA5501	81642
PA5501	81642
PA5502	81672
PA5504	81556
PA5505	81710
PA5506	81711
PA5507	81844
PA5508	81712
PA5509	81713
PA5510	81799
PA5510	81799
PA5702	81714
PA5704	81715
PA5903	81488
PA5904	81489
PA5907	81315
PA5908	81300
PA5909	81324
PA5911	81325
PA5912	81339
PA5913	81303
PA5914	81365
PA5915	81304
PA5916	81333
PA5918	81327
PA5919	81334

O.E.	MAGNETI MARELLI
------	-----------------

BUGATTI	
PA5919	81334
PA5920	81332
PA5920	81332
PA5921	81335
PA5921	81335
PA5922	81316
PA5922	81316
PA5924	81341
PA5925	81364
PA5926	81329
PA5927	81330
PA5928	81342
PA5929	81372
PA5930	81328
PA5930	81328
PA5930	81328
PA5930	81328
PA5931	81363
PA5932	81346
PA5932	81346
PA5933	81368
PA5933	81368
PA5935	81351
PA5936	81301
PA5937	81343
PA5938	81366
PA5939	81320
PA5940	81318
PA5941	81319
PA5942	81370
PA5943	81369
PA5943	81369
PA5944	81344
PA5945	81801
PA5946	82086
PA6001	81653
PA6002	81654
PA6003	81559
PA6004	81655
PA6005	81656
PA6006	81657
PA6006	81657
PA6007	81658
PA6009	82004
PA6010	81598
PA6011	81716
PA6012	81802

O.E.	MAGNETI MARELLI
------	-----------------

BUGATTI	
PA6013	81803
PA6014	81845
PA6015	81804
PA6016	81805
PA6401	81717
PA6501	81490
PA6701	81718
PA6804	81508
PA6805	81509
PA6808	81499
PA6811	81722
PA6811	81722
PA6814	81723
PA6816	81724
PA6816	81724
PA6818	81725
PA6819	81726
PA6820	82087
PA6820	82087
PA6821	81728
PA6822	81729
PA6823	81730
PA6824	82088
PA6905	81731
PA6908	81733
PA7101	81734
PA7103	81736
PA7107	81740
PA7109	81742
PA7110	81743
PA7111	81744
PA7112	81745
PA7201	81685
PA7202	81550
PA7202	81550
PA7203	81551
PA7204	82005
PA7205	81687
PA7207	81746
PA7208	81747
PA7209	81846
PA7209	81846
PA7210	81748
PA7211	81749
PA7212	81750
PA7213	81751
PA7215	81848

O.E.	MAGNETI MARELLI
<b>BUGATTI</b>	
PA7217	81812
PA7402	81367
PA7404	81513
PA7405	81353
PA7406	81752
PA7407	81753
PA7409	81800
PA7410	81813
PA7410	81813
PA7701	81574
PA7702	81754
PA7703	81666
PA7704	81667
PA7705	81755
PA7707	81851
PA7708	81596
PA7709	81756
PA7710	81757
PA7711	81758
PA7712	81759
PA7713	81760
PA7714	81579
PA7714	81579
PA7715	81578
PA7716	81761
PA7717	81762
PA7718	81806
PA7718	81806
PA7719	81852
PA7721	81811
PA7722	81853
PA7723	81854
PA7724	81855
PA7801	81763
PA7802	81764
PA7902	81497
PA8501	81766
PA8502	81767
PA8503	81768
PA8504	81769
PA8505	81770
PA8506	81771
PA8507	81808
PA8508	81809
PA8701	81772
PA8702	81524
PA8703	81525

O.E.	MAGNETI MARELLI
<b>BUGATTI</b>	
PA8703	81525
PA8704	81527
PA8705	81773
PA8706	81774
PA8707	81775
PA8708	81856
PA8709	81776
PA8710	81777
PA8711	81807
PA8712	81791
PA8712	81791
PA8713	81701
PA8713	81701
PA8802	81857
PA8804	81779
PA9101	81780
PA9102	81781
PA9103	81782
PA9104	81783
PA9201	81784
PA9202	81785
PA9202	81785
PA9203	81786
PA9204	81787
PA9205	81788
PA9301	81789
PA9301	81789
PA9302	81790
PA9303	81858

<b>CHEVROLET</b>	
24409355	81550
92065969	81550
92226211	81550
96518977	81783
96563958	81783
96666219	81783
96872702	81782
96930074	81782

<b>CHRYSLER</b>	
4667660	81733
4720429	81302
4864566	81362
68000693AB	81816

O.E.	MAGNETI MARELLI
<b>CITROËN</b>	
1201.37	81822
1201.82	81753
1201.A2	81753
1201.E1	81799
1201.E1	82089
1201.E5	81753
1201.E7	81799
1201.E7	82089
1201.F4	81799
1201.F4	82089
1201.F5	81799
1201.F5	82089
1201.G4	81799
1201.G4	82089
1201.G5	81799
1201.G5	82089
1201.H4	81753
1201.J1	81799
1201.J1	82089
1201.J2	81799
1201.J2	82089
1201.J4	82094
1201.K0	82094
1201.K1	82089
120134	81367
120140	81367
120150	81512
120152	81642
120154	81353
120155	81353
120158	81513
120161	81512
120163	81554
120165	81642
120167	81642
120169	81572
120170	81752
120191	81642
120193	81711
120195	81368
120196	81346
120198	81710
1201A1	81711
1201A3	81752
1201A4	81642
1201A5	81712
1201A6	81844

O.E.	MAGNETI MARELLI
------	-----------------

### CITROËN

1201A7	81353
1201A8	81642
1201C4	81713
1201C5	81353
1201C6	81353
1201C7	81844
1201C9	81316
1201E0	81353
1201E3	81556
1201E4	81513
1201E8	81800
1201F6	81813
1201F9	81798
1201G0	81797
1201G8	81798
1201H5	81316
120258	81572
120718	81556
120723	81556
120725	81513
20145	81560
5416786	81493
75522430	81493
75530147	81822
7901120258	81572
91511136	81554
9401201340	81367
9401201390	81554
9401201400	81367
9401201480	81672
9451001263	81556
95548541	81822
95575455	81493
95619748	81822
95625017	81512
95641148	81554
95641149	81672
95643824	81672
95650955	81642
95655207	81554
95655208	81512
95655209	81672
95655210	81672
95656566	81554
95656567	81512
95656568	81672
95656569	81672

O.E.	MAGNETI MARELLI
------	-----------------

### CITROËN

95666768	81642
96047088	81353
9608564280	81513
9617376980	81556
97521368	81560

### DACIA

7700861686	81579
7701473327	81810
7701475995	81810
7701476496	81810
8200146298	81579

### DAEWOO

1334008	81606
1334025	81549
1334098	81549
1740050812	81783
1740060D01	81783
1740061810	81783
1740070B00	81783
17400A60D01	81783
17400A60D02	81783
24409355	81550
90106656	81548
90144227	81549
90220568	81606
90272361	81606
90273361	81606
90273924	81548
90284802	81548
90325660	81549
90349239	81549
90443549	81550
90444359	81550
90466343	81550
92064250	81550
92065969	81550
94013802	81780
96182871	81782
96350799	81781
96351284	81780
96351969	81549
96351971	81780
96352648	81781
96352649	81780
96352650	81782

O.E.	MAGNETI MARELLI
------	-----------------

### DAEWOO

R1160012	81549
----------	-------

### DAIHATSU

1610087109	81715
1610087182	81714
1610087183	81715
1610087184	81714
1610087185	81715
1610087390	81714
1610087726	81441
1610087787	81441
1610087796	81441
1610097404	81808
1610097404000	81808
1610097411	81808
1610097411000	81808
16100B09010	81808
16100B9010	81808
16100B9010	81808
554021207	81441

### FIAT

46757573	82086
1304596080	81320
1304612080	81318
1312388080	81318
1313021080	81319
1317462080	81320
1317463080	81318
1317464080	81318
1317466080	81319
195320702402	19532/E
4243672	81415
4243679	81415
4296890	81415
4336009	81434
4458134	81436
46400058	81341
46400058	81364
46407762	81328
46407766	81363
46408312	81489
46409134	81469
46409136	81456
46409200	81368
46409201	81346
46410549	81339

O.E.	MAGNETI MARELLI
<b>FIAT</b>	
46410551	81342
46410551E	81372
46410562	81344
46411355	81341
46411355	81364
46422430	81343
46422430	81366
46422512	81369
46423351	81801
46432248	81352
46437911	81343
46437911	81366
46437912	81303
46437913	81346
46437914	81346
46437915	81343
46437915	81366
46437916	81303
46444355	81341
46444355	81364
46445405	81365
46464225	81344
46515970	81352
46515971	81351
46515972	81352
46520401	81369
46525058	81344
46526243	81370
46531183	81801
46554397	81344
46742168	81300
46757574	82086
46805736	81370
4720031	81423
4755003	81423
4764782	81423
4822231	81445
4823810	81488
4829216	81445
504083122	81316
504102572	82094
504248581	82094
5416786	81493
55184080	81370
55184081	81369
55198358	81355
55198547	81369

O.E.	MAGNETI MARELLI
<b>FIAT</b>	
55204538	81369
5548541	81822
5882691	81434
5882694	81415
5890406	81434
5894394	81360
5896818	81464
5896819	81464
5939200	81415
5973319	81443
5973713	81801
5996594	81482
5999790	81360
60513151	19532/E
60555347	19532/E
60555348	19532/E
60561800	19532/E
60564048	19532/E
60586222	81331
60608898	81348
60800169	81443
60808116	19532/E
60808756	81464
60809209	81322
60810426	81322
60811328	81331
60814609	81352
60816231	81348
71713727	81801
71713728	81369
71716878	81364
71719666	81333
71737974	81333
71739401	81812
71739779	82083
71751273	81812
7301592	81423
7302554	81445
7303050	81423
7533502	81482
75530147	81822
7565764	81482
7574887	81436
7575827	81469
7580754	81482
7580756	81481
7589065	81477

O.E.	MAGNETI MARELLI
<b>FIAT</b>	
7597569	81309
7608844	81456
7609204	81490
7617168	81476
7617364	81458
7626604	81463
7629033	81326
7629033	81464
7629228	81463
7631379	81464
7631494	81309
7635180	81360
7640163	81801
7648451	81328
7651586	81314
7658606	81309
7658607	81309
76611813	81360
7661811	81490
7661813	81360
7671811	81333
7691043	81482
7691046	81476
7691047	81476
7691820	81801
7692285	81309
7692551	81489
7692552	81463
7692555	81363
7693569	81309
7693570	81464
7694229	81360
7695555	81490
7695557	81360
7695559	81490
7696226	81464
7701137	81315
7703893	81327
7708187	81322
7715051	81328
7715242	81801
7719921	81482
7720987	81333
7723345	81476
7724414	81300
7737200	81333
7744397	81333

O.E.	MAGNETI MARELLI
------	-----------------

FIAT	
7747386	81490
7747388	81322
7750698	81303
7752928	81343
7752928	81366
7762924	81340
7762925	81330
7762926	81329
7762986	81301
7770038	81476
777034	81333
7781232	81304
7783006	81315
7784977	81333
7784979	81476
7784981	81482
7784982	81476
7784988	81333
91107589	81490
9401201340	81367
9401201400	81367
9401201480	81672
9463623088	81800
95548541	81822
95619748	81822
95641149	81672
95643824	81672
9565095580	81642
95655209	81672
95655210	81672
9565656788	81512
95656568	81672
95656569	81672
9566945680	81642
9566945688	81642
9567521488	81642
9569147388	81713
9604708880	81353
9627667988	81642
9629110980	81353
9631169188	81797
9640601280	81799
9640601280	82089
9641117180	81813
9654531880	81799
9654531880	82089
9655043180	81799

O.E.	MAGNETI MARELLI
------	-----------------

FIAT	
9655043180	82089
98430541	81324
98435125	81325
98473452	81316
99440717	81316
99440930	81325
99459759	81488
FORD	
1001889	81773
1007714	81598
1020538	81598
1020567	81716
1020988	81651
1023645	81651
1031279	81657
1031879	81522
1032940	81362
1053879	81803
1059843	81773
1079085	81802
1094596	81803
1100635	81816
1104115	81802
1116996	81805
1119276	81804
1119276	81804
1131878	81802
1132607	81598
1138318	81803
1142005	81804
1142427	81804
1143851	81805
1147585	81798
1227902	81803
1232499	81800
1310015	81816
1318354	81656
1326374	81598
1336008	81804
1347102	81805
1350461	81598
1359942	81798
1361486	81804
1364152	81804
1366614	81798
1432630	81800

O.E.	MAGNETI MARELLI
------	-----------------

FORD	
1434347	81804
1517728	81655
1517749	81651
1528548	81532
1535462	81369
1535466	81369
1562255	81800
1612189	81603
1651816	81654
19BBX8591FA	81803
1F1E8501BA	81845
1S7G8501AK	81804
1S7G8501AR	81804
3006897	81845
3715703	81845
3M5Q8591EA	81800
5004972	81532
5004995	81602
5005058	81532
5006043	81602
5006046	81602
5009186	81602
5009286	81532
5009287	81602
5009823	81603
5010875	81532
5010876	81532
5010877	81602
5010878	81602
5010880	81532
5011863	81602
5011864	81532
5012359	81602
5012773	81559
5013267	81532
5013268	81602
5013274	81602
5013320	81538
5019394	81659
5020242	81651
5020437	81650
5020651	81538
5024297	81657
5024545	81559
5024638	81603
5025607	81655
5025908	81650

O.E.	MAGNETI MARELLI
<b>FORD</b>	
5026783	81650
5028472	81656
6065711	81602
6189520	81658
6457409	81654
6683522	81653
6878045	82004
7072641	81302
7087382	81654
7087383	81658
83EF8501AA	81603
88BX8591AA	81650
88FX8591AA	81651
88FX8591AB	81651
88GX8591AA	81659
88WF8501AB	81654
89EX8591AA	81603
914FX8591AA	81559
91FX8591AA	81657
91WM8501AA	81654
91XM8501AA	81658
928X8591AA	81655
92BX8591AA	81653
92BX8591BA	81650
93FX8591AA	81656
95VW8503AA	82080
95VW8591AA	81773
95XM8501A	81658
96BX8591AA	81716
96FX8591AA	81651
96FX8591EA	81657
96MX8591AA	81598
988X8591FA	81803
988X8591FC	81803
A790X8591DA	81532
A790X8591EFA	81532
A840X8591AA	81559
A840X8591ATA	81559
A840X8591AUA	81532
A840X8591BAA	81602
A840X8591BCA	81538
A840X8591KA	81602
EPW20	81559
EPW21	81659
EPW38	81559
EPW40	81651
EPW41	81602

O.E.	MAGNETI MARELLI
<b>FORD</b>	
EPW45	81603
EPW50	81602
EPW51	81602
EPW52	81657
EPW55	81655
EPW60	81653
EPW63	81532
EPW67	81532
EPW68	81602
EPW7	81532
EPW70	81538
EPW71	81650
EPW74	81654
EPW743	81532
EPW746	81532
EPW75	81658
EPW76	82004
EPW79	81656
EPW80	81598
EPW81	81716
EPW82	81651
EPW85	81657
V94DD8501AA	81302
XS2E8501BD	81845
XS2E8501CC	81845
XS4J8591AC	81802
XS7Q8K500AE	81805
<b>GRAF</b>	
PA051	10526/E
PA088	81415
PA1013	82093
PA102	81593
PA1021	81837
PA1026	82094
PA1035	81579
PA1043	81806
PA1045	82089
PA1047	81768
PA105	81503
PA1051	82097
PA1053	81795
PA1054 ???	81795
PA1075 ??	81820
PA1077 ???	81836
PA108	81544
PA1104	81522

O.E.	MAGNETI MARELLI
<b>GRAF</b>	
PA1105	82080
PA113	81828
PA117	81602
PA117	81602
PA117	81602
PA121	81546
PA131	81532
PA134	81503
PA146	81521
PA147	81572
PA148	81520
PA161	81335
PA161	81423
PA165	81493
PA178	81334
PA197	81560
PA235	81548
PA240	81822
PA243	81586
PA247	81576
PA256	81554
PA257	11712
PA270	81585
PA279	81522
PA284	81601
PA286A	81801
PA292	81482
PA293	81443
PA294	81445
PA295	81602
PA295	81602
PA297	81603
PA298	81360
PA300	81452
PA303	81659
PA304	81498
PA305	81441
PA305	81441
PA306	11707
PA312	81594
PA317	81491
PA321	81538
PA323	81559
PA324	81605
PA325	81606
PA326	81682
PA338A	81456

O.E.	MAGNETI MARELLI
------	-----------------

GRAF	
PA340	81469
PA344	81832
PA346	19532/E
PA348	81512
PA353	81660
PA354	81458
PA365	81464
PA369	81616
PA370	81617
PA372	81477
PA374	81612
PA378A	81309
PA380	81618
PA383	81683
PA384	81833
PA390	81587
PA391	81642
PA393	81672
PA397	81360
PA398	81476
PA399	81490
PA401	81650
PA404	81619
PA406	81508
PA409	81680
PA410	81684
PA412	81661
PA413	81621
PA415	81685
PA418	81436
PA420A	81302
PA420A	81302
PA423	81525
PA423	81525
PA424	81772
PA425	81524
PA426	81614
PA427	81615
PA428	81613
PA429A	81654
PA430	81590
PA431	81589
PA432A	81588
PA436	81734
PA440	81653
PA441	81543
PA442	81549

O.E.	MAGNETI MARELLI
------	-----------------

GRAF	
PA443	81681
PA444	81489
PA446	81504
PA448	81506
PA449	81507
PA451	81300
PA452	81324
PA453	11713
PA454	81488
PA491	81513
PA493A	81744
PA495	81509
PA496	81322
PA497	81315
PA498	81335
PA499	81334
PA500	81332
PA501	81655
PA502A	81597
PA503	81325
PA508	81736
PA509	82004
PA513	81755
PA514	81666
PA515	81851
PA516	81754
PA517	81602
PA517	81602
PA527	81664
PA529	81596
PA530	81756
PA531	81574
PA532	81759
PA533	81757
PA534	81758
PA536	81667
PA537	81742
PA540	81740
PA541	82005
PA541A	81817
PA542	81353
PA543	81608
PA544	81367
PA546	82001
PA550	81573
PA551	81718
PA552	81339

O.E.	MAGNETI MARELLI
------	-----------------

GRAF	
PA553	81304
PA554	81481
PA555	81715
PA556	81714
PA559	81434
PA561A	81843
PA562	81707
PA563	81708
PA564	81709
PA571	81687
PA572A	81550
PA572A	81550
PA575	81999
PA577	81551
PA579	82080
PA579	82080
PA580	81722
PA582	81499
PA583	81723
PA584	81724
PA587	81419
PA587	81419
PA588	81658
PA589A	81657
PA589A	81657
PA590	81656
PA591	81700
PA594	81853
PA595	81811
PA597	81854
PA598	81314
PA599	81333
PA601	81303
PA603	81527
PA605A	81328
PA605A	81328
PA607	81316
PA607	81316
PA609	81528
PA610	81724
PA611	81743
PA612	81598
PA615	81330
PA616	81329
PA617	81773
PA618A	81842
PA620	81364



O.E.	MAGNETI MARELLI
------	-----------------

GRAF	
PA621	81331
PA622	81342
PA624	81463
PA626	81366
PA627	81760
PA628	81556
PA629	81341
PA630	81343
PA631	81348
PA632	81762
PA633	81578
PA634	81579
PA636	81764
PA637	81846
PA637	81846
PA638	81763
PA639	81716
PA640	81651
PA641	81711
PA642	81710
PA643	81752
PA645	81320
PA646	81319
PA647	81318
PA653	81844
PA654	81776
PA658	81856
PA661	81722
PA662	81701
PA664	81746
PA665	81750
PA666	81857
PA667	81328
PA667	81328
PA669	81838
PA670	81839
PA670	81839
PA671	81362
PA672	81352
PA672	81362
PA673	81355
PA674	81777
PA675	81705
PA676	81775
PA677	81774
PA678	82087
PA679	81526

O.E.	MAGNETI MARELLI
------	-----------------

GRAF	
PA683	81753
PA684	81712
PA685	81346
PA686	81346
PA687	81725
PA688	81733
PA689	81301
PA690	81351
PA692	81793
PA693	81369
PA694	81781
PA695	81780
PA696	81782
PA697	81784
PA698	81785
PA700	81787
PA702	81786
PA703	81745
PA704	81717
PA706	81726
PA708	81728
PA709	81729
PA710	81730
PA712	81766
PA713	81767
PA715	81770
PA717	81769
PA718	81771
PA721	81852
PA723	81761
PA724A	81806
PA725	81789
PA726	81790
PA727	81751
PA728	81748
PA729	81749
PA730	81747
PA731	81706
PA733	81344
PA736	82087
PA737	81796
PA738	81783
PA739	81370
PA741	81803
PA742	81802
PA746	82084
PA747	81713

O.E.	MAGNETI MARELLI
------	-----------------

GRAF	
PA750	81834
PA751	81835
PA752	82088
PA758	81701
PA759	81794
PA760	81795
PA761	81791
PA762	81816
PA763	81842
PA764	82081
PA765	81840
PA773	81858
PA779	81529
PA780	81788
PA799	81731
PA802	81362
PA803	81855
PA804	81807
PA820	81820
PA821	81810
PA822	81814
PA826	81808
PA829	82085
PA834	81836
PA837	81797
PA839	81805
PA859	81798
PA859	81798
PA860	81861
PA861	81800
PA862	81799
PA863	81799
PA864	81809
PA865	81779
PA866	81369
PA868	81705
PA877 ??	81837
PA878	81816
PA879	81791
PA880	82086
PA881	81819
PA886	81813
PA889	83002
PA890	81821
PA903	81804
PA904	81702
PA904	81702

O.E.	MAGNETI MARELLI
------	-----------------

GRAF	
PA905	81816
PA906	81813
PA909	82082
PA911	81642
PA914	81332
PA940	81818
PA947	81703
PA957	81812
PA959	82083
PA967	82095
PA972	81785
PA973	82092
PA974	81845
PA975	81789
PA977	81810
PA981	82091
PA983	82090

### HONDA

19200P14A00	81709
19200P2A004	81838
19200P2AA01	81838
19200P2AA02	81838
19200P30003	81839
19200P5TG00	81707
19200P72003	81839
19200P72013	81839
19200P72A01	81839
19200PDFE01	81838
19200PH7013	81839
19200PM3000	81613
19200PM3003	81613
19200PM3013	81613
19200PM3014	81613
19200PO1003	81613
19200PO1004	81613
19200POBA01	81708
19200PTO003	81708
19200PTO013	81708
19200-RBD-E01	82093
19200-RSR-E01	82093
19200-RSR-E02	82093

### HYUNDAI

2510027000	82085
2510027900	82085
2510002500	81837

O.E.	MAGNETI MARELLI
------	-----------------

HYUNDAI	
2510002501	81837
2510002502	81837
2510002566	81837
2510021000	81784
2510021010	81784
2510022010	81784
2510022012	81784
2510022650	81784
2510023001	81785
2510023002	81785
25100-23010	81785
2510023011	81785
25100-23511	81785
25100-23513	81785
25100-23530	81785
2510024030	81784
2510024040	81784
2510024060	81784
2510027010	82085
2510032120	81786
2510033111	81786
2510033120	81786
2510033132	81786
25100-42000	81787
2511129000	81642

### INNOCENTI

31402021	81419
38401023	81419
38402024	81419
38406025	81419
39402022	81419
4336009	81434
4384128	81481
46409136	81456
46410562	81344
46437911	81366
46464225	81344
554021207	81441
5882691	81434
5890406	81434
5996594	81482
7533502	81482
7565764	81482
7580754	81482
7580755	81482
7608844	81456

O.E.	MAGNETI MARELLI
------	-----------------

INNOCENTI	
7617168	81476
7651586	81314
7691043	81482
7691046	81476
7691047	81476
7723345	81476
7738267	81476
7748002	81476
7752928	81343
7770038	81476
7770042	81476
7784979	81476
7784981	81482
7784982	81476

### ISUZU

586008905Z	81838
586008940Z	81838
5862023750	81708

### IVECO

4714636	81334
4720031	81423
4754850	81334
4755003	81423
4764761	81334
4764782	81423
500300476	81332
504113544	82095
7301592	81423
7303009	81334
7303050	81423
7303056	81491
98418986	81334
98435994	81335
98437726	81334
98438356	81332
99438900	81332
99440726	81334
99459755	81491

### JAGUAR

C2S18139	81845
C2S40055	81805
C2S43292	81845
C2S43330	81805
C2S48033	81805

O.E.	MAGNETI MARELLI
------	-----------------

JAGUAR	
C2S5120	81845

JEEP	
4864566	81362
4864688	81664
68000693AB	81816
6800693AA	81816

KIA	
2510027900	82085
2510002500	81837
2510002501	81837
2510002502	81837
2510002566	81837
2510023001	81785
2510023002	81785
2510023011	81785
25100-23530	81785
2510027000	82085
2510027010	82085
2510032120	81786
2510033111	81786
2510033120	81786
2510033132	81786

LADA	
21011307010	81999
21011307014	81999
21081307010	81619
2108130701010	81717
4197598	81999
9401201480	81672
95641149	81672
95643824	81672
95655209	81672
95655210	81672
95656568	81672
95656569	81672

LANCIA	
4192732	81415
4243672	81415
4243679	81415
4296890	81415
4336009	81434
4384128	81481
4384129	81415

O.E.	MAGNETI MARELLI
------	-----------------

LANCIA	
4458134	81436
46400058	81341
46400058	81364
46410549	81303
46411355	81341
46411355	81364
46422512	81369
46423351	81801
46432248	81352
46435858	81363
46437912	81303
46437912	81339
46437916	81303
46437916	81339
46444355	81341
46444355	81364
46515970	81352
46515971	81351
46515972	81352
46520401	81369
46526243	81370
46531183	81801
4822231	81445
4829216	81445
55184080	81370
55184081	81369
55198358	81355
55198547	81369
5882691	81434
5882694	81415
5890406	81434
5894394	81360
5896818	81464
5896819	81464
5939200	81415
5973319	81443
5973713	81801
5996594	81482
5999790	81360
60586222	81331
60604181	81355
60630271	81355
60668487	81355
60800169	81443
60808756	81464
60809209	81322
60810426	81322

O.E.	MAGNETI MARELLI
------	-----------------

LANCIA	
60811328	81331
60813207	81355
60814609	81352
60816018	81355
71713727	81801
71713728	81369
71719666	81333
71737974	81333
7302554	81445
7533502	81482
7541664	81452
7565764	81482
7574887	81436
7580754	81482
7609204	81490
7617168	81476
7629033	81326
7629033	81464
7631379	81464
7635180	81360
7640163	81801
7651586	81314
76611813	81360
7661811	81490
7661813	81360
7671811	81333
7691043	81482
7691046	81476
7691047	81476
7691820	81801
7693570	81464
7694229	81360
7695555	81490
7695557	81360
7695559	81490
7696226	81464
7701137	81315
7708187	81322
7710471	81328
7715242	81801
7720987	81333
7723345	81476
7737200	81333
7738267	81476
7744397	81333
7747386	81490
7747388	81322

O.E.	MAGNETI MARELLI
------	-----------------

LANCIA	
7748002	81476
7750698	81339
7762924	81340
7762925	81330
7762926	81329
7770034	81333
7770038	81476
7770042	81476
7783006	81315
7784977	81333
7784979	81476
7784981	81482
7784982	81476
7784987	81333
7784988	81333
91107589	81490
9463623088	81800
9565095580	81642
9566945688	81642
9567521488	81642
9569147388	81713
9604708880	81353
9629110980	81353
9640601280	81799
9640601280	82089
9654531880	81799
9654531880	82089
9655043180	81799
9655043180	82089
98430541	81324
98435125	81325
98456197	81325
99440930	81325

LAND ROVER	
GWP193	81707
GWP347	81707
PEB000050	81795
PEB000050E	81795
PEB102010	81707
PEB102420	81707
PEB102420L	81707
STC2192	81597
STC3342	81597
STC3343E	81597

O.E.	MAGNETI MARELLI
------	-----------------

LOTUS	
GWP333	81615
MAZDA	
1201F9	81798
1201G8	81798
1E0415010	81716
1E0515010	81598
1E0615010	81598
1N0015010	81745
1N0515010	81745
8AB115010	81718
E30115010	81718
E30115010A	81718
E30115010B	81718
E30115010C	81718
E30115010D	81718
E30115010F	81718
E5B615010	81718
L327-15-100A	81804
LF01-15-100	81804
LF01-15-100A	81804
LF94-15-100	81804
LF94-15-100A	81804
RF2A-15-100A	82092
RF2A-15-100B	82092
RF2A-15-100C	82092
RF5C-15-010A	82092
RF5G-15-010B	82092
RF7J-15-010A	82092
RF8G-15-010A	82092
Y401-15-010	81798
Y401-15-010A	81798

MEGA	
120158	81513
1201E3	81556
120723	81556
120725	81513
19109800	81560
32641Q	81560
44854W	81560
49152500	81560
9451001263	81556
9608564280	81513
9617376980	81556

O.E.	MAGNETI MARELLI
------	-----------------

MERCEDES-BENZ	
1662000320	82087
1662000420	82087
1662000520	82087
1662000720	82087
6132000701	82084
6462000301	82082
0002000301	81773
1022000520	81509
1022000620	81509
1022000920	81509
1022001120	81509
1022003901	81509
1022004901	81509
1022005001	81509
1032000701	81507
1032001701	81507
1032002601	81507
1032003701	81507
1042001301	81724
1042002701	81724
1042002801	81722
1042003001	81724
1042003201	81724
1042003301	81722
1042004401	81722
1042004501	81722
1042004601	81724
1042004701	81722
1042004801	81724
1042004901	81722
1102000120	81503
1102000920	81503
1102001720	81503
1112000401	81499
1112002101	81728
1112002201	81774
1112002301	81725
1112002401	81729
1112003901	81729
1112004001	81499
1122000110	81730
1122000123	81730
1122000201	81730
1122000401	81730
1122001101	81730
1122001401	81730
1152000020	81503

O.E.	MAGNETI MARELLI
------	-----------------

MERCEDES-BENZ	
1152001520	81503
1212000920	81503
1662000620	82087
6012000220	81504
6012000720	81504
6012000920	81504
6012001120	81723
6022000020	81506
6022000120	81506
6022000220	81506
6052000120	81726
6052000320	81726
6052000520	81726
6052000820	81726
6112000201	82088
6112001201	82088
6132000901	83002
6162000420	81508
6162000720	81508

MG	
GWP333	81615

MINI	
11511485846	81861
11517510803	81861
11517513062	81861
11517790871	81821
11517829914	81861
11517829922	81861

MITSUBISHI	
M345611	81574
M855991	81574
MD030863	81784
MD050450	81787
MD168048	81787
MD168050	81787
MD179030	81731
MD300799	81731
MD301847	81787
MD306414	81731
MD4667660	81733
MD664616	81787
MD972001	81787
MD972052	81786
MD972456	81731

O.E.	MAGNETI MARELLI
------	-----------------

MITSUBISHI	
MD974649	81784
MD997076	81784
MD997079	81788
MD997080	81788
MD997084	81787
MD997150	81787
MD997151	81787
MD997160	81787
MD997170	81787
MD997417	81786
MD997609	81784
MD997615	81788
MD997618	81787
MD997621	81786
MN980134	81816
MN980266	81816
MW30620725	81814

NISSAN	
2101001B25	81734
2101001B26	81734
2101001B27	81734
2101001B28	81734
210100M300	81744
210100M301	81744
2101019B25	81743
210101F700	81742
2101024B25	81743
2101041B02	81742
2101041B03	81742
2101053J00	81736
2101053J01	81736
2101053Y00	81744
2101053Y01	81744
2101057J00	81745
2101057J01	81745
2101057J02	81745
2101057J03	81745
2101057J25	81745
2101057J26	81745
2101057J27	81745
2101070J00	81736
2101071J00	81744
2101099B00	81742
21010BN700	81810
21010V5500	81740
21010V5525	81740

O.E.	MAGNETI MARELLI
------	-----------------

NISSAN	
21010V5527	81740
21010V5528	81740
21010V5529	81740
21010V5585	81740
21010W4425	81740
7701472182	81814
7701472625	81855
7701474190	81855
8200129206	81855

OPEL	
03469874	81546
1151669	81362
12585226	81812
12591894	81812
1334000	81848
1334004	81543
1334008	81606
1334009	81682
1334011	81681
1334013	81548
1334014	81605
1334016	81684
1334017	81680
1334021	81682
1334023	81543
1334024	81681
1334025	81549
1334027	81544
1334031	81687
1334034	81685
1334038	81680
1334041	81550
1334045	81546
1334046	82005
1334050	81550
1334052	81687
1334053	81550
1334054	81551
1334059	81846
1334065	81549
1334066	82005
1334067	81812
1334070	81543
1334071	81544
1334072	81846
1334073	81836

O.E.	MAGNETI MARELLI
------	-----------------

OPEL	
1334074	81546
1334075	81812
1334077	81817
1334078	81818
1334079	81749
1334082	81795
1334083	81812
1334084	81548
1334087	81546
1334098	81549
1334102	81685
1334105	81687
1334107	81685
1334112	81597
1334114	81748
1334115	81746
1334117	81747
1334118	81747
1334119	81550
1334121	81750
1334123	81362
1334124	81597
1334130	81749
1334131	81846
1334135	81751
1334137	81550
1334139	81550
1334140	81846
1334142	82083
1334143	81836
1334756	81750
24405895	82083
24439798	81812
24461382	81812
24467301	81812
3467874	81546
4401595	81855
4404098	81574
4408028	81814
4409162	81574
4501293	81834
4501294	81835
4506045	81855
4804957	81812
6334002	81812
6334003	81352
6334019	81836

O.E.	MAGNETI MARELLI
------	-----------------

OPEL	
6334039	81818
6334042	81812
6334048	81836
7701479043	81814
90076952	81543
90091035	81544
90096415	81546
90106656	81548
90136382	81546
90144227	81549
90183273	81543
90220568	81606
90234200	81681
90271492	81682
90281612	81680
90284802	81548
90284913	81605
90325660	81549
90325661	81681
90348231	81682
90349239	81549
90349241	81543
90409912	81544
90442207	81680
90443549	81550
90444079	82005
90444123	81551
90444311	81550
90444649	81846
90512535	81597
90540478	81747
90541671	81597
90542606	81749
90543277	81846
90543935	81751
9109595	81855
91159773	81814
9161593	81834
9161594	81835
9192370	81550
9192793	81549
9192797	82005
9194747	81812
9199592	81817
9199595	81818
93170142	81749
93170697	81846

O.E.	MAGNETI MARELLI
------	-----------------

OPEL	
93178602	81812
93182042	81818
93182043	81747
94124093	81684
94341998	81687
94386207	81685
97101319	81685
97101320	81687
97110386	81685
97110387	81687
97114682	81746
97114683	81748
97135548	81750
97167554	81848
97287175	81836
97351178	81836
R1160032	81550

PEUGEOT	
1201.37	81822
1201.82	81753
1201.A2	81753
1201.E1	81799
1201.E1	82089
1201.E5	81753
1201.E7	81799
1201.E7	82089
1201.F4	81799
1201.F4	82089
1201.F5	81799
1201.F5	82089
1201.G4	81799
1201.G4	82089
1201.G5	81799
1201.G5	82089
1201.H4	81753
1201.J1	81799
1201.J1	82089
1201.J2	81799
1201.J2	82089
1201.J4	82094
1201.K0	82094
1201.K1	82089
120134	81367
120135	81603
120136	81822
120139	81554

O.E.	MAGNETI MARELLI
<b>PEUGEOT</b>	
120140	81367
120142	81659
120143	81659
120145	81560
120148	81672
120150	81512
120151	81672
120152	81642
120154	81353
120155	81353
120158	81513
120160	81672
120161	81512
120162	81512
120163	81554
120165	81642
120167	81642
120170	81752
120174	81603
120176	81659
120191	81642
120193	81711
120195	81368
120196	81346
120198	81710
1201A1	81711
1201A3	81752
1201A4	81642
1201A5	81712
1201A6	81844
1201A7	81353
1201A8	81642
1201C4	81713
1201C5	81353
1201C6	81353
1201C7	81844
1201C9	81316
1201E0	81353
1201E3	81556
1201E4	81513
1201E8	81800
1201E9	81813
1201F6	81813
1201F9	81798
1201G0	81797
1201G8	81798
1201H5	81316

O.E.	MAGNETI MARELLI
<b>PEUGEOT</b>	
120258	81572
120434	81572
120718	81556
120723	81556
120725	81513
94012010390	81554
9451001263	81556
96047088	81353
9608564280	81513
9617376980	81556
<b>PUCH</b>	
1032002601	81507
1102000120	81503
1102000920	81503
1102001720	81503
1152000020	81503
1152001520	81503
1212000920	81503
6022000020	81506
6022000220	81506
<b>RENAULT</b>	
210105296R	81806
5001001274	81334
7303056	81491
77 01 478 830	82098
77 01 478 846	82099
7700105176	81806
7700105378	81806
7700106101	81761
7700107845	81761
7700274330	81806
7700736091	81661
7700859931	81760
7700861627	81761
7700861686	81579
7700864596	81762
7700866518	81578
7700871801	81760
7701041348	81762
7701459820	81572
7701460145	81828
7701461006	81828
7701461336	81664
7701461405	81576
7701462145	81573

O.E.	MAGNETI MARELLI
<b>RENAULT</b>	
7701462145	81811
7701462491	81573
7701462491	81811
7701462808	81334
7701462809	81574
7701463014	81660
7701463111	81574
7701463182	81576
7701463377	81573
7701463377	81811
7701463397	81574
7701464030	81608
7701464054	81756
7701464054	81853
7701464736	81574
7701465122	81851
7701465513	81666
7701465643	81755
7701465816	81574
7701466152	81754
7701466419	81573
7701466419	81811
7701466420	81756
7701466420	81853
7701466571	81667
7701466578	81574
7701466778	81757
7701466779	81758
7701466788	81759
7701467153	81596
7701467153	81854
7701467223	81608
7701467278	81325
7701467622	81760
7701467642	81852
7701468342	81334
7701468491	81574
7701470879	81834
7701470880	81835
7701472182	81814
7701472625	81855
7701473327	81810
7701473365	81574
7701473784	81334
7701474190	81855
7701475995	81810
7701476496	81810

O.E.	MAGNETI MARELLI
------	-----------------

**RENAULT**

7701478018	81579
7701478031	81810
7701478923	81820
7701478924	82091
7701633125	81661
7703002053	81762
7703020052	81820
7703602272	81820
7901120258	81572
8200042514	81761
8200042880	81820
8200088663	81762
8200129206	81855
8200146297	81806
8200146298	81579
8200146301	81578
8200233224	81820
8200238333	81820
8200266947	81762
8200266950	81820
8200397732	82090
8200397735	82091
8200428447	81806
8200582675	81806
8200702750	81820
8200702755	82091
8200702762	81820
9637506680	81844
9640344280	81844
9641117180	81813

**ROVER**

12G120	81419
12G1771	81419
GWP101	81419
GWP102	81419
GWP104	81419
GWP105	81419
GWP117	81419
GWP132	81419
GWP134	81419
GWP157	81612
GWP173	81612
GWP183	81612
GWP193	81707
GWP195	81556
GWP2154	81843

O.E.	MAGNETI MARELLI
------	-----------------

**ROVER**

GWP2155	81843
GWP2157	81613
GWP2161	81613
GWP2162	81302
GWP2163	81613
GWP2166	81843
GWP2523	81362
GWP333	81615
GWP336	81614
GWP337	81672
GWP338	81672
GWP341	81556
GWP342	81708
GWP343	81709
GWP345	81708
GWP346	81556
GWP347	81707
PEB102010	81707
PEB102420	81707
PEB102420L	81707

**SAAB**

1334117	81747
1334118	81747
4610176	81621
4610192	81621
4770970	81846
4772711	81747
7501547	81601
7507460	81601
8817900	81601
8817918	81621
8819948	81763
8821944	81846
8822710	81764
8822744	81764
8822793	81764
90540478	81747
9127234	81621
9307893	81601
93181118	81812
9321670	81621
9321688	81763
9321951	81764

O.E.	MAGNETI MARELLI
------	-----------------

**SEAT**

0131121005A	81525
021121004	81773
021121004V	81773
021121004X	81773
026121005	81522
026121005A	81522
026121005C	81522
026121005E	81522
026121005G	81522
026121005H	81522
026121010	82080
026121010C	82080
026121010CV	82080
026121010CX	82080
026121010E	82080
026121010F	82080
026121010FV	82080
026121010FX	82080
026121010V	82080
026121010X	82080
028121004	81528
028121004V	81528
028121004X	81528
030121004A	81524
030121004B	81524
030121005D	81527
030121005H	81524
030121005L	81524
030121005LV	81524
030121005LX	81524
030121005N	81527
030121005NV	81527
030121005NX	81527
030121005S	81775
030121005T	81527
030121005TV	81527
030121005TX	81527
030121008A	81775
030121008AV	81775
030121008AX	81775
030121008C	81775
030121008D	81527
031121004	81525
031121004A	81525
031121004AV	81525
031121004AX	81525
031121004V	81525



O.E.	MAGNETI MARELLI
------	-----------------

SEAT	
031121004X	81525
031121005A	81525
031121005C	81525
031121005CV	81525
031121005CX	81525
036 121 008K	81777
036 121 008L	81777
036121005	81776
036121005D	81776
036121005DX	81776
036121005E	81777
036121005EV	81777
036121005EX	81777
036121005F	81840
036121005G	81840
036121005GX	81840
036121005M	81776
036121005P	81840
036121005Q	81777
036121005QX	81777
036121005S	81777
036121005SV	81777
036121005SX	81777
036121008G	81840
036121008GX	81840
037121010	82080
037121010A	82080
037121010AV	82080
037121010AX	82080
037121010BX	82080
037121010C	82080
038 121 011JX	81816
038 121 011KX	81816
038121011	81706
038121011A	81706
038121011AV	81706
038121011AX	81706
038121011C	81816
038121011CX	81816
038121011D	81816
038121011G	81816
038121011GX	81816
038121011H	81816
038121011HX	81816
03C 121 005N	82097
03C 121 005NX	82097
03C 121 005R	82097

O.E.	MAGNETI MARELLI
------	-----------------

SEAT	
03C 121 005RX	82097
03C 121 008 B	82097
03C121005S	81777
045 121 011HX	81791
045121011	81791
045121011B	81791
045121011F	81791
045121011FX	81791
047121013J	81807
066121011C	81856
066121011CX	81856
066121011D	81856
068121005A	81522
068121010A	82080
068121010AX	82080
06A121011C	81703
06A121011E	81703
06A121011EV	81703
06A121011EX	81703
06A121011F	81703
06A121011G	81703
06A121011H	81703
06A121011HV	81703
06A121011HX	81703
06A121011L	81703
06A121011LV	81703
06A121011LX	81703
06A121011T	81703
06A121011TX	81703
06B121011	81702
06B121011A	81702
06B121011B	81702
06B121011BV	81702
06B121011BX	81702
06B121011C	81702
06B121011CV	81702
06B121011CX	81702
06B121011E	81702
06B121011EV	81702
06B121011EX	81702
06B121011H	81702
06B121011L	81702
06B121011LX	81702
06B121011M	81702
06B121011N	81702
06B121011NX	81702
06H 121 026AF	82096

O.E.	MAGNETI MARELLI
------	-----------------

SEAT	
071121005	81856
4720031	81423
4755003	81423
4764782	81423
7301592	81423
7303050	81423
HB03200000	81415
SE020032000A	81415
SE021032000A	81498
SE700032000C	81497

SIL	
-----	--

PA1001	81712
PA1002	81701
PA1036	81768
PA1048A	81816
PA1048A	81816
PA1048A	81816
PA1049	81791
PA1051A	82081
PA1054	81713
PA1055A	81799
PA1057	81834
PA1058	81642
PA1059	81837
PA1060	81840
PA1069	81842
PA1070	81796
PA1071	81794
PA1072	81795
PA1072	81795
PA1073	81783
PA1075	81838
PA1076	81839
PA1078	81785
PA1087	82084
PA1116	81302
PA1117	81362
PA1118	11713
PA1121	81861
PA1126	81362
PA1126	81362
PA1128	81835
PA1130	81820
PA1131	81810
PA1132	81814
PA1134	81836

O.E.	MAGNETI MARELLI
------	-----------------

SIL	
PA1134A	81836
PA1135	81805
PA1136	81798
PA1136AL	81798
PA1138	81804
PA1160	81808
PA1161	81809
PA1216	81817
PA1217	81818
PA1218	82086
PA1221	81666
PA1224	81855
PA1234	81797
PA1235	81800
PA1236	81813
PA1236	81813
PA1247	81550
PA1251	81812
PA1259	82083
PA1262	81819
PA1264	82082
PA1265	83002
PA1270A	81702
PA1272	81821
PA1281A	81799
PA129P	10526/E
PA1302	81839
PA1305	81785
PA1307	82085
PA1322	81771
PA1354	81791
PA1360	81733
PA1370	81369
PA1378	81302
PA1395	81810
PA1404	82090
PA1442	81316
PA1445	82097
PA1463	82091
PA1473	82098
PA1495	82099
PA201	81419
PA201AC	81419
PA206P	81415
PA215	81532
PA229P	81572
PA231	81999

O.E.	MAGNETI MARELLI
------	-----------------

SIL	
PA234P	81481
PA236	81521
PA238	81503
PA238S	81503
PA259	81560
PA278P	81520
PA280	81660
PA288S	81434
PA297P	81493
PA347P	81546
PA355	81544
PA356	81334
PA358P	81543
PA364	81828
PA373	81602
PA378	81846
PA380P	81593
PA382	81586
PA386	81618
PA397	81664
PA413	81576
PA419	81603
PA427P	81548
PA429P	81554
PA434	81602
PA437P	81549
PA445P	81822
PA450P	11712
PA456	81718
PA460	81522
PA463P	11707
PA464P	81573
PA465	81504
PA467A	81801
PA469	81601
PA470	81423
PA471P	81612
PA472	81443
PA473	81594
PA483	81659
PA484P	81498
PA485	81452
PA487P	81482
PA488P	81538
PA493	81506
PA495	81559
PA497	81608

O.E.	MAGNETI MARELLI
------	-----------------

SIL	
PA498	81602
PA498	81602
PA498	81602
PA498E	81602
PA498E	81602
PA500	81441
PA507	81436
PA511P	81556
PA512P	81606
PA513P	81672
PA516P	81734
PA518P	81619
PA519	82001
PA521	82080
PA521S	82080
PA524P	81605
PA525P	81458
PA527P	81681
PA534P	81476
PA547	81463
PA552P	81464
PA557A	81574
PA561	81509
PA562	81616
PA563	81754
PA564	19532/E
PA570	81456
PA571	81585
PA575P	81682
PA576	81491
PA584	81367
PA588P	81445
PA589P	81525
PA590P	81651
PA591	81360
PA591	81360
PA595	81508
PA599	81650
PA607	81469
PA609	81740
PA610	81507
PA611A	81661
PA615	81621
PA616	81617
PA619P	81683
PA620P	81833
PA624P	81680

<b>O.E.</b>	<b>MAGNETI MARELLI</b>
-------------	------------------------

<b>SIL</b>	
PA631	81477
PA636	81755
PA637	81328
PA637	81328
PA639P	81309
PA641	81851
PA645P	81756
PA645P	81853
PA646	81587
PA648P	81512
PA649P	81642
PA650	81763
PA653	81654
PA655P	81524
PA656	81684
PA657	81685
PA658	81590
PA659	81588
PA660	81589
PA663P	81772
PA664P	81700
PA667	81653
PA669	81655
PA670P	81353
PA675	81687
PA681P	81613
PA682P	81614
PA683P	81615
PA684	81744
PA685	81736
PA688	81490
PA690	81489
PA691P	81525
PA693P	81300
PA703P	81324
PA706	81315
PA707P	82005
PA708A	81550
PA709P	81551
PA710	81322
PA711P	81811
PA712	82004
PA713	81667
PA714	81597
PA715	81499
PA716	81722
PA717	81742

<b>O.E.</b>	<b>MAGNETI MARELLI</b>
-------------	------------------------

<b>SIL</b>	
PA719P	81333
PA720P	81513
PA721P	81854
PA722P	81852
PA723P	81314
PA724P	81656
PA725	81658
PA731P	81303
PA732P	81339
PA733	81304
PA736P	81657
PA738P	81709
PA739P	81329
PA745	81325
PA748	81723
PA751	81707
PA752	81759
PA753	81757
PA754	81758
PA762A	81842
PA764	81365
PA766	81488
PA775	81784
PA776	81787
PA778	81788
PA782	81786
PA789	81789
PA797	81770
PA801	81858
PA802	81790
PA803	81714
PA816	81596
PA822	81815
PA825	81341
PA826	81364
PA827	81342
PA828	81528
PA829	81529
PA830	81579
PA831	81578
PA833	81316
PA834	81320
PA835	81724
PA837	81724
PA839	81722
PA840	81526
PA843	81334

<b>O.E.</b>	<b>MAGNETI MARELLI</b>
-------------	------------------------

<b>SIL</b>	
PA844	81332
PA844	81332
PA845	81335
PA845	81335
PA846	81527
PA847	81773
PA848	81598
PA852	81351
PA853	81344
PA854	81343
PA855	81366
PA856	81346
PA857	81368
PA858	81346
PA859	81368
PA860	81348
PA861	81331
PA864A	81703
PA866A	81702
PA867	81856
PA869	81752
PA870	81844
PA871	81780
PA873	81301
PA874	81328
PA874	81328
PA875	81363
PA877	81657
PA878	81845
PA879	81716
PA880	81760
PA881	81764
PA883	81705
PA883	81705
PA884	81774
PA885	81711
PA886	81710
PA887	81846
PA890	81746
PA891	81747
PA896	81789
PA898	81441
PA908	81708
PA913	81369
PA919	81318
PA920	81319
PA921	81743

O.E.	MAGNETI MARELLI
------	-----------------

SIL	
PA922	81330
PA922	81352
PA923	81355
PA928	81782
PA931	82087
PA931	82087
PA932	81725
PA934A	81730
PA935	81749
PA936	81751
PA937	81748
PA938	81753
PA939	81762
PA941	81775
PA944	81706
PA945	81777
PA946	81776
PA948	81745
PA949	81802
PA950	81803
PA951	81726
PA952	82088
PA953	81728
PA957	81781
PA958	81715
PA965	81793
PA967	81729
PA969	81761
PA970	81806
PA970S	81806
PA980	81779
PA982	81807
PA983A	81370
PA988	81701
PA993	81731

SKODA	
028121004	81528
028121004V	81528
028121004X	81528
030121005D	81527
030121005N	81527
030121005NV	81527
030121005NX	81527
036 121 008K	81777
036 121 008L	81777
036121005E	81777

O.E.	MAGNETI MARELLI
------	-----------------

SKODA	
036121005EV	81777
036121005EX	81777
036121005Q	81777
036121005QX	81777
036121005S	81777
036121005SV	81777
036121005SX	81777
038 121 011JX	81816
038 121 011KX	81816
038121011	81706
038121011A	81706
038121011AV	81706
038121011AX	81706
038121011C	81816
038121011CX	81816
038121011D	81816
038121011G	81816
038121011GX	81816
038121011H	81816
038121011HX	81816
038121011J	81816
03L 121 011G	81816
03L 121 011GX	81816
045 121 011HX	81791
045121011	81791
045121011B	81791
045121011F	81791
045121011FX	81791
045121011H	81791
059121004B	81705
059121004C	81705
059121004CX	81705
059121004D	81705
059121004E	81705
059121004EV	81705
059121004EX	81705
06A121011C	81703
06A121011E	81703
06A121011EV	81703
06A121011EX	81703
06A121011F	81703
06A121011G	81703
06A121011H	81703
06A121011HV	81703
06A121011HX	81703
06A121011L	81703
06A121011LV	81703

O.E.	MAGNETI MARELLI
------	-----------------

SKODA	
06A121011LX	81703
06A121011T	81703
06A121011TX	81703
06B121011	81702
06B121011A	81702
06B121011B	81702
06B121011BV	81702
06B121011BX	81702
06B121011C	81702
06B121011CV	81702
06B121011CX	81702
06B121011E	81702
06B121011EV	81702
06B121011EX	81702
06B121011H	81702
06B121011L	81702
06B121011LX	81702
06B121011M	81702
06B121011N	81702
06B121011NX	81702
06H 121 026AB	82096
06H 121 026AF	82096
06H 121 026AG	82096
06H 121 026N	82096
06J 121 026A	82096
06J 121 026F	82096
06J 121 026G	82096
078121004H	81842
078121004HX	81842
078121004J	81842
078121004JV	81842
078121004JX	81842
078121004L	81842
078121004Q	81842
078121004QX	81842
078121004R	81842
078121006	81842
078121006A	81842
078121006X	81842
145121011BX	81791

SSANGYONG	
1042001301	81724
1042002701	81724
1042003001	81724
1042003201	81724
1042004601	81724

O.E.	MAGNETI MARELLI
------	-----------------

SSANGYONG	
1042004801	81724
6022000220	81506

SUBARU	
1740082850	81858

SUZUKI	
1740050812	81783
1740060810	81790
1740060811	81790
1740060812	81790
1740060813	81790
1740060814	81790
1740060815	81790
1740060D01	81783
1740061810	81783
1740070B00	81783
1740073J00	81798
1740079J50	81352
1740082810	81789
1740082811	81789
1740082812	81789
1740082823	81858
1740082830	81789
1740082850	81858
1740082851	81858
1740083810	81789
1740083811	81789
1740083812	81789
1740083814	81789
1740083815	81789
1740083820	81789
17400A60D01	81783
17400A60D02	81783
1740973J00	81798
1741066G00	81642

TALBOT	
120139	81554
120145	81560
120163	81554
120169	81572
120258	81572
120434	81572
19109800	81560
32641Q	81560
44854W	81560

O.E.	MAGNETI MARELLI
------	-----------------

TALBOT	
49152500	81560
7901120258	81572
94012010390	81554

TOYOTA	
1610009020	81767
1610009050	81767
1610009051	81766
1610009051	81815
1610009060	81768
1610009061	81768
1610009120	81766
1610009120	81815
1610019105	81771
1610019106	81771
1610019195	81771
1610019225	81771
1610019226	81771
1610019255	81766
1610019255	81815
1610019265	81769
1610019295	81766
1610019295	81815
1610019296	81766
1610019296	81815
1610019305	81769
1610029115	81808
1610029155	81809
1610029195	81809
1610039395	81821
1611009020	81815
1611009021	81815
1611019107	81771
1611019146	81815
1611019185	81769
1611019205	81815
1611079025	81770
1611079026	81770
1611079045	81770
1611079135	81770
SU00100596	81798

VAUXHALL	
12585226	81812
12591894	81812
133400	81848
1334014	81605

O.E.	MAGNETI MARELLI
------	-----------------

VAUXHALL	
1334025	81549
1334041	81550
1334045	81546
1334050	81550
1334053	81550
1334065	81549
1334073	81836
1334074	81546
1334077	81817
1334078	81818
1334087	81546
1334098	81549
1334101	81597
1334117	81747
1334118	81747
1334119	81550
1334135	81751
1334137	81550
1334143	81836
24405895	82083
24439798	81812
24461382	81812
3469874	81546
4408028	81814
6334019	81836
6334039	81818
6334048	81836
7701479043	81814
90076952	81543
90091035	81544
90096415	81546
90106656	81548
90108739	81546
90136382	81546
90144227	81549
90183273	81543
90220568	81606
90234200	81681
90271492	81682
90272361	81606
90273923	81681
90273924	81548
90281612	81680
90284802	81548
90284813	81605
90284913	81605
90295078	81605

O.E.	MAGNETI MARELLI
------	-----------------

VAUXHALL	
90325660	81549
90325661	81681
90348231	81682
90349239	81549
90349241	81543
90409912	81544
90442207	81680
90443549	81550
90444079	82005
90444123	81551
90444311	81550
90444649	81846
90512535	81597
90540478	81747
90541671	81597
90542606	81749
90543277	81846
90543935	81751
9109595	81855
9112098	81574
91151669	81362
91159773	81814
9161593	81834
9161594	81835
9192370	81550
9192793	81549
9192797	82005
9194747	81812
9199592	81817
9199595	81818
9201182	81846
9201450	81855
93170401	81812
93170697	81846
93172718	81812
93178602	81812
93182042	81818
93182043	81747
94124093	81684
94341998	81687
94386207	81685
96351969	81549
97062796	81546
97101319	81685
97101320	81687
97110386	81685
97110387	81687

O.E.	MAGNETI MARELLI
------	-----------------

VAUXHALL	
97114682	81746
97114683	81748
97135548	81750
97167554	81848
97251178	81836
97287175	81836
R1160012	81549
R1160018	81606
R1160024	81605
R1160025	81685
R1160027	81682
R1160028	81687
R1160030	82005
R1160031	81551
R1160032	81550
R1160034	81680
R1160036	81746
R1160037	81685
R1160038	81748
R1160039	81750
R1160043	81846
R1160044	81362
VOLVO	
12571857	81593
1326342	81594
270559	81594
271275	81594
2716132	81593
2717684	81701
271830	81594
271975	81594
2719847	81857
272334	81779
274155	81701
30620725	81814
30731312	81804
30735758	81598
30757405	81804
30777590	81804
30788221	81800
30855991	81574
31219176	81598
3242084	81574
32877516	81574
33430935	81574
33442518	81574

O.E.	MAGNETI MARELLI
------	-----------------

VOLVO	
33448275	81574
3344831	81574
3345626	81574
8653806	81800
8694759	81804
VW	
00A121010	81774
0131121005A	81525
021121004	81773
021121004A	81773
021121004V	81773
021121004X	81773
023121004	81772
023121004V	81772
023121004X	81772
025121010C	81832
025121010CV	81832
025121010CX	81832
026121005	81522
026121005	82080
026121005A	81522
026121005A	82080
026121005C	81522
026121005C	82080
026121005E	81522
026121005E	82080
026121005F	81526
026121005G	81522
026121005G	82080
026121005H	81522
026121005H	82080
026121005K	81526
026121010	82080
026121010A	82001
026121010AV	82001
026121010C	82080
026121010CV	82080
026121010CX	82080
026121010D	82001
026121010DV	82001
026121010DX	82001
026121010E	82080
026121010F	82080
026121010FV	82080
026121010FX	82080
026121010V	82080

O.E.	MAGNETI MARELLI
<b>VW</b>	
026121010X	82080
028121004	81528
028121004V	81528
028121004X	81528
030121004A	81524
030121004B	81524
030121005D	81527
030121005H	81524
030121005L	81524
030121005LV	81524
030121005LX	81524
030121005N	81527
030121005NV	81527
030121005NX	81527
030121005S	81775
030121008A	81775
030121008AV	81775
030121008AX	81775
030121008C	81775
031121004	81525
031121004A	81525
031121004AV	81525
031121004AX	81525
031121004V	81525
031121004X	81525
031121005A	81525
031121005C	81525
031121005CV	81525
031121005CX	81525
036 121 008K	81777
036 121 008L	81777
036121005	81776
036121005B	81777
036121005D	81776
036121005DX	81776
036121005E	81777
036121005EV	81777
036121005EX	81777
036121005F	81840
036121005G	81840
036121005GX	81840
036121005M	81776
036121005P	81840
036121005Q	81777
036121005QX	81777
036121005R	81777
036121005S	81777

O.E.	MAGNETI MARELLI
<b>VW</b>	
036121005SV	81777
036121005SX	81777
036121008G	81840
036121008GX	81840
037121010	82080
037121010A	82080
037121010AV	82080
037121010AX	82080
037121010BX	82080
037121010C	82080
038 121 011JX	81816
038 121 011K	81816
038 121 011KX	81816
038121011	81706
038121011A	81706
038121011AV	81706
038121011AX	81706
038121011C	81816
038121011CX	81816
038121011D	81816
038121011G	81816
038121011GX	81816
038121011H	81816
038121011HX	81816
038121011J	81816
03C 121 005N	82097
03C 121 005NX	82097
03C 121 005R	82097
03C 121 005RX	82097
03C 121 008 B	82097
03C121005S	81777
03G121011	81816
03G121011X	81816
03L 121 011	83000
03L 121 011G	81816
03L 121 011GX	81816
03L 121 011X	83000
03L121011B	81816
045 121 011HX	81791
045121011	81791
045121011B	81791
045121011F	81791
045121011FX	81791
045121011H	81791
046121004D	81701
046121004DV	81701
046121004DX	81701

O.E.	MAGNETI MARELLI
<b>VW</b>	
047121013J	81807
050121010	81529
050121010A	81529
050121010AV	81529
050121010AX	81529
050121010C	81529
050121010V	81529
050121010X	81529
052121004	81520
052121004AV	81520
052121004AX	81520
052121004V	81520
052121004X	81520
052121005	81520
052121005A	81520
052121019	81520
055121010	82001
055121010X	82001
056121005	81521
056121005A	81521
056121011	82001
056121013A	82001
059121004B	81705
059121004C	81705
059121004CX	81705
059121004D	81705
059121004E	81705
059121004EV	81705
059121004EX	81705
066121011C	81856
066121011CX	81856
066121011D	81856
068121005	81521
068121005A	81522
068121005A	82080
068121005B	81521
068121005C	81521
068121010	82001
068121010A	82080
068121010AX	82080
069121004	81593
069121004V	81593
069121004X	81593
069121005D	81593
06A121011C	81703
06A121011E	81703
06A121011EV	81703



<b>VW</b>	
06A121011EX	81703
06A121011F	81703
06A121011G	81703
06A121011H	81703
06A121011HV	81703
06A121011HX	81703
06A121011L	81703
06A121011LV	81703
06A121011LX	81703
06A121011T	81703
06A121011TX	81703
06A121012	81703
06A121012X	81703
06B121011	81702
06B121011A	81702
06B121011B	81702
06B121011BV	81702
06B121011BX	81702
06B121011C	81702
06B121011CV	81702
06B121011CX	81702
06B121011E	81702
06B121011EV	81702
06B121011EX	81702
06B121011H	81702
06B121011L	81702
06B121011LX	81702
06B121011M	81702
06B121011N	81702
06B121011NX	81702
06H 121 026AB	82096
06H 121 026AF	82096
06H 121 026AG	82096
06H 121 026N	82096
06J 121 026A	82096
06J 121 026F	82096
06J 121 026G	82096
071121005	81856
073121004	81833
073121004V	81833
073121004X	81833
073121005	81833
074121004	81701
074121004A	81701
074121004AV	81701
074121004AX	81701
074121004BX	81701



<b>VW</b>	
074121004N	81701
074121004NX	81701
074121004V	81701
074121004X	81701
074121005MV	81701
074121005N	81701
077121004M	82081
077121004MX	82081
077121004N	82081
077121004PX	82081
078121004H	81842
078121004HX	81842
078121004J	81842
078121004JV	81842
078121004JX	81842
078121004L	81842
078121004Q	81842
078121004QX	81842
078121004R	81842
078121006	81842
078121006A	81842
078121006X	81842

<b>YUGO</b>	
4384128	81481
7580756	81481





