



Sterzo e sospensioni
Steering and suspension parts
Lenkungs und Aufhängungsteile
Pièces de direction et de suspension
Direction & suspension
Direcção & suspensão
Τιμονι Και Εξαρτηματα Αναρτησης
Elementy układu kierowniczego i zawieszenia
Детали подвески и рулевого управления
Direksiyon ve süspansiyon parçaları



Indice
Contents
Inhaltsverzeichnis
Sommaire
Índice
Índice
Περιεχόμενα
Spis treści
Содержание
Índeks

Legenda
Legend
Legende
Légende
Leyenda
Legenda
Υπόμνημα
Legenda
Легенда
Semboller

4

Codici Magneti Marelli
Magnet Marelli references
Magnet Marelli Nr.
Références Magneti Marelli
Códigos Magneti Marelli
Códigos Magneti Marelli
Κωδικοί Magneti Marelli
Kody Magneti Marelli
Коды Магнети Марелли
Magnet Marelli kodları



7



Applicazione per codice
Buyers guide
Zuordnung nach Bestellnummer
Affectations par références
Aplicación por código
Aplicação por código
Εφαρμογες ανα κωδικο
Zastosowanie dla kodu
Применение для кода
Koda göre araç uygulaması



33

Applicazione per marca e veicolo
Vehicle application guide
Zuordnung nach Marke und Fahrzeug
Affectations par marques et véhicules
Aplicación por marca y vehículo
Aplicação por marca e veículo
Εφαρμογη ανα μοντελο
Zastosowanie dla marki i pojazdu
Применение по марке и модели
Marka ve otomobile göre uygulama



333

Tavole di comparazione
Cross reference guide
Gegenüberstellung Cross-Referenzen
Table de correspondance
Tabla de equivalencias
Tabelas de equivalências
Πίνακας αντιστοιχιών
Tabela porównawcza
Таблица взаимозаменяемости
Çapraz referans tablosu



1423

Tavole di comparazione
Cross reference guide
Gegenüberstellung Cross-Referenzen
Table de correspondance
Tabla de equivalencias
Tabelas de equivalências
Πίνακας αντιστοιχιών
Tabela porównawcza
Таблица взаимозаменяемости
Çapraz referans tablosu



1467

Tavole di comparazione
 Cross reference guide
 Gegenüberstellung Cross-Referenzen
 Table de correspondance
 Tabla de equivalencias
 Tabelas de equivalências
 Πίνακας αντιστοιχιών
 Tabela porównawcza
 Таблица взаимозаменяемости
 Çapraz referans tablosu



Tavole di comparazione
 Cross reference guide
 Gegenüberstellung Cross-Referenzen
 Table de correspondance
 Tabla de equivalencias
 Tabelas de equivalências
 Πίνακας αντιστοιχιών
 Tabela porównawcza
 Таблица взаимозаменяемости
 Çapraz referans tablosu



Dizionario
 Dictionary
 Wörterbuch
 Dictionnaire
 Diccionario
 Dicionário
 Λεξικό
 Słownik
 Словарь
 Sözlük





Legenda
Legend
Legende
Légende
Leyenda
Legenda
Υπόμνημα
Legenda
Легенда
Semboller

Costruttore e modello
Make and model
Hersteller und Modell
Marque et modèle
Constructor y modelo
Montadora e modelo
Μάρκα και μοντέλο
Marka i model
Марка и модель
Üretici ve model

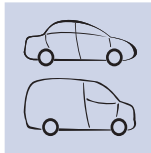

Anno di produzione
Manufacturing year
Baujahr
Année de production
Año de fabricación
Ano de fabricação
Ετος παραγωγής
Rok produkcji
Год выпуска автомобиля
Üretim yılı



Codici Magneti Marelli
Magneti Marelli references
Magneti Marelli Nr.
Références Magneti Marelli
Códigos Magneti Marelli
Códigos Magneti Marelli
Κωδικοί Magneti Marelli
Kody Magneti Marelli
Коды Магнети Марелли
Magneti Marelli kodları



**I**

Magneti Marelli After Market Parts and Services S.p.A. ha curato con particolare attenzione la stesura del presente catalogo; declina comunque ogni responsabilità per eventuali errori od omissioni relativi a schemi, disegni, corrispondenze con i codici O.E. ecc. e si riserva il diritto di apportare modifiche al contenuto senza l'obbligo di darne preventiva comunicazione. Sono particolarmente graditi, da parte degli utenti, commenti, segnalazioni di inesattezze e qualsiasi altro suggerimento atto a rendere più efficace la prossima edizione del catalogo.

GB

Magneti Marelli After Market Parts and Services S.p.A. has devoted its best attention to the editing of this catalogue; it nevertheless declines any responsibility for possible mistakes or omissions regarding figures, drawings, correspondence with O.E. codes etc. and it reserves the right to modify the contents without prior notice. Users' comments, reports of inaccuracies or any other suggestions which may in any way improve the next edition of this catalogue are warmly welcomed.

D

Magneti Marelli After Market Parts and Services S.p.A. hat diesen Katalog sorgfältig verfasst. Die Firma enthebt sich jeglicher Verantwortung für eventuelle Fehler oder Auslassung hinsichtlich Schemen, Zeichnungen, Übereinstimmungen mit O.E. Codes usw. und behält sich das Recht vor, ohne Ankündigung, am Inhalt Veränderungen vorzunehmen. Anmerkungen, Fehlerhinweise und weitere Anregungen werden gerne entgegengenommen, um die nächste Ausgabe des Katalogs effizienter zu gestalten.

F

Magneti Marelli After Market Parts and Services S.p.A. a soigné avec une attention particulière la rédaction de ce catalogue; elle décline cependant toute responsabilité pour toute erreur ou omission éventuelle dans les schémas, les dessins, les correspondances avec les codes O.E., etc. et se réserve le droit d'en modifier le contenu sans obligation de communication préalable. Les commentaires, les signalisations d'inexactitudes et toute autre suggestion des utilisateurs susceptibles de rendre la prochaine rédaction du catalogue plus efficace seront particulièrement appréciés.

E

Magneti Marelli After Market Parts and Services S.p.A. ha cuidado con especial atención la redacción del presente catálogo; de todas maneras declina toda responsabilidad por eventuales errores u omisiones relativos a esquemas, diseños, correspondencia con los códigos O.E., etc., y se reserva el derecho de aportar modificaciones al contenido sin la obligación de previo aviso. Se agradecen especialmente los comentarios, las indicaciones al contenido sin la obligación de previo aviso. Se agradecen especialmente los comentarios, las indicaciones de inexactitudes y cualquier otra sugerencia por parte de los usuarios que sean útiles para hacer más eficaz la próxima edición del catálogo.

P

A Magneti Marelli After Market Parts and Services S.p.A. cuidou com particular atenção a redação do presente catálogo; como quer que seja, rejeita qualquer responsabilidade face a eventuais erros o omissões relacionados aos esquemas, desenhos, correspondências aos códigos O.E. etc. e reserva-se o direito de introduzir alterações ao seu conteúdo sem a obrigação de comunicação prévia das mesmas. São particularmente bem aceitos, comentários, sinalizações de inexatidões e qualquer outra sugestão idônea a tornar mais eficaz a próxima edição do catálogo.

G

H Magneti Marelli After Market Parts and Services S.p.A. φροντίσε με καθε λεπτομερεια την ορθότητα των στοιχειων αυτου του καταλογου, δεν φερει ομως καμια ευθυνη για τυχον λαθη ή παραληψεις που σχετιζονται με σχηματα, σχεδια, αντιστοιχιες με γνησια νουμερα κτλ. και επιφυλασσειται του δικαιωματος να αλλαξει το περιεχομενο του καταλογου οποιαδηποτε στιγμή χωρις προτερη ενημερωση. Οποιαδηποτε σχολια η παρατηρησεις, με στοχο την βελτιωση του καταλογου, είναι ευπροσδεκτα.

PL

Firma Magneti Marelli After Market Parts and Services S.p.A. dołożyła szczególnych starań przy opracowywaniu niniejszego katalogu. Nie ponosi ona jednak żadnej odpowiedzialności za ewentualne błędy lub braki dotyczące schematów, rysunków, zgodności z kodami O.E., itp. Firma Magneti Marelli After Market Parts and Services S.p.A. zastrzega sobie prawo do wprowadzania zmian bez obowiązku uprzedniego powiadomienia o tym. Szczególnie mile widziane są komentarze i sygnały dotyczące nieprawidłowości oraz jakiegokolwiek inne sugestie zgłaszane przez klientów, mające na celu udoskonalenie następnych edycji katalogu.

RU

Magneti Marelli After Market Parts and Services S.p.A. уделила особое внимание созданию этого каталога. Но, несмотря на это, мы не несем ответственности за возможные ошибки или неточности в цифрах, изображениях или кросс-номерах. Также мы оставляем за собой право вносить любые изменения без предварительного уведомления. Мы будем благодарны Вам за замечания и комментарии, которые учтем при подготовке следующего издания каталога.

T

Magneti Marelli After Market Parts and Services S.p.A., mevcut katalogdaki yazıyı çok özenli bir şekilde hazırlamıştır; O.E. vs. şifrelerine karşılık gelen her türlü model ve tasarım ile ilgili olası eksiklikler ve hatalar ile ilgili sorumluluğunun altını çizer ve öncesinde haber verme zorunluluğu olmaksızın değişiklik yapma hakkını saklı tutar. Kullanıcı tarafından yorumların, eksikliklerin ve her türlü önerilerin belirtilmesi, bir sonraki katalog baskısını daha etkili hale getirecektir.

**I**

È vietata la riproduzione, anche parziale, del contenuto del presente catalogo senza preventiva autorizzazione scritta della Magneti Marelli After Market Parts and Services S.p.A., che tutelerà i propri diritti a termine di legge.

GB

It is forbidden to reproduce, even partially, the contents of this catalogue without prior written consent from Magneti Marelli After Market Parts and Services S.p.A., who will protect its rights in accordance with the law.

D

Die Vervielfältigung, auch teilweise, des urheberrechtlich geschützten Inhalts des vorliegenden Katalogs ist ohne schriftliche Genehmigung durch Magneti Marelli After Market Parts and Services S.p.A. untersagt.

F

Il est interdit de reproduire même partiellement le contenu de ce catalogue sans autorisation écrite préalable de Magneti Marelli After Market Parts and Services S.p.A., qui protégera ses droits selon les termes de la loi.

E

Está prohibida la reproducción, total o parcial, del contenido del presente catálogo sin previa autorización escrita de Magneti Marelli After Market Parts and Services S.p.A., que protegerá sus propios derechos con arreglo a la ley.

P

É proibida a reprodução, também parcial, do conteúdo do presente catálogo sem a prévia autorização escrita de Magneti Marelli After Market Parts and Services S.p.A., que defenderá os próprios direitos, nos termos de lei.

G

Απαγορεύεται η αναπαραγωγή, ολική ή μερική, του περιεχομένου του παρόντος καταλόγου χωρίς την γραπτή εξουσιοδότηση της Magneti Marelli After Market Parts and Services S.p.A.

PL

Zabroniona jest nawet częściowa reprodukcja zawartości katalogu bez uprzedniej pisemnej autoryzacji ze strony firmy Magneti Marelli After Market Parts and Services S.p.A., która chroni swą własność zgodnie z przepisami prawa.

RU

Запрещается воспроизводить, даже частично, содержание этого каталога без предварительного письменного согласия от Magneti Marelli After Market Parts and Services S.p.A., которая будет защищать свои права в соответствии с законом.

T

Tüm yasal hakların sahibi olan Magneti Marelli After Market Parts and Services S.p.A. 'in yazılı izni olmaksızın mevcut kataloğun kısmen de olsa çoğaltılması yasaktır.

La corrispondenza dovrà essere inviata a:

Correspondence should be sent to:

Der Briefverkehr ist zu senden an:

Envoyer la correspondance à:

La correspondencia debe ser enviada a:

La correspondência deverá ser enviada a:

Η αλληλογραφία θα πρέπει να αποστέλλεται:

Korespondencję należy przysyłać na adres:

Соответствующую корреспонденцию просим присылать по адресу:

Ticari yazışmalar şu adrese gönderilmelidir:

Magneti Marelli Aftermarket Sp. z o.o.

ul. Plac pod Lipami 5

40-476 Katowice

Tel. +48/32/6036107 • Fax +48/32/6036108

e-mail: ricambi@magnetimarelli.com

www.magnetimarelli-checkstar.pl



***Codici Magneti Marelli
Magneti Marelli references
Magneti Marelli Nr.
Références Magneti Marelli
Códigos Magneti Marelli
Códigos Magneti Marelli
Κωδικοί Magneti Marelli
Kody Magneti Marelli
Коды Магнети Марелли
Magneti Marelli kodlari***





LONG	SHORT	LONG	SHORT	LONG	SHORT
301181300100	ARM001	301181309500	ARM095	301181316200	ARM162
301181300200	ARM002	301181309600	ARM096	301181316300	ARM163
301181300300	ARM003	301181311100	ARM111	301181316400	ARM164
301181300400	ARM004	301181311200	ARM112	301181316500	ARM165
301181300700	ARM007	301181311300	ARM113	301181316600	ARM166
301181300800	ARM008	301181311400	ARM114	301181316700	ARM167
301181301700	ARM017	301181311500	ARM115	301181316800	ARM168
301181301800	ARM018	301181311600	ARM116	301181316900	ARM169
301181301900	ARM019	301181311700	ARM117	301181317000	ARM170
301181302000	ARM020	301181311800	ARM118	301181317100	ARM171
301181302300	ARM023	301181311900	ARM119	301181317200	ARM172
301181302400	ARM024	301181312000	ARM120	301181317300	ARM173
301181302500	ARM025	301181312100	ARM121	301181317400	ARM174
301181302600	ARM026	301181312200	ARM122	301181317500	ARM175
301181302700	ARM027	301181312300	ARM123	301181317600	ARM176
301181302800	ARM028	301181312400	ARM124	301181317700	ARM177
301181303500	ARM035	301181312500	ARM125	301181317800	ARM178
301181303600	ARM036	301181312600	ARM126	301181317900	ARM179
301181303700	ARM037	301181312700	ARM127	301181318000	ARM180
301181304100	ARM041	301181312800	ARM128	301181318100	ARM181
301181304200	ARM042	301181313300	ARM133	301181318200	ARM182
301181305800	ARM058	301181313400	ARM134	301181318300	ARM183
301181305900	ARM059	301181313500	ARM135	301181318400	ARM184
301181306000	ARM060	301181313600	ARM136	301181318500	ARM185
301181306100	ARM061	301181313700	ARM137	301181318600	ARM186
301181306200	ARM062	301181313800	ARM138	301181318700	ARM187
301181306300	ARM063	301181313900	ARM139	301181318800	ARM188
301181306800	ARM068	301181314000	ARM140	301181318900	ARM189
301181307000	ARM070	301181314100	ARM141	301181319000	ARM190
301181307300	ARM073	301181314200	ARM142	301181319100	ARM191
301181307400	ARM074	301181314700	ARM147	301181319200	ARM192
301181307500	ARM075	301181314800	ARM148	301181319300	ARM193
301181307600	ARM076	301181314900	ARM149	301181319400	ARM194
301181308100	ARM081	301181315000	ARM150	301181319500	ARM195
301181308200	ARM082	301181315100	ARM151	301181319600	ARM196
301181308900	ARM089	301181315200	ARM152	301181319700	ARM197
301181309000	ARM090	301181315300	ARM153	301181319800	ARM198
301181309100	ARM091	301181315400	ARM154	301181319900	ARM199
301181309200	ARM092	301181315500	ARM155	301181320000	ARM200
301181309300	ARM093	301181315600	ARM156	301181320100	ARM201
301181309400	ARM094	301181316100	ARM161	301181320200	ARM202



MAGNETI MARELLI		MAGNETI MARELLI		MAGNETI MARELLI	
LONG	SHORT	LONG	SHORT	LONG	SHORT
301181320300	ARM203	301181324400	ARM244	301181328500	ARM285
301181320400	ARM204	301181324500	ARM245	301181328600	ARM286
301181320500	ARM205	301181324600	ARM246	301181328700	ARM287
301181320600	ARM206	301181324700	ARM247	301181328800	ARM288
301181320700	ARM207	301181324800	ARM248	301181328900	ARM289
301181320800	ARM208	301181324900	ARM249	301181329000	ARM290
301181320900	ARM209	301181325000	ARM250	301181329100	ARM291
301181321000	ARM210	301181325100	ARM251	301181329200	ARM292
301181321100	ARM211	301181325200	ARM252	301181329300	ARM293
301181321200	ARM212	301181325300	ARM253	301181329400	ARM294
301181321300	ARM213	301181325400	ARM254	301181329500	ARM295
301181321400	ARM214	301181325500	ARM255	301181329600	ARM296
301181321500	ARM215	301181325600	ARM256	301181329700	ARM297
301181321600	ARM216	301181325700	ARM257	301181329800	ARM298
301181321700	ARM217	301181325800	ARM258	301181329900	ARM299
301181321800	ARM218	301181325900	ARM259	301181330000	ARM300
301181321900	ARM219	301181326000	ARM260	301181330100	ARM301
301181322000	ARM220	301181326100	ARM261	301181330200	ARM302
301181322100	ARM221	301181326200	ARM262	301181330300	ARM303
301181322200	ARM222	301181326300	ARM263	301181330400	ARM304
301181322300	ARM223	301181326400	ARM264	301181330500	ARM305
301181322400	ARM224	301181326500	ARM265	301181330600	ARM306
301181322500	ARM225	301181326600	ARM266	301181330700	ARM307
301181322600	ARM226	301181326700	ARM267	301181330800	ARM308
301181322700	ARM227	301181326800	ARM268	301181330900	ARM309
301181322800	ARM228	301181326900	ARM269	301181331000	ARM310
301181322900	ARM229	301181327000	ARM270	301181331100	ARM311
301181323000	ARM230	301181327100	ARM271	301181331200	ARM312
301181323100	ARM231	301181327200	ARM272	301181331300	ARM313
301181323200	ARM232	301181327300	ARM273	301181331400	ARM314
301181323300	ARM233	301181327400	ARM274	301181331500	ARM315
301181323400	ARM234	301181327500	ARM275	301181331600	ARM316
301181323500	ARM235	301181327600	ARM276	301181331700	ARM317
301181323600	ARM236	301181327700	ARM277	301181331800	ARM318
301181323700	ARM237	301181327800	ARM278	301181331900	ARM319
301181323800	ARM238	301181327900	ARM279	301181332000	ARM320
301181323900	ARM239	301181328000	ARM280	301181332100	ARM321
301181324000	ARM240	301181328100	ARM281	301181332200	ARM322
301181324100	ARM241	301181328200	ARM282	301181332300	ARM323
301181324200	ARM242	301181328300	ARM283	301181332400	ARM324
301181324300	ARM243	301181328400	ARM284	301181332500	ARM325



LONG	SHORT	LONG	SHORT	LONG	SHORT
301181332600	ARM326	301181336700	ARM367	301181340800	ARM408
301181332700	ARM327	301181336800	ARM368	301181340900	ARM409
301181332800	ARM328	301181336900	ARM369	301181341000	ARM410
301181332900	ARM329	301181337000	ARM370	301181341100	ARM411
301181333000	ARM330	301181337100	ARM371	301181341200	ARM412
301181333100	ARM331	301181337200	ARM372	301181341300	ARM413
301181333200	ARM332	301181337300	ARM373	301181341400	ARM414
301181333300	ARM333	301181337400	ARM374	301181341500	ARM415
301181333400	ARM334	301181337500	ARM375	301181341600	ARM416
301181333500	ARM335	301181337600	ARM376	301181341700	ARM417
301181333600	ARM336	301181337700	ARM377	301181341800	ARM418
301181333700	ARM337	301181337800	ARM378	301181341900	ARM419
301181333800	ARM338	301181337900	ARM379	301181342000	ARM420
301181333900	ARM339	301181338000	ARM380	301181342100	ARM421
301181334000	ARM340	301181338100	ARM381	301181342200	ARM422
301181334100	ARM341	301181338200	ARM382	301181342300	ARM423
301181334200	ARM342	301181338300	ARM383	301181342400	ARM424
301181334300	ARM343	301181338400	ARM384	301181342500	ARM425
301181334400	ARM344	301181338500	ARM385	301181342600	ARM426
301181334500	ARM345	301181338600	ARM386	301181342700	ARM427
301181334600	ARM346	301181338700	ARM387	301181342800	ARM428
301181334700	ARM347	301181338800	ARM388	301181342900	ARM429
301181334800	ARM348	301181338900	ARM389	301181343000	ARM430
301181334900	ARM349	301181339000	ARM390	301181343100	ARM431
301181335000	ARM350	301181339100	ARM391	301181343200	ARM432
301181335100	ARM351	301181339200	ARM392	301181343300	ARM433
301181335200	ARM352	301181339300	ARM393	301181343400	ARM434
301181335300	ARM353	301181339400	ARM394	301181343500	ARM435
301181335400	ARM354	301181339500	ARM395	301181343600	ARM436
301181335500	ARM355	301181339600	ARM396	301181343700	ARM437
301181335600	ARM356	301181339700	ARM397	301181343800	ARM438
301181335700	ARM357	301181339800	ARM398	301181343900	ARM439
301181335800	ARM358	301181339900	ARM399	301181344000	ARM440
301181335900	ARM359	301181340000	ARM400	301181344100	ARM441
301181336000	ARM360	301181340100	ARM401	301181344200	ARM442
301181336100	ARM361	301181340200	ARM402	301181344300	ARM443
301181336200	ARM362	301181340300	ARM403	301181344400	ARM444
301181336300	ARM363	301181340400	ARM404	301181344500	ARM445
301181336400	ARM364	301181340500	ARM405	301181344600	ARM446
301181336500	ARM365	301181340600	ARM406	301181344700	ARM447
301181336600	ARM366	301181340700	ARM407	301181344800	ARM448



MAGNETI MARELLI		MAGNETI MARELLI		MAGNETI MARELLI	
LONG	SHORT	LONG	SHORT	LONG	SHORT
301181344900	ARM449	301181349000	ARM490	301181353200	ARM532
301181345000	ARM450	301181349100	ARM491	301181353300	ARM533
301181345100	ARM451	301181349200	ARM492	301181353400	ARM534
301181345200	ARM452	301181349300	ARM493	301181353500	ARM535
301181345300	ARM453	301181349400	ARM494	301181353600	ARM536
301181345400	ARM454	301181349500	ARM495	301181353700	ARM537
301181345500	ARM455	301181349600	ARM496	301181353800	ARM538
301181345600	ARM456	301181349700	ARM497	301181353900	ARM539
301181345700	ARM457	301181349800	ARM498	301181354000	ARM540
301181345800	ARM458	301181349900	ARM499	301181354100	ARM541
301181345900	ARM459	301181350100	ARM501	301181354200	ARM542
301181346000	ARM460	301181350200	ARM502	301181354300	ARM543
301181346100	ARM461	301181350300	ARM503	301181354400	ARM544
301181346200	ARM462	301181350400	ARM504	301181354500	ARM545
301181346300	ARM463	301181350500	ARM505	301181354600	ARM546
301181346400	ARM464	301181350600	ARM506	301181354700	ARM547
301181346500	ARM465	301181350700	ARM507	301181354800	ARM548
301181346600	ARM466	301181350800	ARM508	301181354900	ARM549
301181346700	ARM467	301181350900	ARM509	301181355000	ARM550
301181346800	ARM468	301181351000	ARM510	301181355100	ARM551
301181346900	ARM469	301181351100	ARM511	301181355200	ARM552
301181347000	ARM470	301181351200	ARM512	301181355300	ARM553
301181347100	ARM471	301181351300	ARM513	301181355400	ARM554
301181347200	ARM472	301181351400	ARM514	301181355500	ARM555
301181347300	ARM473	301181351500	ARM515	301181355600	ARM556
301181347400	ARM474	301181351600	ARM516	301181355700	ARM557
301181347500	ARM475	301181351700	ARM517	301181355800	ARM558
301181347600	ARM476	301181351800	ARM518	301181355900	ARM559
301181347700	ARM477	301181351900	ARM519	301181356000	ARM560
301181347800	ARM478	301181352000	ARM520	301181356100	ARM561
301181347900	ARM479	301181352100	ARM521	301181356200	ARM562
301181348000	ARM480	301181352200	ARM522	301181356300	ARM563
301181348100	ARM481	301181352300	ARM523	301181356400	ARM564
301181348200	ARM482	301181352400	ARM524	301181356500	ARM565
301181348300	ARM483	301181352500	ARM525	301181356600	ARM566
301181348400	ARM484	301181352600	ARM526	301181356700	ARM567
301181348500	ARM485	301181352700	ARM527	301181356800	ARM568
301181348600	ARM486	301181352800	ARM528	301181356900	ARM569
301181348700	ARM487	301181352900	ARM529	301181357000	ARM570
301181348800	ARM488	301181353000	ARM530	301181357100	ARM571
301181348900	ARM489	301181353100	ARM531	301181357200	ARM572



LONG	SHORT	LONG	SHORT	LONG	SHORT
301181357300	ARM573	301181361400	ARM614	301181365500	ARM655
301181357400	ARM574	301181361500	ARM615	301181365600	ARM656
301181357500	ARM575	301181361600	ARM616	301181365700	ARM657
301181357600	ARM576	301181361700	ARM617	301181365800	ARM658
301181357700	ARM577	301181361800	ARM618	301181365900	ARM659
301181357800	ARM578	301181361900	ARM619	301181366000	ARM660
301181357900	ARM579	301181362000	ARM620	301181366100	ARM661
301181358000	ARM580	301181362100	ARM621	301181366200	ARM662
301181358100	ARM581	301181362200	ARM622	301181366300	ARM663
301181358200	ARM582	301181362300	ARM623	301181366400	ARM664
301181358300	ARM583	301181362400	ARM624	301181366500	ARM665
301181358400	ARM584	301181362500	ARM625	301181366600	ARM666
301181358500	ARM585	301181362600	ARM626	301181366700	ARM667
301181358600	ARM586	301181362700	ARM627	301181366800	ARM668
301181358700	ARM587	301181362800	ARM628	301181366900	ARM669
301181358800	ARM588	301181362900	ARM629	301181367000	ARM670
301181358900	ARM589	301181363000	ARM630	301181367100	ARM671
301181359000	ARM590	301181363100	ARM631	301181367200	ARM672
301181359100	ARM591	301181363200	ARM632	301181367300	ARM673
301181359200	ARM592	301181363300	ARM633	301181367400	ARM674
301181359300	ARM593	301181363400	ARM634	301181367500	ARM675
301181359400	ARM594	301181363500	ARM635	301181367600	ARM676
301181359500	ARM595	301181363600	ARM636	301181367700	ARM677
301181359600	ARM596	301181363700	ARM637	301181367800	ARM678
301181359700	ARM597	301181363800	ARM638	301181367900	ARM679
301181359800	ARM598	301181363900	ARM639	301181368000	ARM680
301181359900	ARM599	301181364000	ARM640	301181368100	ARM681
301181360000	ARM600	301181364100	ARM641	301181368200	ARM682
301181360100	ARM601	301181364200	ARM642	301181368300	ARM683
301181360200	ARM602	301181364300	ARM643	301181368400	ARM684
301181360300	ARM603	301181364400	ARM644	301181368500	ARM685
301181360400	ARM604	301181364500	ARM645	301181368600	ARM686
301181360500	ARM605	301181364600	ARM646	301181368700	ARM687
301181360600	ARM606	301181364700	ARM647	301181368800	ARM688
301181360700	ARM607	301181364800	ARM648	301181368900	ARM689
301181360800	ARM608	301181364900	ARM649	301181369000	ARM690
301181360900	ARM609	301181365000	ARM650	301181369100	ARM691
301181361000	ARM610	301181365100	ARM651	301181369200	ARM692
301181361100	ARM611	301181365200	ARM652	301181369300	ARM693
301181361200	ARM612	301181365300	ARM653	301181369400	ARM694
301181361300	ARM613	301181365400	ARM654	301181369500	ARM695



MAGNETI MARELLI		MAGNETI MARELLI		MAGNETI MARELLI	
LONG	SHORT	LONG	SHORT	LONG	SHORT
301181369600	ARM696	301181373700	ARM737	301181377800	ARM778
301181369700	ARM697	301181373800	ARM738	301181377900	ARM779
301181369800	ARM698	301181373900	ARM739	301181378000	ARM780
301181369900	ARM699	301181374000	ARM740	301181378100	ARM781
301181370000	ARM700	301181374100	ARM741	301181378200	ARM782
301181370100	ARM701	301181374200	ARM742	301181378300	ARM783
301181370200	ARM702	301181374300	ARM743	301181378400	ARM784
301181370300	ARM703	301181374400	ARM744	301181378500	ARM785
301181370400	ARM704	301181374500	ARM745	301181378600	ARM786
301181370500	ARM705	301181374600	ARM746	301181378700	ARM787
301181370600	ARM706	301181374700	ARM747	301181378800	ARM788
301181370700	ARM707	301181374800	ARM748	301181378900	ARM789
301181370800	ARM708	301181374900	ARM749	301181379000	ARM790
301181370900	ARM709	301181375000	ARM750	301181379100	ARM791
301181371000	ARM710	301181375100	ARM751	301181379200	ARM792
301181371100	ARM711	301181375200	ARM752	301181379300	ARM793
301181371200	ARM712	301181375300	ARM753	301181379400	ARM794
301181371300	ARM713	301181375400	ARM754	301181379500	ARM795
301181371400	ARM714	301181375500	ARM755	301181379600	ARM796
301181371500	ARM715	301181375600	ARM756	301181379700	ARM797
301181371600	ARM716	301181375700	ARM757	301181379800	ARM798
301181371700	ARM717	301181375800	ARM758	301181379900	ARM799
301181371800	ARM718	301181375900	ARM759	301181380000	ARM800
301181371900	ARM719	301181376000	ARM760	301181380100	ARM801
301181372000	ARM720	301181376100	ARM761	301181380200	ARM802
301181372100	ARM721	301181376200	ARM762	301181380300	ARM803
301181372200	ARM722	301181376300	ARM763	301181380400	ARM804
301181372300	ARM723	301181376400	ARM764	301181380500	ARM805
301181372400	ARM724	301181376500	ARM765	301181380600	ARM806
301181372500	ARM725	301181376600	ARM766	301181380700	ARM807
301181372600	ARM726	301181376700	ARM767	301181380800	ARM808
301181372700	ARM727	301181376800	ARM768	301181380900	ARM809
301181372800	ARM728	301181376900	ARM769	301181381000	ARM810
301181372900	ARM729	301181377000	ARM770	301181381100	ARM811
301181373000	ARM730	301181377100	ARM771	301181381200	ARM812
301181373100	ARM731	301181377200	ARM772	301181381300	ARM813
301181373200	ARM732	301181377300	ARM773	301181381400	ARM814
301181373300	ARM733	301181377400	ARM774	301181381500	ARM815
301181373400	ARM734	301181377500	ARM775	301181381600	ARM816
301181373500	ARM735	301181377600	ARM776	301181381700	ARM817
301181373600	ARM736	301181377700	ARM777	301181381800	ARM818



LONG	SHORT	LONG	SHORT	LONG	SHORT
301181381900	ARM819	301181386000	ARM860	301181390100	ARM901
301181382000	ARM820	301181386100	ARM861	301181390200	ARM902
301181382100	ARM821	301181386200	ARM862	301181390300	ARM903
301181382200	ARM822	301181386300	ARM863	301181390400	ARM904
301181382300	ARM823	301181386400	ARM864	301181390500	ARM905
301181382400	ARM824	301181386500	ARM865	301181390600	ARM906
301181382500	ARM825	301181386600	ARM866	301181390700	ARM907
301181382600	ARM826	301181386700	ARM867	301181390800	ARM908
301181382700	ARM827	301181386800	ARM868	301181390900	ARM909
301181382800	ARM828	301181386900	ARM869	301181391000	ARM910
301181382900	ARM829	301181387000	ARM870	301181391100	ARM911
301181383000	ARM830	301181387100	ARM871	301181391200	ARM912
301181383100	ARM831	301181387200	ARM872	301181391300	ARM913
301181383200	ARM832	301181387300	ARM873	301181391400	ARM914
301181383300	ARM833	301181387400	ARM874	301181391500	ARM915
301181383400	ARM834	301181387500	ARM875	301181391600	ARM916
301181383500	ARM835	301181387600	ARM876	301181391700	ARM917
301181383600	ARM836	301181387700	ARM877	301181391800	ARM918
301181383700	ARM837	301181387800	ARM878	301181391900	ARM919
301181383800	ARM838	301181387900	ARM879	301181392000	ARM920
301181383900	ARM839	301181388000	ARM880	301181392100	ARM921
301181384000	ARM840	301181388100	ARM881	301181392200	ARM922
301181384100	ARM841	301181388200	ARM882	301181392300	ARM923
301181384200	ARM842	301181388300	ARM883	301181392400	ARM924
301181384300	ARM843	301181388400	ARM884	301181392500	ARM925
301181384400	ARM844	301181388500	ARM885	301181392600	ARM926
301181384500	ARM845	301181388600	ARM886	301181392700	ARM927
301181384600	ARM846	301181388700	ARM887	301181392800	ARM928
301181384700	ARM847	301181388800	ARM888	301181392900	ARM929
301181384800	ARM848	301181388900	ARM889	301181393000	ARM930
301181384900	ARM849	301181389000	ARM890	301181393100	ARM931
301181385000	ARM850	301181389100	ARM891	301181393200	ARM932
301181385100	ARM851	301181389200	ARM892	301181393300	ARM933
301181385200	ARM852	301181389300	ARM893	301181393400	ARM934
301181385300	ARM853	301181389400	ARM894	301181393500	ARM935
301181385400	ARM854	301181389500	ARM895	301181393600	ARM936
301181385500	ARM855	301181389600	ARM896	301181393700	ARM937
301181385600	ARM856	301181389700	ARM897	301181393800	ARM938
301181385700	ARM857	301181389800	ARM898	301181393900	ARM939
301181385800	ARM858	301181389900	ARM899	301181394000	ARM940
301181385900	ARM859	301181390000	ARM900	301181394100	ARM941



MAGNETI MARELLI		MAGNETI MARELLI		MAGNETI MARELLI	
LONG	SHORT	LONG	SHORT	LONG	SHORT
301181394200	ARM942	301181398300	ARM983	301181310270	ARM1027
301181394300	ARM943	301181398400	ARM984	301181310280	ARM1028
301181394400	ARM944	301181398500	ARM985	301181310290	ARM1029
301181394500	ARM945	301181398600	ARM986	301181310300	ARM1030
301181394600	ARM946	301181398700	ARM987	301181310310	ARM1031
301181394700	ARM947	301181398800	ARM988	301181310320	ARM1032
301181394800	ARM948	301181398900	ARM989	301181310330	ARM1033
301181394900	ARM949	301181399000	ARM990	301181310340	ARM1034
301181395000	ARM950	301181399100	ARM991	301181310350	ARM1035
301181395100	ARM951	301181399200	ARM992	301181310360	ARM1036
301181395200	ARM952	301181399300	ARM993	301181310370	ARM1037
301181395300	ARM953	301181399400	ARM994	301181310380	ARM1038
301181395400	ARM954	301181399500	ARM995	301181310390	ARM1039
301181395500	ARM955	301181399600	ARM996	301181310400	ARM1040
301181395600	ARM956	301181399700	ARM997	301181310410	ARM1041
301181395700	ARM957	301181399800	ARM998	301181310420	ARM1042
301181395800	ARM958	301181399900	ARM999	301181310430	ARM1043
301181395900	ARM959	301181310010	ARM1001	301181310440	ARM1044
301181396000	ARM960	301181310020	ARM1002	301181310450	ARM1045
301181396100	ARM961	301181310030	ARM1003	301181310460	ARM1046
301181396200	ARM962	301181310040	ARM1004	301181310470	ARM1047
301181396300	ARM963	301181310050	ARM1005	301181310480	ARM1048
301181396400	ARM964	301181310060	ARM1006	301181310490	ARM1049
301181396500	ARM965	301181310070	ARM1007	301181310500	ARM1050
301181396600	ARM966	301181310080	ARM1008	301181310510	ARM1051
301181396700	ARM967	301181310090	ARM1009	301181310520	ARM1052
301181396800	ARM968	301181310100	ARM1010	301181310530	ARM1053
301181396900	ARM969	301181310110	ARM1011	301181310540	ARM1054
301181397000	ARM970	301181310120	ARM1012	301181310550	ARM1055
301181397100	ARM971	301181310130	ARM1013	301181310560	ARM1056
301181397200	ARM972	301181310140	ARM1014	301181310570	ARM1057
301181397300	ARM973	301181310150	ARM1015	301181310580	ARM1058
301181397400	ARM974	301181310160	ARM1016	301181310590	ARM1059
301181397500	ARM975	301181310170	ARM1017	301181310600	ARM1060
301181397600	ARM976	301181310180	ARM1018	301181310610	ARM1061
301181397700	ARM977	301181310190	ARM1019	301181310620	ARM1062
301181397800	ARM978	301181310220	ARM1022	301181310630	ARM1063
301181397900	ARM979	301181310230	ARM1023	301181310640	ARM1064
301181398000	ARM980	301181310240	ARM1024	301181310650	ARM1065
301181398100	ARM981	301181310250	ARM1025	301181310660	ARM1066
301181398200	ARM982	301181310260	ARM1026	301181310670	ARM1067



LONG	SHORT	LONG	SHORT	LONG	SHORT
301181310680	ARM1068	301191600160	SSP0016	301191600570	SSP0057
301181310690	ARM1069	301191600170	SSP0017	301191600580	SSP0058
301181310700	ARM1070	301191600180	SSP0018	301191600590	SSP0059
301181310710	ARM1071	301191600190	SSP0019	301191600600	SSP0060
301181310720	ARM1072	301191600200	SSP0020	301191600610	SSP0061
301181310730	ARM1073	301191600210	SSP0021	301191600620	SSP0062
301181310740	ARM1074	301191600220	SSP0022	301191600630	SSP0063
301181310750	ARM1075	301191600230	SSP0023	301191600640	SSP0064
301181310760	ARM1076	301191600240	SSP0024	301191600650	SSP0065
301181310770	ARM1077	301191600250	SSP0025	301191600660	SSP0066
301181310780	ARM1078	301191600260	SSP0026	301191600670	SSP0067
301181310790	ARM1079	301191600270	SSP0027	301191600680	SSP0068
301181310800	ARM1080	301191600280	SSP0028	301191600690	SSP0069
301181310810	ARM1081	301191600290	SSP0029	301191600700	SSP0070
301181310820	ARM1082	301191600300	SSP0030	301191600710	SSP0071
301181310830	ARM1083	301191600310	SSP0031	301191600720	SSP0072
301181310840	ARM1084	301191600320	SSP0032	301191600730	SSP0073
301181310850	ARM1085	301191600330	SSP0033	301191600740	SSP0074
301181310860	ARM1086	301191600340	SSP0034	301191600750	SSP0075
301181310870	ARM1087	301191600350	SSP0035	301191600760	SSP0076
301181310880	ARM1088	301191600360	SSP0036	301191600770	SSP0077
301181310890	ARM1089	301191600370	SSP0037	301191600780	SSP0078
301181310900	ARM1090	301191600380	SSP0038	301191600790	SSP0079
301181310910	ARM1091	301191600390	SSP0039	301191600800	SSP0080
301181310920	ARM1092	301191600400	SSP0040	301191600810	SSP0081
301181310930	ARM1093	301191600410	SSP0041	301191600820	SSP0082
301191600010	SSP0001	301191600420	SSP0042	301191600830	SSP0083
301191600020	SSP0002	301191600430	SSP0043	301191600840	SSP0084
301191600030	SSP0003	301191600440	SSP0044	301191600850	SSP0085
301191600040	SSP0004	301191600450	SSP0045	301191600860	SSP0086
301191600050	SSP0005	301191600460	SSP0046	301191600870	SSP0087
301191600060	SSP0006	301191600470	SSP0047	301191600880	SSP0088
301191600070	SSP0007	301191600480	SSP0048	301191600890	SSP0089
301191600080	SSP0008	301191600490	SSP0049	301191600900	SSP0090
301191600090	SSP0009	301191600500	SSP0050	301191600910	SSP0091
301191600100	SSP0010	301191600510	SSP0051	301191600920	SSP0092
301191600110	SSP0011	301191600520	SSP0052	301191600930	SSP0093
301191600120	SSP0012	301191600530	SSP0053	301191600940	SSP0094
301191600130	SSP0013	301191600540	SSP0054	301191600950	SSP0095
301191600140	SSP0014	301191600550	SSP0055	301191600960	SSP0096
301191600150	SSP0015	301191600560	SSP0056	301191600970	SSP0097



MAGNETI MARELLI		MAGNETI MARELLI		MAGNETI MARELLI	
LONG	SHORT	LONG	SHORT	LONG	SHORT
301191600980	SSP0098	301191601390	SSP0139	301191601800	SSP0180
301191600990	SSP0099	301191601400	SSP0140	301191601810	SSP0181
301191601000	SSP0100	301191601410	SSP0141	301191601820	SSP0182
301191601010	SSP0101	301191601420	SSP0142	301191601830	SSP0183
301191601020	SSP0102	301191601430	SSP0143	301191601840	SSP0184
301191601030	SSP0103	301191601440	SSP0144	301191601850	SSP0185
301191601040	SSP0104	301191601450	SSP0145	301191601860	SSP0186
301191601050	SSP0105	301191601460	SSP0146	301191601870	SSP0187
301191601060	SSP0106	301191601470	SSP0147	301191601880	SSP0188
301191601070	SSP0107	301191601480	SSP0148	301191601890	SSP0189
301191601080	SSP0108	301191601490	SSP0149	301191601900	SSP0190
301191601090	SSP0109	301191601500	SSP0150	301191601910	SSP0191
301191601100	SSP0110	301191601510	SSP0151	301191601920	SSP0192
301191601110	SSP0111	301191601520	SSP0152	301191601930	SSP0193
301191601120	SSP0112	301191601530	SSP0153	301191601940	SSP0194
301191601130	SSP0113	301191601540	SSP0154	301191601950	SSP0195
301191601140	SSP0114	301191601550	SSP0155	301191601960	SSP0196
301191601150	SSP0115	301191601560	SSP0156	301191601970	SSP0197
301191601160	SSP0116	301191601570	SSP0157	301191601980	SSP0198
301191601170	SSP0117	301191601580	SSP0158	301191601990	SSP0199
301191601180	SSP0118	301191601590	SSP0159	301191602000	SSP0200
301191601190	SSP0119	301191601600	SSP0160	301191602010	SSP0201
301191601200	SSP0120	301191601610	SSP0161	301191602020	SSP0202
301191601210	SSP0121	301191601620	SSP0162	301191602030	SSP0203
301191601220	SSP0122	301191601630	SSP0163	301191602040	SSP0204
301191601230	SSP0123	301191601640	SSP0164	301191602050	SSP0205
301191601240	SSP0124	301191601650	SSP0165	301191602060	SSP0206
301191601250	SSP0125	301191601660	SSP0166	301191602070	SSP0207
301191601260	SSP0126	301191601670	SSP0167	301191602080	SSP0208
301191601270	SSP0127	301191601680	SSP0168	301191602090	SSP0209
301191601280	SSP0128	301191601690	SSP0169	301191602100	SSP0210
301191601290	SSP0129	301191601700	SSP0170	301191602110	SSP0211
301191601300	SSP0130	301191601710	SSP0171	301191602120	SSP0212
301191601310	SSP0131	301191601720	SSP0172	301191602130	SSP0213
301191601320	SSP0132	301191601730	SSP0173	301191602140	SSP0214
301191601330	SSP0133	301191601740	SSP0174	301191602150	SSP0215
301191601340	SSP0134	301191601750	SSP0175	301191602160	SSP0216
301191601350	SSP0135	301191601760	SSP0176	301191602170	SSP0217
301191601360	SSP0136	301191601770	SSP0177	301191602180	SSP0218
301191601370	SSP0137	301191601780	SSP0178	301191602190	SSP0219
301191601380	SSP0138	301191601790	SSP0179	301191602200	SSP0220



LONG	SHORT	LONG	SHORT	LONG	SHORT
301191602210	SSP0221	301191602620	SSP0262	301191603030	SSP0303
301191602220	SSP0222	301191602630	SSP0263	301191603040	SSP0304
301191602230	SSP0223	301191602640	SSP0264	301191603050	SSP0305
301191602240	SSP0224	301191602650	SSP0265	301191603060	SSP0306
301191602250	SSP0225	301191602660	SSP0266	301191603070	SSP0307
301191602260	SSP0226	301191602670	SSP0267	301191603080	SSP0308
301191602270	SSP0227	301191602680	SSP0268	301191603090	SSP0309
301191602280	SSP0228	301191602690	SSP0269	301191603100	SSP0310
301191602290	SSP0229	301191602700	SSP0270	301191603110	SSP0311
301191602300	SSP0230	301191602710	SSP0271	301191603120	SSP0312
301191602310	SSP0231	301191602720	SSP0272	301191603130	SSP0313
301191602320	SSP0232	301191602730	SSP0273	301191603140	SSP0314
301191602330	SSP0233	301191602740	SSP0274	301191603150	SSP0315
301191602340	SSP0234	301191602750	SSP0275	301191603160	SSP0316
301191602350	SSP0235	301191602760	SSP0276	301191603170	SSP0317
301191602360	SSP0236	301191602770	SSP0277	301191603180	SSP0318
301191602370	SSP0237	301191602780	SSP0278	301191603190	SSP0319
301191602380	SSP0238	301191602790	SSP0279	301191603200	SSP0320
301191602390	SSP0239	301191602800	SSP0280	301191603210	SSP0321
301191602400	SSP0240	301191602810	SSP0281	301191603220	SSP0322
301191602410	SSP0241	301191602820	SSP0282	301191603230	SSP0323
301191602420	SSP0242	301191602830	SSP0283	301191603240	SSP0324
301191602430	SSP0243	301191602840	SSP0284	301191603250	SSP0325
301191602440	SSP0244	301191602850	SSP0285	301191603260	SSP0326
301191602450	SSP0245	301191602860	SSP0286	301191603270	SSP0327
301191602460	SSP0246	301191602870	SSP0287	301191603280	SSP0328
301191602470	SSP0247	301191602880	SSP0288	301191603290	SSP0329
301191602480	SSP0248	301191602890	SSP0289	301191603300	SSP0330
301191602490	SSP0249	301191602900	SSP0290	301191603310	SSP0331
301191602500	SSP0250	301191602910	SSP0291	301191603320	SSP0332
301191602510	SSP0251	301191602920	SSP0292	301191603330	SSP0333
301191602520	SSP0252	301191602930	SSP0293	301191603340	SSP0334
301191602530	SSP0253	301191602940	SSP0294	301191603350	SSP0335
301191602540	SSP0254	301191602950	SSP0295	301191603360	SSP0336
301191602550	SSP0255	301191602960	SSP0296	301191603370	SSP0337
301191602560	SSP0256	301191602970	SSP0297	301191603380	SSP0338
301191602570	SSP0257	301191602980	SSP0298	301191603390	SSP0339
301191602580	SSP0258	301191602990	SSP0299	301191603400	SSP0340
301191602590	SSP0259	301191603000	SSP0300	301191603410	SSP0341
301191602600	SSP0260	301191603010	SSP0301	301191603420	SSP0342
301191602610	SSP0261	301191603020	SSP0302	301191603430	SSP0343



MAGNETI MARELLI		MAGNETI MARELLI		MAGNETI MARELLI	
LONG	SHORT	LONG	SHORT	LONG	SHORT
301191603440	SSP0344	301191603850	SSP0385	301191604260	SSP0426
301191603450	SSP0345	301191603860	SSP0386	301191604270	SSP0427
301191603460	SSP0346	301191603870	SSP0387	301191604280	SSP0428
301191603470	SSP0347	301191603880	SSP0388	301191604290	SSP0429
301191603480	SSP0348	301191603890	SSP0389	301191604300	SSP0430
301191603490	SSP0349	301191603900	SSP0390	301191604310	SSP0431
301191603500	SSP0350	301191603910	SSP0391	301191604320	SSP0432
301191603510	SSP0351	301191603920	SSP0392	301191604330	SSP0433
301191603520	SSP0352	301191603930	SSP0393	301191604340	SSP0434
301191603530	SSP0353	301191603940	SSP0394	301191604350	SSP0435
301191603540	SSP0354	301191603950	SSP0395	301191604360	SSP0436
301191603550	SSP0355	301191603960	SSP0396	301191604370	SSP0437
301191603560	SSP0356	301191603970	SSP0397	301191604380	SSP0438
301191603570	SSP0357	301191603980	SSP0398	301191604390	SSP0439
301191603580	SSP0358	301191603990	SSP0399	301191604400	SSP0440
301191603590	SSP0359	301191604000	SSP0400	301191604410	SSP0441
301191603600	SSP0360	301191604010	SSP0401	301191604420	SSP0442
301191603610	SSP0361	301191604020	SSP0402	301191604430	SSP0443
301191603620	SSP0362	301191604030	SSP0403	301191604440	SSP0444
301191603630	SSP0363	301191604040	SSP0404	301191604450	SSP0445
301191603640	SSP0364	301191604050	SSP0405	301191604460	SSP0446
301191603650	SSP0365	301191604060	SSP0406	301191604470	SSP0447
301191603660	SSP0366	301191604070	SSP0407	301191604480	SSP0448
301191603670	SSP0367	301191604080	SSP0408	301191604490	SSP0449
301191603680	SSP0368	301191604090	SSP0409	301191604500	SSP0450
301191603690	SSP0369	301191604100	SSP0410	301191604510	SSP0451
301191603700	SSP0370	301191604110	SSP0411	301191604520	SSP0452
301191603710	SSP0371	301191604120	SSP0412	301191604530	SSP0453
301191603720	SSP0372	301191604130	SSP0413	301191604540	SSP0454
301191603730	SSP0373	301191604140	SSP0414	301191604550	SSP0455
301191603740	SSP0374	301191604150	SSP0415	301191604560	SSP0456
301191603750	SSP0375	301191604160	SSP0416	301191604570	SSP0457
301191603760	SSP0376	301191604170	SSP0417	301191604580	SSP0458
301191603770	SSP0377	301191604180	SSP0418	301191604590	SSP0459
301191603780	SSP0378	301191604190	SSP0419	301191604600	SSP0460
301191603790	SSP0379	301191604200	SSP0420	301191604610	SSP0461
301191603800	SSP0380	301191604210	SSP0421	301191604620	SSP0462
301191603810	SSP0381	301191604220	SSP0422	301191604630	SSP0463
301191603820	SSP0382	301191604230	SSP0423	301191604640	SSP0464
301191603830	SSP0383	301191604240	SSP0424	301191604650	SSP0465
301191603840	SSP0384	301191604250	SSP0425	301191604660	SSP0466



LONG	SHORT	LONG	SHORT	LONG	SHORT
301191604670	SSP0467	301191605080	SSP0508	301191605490	SSP0549
301191604680	SSP0468	301191605090	SSP0509	301191605500	SSP0550
301191604690	SSP0469	301191605100	SSP0510	301191605510	SSP0551
301191604700	SSP0470	301191605110	SSP0511	301191605520	SSP0552
301191604710	SSP0471	301191605120	SSP0512	301191605530	SSP0553
301191604720	SSP0472	301191605130	SSP0513	301191605540	SSP0554
301191604730	SSP0473	301191605140	SSP0514	301191605550	SSP0555
301191604740	SSP0474	301191605150	SSP0515	301191605560	SSP0556
301191604750	SSP0475	301191605160	SSP0516	301191605570	SSP0557
301191604760	SSP0476	301191605170	SSP0517	301191605580	SSP0558
301191604770	SSP0477	301191605180	SSP0518	301191605590	SSP0559
301191604780	SSP0478	301191605190	SSP0519	301191605600	SSP0560
301191604790	SSP0479	301191605200	SSP0520	301191605610	SSP0561
301191604800	SSP0480	301191605210	SSP0521	301191605620	SSP0562
301191604810	SSP0481	301191605220	SSP0522	301191605630	SSP0563
301191604820	SSP0482	301191605230	SSP0523	301191605640	SSP0564
301191604830	SSP0483	301191605240	SSP0524	301191605650	SSP0565
301191604840	SSP0484	301191605250	SSP0525	301191605660	SSP0566
301191604850	SSP0485	301191605260	SSP0526	301191605670	SSP0567
301191604860	SSP0486	301191605270	SSP0527	301191605680	SSP0568
301191604870	SSP0487	301191605280	SSP0528	301191605690	SSP0569
301191604880	SSP0488	301191605290	SSP0529	301191605700	SSP0570
301191604890	SSP0489	301191605300	SSP0530	301191605710	SSP0571
301191604900	SSP0490	301191605310	SSP0531	301191605720	SSP0572
301191604910	SSP0491	301191605320	SSP0532	301191605730	SSP0573
301191604920	SSP0492	301191605330	SSP0533	301191605740	SSP0574
301191604930	SSP0493	301191605340	SSP0534	301191605750	SSP0575
301191604940	SSP0494	301191605350	SSP0535	301191605760	SSP0576
301191604950	SSP0495	301191605360	SSP0536	301191605770	SSP0577
301191604960	SSP0496	301191605370	SSP0537	301191605780	SSP0578
301191604970	SSP0497	301191605380	SSP0538	301191605790	SSP0579
301191604980	SSP0498	301191605390	SSP0539	301191605800	SSP0580
301191604990	SSP0499	301191605400	SSP0540	301191605810	SSP0581
301191605000	SSP0500	301191605410	SSP0541	301191605820	SSP0582
301191605010	SSP0501	301191605420	SSP0542	301191605830	SSP0583
301191605020	SSP0502	301191605430	SSP0543	301191605840	SSP0584
301191605030	SSP0503	301191605440	SSP0544	301191605850	SSP0585
301191605040	SSP0504	301191605450	SSP0545	301191605860	SSP0586
301191605050	SSP0505	301191605460	SSP0546	301191605870	SSP0587
301191605060	SSP0506	301191605470	SSP0547	301191605880	SSP0588
301191605070	SSP0507	301191605480	SSP0548	301191605890	SSP0589



MAGNETI MARELLI		MAGNETI MARELLI		MAGNETI MARELLI	
LONG	SHORT	LONG	SHORT	LONG	SHORT
301191605900	SSP0590	301191606310	SSP0631	301191606720	SSP0672
301191605910	SSP0591	301191606320	SSP0632	301191606730	SSP0673
301191605920	SSP0592	301191606330	SSP0633	301191606740	SSP0674
301191605930	SSP0593	301191606340	SSP0634	301191606750	SSP0675
301191605940	SSP0594	301191606350	SSP0635	301191606760	SSP0676
301191605950	SSP0595	301191606360	SSP0636	301191606770	SSP0677
301191605960	SSP0596	301191606370	SSP0637	301191606780	SSP0678
301191605970	SSP0597	301191606380	SSP0638	301191606790	SSP0679
301191605980	SSP0598	301191606390	SSP0639	301191606800	SSP0680
301191605990	SSP0599	301191606400	SSP0640	301191606810	SSP0681
301191606000	SSP0600	301191606410	SSP0641	301191606820	SSP0682
301191606010	SSP0601	301191606420	SSP0642	301191606830	SSP0683
301191606020	SSP0602	301191606430	SSP0643	301191606840	SSP0684
301191606030	SSP0603	301191606440	SSP0644	301191606850	SSP0685
301191606040	SSP0604	301191606450	SSP0645	301191606860	SSP0686
301191606050	SSP0605	301191606460	SSP0646	301191606870	SSP0687
301191606060	SSP0606	301191606470	SSP0647	301191606880	SSP0688
301191606070	SSP0607	301191606480	SSP0648	301191606890	SSP0689
301191606080	SSP0608	301191606490	SSP0649	301191606900	SSP0690
301191606090	SSP0609	301191606500	SSP0650	301191606910	SSP0691
301191606100	SSP0610	301191606510	SSP0651	301191606920	SSP0692
301191606110	SSP0611	301191606520	SSP0652	301191606930	SSP0693
301191606120	SSP0612	301191606530	SSP0653	301191606940	SSP0694
301191606130	SSP0613	301191606540	SSP0654	301191606950	SSP0695
301191606140	SSP0614	301191606550	SSP0655	301191606960	SSP0696
301191606150	SSP0615	301191606560	SSP0656	301191606970	SSP0697
301191606160	SSP0616	301191606570	SSP0657	301191606980	SSP0698
301191606170	SSP0617	301191606580	SSP0658	301191606990	SSP0699
301191606180	SSP0618	301191606590	SSP0659	301191607000	SSP0700
301191606190	SSP0619	301191606600	SSP0660	301191607010	SSP0701
301191606200	SSP0620	301191606610	SSP0661	301191607020	SSP0702
301191606210	SSP0621	301191606620	SSP0662	301191607030	SSP0703
301191606220	SSP0622	301191606630	SSP0663	301191607040	SSP0704
301191606230	SSP0623	301191606640	SSP0664	301191607050	SSP0705
301191606240	SSP0624	301191606650	SSP0665	301191607060	SSP0706
301191606250	SSP0625	301191606660	SSP0666	301191607070	SSP0707
301191606260	SSP0626	301191606670	SSP0667	301191607080	SSP0708
301191606270	SSP0627	301191606680	SSP0668	301191607090	SSP0709
301191606280	SSP0628	301191606690	SSP0669	301191607100	SSP0710
301191606290	SSP0629	301191606700	SSP0670	301191607110	SSP0711
301191606300	SSP0630	301191606710	SSP0671	301191607120	SSP0712



LONG	SHORT	LONG	SHORT	LONG	SHORT
301191607130	SSP0713	301181312960	SSP1296	301181313430	SSP1343
301191607140	SSP0714	301181312970	SSP1297	301181313440	SSP1344
301191607150	SSP0715	301181312980	SSP1298	301181313450	SSP1345
301191607160	SSP0716	301181312990	SSP1299	301181313460	SSP1346
301191607170	SSP0717	301181313010	SSP1301	301181313470	SSP1347
301191607180	SSP0718	301181313020	SSP1302	301181313480	SSP1348
301181311810	SSP1181	301181313040	SSP1304	301181313490	SSP1349
301181311820	SSP1182	301181313050	SSP1305	301181313510	SSP1351
301181311830	SSP1183	301181313060	SSP1306	301181313520	SSP1352
301181311840	SSP1184	301181313070	SSP1307	301181313530	SSP1353
301181311850	SSP1185	301181313080	SSP1308	301181313540	SSP1354
301181311860	SSP1186	301181313090	SSP1309	301181313550	SSP1355
301181311870	SSP1187	301181313110	SSP1311	301181313560	SSP1356
301181311880	SSP1188	301181313120	SSP1312	301181313570	SSP1357
301181311890	SSP1189	301181313130	SSP1313	301181313580	SSP1358
301181311910	SSP1191	301181313140	SSP1314	301181313590	SSP1359
301181311920	SSP1192	301181313150	SSP1315	301181313610	SSP1361
301181311930	SSP1193	301181313160	SSP1316	301181313620	SSP1362
301181311940	SSP1194	301181313170	SSP1317	301181313630	SSP1363
301181311950	SSP1195	301181313180	SSP1318	301181313640	SSP1364
301181311960	SSP1196	301181313190	SSP1319	301181313650	SSP1365
301181311970	SSP1197	301181313210	SSP1321	301181313660	SSP1366
301181311980	SSP1198	301181313220	SSP1322	301181313670	SSP1367
301181311990	SSP1199	301181313230	SSP1323	301181313680	SSP1368
301181312010	SSP1201	301181313240	SSP1324	301181313690	SSP1369
301181312020	SSP1202	301181313250	SSP1325	301181313710	SSP1371
301181312030	SSP1203	301181313260	SSP1326	301181313720	SSP1372
301181312040	SSP1204	301181313270	SSP1327	301181313730	SSP1373
301181312050	SSP1205	301181313280	SSP1328	301181313740	SSP1374
301181312060	SSP1206	301181313290	SSP1329	301181313750	SSP1375
301181312070	SSP1207	301181313310	SSP1331	301181313760	SSP1376
301181312080	SSP1208	301181313320	SSP1332	301181313770	SSP1377
301181312090	SSP1209	301181313330	SSP1333	301181313780	SSP1378
301181312870	SSP1287	301181313340	SSP1334	301181313790	SSP1379
301181312880	SSP1288	301181313350	SSP1335	301181313810	SSP1381
301181312890	SSP1289	301181313360	SSP1336	301181313820	SSP1382
301181312910	SSP1291	301181313370	SSP1337	301181313830	SSP1383
301181312920	SSP1292	301181313380	SSP1338	301181313840	SSP1384
301181312930	SSP1293	301181313390	SSP1339	301181313850	SSP1385
301181312940	SSP1294	301181313410	SSP1341	301181313860	SSP1386
301181312950	SSP1295	301181313420	SSP1342	301181313870	SSP1387





MAGNETI MARELLI		MAGNETI MARELLI		MAGNETI MARELLI	
LONG	SHORT	LONG	SHORT	LONG	SHORT
301181313880	SSP1388	301181314340	SSP1434	301191617970	SSP1797
301181313890	SSP1389	301181314350	SSP1435	301191617980	SSP1798
301181313910	SSP1391	301181314360	SSP1436	301191617990	SSP1799
301181313920	SSP1392	301181314370	SSP1437	301191618000	SSP1800
301181313930	SSP1393	301181314380	SSP1438	301191618010	SSP1801
301181313940	SSP1394	301181314390	SSP1439	301191618020	SSP1802
301181313950	SSP1395	301181314410	SSP1441	301191618030	SSP1803
301181313960	SSP1396	301181314420	SSP1442	301191618040	SSP1804
301181313970	SSP1397	301181314430	SSP1443	301191618050	SSP1805
301181313980	SSP1398	301181314440	SSP1444	301191618060	SSP1806
301181313990	SSP1399	301181314450	SSP1445	301191618070	SSP1807
301181314010	SSP1401	301181314460	SSP1446	301191618080	SSP1808
301181314020	SSP1402	301181314470	SSP1447	301191618090	SSP1809
301181314030	SSP1403	301181314480	SSP1448	301191618100	SSP1810
301181314040	SSP1404	301181314490	SSP1449	301191618110	SSP1811
301181314050	SSP1405	301181314510	SSP1451	301191618120	SSP1812
301181314060	SSP1406	301181314520	SSP1452	301191618130	SSP1813
301181314070	SSP1407	301191617730	SSP1773	301191618140	SSP1814
301181314080	SSP1408	301191617740	SSP1774	301191618150	SSP1815
301181314090	SSP1409	301191617750	SSP1775	301191618160	SSP1816
301181314110	SSP1411	301191617760	SSP1776	301191618170	SSP1817
301181314120	SSP1412	301191617770	SSP1777	301191618180	SSP1818
301181314130	SSP1413	301191617780	SSP1778	301191618190	SSP1819
301181314140	SSP1414	301191617790	SSP1779	301191618200	SSP1820
301181314150	SSP1415	301191617800	SSP1780	301191618210	SSP1821
301181314160	SSP1416	301191617810	SSP1781	301191618220	SSP1822
301181314170	SSP1417	301191617820	SSP1782	301191618230	SSP1823
301181314180	SSP1418	301191617830	SSP1783	301191618240	SSP1824
301181314190	SSP1419	301191617840	SSP1784	301191618250	SSP1825
301181314210	SSP1421	301191617850	SSP1785	301191618260	SSP1826
301181314220	SSP1422	301191617860	SSP1786	301191618270	SSP1827
301181314230	SSP1423	301191617870	SSP1787	301191618280	SSP1828
301181314240	SSP1424	301191617880	SSP1788	301191618290	SSP1829
301181314250	SSP1425	301191617890	SSP1789	301191618300	SSP1830
301181314260	SSP1426	301191617900	SSP1790	301191618310	SSP1831
301181314270	SSP1427	301191617910	SSP1791	301191618320	SSP1832
301181314280	SSP1428	301191617920	SSP1792	301191618330	SSP1833
301181314290	SSP1429	301191617930	SSP1793	301191618340	SSP1834
301181314310	SSP1431	301191617940	SSP1794	301191618350	SSP1835
301181314320	SSP1432	301191617950	SSP1795	301191618360	SSP1836
301181314330	SSP1433	301191617960	SSP1796	301191618370	SSP1837



LONG	SHORT	LONG	SHORT	LONG	SHORT
301191618380	SSP1838	301191618790	SSP1879	301191619200	SSP1920
301191618390	SSP1839	301191618800	SSP1880	301191619210	SSP1921
301191618400	SSP1840	301191618810	SSP1881	301191619220	SSP1922
301191618410	SSP1841	301191618820	SSP1882	301191619230	SSP1923
301191618420	SSP1842	301191618830	SSP1883	301191619240	SSP1924
301191618430	SSP1843	301191618840	SSP1884	301191619250	SSP1925
301191618440	SSP1844	301191618850	SSP1885	301191619260	SSP1926
301191618450	SSP1845	301191618860	SSP1886	301191619270	SSP1927
301191618460	SSP1846	301191618870	SSP1887	301191619280	SSP1928
301191618470	SSP1847	301191618880	SSP1888	301191619290	SSP1929
301191618480	SSP1848	301191618890	SSP1889	301191619300	SSP1930
301191618490	SSP1849	301191618900	SSP1890	301191619310	SSP1931
301191618500	SSP1850	301191618910	SSP1891	301191619320	SSP1932
301191618510	SSP1851	301191618920	SSP1892	301191619330	SSP1933
301191618520	SSP1852	301191618930	SSP1893	301191619340	SSP1934
301191618530	SSP1853	301191618940	SSP1894	301191619350	SSP1935
301191618540	SSP1854	301191618950	SSP1895	301191619360	SSP1936
301191618550	SSP1855	301191618960	SSP1896	301191619370	SSP1937
301191618560	SSP1856	301191618970	SSP1897	301191619380	SSP1938
301191618570	SSP1857	301191618980	SSP1898	301191619390	SSP1939
301191618580	SSP1858	301191618990	SSP1899	301191619400	SSP1940
301191618590	SSP1859	301191619000	SSP1900	301191619410	SSP1941
301191618600	SSP1860	301191619010	SSP1901	301191619420	SSP1942
301191618610	SSP1861	301191619020	SSP1902	301191619430	SSP1943
301191618620	SSP1862	301191619030	SSP1903	301191619440	SSP1944
301191618630	SSP1863	301191619040	SSP1904	301191619450	SSP1945
301191618640	SSP1864	301191619050	SSP1905	301191619460	SSP1946
301191618650	SSP1865	301191619060	SSP1906	301191619470	SSP1947
301191618660	SSP1866	301191619070	SSP1907	301191619480	SSP1948
301191618670	SSP1867	301191619080	SSP1908	301191619490	SSP1949
301191618680	SSP1868	301191619090	SSP1909	301191619500	SSP1950
301191618690	SSP1869	301191619100	SSP1910	301191619510	SSP1951
301191618700	SSP1870	301191619110	SSP1911	301191619520	SSP1952
301191618710	SSP1871	301191619120	SSP1912	301191619530	SSP1953
301191618720	SSP1872	301191619130	SSP1913	301191619540	SSP1954
301191618730	SSP1873	301191619140	SSP1914	301191619550	SSP1955
301191618740	SSP1874	301191619150	SSP1915	301191619560	SSP1956
301191618750	SSP1875	301191619160	SSP1916	301191619570	SSP1957
301191618760	SSP1876	301191619170	SSP1917	301191619580	SSP1958
301191618770	SSP1877	301191619180	SSP1918	301191619590	SSP1959
301191618780	SSP1878	301191619190	SSP1919	301191619600	SSP1960



 LONG SHORT		 LONG SHORT		 LONG SHORT	
301191619610	SSP1961	301191620020	SSP2002	301191620440	SSP2044
301191619620	SSP1962	301191620030	SSP2003	301191620450	SSP2045
301191619630	SSP1963	301191620040	SSP2004	301191620460	SSP2046
301191619640	SSP1964	301191620050	SSP2005	301191620470	SSP2047
301191619650	SSP1965	301191620060	SSP2006	301191620480	SSP2048
301191619660	SSP1966	301191620070	SSP2007	301191620490	SSP2049
301191619670	SSP1967	301191620080	SSP2008	301191620500	SSP2050
301191619680	SSP1968	301191620090	SSP2009	301191620510	SSP2051
301191619690	SSP1969	301191620100	SSP2010	301191620520	SSP2052
301191619700	SSP1970	301191620110	SSP2011	301191620530	SSP2053
301191619710	SSP1971	301191620120	SSP2012	301191620540	SSP2054
301191619720	SSP1972	301191620130	SSP2013	301191620550	SSP2055
301191619730	SSP1973	301191620140	SSP2014	301191620560	SSP2056
301191619740	SSP1974	301191620150	SSP2015	301191620570	SSP2057
301191619750	SSP1975	301191620160	SSP2016	301191620580	SSP2058
301191619760	SSP1976	301191620170	SSP2017	301191620590	SSP2059
301191619770	SSP1977	301191620180	SSP2018	301191620600	SSP2060
301191619780	SSP1978	301191620190	SSP2019	301191620610	SSP2061
301191619790	SSP1979	301191620200	SSP2020	301191620620	SSP2062
301191619800	SSP1980	301191620210	SSP2021	301191620630	SSP2063
301191619810	SSP1981	301191620220	SSP2022	301191620640	SSP2064
301191619820	SSP1982	301191620230	SSP2023	301191620650	SSP2065
301191619830	SSP1983	301191620240	SSP2024	301191620660	SSP2066
301191619840	SSP1984	301191620250	SSP2025	301191620670	SSP2067
301191619850	SSP1985	301191620270	SSP2027	301191620680	SSP2068
301191619860	SSP1986	301191620280	SSP2028	301191620690	SSP2069
301191619870	SSP1987	301191620290	SSP2029	301191620700	SSP2070
301191619880	SSP1988	301191620300	SSP2030	301191620710	SSP2071
301191619890	SSP1989	301191620310	SSP2031	301191620720	SSP2072
301191619900	SSP1990	301191620320	SSP2032	301191620730	SSP2073
301191619910	SSP1991	301191620330	SSP2033	301191620740	SSP2074
301191619920	SSP1992	301191620340	SSP2034	301191620750	SSP2075
301191619930	SSP1993	301191620350	SSP2035	301191620760	SSP2076
301191619940	SSP1994	301191620360	SSP2036	301191620770	SSP2077
301191619950	SSP1995	301191620370	SSP2037	301191620780	SSP2078
301191619960	SSP1996	301191620380	SSP2038	301191620790	SSP2079
301191619970	SSP1997	301191620390	SSP2039	301191620800	SSP2080
301191619980	SSP1998	301191620400	SSP2040	301191620810	SSP2081
301191619990	SSP1999	301191620410	SSP2041	301191620820	SSP2082
301191620000	SSP2000	301191620420	SSP2042	301191620830	SSP2083
301191620010	SSP2001	301191620430	SSP2043	301191620840	SSP2084



LONG	SHORT	LONG	SHORT	LONG	SHORT
301191620850	SSP2085	301191621260	SSP2126	301191621670	SSP2167
301191620860	SSP2086	301191621270	SSP2127	301191621680	SSP2168
301191620870	SSP2087	301191621280	SSP2128	301191621690	SSP2169
301191620880	SSP2088	301191621290	SSP2129	301191621700	SSP2170
301191620890	SSP2089	301191621300	SSP2130	301191621710	SSP2171
301191620900	SSP2090	301191621310	SSP2131	301191621720	SSP2172
301191620910	SSP2091	301191621320	SSP2132	301191621730	SSP2173
301191620920	SSP2092	301191621330	SSP2133	301191621740	SSP2174
301191620930	SSP2093	301191621340	SSP2134	301191621750	SSP2175
301191620940	SSP2094	301191621350	SSP2135	301191621760	SSP2176
301191620950	SSP2095	301191621360	SSP2136	301191621770	SSP2177
301191620960	SSP2096	301191621370	SSP2137	301191621780	SSP2178
301191620970	SSP2097	301191621380	SSP2138	301191621790	SSP2179
301191620980	SSP2098	301191621390	SSP2139	301191621800	SSP2180
301191620990	SSP2099	301191621400	SSP2140	301191621810	SSP2181
301191621000	SSP2100	301191621410	SSP2141	301191621820	SSP2182
301191621010	SSP2101	301191621420	SSP2142	301191621830	SSP2183
301191621020	SSP2102	301191621430	SSP2143	301191621840	SSP2184
301191621030	SSP2103	301191621440	SSP2144	301191621850	SSP2185
301191621040	SSP2104	301191621450	SSP2145	301191621860	SSP2186
301191621050	SSP2105	301191621460	SSP2146	301191621870	SSP2187
301191621060	SSP2106	301191621470	SSP2147	301191621880	SSP2188
301191621070	SSP2107	301191621480	SSP2148	301191621890	SSP2189
301191621080	SSP2108	301191621490	SSP2149	301191621900	SSP2190
301191621090	SSP2109	301191621500	SSP2150	301191621910	SSP2191
301191621100	SSP2110	301191621510	SSP2151	301191621920	SSP2192
301191621110	SSP2111	301191621520	SSP2152	301191621930	SSP2193
301191621120	SSP2112	301191621530	SSP2153	301191621940	SSP2194
301191621130	SSP2113	301191621540	SSP2154	301191621950	SSP2195
301191621140	SSP2114	301191621550	SSP2155	301191621960	SSP2196
301191621150	SSP2115	301191621560	SSP2156	301191621970	SSP2197
301191621160	SSP2116	301191621570	SSP2157	301191621980	SSP2198
301191621170	SSP2117	301191621580	SSP2158	301191621990	SSP2199
301191621180	SSP2118	301191621590	SSP2159	301191622000	SSP2200
301191621190	SSP2119	301191621600	SSP2160	301191622010	SSP2201
301191621200	SSP2120	301191621610	SSP2161	301191622020	SSP2202
301191621210	SSP2121	301191621620	SSP2162	301191622030	SSP2203
301191621220	SSP2122	301191621630	SSP2163	301191622040	SSP2204
301191621230	SSP2123	301191621640	SSP2164	301191622050	SSP2205
301191621240	SSP2124	301191621650	SSP2165	301191622060	SSP2206
301191621250	SSP2125	301191621660	SSP2166	301191622070	SSP2207



MAGNETI MARELLI		MAGNETI MARELLI		MAGNETI MARELLI	
LONG	SHORT	LONG	SHORT	LONG	SHORT
301191622080	SSP2208	301191622490	SSP2249	301191622900	SSP2290
301191622090	SSP2209	301191622500	SSP2250	301191622910	SSP2291
301191622100	SSP2210	301191622510	SSP2251	301191622920	SSP2292
301191622110	SSP2211	301191622520	SSP2252	301191622930	SSP2293
301191622120	SSP2212	301191622530	SSP2253	301191622940	SSP2294
301191622130	SSP2213	301191622540	SSP2254	301191622950	SSP2295
301191622140	SSP2214	301191622550	SSP2255	301191622960	SSP2296
301191622150	SSP2215	301191622560	SSP2256	301191622970	SSP2297
301191622160	SSP2216	301191622570	SSP2257	301191622980	SSP2298
301191622170	SSP2217	301191622580	SSP2258	301191622990	SSP2299
301191622180	SSP2218	301191622590	SSP2259	301191623000	SSP2300
301191622190	SSP2219	301191622600	SSP2260	301191623010	SSP2301
301191622200	SSP2220	301191622610	SSP2261	301191623020	SSP2302
301191622210	SSP2221	301191622620	SSP2262	301191623030	SSP2303
301191622220	SSP2222	301191622630	SSP2263	301191623040	SSP2304
301191622230	SSP2223	301191622640	SSP2264	301191623050	SSP2305
301191622240	SSP2224	301191622650	SSP2265	301191623060	SSP2306
301191622250	SSP2225	301191622660	SSP2266	301191623070	SSP2307
301191622260	SSP2226	301191622670	SSP2267	301191623080	SSP2308
301191622270	SSP2227	301191622680	SSP2268	301191623090	SSP2309
301191622280	SSP2228	301191622690	SSP2269	301191623100	SSP2310
301191622290	SSP2229	301191622700	SSP2270	301191623110	SSP2311
301191622300	SSP2230	301191622710	SSP2271	301191623120	SSP2312
301191622310	SSP2231	301191622720	SSP2272	301191623130	SSP2313
301191622320	SSP2232	301191622730	SSP2273	301191623140	SSP2314
301191622330	SSP2233	301191622740	SSP2274	301191623150	SSP2315
301191622340	SSP2234	301191622750	SSP2275	301191623160	SSP2316
301191622350	SSP2235	301191622760	SSP2276	301191623170	SSP2317
301191622360	SSP2236	301191622770	SSP2277	301191623180	SSP2318
301191622370	SSP2237	301191622780	SSP2278	301191623190	SSP2319
301191622380	SSP2238	301191622790	SSP2279	301191623200	SSP2320
301191622390	SSP2239	301191622800	SSP2280	301191623210	SSP2321
301191622400	SSP2240	301191622810	SSP2281	301191623220	SSP2322
301191622410	SSP2241	301191622820	SSP2282	301191623230	SSP2323
301191622420	SSP2242	301191622830	SSP2283	301191623240	SSP2324
301191622430	SSP2243	301191622840	SSP2284	301191623250	SSP2325
301191622440	SSP2244	301191622850	SSP2285	301191623260	SSP2326
301191622450	SSP2245	301191622860	SSP2286	301191623270	SSP2327
301191622460	SSP2246	301191622870	SSP2287	301191623280	SSP2328
301191622470	SSP2247	301191622880	SSP2288	301191623290	SSP2329
301191622480	SSP2248	301191622890	SSP2289	301191623300	SSP2330



LONG	SHORT	LONG	SHORT	LONG	SHORT
301191623310	SSP2331	301191623720	SSP2372	301191624130	SSP2413
301191623320	SSP2332	301191623730	SSP2373	301191624140	SSP2414
301191623330	SSP2333	301191623740	SSP2374	301191624150	SSP2415
301191623340	SSP2334	301191623750	SSP2375	301191624160	SSP2416
301191623350	SSP2335	301191623760	SSP2376	301191624170	SSP2417
301191623360	SSP2336	301191623770	SSP2377	301191624180	SSP2418
301191623370	SSP2337	301191623780	SSP2378	301191624190	SSP2419
301191623380	SSP2338	301191623790	SSP2379	301191624200	SSP2420
301191623390	SSP2339	301191623800	SSP2380	301191624210	SSP2421
301191623400	SSP2340	301191623810	SSP2381	301191624220	SSP2422
301191623410	SSP2341	301191623820	SSP2382	301191624230	SSP2423
301191623420	SSP2342	301191623830	SSP2383	301191624240	SSP2424
301191623430	SSP2343	301191623840	SSP2384	301191624250	SSP2425
301191623440	SSP2344	301191623850	SSP2385	301191624260	SSP2426
301191623450	SSP2345	301191623860	SSP2386	301191624270	SSP2427
301191623460	SSP2346	301191623870	SSP2387	301191624280	SSP2428
301191623470	SSP2347	301191623880	SSP2388	301191624290	SSP2429
301191623480	SSP2348	301191623890	SSP2389	301191624300	SSP2430
301191623490	SSP2349	301191623900	SSP2390	301191624310	SSP2431
301191623500	SSP2350	301191623910	SSP2391	301191624320	SSP2432
301191623510	SSP2351	301191623920	SSP2392	301191624330	SSP2433
301191623520	SSP2352	301191623930	SSP2393	301191624340	SSP2434
301191623530	SSP2353	301191623940	SSP2394	301191624350	SSP2435
301191623540	SSP2354	301191623950	SSP2395	301191624360	SSP2436
301191623550	SSP2355	301191623960	SSP2396	301191624370	SSP2437
301191623560	SSP2356	301191623970	SSP2397	301191624380	SSP2438
301191623570	SSP2357	301191623980	SSP2398	301191624390	SSP2439
301191623580	SSP2358	301191623990	SSP2399	301191624400	SSP2440
301191623590	SSP2359	301191624000	SSP2400	301191624410	SSP2441
301191623600	SSP2360	301191624010	SSP2401	301191624420	SSP2442
301191623610	SSP2361	301191624020	SSP2402	301191624430	SSP2443
301191623620	SSP2362	301191624030	SSP2403	301191624440	SSP2444
301191623630	SSP2363	301191624040	SSP2404	301191624450	SSP2445
301191623640	SSP2364	301191624050	SSP2405	301191624460	SSP2446
301191623650	SSP2365	301191624060	SSP2406	301191624470	SSP2447
301191623660	SSP2366	301191624070	SSP2407	301191624480	SSP2448
301191623670	SSP2367	301191624080	SSP2408	301191624490	SSP2449
301191623680	SSP2368	301191624090	SSP2409	301191624500	SSP2450
301191623690	SSP2369	301191624100	SSP2410	301191624510	SSP2451
301191623700	SSP2370	301191624110	SSP2411	301191624520	SSP2452
301191623710	SSP2371	301191624120	SSP2412	301191624530	SSP2453



MAGNETI MARELLI		MAGNETI MARELLI		MAGNETI MARELLI	
LONG	SHORT	LONG	SHORT	LONG	SHORT
301191624540	SSP2454	301191624950	SSP2495	301191625360	SSP2536
301191624550	SSP2455	301191624960	SSP2496	301191625370	SSP2537
301191624560	SSP2456	301191624970	SSP2497	301191625380	SSP2538
301191624570	SSP2457	301191624980	SSP2498	301191625390	SSP2539
301191624580	SSP2458	301191624990	SSP2499	301191625400	SSP2540
301191624590	SSP2459	301191625000	SSP2500	301191625410	SSP2541
301191624600	SSP2460	301191625010	SSP2501	301191625420	SSP2542
301191624610	SSP2461	301191625020	SSP2502	301191625430	SSP2543
301191624620	SSP2462	301191625030	SSP2503	301191625440	SSP2544
301191624630	SSP2463	301191625040	SSP2504	301191625450	SSP2545
301191624640	SSP2464	301191625050	SSP2505	301191625460	SSP2546
301191624650	SSP2465	301191625060	SSP2506	301191625470	SSP2547
301191624660	SSP2466	301191625070	SSP2507	301191625480	SSP2548
301191624670	SSP2467	301191625080	SSP2508	301191625490	SSP2549
301191624680	SSP2468	301191625090	SSP2509	301191625500	SSP2550
301191624690	SSP2469	301191625100	SSP2510	301191625510	SSP2551
301191624700	SSP2470	301191625110	SSP2511	301191625520	SSP2552
301191624710	SSP2471	301191625120	SSP2512	301191625530	SSP2553
301191624720	SSP2472	301191625130	SSP2513	301191625540	SSP2554
301191624730	SSP2473	301191625140	SSP2514	301191625550	SSP2555
301191624740	SSP2474	301191625150	SSP2515	301191625560	SSP2556
301191624750	SSP2475	301191625160	SSP2516	301191625570	SSP2557
301191624760	SSP2476	301191625170	SSP2517	301191625580	SSP2558
301191624770	SSP2477	301191625180	SSP2518	301191625590	SSP2559
301191624780	SSP2478	301191625190	SSP2519	301191625600	SSP2560
301191624790	SSP2479	301191625200	SSP2520	301191625610	SSP2561
301191624800	SSP2480	301191625210	SSP2521	301191625620	SSP2562
301191624810	SSP2481	301191625220	SSP2522	301191625630	SSP2563
301191624820	SSP2482	301191625230	SSP2523	301191625640	SSP2564
301191624830	SSP2483	301191625240	SSP2524	301191625650	SSP2565
301191624840	SSP2484	301191625250	SSP2525	301191625660	SSP2566
301191624850	SSP2485	301191625260	SSP2526	301191625670	SSP2567
301191624860	SSP2486	301191625270	SSP2527	301191625680	SSP2568
301191624870	SSP2487	301191625280	SSP2528	301191625690	SSP2569
301191624880	SSP2488	301191625290	SSP2529	301191625700	SSP2570
301191624890	SSP2489	301191625300	SSP2530	301191625710	SSP2571
301191624900	SSP2490	301191625310	SSP2531	301191625720	SSP2572
301191624910	SSP2491	301191625320	SSP2532	301191625730	SSP2573
301191624920	SSP2492	301191625330	SSP2533	301191625740	SSP2574
301191624930	SSP2493	301191625340	SSP2534	301191625750	SSP2575
301191624940	SSP2494	301191625350	SSP2535	301191625760	SSP2576



301191625770	SSP2577
301191625780	SSP2578
301191625790	SSP2579
301191625800	SSP2580
301191625810	SSP2581
301191625820	SSP2582
301191625830	SSP2583
301191625840	SSP2584
301191625850	SSP2585
301191625860	SSP2586
301191625870	SSP2587
301191625880	SSP2588
301191625890	SSP2589
301191625900	SSP2590
301191625910	SSP2591
301191625920	SSP2592
301191625930	SSP2593
301191625940	SSP2594
301191625950	SSP2595
301191625960	SSP2596



Applicazione per codice
Buyers guide
Zuordnung nach Bestellnummer
Affectations par références
Aplicación por código
Aplicação por código
Εφαρμογες ανα κωδικο
Zastosowanie dla kodu
Применение для кода
Koda göre araç uygulaması





			DESCRIPTION
SHORT	LONG		
ARM001	301181300100	FIAT CINQUECENTO 1992-1998	Suspension Control Arm and Ball Joint Assembly - Front Right Lower
ARM001	301181300100	FIAT SEICENTO 1998-2007	Suspension Control Arm and Ball Joint Assembly - Front Right Lower
ARM002	301181300200	FIAT CINQUECENTO 1992-1998	Suspension Control Arm and Ball Joint Assembly - Front Left
ARM002	301181300200	FIAT SEICENTO 1998-2007	Suspension Control Arm and Ball Joint Assembly - Front Left
ARM003	301181300300	ALFA ROMEO 147 937 11/2000-03/2010	Suspension Control Arm and Ball Joint Assembly - Front Right Lower
ARM003	301181300300	ALFA ROMEO 156 932 09/1997-05/2006	Suspension Control Arm and Ball Joint Assembly - Front Right Lower
ARM003	301181300300	ALFA ROMEO GT 937 11/2003-09/2010	Suspension Control Arm and Ball Joint Assembly - Front Right Lower
ARM004	301181300400	ALFA ROMEO 147 937 11/2000-03/2010	Suspension Control Arm and Ball Joint Assembly - Front Left Lower
ARM004	301181300400	ALFA ROMEO 156 932 09/1997-05/2006	Suspension Control Arm and Ball Joint Assembly - Front Left Lower
ARM004	301181300400	ALFA ROMEO GT 937 11/2003-09/2010	Suspension Control Arm and Ball Joint Assembly - Front Left Lower
ARM007	301181300700	ALFA ROMEO 145 930 1994-2001	Suspension Control Arm and Ball Joint Assembly - Front Right
ARM007	301181300700	ALFA ROMEO 146 930 1994-2001	Suspension Control Arm and Ball Joint Assembly - Front Right
ARM007	301181300700	ALFA ROMEO 155 167 1992-1998	Suspension Control Arm and Ball Joint Assembly - Front Right
ARM007	301181300700	ALFA ROMEO GTV 167 1992-1998	Suspension Control Arm and Ball Joint Assembly - Front Right
ARM007	301181300700	ALFA ROMEO SPIDER 167 1992-1998	Suspension Control Arm and Ball Joint Assembly - Front Right
ARM007	301181300700	FIAT COUPE FA-175 11/1993-2000	Suspension Control Arm and Ball Joint Assembly - Front Right
ARM007	301181300700	FIAT MAREA 185 06/1996-12/2007	Suspension Control Arm and Ball Joint Assembly - Front Right
ARM007	301181300700	LANCIA DELTA II 1993-2000	Suspension Control Arm and Ball Joint Assembly - Front Right
ARM008	301181300800	ALFA ROMEO 145 930 1994-2001	Suspension Control Arm and Ball Joint Assembly - Front Left Lower
ARM008	301181300800	ALFA ROMEO 146 930 1994-2001	Suspension Control Arm and Ball Joint Assembly - Front Left Lower
ARM008	301181300800	ALFA ROMEO 155 167 1992-1998	Suspension Control Arm and Ball Joint Assembly - Front Left Lower
ARM008	301181300800	ALFA ROMEO GTV 167 1992-1998	Suspension Control Arm and Ball Joint Assembly - Front Left Lower
ARM008	301181300800	ALFA ROMEO SPIDER 167 1992-1998	Suspension Control Arm and Ball Joint Assembly - Front Left Lower
ARM008	301181300800	FIAT COUPE FA-175 11/1993-2000	Suspension Control Arm and Ball Joint Assembly - Front Left Lower
ARM008	301181300800	FIAT MAREA 185 06/1996-12/2007	Suspension Control Arm and Ball Joint Assembly - Front Left Lower





 SHORT LONG			DESCRIPTION
ARM008	301181300800	LANCIA DELTA II 1993-2000	Suspension Control Arm and Ball Joint Assembly - Front Left Lower
ARM017	301181301700	FIAT STILO 192 10/2001-11/2010	Suspension Control Arm and Ball Joint Assembly - Front Right
ARM018	301181301800	FIAT STILO 192 10/2001-11/2010	Suspension Control Arm and Ball Joint Assembly - Front Left
ARM019	301181301900	FIAT MULTIPLA 04/1999-12/2010	Suspension Control Arm and Ball Joint Assembly - Front Right Lower
ARM019	301181301900	LANCIA LYBRA 07/1999-10/2005	Suspension Control Arm and Ball Joint Assembly - Front Right Lower
ARM020	301181302000	FIAT MULTIPLA 04/1999-12/2010	Suspension Control Arm and Ball Joint Assembly - Front Left
ARM020	301181302000	LANCIA LYBRA 07/1999-10/2005	Suspension Control Arm and Ball Joint Assembly - Front Left
ARM023	301181302300	CITROEN JUMPY EVANSION 1995-2003	Suspension Control Arm and Ball Joint Assembly - Front Right Lower
ARM023	301181302300	CITROEN JUMPY II 04/2004-12/2006	Suspension Control Arm and Ball Joint Assembly - Front Right Lower
ARM023	301181302300	FIAT SCUDO 02/1996-08/2002	Suspension Control Arm and Ball Joint Assembly - Front Right Lower
ARM023	301181302300	FIAT ULYSSE 121 06/1994-08/2002	Suspension Control Arm and Ball Joint Assembly - Front Right Lower
ARM023	301181302300	LANCIA Z 2004-2010	Suspension Control Arm and Ball Joint Assembly - Front Right Lower
ARM023	301181302300	PEUGEOT 806 06/1994-08/2002	Suspension Control Arm and Ball Joint Assembly - Front Right Lower
ARM023	301181302300	PEUGEOT EXPERT 224 07/1995-12/2006	Suspension Control Arm and Ball Joint Assembly - Front Right Lower
ARM024	301181302400	CITROEN JUMPY EVANSION 1995-2003	Suspension Control Arm and Ball Joint Assembly - Front Left
ARM024	301181302400	CITROEN JUMPY II 04/2004-12/2006	Suspension Control Arm and Ball Joint Assembly - Front Left
ARM024	301181302400	FIAT SCUDO 02/1996-08/2002	Suspension Control Arm and Ball Joint Assembly - Front Left
ARM024	301181302400	FIAT ULYSSE 121 06/1994-08/2002	Suspension Control Arm and Ball Joint Assembly - Front Left
ARM024	301181302400	LANCIA Z 1994-2003	Suspension Control Arm and Ball Joint Assembly - Front Left
ARM024	301181302400	PEUGEOT 806 06/1994-08/2002	Suspension Control Arm and Ball Joint Assembly - Front Left
ARM024	301181302400	PEUGEOT EXPERT 224 07/1995-12/2006	Suspension Control Arm and Ball Joint Assembly - Front Left
ARM025	301181302500	CITROEN JUMPER I 03/1994-04/2002	Suspension Control Arm - Front Right Lower
ARM025	301181302500	FIAT DUCATO 10Q-14Q-1.8Q 1994-04/2002	Suspension Control Arm - Front Right Lower
ARM025	301181302500	PEUGEOT BOXER (1.4Q-1.8Q) 04/1994-04/2002	Suspension Control Arm - Front Right Lower
ARM026	301181302600	CITROEN JUMPER I 03/1994-04/2002	Suspension Control Arm - Front Left Lower
ARM026	301181302600	FIAT DUCATO 10Q-14Q-1.8Q 1994-04/2002	Suspension Control Arm - Front Left Lower
ARM026	301181302600	PEUGEOT BOXER (1.4Q-1.8Q) 04/1994-04/2002	Suspension Control Arm - Front Left Lower



 SHORT LONG			DESCRIPTION
ARM027	301181302700	CITROEN JUMPER I 03/1994-04/2002	Suspension Control Arm - Front Right Lower
ARM027	301181302700	FIAT DUCATO 10Q-14Q-1.8Q 1994-04/2002	Suspension Control Arm - Front Right Lower
ARM027	301181302700	PEUGEOT BOXER (1.4Q-1.8Q) 04/1994-04/2002	Suspension Control Arm - Front Right Lower
ARM028	301181302800	CITROEN JUMPER I 03/1994-04/2002	Suspension Control Arm - Front Left Lower
ARM028	301181302800	FIAT DUCATO 10Q-14Q-1.8Q 1994-04/2002	Suspension Control Arm - Front Left Lower
ARM028	301181302800	PEUGEOT BOXER (1.4Q-1.8Q) 04/1994-04/2002	Suspension Control Arm - Front Left Lower
ARM035	301181303500	CITROEN C8 07/2002-07/2014	Suspension Control Arm and Ball Joint Assembly - Front Right Lower
ARM035	301181303500	FIAT ULYSSE 179AX 09/2002-2011	Suspension Control Arm and Ball Joint Assembly - Front Right Lower
ARM035	301181303500	LANCIA PHEDRA 09/2002-11/2010	Suspension Control Arm and Ball Joint Assembly - Front Right Lower
ARM035	301181303500	PEUGEOT 807 06/2002-08/2014	Suspension Control Arm and Ball Joint Assembly - Front Right Lower
ARM036	301181303600	CITROEN C8 07/2002-07/2014	Suspension Control Arm and Ball Joint Assembly - Front Left
ARM036	301181303600	FIAT ULYSSE 179AX 09/2002-2011	Suspension Control Arm and Ball Joint Assembly - Front Left
ARM036	301181303600	LANCIA PHEDRA 09/2002-11/2010	Suspension Control Arm and Ball Joint Assembly - Front Left
ARM036	301181303600	PEUGEOT 807 06/2002-08/2014	Suspension Control Arm and Ball Joint Assembly - Front Left
ARM037	301181303700	OPEL AGILA (A) 09/2000-08/2007	Suspension Control Arm and Ball Joint Assembly - Front Lower
ARM037	301181303700	SUBARU JUSTY III 09/2003-12/2006	Suspension Control Arm and Ball Joint Assembly - Front Lower
ARM037	301181303700	SUZUKI IGNIS II 09/2003-07/2008	Suspension Control Arm and Ball Joint Assembly - Front Lower
ARM041	301181304100	FIAT BRAVO & BRAVA 182 1995-2002	Suspension Control Arm and Ball Joint Assembly - Front Right Lower
ARM041	301181304100	FIAT TEMPRA 1988-1997	Suspension Control Arm and Ball Joint Assembly - Front Right Lower
ARM041	301181304100	FIAT TIPO 1987-2000	Suspension Control Arm and Ball Joint Assembly - Front Right Lower
ARM041	301181304100	LANCIA DEDRA 835 1989-1999	Suspension Control Arm and Ball Joint Assembly - Front Right Lower
ARM041	301181304100	LANCIA DELTA II 1993-2000	Suspension Control Arm and Ball Joint Assembly - Front Right Lower
ARM042	301181304200	FIAT BRAVO & BRAVA 182 1995-2002	Suspension Control Arm and Ball Joint Assembly - Front Left
ARM042	301181304200	FIAT TEMPRA 1988-1997	Suspension Control Arm and Ball Joint Assembly - Front Left
ARM042	301181304200	FIAT TIPO 1987-2000	Suspension Control Arm and Ball Joint Assembly - Front Left
ARM042	301181304200	LANCIA DEDRA 835 1989-1999	Suspension Control Arm and Ball Joint Assembly - Front Left
ARM042	301181304200	LANCIA DELTA II 1993-2000	Suspension Control Arm and Ball Joint Assembly - Front Left



 SHORT LONG			DESCRIPTION
ARM058	301181305800	ALFA ROMEO MITO 09/2008-	Suspension Control Arm and Ball Joint Assembly - Front Left Lower
ARM058	301181305800	CITROEN NEMO 2008-	Suspension Control Arm and Ball Joint Assembly - Front Left Lower
ARM058	301181305800	FIAT FIORINO 2008-	Suspension Control Arm and Ball Joint Assembly - Front Left Lower
ARM058	301181305800	FIAT GRANDE PUNTO 199 10/2005-2012	Suspension Control Arm and Ball Joint Assembly - Front Left Lower
ARM058	301181305800	FIAT LINEA 323 06/2007-2016	Suspension Control Arm and Ball Joint Assembly - Front Left Lower
ARM058	301181305800	FIAT PUNTO EVO 07/2008-02/2012	Suspension Control Arm and Ball Joint Assembly - Front Left Lower
ARM058	301181305800	PEUGEOT BIPPER 02/2008-	Suspension Control Arm and Ball Joint Assembly - Front Left Lower
ARM059	301181305900	ALFA ROMEO MITO 09/2008-	Suspension Control Arm and Ball Joint Assembly - Front Right Lower
ARM059	301181305900	CITROEN NEMO 2008-	Suspension Control Arm and Ball Joint Assembly - Front Right Lower
ARM059	301181305900	FIAT FIORINO 2008-	Suspension Control Arm and Ball Joint Assembly - Front Right Lower
ARM059	301181305900	FIAT GRANDE PUNTO 199 10/2005-2012	Suspension Control Arm and Ball Joint Assembly - Front Right Lower
ARM059	301181305900	FIAT LINEA 323 06/2007-2016	Suspension Control Arm and Ball Joint Assembly - Front Right Lower
ARM059	301181305900	FIAT PUNTO EVO 07/2008-02/2012	Suspension Control Arm and Ball Joint Assembly - Front Right Lower
ARM059	301181305900	PEUGEOT BIPPER 02/2008-	Suspension Control Arm and Ball Joint Assembly - Front Right Lower
ARM060	301181306000	ALFA ROMEO 159 939 09/2005-11/2011	Suspension Control Arm and Ball Joint Assembly - Front Left Upper
ARM061	301181306100	ALFA ROMEO 159 939 09/2005-11/2011	Suspension Control Arm and Ball Joint Assembly - Front Right Upper
ARM062	301181306200	ALFA ROMEO 159 939 09/2005-11/2011	Suspension Control Arm and Ball Joint Assembly - Front Left Lower
ARM063	301181306300	ALFA ROMEO 159 939 09/2005-11/2011	Suspension Control Arm and Ball Joint Assembly - Front Right Lower
ARM068	301181306800	FIAT BRAVO II 198 04/2007-	Suspension Control Arm and Ball Joint Assembly - Front Left Lower
ARM068	301181306800	FIAT STILO 192 10/2001-11/2010	Suspension Control Arm and Ball Joint Assembly - Front Left Lower
ARM068	301181306800	LANCIA DELTA III (844) 09/2008-	Suspension Control Arm and Ball Joint Assembly - Front Left Lower
ARM070	301181307000	FIAT BRAVO II 198 04/2007-	Suspension Control Arm and Ball Joint Assembly - Front Right Lower
ARM070	301181307000	FIAT STILO 192 10/2001-11/2010	Suspension Control Arm and Ball Joint Assembly - Front Right Lower
ARM070	301181307000	LANCIA DELTA III (844) 09/2008-	Suspension Control Arm and Ball Joint Assembly - Front Right Lower
ARM073	301181307300	CITROEN JUMPY III 01/2007-	Suspension Control Arm and Ball Joint Assembly - Front Right



			DESCRIPTION
SHORT	LONG		
ARM073	301181307300	FIAT SCUDO 272 01/2007-	Suspension Control Arm and Ball Joint Assembly - Front Right
ARM073	301181307300	PEUGEOT EXPERT 01/2007-	Suspension Control Arm and Ball Joint Assembly - Front Right
ARM074	301181307400	CITROEN JUMPY III 01/2007-	Suspension Control Arm and Ball Joint Assembly - Front Left
ARM074	301181307400	FIAT SCUDO 272 01/2007-	Suspension Control Arm and Ball Joint Assembly - Front Left
ARM074	301181307400	PEUGEOT EXPERT 01/2007-	Suspension Control Arm and Ball Joint Assembly - Front Left
ARM075	301181307500	FIAT IDEA 2003-2012	Suspension Control Arm and Ball Joint Assembly - Front Right Lower
ARM075	301181307500	LANCIA MUSA 350 10/2004-	Suspension Control Arm and Ball Joint Assembly - Front Right Lower
ARM075	301181307500	LANCIA YPSILON 843 10/2003-12/2011	Suspension Control Arm and Ball Joint Assembly - Front Right Lower
ARM076	301181307600	FIAT IDEA 2003-2012	Suspension Control Arm and Ball Joint Assembly - Front Left
ARM076	301181307600	LANCIA MUSA 350 10/2004-	Suspension Control Arm and Ball Joint Assembly - Front Left
ARM076	301181307600	LANCIA YPSILON 843 10/2003-12/2011	Suspension Control Arm and Ball Joint Assembly - Front Left
ARM081	301181308100	FIAT PANDA 169 09/2003-02/2012	Suspension Control Arm and Ball Joint Assembly - Front Right
ARM082	301181308200	FIAT PANDA 169 09/2003-02/2012	Suspension Control Arm and Ball Joint Assembly - Front Left
ARM089	301181308900	FIAT PANDA 169 09/2003-02/2012	Suspension Control Arm and Ball Joint Assembly - Front Right Lower
ARM090	301181309000	FIAT PANDA 169 09/2003-02/2012	Suspension Control Arm and Ball Joint Assembly - Front Left Lower
ARM091	301181309100	CITROEN JUMPER III 06/2006-	Suspension Control Arm - Front Right Lower
ARM091	301181309100	FIAT DUCATO 06/2006-2016	Suspension Control Arm - Front Right Lower
ARM091	301181309100	PEUGEOT BOXER (1.1Q-1.5Q-1.7Q,H-2.0Q) 06/2006-	Suspension Control Arm - Front Right Lower
ARM092	301181309200	CITROEN JUMPER III 06/2006-	Suspension Control Arm - Front Left
ARM092	301181309200	FIAT DUCATO 06/2006-2016	Suspension Control Arm - Front Left
ARM092	301181309200	PEUGEOT BOXER (1.1Q-1.5Q-1.7Q,H-2.0Q) 06/2006-	Suspension Control Arm - Front Left
ARM093	301181309300	CITROEN JUMPER III 06/2006-	Suspension Control Arm - Front Right Lower
ARM093	301181309300	FIAT DUCATO 06/2006-2016	Suspension Control Arm - Front Right Lower
ARM093	301181309300	PEUGEOT BOXER (1.1Q-1.5Q-1.7Q,H-2.0Q) 06/2006-	Suspension Control Arm - Front Right Lower
ARM094	301181309400	CITROEN JUMPER III 06/2006-	Suspension Control Arm - Front Left
ARM094	301181309400	FIAT DUCATO 06/2006-2016	Suspension Control Arm - Front Left
ARM094	301181309400	PEUGEOT BOXER (1.1Q-1.5Q-1.7Q,H-2.0Q) 06/2006-	Suspension Control Arm - Front Left
ARM095	301181309500	FIAT PUNTO 188 10/1999-10/2009	Suspension Control Arm and Ball Joint Assembly - Front Right Lower





 SHORT LONG			DESCRIPTION
ARM096	301181309600	FIAT PUNTO 188 10/1999-10/2009	Suspension Control Arm and Ball Joint Assembly - Front Left
ARM111	301181311100	FIAT ALBEA 178 09/1996-05/2013	Suspension Control Arm and Ball Joint Assembly - Front Right Lower
ARM111	301181311100	FIAT DOBLO 119 03/2001-01/2010	Suspension Control Arm and Ball Joint Assembly - Front Right Lower
ARM111	301181311100	FIAT PALIO - SIENA 04/1996-05/2013	Suspension Control Arm and Ball Joint Assembly - Front Right Lower
ARM111	301181311100	FIAT STRADA 178E 1999-2012	Suspension Control Arm and Ball Joint Assembly - Front Right Lower
ARM112	301181311200	FIAT ALBEA 178 09/1996-05/2013	Suspension Control Arm and Ball Joint Assembly - Front Left Lower
ARM112	301181311200	FIAT DOBLO 119 03/2001-01/2010	Suspension Control Arm and Ball Joint Assembly - Front Left Lower
ARM112	301181311200	FIAT PALIO - SIENA 04/1996-05/2013	Suspension Control Arm and Ball Joint Assembly - Front Left Lower
ARM112	301181311200	FIAT STRADA 178E 1999-2012	Suspension Control Arm and Ball Joint Assembly - Front Left Lower
ARM113	301181311300	FIAT DOBLO 119 03/2001-01/2010	Suspension Control Arm and Ball Joint Assembly - Front Right Lower
ARM114	301181311400	FIAT DOBLO 119 03/2001-01/2010	Suspension Control Arm and Ball Joint Assembly - Front Left Lower
ARM115	301181311500	FIAT DOBLO II 152 02/2010-	Suspension Control Arm and Ball Joint Assembly - Front Right Lower
ARM116	301181311600	FIAT DOBLO II 152 02/2010-	Suspension Control Arm and Ball Joint Assembly - Front Left Lower
ARM117	301181311700	FIAT CROMA 194 1.9DMULTIJET 06/2005-2011	Suspension Control Arm and Ball Joint Assembly - Front Right Lower
ARM117	301181311700	OPEL SIGNUM 03/2003-08/2008	Suspension Control Arm and Ball Joint Assembly - Front Right Lower
ARM117	301181311700	OPEL VECTRA (C) 08/2002-09/2008	Suspension Control Arm and Ball Joint Assembly - Front Right Lower
ARM117	301181311700	SAAB 9_3 2nd Gen 10/2002-01/2009	Suspension Control Arm and Ball Joint Assembly - Front Right Lower
ARM117	301181311700	VAUXHALL VECTRA C 2002-	Suspension Control Arm and Ball Joint Assembly - Front Right Lower
ARM118	301181311800	FIAT CROMA 194 1.9DMULTIJET 06/2005-2011	Suspension Control Arm and Ball Joint Assembly - Front Left Lower
ARM118	301181311800	OPEL SIGNUM 03/2003-08/2008	Suspension Control Arm and Ball Joint Assembly - Front Left Lower
ARM118	301181311800	OPEL VECTRA (C) 08/2002-09/2008	Suspension Control Arm and Ball Joint Assembly - Front Left Lower
ARM118	301181311800	SAAB 9_3 2nd Gen 10/2002-01/2009	Suspension Control Arm and Ball Joint Assembly - Front Left Lower
ARM118	301181311800	VAUXHALL VECTRA C 2002-	Suspension Control Arm and Ball Joint Assembly - Front Left Lower
ARM119	301181311900	ALFA ROMEO 147 937 11/2000-03/2010	Suspension Control Arm and Ball Joint Assembly - Front Right Upper
ARM119	301181311900	ALFA ROMEO 156 932 09/1997-05/2006	Suspension Control Arm and Ball Joint Assembly - Front Right Upper



			DESCRIPTION
SHORT	LONG		
ARM119	301181311900	ALFA ROMEO GT 937 11/2003-09/2010	Suspension Control Arm and Ball Joint Assembly - Front Right Upper
ARM120	301181312000	ALFA ROMEO 147 937 11/2000-03/2010	Suspension Control Arm and Ball Joint Assembly - Front Left Upper
ARM120	301181312000	ALFA ROMEO 156 932 09/1997-05/2006	Suspension Control Arm and Ball Joint Assembly - Front Left Upper
ARM120	301181312000	ALFA ROMEO GT 937 11/2003-09/2010	Suspension Control Arm and Ball Joint Assembly - Front Left Upper
ARM121	301181312100	ALFA ROMEO 147 937 11/2000-03/2010	Lateral Arm - Rear Right
ARM121	301181312100	ALFA ROMEO 156 932 09/1997-05/2006	Lateral Arm - Rear Right
ARM122	301181312200	ALFA ROMEO 147 937 11/2000-03/2010	Lateral Arm - Rear Left
ARM122	301181312200	ALFA ROMEO 156 932 09/1997-05/2006	Lateral Arm - Rear Left
ARM123	301181312300	ALFA ROMEO 159 939 09/2005-11/2011	Suspension Control Arm and Ball Joint Assembly - Front Right Upper
ARM124	301181312400	ALFA ROMEO 159 939 09/2005-11/2011	Suspension Control Arm and Ball Joint Assembly - Front Left Upper
ARM125	301181312500	ALFA ROMEO 166 936 09/1998-06/2007	Suspension Control Arm and Ball Joint Assembly - Front Right
ARM126	301181312600	ALFA ROMEO 166 936 09/1998-06/2007	Suspension Control Arm and Ball Joint Assembly - Front Left
ARM127	301181312700	ALFA ROMEO 166 936 09/1998-06/2007	Suspension Control Arm and Ball Joint Assembly - Front Right Upper
ARM128	301181312800	ALFA ROMEO 166 936 09/1998-06/2007	Suspension Control Arm and Ball Joint Assembly - Front Left Upper
ARM133	301181313300	FIAT ALBEA 178 09/1996-05/2013	Suspension Control Arm and Ball Joint Assembly - Front Right Lower
ARM133	301181313300	FIAT PALIO - SIENA 04/1996-05/2013	Suspension Control Arm and Ball Joint Assembly - Front Right Lower
ARM134	301181313400	FIAT ALBEA 178 09/1996-05/2013	Suspension Control Arm and Ball Joint Assembly - Front Left Lower
ARM134	301181313400	FIAT PALIO - SIENA 04/1996-05/2013	Suspension Control Arm and Ball Joint Assembly - Front Left Lower
ARM135	301181313500	FIAT DOBLO 119 03/2001-01/2010	Suspension Control Arm and Ball Joint Assembly - Front Right Lower
ARM136	301181313600	FIAT DOBLO 119 03/2001-01/2010	Suspension Control Arm and Ball Joint Assembly - Front Left Lower
ARM137	301181313700	DODGE JOURNEY 01/2009-	Suspension Control Arm - Front Right
ARM137	301181313700	FIAT FREEMONT (JC) 08/2011-	Suspension Control Arm - Front Right
ARM138	301181313800	DODGE JOURNEY 01/2009-	Suspension Control Arm - Front Left
ARM138	301181313800	FIAT FREEMONT (JC) 08/2011-	Suspension Control Arm - Front Left
ARM139	301181313900	CHRYSLER GRAND VOYAGER III 01/1995-03/2001	Suspension Control Arm and Ball Joint Assembly - Front Right
ARM139	301181313900	CHRYSLER TOWN & COUNTRY III 1995-2001	Suspension Control Arm and Ball Joint Assembly - Front Right
ARM139	301181313900	DODGE CARAVAN/G. CARAVAN 1995-2001	Suspension Control Arm and Ball Joint Assembly - Front Right
ARM139	301181313900	PLYMOUTH GRAND VOYAGER 3rd Gen 1995-2001	Suspension Control Arm and Ball Joint Assembly - Front Right



 SHORT LONG			DESCRIPTION
ARM139	301181313900	PLYMOUTH VOYAGER 3rd Gen 1995-2001	Suspension Control Arm and Ball Joint Assembly - Front Right
ARM140	301181314000	CHRYSLER GRAND VOYAGER III 01/1995-03/2001	Suspension Control Arm and Ball Joint Assembly - Front Left
ARM140	301181314000	CHRYSLER TOWN & COUNTRY III 1995-2001	Suspension Control Arm and Ball Joint Assembly - Front Left
ARM140	301181314000	DODGE CARAVAN/G. CARAVAN 1995-2001	Suspension Control Arm and Ball Joint Assembly - Front Left
ARM140	301181314000	PLYMOUTH GRAND VOYAGER 3rd Gen 1995-2001	Suspension Control Arm and Ball Joint Assembly - Front Left
ARM140	301181314000	PLYMOUTH VOYAGER 3rd Gen 1995-2001	Suspension Control Arm and Ball Joint Assembly - Front Left
ARM141	301181314100	CHRYSLER GRAND VOYAGER IV 2000-2008	Suspension Control Arm and Ball Joint Assembly - Front Right Lower
ARM142	301181314200	CHRYSLER GRAND VOYAGER IV 2000-2008	Suspension Control Arm and Ball Joint Assembly - Front Left Lower
ARM147	301181314700	FIAT PALIO - SIENA 04/1996-05/2013	Suspension Control Arm and Ball Joint Assembly - Front Right Lower
ARM148	301181314800	FIAT PALIO - SIENA 04/1996-05/2013	Suspension Control Arm and Ball Joint Assembly - Front Left Lower
ARM149	301181314900	FIAT PANDA 141A 1980-08/2003	Suspension Control Arm and Ball Joint Assembly - Front Upper
ARM149	301181314900	LANCIA Y 10 1985-1996	Suspension Control Arm and Ball Joint Assembly - Front Upper
ARM149	301181314900	SEAT MARBELLA 1986-1992	Suspension Control Arm and Ball Joint Assembly - Front Upper
ARM150	301181315000	FIAT PANDA 141A 1980-08/2003	Suspension Control Arm - Front Lower
ARM150	301181315000	LANCIA Y 10 1985-1996	Suspension Control Arm - Front Lower
ARM150	301181315000	SEAT MARBELLA 1992-1998	Suspension Control Arm - Front Lower
ARM151	301181315100	CHRYSLER PT CRUISER 06/2000-12/2010	Suspension Control Arm and Ball Joint Assembly - Front Right Lower
ARM151	301181315100	DODGE NEON 2003-2005	Suspension Control Arm and Ball Joint Assembly - Front Right Lower
ARM152	301181315200	CHRYSLER PT CRUISER 06/2000-12/2010	Suspension Control Arm and Ball Joint Assembly - Front Left Lower
ARM152	301181315200	DODGE NEON 2003-2005	Suspension Control Arm and Ball Joint Assembly - Front Left Lower
ARM153	301181315300	FIAT STILO 192 10/2001-11/2010	Suspension Control Arm and Ball Joint Assembly - Front Right
ARM154	301181315400	FIAT STILO 192 10/2001-11/2010	Suspension Control Arm and Ball Joint Assembly - Front Left
ARM155	301181315500	FIAT TEMPRA 1988-1997	Suspension Control Arm and Ball Joint Assembly - Front Right Lower
ARM155	301181315500	FIAT TIPO 1987-2000	Suspension Control Arm and Ball Joint Assembly - Front Right Lower
ARM156	301181315600	FIAT TEMPRA 1988-1997	Suspension Control Arm and Ball Joint Assembly - Front Left
ARM156	301181315600	FIAT TIPO 1987-2000	Suspension Control Arm and Ball Joint Assembly - Front Left
ARM161	301181316100	AUDI 80 1992-1994	Suspension Control Arm and Ball Joint Assembly - Front Right Lower



 SHORT LONG			DESCRIPTION
ARM161	301181316100	AUDI 90 1992-1994	Suspension Control Arm and Ball Joint Assembly - Front Right Lower
ARM161	301181316100	AUDI CABRIOLET 1991-2000	Suspension Control Arm and Ball Joint Assembly - Front Right Lower
ARM161	301181316100	AUDI COUPE 1982-1988	Suspension Control Arm and Ball Joint Assembly - Front Right Lower
ARM161	301181316100	AUDI COUPE QUATTRO 1988-1995	Suspension Control Arm and Ball Joint Assembly - Front Right Lower
ARM162	301181316200	AUDI 80 1992-1994	Suspension Control Arm and Ball Joint Assembly - Front Left Lower
ARM162	301181316200	AUDI 90 1992-1994	Suspension Control Arm and Ball Joint Assembly - Front Left Lower
ARM162	301181316200	AUDI CABRIOLET 1991-2000	Suspension Control Arm and Ball Joint Assembly - Front Left Lower
ARM162	301181316200	AUDI COUPE 1982-1988	Suspension Control Arm and Ball Joint Assembly - Front Left Lower
ARM162	301181316200	AUDI COUPE 1988-1996	Suspension Control Arm and Ball Joint Assembly - Front Left Lower
ARM162	301181316200	AUDI COUPE QUATTRO 1988-1995	Suspension Control Arm and Ball Joint Assembly - Front Left Lower
ARM163	301181316300	AUDI ALLROAD QUATTRO (4BH,C5) 2000-2005	Suspension Control Arm and Ball Joint Assembly - Front Right Lower Rearward
ARM164	301181316400	AUDI ALLROAD QUATTRO (4BH,C5) 2000-2005	Suspension Control Arm and Ball Joint Assembly - Front Left Lower Rearward
ARM165	301181316500	AUDI ALLROAD QUATTRO (4BH,C5) 2000-2005	Suspension Control Arm and Ball Joint Assembly - Front Lower Forward
ARM166	301181316600	AUDI ALLROAD QUATTRO (4BH,C5) 2000-2005	Suspension Control Arm and Ball Joint Assembly - Front Lower Forward
ARM167	301181316700	AUDI A3 8V1 09/2012-	Suspension Control Arm and Ball Joint Assembly - Front Right Lower
ARM167	301181316700	SKODA OCTAVIA (5 E) 11/2012-	Suspension Control Arm and Ball Joint Assembly - Front Right Lower
ARM168	301181316800	AUDI A3 8V1 09/2012-	Suspension Control Arm and Ball Joint Assembly - Front Left Lower
ARM168	301181316800	SKODA OCTAVIA (5 E) 11/2012-	Suspension Control Arm and Ball Joint Assembly - Front Left Lower
ARM169	301181316900	AUDI A3 8L1 09/1996-05/2003	Lateral Arm - Rear
ARM169	301181316900	AUDI TT 8N3, ROADSTER, 8N9 02/1999-06/2006	Lateral Arm - Rear
ARM169	301181316900	SEAT LEON 1M1 03/1999-05/2006	Lateral Arm - Rear
ARM169	301181316900	SKODA OCTAVIA (1U2), (1U5) 07/1996-05/2004	Lateral Arm - Rear
ARM169	301181316900	VOLKSWAGEN GOLF MK4/A4 1998-09/2003	Lateral Arm - Rear
ARM170	301181317000	AUDI A4 8D2, 8E5, B5 11/1994-10/2001	Suspension Control Arm and Ball Joint Assembly - Front Right Upper Rearward
ARM170	301181317000	AUDI A6 4B, C5 01/1997-01/2005	Suspension Control Arm and Ball Joint Assembly - Front Right Upper Rearward
ARM170	301181317000	AUDI A8 4D2, 4D8 03/1994-09/2002	Suspension Control Arm and Ball Joint Assembly - Front Right Upper Rearward
ARM170	301181317000	VOLKSWAGEN PASSAT B5, B5.5 1997-08/2005	Suspension Control Arm and Ball Joint Assembly - Front Right Upper Rearward





 SHORT LONG			DESCRIPTION
ARM171	301181317100	AUDI A4 8E2, 8E5, B6 12/2001-12/2004	Suspension Control Arm and Ball Joint Assembly - Front Right Upper Rearward
ARM171	301181317100	AUDI A4 8EC, 8ED 11/2004-06/2008	Suspension Control Arm and Ball Joint Assembly - Front Right Upper Rearward
ARM171	301181317100	AUDI A6 4B, C5 01/1997-01/2005	Suspension Control Arm and Ball Joint Assembly - Front Right Upper Rearward
ARM171	301181317100	AUDI A8 4D2, 4D8 03/1994-09/2002	Suspension Control Arm and Ball Joint Assembly - Front Right Upper Rearward
ARM171	301181317100	SKODA SUPERB (3U4) 02/2002-03/2008	Suspension Control Arm and Ball Joint Assembly - Front Right Upper Rearward
ARM171	301181317100	VOLKSWAGEN PASSAT B5, B5.5 1997-08/2005	Suspension Control Arm and Ball Joint Assembly - Front Right Upper Rearward
ARM172	301181317200	AUDI A4 8D2, 8E5, B5 11/1994-10/2001	Suspension Control Arm and Ball Joint Assembly - Front Left Upper Rearward
ARM172	301181317200	AUDI A6 4B, C5 01/1997-01/2005	Suspension Control Arm and Ball Joint Assembly - Front Left Upper Rearward
ARM172	301181317200	AUDI A8 4D2, 4D8 03/1994-09/2002	Suspension Control Arm and Ball Joint Assembly - Front Left Upper Rearward
ARM172	301181317200	VOLKSWAGEN PASSAT B5, B5.5 1997-08/2005	Suspension Control Arm and Ball Joint Assembly - Front Left Upper Rearward
ARM173	301181317300	AUDI A4 8E2, 8E5, B6 12/2001-12/2004	Suspension Control Arm and Ball Joint Assembly - Front Left Upper Rearward
ARM173	301181317300	AUDI A4 8EC, 8ED 11/2004-06/2008	Suspension Control Arm and Ball Joint Assembly - Front Left Upper Rearward
ARM173	301181317300	AUDI A6 4B, C5 01/1997-01/2005	Suspension Control Arm and Ball Joint Assembly - Front Left Upper Rearward
ARM173	301181317300	AUDI A8 4D2, 4D8 03/1994-09/2002	Suspension Control Arm and Ball Joint Assembly - Front Left Upper Rearward
ARM173	301181317300	SKODA SUPERB (3U4) 02/2002-03/2008	Suspension Control Arm and Ball Joint Assembly - Front Left Upper Rearward
ARM173	301181317300	VOLKSWAGEN PASSAT B5, B5.5 1997-08/2005	Suspension Control Arm and Ball Joint Assembly - Front Left Upper Rearward
ARM174	301181317400	AUDI A4 8D2, 8E5, B5 11/1994-10/2001	Suspension Control Arm and Ball Joint Assembly - Front Right Upper Forward
ARM174	301181317400	AUDI A6 4B, C5 01/1997-01/2005	Suspension Control Arm and Ball Joint Assembly - Front Right Upper Forward
ARM174	301181317400	AUDI A8 4D2, 4D8 03/1994-09/2002	Suspension Control Arm and Ball Joint Assembly - Front Right Upper Forward
ARM174	301181317400	VOLKSWAGEN PASSAT B5, B5.5 1997-08/2005	Suspension Control Arm and Ball Joint Assembly - Front Right Upper Forward
ARM175	301181317500	AUDI A4 8E2, 8E5, B6 12/2001-12/2004	Suspension Control Arm and Ball Joint Assembly - Front Right Upper Forward
ARM175	301181317500	AUDI A6 4B, C5 01/1997-01/2005	Suspension Control Arm and Ball Joint Assembly - Front Right Upper Forward
ARM175	301181317500	AUDI A8 4D2, 4D8 03/1994-09/2002	Suspension Control Arm and Ball Joint Assembly - Front Right Upper Forward
ARM175	301181317500	SKODA SUPERB (3U4) 02/2002-03/2008	Suspension Control Arm and Ball Joint Assembly - Front Right Upper Forward
ARM175	301181317500	VOLKSWAGEN PASSAT B5, B5.5 1997-08/2005	Suspension Control Arm and Ball Joint Assembly - Front Right Upper Forward



			DESCRIPTION
SHORT	LONG		
ARM176	301181317600	AUDI A4 8D2, 8E5, B5 11/1994-10/2001	Suspension Control Arm and Ball Joint Assembly - Front Left Upper Forward
ARM176	301181317600	AUDI A6 4B, C5 01/1997-01/2005	Suspension Control Arm and Ball Joint Assembly - Front Left Upper Forward
ARM176	301181317600	AUDI A8 4D2, 4D8 03/1994-09/2002	Suspension Control Arm and Ball Joint Assembly - Front Left Upper Forward
ARM176	301181317600	VOLKSWAGEN PASSAT B5, B5.5 1997-08/2005	Suspension Control Arm and Ball Joint Assembly - Front Left Upper Forward
ARM177	301181317700	AUDI A4 8E2, 8E5, B6 12/2001-12/2004	Suspension Control Arm and Ball Joint Assembly - Front Left Upper Forward
ARM177	301181317700	AUDI A6 4B, C5 01/1997-01/2005	Suspension Control Arm and Ball Joint Assembly - Front Left Upper Forward
ARM177	301181317700	AUDI A8 4D2, 4D8 03/1994-09/2002	Suspension Control Arm and Ball Joint Assembly - Front Left Upper Forward
ARM177	301181317700	SKODA SUPERB (3U4) 02/2002-03/2008	Suspension Control Arm and Ball Joint Assembly - Front Left Upper Forward
ARM177	301181317700	VOLKSWAGEN PASSAT B5, B5.5 1997-08/2005	Suspension Control Arm and Ball Joint Assembly - Front Left Upper Forward
ARM178	301181317800	AUDI A4 8D2, 8E5, B5 11/1994-10/2001	Suspension Control Arm and Ball Joint Assembly - Front Right Lower Rearward
ARM178	301181317800	AUDI A4 8D2, 8E5, B5 11/1994-10/2001	Suspension Control Arm and Ball Joint Assembly - Front Right Lower Rearward
ARM178	301181317800	AUDI A4 8E2, 8E5, B6 12/2001-12/2004	Suspension Control Arm and Ball Joint Assembly - Front Right Lower Rearward
ARM178	301181317800	AUDI A6 4B, C5 01/1997-01/2005	Suspension Control Arm and Ball Joint Assembly - Front Right Lower Rearward
ARM178	301181317800	AUDI A8 4D2, 4D8 03/1994-09/2002	Suspension Control Arm and Ball Joint Assembly - Front Right Lower Rearward
ARM178	301181317800	SKODA SUPERB (3U4) 02/2002-03/2008	Suspension Control Arm and Ball Joint Assembly - Front Right Lower Rearward
ARM178	301181317800	VOLKSWAGEN PASSAT B5, B5.5 1997-08/2005	Suspension Control Arm and Ball Joint Assembly - Front Right Lower Rearward
ARM179	301181317900	AUDI A4 8D2, 8E5, B5 11/1994-10/2001	Suspension Control Arm and Ball Joint Assembly - Front Left Lower
ARM179	301181317900	AUDI A4 8E2, 8E5, B6 12/2001-12/2004	Suspension Control Arm and Ball Joint Assembly - Front Left Lower
ARM179	301181317900	AUDI A6 4B, C5 01/1997-01/2005	Suspension Control Arm and Ball Joint Assembly - Front Left Lower
ARM179	301181317900	AUDI A8 4D2, 4D8 03/1994-09/2002	Suspension Control Arm and Ball Joint Assembly - Front Left Lower
ARM179	301181317900	SKODA SUPERB (3U4) 02/2002-03/2008	Suspension Control Arm and Ball Joint Assembly - Front Left Lower
ARM179	301181317900	VOLKSWAGEN PASSAT B5, B5.5 1997-08/2005	Suspension Control Arm and Ball Joint Assembly - Front Left Lower
ARM180	301181318000	AUDI A4 8D2, 8E5, B5 11/1994-10/2001	Suspension Control Arm and Ball Joint Assembly - Front Lower Forward
ARM180	301181318000	AUDI A4 8EC, 8ED 11/2004-06/2008	Suspension Control Arm and Ball Joint Assembly - Front Lower Forward
ARM180	301181318000	AUDI A6 4B, C5 01/1997-01/2005	Suspension Control Arm and Ball Joint Assembly - Front Lower Forward





 SHORT LONG			DESCRIPTION
ARM180	301181318000	AUDI A8 4D2, 4D8 03/1994-09/2002	Suspension Control Arm and Ball Joint Assembly - Front Lower Forward
ARM180	301181318000	SKODA SUPERB (3U4) 02/2002-03/2008	Suspension Control Arm and Ball Joint Assembly - Front Lower Forward
ARM180	301181318000	VOLKSWAGEN PASSAT B5, B5.5 1997-08/2005	Suspension Control Arm and Ball Joint Assembly - Front Lower Forward
ARM181	301181318100	AUDI A4 8E2, 8E5, B6 12/2001-12/2004	Suspension Control Arm and Ball Joint Assembly - Front Lower Forward
ARM181	301181318100	AUDI A6 4B, C5 01/1997-01/2005	Suspension Control Arm and Ball Joint Assembly - Front Lower Forward
ARM181	301181318100	AUDI A8 4D2, 4D8 03/1994-09/2002	Suspension Control Arm and Ball Joint Assembly - Front Lower Forward
ARM181	301181318100	VOLKSWAGEN PASSAT B5, B5.5 1997-08/2005	Suspension Control Arm and Ball Joint Assembly - Front Lower Forward
ARM182	301181318200	AUDI A3 8L1 09/1996-05/2003	Suspension Control Arm and Ball Joint Assembly - Front Right Lower
ARM182	301181318200	SEAT LEON 1M1 03/1999-05/2006	Suspension Control Arm and Ball Joint Assembly - Front Right Lower
ARM182	301181318200	SEAT TOLEDO II (1M2) 03/1999-05/2006	Suspension Control Arm and Ball Joint Assembly - Front Right Lower
ARM182	301181318200	SKODA OCTAVIA (1U2), (1U5) 07/1996-05/2004	Suspension Control Arm and Ball Joint Assembly - Front Right Lower
ARM182	301181318200	VOLKSWAGEN BEETLE 9C1, 1C1 1998-2010	Suspension Control Arm and Ball Joint Assembly - Front Right Lower
ARM182	301181318200	VOLKSWAGEN GOLF MK4/A4 1998-09/2003	Suspension Control Arm and Ball Joint Assembly - Front Right Lower
ARM182	301181318200	VOLKSWAGEN JETTA MK4/A4 1998-09/2003	Suspension Control Arm and Ball Joint Assembly - Front Right Lower
ARM183	301181318300	AUDI A3 8L1 09/1996-05/2003	Suspension Control Arm and Ball Joint Assembly - Front Left Lower
ARM183	301181318300	SEAT LEON 1M1 03/1999-05/2006	Suspension Control Arm and Ball Joint Assembly - Front Left Lower
ARM183	301181318300	SEAT TOLEDO II (1M2) 03/1999-05/2006	Suspension Control Arm and Ball Joint Assembly - Front Left Lower
ARM183	301181318300	SKODA OCTAVIA (1U2), (1U5) 07/1996-05/2004	Suspension Control Arm and Ball Joint Assembly - Front Left Lower
ARM183	301181318300	VOLKSWAGEN BEETLE 9C1, 1C1 1998-2010	Suspension Control Arm and Ball Joint Assembly - Front Left Lower
ARM183	301181318300	VOLKSWAGEN GOLF MK4/A4 1998-09/2003	Suspension Control Arm and Ball Joint Assembly - Front Left Lower
ARM183	301181318300	VOLKSWAGEN JETTA MK4/A4 1998-09/2003	Suspension Control Arm and Ball Joint Assembly - Front Left Lower
ARM184	301181318400	AUDI A3 8L1 09/1996-05/2003	Suspension Control Arm and Ball Joint Assembly - Front Upper
ARM184	301181318400	AUDI A8 4D2, 4D8 03/1994-09/2002	Suspension Control Arm and Ball Joint Assembly - Front Upper
ARM185	301181318500	AUDI A4 8D2, 8E5, B5 11/1994-10/2001	Lateral Arm - Rear
ARM186	301181318600	AUDI A4 8EC, 8ED 11/2004-06/2008	Lateral Arm - Rear
ARM186	301181318600	AUDI A4 8K2, 8K5 11/2007-06/2015	Lateral Arm - Rear
ARM186	301181318600	SEAT EXEO 2008-2013	Lateral Arm - Rear



 SHORT LONG			DESCRIPTION
ARM187	301181318700	AUDI Q3 8U 06/2011-2016	Lateral Arm - Rear Right Lower
ARM187	301181318700	VOLKSWAGEN TIGUAN 1st Gen 09/2007-2016	Lateral Arm - Rear Right Lower
ARM188	301181318800	AUDI Q3 8U 06/2011-2016	Lateral Arm - Rear Left Lower
ARM188	301181318800	VOLKSWAGEN TIGUAN 1st Gen 09/2007-2016	Lateral Arm - Rear Left Lower
ARM189	301181318900	AUDI A3 8P1 06/2003-08/2012	Lateral Arm - Rear Upper
ARM189	301181318900	AUDI TT 8J3 07/2006-06/2014	Lateral Arm - Rear Upper
ARM189	301181318900	AUDI TT 8N3, ROADSTER, 8N9 02/1999-06/2006	Lateral Arm - Rear Upper
ARM189	301181318900	SKODA OCTAVIA (1Z3), (1Z5) 06/2004-10/2012	Lateral Arm - Rear Upper
ARM189	301181318900	SKODA SUPERB (3T4) 04/2008-	Lateral Arm - Rear Upper
ARM189	301181318900	VOLKSWAGEN EOS 2006-2016	Lateral Arm - Rear Upper
ARM189	301181318900	VOLKSWAGEN GOLF MK5/A5 10/2003-06/2009	Lateral Arm - Rear Upper
ARM189	301181318900	VOLKSWAGEN GTI MK5/A5 2006-2009	Lateral Arm - Rear Upper
ARM189	301181318900	VOLKSWAGEN JETTA IV (162) 11/2010-	Lateral Arm - Rear Upper
ARM189	301181318900	VOLKSWAGEN PASSAT B6 09/2005-07/2010	Lateral Arm - Rear Upper
ARM189	301181318900	VOLKSWAGEN Rabbit MK5/A5 10/2003-06/2009	Lateral Arm - Rear Upper
ARM189	301181318900	VOLKSWAGEN TIGUAN 1st Gen 09/2007-2016	Lateral Arm - Rear Upper
ARM189	301181318900	VOLKSWAGEN TOURAN (1T1,1T2) 02/2003-05/2010	Lateral Arm - Rear Upper
ARM190	301181319000	AUDI A4 8K2, 8K5 11/2007-06/2015	Lateral Arm - Rear Right
ARM190	301181319000	AUDI A5 8T3 2007-2015	Lateral Arm - Rear Right
ARM190	301181319000	AUDI A6 4G2, C5 04/2011-	Lateral Arm - Rear Right
ARM191	301181319100	AUDI A4 8K2, 8K5 11/2007-06/2015	Lateral Arm - Rear Left
ARM191	301181319100	AUDI A5 8T3 2007-2015	Lateral Arm - Rear Left
ARM191	301181319100	AUDI A6 4G2, C5 04/2011-	Lateral Arm - Rear Left
ARM192	301181319200	AUDI A4 8K2, 8K5 11/2007-06/2015	Suspension Control Arm - Front Right Lower Forward
ARM192	301181319200	AUDI A5 8T3 2007-2015	Suspension Control Arm - Front Right Lower Forward
ARM192	301181319200	AUDI Q5 8R 11/2008-2016	Suspension Control Arm - Front Right Lower Forward
ARM193	301181319300	AUDI A4 8K2, 8K5 11/2007-06/2015	Suspension Control Arm - Front Left Lower Forward
ARM193	301181319300	AUDI A5 8T3 2007-2015	Suspension Control Arm - Front Left Lower Forward
ARM193	301181319300	AUDI Q5 8R 11/2008-2016	Suspension Control Arm - Front Left Lower Forward
ARM194	301181319400	AUDI A4 8K2, 8K5 11/2007-06/2015	Suspension Control Arm and Ball Joint Assembly - Front Right Lower Rearward
ARM194	301181319400	AUDI A5 8T3 2007-2015	Suspension Control Arm and Ball Joint Assembly - Front Right Lower Rearward





 SHORT LONG			DESCRIPTION
ARM195	301181319500	AUDI A4 8K2, 8K5 11/2007-06/2015	Suspension Control Arm and Ball Joint Assembly - Front Left Lower Rearward
ARM195	301181319500	AUDI A5 8T3 2007-2015	Suspension Control Arm and Ball Joint Assembly - Front Left Lower Rearward
ARM196	301181319600	AUDI A4 8K2, 8K5 11/2007-06/2015	Suspension Control Arm and Ball Joint Assembly - Front Right Upper Forward
ARM196	301181319600	AUDI A5 8T3 2007-2015	Suspension Control Arm and Ball Joint Assembly - Front Right Upper Forward
ARM196	301181319600	AUDI Q5 8R 11/2008-2016	Suspension Control Arm and Ball Joint Assembly - Front Right Upper Forward
ARM197	301181319700	AUDI A4 8K2, 8K5 11/2007-06/2015	Suspension Control Arm and Ball Joint Assembly - Front Left Upper Forward
ARM197	301181319700	AUDI A5 8T3 2007-2015	Suspension Control Arm and Ball Joint Assembly - Front Left Upper Forward
ARM197	301181319700	AUDI Q5 8R 11/2008-2016	Suspension Control Arm and Ball Joint Assembly - Front Left Upper Forward
ARM198	301181319800	AUDI A4 8K2, 8K5 11/2007-06/2015	Suspension Control Arm and Ball Joint Assembly - Front Right Upper Rearward
ARM198	301181319800	AUDI A5 8T3 2007-2015	Suspension Control Arm and Ball Joint Assembly - Front Right Upper Rearward
ARM198	301181319800	AUDI Q5 8R 11/2008-2016	Suspension Control Arm and Ball Joint Assembly - Front Right Upper Rearward
ARM199	301181319900	AUDI A4 8K2, 8K5 11/2007-06/2015	Suspension Control Arm and Ball Joint Assembly - Front Left Upper Rearward
ARM199	301181319900	AUDI A5 8T3 2007-2015	Suspension Control Arm and Ball Joint Assembly - Front Left Upper Rearward
ARM199	301181319900	AUDI Q5 8R 11/2008-2016	Suspension Control Arm and Ball Joint Assembly - Front Left Upper Rearward
ARM200	301181320000	AUDI A4 8K2, 8K5 11/2007-06/2015	Lateral Arm - Rear Lower Forward
ARM200	301181320000	AUDI A5 8T3 2007-2015	Lateral Arm - Rear Lower Forward
ARM200	301181320000	AUDI A6 4B, C5 01/1997-01/2005	Lateral Arm - Rear Lower Forward
ARM200	301181320000	AUDI A6 4G2, C5 04/2011-	Lateral Arm - Rear Lower Forward
ARM200	301181320000	AUDI A7 4 GA Sportback 10/2010-	Lateral Arm - Rear Lower Forward
ARM200	301181320000	AUDI A8 4H 08/2010-	Lateral Arm - Rear Lower Forward
ARM200	301181320000	AUDI Q5 8R 11/2008-2016	Lateral Arm - Rear Lower Forward
ARM200	301181320000	PORSCHE MACAN 02/2014-	Lateral Arm - Rear Lower Forward
ARM201	301181320100	AUDI TT 8N3, ROADSTER, 8N9 02/1999-06/2006	Suspension Control Arm and Ball Joint Assembly - Front Right Lower
ARM202	301181320200	AUDI TT 8N3, ROADSTER, 8N9 02/1999-06/2006	Suspension Control Arm and Ball Joint Assembly - Front Left Lower
ARM203	301181320300	AUDI A4 8K2, 8K5 11/2007-06/2015	Suspension Control Arm and Ball Joint Assembly - Front Right Lower Rearward
ARM203	301181320300	AUDI A5 8T3 2007-2015	Suspension Control Arm and Ball Joint Assembly - Front Right Lower Rearward
ARM203	301181320300	AUDI Q5 8R 11/2008-2016	Suspension Control Arm and Ball Joint Assembly - Front Right Lower Rearward
ARM204	301181320400	AUDI A4 8K2, 8K5 11/2007-06/2015	Suspension Control Arm and Ball Joint Assembly - Front Left Lower Rearward



 SHORT LONG			DESCRIPTION
ARM204	301181320400	AUDI A5 8T3 2007-2015	Suspension Control Arm and Ball Joint Assembly - Front Left Lower Rearward
ARM204	301181320400	AUDI Q5 8R 11/2008-2016	Suspension Control Arm and Ball Joint Assembly - Front Left Lower Rearward
ARM205	301181320500	AUDI A4 8K2, 8K5 11/2007-06/2015	Suspension Control Arm - Front Right Lower
ARM205	301181320500	AUDI A5 8T3 2007-2015	Suspension Control Arm - Front Right Lower
ARM205	301181320500	AUDI Q5 8R 11/2008-2016	Suspension Control Arm - Front Right Lower
ARM206	301181320600	AUDI A4 8K2, 8K5 11/2007-06/2015	Suspension Control Arm - Front Left Lower
ARM206	301181320600	AUDI A5 8T3 2007-2015	Suspension Control Arm - Front Left Lower
ARM206	301181320600	AUDI Q5 8R 11/2008-2016	Suspension Control Arm - Front Left Lower
ARM207	301181320700	AUDI A6 4F2, C6 02/2005-03/2011	Suspension Control Arm and Ball Joint Assembly - Front Right Upper Rearward
ARM207	301181320700	AUDI A8 4E 10/2002-07/2010	Suspension Control Arm and Ball Joint Assembly - Front Right Upper Rearward
ARM207	301181320700	VOLKSWAGEN PHAETON 04/2002-2016	Suspension Control Arm and Ball Joint Assembly - Front Right Upper Rearward
ARM208	301181320800	AUDI A6 4F2, C6 02/2005-03/2011	Suspension Control Arm and Ball Joint Assembly - Front Left Upper Rearward
ARM208	301181320800	AUDI A8 4E 10/2002-07/2010	Suspension Control Arm and Ball Joint Assembly - Front Left Upper Rearward
ARM208	301181320800	VOLKSWAGEN PHAETON 04/2002-2016	Suspension Control Arm and Ball Joint Assembly - Front Left Upper Rearward
ARM209	301181320900	AUDI A6 4F2, C6 02/2005-03/2011	Suspension Control Arm and Ball Joint Assembly - Front Right Upper Forward
ARM209	301181320900	AUDI A8 4E 10/2002-07/2010	Suspension Control Arm and Ball Joint Assembly - Front Right Upper Forward
ARM209	301181320900	VOLKSWAGEN PHAETON 04/2002-2016	Suspension Control Arm and Ball Joint Assembly - Front Right Upper Forward
ARM210	301181321000	AUDI A6 4F2, C6 02/2005-03/2011	Suspension Control Arm and Ball Joint Assembly - Front Left Upper Forward
ARM210	301181321000	AUDI A8 4E 10/2002-07/2010	Suspension Control Arm and Ball Joint Assembly - Front Left Upper Forward
ARM210	301181321000	VOLKSWAGEN PHAETON 04/2002-2016	Suspension Control Arm and Ball Joint Assembly - Front Left Upper Forward
ARM211	301181321100	AUDI A6 4F2, C6 02/2005-03/2011	Suspension Control Arm and Ball Joint Assembly - Front Right Lower
ARM212	301181321200	AUDI A6 4F2, C6 02/2005-03/2011	Suspension Control Arm and Ball Joint Assembly - Front Left Lower
ARM213	301181321300	AUDI A6 4F2, C6 02/2005-03/2011	Suspension Control Arm and Ball Joint Assembly - Front Lower
ARM214	301181321400	AUDI A4 8E2, 8E5, B6 12/2001-12/2004	Lateral Arm - Rear Right Upper Rearward
ARM214	301181321400	AUDI A4 8EC, 8ED 11/2004-06/2008	Lateral Arm - Rear Right Upper Rearward
ARM214	301181321400	SEAT EXEO 2008-2013	Lateral Arm - Rear Right Upper Rearward
ARM215	301181321500	AUDI A4 8E2, 8E5, B6 12/2001-12/2004	Lateral Arm - Rear Left Upper Rearward
ARM215	301181321500	AUDI A4 8EC, 8ED 11/2004-06/2008	Lateral Arm - Rear Left Upper Rearward
ARM215	301181321500	SEAT EXEO 2008-2013	Lateral Arm - Rear Left Upper Rearward
ARM216	301181321600	AUDI A4 8EC, 8ED 11/2004-06/2008	Suspension Control Arm and Ball Joint Assembly - Front Right Lower Rearward





 SHORT LONG			DESCRIPTION
ARM216	301181321600	SEAT EXEO 2008-2013	Suspension Control Arm and Ball Joint Assembly - Front Right Lower Rearward
ARM217	301181321700	AUDI A4 8EC, 8ED 11/2004-06/2008	Suspension Control Arm and Ball Joint Assembly - Front Left Lower Rearward
ARM217	301181321700	SEAT EXEO 2008-2013	Suspension Control Arm and Ball Joint Assembly - Front Left Lower Rearward
ARM218	301181321800	AUDI A6 4F2, C6 02/2005-03/2011	Lateral Arm - Rear
ARM219	301181321900	AUDI A8 4H 08/2010-	Suspension Control Arm and Ball Joint Assembly - Front Right Upper Forward
ARM220	301181322000	AUDI A8 4H 08/2010-	Suspension Control Arm and Ball Joint Assembly - Front Left Upper Forward
ARM221	301181322100	AUDI A8 4H 08/2010-	Suspension Control Arm and Ball Joint Assembly - Front Right Upper Rearward
ARM222	301181322200	AUDI A8 4H 08/2010-	Suspension Control Arm and Ball Joint Assembly - Front Left Upper Rearward
ARM223	301181322300	AUDI A8 4H 08/2010-	Suspension Control Arm and Ball Joint Assembly - Front Right Lower
ARM224	301181322400	AUDI A8 4H 08/2010-	Suspension Control Arm and Ball Joint Assembly - Front Left Lower
ARM225	301181322500	AUDI A8 4H 08/2010-	Suspension Control Arm - Front Right Lower
ARM226	301181322600	AUDI A8 4H 08/2010-	Suspension Control Arm - Front Left Lower
ARM227	301181322700	AUDI A6 4G2, C5 04/2011-	Suspension Control Arm and Ball Joint Assembly - Front Right Lower
ARM227	301181322700	AUDI A7 4 GA Sportback 10/2010-	Suspension Control Arm and Ball Joint Assembly - Front Right Lower
ARM228	301181322800	AUDI A6 4G2, C5 04/2011-	Suspension Control Arm and Ball Joint Assembly - Front Left Lower
ARM228	301181322800	AUDI A7 4 GA Sportback 10/2010-	Suspension Control Arm and Ball Joint Assembly - Front Left Lower
ARM229	301181322900	AUDI A6 4G2, C5 04/2011-	Suspension Control Arm and Ball Joint Assembly - Front Right Upper Forward
ARM229	301181322900	AUDI A7 4 GA Sportback 10/2010-	Suspension Control Arm and Ball Joint Assembly - Front Right Upper Forward
ARM230	301181323000	AUDI A6 4G2, C5 04/2011-	Suspension Control Arm and Ball Joint Assembly - Front Left Upper Forward
ARM230	301181323000	AUDI A7 4 GA Sportback 10/2010-	Suspension Control Arm and Ball Joint Assembly - Front Left Upper Forward
ARM231	301181323100	AUDI A6 4G2, C5 04/2011-	Suspension Control Arm and Ball Joint Assembly - Front Right Upper Rearward
ARM231	301181323100	AUDI A7 4 GA Sportback 10/2010-	Suspension Control Arm and Ball Joint Assembly - Front Right Upper Rearward
ARM232	301181323200	AUDI A6 4G2, C5 04/2011-	Suspension Control Arm and Ball Joint Assembly - Front Left Upper Rearward
ARM232	301181323200	AUDI A7 4 GA Sportback 10/2010-	Suspension Control Arm and Ball Joint Assembly - Front Left Upper Rearward
ARM233	301181323300	AUDI A6 4G2, C5 04/2011-	Suspension Control Arm - Front Right Lower
ARM233	301181323300	AUDI A7 4 GA Sportback 10/2010-	Suspension Control Arm - Front Right Lower
ARM234	301181323400	AUDI A6 4G2, C5 04/2011-	Suspension Control Arm - Front Left Lower
ARM234	301181323400	AUDI A7 4 GA Sportback 10/2010-	Suspension Control Arm - Front Left Lower



 SHORT LONG			DESCRIPTION
ARM235	301181323500	AUDI A6 4G2, C5 04/2011-	Lateral Arm - Rear Right Upper
ARM236	301181323600	AUDI A6 4G2, C5 04/2011-	Lateral Arm - Rear Left Upper
ARM237	301181323700	AUDI Q7 4L 03/2006-08/2010	Lateral Arm - Rear Right
ARM237	301181323700	PORSCHE CAYENNE 92A 2011-	Lateral Arm - Rear Right
ARM238	301181323800	AUDI Q7 4L 03/2006-08/2010	Lateral Arm - Rear Left
ARM238	301181323800	PORSCHE CAYENNE 92A 2011-	Lateral Arm - Rear Left
ARM239	301181323900	AUDI Q7 4L 03/2006-08/2010	Lateral Arm - Rear Lower
ARM239	301181323900	PORSCHE CAYENNE 92A 2011-	Lateral Arm - Rear Lower
ARM239	301181323900	PORSCHE CAYENNE 955 09/2002-08/2010	Lateral Arm - Rear Lower
ARM239	301181323900	VOLKSWAGEN GOL 2002-2010	Lateral Arm - Rear Lower
ARM239	301181323900	VOLKSWAGEN TOUAREG (7LA,7L6,7L7) 10/2002-05/2010	Lateral Arm - Rear Lower
ARM240	301181324000	AUDI Q7 4L 03/2006-08/2010	Suspension Control Arm and Ball Joint Assembly - Front Right Lower
ARM240	301181324000	PORSCHE CAYENNE 92A 2011-	Suspension Control Arm and Ball Joint Assembly - Front Right Lower
ARM241	301181324100	AUDI Q7 4L 03/2006-08/2010	Suspension Control Arm and Ball Joint Assembly - Front Left Lower
ARM241	301181324100	PORSCHE CAYENNE 92A 2011-	Suspension Control Arm and Ball Joint Assembly - Front Left Lower
ARM242	301181324200	AUDI A8 4E 10/2002-07/2010	Lateral Arm - Rear Lower
ARM242	301181324200	BENTLEY CONTINENTAL (3D) 2005-	Lateral Arm - Rear Lower
ARM242	301181324200	VOLKSWAGEN PHAETON 04/2002-2016	Lateral Arm - Rear Lower
ARM243	301181324300	AUDI A8 4E 10/2002-07/2010	Suspension Control Arm and Ball Joint Assembly - Front Right Lower
ARM243	301181324300	VOLKSWAGEN PHAETON 04/2002-2016	Suspension Control Arm and Ball Joint Assembly - Front Right Lower
ARM244	301181324400	AUDI A8 4E 10/2002-07/2010	Suspension Control Arm and Ball Joint Assembly - Front Left Lower
ARM244	301181324400	VOLKSWAGEN PHAETON 04/2002-2016	Suspension Control Arm and Ball Joint Assembly - Front Left Lower
ARM245	301181324500	AUDI A8 4E 10/2002-07/2010	Suspension Control Arm and Ball Joint Assembly - Front Lower
ARM245	301181324500	VOLKSWAGEN PHAETON 04/2002-2016	Suspension Control Arm and Ball Joint Assembly - Front Lower
ARM246	301181324600	ALFA ROMEO GIULIETTA 940 04/2010-	Suspension Control Arm and Ball Joint Assembly - Front Right Lower
ARM247	301181324700	ALFA ROMEO GIULIETTA 940 04/2010-	Suspension Control Arm and Ball Joint Assembly - Front Left Lower
ARM248	301181324800	BMW 218i Active Tourer F45,F46 09/2014-	Lateral Arm - Rear Upper
ARM248	301181324800	BMW 220i Active Tourer F45,F46 09/2014-	Lateral Arm - Rear Upper
ARM248	301181324800	BMW X1 F48 2015-	Lateral Arm - Rear Upper
ARM248	301181324800	MINI Cooper (F55,F56) 07/2014-	Lateral Arm - Rear Upper
ARM249	301181324900	BMW 120i E81, E82, E87, E88 09/2004-09/2012	Suspension Control Arm and Ball Joint Assembly - Front Right Lower Rearward
ARM249	301181324900	BMW 125i E81, E82, E87, E88 09/2004-09/2012	Suspension Control Arm and Ball Joint Assembly - Front Right Lower Rearward





 SHORT LONG			DESCRIPTION
ARM249	301181324900	BMW 128i E81, E82, E87, E88 09/2004-09/2012	Suspension Control Arm and Ball Joint Assembly - Front Right Lower Rearward
ARM249	301181324900	BMW 130i E81, E82, E87, E88 09/2004-09/2012	Suspension Control Arm and Ball Joint Assembly - Front Right Lower Rearward
ARM249	301181324900	BMW 135i E81, E82, E87, E88 09/2004-09/2012	Suspension Control Arm and Ball Joint Assembly - Front Right Lower Rearward
ARM249	301181324900	BMW 323i E90/E91/E92/E93 01/2005-12/2011	Suspension Control Arm and Ball Joint Assembly - Front Right Lower Rearward
ARM249	301181324900	BMW 325Ci E90/E91/E92/E93 01/2005-12/2011	Suspension Control Arm and Ball Joint Assembly - Front Right Lower Rearward
ARM249	301181324900	BMW 325i E90/E91/E92/E93 01/2005-12/2011	Suspension Control Arm and Ball Joint Assembly - Front Right Lower Rearward
ARM249	301181324900	BMW 328i E90/E91/E92/E93 01/2005-12/2011	Suspension Control Arm and Ball Joint Assembly - Front Right Lower Rearward
ARM249	301181324900	BMW 330Ci E90/E91/E92/E93 01/2005-12/2011	Suspension Control Arm and Ball Joint Assembly - Front Right Lower Rearward
ARM249	301181324900	BMW 330i E90/E91/E92/E93 01/2005-12/2011	Suspension Control Arm and Ball Joint Assembly - Front Right Lower Rearward
ARM249	301181324900	BMW 335d E90/E91/E92/E93 01/2005-12/2011	Suspension Control Arm and Ball Joint Assembly - Front Right Lower Rearward
ARM249	301181324900	BMW 335i E90/E91/E92/E93 01/2005-12/2011	Suspension Control Arm and Ball Joint Assembly - Front Right Lower Rearward
ARM249	301181324900	BMW 335is E90/E91/E92/E93 01/2005-12/2011	Suspension Control Arm and Ball Joint Assembly - Front Right Lower Rearward
ARM249	301181324900	BMW X1 E84 10/2009-2016	Suspension Control Arm and Ball Joint Assembly - Front Right Lower Rearward
ARM250	301181325000	BMW 120i E81, E82, E87, E88 09/2004-09/2012	Suspension Control Arm and Ball Joint Assembly - Front Left Lower Rearward
ARM250	301181325000	BMW 125i E81, E82, E87, E88 09/2004-09/2012	Suspension Control Arm and Ball Joint Assembly - Front Left Lower Rearward
ARM250	301181325000	BMW 128i E81, E82, E87, E88 09/2004-09/2012	Suspension Control Arm and Ball Joint Assembly - Front Left Lower Rearward
ARM250	301181325000	BMW 130i E81, E82, E87, E88 09/2004-09/2012	Suspension Control Arm and Ball Joint Assembly - Front Left Lower Rearward
ARM250	301181325000	BMW 135i E81, E82, E87, E88 09/2004-09/2012	Suspension Control Arm and Ball Joint Assembly - Front Left Lower Rearward
ARM250	301181325000	BMW 323i E90/E91/E92/E93 01/2005-12/2011	Suspension Control Arm and Ball Joint Assembly - Front Left Lower Rearward
ARM250	301181325000	BMW 325Ci E90/E91/E92/E93 01/2005-12/2011	Suspension Control Arm and Ball Joint Assembly - Front Left Lower Rearward
ARM250	301181325000	BMW 325i E90/E91/E92/E93 01/2005-12/2011	Suspension Control Arm and Ball Joint Assembly - Front Left Lower Rearward
ARM250	301181325000	BMW 328i E90/E91/E92/E93 01/2005-12/2011	Suspension Control Arm and Ball Joint Assembly - Front Left Lower Rearward
ARM250	301181325000	BMW 330Ci E90/E91/E92/E93 01/2005-12/2011	Suspension Control Arm and Ball Joint Assembly - Front Left Lower Rearward
ARM250	301181325000	BMW 330i E90/E91/E92/E93 01/2005-12/2011	Suspension Control Arm and Ball Joint Assembly - Front Left Lower Rearward
ARM250	301181325000	BMW 335d E90/E91/E92/E93 01/2005-12/2011	Suspension Control Arm and Ball Joint Assembly - Front Left Lower Rearward



 SHORT LONG			DESCRIPTION
ARM250	301181325000	BMW 335i E90/E91/E92/E93 01/2005-12/2011	Suspension Control Arm and Ball Joint Assembly - Front Left Lower Rearward
ARM250	301181325000	BMW 335is E90/E91/E92/E93 01/2005-12/2011	Suspension Control Arm and Ball Joint Assembly - Front Left Lower Rearward
ARM250	301181325000	BMW X1 E84 10/2009-2016	Suspension Control Arm and Ball Joint Assembly - Front Left Lower Rearward
ARM251	301181325100	BMW 120i E81, E82, E87, E88 09/2004-09/2012	Suspension Control Arm and Ball Joint Assembly - Front Right Lower Forward
ARM251	301181325100	BMW 125i E81, E82, E87, E88 09/2004-09/2012	Suspension Control Arm and Ball Joint Assembly - Front Right Lower Forward
ARM251	301181325100	BMW 128i E81, E82, E87, E88 09/2004-09/2012	Suspension Control Arm and Ball Joint Assembly - Front Right Lower Forward
ARM251	301181325100	BMW 130i E81, E82, E87, E88 09/2004-09/2012	Suspension Control Arm and Ball Joint Assembly - Front Right Lower Forward
ARM251	301181325100	BMW 135i E81, E82, E87, E88 09/2004-09/2012	Suspension Control Arm and Ball Joint Assembly - Front Right Lower Forward
ARM251	301181325100	BMW 323i E90/E91/E92/E93 01/2005-12/2011	Suspension Control Arm and Ball Joint Assembly - Front Right Lower Forward
ARM251	301181325100	BMW 325Ci E90/E91/E92/E93 01/2005-12/2011	Suspension Control Arm and Ball Joint Assembly - Front Right Lower Forward
ARM251	301181325100	BMW 325i E90/E91/E92/E93 01/2005-12/2011	Suspension Control Arm and Ball Joint Assembly - Front Right Lower Forward
ARM251	301181325100	BMW 328i E90/E91/E92/E93 01/2005-12/2011	Suspension Control Arm and Ball Joint Assembly - Front Right Lower Forward
ARM251	301181325100	BMW 330Ci E90/E91/E92/E93 01/2005-12/2011	Suspension Control Arm and Ball Joint Assembly - Front Right Lower Forward
ARM251	301181325100	BMW 330i E90/E91/E92/E93 01/2005-12/2011	Suspension Control Arm and Ball Joint Assembly - Front Right Lower Forward
ARM251	301181325100	BMW 335d E90/E91/E92/E93 01/2005-12/2011	Suspension Control Arm and Ball Joint Assembly - Front Right Lower Forward
ARM251	301181325100	BMW 335i E90/E91/E92/E93 01/2005-12/2011	Suspension Control Arm and Ball Joint Assembly - Front Right Lower Forward
ARM251	301181325100	BMW 335is E90/E91/E92/E93 01/2005-12/2011	Suspension Control Arm and Ball Joint Assembly - Front Right Lower Forward
ARM251	301181325100	BMW X1 E84 10/2009-2016	Suspension Control Arm and Ball Joint Assembly - Front Right Lower Forward
ARM252	301181325200	BMW 120i E81, E82, E87, E88 09/2004-09/2012	Suspension Control Arm and Ball Joint Assembly - Front Left Lower Forward
ARM252	301181325200	BMW 125i E81, E82, E87, E88 09/2004-09/2012	Suspension Control Arm and Ball Joint Assembly - Front Left Lower Forward
ARM252	301181325200	BMW 128i E81, E82, E87, E88 09/2004-09/2012	Suspension Control Arm and Ball Joint Assembly - Front Left Lower Forward
ARM252	301181325200	BMW 130i E81, E82, E87, E88 09/2004-09/2012	Suspension Control Arm and Ball Joint Assembly - Front Left Lower Forward
ARM252	301181325200	BMW 135i E81, E82, E87, E88 09/2004-09/2012	Suspension Control Arm and Ball Joint Assembly - Front Left Lower Forward
ARM252	301181325200	BMW 323i E90/E91/E92/E93 01/2005-12/2011	Suspension Control Arm and Ball Joint Assembly - Front Left Lower Forward
ARM252	301181325200	BMW 325Ci E90/E91/E92/E93 01/2005-12/2011	Suspension Control Arm and Ball Joint Assembly - Front Left Lower Forward



 SHORT LONG			DESCRIPTION
ARM252	301181325200	BMW 325i E90/E91/E92/E93 01/2005-12/2011	Suspension Control Arm and Ball Joint Assembly - Front Left Lower Forward
ARM252	301181325200	BMW 328i E90/E91/E92/E93 01/2005-12/2011	Suspension Control Arm and Ball Joint Assembly - Front Left Lower Forward
ARM252	301181325200	BMW 330Ci E90/E91/E92/E93 01/2005-12/2011	Suspension Control Arm and Ball Joint Assembly - Front Left Lower Forward
ARM252	301181325200	BMW 330i E90/E91/E92/E93 01/2005-12/2011	Suspension Control Arm and Ball Joint Assembly - Front Left Lower Forward
ARM252	301181325200	BMW 335d E90/E91/E92/E93 01/2005-12/2011	Suspension Control Arm and Ball Joint Assembly - Front Left Lower Forward
ARM252	301181325200	BMW 335i E90/E91/E92/E93 01/2005-12/2011	Suspension Control Arm and Ball Joint Assembly - Front Left Lower Forward
ARM252	301181325200	BMW 335is E90/E91/E92/E93 01/2005-12/2011	Suspension Control Arm and Ball Joint Assembly - Front Left Lower Forward
ARM252	301181325200	BMW X1 E84 10/2009-2016	Suspension Control Arm and Ball Joint Assembly - Front Left Lower Forward
ARM253	301181325300	BMW 120i E81, E82, E87, E88 09/2004-09/2012	Lateral Arm - Rear Upper Forward
ARM253	301181325300	BMW 125i E81, E82, E87, E88 09/2004-09/2012	Lateral Arm - Rear Upper Forward
ARM253	301181325300	BMW 128i E81, E82, E87, E88 09/2004-09/2012	Lateral Arm - Rear Upper Forward
ARM253	301181325300	BMW 130i E81, E82, E87, E88 09/2004-09/2012	Lateral Arm - Rear Upper Forward
ARM253	301181325300	BMW 135i E81, E82, E87, E88 09/2004-09/2012	Lateral Arm - Rear Upper Forward
ARM253	301181325300	BMW 323i E90/E91/E92/E93 01/2005-12/2011	Lateral Arm - Rear Upper Forward
ARM253	301181325300	BMW 325Ci E90/E91/E92/E93 01/2005-12/2011	Lateral Arm - Rear Upper Forward
ARM253	301181325300	BMW 325i E90/E91/E92/E93 01/2005-12/2011	Lateral Arm - Rear Upper Forward
ARM253	301181325300	BMW 328i E90/E91/E92/E93 01/2005-12/2011	Lateral Arm - Rear Upper Forward
ARM253	301181325300	BMW 330Ci E90/E91/E92/E93 01/2005-12/2011	Lateral Arm - Rear Upper Forward
ARM253	301181325300	BMW 330i E90/E91/E92/E93 01/2005-12/2011	Lateral Arm - Rear Upper Forward
ARM253	301181325300	BMW 335d E90/E91/E92/E93 01/2005-12/2011	Lateral Arm - Rear Upper Forward
ARM253	301181325300	BMW 335i E90/E91/E92/E93 01/2005-12/2011	Lateral Arm - Rear Upper Forward
ARM253	301181325300	BMW 335is E90/E91/E92/E93 01/2005-12/2011	Lateral Arm - Rear Upper Forward
ARM253	301181325300	BMW X1 E84 10/2009-2016	Lateral Arm - Rear Upper Forward
ARM254	301181325400	BMW 120i E81, E82, E87, E88 09/2004-09/2012	Lateral Arm - Rear Upper Rearward
ARM254	301181325400	BMW 125i E81, E82, E87, E88 09/2004-09/2012	Lateral Arm - Rear Upper Rearward
ARM254	301181325400	BMW 128i E81, E82, E87, E88 09/2004-09/2012	Lateral Arm - Rear Upper Rearward
ARM254	301181325400	BMW 130i E81, E82, E87, E88 09/2004-09/2012	Lateral Arm - Rear Upper Rearward
ARM254	301181325400	BMW 135i E81, E82, E87, E88 09/2004-09/2012	Lateral Arm - Rear Upper Rearward



			DESCRIPTION
SHORT	LONG		
ARM254	301181325400	BMW 323i E90/E91/E92/E93 01/2005-12/2011	Lateral Arm - Rear Upper Rearward
ARM254	301181325400	BMW 325Ci E90/E91/E92/E93 01/2005-12/2011	Lateral Arm - Rear Upper Rearward
ARM254	301181325400	BMW 325i E90/E91/E92/E93 01/2005-12/2011	Lateral Arm - Rear Upper Rearward
ARM254	301181325400	BMW 328i E90/E91/E92/E93 01/2005-12/2011	Lateral Arm - Rear Upper Rearward
ARM254	301181325400	BMW 330Ci E90/E91/E92/E93 01/2005-12/2011	Lateral Arm - Rear Upper Rearward
ARM254	301181325400	BMW 330i E90/E91/E92/E93 01/2005-12/2011	Lateral Arm - Rear Upper Rearward
ARM254	301181325400	BMW 335d E90/E91/E92/E93 01/2005-12/2011	Lateral Arm - Rear Upper Rearward
ARM254	301181325400	BMW 335i E90/E91/E92/E93 01/2005-12/2011	Lateral Arm - Rear Upper Rearward
ARM254	301181325400	BMW 335is E90/E91/E92/E93 01/2005-12/2011	Lateral Arm - Rear Upper Rearward
ARM254	301181325400	BMW X1 E84 10/2009-2016	Lateral Arm - Rear Upper Rearward
ARM255	301181325500	BMW 120i E81, E82, E87, E88 09/2004-09/2012	Lateral Arm - Rear Lower Rearward
ARM255	301181325500	BMW 125i E81, E82, E87, E88 09/2004-09/2012	Lateral Arm - Rear Lower Rearward
ARM255	301181325500	BMW 128i E81, E82, E87, E88 09/2004-09/2012	Lateral Arm - Rear Lower Rearward
ARM255	301181325500	BMW 130i E81, E82, E87, E88 09/2004-09/2012	Lateral Arm - Rear Lower Rearward
ARM255	301181325500	BMW 135i E81, E82, E87, E88 09/2004-09/2012	Lateral Arm - Rear Lower Rearward
ARM255	301181325500	BMW 323i E90/E91/E92/E93 01/2005-12/2011	Lateral Arm - Rear Lower Rearward
ARM255	301181325500	BMW 325Ci E90/E91/E92/E93 01/2005-12/2011	Lateral Arm - Rear Lower Rearward
ARM255	301181325500	BMW 325i E90/E91/E92/E93 01/2005-12/2011	Lateral Arm - Rear Lower Rearward
ARM255	301181325500	BMW 328i E90/E91/E92/E93 01/2005-12/2011	Lateral Arm - Rear Lower Rearward
ARM255	301181325500	BMW 330Ci E90/E91/E92/E93 01/2005-12/2011	Lateral Arm - Rear Lower Rearward
ARM255	301181325500	BMW 330i E90/E91/E92/E93 01/2005-12/2011	Lateral Arm - Rear Lower Rearward
ARM255	301181325500	BMW 335d E90/E91/E92/E93 01/2005-12/2011	Lateral Arm - Rear Lower Rearward
ARM255	301181325500	BMW 335i E90/E91/E92/E93 01/2005-12/2011	Lateral Arm - Rear Lower Rearward
ARM255	301181325500	BMW 335is E90/E91/E92/E93 01/2005-12/2011	Lateral Arm - Rear Lower Rearward
ARM255	301181325500	BMW X1 E84 10/2009-2016	Lateral Arm - Rear Lower Rearward
ARM256	301181325600	BMW 325xi E90/E91/E92/E93 (xDrive) 4x4 01/2005-12/2011	Suspension Control Arm - Front Right Lower Rearward
ARM256	301181325600	BMW 328i xDrive E90/E91/E92/E93 (xDrive) 4x4 01/2005-12/2011	Suspension Control Arm - Front Right Lower Rearward
ARM256	301181325600	BMW 328xi E90/E91/E92/E93 (xDrive) 4x4 01/2005-12/2011	Suspension Control Arm - Front Right Lower Rearward
ARM256	301181325600	BMW 330xi E90/E91/E92/E93 (xDrive) 4x4 01/2005-12/2011	Suspension Control Arm - Front Right Lower Rearward
ARM256	301181325600	BMW 335i xDrive E90/E91/E92/E93 (xDrive) 4x4 01/2005-12/2011	Suspension Control Arm - Front Right Lower Rearward
ARM256	301181325600	BMW 335xi E90/E91/E92/E93 (xDrive) 4x4 01/2005-12/2011	Suspension Control Arm - Front Right Lower Rearward





 SHORT LONG			DESCRIPTION
ARM257	301181325700	BMW 325xi E90/E91/E92/E93 (xDrive) 4x4 01/2005-12/2011	Suspension Control Arm - Front Left Lower Rearward
ARM257	301181325700	BMW 328i xDrive E90/E91/E92/E93 (xDrive) 4x4 01/2005-12/2011	Suspension Control Arm - Front Left Lower Rearward
ARM257	301181325700	BMW 328xi E90/E91/E92/E93 (xDrive) 4x4 01/2005-12/2011	Suspension Control Arm - Front Left Lower Rearward
ARM257	301181325700	BMW 330xi E90/E91/E92/E93 (xDrive) 4x4 01/2005-12/2011	Suspension Control Arm - Front Left Lower Rearward
ARM257	301181325700	BMW 335i xDrive E90/E91/E92/E93 (xDrive) 4x4 01/2005-12/2011	Suspension Control Arm - Front Left Lower Rearward
ARM257	301181325700	BMW 335xi E90/E91/E92/E93 (xDrive) 4x4 01/2005-12/2011	Suspension Control Arm - Front Left Lower Rearward
ARM258	301181325800	BMW 118i F 10/2011-	Suspension Control Arm and Ball Joint Assembly - Front Right Lower Rearward
ARM258	301181325800	BMW 120i F 10/2011-	Suspension Control Arm and Ball Joint Assembly - Front Right Lower Rearward
ARM258	301181325800	BMW 125i F 10/2011-	Suspension Control Arm and Ball Joint Assembly - Front Right Lower Rearward
ARM258	301181325800	BMW 128i F 10/2011-	Suspension Control Arm and Ball Joint Assembly - Front Right Lower Rearward
ARM258	301181325800	BMW 130i F 10/2011-	Suspension Control Arm and Ball Joint Assembly - Front Right Lower Rearward
ARM258	301181325800	BMW 135i F 10/2011-	Suspension Control Arm and Ball Joint Assembly - Front Right Lower Rearward
ARM258	301181325800	BMW 135is F 10/2011-	Suspension Control Arm and Ball Joint Assembly - Front Right Lower Rearward
ARM258	301181325800	BMW 320i F 10/2011-	Suspension Control Arm and Ball Joint Assembly - Front Right Lower Rearward
ARM258	301181325800	BMW 325i F 10/2011-	Suspension Control Arm and Ball Joint Assembly - Front Right Lower Rearward
ARM258	301181325800	BMW 328d F 10/2011-	Suspension Control Arm and Ball Joint Assembly - Front Right Lower Rearward
ARM258	301181325800	BMW 328i F 10/2011-	Suspension Control Arm and Ball Joint Assembly - Front Right Lower Rearward
ARM258	301181325800	BMW 330i F 10/2011-	Suspension Control Arm and Ball Joint Assembly - Front Right Lower Rearward
ARM258	301181325800	BMW 335i F 10/2011-	Suspension Control Arm and Ball Joint Assembly - Front Right Lower Rearward
ARM258	301181325800	BMW 335is F 10/2011-	Suspension Control Arm and Ball Joint Assembly - Front Right Lower Rearward
ARM258	301181325800	BMW 340i F 10/2011-	Suspension Control Arm and Ball Joint Assembly - Front Right Lower Rearward
ARM258	301181325800	BMW 420i F 05/2014-	Suspension Control Arm and Ball Joint Assembly - Front Right Lower Rearward
ARM258	301181325800	BMW 420i Gran Coupe F 05/2014-	Suspension Control Arm and Ball Joint Assembly - Front Right Lower Rearward
ARM258	301181325800	BMW 428i F 05/2014-	Suspension Control Arm and Ball Joint Assembly - Front Right Lower Rearward
ARM258	301181325800	BMW 428i Gran Coupe F 05/2014-	Suspension Control Arm and Ball Joint Assembly - Front Right Lower Rearward



			DESCRIPTION
SHORT	LONG		
ARM258	301181325800	BMW 435i F 05/2014-	Suspension Control Arm and Ball Joint Assembly - Front Right Lower Rearward
ARM258	301181325800	BMW 435i Gran Coupe F 05/2014-	Suspension Control Arm and Ball Joint Assembly - Front Right Lower Rearward
ARM259	301181325900	BMW 118i F 10/2011-	Suspension Control Arm and Ball Joint Assembly - Front Left Lower Rearward
ARM259	301181325900	BMW 120i F 10/2011-	Suspension Control Arm and Ball Joint Assembly - Front Left Lower Rearward
ARM259	301181325900	BMW 125i F 10/2011-	Suspension Control Arm and Ball Joint Assembly - Front Left Lower Rearward
ARM259	301181325900	BMW 128i F 10/2011-	Suspension Control Arm and Ball Joint Assembly - Front Left Lower Rearward
ARM259	301181325900	BMW 130i F 10/2011-	Suspension Control Arm and Ball Joint Assembly - Front Left Lower Rearward
ARM259	301181325900	BMW 135i F 10/2011-	Suspension Control Arm and Ball Joint Assembly - Front Left Lower Rearward
ARM259	301181325900	BMW 135is F 10/2011-	Suspension Control Arm and Ball Joint Assembly - Front Left Lower Rearward
ARM259	301181325900	BMW 320i F 10/2011-	Suspension Control Arm and Ball Joint Assembly - Front Left Lower Rearward
ARM259	301181325900	BMW 325i F 10/2011-	Suspension Control Arm and Ball Joint Assembly - Front Left Lower Rearward
ARM259	301181325900	BMW 328d F 10/2011-	Suspension Control Arm and Ball Joint Assembly - Front Left Lower Rearward
ARM259	301181325900	BMW 328i F 10/2011-	Suspension Control Arm and Ball Joint Assembly - Front Left Lower Rearward
ARM259	301181325900	BMW 330i F 10/2011-	Suspension Control Arm and Ball Joint Assembly - Front Left Lower Rearward
ARM259	301181325900	BMW 335i F 10/2011-	Suspension Control Arm and Ball Joint Assembly - Front Left Lower Rearward
ARM259	301181325900	BMW 335is F 10/2011-	Suspension Control Arm and Ball Joint Assembly - Front Left Lower Rearward
ARM259	301181325900	BMW 340i F 10/2011-	Suspension Control Arm and Ball Joint Assembly - Front Left Lower Rearward
ARM259	301181325900	BMW 420i F 05/2014-	Suspension Control Arm and Ball Joint Assembly - Front Left Lower Rearward
ARM259	301181325900	BMW 420i Gran Coupe F 05/2014-	Suspension Control Arm and Ball Joint Assembly - Front Left Lower Rearward
ARM259	301181325900	BMW 428i F 05/2014-	Suspension Control Arm and Ball Joint Assembly - Front Left Lower Rearward
ARM259	301181325900	BMW 428i Gran Coupe F 05/2014-	Suspension Control Arm and Ball Joint Assembly - Front Left Lower Rearward
ARM259	301181325900	BMW 435i F 05/2014-	Suspension Control Arm and Ball Joint Assembly - Front Left Lower Rearward
ARM259	301181325900	BMW 435i Gran Coupe F 05/2014-	Suspension Control Arm and Ball Joint Assembly - Front Left Lower Rearward
ARM260	301181326000	BMW 118i F 10/2011-	Suspension Control Arm and Ball Joint Assembly - Front Right Lower Forward
ARM260	301181326000	BMW 120i F 10/2011-	Suspension Control Arm and Ball Joint Assembly - Front Right Lower Forward





 SHORT LONG		 	DESCRIPTION
ARM260	301181326000	BMW 125i F 10/2011-	Suspension Control Arm and Ball Joint Assembly - Front Right Lower Forward
ARM260	301181326000	BMW 128i F 10/2011-	Suspension Control Arm and Ball Joint Assembly - Front Right Lower Forward
ARM260	301181326000	BMW 130i F 10/2011-	Suspension Control Arm and Ball Joint Assembly - Front Right Lower Forward
ARM260	301181326000	BMW 135i F 10/2011-	Suspension Control Arm and Ball Joint Assembly - Front Right Lower Forward
ARM260	301181326000	BMW 135is F 10/2011-	Suspension Control Arm and Ball Joint Assembly - Front Right Lower Forward
ARM260	301181326000	BMW 320i F 10/2011-	Suspension Control Arm and Ball Joint Assembly - Front Right Lower Forward
ARM260	301181326000	BMW 325i F 10/2011-	Suspension Control Arm and Ball Joint Assembly - Front Right Lower Forward
ARM260	301181326000	BMW 328d F 10/2011-	Suspension Control Arm and Ball Joint Assembly - Front Right Lower Forward
ARM260	301181326000	BMW 328i F 10/2011-	Suspension Control Arm and Ball Joint Assembly - Front Right Lower Forward
ARM260	301181326000	BMW 330i F 10/2011-	Suspension Control Arm and Ball Joint Assembly - Front Right Lower Forward
ARM260	301181326000	BMW 335i F 10/2011-	Suspension Control Arm and Ball Joint Assembly - Front Right Lower Forward
ARM260	301181326000	BMW 335is F 10/2011-	Suspension Control Arm and Ball Joint Assembly - Front Right Lower Forward
ARM260	301181326000	BMW 340i F 10/2011-	Suspension Control Arm and Ball Joint Assembly - Front Right Lower Forward
ARM260	301181326000	BMW 420i F 05/2014-	Suspension Control Arm and Ball Joint Assembly - Front Right Lower Forward
ARM260	301181326000	BMW 420i Gran Coupe F 05/2014-	Suspension Control Arm and Ball Joint Assembly - Front Right Lower Forward
ARM260	301181326000	BMW 428i F 05/2014-	Suspension Control Arm and Ball Joint Assembly - Front Right Lower Forward
ARM260	301181326000	BMW 428i Gran Coupe F 05/2014-	Suspension Control Arm and Ball Joint Assembly - Front Right Lower Forward
ARM260	301181326000	BMW 435i F 05/2014-	Suspension Control Arm and Ball Joint Assembly - Front Right Lower Forward
ARM260	301181326000	BMW 435i Gran Coupe F 05/2014-	Suspension Control Arm and Ball Joint Assembly - Front Right Lower Forward
ARM261	301181326100	BMW 118i F 10/2011-	Suspension Control Arm and Ball Joint Assembly - Front Left Lower Forward
ARM261	301181326100	BMW 120i F 10/2011-	Suspension Control Arm and Ball Joint Assembly - Front Left Lower Forward
ARM261	301181326100	BMW 125i F 10/2011-	Suspension Control Arm and Ball Joint Assembly - Front Left Lower Forward
ARM261	301181326100	BMW 128i F 10/2011-	Suspension Control Arm and Ball Joint Assembly - Front Left Lower Forward
ARM261	301181326100	BMW 130i F 10/2011-	Suspension Control Arm and Ball Joint Assembly - Front Left Lower Forward
ARM261	301181326100	BMW 135i F 10/2011-	Suspension Control Arm and Ball Joint Assembly - Front Left Lower Forward



			DESCRIPTION
SHORT	LONG		
ARM261	301181326100	BMW 135is F 10/2011-	Suspension Control Arm and Ball Joint Assembly - Front Left Lower Forward
ARM261	301181326100	BMW 320i F 10/2011-	Suspension Control Arm and Ball Joint Assembly - Front Left Lower Forward
ARM261	301181326100	BMW 325i F 10/2011-	Suspension Control Arm and Ball Joint Assembly - Front Left Lower Forward
ARM261	301181326100	BMW 328d F 10/2011-	Suspension Control Arm and Ball Joint Assembly - Front Left Lower Forward
ARM261	301181326100	BMW 328i F 10/2011-	Suspension Control Arm and Ball Joint Assembly - Front Left Lower Forward
ARM261	301181326100	BMW 330i F 10/2011-	Suspension Control Arm and Ball Joint Assembly - Front Left Lower Forward
ARM261	301181326100	BMW 335i F 10/2011-	Suspension Control Arm and Ball Joint Assembly - Front Left Lower Forward
ARM261	301181326100	BMW 335is F 10/2011-	Suspension Control Arm and Ball Joint Assembly - Front Left Lower Forward
ARM261	301181326100	BMW 340i F 10/2011-	Suspension Control Arm and Ball Joint Assembly - Front Left Lower Forward
ARM261	301181326100	BMW 420i F 05/2014-	Suspension Control Arm and Ball Joint Assembly - Front Left Lower Forward
ARM261	301181326100	BMW 420i Gran Coupe F 05/2014-	Suspension Control Arm and Ball Joint Assembly - Front Left Lower Forward
ARM261	301181326100	BMW 428i F 05/2014-	Suspension Control Arm and Ball Joint Assembly - Front Left Lower Forward
ARM261	301181326100	BMW 428i Gran Coupe F 05/2014-	Suspension Control Arm and Ball Joint Assembly - Front Left Lower Forward
ARM261	301181326100	BMW 435i F 05/2014-	Suspension Control Arm and Ball Joint Assembly - Front Left Lower Forward
ARM261	301181326100	BMW 435i Gran Coupe F 05/2014-	Suspension Control Arm and Ball Joint Assembly - Front Left Lower Forward
ARM262	301181326200	BMW 118i F 10/2011-	Lateral Arm - Rear Right Upper Forward
ARM262	301181326200	BMW 120i F 10/2011-	Lateral Arm - Rear Right Upper Forward
ARM262	301181326200	BMW 125i F 10/2011-	Lateral Arm - Rear Right Upper Forward
ARM262	301181326200	BMW 128i F 10/2011-	Lateral Arm - Rear Right Upper Forward
ARM262	301181326200	BMW 130i F 10/2011-	Lateral Arm - Rear Right Upper Forward
ARM262	301181326200	BMW 135i F 10/2011-	Lateral Arm - Rear Right Upper Forward
ARM262	301181326200	BMW 135is F 10/2011-	Lateral Arm - Rear Right Upper Forward
ARM262	301181326200	BMW 218i F 2014-	Lateral Arm - Rear Right Upper Forward
ARM262	301181326200	BMW 220i F 2014-	Lateral Arm - Rear Right Upper Forward
ARM262	301181326200	BMW 228i F 2014-	Lateral Arm - Rear Right Upper Forward
ARM262	301181326200	BMW 235i F 2014-	Lateral Arm - Rear Right Upper Forward
ARM262	301181326200	BMW 320i F 10/2011-	Lateral Arm - Rear Right Upper Forward
ARM262	301181326200	BMW 325i F 10/2011-	Lateral Arm - Rear Right Upper Forward
ARM262	301181326200	BMW 328d F 10/2011-	Lateral Arm - Rear Right Upper Forward
ARM262	301181326200	BMW 328i F 10/2011-	Lateral Arm - Rear Right Upper Forward
ARM262	301181326200	BMW 330i F 10/2011-	Lateral Arm - Rear Right Upper Forward
ARM262	301181326200	BMW 335i F 10/2011-	Lateral Arm - Rear Right Upper Forward





 SHORT LONG			DESCRIPTION
ARM262	301181326200	BMW 335is F 10/2011-	Lateral Arm - Rear Right Upper Forward
ARM262	301181326200	BMW 340i F 10/2011-	Lateral Arm - Rear Right Upper Forward
ARM262	301181326200	BMW 420i F 05/2014-	Lateral Arm - Rear Right Upper Forward
ARM262	301181326200	BMW 420i Gran Coupe F 05/2014-	Lateral Arm - Rear Right Upper Forward
ARM262	301181326200	BMW 428i F 05/2014-	Lateral Arm - Rear Right Upper Forward
ARM262	301181326200	BMW 428i Gran Coupe F 05/2014-	Lateral Arm - Rear Right Upper Forward
ARM262	301181326200	BMW 435i F 05/2014-	Lateral Arm - Rear Right Upper Forward
ARM262	301181326200	BMW 435i Gran Coupe F 05/2014-	Lateral Arm - Rear Right Upper Forward
ARM263	301181326300	BMW 118i F 10/2011-	Lateral Arm - Rear Left Upper Forward
ARM263	301181326300	BMW 120i F 10/2011-	Lateral Arm - Rear Left Upper Forward
ARM263	301181326300	BMW 125i F 10/2011-	Lateral Arm - Rear Left Upper Forward
ARM263	301181326300	BMW 128i F 10/2011-	Lateral Arm - Rear Left Upper Forward
ARM263	301181326300	BMW 130i F 10/2011-	Lateral Arm - Rear Left Upper Forward
ARM263	301181326300	BMW 135i F 10/2011-	Lateral Arm - Rear Left Upper Forward
ARM263	301181326300	BMW 135is F 10/2011-	Lateral Arm - Rear Left Upper Forward
ARM263	301181326300	BMW 218i F 2014-	Lateral Arm - Rear Left Upper Forward
ARM263	301181326300	BMW 220i F 2014-	Lateral Arm - Rear Left Upper Forward
ARM263	301181326300	BMW 228i F 2014-	Lateral Arm - Rear Left Upper Forward
ARM263	301181326300	BMW 235i F 2014-	Lateral Arm - Rear Left Upper Forward
ARM263	301181326300	BMW 320i F 10/2011-	Lateral Arm - Rear Left Upper Forward
ARM263	301181326300	BMW 325i F 10/2011-	Lateral Arm - Rear Left Upper Forward
ARM263	301181326300	BMW 328d F 10/2011-	Lateral Arm - Rear Left Upper Forward
ARM263	301181326300	BMW 328i F 10/2011-	Lateral Arm - Rear Left Upper Forward
ARM263	301181326300	BMW 330i F 10/2011-	Lateral Arm - Rear Left Upper Forward
ARM263	301181326300	BMW 335i F 10/2011-	Lateral Arm - Rear Left Upper Forward
ARM263	301181326300	BMW 335is F 10/2011-	Lateral Arm - Rear Left Upper Forward
ARM263	301181326300	BMW 340i F 10/2011-	Lateral Arm - Rear Left Upper Forward
ARM263	301181326300	BMW 420i F 05/2014-	Lateral Arm - Rear Left Upper Forward
ARM263	301181326300	BMW 420i Gran Coupe F 05/2014-	Lateral Arm - Rear Left Upper Forward
ARM263	301181326300	BMW 428i F 05/2014-	Lateral Arm - Rear Left Upper Forward
ARM263	301181326300	BMW 428i Gran Coupe F 05/2014-	Lateral Arm - Rear Left Upper Forward
ARM263	301181326300	BMW 435i F 05/2014-	Lateral Arm - Rear Left Upper Forward
ARM263	301181326300	BMW 435i Gran Coupe F 05/2014-	Lateral Arm - Rear Left Upper Forward
ARM264	301181326400	BMW 118i F 10/2011-	Lateral Arm - Rear Lower
ARM264	301181326400	BMW 120i F 10/2011-	Lateral Arm - Rear Lower
ARM264	301181326400	BMW 125i F 10/2011-	Lateral Arm - Rear Lower
ARM264	301181326400	BMW 128i F 10/2011-	Lateral Arm - Rear Lower
ARM264	301181326400	BMW 130i F 10/2011-	Lateral Arm - Rear Lower
ARM264	301181326400	BMW 135i F 10/2011-	Lateral Arm - Rear Lower
ARM264	301181326400	BMW 135is F 10/2011-	Lateral Arm - Rear Lower
ARM264	301181326400	BMW 218i F 2014-	Lateral Arm - Rear Lower



 SHORT LONG			DESCRIPTION
ARM264	301181326400	BMW 220i F 2014-	Lateral Arm - Rear Lower
ARM264	301181326400	BMW 228i F 2014-	Lateral Arm - Rear Lower
ARM264	301181326400	BMW 235i F 2014-	Lateral Arm - Rear Lower
ARM264	301181326400	BMW 320i F 10/2011-	Lateral Arm - Rear Lower
ARM264	301181326400	BMW 325i F 10/2011-	Lateral Arm - Rear Lower
ARM264	301181326400	BMW 328d F 10/2011-	Lateral Arm - Rear Lower
ARM264	301181326400	BMW 328i F 10/2011-	Lateral Arm - Rear Lower
ARM264	301181326400	BMW 330i F 10/2011-	Lateral Arm - Rear Lower
ARM264	301181326400	BMW 335i F 10/2011-	Lateral Arm - Rear Lower
ARM264	301181326400	BMW 335is F 10/2011-	Lateral Arm - Rear Lower
ARM264	301181326400	BMW 340i F 10/2011-	Lateral Arm - Rear Lower
ARM264	301181326400	BMW 420i F 05/2014-	Lateral Arm - Rear Lower
ARM264	301181326400	BMW 420i Gran Coupe F 05/2014-	Lateral Arm - Rear Lower
ARM264	301181326400	BMW 428i F 05/2014-	Lateral Arm - Rear Lower
ARM264	301181326400	BMW 428i Gran Coupe F 05/2014-	Lateral Arm - Rear Lower
ARM264	301181326400	BMW 435i F 05/2014-	Lateral Arm - Rear Lower
ARM264	301181326400	BMW 435i Gran Coupe F 05/2014-	Lateral Arm - Rear Lower
ARM265	301181326500	BMW 118i F 10/2011-	Lateral Arm - Rear Upper
ARM265	301181326500	BMW 120i F 10/2011-	Lateral Arm - Rear Upper
ARM265	301181326500	BMW 125i F 10/2011-	Lateral Arm - Rear Upper
ARM265	301181326500	BMW 128i F 10/2011-	Lateral Arm - Rear Upper
ARM265	301181326500	BMW 130i F 10/2011-	Lateral Arm - Rear Upper
ARM265	301181326500	BMW 135i F 10/2011-	Lateral Arm - Rear Upper
ARM265	301181326500	BMW 135is F 10/2011-	Lateral Arm - Rear Upper
ARM265	301181326500	BMW 218i F 2014-	Lateral Arm - Rear Upper
ARM265	301181326500	BMW 220i F 2014-	Lateral Arm - Rear Upper
ARM265	301181326500	BMW 228i F 2014-	Lateral Arm - Rear Upper
ARM265	301181326500	BMW 235i F 2014-	Lateral Arm - Rear Upper
ARM265	301181326500	BMW 320i F 10/2011-	Lateral Arm - Rear Upper
ARM265	301181326500	BMW 325i F 10/2011-	Lateral Arm - Rear Upper
ARM265	301181326500	BMW 328d F 10/2011-	Lateral Arm - Rear Upper
ARM265	301181326500	BMW 328i F 10/2011-	Lateral Arm - Rear Upper
ARM265	301181326500	BMW 330i F 10/2011-	Lateral Arm - Rear Upper
ARM265	301181326500	BMW 335i F 10/2011-	Lateral Arm - Rear Upper
ARM265	301181326500	BMW 335is F 10/2011-	Lateral Arm - Rear Upper
ARM265	301181326500	BMW 340i F 10/2011-	Lateral Arm - Rear Upper
ARM265	301181326500	BMW 420i F 05/2014-	Lateral Arm - Rear Upper
ARM265	301181326500	BMW 420i Gran Coupe F 05/2014-	Lateral Arm - Rear Upper
ARM265	301181326500	BMW 428i F 05/2014-	Lateral Arm - Rear Upper
ARM265	301181326500	BMW 428i Gran Coupe F 05/2014-	Lateral Arm - Rear Upper
ARM265	301181326500	BMW 435i F 05/2014-	Lateral Arm - Rear Upper



 SHORT LONG			DESCRIPTION
ARM265	301181326500	BMW 435i Gran Coupe F 05/2014-	Lateral Arm - Rear Upper
ARM266	301181326600	BMW 118i F 10/2011-	Lateral Arm - Rear Right Upper Rearward
ARM266	301181326600	BMW 120i F 10/2011-	Lateral Arm - Rear Right Upper Rearward
ARM266	301181326600	BMW 125i F 10/2011-	Lateral Arm - Rear Right Upper Rearward
ARM266	301181326600	BMW 128i F 10/2011-	Lateral Arm - Rear Right Upper Rearward
ARM266	301181326600	BMW 130i F 10/2011-	Lateral Arm - Rear Right Upper Rearward
ARM266	301181326600	BMW 135i F 10/2011-	Lateral Arm - Rear Right Upper Rearward
ARM266	301181326600	BMW 135is F 10/2011-	Lateral Arm - Rear Right Upper Rearward
ARM266	301181326600	BMW 218i F 2014-	Lateral Arm - Rear Right Upper Rearward
ARM266	301181326600	BMW 220i F 2014-	Lateral Arm - Rear Right Upper Rearward
ARM266	301181326600	BMW 228i F 2014-	Lateral Arm - Rear Right Upper Rearward
ARM266	301181326600	BMW 235i F 2014-	Lateral Arm - Rear Right Upper Rearward
ARM266	301181326600	BMW 320i F 10/2011-	Lateral Arm - Rear Right Upper Rearward
ARM266	301181326600	BMW 325i F 10/2011-	Lateral Arm - Rear Right Upper Rearward
ARM266	301181326600	BMW 328d F 10/2011-	Lateral Arm - Rear Right Upper Rearward
ARM266	301181326600	BMW 328i F 10/2011-	Lateral Arm - Rear Right Upper Rearward
ARM266	301181326600	BMW 330i F 10/2011-	Lateral Arm - Rear Right Upper Rearward
ARM266	301181326600	BMW 335i F 10/2011-	Lateral Arm - Rear Right Upper Rearward
ARM266	301181326600	BMW 335is F 10/2011-	Lateral Arm - Rear Right Upper Rearward
ARM266	301181326600	BMW 340i F 10/2011-	Lateral Arm - Rear Right Upper Rearward
ARM266	301181326600	BMW 420i F 05/2014-	Lateral Arm - Rear Right Upper Rearward
ARM266	301181326600	BMW 420i Gran Coupe F 05/2014-	Lateral Arm - Rear Right Upper Rearward
ARM266	301181326600	BMW 428i F 05/2014-	Lateral Arm - Rear Right Upper Rearward
ARM266	301181326600	BMW 428i Gran Coupe F 05/2014-	Lateral Arm - Rear Right Upper Rearward
ARM266	301181326600	BMW 435i F 05/2014-	Lateral Arm - Rear Right Upper Rearward
ARM266	301181326600	BMW 435i Gran Coupe F 05/2014-	Lateral Arm - Rear Right Upper Rearward
ARM267	301181326700	BMW 118i F 10/2011-	Lateral Arm - Rear Left Upper Rearward
ARM267	301181326700	BMW 120i F 10/2011-	Lateral Arm - Rear Left Upper Rearward
ARM267	301181326700	BMW 125i F 10/2011-	Lateral Arm - Rear Left Upper Rearward
ARM267	301181326700	BMW 128i F 10/2011-	Lateral Arm - Rear Left Upper Rearward
ARM267	301181326700	BMW 130i F 10/2011-	Lateral Arm - Rear Left Upper Rearward
ARM267	301181326700	BMW 135i F 10/2011-	Lateral Arm - Rear Left Upper Rearward
ARM267	301181326700	BMW 135is F 10/2011-	Lateral Arm - Rear Left Upper Rearward
ARM267	301181326700	BMW 218i F 2014-	Lateral Arm - Rear Left Upper Rearward
ARM267	301181326700	BMW 220i F 2014-	Lateral Arm - Rear Left Upper Rearward
ARM267	301181326700	BMW 228i F 10/2011-	Lateral Arm - Rear Left Upper Rearward
ARM267	301181326700	BMW 228i F 2014-	Lateral Arm - Rear Left Upper Rearward
ARM267	301181326700	BMW 235i F 2014-	Lateral Arm - Rear Left Upper Rearward
ARM267	301181326700	BMW 320i F 10/2011-	Lateral Arm - Rear Left Upper Rearward
ARM267	301181326700	BMW 325i F 10/2011-	Lateral Arm - Rear Left Upper Rearward
ARM267	301181326700	BMW 328d F 10/2011-	Lateral Arm - Rear Left Upper Rearward



 SHORT LONG			DESCRIPTION
ARM267	301181326700	BMW 328i F 10/2011-	Lateral Arm - Rear Left Upper Rearward
ARM267	301181326700	BMW 330i F 10/2011-	Lateral Arm - Rear Left Upper Rearward
ARM267	301181326700	BMW 335i F 10/2011-	Lateral Arm - Rear Left Upper Rearward
ARM267	301181326700	BMW 335is F 10/2011-	Lateral Arm - Rear Left Upper Rearward
ARM267	301181326700	BMW 340i F 10/2011-	Lateral Arm - Rear Left Upper Rearward
ARM267	301181326700	BMW 420i F 05/2014-	Lateral Arm - Rear Left Upper Rearward
ARM267	301181326700	BMW 420i Gran Coupe F 05/2014-	Lateral Arm - Rear Left Upper Rearward
ARM267	301181326700	BMW 428i F 05/2014-	Lateral Arm - Rear Left Upper Rearward
ARM267	301181326700	BMW 428i Gran Coupe F 05/2014-	Lateral Arm - Rear Left Upper Rearward
ARM267	301181326700	BMW 435i F 05/2014-	Lateral Arm - Rear Left Upper Rearward
ARM267	301181326700	BMW 435i Gran Coupe F 05/2014-	Lateral Arm - Rear Left Upper Rearward
ARM268	301181326800	BMW 525i E39 11/1995-06/2003	Suspension Control Arm and Ball Joint Assembly - Front Right Lower Forward
ARM268	301181326800	BMW 528i E39 11/1995-06/2003	Suspension Control Arm and Ball Joint Assembly - Front Right Lower Forward
ARM268	301181326800	BMW 530i E39 11/1995-06/2003	Suspension Control Arm and Ball Joint Assembly - Front Right Lower Forward
ARM269	301181326900	BMW 525i E39 11/1995-06/2003	Suspension Control Arm and Ball Joint Assembly - Front Left Lower Forward
ARM269	301181326900	BMW 528i E39 11/1995-06/2003	Suspension Control Arm and Ball Joint Assembly - Front Left Lower Forward
ARM269	301181326900	BMW 530i E39 11/1995-06/2003	Suspension Control Arm and Ball Joint Assembly - Front Left Lower Forward
ARM270	301181327000	BMW 525i E39 11/1995-06/2003	Suspension Control Arm and Ball Joint Assembly - Front Right Lower Rearward
ARM270	301181327000	BMW 528i E39 11/1995-06/2003	Suspension Control Arm and Ball Joint Assembly - Front Right Lower Rearward
ARM270	301181327000	BMW 530i E39 11/1995-06/2003	Suspension Control Arm and Ball Joint Assembly - Front Right Lower Rearward
ARM271	301181327100	BMW 525i E39 11/1995-06/2003	Suspension Control Arm and Ball Joint Assembly - Front Left Lower Rearward
ARM271	301181327100	BMW 528i E39 11/1995-06/2003	Suspension Control Arm and Ball Joint Assembly - Front Left Lower Rearward
ARM271	301181327100	BMW 530i E39 11/1995-06/2003	Suspension Control Arm and Ball Joint Assembly - Front Left Lower Rearward
ARM272	301181327200	BMW 525i E39 11/1995-06/2003	Lateral Arm - Rear Right
ARM272	301181327200	BMW 528i E39 11/1995-06/2003	Lateral Arm - Rear Right
ARM272	301181327200	BMW 530i E39 11/1995-06/2003	Lateral Arm - Rear Right
ARM273	301181327300	BMW 525i E39 11/1995-06/2003	Lateral Arm - Rear Left
ARM273	301181327300	BMW 528i E39 11/1995-06/2003	Lateral Arm - Rear Left
ARM273	301181327300	BMW 530i E39 11/1995-06/2003	Lateral Arm - Rear Left
ARM274	301181327400	BMW 320i E46 02/1998-04/2005	Suspension Control Arm and Ball Joint Assembly - Front Right Lower
ARM274	301181327400	BMW 323Ci E46 02/1998-04/2005	Suspension Control Arm and Ball Joint Assembly - Front Right Lower
ARM274	301181327400	BMW 323i E46 02/1998-04/2005	Suspension Control Arm and Ball Joint Assembly - Front Right Lower





 SHORT LONG			DESCRIPTION
ARM274	301181327400	BMW 325Ci E46 02/1998-04/2005	Suspension Control Arm and Ball Joint Assembly - Front Right Lower
ARM274	301181327400	BMW 325i E46 02/1998-04/2005	Suspension Control Arm and Ball Joint Assembly - Front Right Lower
ARM274	301181327400	BMW 330Ci E46 02/1998-04/2005	Suspension Control Arm and Ball Joint Assembly - Front Right Lower
ARM274	301181327400	BMW 330i E46 02/1998-04/2005	Suspension Control Arm and Ball Joint Assembly - Front Right Lower
ARM274	301181327400	BMW Z4 E85 02/2003-02/2009	Suspension Control Arm and Ball Joint Assembly - Front Right Lower
ARM275	301181327500	BMW 320i E46 02/1998-04/2005	Suspension Control Arm Kit - Front Right Lower
ARM275	301181327500	BMW 323Ci E46 02/1998-04/2005	Suspension Control Arm Kit - Front Right Lower
ARM275	301181327500	BMW 323i E46 02/1998-04/2005	Suspension Control Arm Kit - Front Right Lower
ARM275	301181327500	BMW 325Ci E46 02/1998-04/2005	Suspension Control Arm Kit - Front Right Lower
ARM275	301181327500	BMW 325i E46 02/1998-04/2005	Suspension Control Arm Kit - Front Right Lower
ARM275	301181327500	BMW 330Ci E46 02/1998-04/2005	Suspension Control Arm Kit - Front Right Lower
ARM275	301181327500	BMW 330i E46 02/1998-04/2005	Suspension Control Arm Kit - Front Right Lower
ARM275	301181327500	BMW Z4 E85 02/2003-02/2009	Suspension Control Arm Kit - Front Right Lower
ARM276	301181327600	BMW 320i E46 02/1998-04/2005	Suspension Control Arm Kit - Front Right Lower
ARM276	301181327600	BMW 323Ci E46 02/1998-04/2005	Suspension Control Arm Kit - Front Right Lower
ARM276	301181327600	BMW 323i E46 02/1998-04/2005	Suspension Control Arm Kit - Front Right Lower
ARM276	301181327600	BMW 325Ci E46 02/1998-04/2005	Suspension Control Arm Kit - Front Right Lower
ARM276	301181327600	BMW 325i E46 02/1998-04/2005	Suspension Control Arm Kit - Front Right Lower
ARM276	301181327600	BMW 330Ci E46 02/1998-04/2005	Suspension Control Arm Kit - Front Right Lower
ARM276	301181327600	BMW 330i E46 02/1998-04/2005	Suspension Control Arm Kit - Front Right Lower
ARM276	301181327600	BMW Z4 E85 02/2003-02/2009	Suspension Control Arm Kit - Front Right Lower
ARM277	301181327700	BMW 320i E46 02/1998-04/2005	Suspension Control Arm and Ball Joint Assembly - Front Left Lower
ARM277	301181327700	BMW 323Ci E46 02/1998-04/2005	Suspension Control Arm and Ball Joint Assembly - Front Left Lower
ARM277	301181327700	BMW 323i E46 02/1998-04/2005	Suspension Control Arm and Ball Joint Assembly - Front Left Lower
ARM277	301181327700	BMW 325Ci E46 02/1998-04/2005	Suspension Control Arm and Ball Joint Assembly - Front Left Lower



			DESCRIPTION
SHORT	LONG		
ARM277	301181327700	BMW 325i E46 02/1998-04/2005	Suspension Control Arm and Ball Joint Assembly - Front Left Lower
ARM277	301181327700	BMW 330Ci E46 02/1998-04/2005	Suspension Control Arm and Ball Joint Assembly - Front Left Lower
ARM277	301181327700	BMW 330i E46 02/1998-04/2005	Suspension Control Arm and Ball Joint Assembly - Front Left Lower
ARM277	301181327700	BMW Z4 E85 02/2003-02/2009	Suspension Control Arm and Ball Joint Assembly - Front Left Lower
ARM278	301181327800	BMW 320i E46 02/1998-04/2005	Suspension Control Arm Kit - Front Left Lower
ARM278	301181327800	BMW 323Ci E46 02/1998-04/2005	Suspension Control Arm Kit - Front Left Lower
ARM278	301181327800	BMW 323i E46 02/1998-04/2005	Suspension Control Arm Kit - Front Left Lower
ARM278	301181327800	BMW 325Ci E46 02/1998-04/2005	Suspension Control Arm Kit - Front Left Lower
ARM278	301181327800	BMW 325i E46 02/1998-04/2005	Suspension Control Arm Kit - Front Left Lower
ARM278	301181327800	BMW 330Ci E46 02/1998-04/2005	Suspension Control Arm Kit - Front Left Lower
ARM278	301181327800	BMW 330i E46 02/1998-04/2005	Suspension Control Arm Kit - Front Left Lower
ARM278	301181327800	BMW Z4 E85 02/2003-02/2009	Suspension Control Arm Kit - Front Left Lower
ARM279	301181327900	BMW 320i E46 02/1998-04/2005	Suspension Control Arm Kit - Front Left Lower
ARM279	301181327900	BMW 323Ci E46 02/1998-04/2005	Suspension Control Arm Kit - Front Left Lower
ARM279	301181327900	BMW 323i E46 02/1998-04/2005	Suspension Control Arm Kit - Front Left Lower
ARM279	301181327900	BMW 325Ci E46 02/1998-04/2005	Suspension Control Arm Kit - Front Left Lower
ARM279	301181327900	BMW 325i E46 02/1998-04/2005	Suspension Control Arm Kit - Front Left Lower
ARM279	301181327900	BMW 330Ci E46 02/1998-04/2005	Suspension Control Arm Kit - Front Left Lower
ARM279	301181327900	BMW 330i E46 02/1998-04/2005	Suspension Control Arm Kit - Front Left Lower
ARM279	301181327900	BMW Z4 E85 02/2003-02/2009	Suspension Control Arm Kit - Front Left Lower
ARM280	301181328000	BMW 318i E46 02/1998-04/2005	Suspension Control Arm and Ball Joint Assembly - Front Right
ARM280	301181328000	BMW 320i E46 02/1998-04/2005	Suspension Control Arm and Ball Joint Assembly - Front Right
ARM280	301181328000	BMW 325i E46 02/1998-04/2005	Suspension Control Arm and Ball Joint Assembly - Front Right
ARM280	301181328000	BMW 330i E46 02/1998-04/2005	Suspension Control Arm and Ball Joint Assembly - Front Right
ARM281	301181328100	BMW 318i E46 02/1998-04/2005	Suspension Control Arm and Ball Joint Assembly - Front Right
ARM281	301181328100	BMW 320i E46 02/1998-04/2005	Suspension Control Arm and Ball Joint Assembly - Front Right
ARM281	301181328100	BMW 325i E46 02/1998-04/2005	Suspension Control Arm and Ball Joint Assembly - Front Right
ARM281	301181328100	BMW 330i E46 02/1998-04/2005	Suspension Control Arm and Ball Joint Assembly - Front Right
ARM282	301181328200	BMW 318i E46 02/1998-04/2005	Suspension Control Arm and Ball Joint Assembly - Front Left
ARM282	301181328200	BMW 320i E46 02/1998-04/2005	Suspension Control Arm and Ball Joint Assembly - Front Left
ARM282	301181328200	BMW 325i E46 02/1998-04/2005	Suspension Control Arm and Ball Joint Assembly - Front Left





 SHORT LONG			DESCRIPTION
ARM282	301181328200	BMW 330i E46 02/1998-04/2005	Suspension Control Arm and Ball Joint Assembly - Fornt Left
ARM283	301181328300	BMW 318i E46 02/1998-04/2005	Suspension Control Arm and Ball Joint Assembly - Front Left
ARM283	301181328300	BMW 320i E46 02/1998-04/2005	Suspension Control Arm and Ball Joint Assembly - Front Left
ARM283	301181328300	BMW 325i E46 02/1998-04/2005	Suspension Control Arm and Ball Joint Assembly - Front Left
ARM283	301181328300	BMW 330i E46 02/1998-04/2005	Suspension Control Arm and Ball Joint Assembly - Front Left
ARM284	301181328400	BMW M3 E46 2001-2006	Suspension Control Arm and Ball Joint Assembly - Front Right
ARM285	301181328500	BMW M3 E46 2001-2006	Suspension Control Arm and Ball Joint Assembly - Front Left
ARM286	301181328600	BMW 645Ci E63, E64 01/2004-11/2010	Suspension Control Arm and Ball Joint Assembly - Front Left Lower Rearward
ARM286	301181328600	BMW 650Ci E63, E64 01/2004-11/2010	Suspension Control Arm and Ball Joint Assembly - Front Left Lower Rearward
ARM286	301181328600	BMW 650i E63, E64 01/2004-11/2010	Suspension Control Arm and Ball Joint Assembly - Front Left Lower Rearward
ARM286	301181328600	BMW 745i E65, E66, E67 01/2001-09/2008	Suspension Control Arm and Ball Joint Assembly - Front Left Lower Rearward
ARM286	301181328600	BMW 745Li E65, E66, E67 01/2001-09/2008	Suspension Control Arm and Ball Joint Assembly - Front Left Lower Rearward
ARM286	301181328600	BMW 750i E65, E66, E67 01/2001-09/2008	Suspension Control Arm and Ball Joint Assembly - Front Left Lower Rearward
ARM286	301181328600	BMW 750Li E65, E66, E67 01/2001-09/2008	Suspension Control Arm and Ball Joint Assembly - Front Left Lower Rearward
ARM286	301181328600	BMW 760i E65, E66, E67 01/2001-09/2008	Suspension Control Arm and Ball Joint Assembly - Front Left Lower Rearward
ARM286	301181328600	BMW 760Li E65, E66, E67 01/2001-09/2008	Suspension Control Arm and Ball Joint Assembly - Front Left Lower Rearward
ARM287	301181328700	BMW 645Ci E63, E64 01/2004-11/2010	Suspension Control Arm and Ball Joint Assembly - Front Right Lower Forward
ARM287	301181328700	BMW 650Ci E63, E64 01/2004-11/2010	Suspension Control Arm and Ball Joint Assembly - Front Right Lower Forward
ARM287	301181328700	BMW 650i E63, E64 01/2004-11/2010	Suspension Control Arm and Ball Joint Assembly - Front Right Lower Forward
ARM287	301181328700	BMW 745i E65, E66, E67 01/2001-09/2008	Suspension Control Arm and Ball Joint Assembly - Front Right Lower Forward
ARM287	301181328700	BMW 745Li E65, E66, E67 01/2001-09/2008	Suspension Control Arm and Ball Joint Assembly - Front Right Lower Forward
ARM287	301181328700	BMW 750i E65, E66, E67 01/2001-09/2008	Suspension Control Arm and Ball Joint Assembly - Front Right Lower Forward
ARM287	301181328700	BMW 750Li E65, E66, E67 01/2001-09/2008	Suspension Control Arm and Ball Joint Assembly - Front Right Lower Forward
ARM287	301181328700	BMW 760i E65, E66, E67 01/2001-09/2008	Suspension Control Arm and Ball Joint Assembly - Front Right Lower Forward
ARM287	301181328700	BMW 760Li E65, E66, E67 01/2001-09/2008	Suspension Control Arm and Ball Joint Assembly - Front Right Lower Forward



 SHORT LONG			DESCRIPTION
ARM288	301181328800	BMW 645Ci E63, E64 01/2004-11/2010	Suspension Control Arm and Ball Joint Assembly - Front Left Lower Forward
ARM288	301181328800	BMW 650Ci E63, E64 01/2004-11/2010	Suspension Control Arm and Ball Joint Assembly - Front Left Lower Forward
ARM288	301181328800	BMW 650i E63, E64 01/2004-11/2010	Suspension Control Arm and Ball Joint Assembly - Front Left Lower Forward
ARM288	301181328800	BMW 745i E65, E66, E67 01/2001-09/2008	Suspension Control Arm and Ball Joint Assembly - Front Left Lower Forward
ARM288	301181328800	BMW 745Li E65, E66, E67 01/2001-09/2008	Suspension Control Arm and Ball Joint Assembly - Front Left Lower Forward
ARM288	301181328800	BMW 750i E65, E66, E67 01/2001-09/2008	Suspension Control Arm and Ball Joint Assembly - Front Left Lower Forward
ARM288	301181328800	BMW 750Li E65, E66, E67 01/2001-09/2008	Suspension Control Arm and Ball Joint Assembly - Front Left Lower Forward
ARM288	301181328800	BMW 760i E65, E66, E67 01/2001-09/2008	Suspension Control Arm and Ball Joint Assembly - Front Left Lower Forward
ARM288	301181328800	BMW 760Li E65, E66, E67 01/2001-09/2008	Suspension Control Arm and Ball Joint Assembly - Front Left Lower Forward
ARM289	301181328900	BMW 645Ci E63, E64 01/2004-11/2010	Suspension Control Arm and Ball Joint Assembly - Front Right Lower Forward
ARM289	301181328900	BMW 650Ci E63, E64 01/2004-11/2010	Suspension Control Arm and Ball Joint Assembly - Front Right Lower Forward
ARM289	301181328900	BMW 650i E63, E64 01/2004-11/2010	Suspension Control Arm and Ball Joint Assembly - Front Right Lower Forward
ARM289	301181328900	BMW 745i E65, E66, E67 01/2001-09/2008	Suspension Control Arm and Ball Joint Assembly - Front Right Lower Forward
ARM289	301181328900	BMW 745Li E65, E66, E67 01/2001-09/2008	Suspension Control Arm and Ball Joint Assembly - Front Right Lower Forward
ARM289	301181328900	BMW 750i E65, E66, E67 01/2001-09/2008	Suspension Control Arm and Ball Joint Assembly - Front Right Lower Forward
ARM289	301181328900	BMW 750Li E65, E66, E67 01/2001-09/2008	Suspension Control Arm and Ball Joint Assembly - Front Right Lower Forward
ARM289	301181328900	BMW 760i E65, E66, E67 01/2001-09/2008	Suspension Control Arm and Ball Joint Assembly - Front Right Lower Forward
ARM289	301181328900	BMW 760Li E65, E66, E67 01/2001-09/2008	Suspension Control Arm and Ball Joint Assembly - Front Right Lower Forward
ARM290	301181329000	BMW 525i E60 - E61 07/2003-03/2010	Lateral Arm - Rear Right Upper Rearward
ARM290	301181329000	BMW 528i E60 - E61 07/2003-03/2010	Lateral Arm - Rear Right Upper Rearward
ARM290	301181329000	BMW 530i E60 - E61 07/2003-03/2010	Lateral Arm - Rear Right Upper Rearward
ARM290	301181329000	BMW 535i E60 - E61 07/2003-03/2010	Lateral Arm - Rear Right Upper Rearward
ARM290	301181329000	BMW 545i E60 - E61 07/2003-03/2010	Lateral Arm - Rear Right Upper Rearward
ARM290	301181329000	BMW 550i E60 - E61 07/2003-03/2010	Lateral Arm - Rear Right Upper Rearward
ARM290	301181329000	BMW 645Ci E63, E64 01/2004-11/2010	Lateral Arm - Rear Right Upper Rearward
ARM290	301181329000	BMW 650Ci E63, E64 01/2004-11/2010	Lateral Arm - Rear Right Upper Rearward
ARM290	301181329000	BMW 650i E63, E64 01/2004-11/2010	Lateral Arm - Rear Right Upper Rearward
ARM290	301181329000	BMW 745i E65, E66, E67 01/2001-09/2008	Lateral Arm - Rear Right Upper Rearward
ARM290	301181329000	BMW 745Li E65, E66, E67 01/2001-09/2008	Lateral Arm - Rear Right Upper Rearward
ARM290	301181329000	BMW 750i E65, E66, E67 01/2001-09/2008	Lateral Arm - Rear Right Upper Rearward





 SHORT LONG			DESCRIPTION
ARM290	301181329000	BMW 750Li E65, E66, E67 01/2001-09/2008	Lateral Arm - Rear Right Upper Rearward
ARM290	301181329000	BMW 760i E65, E66, E67 01/2001-09/2008	Lateral Arm - Rear Right Upper Rearward
ARM290	301181329000	BMW 760Li E65, E66, E67 01/2001-09/2008	Lateral Arm - Rear Right Upper Rearward
ARM291	301181329100	BMW 525i E60 - E61 07/2003-03/2010	Lateral Arm - Rear Left Upper Rearward
ARM291	301181329100	BMW 528i E60 - E61 07/2003-03/2010	Lateral Arm - Rear Left Upper Rearward
ARM291	301181329100	BMW 530i E60 - E61 07/2003-03/2010	Lateral Arm - Rear Left Upper Rearward
ARM291	301181329100	BMW 535i E60 - E61 07/2003-03/2010	Lateral Arm - Rear Left Upper Rearward
ARM291	301181329100	BMW 545i E60 - E61 07/2003-03/2010	Lateral Arm - Rear Left Upper Rearward
ARM291	301181329100	BMW 550i E60 - E61 07/2003-03/2010	Lateral Arm - Rear Left Upper Rearward
ARM291	301181329100	BMW 645Ci E63, E64 01/2004-11/2010	Lateral Arm - Rear Left Upper Rearward
ARM291	301181329100	BMW 650Ci E63, E64 01/2004-11/2010	Lateral Arm - Rear Left Upper Rearward
ARM291	301181329100	BMW 650i E63, E64 01/2004-11/2010	Lateral Arm - Rear Left Upper Rearward
ARM291	301181329100	BMW 745i E65, E66, E67 01/2001-09/2008	Lateral Arm - Rear Left Upper Rearward
ARM291	301181329100	BMW 745Li E65, E66, E67 01/2001-09/2008	Lateral Arm - Rear Left Upper Rearward
ARM291	301181329100	BMW 750i E65, E66, E67 01/2001-09/2008	Lateral Arm - Rear Left Upper Rearward
ARM291	301181329100	BMW 750Li E65, E66, E67 01/2001-09/2008	Lateral Arm - Rear Left Upper Rearward
ARM291	301181329100	BMW 760i E65, E66, E67 01/2001-09/2008	Lateral Arm - Rear Left Upper Rearward
ARM291	301181329100	BMW 760Li E65, E66, E67 01/2001-09/2008	Lateral Arm - Rear Left Upper Rearward
ARM292	301181329200	BMW 525i E39 11/1995-06/2003	Lateral Arm - Rear Upper Forward
ARM292	301181329200	BMW 525i E60 - E61 07/2003-03/2010	Lateral Arm - Rear Upper Forward
ARM292	301181329200	BMW 528i E39 11/1995-06/2003	Lateral Arm - Rear Upper Forward
ARM292	301181329200	BMW 528i E60 - E61 07/2003-03/2010	Lateral Arm - Rear Upper Forward
ARM292	301181329200	BMW 530i E39 11/1995-06/2003	Lateral Arm - Rear Upper Forward
ARM292	301181329200	BMW 530i E60 - E61 07/2003-03/2010	Lateral Arm - Rear Upper Forward
ARM292	301181329200	BMW 535i E60 - E61 07/2003-03/2010	Lateral Arm - Rear Upper Forward
ARM292	301181329200	BMW 540i E39 11/1995-06/2003	Lateral Arm - Rear Upper Forward
ARM292	301181329200	BMW 545i E60 - E61 07/2003-03/2010	Lateral Arm - Rear Upper Forward
ARM292	301181329200	BMW 550i E60 - E61 07/2003-03/2010	Lateral Arm - Rear Upper Forward
ARM292	301181329200	BMW 645Ci E63, E64 01/2004-11/2010	Lateral Arm - Rear Upper Forward
ARM292	301181329200	BMW 650Ci E63, E64 01/2004-11/2010	Lateral Arm - Rear Upper Forward
ARM292	301181329200	BMW 650i E63, E64 01/2004-11/2010	Lateral Arm - Rear Upper Forward
ARM292	301181329200	BMW 745i E65, E66, E67 01/2001-09/2008	Lateral Arm - Rear Upper Forward
ARM292	301181329200	BMW 745Li E65, E66, E67 01/2001-09/2008	Lateral Arm - Rear Upper Forward
ARM292	301181329200	BMW 750i E65, E66, E67 01/2001-09/2008	Lateral Arm - Rear Upper Forward
ARM292	301181329200	BMW 750Li E65, E66, E67 01/2001-09/2008	Lateral Arm - Rear Upper Forward
ARM292	301181329200	BMW 760i E65, E66, E67 01/2001-09/2008	Lateral Arm - Rear Upper Forward
ARM292	301181329200	BMW 760Li E65, E66, E67 01/2001-09/2008	Lateral Arm - Rear Upper Forward
ARM293	301181329300	BMW 525i E60 - E61 07/2003-03/2010	Lateral Arm - Rear Right Upper Rearward
ARM293	301181329300	BMW 528i E60 - E61 07/2003-03/2010	Lateral Arm - Rear Right Upper Rearward
ARM293	301181329300	BMW 530i E60 - E61 07/2003-03/2010	Lateral Arm - Rear Right Upper Rearward
ARM293	301181329300	BMW 535i E60 - E61 07/2003-03/2010	Lateral Arm - Rear Right Upper Rearward



			DESCRIPTION
SHORT	LONG		
ARM293	301181329300	BMW 545i E60 - E61 07/2003-03/2010	Lateral Arm - Rear Right Upper Rearward
ARM293	301181329300	BMW 550i E60 - E61 07/2003-03/2010	Lateral Arm - Rear Right Upper Rearward
ARM293	301181329300	BMW 645Ci E63, E64 01/2004-11/2010	Lateral Arm - Rear Right Upper Rearward
ARM293	301181329300	BMW 650Ci E63, E64 01/2004-11/2010	Lateral Arm - Rear Right Upper Rearward
ARM293	301181329300	BMW 650i E63, E64 01/2004-11/2010	Lateral Arm - Rear Right Upper Rearward
ARM294	301181329400	BMW 525i E60 - E61 07/2003-03/2010	Lateral Arm - Rear Left Upper Rearward
ARM294	301181329400	BMW 528i E60 - E61 07/2003-03/2010	Lateral Arm - Rear Left Upper Rearward
ARM294	301181329400	BMW 530i E60 - E61 07/2003-03/2010	Lateral Arm - Rear Left Upper Rearward
ARM294	301181329400	BMW 535i E60 - E61 07/2003-03/2010	Lateral Arm - Rear Left Upper Rearward
ARM294	301181329400	BMW 545i E60 - E61 07/2003-03/2010	Lateral Arm - Rear Left Upper Rearward
ARM294	301181329400	BMW 550i E60 - E61 07/2003-03/2010	Lateral Arm - Rear Left Upper Rearward
ARM294	301181329400	BMW 645Ci E63, E64 01/2004-11/2010	Lateral Arm - Rear Left Upper Rearward
ARM294	301181329400	BMW 650Ci E63, E64 01/2004-11/2010	Lateral Arm - Rear Left Upper Rearward
ARM294	301181329400	BMW 650i E63, E64 01/2004-11/2010	Lateral Arm - Rear Left Upper Rearward
ARM295	301181329500	BMW 525i E60 - E61 07/2003-03/2010	Suspension Control Arm and Ball Joint Assembly - Front Right Lower Forward
ARM295	301181329500	BMW 528i E60 - E61 07/2003-03/2010	Suspension Control Arm and Ball Joint Assembly - Front Right Lower Forward
ARM295	301181329500	BMW 530i E60 - E61 07/2003-03/2010	Suspension Control Arm and Ball Joint Assembly - Front Right Lower Forward
ARM295	301181329500	BMW 535i E60 - E61 07/2003-03/2010	Suspension Control Arm and Ball Joint Assembly - Front Right Lower Forward
ARM295	301181329500	BMW 545i E60 - E61 07/2003-03/2010	Suspension Control Arm and Ball Joint Assembly - Front Right Lower Forward
ARM295	301181329500	BMW 550i E60 - E61 07/2003-03/2010	Suspension Control Arm and Ball Joint Assembly - Front Right Lower Forward
ARM296	301181329600	BMW 525i E60 - E61 07/2003-03/2010	Suspension Control Arm and Ball Joint Assembly - Front Left Lower Forward
ARM296	301181329600	BMW 528i E60 - E61 07/2003-03/2010	Suspension Control Arm and Ball Joint Assembly - Front Left Lower Forward
ARM296	301181329600	BMW 530i E60 - E61 07/2003-03/2010	Suspension Control Arm and Ball Joint Assembly - Front Left Lower Forward
ARM296	301181329600	BMW 535i E60 - E61 07/2003-03/2010	Suspension Control Arm and Ball Joint Assembly - Front Left Lower Forward
ARM296	301181329600	BMW 545i E60 - E61 07/2003-03/2010	Suspension Control Arm and Ball Joint Assembly - Front Left Lower Forward
ARM296	301181329600	BMW 550i E60 - E61 07/2003-03/2010	Suspension Control Arm and Ball Joint Assembly - Front Left Lower Forward
ARM297	301181329700	BMW 525i E60 - E61 07/2003-03/2010	Suspension Control Arm and Ball Joint Assembly - Front Right Lower Rearward
ARM297	301181329700	BMW 528i E60 - E61 07/2003-03/2010	Suspension Control Arm and Ball Joint Assembly - Front Right Lower Rearward
ARM297	301181329700	BMW 530i E60 - E61 07/2003-03/2010	Suspension Control Arm and Ball Joint Assembly - Front Right Lower Rearward
ARM297	301181329700	BMW 535i E60 - E61 07/2003-03/2010	Suspension Control Arm and Ball Joint Assembly - Front Right Lower Rearward
ARM297	301181329700	BMW 545i E60 - E61 07/2003-03/2010	Suspension Control Arm and Ball Joint Assembly - Front Right Lower Rearward





 SHORT LONG			DESCRIPTION
ARM297	301181329700	BMW 550i E60 - E61 07/2003-03/2010	Suspension Control Arm and Ball Joint Assembly - Front Right Lower Rearward
ARM298	301181329800	BMW 525i E60 - E61 07/2003-03/2010	Suspension Control Arm and Ball Joint Assembly - Front Left Lower
ARM298	301181329800	BMW 528i E60 - E61 07/2003-03/2010	Suspension Control Arm and Ball Joint Assembly - Front Left Lower
ARM298	301181329800	BMW 530i E60 - E61 07/2003-03/2010	Suspension Control Arm and Ball Joint Assembly - Front Left Lower
ARM298	301181329800	BMW 535i E60 - E61 07/2003-03/2010	Suspension Control Arm and Ball Joint Assembly - Front Left Lower
ARM298	301181329800	BMW 545i E60 - E61 07/2003-03/2010	Suspension Control Arm and Ball Joint Assembly - Front Left Lower
ARM298	301181329800	BMW 550i E60 - E61 07/2003-03/2010	Suspension Control Arm and Ball Joint Assembly - Front Left Lower
ARM299	301181329900	BMW 740i E38 1994-2002	Suspension Control Arm and Ball Joint Assembly - Front Right Lower Rearward
ARM299	301181329900	BMW 740iL E38 1994-2002	Suspension Control Arm and Ball Joint Assembly - Front Right Lower Rearward
ARM299	301181329900	BMW 745i E38 1994-2002	Suspension Control Arm and Ball Joint Assembly - Front Right Lower Rearward
ARM299	301181329900	BMW 745Li E38 1994-2002	Suspension Control Arm and Ball Joint Assembly - Front Right Lower Rearward
ARM299	301181329900	BMW 750iL E38 1994-2002	Suspension Control Arm and Ball Joint Assembly - Front Right Lower Rearward
ARM300	301181330000	BMW 740i E38 1994-2002	Suspension Control Arm and Ball Joint Assembly - Front Left Lower Rearward
ARM300	301181330000	BMW 740iL E38 1994-2002	Suspension Control Arm and Ball Joint Assembly - Front Left Lower Rearward
ARM300	301181330000	BMW 745i E38 1994-2002	Suspension Control Arm and Ball Joint Assembly - Front Left Lower Rearward
ARM300	301181330000	BMW 745Li E38 1994-2002	Suspension Control Arm and Ball Joint Assembly - Front Left Lower Rearward
ARM300	301181330000	BMW 750iL E38 1994-2002	Suspension Control Arm and Ball Joint Assembly - Front Left Lower Rearward
ARM301	301181330100	BMW 525i E39 11/1995-06/2003	Lateral Arm - Rear Upper Forward
ARM301	301181330100	BMW 528i E39 11/1995-06/2003	Lateral Arm - Rear Upper Forward
ARM301	301181330100	BMW 530i E39 11/1995-06/2003	Lateral Arm - Rear Upper Forward
ARM301	301181330100	BMW 540i E39 11/1995-06/2003	Lateral Arm - Rear Upper Forward
ARM301	301181330100	BMW 740i E38 1994-2002	Lateral Arm - Rear Upper Forward
ARM301	301181330100	BMW 740iL E38 1994-2002	Lateral Arm - Rear Upper Forward
ARM301	301181330100	BMW 745i E38 1994-2002	Lateral Arm - Rear Upper Forward
ARM301	301181330100	BMW 745Li E38 1994-2002	Lateral Arm - Rear Upper Forward
ARM301	301181330100	BMW 750iL E38 1994-2002	Lateral Arm - Rear Upper Forward
ARM302	301181330200	BMW 740i E38 1994-2002	Suspension Control Arm and Ball Joint Assembly - Front Right Lower Forward
ARM302	301181330200	BMW 740iL E38 1994-2002	Suspension Control Arm and Ball Joint Assembly - Front Right Lower Forward
ARM302	301181330200	BMW 745i E38 1994-2002	Suspension Control Arm and Ball Joint Assembly - Front Right Lower Forward



			DESCRIPTION
SHORT	LONG		
ARM302	301181330200	BMW 745Li E38 1994-2002	Suspension Control Arm and Ball Joint Assembly - Front Right Lower Forward
ARM302	301181330200	BMW 750iL E38 1994-2002	Suspension Control Arm and Ball Joint Assembly - Front Right Lower Forward
ARM303	301181330300	BMW 740i E38 1994-2002	Suspension Control Arm and Ball Joint Assembly - Front Left Lower Forward
ARM303	301181330300	BMW 740iL E38 1994-2002	Suspension Control Arm and Ball Joint Assembly - Front Left Lower Forward
ARM303	301181330300	BMW 745i E38 1994-2002	Suspension Control Arm and Ball Joint Assembly - Front Left Lower Forward
ARM303	301181330300	BMW 745Li E38 1994-2002	Suspension Control Arm and Ball Joint Assembly - Front Left Lower Forward
ARM303	301181330300	BMW 750iL E38 1994-2002	Suspension Control Arm and Ball Joint Assembly - Front Left Lower Forward
ARM304	301181330400	BMW 740i E38 1994-2002	Lateral Arm - Rear Right
ARM304	301181330400	BMW 740iL E38 1994-2002	Lateral Arm - Rear Right
ARM304	301181330400	BMW 745i E38 1994-2002	Lateral Arm - Rear Right
ARM304	301181330400	BMW 745Li E38 1994-2002	Lateral Arm - Rear Right
ARM304	301181330400	BMW 750iL E38 1994-2002	Lateral Arm - Rear Right
ARM305	301181330500	BMW 740i E38 1994-2002	Lateral Arm - Rear Left
ARM305	301181330500	BMW 740iL E38 1994-2002	Lateral Arm - Rear Left
ARM305	301181330500	BMW 745i E38 1994-2002	Lateral Arm - Rear Left
ARM305	301181330500	BMW 745Li E38 1994-2002	Lateral Arm - Rear Left
ARM305	301181330500	BMW 750iL E38 1994-2002	Lateral Arm - Rear Left
ARM306	301181330600	BMW 525i E39 11/1995-06/2003	Suspension Control Arm and Ball Joint Assembly - Front Right Lower
ARM306	301181330600	BMW 528i E39 11/1995-06/2003	Suspension Control Arm and Ball Joint Assembly - Front Right Lower
ARM306	301181330600	BMW 530i E39 11/1995-06/2003	Suspension Control Arm and Ball Joint Assembly - Front Right Lower
ARM306	301181330600	BMW 540i E39 11/1995-06/2003	Suspension Control Arm and Ball Joint Assembly - Front Right Lower
ARM307	301181330700	BMW 525i E39 11/1995-06/2003	Suspension Control Arm and Ball Joint Assembly - Front Left Lower
ARM307	301181330700	BMW 528i E39 11/1995-06/2003	Suspension Control Arm and Ball Joint Assembly - Front Left Lower
ARM307	301181330700	BMW 530i E39 11/1995-06/2003	Suspension Control Arm and Ball Joint Assembly - Front Left Lower
ARM307	301181330700	BMW 540i E39 11/1995-06/2003	Suspension Control Arm and Ball Joint Assembly - Front Left Lower
ARM308	301181330800	BMW 535i E39 11/1995-06/2003	Suspension Control Arm and Ball Joint Assembly - Front Right Lower Rearward
ARM308	301181330800	BMW 540i E39 11/1995-06/2003	Suspension Control Arm and Ball Joint Assembly - Front Right Lower Rearward
ARM308	301181330800	BMW M5 E39 11/1995-06/2003	Suspension Control Arm and Ball Joint Assembly - Front Right Lower Rearward
ARM309	301181330900	BMW 535i E39 11/1995-06/2003	Suspension Control Arm and Ball Joint Assembly - Front Left Lower Rearward





 SHORT LONG			DESCRIPTION
ARM309	301181330900	BMW 540i E39 11/1995-06/2003	Suspension Control Arm and Ball Joint Assembly - Front Left Lower Rearward
ARM309	301181330900	BMW M5 E39 11/1995-06/2003	Suspension Control Arm and Ball Joint Assembly - Front Left Lower Rearward
ARM310	301181331000	BMW 645Ci E63, E64 01/2004-11/2010	Lateral Arm - Rear Right Forward
ARM310	301181331000	BMW 650Ci E63, E64 01/2004-11/2010	Lateral Arm - Rear Right Forward
ARM310	301181331000	BMW 650i E63, E64 01/2004-11/2010	Lateral Arm - Rear Right Forward
ARM310	301181331000	BMW 745i E65, E66, E67 01/2001-09/2008	Lateral Arm - Rear Right Forward
ARM310	301181331000	BMW 745Li E65, E66, E67 01/2001-09/2008	Lateral Arm - Rear Right Forward
ARM310	301181331000	BMW 750i E65, E66, E67 01/2001-09/2008	Lateral Arm - Rear Right Forward
ARM310	301181331000	BMW 750Li E65, E66, E67 01/2001-09/2008	Lateral Arm - Rear Right Forward
ARM310	301181331000	BMW 760i E65, E66, E67 01/2001-09/2008	Lateral Arm - Rear Right Forward
ARM310	301181331000	BMW 760Li E65, E66, E67 01/2001-09/2008	Lateral Arm - Rear Right Forward
ARM311	301181331100	BMW 645Ci E63, E64 01/2004-11/2010	Lateral Arm - Rear Left Forward
ARM311	301181331100	BMW 650Ci E63, E64 01/2004-11/2010	Lateral Arm - Rear Left Forward
ARM311	301181331100	BMW 650i E63, E64 01/2004-11/2010	Lateral Arm - Rear Left Forward
ARM311	301181331100	BMW 745i E65, E66, E67 01/2001-09/2008	Lateral Arm - Rear Left Forward
ARM311	301181331100	BMW 745Li E65, E66, E67 01/2001-09/2008	Lateral Arm - Rear Left Forward
ARM311	301181331100	BMW 750i E65, E66, E67 01/2001-09/2008	Lateral Arm - Rear Left Forward
ARM311	301181331100	BMW 750Li E65, E66, E67 01/2001-09/2008	Lateral Arm - Rear Left Forward
ARM311	301181331100	BMW 760i E65, E66, E67 01/2001-09/2008	Lateral Arm - Rear Left Forward
ARM311	301181331100	BMW 760Li E65, E66, E67 01/2001-09/2008	Lateral Arm - Rear Left Forward
ARM312	301181331200	BMW X5 F15,F85 11/2012-	Suspension Control Arm and Ball Joint Assembly - Front Right Lower Rearward
ARM312	301181331200	BMW X6 F15, F85 2014-	Suspension Control Arm and Ball Joint Assembly - Front Right Lower Rearward
ARM313	301181331300	BMW X5 F15,F85 11/2012-	Suspension Control Arm and Ball Joint Assembly - Front Left Lower Rearward
ARM313	301181331300	BMW X6 F15, F85 2014-	Suspension Control Arm and Ball Joint Assembly - Front Left Lower Rearward
ARM314	301181331400	BMW 525i E39 11/1995-06/2003	Lateral Arm - Rear
ARM314	301181331400	BMW 525i E60 - E61 07/2003-03/2010	Lateral Arm - Rear
ARM314	301181331400	BMW 528i E39 11/1995-06/2003	Lateral Arm - Rear
ARM314	301181331400	BMW 528i E60 - E61 07/2003-03/2010	Lateral Arm - Rear
ARM314	301181331400	BMW 530i E39 11/1995-06/2003	Lateral Arm - Rear
ARM314	301181331400	BMW 530i E60 - E61 07/2003-03/2010	Lateral Arm - Rear
ARM314	301181331400	BMW 535i E60 - E61 07/2003-03/2010	Lateral Arm - Rear
ARM314	301181331400	BMW 545i E60 - E61 07/2003-03/2010	Lateral Arm - Rear
ARM314	301181331400	BMW 550i E60 - E61 07/2003-03/2010	Lateral Arm - Rear
ARM314	301181331400	BMW 645Ci E63, E64 01/2004-11/2010	Lateral Arm - Rear
ARM314	301181331400	BMW 650Ci E63, E64 01/2004-11/2010	Lateral Arm - Rear
ARM314	301181331400	BMW 650i E63, E64 01/2004-11/2010	Lateral Arm - Rear
ARM314	301181331400	BMW 740i E38 1994-2002	Lateral Arm - Rear



 SHORT LONG			DESCRIPTION
ARM314	301181331400	BMW 740iL E38 1994-2002	Lateral Arm - Rear
ARM314	301181331400	BMW 745i E38 1994-2002	Lateral Arm - Rear
ARM314	301181331400	BMW 745i E65, E66, E67 01/2001-09/2008	Lateral Arm - Rear
ARM314	301181331400	BMW 745Li E38 1994-2002	Lateral Arm - Rear
ARM314	301181331400	BMW 745Li E65, E66, E67 01/2001-09/2008	Lateral Arm - Rear
ARM314	301181331400	BMW 750i E65, E66, E67 01/2001-09/2008	Lateral Arm - Rear
ARM314	301181331400	BMW 750iL E38 1994-2002	Lateral Arm - Rear
ARM314	301181331400	BMW 750Li E65, E66, E67 01/2001-09/2008	Lateral Arm - Rear
ARM314	301181331400	BMW 760i E65, E66, E67 01/2001-09/2008	Lateral Arm - Rear
ARM314	301181331400	BMW 760Li E65, E66, E67 01/2001-09/2008	Lateral Arm - Rear
ARM314	301181331400	BMW X5 E53 05/2000-01/2007	Lateral Arm - Rear
ARM315	301181331500	BMW X5 E53 05/2000-01/2007	Suspension Control Arm - Front Right Lower Forward
ARM316	301181331600	BMW X5 E53 05/2000-01/2007	Suspension Control Arm - Front Left Lower Forward
ARM317	301181331700	BMW X5 E53 05/2000-01/2007	Suspension Control Arm and Ball Joint Assembly - Front Right Lower Rearward
ARM318	301181331800	BMW X5 E53 05/2000-01/2007	Suspension Control Arm and Ball Joint Assembly - Front Left Lower Rearward
ARM319	301181331900	BMW X5 E53 05/2000-01/2007	Lateral Arm - Rear Right
ARM320	301181332000	BMW X5 E53 05/2000-01/2007	Lateral Arm - Rear Left
ARM321	301181332100	BMW X5 E53 05/2000-01/2007	Lateral Arm - Rear Upper
ARM322	301181332200	BMW 318i E36 1990-1998	Lateral Arm - Rear Lower
ARM322	301181332200	BMW 318is E36 1990-1998	Lateral Arm - Rear Lower
ARM322	301181332200	BMW 318ti E36 1990-1998	Lateral Arm - Rear Lower
ARM322	301181332200	BMW 320i E36 1990-1998	Lateral Arm - Rear Lower
ARM322	301181332200	BMW 320i E46 02/1998-04/2005	Lateral Arm - Rear Lower
ARM322	301181332200	BMW 323Ci E46 02/1998-04/2005	Lateral Arm - Rear Lower
ARM322	301181332200	BMW 323i E36 1990-1998	Lateral Arm - Rear Lower
ARM322	301181332200	BMW 323i E46 02/1998-04/2005	Lateral Arm - Rear Lower
ARM322	301181332200	BMW 323is E36 1990-1998	Lateral Arm - Rear Lower
ARM322	301181332200	BMW 325Ci E46 02/1998-04/2005	Lateral Arm - Rear Lower
ARM322	301181332200	BMW 325i E36 1990-1998	Lateral Arm - Rear Lower
ARM322	301181332200	BMW 325i E46 02/1998-04/2005	Lateral Arm - Rear Lower
ARM322	301181332200	BMW 325is E36 1990-1998	Lateral Arm - Rear Lower
ARM322	301181332200	BMW 328i E36 1990-1998	Lateral Arm - Rear Lower
ARM322	301181332200	BMW 328is E36 1990-1998	Lateral Arm - Rear Lower
ARM322	301181332200	BMW 330Ci E46 02/1998-04/2005	Lateral Arm - Rear Lower
ARM322	301181332200	BMW 330i E46 02/1998-04/2005	Lateral Arm - Rear Lower
ARM322	301181332200	BMW X3 E83 01/2004-08/2010	Lateral Arm - Rear Lower
ARM322	301181332200	BMW Z4 E85 02/2003-02/2009	Lateral Arm - Rear Lower
ARM323	301181332300	BMW X3 E83 01/2004-08/2010	Suspension Control Arm and Ball Joint Assembly - Front Right Lower Rearward



 SHORT LONG			DESCRIPTION
ARM324	301181332400	BMW X3 E83 01/2004-08/2010	Suspension Control Arm and Ball Joint Assembly - Front Left Lower Rearward
ARM325	301181332500	BMW X3 E83 01/2004-08/2010	Suspension Control Arm - Front Right Lower Forward
ARM326	301181332600	BMW X3 E83 01/2004-08/2010	Suspension Control Arm - Front Left Lower Forward
ARM327	301181332700	BMW X5 E70 02/2007-12/2012	Lateral Arm - Rear Right Upper Forward
ARM327	301181332700	BMW X6 E71, E72 04/2008-07/2014	Lateral Arm - Rear Right Upper Forward
ARM328	301181332800	BMW X5 E70 02/2007-12/2012	Lateral Arm - Rear Left Upper
ARM328	301181332800	BMW X6 E71, E72 04/2008-07/2014	Lateral Arm - Rear Left Upper
ARM329	301181332900	BMW X5 E70 02/2007-12/2012	Lateral Arm - Rear Right Upper Rearward
ARM329	301181332900	BMW X6 E71, E72 04/2008-07/2014	Lateral Arm - Rear Right Upper Rearward
ARM330	301181333000	BMW X5 E70 02/2007-12/2012	Lateral Arm - Rear Left
ARM330	301181333000	BMW X6 E71, E72 04/2008-07/2014	Lateral Arm - Rear Left
ARM331	301181333100	BMW X5 E70 02/2007-12/2012	Suspension Control Arm and Ball Joint Assembly - Front Right Lower
ARM332	301181333200	BMW X5 E70 02/2007-12/2012	Suspension Control Arm and Ball Joint Assembly - Front Left Lower
ARM333	301181333300	BMW X5 E70 02/2007-12/2012	Suspension Control Arm and Ball Joint Assembly - Front Right Lower Rearward
ARM334	301181333400	BMW X5 E70 02/2007-12/2012	Suspension Control Arm and Ball Joint Assembly - Front Left Lower Rearward
ARM335	301181333500	BMW X5 E70 02/2007-12/2012	Suspension Control Arm and Ball Joint Assembly - Front Right Upper
ARM335	301181333500	BMW X5 F15,F85 11/2012-	Suspension Control Arm and Ball Joint Assembly - Front Right Upper
ARM335	301181333500	BMW X6 E71, E72 04/2008-07/2014	Suspension Control Arm and Ball Joint Assembly - Front Right Upper
ARM336	301181333600	BMW X5 E70 02/2007-12/2012	Suspension Control Arm and Ball Joint Assembly - Front Left Upper
ARM336	301181333600	BMW X5 F15,F85 11/2012-	Suspension Control Arm and Ball Joint Assembly - Front Left Upper
ARM336	301181333600	BMW X6 E71, E72 04/2008-07/2014	Suspension Control Arm and Ball Joint Assembly - Front Left Upper
ARM337	301181333700	BMW X3 F25 09/2010-2016	Lateral Arm - Rear Upper
ARM338	301181333800	BMW X3 F25 09/2010-2016	Lateral Arm - Rear Lower
ARM339	301181333900	BMW X3 F25 09/2010-2016	Lateral Arm - Rear Right
ARM340	301181334000	BMW X3 F25 09/2010-2016	Lateral Arm - Rear Left
ARM341	301181334100	BMW X3 F25 09/2010-2016	Suspension Control Arm and Ball Joint Assembly - Front Right Lower Rearward
ARM341	301181334100	BMW X4 F26 04/2014-	Suspension Control Arm and Ball Joint Assembly - Front Right Lower Rearward
ARM342	301181334200	BMW X3 F25 09/2010-2016	Suspension Control Arm and Ball Joint Assembly - Front Left Lower Rearward
ARM342	301181334200	BMW X4 F26 04/2014-	Suspension Control Arm and Ball Joint Assembly - Front Left Lower Rearward
ARM343	301181334300	BMW X3 F25 09/2010-2016	Suspension Control Arm - Front Right Lower Forward



 SHORT LONG			DESCRIPTION
ARM343	301181334300	BMW X4 F26 04/2014-	Suspension Control Arm - Front Right Lower Forward
ARM344	301181334400	BMW X3 F25 09/2010-2016	Suspension Control Arm - Front Left Lower Forward
ARM344	301181334400	BMW X4 F26 04/2014-	Suspension Control Arm - Front Left Lower Forward
ARM345	301181334500	BMW 118i F 10/2011-	Lateral Arm - Rear
ARM345	301181334500	BMW 120i F 10/2011-	Lateral Arm - Rear
ARM345	301181334500	BMW 125i F 10/2011-	Lateral Arm - Rear
ARM345	301181334500	BMW 128i F 10/2011-	Lateral Arm - Rear
ARM345	301181334500	BMW 130i F 10/2011-	Lateral Arm - Rear
ARM345	301181334500	BMW 135i F 10/2011-	Lateral Arm - Rear
ARM345	301181334500	BMW 135is F 10/2011-	Lateral Arm - Rear
ARM345	301181334500	BMW 320i F 10/2011-	Lateral Arm - Rear
ARM345	301181334500	BMW 325i F 10/2011-	Lateral Arm - Rear
ARM345	301181334500	BMW 328d F 10/2011-	Lateral Arm - Rear
ARM345	301181334500	BMW 328i F 10/2011-	Lateral Arm - Rear
ARM345	301181334500	BMW 330i F 10/2011-	Lateral Arm - Rear
ARM345	301181334500	BMW 335i F 10/2011-	Lateral Arm - Rear
ARM345	301181334500	BMW 335is F 10/2011-	Lateral Arm - Rear
ARM345	301181334500	BMW 340i F 10/2011-	Lateral Arm - Rear
ARM345	301181334500	BMW 420i F 05/2014-	Lateral Arm - Rear
ARM345	301181334500	BMW 420i Gran Coupe F 05/2014-	Lateral Arm - Rear
ARM345	301181334500	BMW 428i F 05/2014-	Lateral Arm - Rear
ARM345	301181334500	BMW 428i Gran Coupe F 05/2014-	Lateral Arm - Rear
ARM345	301181334500	BMW 435i F 05/2014-	Lateral Arm - Rear
ARM345	301181334500	BMW 435i Gran Coupe F 05/2014-	Lateral Arm - Rear
ARM346	301181334600	BMW 520i F 2010-2016	Suspension Control Arm and Ball Joint Assembly - Front Right Lower Rearward
ARM346	301181334600	BMW 528i F 2010-2016	Suspension Control Arm and Ball Joint Assembly - Front Right Lower Rearward
ARM346	301181334600	BMW 530i F 2010-2016	Suspension Control Arm and Ball Joint Assembly - Front Right Lower Rearward
ARM346	301181334600	BMW 535d F 2010-2016	Suspension Control Arm and Ball Joint Assembly - Front Right Lower Rearward
ARM346	301181334600	BMW 535i F 2010-2016	Suspension Control Arm and Ball Joint Assembly - Front Right Lower Rearward
ARM346	301181334600	BMW 550i F 2010-2016	Suspension Control Arm and Ball Joint Assembly - Front Right Lower Rearward
ARM346	301181334600	BMW 640i F 2011-2016	Suspension Control Arm and Ball Joint Assembly - Front Right Lower Rearward
ARM346	301181334600	BMW 640i Gran Coupe F 2011-2016	Suspension Control Arm and Ball Joint Assembly - Front Right Lower Rearward
ARM346	301181334600	BMW 650i F 2011-2016	Suspension Control Arm and Ball Joint Assembly - Front Right Lower Rearward





 SHORT LONG			DESCRIPTION
ARM346	301181334600	BMW 650i Gran Coupe F 2011-2016	Suspension Control Arm and Ball Joint Assembly - Front Right Lower Rearward
ARM347	301181334700	BMW 520i F 2010-2016	Suspension Control Arm and Ball Joint Assembly - Front Left Lower Rearward
ARM347	301181334700	BMW 528i F 2010-2016	Suspension Control Arm and Ball Joint Assembly - Front Left Lower Rearward
ARM347	301181334700	BMW 530i F 2010-2016	Suspension Control Arm and Ball Joint Assembly - Front Left Lower Rearward
ARM347	301181334700	BMW 535d F 2010-2016	Suspension Control Arm and Ball Joint Assembly - Front Left Lower Rearward
ARM347	301181334700	BMW 535i F 2010-2016	Suspension Control Arm and Ball Joint Assembly - Front Left Lower Rearward
ARM347	301181334700	BMW 550i F 2010-2016	Suspension Control Arm and Ball Joint Assembly - Front Left Lower Rearward
ARM347	301181334700	BMW 640i F 2011-2016	Suspension Control Arm and Ball Joint Assembly - Front Left Lower Rearward
ARM347	301181334700	BMW 640i Gran Coupe F 2011-2016	Suspension Control Arm and Ball Joint Assembly - Front Left Lower Rearward
ARM347	301181334700	BMW 650i F 2011-2016	Suspension Control Arm and Ball Joint Assembly - Front Left Lower Rearward
ARM347	301181334700	BMW 650i Gran Coupe F 2011-2016	Suspension Control Arm and Ball Joint Assembly - Front Left Lower Rearward
ARM348	301181334800	BMW 740i F01, F02, F03,F04 06/2008-2016	Suspension Control Arm and Ball Joint Assembly - Front Right Lower Forward
ARM348	301181334800	BMW 740Li F01, F02, F03,F04 06/2008-2016	Suspension Control Arm and Ball Joint Assembly - Front Right Lower Forward
ARM348	301181334800	BMW 750i F01, F02, F03,F04 06/2008-2016	Suspension Control Arm and Ball Joint Assembly - Front Right Lower Forward
ARM348	301181334800	BMW 750Li F01, F02, F03,F04 06/2008-2016	Suspension Control Arm and Ball Joint Assembly - Front Right Lower Forward
ARM348	301181334800	BMW 760Li F01, F02, F03,F04 06/2008-2016	Suspension Control Arm and Ball Joint Assembly - Front Right Lower Forward
ARM349	301181334900	BMW 740i F01, F02, F03,F04 06/2008-2016	Suspension Control Arm and Ball Joint Assembly - Front Left Lower Forward
ARM349	301181334900	BMW 740Li F01, F02, F03,F04 06/2008-2016	Suspension Control Arm and Ball Joint Assembly - Front Left Lower Forward
ARM349	301181334900	BMW 750i F01, F02, F03,F04 06/2008-2016	Suspension Control Arm and Ball Joint Assembly - Front Left Lower Forward
ARM349	301181334900	BMW 750Li F01, F02, F03,F04 06/2008-2016	Suspension Control Arm and Ball Joint Assembly - Front Left Lower Forward
ARM349	301181334900	BMW 760Li F01, F02, F03,F04 06/2008-2016	Suspension Control Arm and Ball Joint Assembly - Front Left Lower Forward
ARM350	301181335000	BMW 520i F 2010-2016	Suspension Control Arm and Ball Joint Assembly - Front Upper
ARM350	301181335000	BMW 528i F 2010-2016	Suspension Control Arm and Ball Joint Assembly - Front Upper
ARM350	301181335000	BMW 530i F 2010-2016	Suspension Control Arm and Ball Joint Assembly - Front Upper
ARM350	301181335000	BMW 535d F 2010-2016	Suspension Control Arm and Ball Joint Assembly - Front Upper



 SHORT LONG			DESCRIPTION
ARM350	301181335000	BMW 535i F 2010-2016	Suspension Control Arm and Ball Joint Assembly - Front Upper
ARM350	301181335000	BMW 550i F 2010-2016	Suspension Control Arm and Ball Joint Assembly - Front Upper
ARM350	301181335000	BMW 640i F 2011-2016	Suspension Control Arm and Ball Joint Assembly - Front Upper
ARM350	301181335000	BMW 640i Gran Coupe F 2011-2016	Suspension Control Arm and Ball Joint Assembly - Front Upper
ARM350	301181335000	BMW 650i F 2011-2016	Suspension Control Arm and Ball Joint Assembly - Front Upper
ARM350	301181335000	BMW 650i Gran Coupe F 2011-2016	Suspension Control Arm and Ball Joint Assembly - Front Upper
ARM350	301181335000	BMW 740i F01, F02, F03,F04 06/2008-2016	Suspension Control Arm and Ball Joint Assembly - Front Upper
ARM350	301181335000	BMW 740Li F01, F02, F03,F04 06/2008-2016	Suspension Control Arm and Ball Joint Assembly - Front Upper
ARM350	301181335000	BMW 750i F01, F02, F03,F04 06/2008-2016	Suspension Control Arm and Ball Joint Assembly - Front Upper
ARM350	301181335000	BMW 750Li F01, F02, F03,F04 06/2008-2016	Suspension Control Arm and Ball Joint Assembly - Front Upper
ARM350	301181335000	BMW 760Li F01, F02, F03,F04 06/2008-2016	Suspension Control Arm and Ball Joint Assembly - Front Upper
ARM350	301181335000	BMW i8 2014-	Suspension Control Arm and Ball Joint Assembly - Front Upper
ARM351	301181335100	BMW 520i F 2010-2016	Suspension Control Arm and Ball Joint Assembly - Front Right Lower Forward
ARM351	301181335100	BMW 528i F 2010-2016	Suspension Control Arm and Ball Joint Assembly - Front Right Lower Forward
ARM351	301181335100	BMW 530i F 2010-2016	Suspension Control Arm and Ball Joint Assembly - Front Right Lower Forward
ARM351	301181335100	BMW 535d F 2010-2016	Suspension Control Arm and Ball Joint Assembly - Front Right Lower Forward
ARM351	301181335100	BMW 535i F 2010-2016	Suspension Control Arm and Ball Joint Assembly - Front Right Lower Forward
ARM351	301181335100	BMW 550i F 2010-2016	Suspension Control Arm and Ball Joint Assembly - Front Right Lower Forward
ARM351	301181335100	BMW 640i F 2011-2016	Suspension Control Arm and Ball Joint Assembly - Front Right Lower Forward
ARM351	301181335100	BMW 640i Gran Coupe F 2011-2016	Suspension Control Arm and Ball Joint Assembly - Front Right Lower Forward
ARM351	301181335100	BMW 650i F 2011-2016	Suspension Control Arm and Ball Joint Assembly - Front Right Lower Forward
ARM351	301181335100	BMW 650i Gran Coupe F 2011-2016	Suspension Control Arm and Ball Joint Assembly - Front Right Lower Forward
ARM352	301181335200	BMW 520i F 2010-2016	Suspension Control Arm and Ball Joint Assembly - Front Left Lower Forward
ARM352	301181335200	BMW 528i F 2010-2016	Suspension Control Arm and Ball Joint Assembly - Front Left Lower Forward
ARM352	301181335200	BMW 530i F 2010-2016	Suspension Control Arm and Ball Joint Assembly - Front Left Lower Forward





 SHORT LONG			DESCRIPTION
ARM352	301181335200	BMW 535d F 2010-2016	Suspension Control Arm and Ball Joint Assembly - Front Left Lower Forward
ARM352	301181335200	BMW 535i F 2010-2016	Suspension Control Arm and Ball Joint Assembly - Front Left Lower Forward
ARM352	301181335200	BMW 550i F 2010-2016	Suspension Control Arm and Ball Joint Assembly - Front Left Lower Forward
ARM352	301181335200	BMW 640i F 2011-2016	Suspension Control Arm and Ball Joint Assembly - Front Left Lower Forward
ARM352	301181335200	BMW 640i Gran Coupe F 2011-2016	Suspension Control Arm and Ball Joint Assembly - Front Left Lower Forward
ARM352	301181335200	BMW 650i F 2011-2016	Suspension Control Arm and Ball Joint Assembly - Front Left Lower Forward
ARM352	301181335200	BMW 650i Gran Coupe F 2011-2016	Suspension Control Arm and Ball Joint Assembly - Front Left Lower Forward
ARM353	301181335300	BMW 520i F 2010-2016	Lateral Arm - Rear
ARM353	301181335300	BMW 528i F 2010-2016	Lateral Arm - Rear
ARM353	301181335300	BMW 530i F 2010-2016	Lateral Arm - Rear
ARM353	301181335300	BMW 535d F 2010-2016	Lateral Arm - Rear
ARM353	301181335300	BMW 535i F 2010-2016	Lateral Arm - Rear
ARM353	301181335300	BMW 550i F 2010-2016	Lateral Arm - Rear
ARM353	301181335300	BMW 640i F 2011-2016	Lateral Arm - Rear
ARM353	301181335300	BMW 640i Gran Coupe F 2011-2016	Lateral Arm - Rear
ARM353	301181335300	BMW 650i F 2011-2016	Lateral Arm - Rear
ARM353	301181335300	BMW 650i Gran Coupe F 2011-2016	Lateral Arm - Rear
ARM353	301181335300	BMW 740i F01, F02, F03,F04 06/2008-2016	Lateral Arm - Rear
ARM353	301181335300	BMW 740Li F01, F02, F03,F04 06/2008-2016	Lateral Arm - Rear
ARM353	301181335300	BMW 750i F01, F02, F03,F04 06/2008-2016	Lateral Arm - Rear
ARM353	301181335300	BMW 750Li F01, F02, F03,F04 06/2008-2016	Lateral Arm - Rear
ARM353	301181335300	BMW 760Li F01, F02, F03,F04 06/2008-2016	Lateral Arm - Rear
ARM354	301181335400	BMW 740i F01, F02, F03,F04 06/2008-2016	Suspension Control Arm and Ball Joint Assembly - Front Right Lower Rearward
ARM354	301181335400	BMW 740Li F01, F02, F03,F04 06/2008-2016	Suspension Control Arm and Ball Joint Assembly - Front Right Lower Rearward
ARM354	301181335400	BMW 750i F01, F02, F03,F04 06/2008-2016	Suspension Control Arm and Ball Joint Assembly - Front Right Lower Rearward
ARM354	301181335400	BMW 750Li F01, F02, F03,F04 06/2008-2016	Suspension Control Arm and Ball Joint Assembly - Front Right Lower Rearward
ARM354	301181335400	BMW 760Li F01, F02, F03,F04 06/2008-2016	Suspension Control Arm and Ball Joint Assembly - Front Right Lower Rearward
ARM355	301181335500	BMW 740i F01, F02, F03,F04 06/2008-2016	Suspension Control Arm and Ball Joint Assembly - Front Left Lower Rearward
ARM355	301181335500	BMW 740Li F01, F02, F03,F04 06/2008-2016	Suspension Control Arm and Ball Joint Assembly - Front Left Lower Rearward
ARM355	301181335500	BMW 750i F01, F02, F03,F04 06/2008-2016	Suspension Control Arm and Ball Joint Assembly - Front Left Lower Rearward
ARM355	301181335500	BMW 750Li F01, F02, F03,F04 06/2008-2016	Suspension Control Arm and Ball Joint Assembly - Front Left Lower Rearward



			DESCRIPTION
SHORT	LONG		
ARM355	301181335500	BMW 760Li F01, F02, F03,F04 06/2008-2016	Suspension Control Arm and Ball Joint Assembly - Front Left Lower Rearward
ARM356	301181335600	BMW 740i F01, F02, F03,F04 06/2008-2016	Lateral Arm - Rear Right
ARM356	301181335600	BMW 740Li F01, F02, F03,F04 06/2008-2016	Lateral Arm - Rear Right
ARM356	301181335600	BMW 750i F01, F02, F03,F04 06/2008-2016	Lateral Arm - Rear Right
ARM356	301181335600	BMW 750Li F01, F02, F03,F04 06/2008-2016	Lateral Arm - Rear Right
ARM356	301181335600	BMW 760Li F01, F02, F03,F04 06/2008-2016	Lateral Arm - Rear Right
ARM357	301181335700	BMW 740i F01, F02, F03,F04 06/2008-2016	Lateral Arm - Rear Left
ARM357	301181335700	BMW 740Li F01, F02, F03,F04 06/2008-2016	Lateral Arm - Rear Left
ARM357	301181335700	BMW 750i F01, F02, F03,F04 06/2008-2016	Lateral Arm - Rear Left
ARM357	301181335700	BMW 750Li F01, F02, F03,F04 06/2008-2016	Lateral Arm - Rear Left
ARM357	301181335700	BMW 760Li F01, F02, F03,F04 06/2008-2016	Lateral Arm - Rear Left
ARM358	301181335800	BMW X3 F25 09/2010-2016	Lateral Arm - Rear
ARM358	301181335800	BMW X4 F26 04/2014-	Lateral Arm - Rear
ARM359	301181335900	BMW X5 E70 02/2007-12/2012	Lateral Arm - Rear
ARM359	301181335900	BMW X5 F15,F85 11/2012-	Lateral Arm - Rear
ARM359	301181335900	BMW X6 E71, E72 04/2008-07/2014	Lateral Arm - Rear
ARM360	301181336000	BMW 325xi E90/E91/E92/E93 (xDrive) 4x4 01/2005-12/2011	Suspension Control Arm and Ball Joint Assembly - Front
ARM360	301181336000	BMW 328xi E90/E91/E92/E93 (xDrive) 4x4 01/2005-12/2011	Suspension Control Arm and Ball Joint Assembly - Front
ARM360	301181336000	BMW 330xi E90/E91/E92/E93 (xDrive) 4x4 01/2005-12/2011	Suspension Control Arm and Ball Joint Assembly - Front
ARM360	301181336000	BMW 335xi E90/E91/E92/E93 (xDrive) 4x4 01/2005-12/2011	Suspension Control Arm and Ball Joint Assembly - Front
ARM360	301181336000	BMW X1 E84 10/2009-2016	Suspension Control Arm and Ball Joint Assembly - Front
ARM361	301181336100	BMW 525xi E60 - E61, AWD 07/2003-03/2010	Suspension Control Arm and Ball Joint Assembly - Front Right Rearward
ARM361	301181336100	BMW 528xi E60 - E61, AWD 07/2003-03/2010	Suspension Control Arm and Ball Joint Assembly - Front Right Rearward
ARM361	301181336100	BMW 530xi E60 - E61, AWD 07/2003-03/2010	Suspension Control Arm and Ball Joint Assembly - Front Right Rearward
ARM361	301181336100	BMW 535xi E60 - E61, AWD 07/2003-03/2010	Suspension Control Arm and Ball Joint Assembly - Front Right Rearward
ARM362	301181336200	BMW 525xi E60 - E61, AWD 07/2003-03/2010	Suspension Control Arm and Ball Joint Assembly - Front Left Rearward
ARM362	301181336200	BMW 528xi E60 - E61, AWD 07/2003-03/2010	Suspension Control Arm and Ball Joint Assembly - Front Left Rearward
ARM362	301181336200	BMW 530xi E60 - E61, AWD 07/2003-03/2010	Suspension Control Arm and Ball Joint Assembly - Front Left Rearward
ARM362	301181336200	BMW 535xi E60 - E61, AWD 07/2003-03/2010	Suspension Control Arm and Ball Joint Assembly - Front Left Rearward
ARM363	301181336300	CHEVROLET EVANDA V200 03/2003-09/2006	Suspension Control Arm and Ball Joint Assembly - Front Right Lower
ARM364	301181336400	CHEVROLET EVANDA V200 03/2003-09/2006	Suspension Control Arm and Ball Joint Assembly - Front Left Lower





 SHORT LONG			DESCRIPTION
ARM365	301181336500	CHEVROLET EPICA V250 01/2005-03/2011	Suspension Control Arm and Ball Joint Assembly - Front Right Lower
ARM366	301181336600	CHEVROLET EPICA V250 01/2005-03/2011	Suspension Control Arm and Ball Joint Assembly - Front Left Lower
ARM367	301181336700	BUICK VERANO 2012-2016	Suspension Control Arm and Ball Joint Assembly - Front Right Lower
ARM367	301181336700	CHEVROLET CRUZE 05/2009-2016	Suspension Control Arm and Ball Joint Assembly - Front Right Lower
ARM367	301181336700	CHEVROLET VOLT 1st Gen 2010-2015	Suspension Control Arm and Ball Joint Assembly - Front Right Lower
ARM368	301181336800	BUICK VERANO 2012-2016	Suspension Control Arm and Ball Joint Assembly - Front Left Lower
ARM368	301181336800	CHEVROLET CRUZE 05/2009-2016	Suspension Control Arm and Ball Joint Assembly - Front Left Lower
ARM368	301181336800	CHEVROLET VOLT 1st Gen 2010-2015	Suspension Control Arm and Ball Joint Assembly - Front Left Lower
ARM369	301181336900	CHEVROLET IMPALA 8th, 9th Gen 2000-2013	Suspension Control Arm and Ball Joint Assembly - Front Right
ARM370	301181337000	CHEVROLET IMPALA 8th, 9th Gen 2000-2013	Suspension Control Arm and Ball Joint Assembly - Front Left
ARM371	301181337100	CHEVROLET AVEO T250 05/2005-02/2011	Suspension Control Arm and Ball Joint Assembly - Front Right Lower
ARM371	301181337100	DAEWOO KALOS (KLAS) 09/2002-03/2011	Suspension Control Arm and Ball Joint Assembly - Front Right Lower
ARM371	301181337100	PONTIAC G3 2007-2009	Suspension Control Arm and Ball Joint Assembly - Front Right Lower
ARM372	301181337200	CHEVROLET AVEO T250 05/2005-02/2011	Suspension Control Arm and Ball Joint Assembly - Front Left Lower
ARM372	301181337200	DAEWOO KALOS (KLAS) 09/2002-03/2011	Suspension Control Arm and Ball Joint Assembly - Front Left Lower
ARM372	301181337200	PONTIAC G3 2007-2009	Suspension Control Arm and Ball Joint Assembly - Front Left Lower
ARM373	301181337300	CHEVROLET EQUINOX 2005-2009	Suspension Control Arm and Ball Joint Assembly - Front Right
ARM373	301181337300	PONTIAC TORRENT 2006-2009	Suspension Control Arm and Ball Joint Assembly - Front Right
ARM373	301181337300	SATURN VUE 2002-2007	Suspension Control Arm and Ball Joint Assembly - Front Right
ARM374	301181337400	CHEVROLET EQUINOX 2005-2009	Suspension Control Arm and Ball Joint Assembly - Front Left
ARM374	301181337400	PONTIAC TORRENT 2006-2009	Suspension Control Arm and Ball Joint Assembly - Front Left
ARM374	301181337400	SATURN VUE 2002-2007	Suspension Control Arm and Ball Joint Assembly - Front Left
ARM375	301181337500	CHEVROLET EQUINOX 2005-2009	Lateral Arm - Rear
ARM375	301181337500	CHEVROLET EQUINOX 2nd Gen 2010-2016	Lateral Arm - Rear
ARM375	301181337500	GMC TERRAIN 2010-	Lateral Arm - Rear
ARM376	301181337600	CHEVROLET EQUINOX 2nd Gen 2010-2016	Suspension Control Arm and Ball Joint Assembly - Front Right Lower
ARM376	301181337600	GMC TERRAIN 2010-	Suspension Control Arm and Ball Joint Assembly - Front Right Lower



 SHORT LONG			DESCRIPTION
ARM377	301181337700	CHEVROLET EQUINOX 2nd Gen 2010-2016	Suspension Control Arm and Ball Joint Assembly - Front Left Lower
ARM377	301181337700	GMC TERRAIN 2010-	Suspension Control Arm and Ball Joint Assembly - Front Left Lower
ARM378	301181337800	CHEVROLET AVEO T300 03/2011-2016	Suspension Control Arm and Ball Joint Assembly - Front Right Lower
ARM379	301181337900	CHEVROLET AVEO T300 03/2011-2016	Suspension Control Arm and Ball Joint Assembly - Front Left Lower
ARM380	301181338000	CHEVROLET LACETTI J200 (OPTRA) 03/2003-04/2012	Suspension Control Arm and Ball Joint Assembly - Front Right Lower
ARM380	301181338000	CHEVROLET OPTRA J200 03/2003-04/2012	Suspension Control Arm and Ball Joint Assembly - Front Right Lower
ARM380	301181338000	DAEWOO NUBIRA II (1.6i, 1.8i) 07/2003-2009	Suspension Control Arm and Ball Joint Assembly - Front Right Lower
ARM380	301181338000	SUZUKI RENO 1st Gen J200 2004-2008	Suspension Control Arm and Ball Joint Assembly - Front Right Lower
ARM381	301181338100	CHEVROLET LACETTI J200 (OPTRA) 03/2003-04/2012	Suspension Control Arm and Ball Joint Assembly - Front Left Lower
ARM381	301181338100	CHEVROLET OPTRA J200 03/2003-04/2012	Suspension Control Arm and Ball Joint Assembly - Front Left Lower
ARM381	301181338100	DAEWOO NUBIRA II (1.6i, 1.8i) 07/2003-2009	Suspension Control Arm and Ball Joint Assembly - Front Left Lower
ARM381	301181338100	SUZUKI RENO 1st Gen J200 2004-2008	Suspension Control Arm and Ball Joint Assembly - Front Left Lower
ARM382	301181338200	CHEVROLET LACETTI J200 (OPTRA) 03/2003-04/2012	Suspension Control Arm and Ball Joint Assembly - Front Right
ARM383	301181338300	CHEVROLET LACETTI J200 (OPTRA) 03/2003-04/2012	Suspension Control Arm and Ball Joint Assembly - Front Left
ARM384	301181338400	BUICK LACROSSE 2nd Gen 2010-2016	Suspension Control Arm and Ball Joint Assembly - Front Right Lower
ARM384	301181338400	BUICK REGAL 5th Gen 2011-2016	Suspension Control Arm and Ball Joint Assembly - Front Right Lower
ARM384	301181338400	CHEVROLET MALIBU 8th Gen 2013-2016	Suspension Control Arm and Ball Joint Assembly - Front Right Lower
ARM384	301181338400	CHEVROLET MALIBU 9th Gen 2016-	Suspension Control Arm and Ball Joint Assembly - Front Right Lower
ARM385	301181338500	BUICK LACROSSE 2nd Gen 2010-2016	Suspension Control Arm and Ball Joint Assembly - Front Left Lower
ARM385	301181338500	BUICK REGAL 5th Gen 2011-2016	Suspension Control Arm and Ball Joint Assembly - Front Left Lower
ARM385	301181338500	CHEVROLET MALIBU 8th Gen 2013-2016	Suspension Control Arm and Ball Joint Assembly - Front Left Lower
ARM385	301181338500	CHEVROLET MALIBU 9th Gen 2016-	Suspension Control Arm and Ball Joint Assembly - Front Left Lower
ARM386	301181338600	CHEVROLET MALIBU 7th Gen 2004-2012	Suspension Control Arm and Ball Joint Assembly - Front Right Lower
ARM386	301181338600	PONTIAC G6 2005-2010	Suspension Control Arm and Ball Joint Assembly - Front Right Lower
ARM387	301181338700	CHEVROLET MALIBU 7th Gen 2004-2012	Suspension Control Arm and Ball Joint Assembly - Front Left Lower



 SHORT LONG			DESCRIPTION
ARM387	301181338700	PONTIAC G6 2005-2010	Suspension Control Arm and Ball Joint Assembly - Front Left Lower
ARM388	301181338800	CHEVROLET REZZO U100 (VIVANT) 2004-2009	Suspension Control Arm and Ball Joint Assembly - Front Right Lower
ARM388	301181338800	CHEVROLET TACUMA 2000-2008	Suspension Control Arm and Ball Joint Assembly - Front Right Lower
ARM388	301181338800	DAEWOO REZZO (KLAU) 09/2000-02/2011	Suspension Control Arm and Ball Joint Assembly - Front Right Lower
ARM389	301181338900	CHEVROLET REZZO U100 (VIVANT) 2004-2009	Suspension Control Arm and Ball Joint Assembly - Front Left Lower
ARM389	301181338900	CHEVROLET TACUMA 2000-2008	Suspension Control Arm and Ball Joint Assembly - Front Left Lower
ARM389	301181338900	DAEWOO REZZO (KLAU) 09/2000-02/2011	Suspension Control Arm and Ball Joint Assembly - Front Left Lower
ARM390	301181339000	CHEVROLET CAPTIVA 06/2006-05/2010	Suspension Control Arm and Ball Joint Assembly - Front Right Lower
ARM390	301181339000	OPEL ANTARA 05/2006-	Suspension Control Arm and Ball Joint Assembly - Front Right Lower
ARM391	301181339100	CHEVROLET CAPTIVA 06/2006-05/2010	Suspension Control Arm and Ball Joint Assembly - Front Left Lower
ARM391	301181339100	OPEL ANTARA 05/2006-	Suspension Control Arm and Ball Joint Assembly - Front Left Lower
ARM392	301181339200	CHEVROLET CAMARO 5th Gen 2010-2015	Suspension Control Arm and Ball Joint Assembly - Front Right Lower Forward
ARM393	301181339300	CHEVROLET CAMARO 5th Gen 2010-2015	Suspension Control Arm and Ball Joint Assembly - Front Left Lower Forward
ARM394	301181339400	CHEVROLET CAMARO 5th Gen 2010-2015	Suspension Control Arm and Ball Joint Assembly - Front Right
ARM395	301181339500	CHEVROLET CAMARO 5th Gen 2010-2015	Suspension Control Arm and Ball Joint Assembly - Front Left
ARM396	301181339600	CHEVROLET SPARK M300 03/2010-2016	Suspension Control Arm and Ball Joint Assembly - Front Right Lower
ARM397	301181339700	CHEVROLET SPARK M300 03/2010-2016	Suspension Control Arm and Ball Joint Assembly - Front Left Lower
ARM398	301181339800	CHEVROLET SILVERADO 1500 2nd Gen, GMT900 2009-2013	Suspension Control Arm and Ball Joint Assembly - Front Right Lower
ARM398	301181339800	CHEVROLET TAHOE 3rd Gen, GMT900 2007-2014	Suspension Control Arm and Ball Joint Assembly - Front Right Lower
ARM398	301181339800	GMC SIERRA 1500 2nd Gen, GMT900 2007-2013	Suspension Control Arm and Ball Joint Assembly - Front Right Lower
ARM398	301181339800	GMC YUKON GMT900 2007-2014	Suspension Control Arm and Ball Joint Assembly - Front Right Lower
ARM399	301181339900	CHEVROLET SILVERADO 1500 2nd Gen, GMT900 2009-2013	Suspension Control Arm and Ball Joint Assembly - Front Left Lower
ARM399	301181339900	CHEVROLET TAHOE 3rd Gen, GMT900 2007-2014	Suspension Control Arm and Ball Joint Assembly - Front Left Lower
ARM399	301181339900	GMC SIERRA 1500 2nd Gen, GMT900 2007-2013	Suspension Control Arm and Ball Joint Assembly - Front Left Lower
ARM399	301181339900	GMC YUKON GMT900 2007-2014	Suspension Control Arm and Ball Joint Assembly - Front Left Lower
ARM400	301181340000	BUICK RAINIER 1st Gen 2003-2007	Suspension Control Arm - Front Right



 SHORT LONG			DESCRIPTION
ARM400	301181340000	CHEVROLET SSR 2003-2005	Suspension Control Arm - Front Right
ARM400	301181340000	CHEVROLET TRAILBLAZER 1st Gen 2002-2008	Suspension Control Arm - Front Right
ARM400	301181340000	GMC ENVOY 2nd Gen 2002-2009	Suspension Control Arm - Front Right
ARM400	301181340000	ISUZU ASCENDER 2003-2008	Suspension Control Arm - Front Right
ARM400	301181340000	OLDSMOBILE BRAVADA 3rd Gen 2002-2003	Suspension Control Arm - Front Right
ARM400	301181340000	SAAB 9_7X 2005-2009	Suspension Control Arm - Front Right
ARM401	301181340100	BUICK RAINIER 1st Gen 2003-2007	Suspension Control Arm - Front Left
ARM401	301181340100	CHEVROLET SSR 2003-2005	Suspension Control Arm - Front Left
ARM401	301181340100	CHEVROLET TRAILBLAZER 1st Gen 2002-2008	Suspension Control Arm - Front Left
ARM401	301181340100	GMC ENVOY 2nd Gen 2002-2009	Suspension Control Arm - Front Left
ARM401	301181340100	ISUZU ASCENDER 2003-2008	Suspension Control Arm - Front Left
ARM401	301181340100	OLDSMOBILE BRAVADA 3rd Gen 2002-2003	Suspension Control Arm - Front Left
ARM401	301181340100	SAAB 9_7X 2005-2009	Suspension Control Arm - Front Left
ARM402	301181340200	BUICK ENCLAVE 1st Gen 2008-2015	Lateral Arm - Rear Upper
ARM402	301181340200	CHEVROLET TRAVERSE 1st Gen 2009-2015	Lateral Arm - Rear Upper
ARM402	301181340200	GMC ACADIA 2007-2017	Lateral Arm - Rear Upper
ARM403	301181340300	BUICK ENCLAVE 1st Gen 2008-2015	Lateral Arm - Rear Lower
ARM403	301181340300	CHEVROLET TRAVERSE 1st Gen 2009-2015	Lateral Arm - Rear Lower
ARM403	301181340300	GMC ACADIA 2007-2017	Lateral Arm - Rear Lower
ARM404	301181340400	CHEVROLET TRAVERSE 1st Gen 2009-2015	Suspension Control Arm and Ball Joint Assembly - Front Right Lower
ARM404	301181340400	GMC ACADIA 1st Gen 2007-2014	Suspension Control Arm and Ball Joint Assembly - Front Right Lower
ARM405	301181340500	CHEVROLET TRAVERSE 1st Gen 2009-2015	Suspension Control Arm and Ball Joint Assembly - Front Left Lower
ARM405	301181340500	GMC ACADIA 1st Gen 2007-2014	Suspension Control Arm and Ball Joint Assembly - Front Left Lower
ARM406	301181340600	CITROEN EVASION 1st Gen 1995-2003	Suspension Control Arm and Ball Joint Assembly - Front Right
ARM406	301181340600	FIAT SCUDO 02/1996-08/2002	Suspension Control Arm and Ball Joint Assembly - Front Right
ARM406	301181340600	PEUGEOT EXPERT 224 07/1995-12/2006	Suspension Control Arm and Ball Joint Assembly - Front Right
ARM407	301181340700	CITROEN EVASION 1st Gen 1995-2003	Suspension Control Arm and Ball Joint Assembly - Front Right
ARM407	301181340700	FIAT SCUDO 02/1996-08/2002	Suspension Control Arm and Ball Joint Assembly - Front Left
ARM407	301181340700	PEUGEOT EXPERT 224 07/1995-12/2006	Suspension Control Arm and Ball Joint Assembly - Front Right
ARM408	301181340800	CITROEN C-ELYSEE 11/2012-	Suspension Control Arm and Ball Joint Assembly - Front Right
ARM408	301181340800	PEUGEOT 301 11/2012-	Suspension Control Arm and Ball Joint Assembly - Front Right
ARM409	301181340900	CITROEN C-ELYSEE 11/2012-	Suspension Control Arm and Ball Joint Assembly - Front Left





 SHORT LONG			DESCRIPTION
ARM409	301181340900	PEUGEOT 301 11/2012-	Suspension Control Arm and Ball Joint Assembly - Front Left
ARM410	301181341000	CITROEN BERLINGO MF 07/1996-	Suspension Control Arm and Ball Joint Assembly - Front Right Lower
ARM410	301181341000	CITROEN XSARA 1997-2005	Suspension Control Arm and Ball Joint Assembly - Front Right Lower
ARM410	301181341000	CITROEN ZX 1991-1997	Suspension Control Arm and Ball Joint Assembly - Front Right Lower
ARM411	301181341100	CITROEN BERLINGO MF 07/1996-	Suspension Control Arm and Ball Joint Assembly - Front Left Lower
ARM411	301181341100	CITROEN XSARA 1997-2005	Suspension Control Arm and Ball Joint Assembly - Front Left Lower
ARM411	301181341100	CITROEN ZX 1991-1997	Suspension Control Arm and Ball Joint Assembly - Front Left Lower
ARM412	301181341200	CITROEN BERLINGO MF 07/1996-	Suspension Control Arm and Ball Joint Assembly - Front Right Lower
ARM412	301181341200	CITROEN XSARA 1997-2005	Suspension Control Arm and Ball Joint Assembly - Front Right Lower
ARM412	301181341200	CITROEN ZX 1991-1997	Suspension Control Arm and Ball Joint Assembly - Front Right Lower
ARM412	301181341200	PEUGEOT PARTNER I 05/1996-	Suspension Control Arm and Ball Joint Assembly - Front Right Lower
ARM413	301181341300	CITROEN BERLINGO MF 07/1996-	Suspension Control Arm and Ball Joint Assembly - Front Left Lower
ARM413	301181341300	CITROEN XSARA 1997-2005	Suspension Control Arm and Ball Joint Assembly - Front Left Lower
ARM413	301181341300	CITROEN ZX 1991-1997	Suspension Control Arm and Ball Joint Assembly - Front Left Lower
ARM413	301181341300	PEUGEOT PARTNER I 05/1996-	Suspension Control Arm and Ball Joint Assembly - Front Left Lower
ARM414	301181341400	CITROEN BERLINGO MF 07/1996-	Suspension Control Arm and Ball Joint Assembly - Front Right Lower
ARM414	301181341400	CITROEN XSARA PICASSO 12/1999-2012	Suspension Control Arm and Ball Joint Assembly - Front Right Lower
ARM414	301181341400	PEUGEOT PARTNER I 05/1996-	Suspension Control Arm and Ball Joint Assembly - Front Right Lower
ARM415	301181341500	CITROEN BERLINGO MF 07/1996-	Suspension Control Arm and Ball Joint Assembly - Front Left
ARM415	301181341500	CITROEN XSARA PICASSO 12/1999-2012	Suspension Control Arm and Ball Joint Assembly - Front Left
ARM415	301181341500	PEUGEOT PARTNER I 05/1996-	Suspension Control Arm and Ball Joint Assembly - Front Left
ARM416	301181341600	CITROEN XANTIA BREAK 1993-2003	Suspension Control Arm - Front Right Lower
ARM417	301181341700	CITROEN XANTIA BREAK 1993-2003	Suspension Control Arm - Front Left
ARM418	301181341800	CITROEN C4 B7 11/2009-	Suspension Control Arm - Front Right Lower
ARM418	301181341800	PEUGEOT 5008 09/2009-	Suspension Control Arm - Front Right Lower
ARM419	301181341900	CITROEN C4 B7 11/2009-	Suspension Control Arm - Front Left Lower
ARM419	301181341900	PEUGEOT 5008 09/2009-	Suspension Control Arm - Front Left Lower
ARM420	301181342000	CITROEN C2 JM 09/2003-09/2009	Suspension Control Arm and Ball Joint Assembly - Front Right Lower



			DESCRIPTION
SHORT	LONG		
ARM420	301181342000	CITROEN C3 FC 03/2003-10/2009	Suspension Control Arm and Ball Joint Assembly - Front Right Lower
ARM421	301181342100	CITROEN C2 JM 09/2003-09/2009	Suspension Control Arm and Ball Joint Assembly - Front Left Lower
ARM421	301181342100	CITROEN C3 FC 03/2003-10/2009	Suspension Control Arm and Ball Joint Assembly - Front Left Lower
ARM422	301181342200	CITROEN C3 II 11/2009-2016	Suspension Control Arm and Ball Joint Assembly - Front Right Lower
ARM422	301181342200	CITROEN C4 CACTUS 09/2014-	Suspension Control Arm and Ball Joint Assembly - Front Right Lower
ARM422	301181342200	CITROEN DS3 II 2009-2016	Suspension Control Arm and Ball Joint Assembly - Front Right Lower
ARM422	301181342200	PEUGEOT 2008 2013-	Suspension Control Arm and Ball Joint Assembly - Front Right Lower
ARM423	301181342300	CITROEN C3 II 11/2009-2016	Suspension Control Arm and Ball Joint Assembly - Front Left Lower
ARM423	301181342300	CITROEN C4 CACTUS 09/2014-	Suspension Control Arm and Ball Joint Assembly - Front Left Lower
ARM423	301181342300	CITROEN DS3 II 2009-2016	Suspension Control Arm and Ball Joint Assembly - Front Left Lower
ARM423	301181342300	PEUGEOT 2008 2013-	Suspension Control Arm and Ball Joint Assembly - Front Left Lower
ARM424	301181342400	CITROEN C5 DC 03/2001-08/2004	Suspension Control Arm - Front Right Lower
ARM425	301181342500	CITROEN C5 DC 03/2001-08/2004	Suspension Control Arm - Front Left Lower
ARM426	301181342600	CITROEN C5 RD 02/2008-	Suspension Control Arm - Front Right Lower
ARM427	301181342700	CITROEN C5 RD 02/2008-	Suspension Control Arm - Front Left Lower
ARM428	301181342800	CITROEN C5 RD 02/2008-	Suspension Control Arm and Ball Joint Assembly - Front Right
ARM429	301181342900	CITROEN C5 RD 02/2008-	Suspension Control Arm - Front Left
ARM430	301181343000	CITROEN C5 RD 02/2008-	Lateral Arm - Rear Right Lower
ARM430	301181343000	PEUGEOT 407 05/2004-12/2011	Lateral Arm - Rear Right Lower
ARM430	301181343000	PEUGEOT 508 11/2010-	Lateral Arm - Rear Right Lower
ARM431	301181343100	CITROEN C5 RD 02/2008-	Lateral Arm - Rear Left
ARM431	301181343100	PEUGEOT 407 05/2004-12/2011	Lateral Arm - Rear Left
ARM431	301181343100	PEUGEOT 508 11/2010-	Lateral Arm - Rear Left
ARM432	301181343200	CITROEN C5 RD 02/2008-	Lateral Arm - Rear Right Upper
ARM432	301181343200	CITROEN C6 TD 09/2005-09/2012	Lateral Arm - Rear Right Upper
ARM432	301181343200	PEUGEOT 407 05/2004-12/2011	Lateral Arm - Rear Right Upper
ARM432	301181343200	PEUGEOT 508 11/2010-	Lateral Arm - Rear Right Upper
ARM433	301181343300	CITROEN C5 RD 02/2008-	Lateral Arm - Rear Left Upper
ARM433	301181343300	CITROEN C6 TD 09/2005-09/2012	Lateral Arm - Rear Left Upper
ARM433	301181343300	PEUGEOT 407 05/2004-12/2011	Lateral Arm - Rear Left Upper
ARM433	301181343300	PEUGEOT 508 11/2010-	Lateral Arm - Rear Left Upper
ARM434	301181343400	CHRYSLER GRAND VOYAGER IV 2000-2008	Suspension Control Arm - Front Right Lower
ARM435	301181343500	CHRYSLER GRAND VOYAGER IV 2000-2008	Suspension Control Arm - Front Left Lower





 SHORT LONG			DESCRIPTION
ARM436	301181343600	CHRYSLER GRAND VOYAGER IV 2001-2003	Suspension Control Arm and Ball Joint Assembly - Front Right Lower
ARM436	301181343600	CHRYSLER TOWN & COUNTRY IV 2001-2007	Suspension Control Arm and Ball Joint Assembly - Front Right Lower
ARM436	301181343600	DODGE CARAVAN 4th Gen 2001-2007	Suspension Control Arm and Ball Joint Assembly - Front Right Lower
ARM437	301181343700	CHRYSLER GRAND VOYAGER IV 2001-2003	Suspension Control Arm and Ball Joint Assembly - Front Left Lower
ARM437	301181343700	CHRYSLER TOWN & COUNTRY IV 2001-2007	Suspension Control Arm and Ball Joint Assembly - Front Left Lower
ARM437	301181343700	DODGE CARAVAN 4th Gen 2001-2007	Suspension Control Arm and Ball Joint Assembly - Front Left Lower
ARM438	301181343800	CHRYSLER TOWN & COUNTRY V 2008-2016	Suspension Control Arm and Ball Joint Assembly - Front Right Lower
ARM438	301181343800	DODGE GRAND CARAVAN V 2008-2016	Suspension Control Arm and Ball Joint Assembly - Front Right Lower
ARM439	301181343900	CHRYSLER TOWN & COUNTRY V 2008-2016	Suspension Control Arm and Ball Joint Assembly - Front Left Lower
ARM439	301181343900	DODGE GRAND CARAVAN V 2008-2016	Suspension Control Arm and Ball Joint Assembly - Front Left Lower
ARM440	301181344000	CHRYSLER 200 1st Gen 2011-2014	Suspension Control Arm - Front Right Lower
ARM440	301181344000	CHRYSLER SEBRING JS 3rd Gen 07/2007-12/2010	Suspension Control Arm - Front Right Lower
ARM440	301181344000	DODGE AVENGER 1st Gen 2011-2014	Suspension Control Arm - Front Right Lower
ARM441	301181344100	CHRYSLER 200 1st Gen 2011-2014	Suspension Control Arm - Front Left Lower
ARM441	301181344100	CHRYSLER SEBRING JS 3rd Gen 07/2007-12/2010	Suspension Control Arm - Front Left Lower
ARM441	301181344100	DODGE AVENGER 1st Gen 2011-2014	Suspension Control Arm - Front Left Lower
ARM442	301181344200	CHRYSLER 300 1st Gen 2005-2010	Suspension Control Arm and Ball Joint Assembly - Front Right
ARM442	301181344200	DODGE CHALLENGER 4th Gen 2008-	Suspension Control Arm and Ball Joint Assembly - Front Right
ARM442	301181344200	DODGE CHARGER 6th Gen 2005-2010	Suspension Control Arm and Ball Joint Assembly - Front Right
ARM443	301181344300	CHRYSLER 300 1st Gen 2005-2010	Suspension Control Arm and Ball Joint Assembly - Front Left
ARM443	301181344300	DODGE CHALLENGER 4th Gen 2008-	Suspension Control Arm and Ball Joint Assembly - Front Left
ARM443	301181344300	DODGE CHARGER 6th Gen 2005-2010	Suspension Control Arm and Ball Joint Assembly - Front Left
ARM444	301181344400	CHRYSLER SEBRING FJ/JX 1995-2000	Suspension Control Arm and Ball Joint Assembly - Front Right
ARM444	301181344400	CHRYSLER SEBRING ST22/JR 2001-2006	Suspension Control Arm and Ball Joint Assembly - Front Right
ARM444	301181344400	DODGE STRATUS 2nd Gen 1995-2006	Suspension Control Arm and Ball Joint Assembly - Front Right
ARM445	301181344500	CHRYSLER SEBRING FJ/JX 1995-2000	Suspension Control Arm and Ball Joint Assembly - Front Left
ARM445	301181344500	CHRYSLER SEBRING ST22/JR 2001-2006	Suspension Control Arm and Ball Joint Assembly - Front Left



 SHORT LONG			DESCRIPTION
ARM445	301181344500	DODGE STRATUS 2nd Gen 1995-2006	Suspension Control Arm and Ball Joint Assembly - Front Left
ARM446	301181344600	DACIA LOGAN (LS) 09/2004-11/2012	Suspension Control Arm and Ball Joint Assembly - Front Right Lower
ARM446	301181344600	DACIA LOGAN MCV (KS) 02/2007-01/2013	Suspension Control Arm and Ball Joint Assembly - Front Right Lower
ARM446	301181344600	DACIA SANDERO I 06/2008-12/2012	Suspension Control Arm and Ball Joint Assembly - Front Right Lower
ARM447	301181344700	DACIA LOGAN (LS) 09/2004-11/2012	Suspension Control Arm and Ball Joint Assembly - Front Left Lower
ARM447	301181344700	DACIA LOGAN MCV (KS) 02/2007-01/2013	Suspension Control Arm and Ball Joint Assembly - Front Left Lower
ARM447	301181344700	DACIA SANDERO I 06/2008-12/2012	Suspension Control Arm and Ball Joint Assembly - Front Left Lower
ARM448	301181344800	DACIA DUSTER 04/2010-	Suspension Control Arm and Ball Joint Assembly - Front Right Lower
ARM449	301181344900	DACIA DUSTER 04/2010-	Suspension Control Arm and Ball Joint Assembly - Front Left Lower
ARM450	301181345000	DACIA DUSTER 04/2010-	Lateral Arm - Rear Right
ARM451	301181345100	DACIA DUSTER 04/2010-	Lateral Arm - Rear Left
ARM452	301181345200	DACIA DUSTER 04/2010-	Lateral Arm - Rear Center
ARM453	301181345300	DACIA DUSTER 04/2010-	Lateral Arm - Rear Lower
ARM454	301181345400	CHRYSLER 300 2nd Gen 2011-2017	Suspension Control Arm and Ball Joint Assembly - Front Right Lower
ARM454	301181345400	DODGE CHALLENGER 4th Gen 2008-	Suspension Control Arm and Ball Joint Assembly - Front Right Lower
ARM454	301181345400	DODGE CHARGER 7th Gen 2011-	Suspension Control Arm and Ball Joint Assembly - Front Right Lower
ARM455	301181345500	CHRYSLER 300 2nd Gen 2011-2017	Suspension Control Arm and Ball Joint Assembly - Front Left Lower
ARM455	301181345500	DODGE CHALLENGER 4th Gen 2008-	Suspension Control Arm and Ball Joint Assembly - Front Left Lower
ARM455	301181345500	DODGE CHARGER 7th Gen 2011-	Suspension Control Arm and Ball Joint Assembly - Front Left Lower
ARM456	301181345600	CHRYSLER 300 2nd Gen 2011-2017	Suspension Control Arm and Ball Joint Assembly - Front Right Lower
ARM456	301181345600	DODGE CHALLENGER 4th Gen 2008-	Suspension Control Arm and Ball Joint Assembly - Front Right Lower
ARM456	301181345600	DODGE CHARGER 7th Gen 2011-	Suspension Control Arm and Ball Joint Assembly - Front Right Lower
ARM457	301181345700	CHRYSLER 300 2nd Gen 2011-2017	Suspension Control Arm and Ball Joint Assembly - Front Left Lower
ARM457	301181345700	DODGE CHALLENGER 4th Gen 2008-	Suspension Control Arm and Ball Joint Assembly - Front Left Lower
ARM457	301181345700	DODGE CHARGER 7th Gen 2011-	Suspension Control Arm and Ball Joint Assembly - Front Left Lower
ARM458	301181345800	CHRYSLER 300 2nd Gen 2011-2017	Suspension Control Arm - Front Lower
ARM458	301181345800	DODGE CHALLENGER 4th Gen 2008-	Suspension Control Arm - Front Lower
ARM458	301181345800	DODGE CHARGER 7th Gen 2011-	Suspension Control Arm - Front Lower





 SHORT LONG			DESCRIPTION
ARM459	301181345900	CHRYSLER 300 1st Gen 2005-2010	Suspension Control Arm - Rear Lower Forward
ARM459	301181345900	DODGE CHALLENGER 4th Gen 2008-	Suspension Control Arm - Rear Lower Forward
ARM459	301181345900	DODGE CHARGER 6th Gen 2005-2010	Suspension Control Arm - Rear Lower Forward
ARM460	301181346000	DODGE DURANGO 3rd Gen 2011-2017	Lateral Arm - Rear
ARM460	301181346000	JEEP GRAND CHEROKEE WK2 2011-	Lateral Arm - Rear
ARM461	301181346100	DODGE DURANGO 3rd Gen 2011-2017	Suspension Control Arm and Ball Joint Assembly - Front Right Upper
ARM461	301181346100	JEEP GRAND CHEROKEE WK2 2011-	Suspension Control Arm and Ball Joint Assembly - Front Right Upper
ARM462	301181346200	DODGE DURANGO 3rd Gen 2011-2017	Suspension Control Arm and Ball Joint Assembly - Front Left Upper
ARM462	301181346200	JEEP GRAND CHEROKEE WK2 2011-	Suspension Control Arm and Ball Joint Assembly - Front Left Upper
ARM463	301181346300	DODGE DURANGO 3rd Gen 2011-2017	Suspension Control Arm - Front Right Lower
ARM463	301181346300	JEEP GRAND CHEROKEE WK2 2011-	Suspension Control Arm - Front Right Lower
ARM464	301181346400	DODGE DURANGO 3rd Gen 2011-2017	Suspension Control Arm - Front Left Lower
ARM464	301181346400	JEEP GRAND CHEROKEE WK2 2011-	Suspension Control Arm - Front Left Lower
ARM465	301181346500	CHRYSLER 300 1st Gen 2005-2010	Suspension Control Arm and Ball Joint Assembly - Front Right Upper
ARM465	301181346500	CHRYSLER 300 2nd Gen 2011-2017	Suspension Control Arm and Ball Joint Assembly - Front Right Upper
ARM465	301181346500	DODGE CHALLENGER 4th Gen 2008-	Suspension Control Arm and Ball Joint Assembly - Front Right Upper
ARM465	301181346500	DODGE CHARGER 6th Gen 2005-2010	Suspension Control Arm and Ball Joint Assembly - Front Right Upper
ARM465	301181346500	DODGE CHARGER 7th Gen 2011-	Suspension Control Arm and Ball Joint Assembly - Front Right Upper
ARM466	301181346600	CHRYSLER 300 1st Gen 2005-2010	Suspension Control Arm and Ball Joint Assembly - Front Left Upper
ARM466	301181346600	CHRYSLER 300 2nd Gen 2011-2017	Suspension Control Arm and Ball Joint Assembly - Front Left Upper
ARM466	301181346600	DODGE CHALLENGER 4th Gen 2008-	Suspension Control Arm and Ball Joint Assembly - Front Left Upper
ARM466	301181346600	DODGE CHARGER 6th Gen 2005-2010	Suspension Control Arm and Ball Joint Assembly - Front Left Upper
ARM466	301181346600	DODGE CHARGER 7th Gen 2011-	Suspension Control Arm and Ball Joint Assembly - Front Left Upper
ARM467	301181346700	CHRYSLER 300 1st Gen 2005-2010	Suspension Control Arm and Ball Joint Assembly - Front Right Lower
ARM467	301181346700	DODGE CHALLENGER 4th Gen 2008-	Suspension Control Arm and Ball Joint Assembly - Front Right Lower
ARM467	301181346700	DODGE CHARGER 6th Gen 2005-2010	Suspension Control Arm and Ball Joint Assembly - Front Right Lower
ARM468	301181346800	CHRYSLER 300 1st Gen 2005-2010	Suspension Control Arm and Ball Joint Assembly - Front Left Lower
ARM468	301181346800	DODGE CHALLENGER 4th Gen 2008-	Suspension Control Arm and Ball Joint Assembly - Front Left Lower



			DESCRIPTION
SHORT	LONG		
ARM468	301181346800	DODGE CHARGER 6th Gen 2005-2010	Suspension Control Arm and Ball Joint Assembly - Front Left Lower
ARM469	301181346900	CHRYSLER 300 2nd Gen 2011-2017	Suspension Control Arm - Front Lower
ARM469	301181346900	DODGE CHALLENGER 4th Gen 2008-	Suspension Control Arm - Front Lower
ARM469	301181346900	DODGE CHARGER 7th Gen 2011-	Suspension Control Arm - Front Lower
ARM470	301181347000	LANCIA YPSILON 312, 846 05/2011-	Suspension Control Arm and Ball Joint Assembly - Front Right Lower
ARM471	301181347100	LANCIA YPSILON 312, 846 05/2011-	Suspension Control Arm and Ball Joint Assembly - Front Left Lower
ARM472	301181347200	FIAT DUNA 1987-1991	Suspension Control Arm and Ball Joint Assembly - Front
ARM472	301181347200	FIAT FIORINO 1988-1993	Suspension Control Arm and Ball Joint Assembly - Front
ARM472	301181347200	FIAT FIORINO NUOVA 1988-1998	Suspension Control Arm and Ball Joint Assembly - Front
ARM472	301181347200	FIAT PREMIO 03/1985-12/1996	Suspension Control Arm and Ball Joint Assembly - Front
ARM472	301181347200	FIAT UNO CS 1983-1996	Suspension Control Arm and Ball Joint Assembly - Front
ARM473	301181347300	FIAT PANDA 312 02/2012-	Suspension Control Arm and Ball Joint Assembly - Front Right Lower
ARM474	301181347400	FIAT PANDA 312 02/2012-	Suspension Control Arm and Ball Joint Assembly - Front Left Lower
ARM475	301181347500	FIAT 500 10/2007-2016	Suspension Control Arm and Ball Joint Assembly - Front Right Lower
ARM475	301181347500	FORD KA II 12/2008-	Suspension Control Arm and Ball Joint Assembly - Front Right Lower
ARM476	301181347600	FIAT 500 10/2007-2016	Suspension Control Arm and Ball Joint Assembly - Front Left
ARM476	301181347600	FORD KA II 12/2008-	Suspension Control Arm and Ball Joint Assembly - Front Left
ARM477	301181347700	FIAT 500L 09/2012-	Suspension Control Arm and Ball Joint Assembly - Front Right Lower
ARM478	301181347800	FIAT 500L 09/2012-	Suspension Control Arm and Ball Joint Assembly - Front Left Lower
ARM479	301181347900	FIAT 500X 01/2015-	Suspension Control Arm and Ball Joint Assembly - Front Right
ARM479	301181347900	JEEP RENEGADE 07/2014-	Suspension Control Arm and Ball Joint Assembly - Front Right
ARM480	301181348000	FIAT 500X 01/2015-	Suspension Control Arm and Ball Joint Assembly - Front Left
ARM480	301181348000	JEEP RENEGADE 07/2014-	Suspension Control Arm and Ball Joint Assembly - Front Left
ARM481	301181348100	FIAT EGEA 356, TIPO 10/2015-	Suspension Control Arm and Ball Joint Assembly - Front Right
ARM482	301181348200	FIAT EGEA 356, TIPO 10/2015-	Suspension Control Arm and Ball Joint Assembly - Front Left
ARM482	301181348200	FIAT TIPO 356 10/2015-	Suspension Control Arm and Ball Joint Assembly - Front Left
ARM483	301181348300	FIAT 500X 01/2015-	Suspension Control Arm and Ball Joint Assembly - Front Right Lower





 SHORT LONG			DESCRIPTION
ARM483	301181348300	JEEP RENEGADE 07/2014-	Suspension Control Arm and Ball Joint Assembly - Front Right Lower
ARM484	301181348400	FIAT 500X 01/2015-	Suspension Control Arm and Ball Joint Assembly - Front Left Lower
ARM484	301181348400	JEEP RENEGADE 07/2014-	Suspension Control Arm and Ball Joint Assembly - Front Left Lower
ARM485	301181348500	FIAT BARCHETTA 1995-2005	Suspension Control Arm and Ball Joint Assembly - Front Right Lower
ARM485	301181348500	FIAT PUNTO 176 04/1994-09/1999	Suspension Control Arm and Ball Joint Assembly - Front Right Lower
ARM485	301181348500	LANCIA Y 11/1995-09/2003	Suspension Control Arm and Ball Joint Assembly - Front Right Lower
ARM486	301181348600	FIAT BARCHETTA 1995-2005	Suspension Control Arm and Ball Joint Assembly - Front Left
ARM486	301181348600	FIAT PUNTO 176 04/1994-09/1999	Suspension Control Arm and Ball Joint Assembly - Front Left
ARM486	301181348600	LANCIA Y 11/1995-09/2003	Suspension Control Arm and Ball Joint Assembly - Front Left
ARM487	301181348700	ALFA ROMEO 145 930 1994-2001	Suspension Control Arm and Ball Joint Assembly - Front Right Lower
ARM487	301181348700	ALFA ROMEO 146 930 1994-2001	Suspension Control Arm and Ball Joint Assembly - Front Right Lower
ARM487	301181348700	ALFA ROMEO 155 167 1992-1998	Suspension Control Arm and Ball Joint Assembly - Front Right Lower
ARM487	301181348700	ALFA ROMEO GTV 167 1992-1998	Suspension Control Arm and Ball Joint Assembly - Front Right Lower
ARM487	301181348700	ALFA ROMEO SPIDER 167 1992-1998	Suspension Control Arm and Ball Joint Assembly - Front Right Lower
ARM487	301181348700	LANCIA DELTA II 1993-2000	Suspension Control Arm and Ball Joint Assembly - Front Right Lower
ARM488	301181348800	ALFA ROMEO 145 930 1994-2001	Suspension Control Arm and Ball Joint Assembly - Front Left
ARM488	301181348800	ALFA ROMEO 146 930 1994-2001	Suspension Control Arm and Ball Joint Assembly - Front Left
ARM488	301181348800	ALFA ROMEO 155 167 1992-1998	Suspension Control Arm and Ball Joint Assembly - Front Left
ARM488	301181348800	ALFA ROMEO GTV 167 1992-1998	Suspension Control Arm and Ball Joint Assembly - Front Left
ARM488	301181348800	ALFA ROMEO SPIDER 167 1992-1998	Suspension Control Arm and Ball Joint Assembly - Front Left
ARM488	301181348800	LANCIA DELTA II 1993-2000	Suspension Control Arm and Ball Joint Assembly - Front Left
ARM489	301181348900	FIAT PALIO - SIENA 04/1996-05/2013	Suspension Control Arm and Ball Joint Assembly - Front Right Lower
ARM490	301181349000	FIAT PALIO - SIENA 04/1996-05/2013	Suspension Control Arm and Ball Joint Assembly - Front Left Lower
ARM491	301181349100	CITROEN JUMPER II 05/2002-05/2006	Suspension Control Arm - Front Right Lower
ARM491	301181349100	FIAT DUCATO 14Q-1.8Q 05/2002-05/2006	Suspension Control Arm - Front Right Lower
ARM491	301181349100	PEUGEOT BOXER (1.4Q-1.8Q) 05/2002-05/2005	Suspension Control Arm - Front Right Lower
ARM492	301181349200	CITROEN JUMPER II 05/2002-05/2006	Suspension Control Arm - Front Left Lower



 SHORT LONG			DESCRIPTION
ARM492	301181349200	FIAT DUCATO 14Q-1.8Q 05/2002-05/2006	Suspension Control Arm - Front Left Lower
ARM492	301181349200	PEUGEOT BOXER (1.4Q-1.8Q) 05/2002-05/2005	Suspension Control Arm - Front Left Lower
ARM493	301181349300	CITROEN JUMPER II 05/2002-05/2006	Suspension Control Arm - Front Right Lower
ARM493	301181349300	FIAT DUCATO 14Q-1.8Q 05/2002-05/2006	Suspension Control Arm - Front Right Lower
ARM493	301181349300	PEUGEOT BOXER (1.4Q-1.8Q) 05/2002-05/2005	Suspension Control Arm - Front Right Lower
ARM494	301181349400	CITROEN JUMPER II 05/2002-05/2006	Suspension Control Arm - Front Left Lower
ARM494	301181349400	FIAT DUCATO 14Q-1.8Q 05/2002-05/2006	Suspension Control Arm - Front Left Lower
ARM494	301181349400	PEUGEOT BOXER (1.4Q-1.8Q) 05/2002-05/2005	Suspension Control Arm - Front Left Lower
ARM495	301181349500	CITROEN JUMPY III 01/2007-	Suspension Control Arm and Ball Joint Assembly - Front Right
ARM495	301181349500	FIAT SCUDO 272 01/2007-	Suspension Control Arm and Ball Joint Assembly - Front Right
ARM495	301181349500	PEUGEOT EXPERT 01/2007-	Suspension Control Arm and Ball Joint Assembly - Front Right
ARM496	301181349600	CITROEN JUMPY III 01/2007-	Suspension Control Arm and Ball Joint Assembly - Front Left
ARM496	301181349600	FIAT SCUDO 272 01/2007-	Suspension Control Arm and Ball Joint Assembly - Front Left
ARM496	301181349600	PEUGEOT EXPERT 01/2007-	Suspension Control Arm and Ball Joint Assembly - Front Left
ARM497	301181349700	IVECO DAILY III 05/1999-05/2006	Suspension Control Arm and Ball Joint Assembly - Front Right Upper
ARM498	301181349800	IVECO DAILY III 05/1999-05/2006	Suspension Control Arm and Ball Joint Assembly - Front Left Upper
ARM499	301181349900	IVECO DAILY III 05/1999-05/2006	Suspension Control Arm and Ball Joint Assembly - Front Right Lower
ARM501	301181350100	FORD EXPLORER UN105/UN150 1995-2001	Suspension Control Arm and Ball Joint Assembly - Front Left Upper
ARM501	301181350100	FORD RANGER ER, EQ 1998-2002	Suspension Control Arm and Ball Joint Assembly - Front Left Upper
ARM502	301181350200	FORD FUSION 1st Gen USA made 2006-2012	Lateral Arm - Rear Upper
ARM502	301181350200	LINCOLN MKZ 1st Gen 2006-2012	Lateral Arm - Rear Upper
ARM502	301181350200	MAZDA 6 GG 06/2002-07/2007	Lateral Arm - Rear Upper
ARM502	301181350200	MERCURY MILAN 2006-2011	Lateral Arm - Rear Upper
ARM503	301181350300	FORD FUSION 1st Gen USA made 2006-2012	Suspension Control Arm and Ball Joint Assembly - Front Right Upper
ARM503	301181350300	LINCOLN MKZ 1st Gen 2006-2012	Suspension Control Arm and Ball Joint Assembly - Front Right Upper
ARM503	301181350300	MERCURY MILAN 2006-2011	Suspension Control Arm and Ball Joint Assembly - Front Right Upper
ARM504	301181350400	FORD FUSION 1st Gen USA made 2006-2012	Suspension Control Arm and Ball Joint Assembly - Front Left Upper
ARM504	301181350400	LINCOLN MKZ 1st Gen 2006-2012	Suspension Control Arm and Ball Joint Assembly - Front Left Upper
ARM504	301181350400	MERCURY MILAN 2006-2011	Suspension Control Arm and Ball Joint Assembly - Front Left Upper





 SHORT LONG			DESCRIPTION
ARM505	301181350500	FORD FUSION 1st Gen USA made 2006-2012	Suspension Control Arm and Ball Joint Assembly - Front Lower
ARM505	301181350500	LINCOLN MKZ 1st Gen 2006-2012	Suspension Control Arm and Ball Joint Assembly - Front Lower
ARM505	301181350500	MERCURY MILAN 2006-2011	Suspension Control Arm and Ball Joint Assembly - Front Lower
ARM506	301181350600	FORD EDGE U387 2006-2014	Suspension Control Arm and Ball Joint Assembly - Front Right Lower
ARM506	301181350600	LINCOLN MKX 1st Gen 2007-2014	Suspension Control Arm and Ball Joint Assembly - Front Right Lower
ARM507	301181350700	FORD EDGE U387 2006-2014	Suspension Control Arm and Ball Joint Assembly - Front Left Lower
ARM507	301181350700	LINCOLN MKX 1st Gen 2007-2014	Suspension Control Arm and Ball Joint Assembly - Front Left Lower
ARM508	301181350800	FORD EDGE U387 2006-2014	Lateral Arm - Rear
ARM508	301181350800	LINCOLN MKX 1st Gen 2007-2014	Lateral Arm - Rear
ARM509	301181350900	FORD FUSION 1st Gen USA made 2006-2012	Suspension Control Arm and Ball Joint Assembly - Front Right
ARM509	301181350900	LINCOLN MKZ 1st Gen 2006-2012	Suspension Control Arm and Ball Joint Assembly - Front Right
ARM509	301181350900	MERCURY MILAN 2006-2011	Suspension Control Arm and Ball Joint Assembly - Front Right
ARM510	301181351000	FORD FUSION 1st Gen USA made 2006-2012	Suspension Control Arm and Ball Joint Assembly - Front Left
ARM510	301181351000	LINCOLN MKZ 1st Gen 2006-2012	Suspension Control Arm and Ball Joint Assembly - Front Left
ARM510	301181351000	MERCURY MILAN 2006-2011	Suspension Control Arm and Ball Joint Assembly - Front Left
ARM511	301181351100	FORD FIESTA USA type 2011-	Suspension Control Arm and Ball Joint Assembly - Front Right Lower
ARM511	301181351100	FORD FIESTA VI 10/2008-2016	Suspension Control Arm and Ball Joint Assembly - Front Right Lower
ARM511	301181351100	MAZDA 2 DE 10/2007-2015	Suspension Control Arm and Ball Joint Assembly - Front Right Lower
ARM512	301181351200	FORD FIESTA USA type 2011-	Suspension Control Arm and Ball Joint Assembly - Front Left Lower
ARM512	301181351200	FORD FIESTA VI 10/2008-2016	Suspension Control Arm and Ball Joint Assembly - Front Left Lower
ARM512	301181351200	MAZDA 2 DE 10/2007-2015	Suspension Control Arm and Ball Joint Assembly - Front Left Lower
ARM513	301181351300	FORD FIESTA V 01/2002-09/2008	Suspension Control Arm and Ball Joint Assembly - Front Right Lower
ARM513	301181351300	FORD FUSION 2003-2009	Suspension Control Arm and Ball Joint Assembly - Front Right Lower
ARM513	301181351300	MAZDA 2 DY 04/2003-06/2007	Suspension Control Arm and Ball Joint Assembly - Front Right Lower
ARM514	301181351400	FORD FIESTA V 01/2002-09/2008	Suspension Control Arm and Ball Joint Assembly - Front Left Lower
ARM514	301181351400	FORD FUSION 2003-2009	Suspension Control Arm and Ball Joint Assembly - Front Left Lower



			DESCRIPTION
SHORT	LONG		
ARM514	301181351400	MAZDA 2 DY 04/2003-06/2007	Suspension Control Arm and Ball Joint Assembly - Front Left Lower
ARM515	301181351500	FORD FIESTA V 01/2002-09/2008	Suspension Control Arm and Ball Joint Assembly - Front Right Lower
ARM516	301181351600	FORD FIESTA V 01/2002-09/2008	Suspension Control Arm and Ball Joint Assembly - Front Left Lower
ARM517	301181351700	FORD COURIER 08/1996-12/2001	Suspension Control Arm and Ball Joint Assembly - Front Right Lower
ARM518	301181351800	FORD COURIER 08/1996-12/2001	Suspension Control Arm and Ball Joint Assembly - Front Left Lower
ARM519	301181351900	FORD COURIER 08/1996-12/2001	Suspension Control Arm and Ball Joint Assembly - Front Right Lower
ARM520	301181352000	FORD COURIER 08/1996-12/2001	Suspension Control Arm and Ball Joint Assembly - Front Left Lower
ARM521	301181352100	FORD KA RB 1996-2008	Suspension Control Arm and Ball Joint Assembly - Front Right Lower
ARM522	301181352200	FORD KA RB 1996-2008	Suspension Control Arm and Ball Joint Assembly - Front Left Lower
ARM523	301181352300	FORD KA RB 1996-2008	Suspension Control Arm and Ball Joint Assembly - Front Right Lower
ARM524	301181352400	FORD KA RB 1996-2008	Suspension Control Arm and Ball Joint Assembly - Front Left Lower
ARM525	301181352500	FORD KA RB 1996-2008	Suspension Control Arm and Ball Joint Assembly - Front Right Lower
ARM526	301181352600	FORD KA RB 1996-2008	Suspension Control Arm and Ball Joint Assembly - Front Left Lower
ARM527	301181352700	FORD KA RB 1996-2008	Suspension Control Arm and Ball Joint Assembly - Front Right Lower
ARM528	301181352800	FORD KA RB 1996-2008	Suspension Control Arm and Ball Joint Assembly - Front Left Lower
ARM529	301181352900	FORD FUSION 1st Gen USA made 2006-2012	Lateral Arm - Rear Lower
ARM529	301181352900	LINCOLN MKZ 1st Gen 2006-2012	Lateral Arm - Rear Lower
ARM529	301181352900	MERCURY MILAN 2006-2011	Lateral Arm - Rear Lower
ARM530	301181353000	FORD KA II 12/2008-	Suspension Control Arm and Ball Joint Assembly - Front Right
ARM531	301181353100	FORD KA II 12/2008-	Suspension Control Arm and Ball Joint Assembly - Front Left Lower
ARM532	301181353200	FORD MONDEO V 09/2014-	Lateral Arm - Rear Upper
ARM533	301181353300	FORD FOCUS II USA made 2005-2010	Suspension Control Arm and Ball Joint Assembly - Front Right Lower
ARM534	301181353400	FORD FOCUS II USA made 2005-2010	Suspension Control Arm and Ball Joint Assembly - Front Left Lower
ARM535	301181353500	FORD C-MAX I 02/2007-11/2010	Lateral Arm - Rear Upper
ARM535	301181353500	FORD FOCUS I 10/1998-11/2004	Lateral Arm - Rear Upper
ARM535	301181353500	FORD FOCUS II 11/2004-03/2011	Lateral Arm - Rear Upper
ARM535	301181353500	FORD FOCUS II USA made 2005-2010	Lateral Arm - Rear Upper
ARM535	301181353500	MAZDA 3 BK 10/2003-06/2009	Lateral Arm - Rear Upper
ARM535	301181353500	MAZDA 5 CR19, 2nd Gen 03/2005-08/2010	Lateral Arm - Rear Upper





 SHORT LONG			DESCRIPTION
ARM535	301181353500	VOLVO S40 II (MS) 01/2004-11/2012	Lateral Arm - Rear Upper
ARM535	301181353500	VOLVO V50 04/2004-11/2012	Lateral Arm - Rear Upper
ARM536	301181353600	FORD ESCAPE 3rd Gen 2013-	Lateral Arm - Rear Lower
ARM536	301181353600	FORD FOCUS I 10/1998-11/2004	Lateral Arm - Rear Lower
ARM536	301181353600	FORD FOCUS II 11/2004-03/2011	Lateral Arm - Rear Lower
ARM536	301181353600	FORD FOCUS II USA made 2005-2010	Lateral Arm - Rear Lower
ARM536	301181353600	FORD FOCUS III 04/2011-	Lateral Arm - Rear Lower
ARM536	301181353600	FORD FOCUS III USA made 2012-	Lateral Arm - Rear Lower
ARM536	301181353600	MAZDA 3 BK 10/2003-06/2009	Lateral Arm - Rear Lower
ARM536	301181353600	MAZDA 5 CR19, 2nd Gen 03/2005-08/2010	Lateral Arm - Rear Lower
ARM536	301181353600	VOLVO C30 10/2006-12/2012	Lateral Arm - Rear Lower
ARM536	301181353600	VOLVO C70 I 11/1996-05/2000	Lateral Arm - Rear Lower
ARM536	301181353600	VOLVO S70 I 11/1996-05/2000	Lateral Arm - Rear Lower
ARM536	301181353600	VOLVO V50 04/2004-11/2012	Lateral Arm - Rear Lower
ARM536	301181353600	VOLVO V70 I 11/1996-05/2000	Lateral Arm - Rear Lower
ARM537	301181353700	FORD FOCUS I 10/1998-11/2004	Lateral Arm - Rear Lower Rearward
ARM537	301181353700	FORD FOCUS II 11/2004-03/2011	Lateral Arm - Rear Lower Rearward
ARM537	301181353700	VOLVO S40 II (MS) 01/2004-11/2012	Lateral Arm - Rear Lower Rearward
ARM537	301181353700	VOLVO V50 04/2004-11/2012	Lateral Arm - Rear Lower Rearward
ARM538	301181353800	FORD FOCUS I 10/1998-11/2004	Suspension Control Arm and Ball Joint Assembly - Front Right Lower
ARM539	301181353900	FORD FOCUS I 10/1998-11/2004	Suspension Control Arm and Ball Joint Assembly - Front Left Lower
ARM540	301181354000	FORD C-MAX I 02/2007-11/2010	Suspension Control Arm and Ball Joint Assembly - Front Right Lower
ARM540	301181354000	FORD FOCUS II 11/2004-03/2011	Suspension Control Arm and Ball Joint Assembly - Front Right Lower
ARM540	301181354000	VOLVO C30 10/2006-12/2012	Suspension Control Arm and Ball Joint Assembly - Front Right Lower
ARM540	301181354000	VOLVO S40 II (MS) 01/2004-11/2012	Suspension Control Arm and Ball Joint Assembly - Front Right Lower
ARM540	301181354000	VOLVO V50 04/2004-11/2012	Suspension Control Arm and Ball Joint Assembly - Front Right Lower
ARM541	301181354100	FORD C-MAX I 02/2007-11/2010	Suspension Control Arm and Ball Joint Assembly - Front Left Lower
ARM541	301181354100	FORD FOCUS II 11/2004-03/2011	Suspension Control Arm and Ball Joint Assembly - Front Left Lower
ARM541	301181354100	VOLVO C30 10/2006-12/2012	Suspension Control Arm and Ball Joint Assembly - Front Left Lower
ARM541	301181354100	VOLVO S40 II (MS) 01/2004-11/2012	Suspension Control Arm and Ball Joint Assembly - Front Left Lower
ARM541	301181354100	VOLVO V50 04/2004-11/2012	Suspension Control Arm and Ball Joint Assembly - Front Left Lower
ARM542	301181354200	FORD C-MAX II 12/2010-	Lateral Arm - Rear Upper
ARM542	301181354200	FORD FOCUS III 04/2011-	Lateral Arm - Rear Upper
ARM542	301181354200	FORD FOCUS III USA made 2012-	Lateral Arm - Rear Upper



 SHORT LONG			DESCRIPTION
ARM543	301181354300	FORD C-MAX I 02/2007-11/2010	Suspension Control Arm and Ball Joint Assembly - Front Right
ARM543	301181354300	FORD FOCUS II 11/2004-03/2011	Suspension Control Arm and Ball Joint Assembly - Front Right
ARM543	301181354300	VOLVO S40 II (MS) 01/2004-11/2012	Suspension Control Arm and Ball Joint Assembly - Front Right
ARM544	301181354400	FORD C-MAX I 02/2007-11/2010	Suspension Control Arm and Ball Joint Assembly - Front Left Lower
ARM544	301181354400	FORD FOCUS II 11/2004-03/2011	Suspension Control Arm and Ball Joint Assembly - Front Left Lower
ARM544	301181354400	VOLVO S40 II (MS) 01/2004-11/2012	Suspension Control Arm and Ball Joint Assembly - Front Left Lower
ARM545	301181354500	FORD C-MAX II 12/2010-	Lateral Arm - Rear
ARM546	301181354600	FORD C-MAX II 12/2010-	Suspension Control Arm and Ball Joint Assembly - Front Right Lower
ARM546	301181354600	FORD FOCUS III USA made 2012-	Suspension Control Arm and Ball Joint Assembly - Front Right Lower
ARM547	301181354700	FORD C-MAX II 12/2010-	Suspension Control Arm and Ball Joint Assembly - Front Left Lower
ARM547	301181354700	FORD FOCUS III USA made 2012-	Suspension Control Arm and Ball Joint Assembly - Front Left Lower
ARM548	301181354800	FORD FOCUS III 04/2011-	Lateral Arm - Rear Lower
ARM549	301181354900	FORD FOCUS III 04/2011-	Suspension Control Arm and Ball Joint Assembly - Front Right Lower
ARM550	301181355000	FORD FOCUS III 04/2011-	Suspension Control Arm and Ball Joint Assembly - Front Left Lower
ARM551	301181355100	FORD B-MAX I 2012-	Suspension Control Arm and Ball Joint Assembly - Front Right
ARM551	301181355100	FORD COURIER I 2014-	Suspension Control Arm and Ball Joint Assembly - Front Right
ARM552	301181355200	FORD B-MAX I 2012-	Suspension Control Arm and Ball Joint Assembly - Front Left
ARM552	301181355200	FORD COURIER I 2014-	Suspension Control Arm and Ball Joint Assembly - Front Left
ARM553	301181355300	FORD EXPEDITION 2nd Gen 2003-2006	Suspension Control Arm and Ball Joint Assembly - Front right lower
ARM553	301181355300	LINCOLN NAVIGATOR UN173, U228 05/1997-12/2006	Suspension Control Arm and Ball Joint Assembly - Front right lower
ARM554	301181355400	FORD EXPEDITION 2nd Gen 2003-2006	Suspension Control Arm and Ball Joint Assembly - Front left lower
ARM554	301181355400	LINCOLN NAVIGATOR UN173, U228 05/1997-12/2006	Suspension Control Arm and Ball Joint Assembly - Front left lower
ARM555	301181355500	FORD EXPLORER U502 2010-2015	Suspension Control Arm and Ball Joint Assembly - Front Right Lower
ARM556	301181355600	FORD EXPLORER U502 2010-2015	Suspension Control Arm and Ball Joint Assembly - Front Left Lower
ARM557	301181355700	FORD KUGA I 02/2008-02/2013	Lateral Arm - Rear Lower
ARM558	301181355800	FORD C-MAX I 02/2007-11/2010	Lateral Arm - Rear Upper
ARM558	301181355800	FORD FOCUS I 10/1998-11/2004	Lateral Arm - Rear Upper
ARM558	301181355800	FORD FOCUS II 11/2004-03/2011	Lateral Arm - Rear Upper





 SHORT LONG			DESCRIPTION
ARM558	301181355800	FORD KUGA I 02/2008-02/2013	Lateral Arm - Rear Upper
ARM558	301181355800	FORD KUGA II 03/2013-	Lateral Arm - Rear Upper
ARM559	301181355900	FORD KUGA I 02/2008-02/2013	Suspension Control Arm and Ball Joint Assembly - Front Right Lower
ARM560	301181356000	FORD KUGA I 02/2008-02/2013	Suspension Control Arm and Ball Joint Assembly - Front Left Lower
ARM561	301181356100	FORD KUGA I 02/2008-02/2013	Lateral Arm - Rear Upper
ARM562	301181356200	FORD KUGA II 03/2013-	Suspension Control Arm and Ball Joint Assembly - Front Right Lower
ARM563	301181356300	FORD KUGA II 03/2013-	Suspension Control Arm and Ball Joint Assembly - Front Left Lower
ARM564	301181356400	FORD FUSION 2nd Gen 2013-	Suspension Control Arm and Ball Joint Assembly - Front Right
ARM564	301181356400	FORD MONDEO V 09/2014-	Suspension Control Arm and Ball Joint Assembly - Front Right
ARM565	301181356500	FORD FUSION 2nd Gen 2013-	Suspension Control Arm and Ball Joint Assembly - Front Left
ARM565	301181356500	FORD MONDEO V 09/2014-	Suspension Control Arm and Ball Joint Assembly - Front Left
ARM566	301181356600	FORD MONDEO V 09/2014-	Lateral Arm - Rear Upper
ARM567	301181356700	FORD C-MAX III 2013-	Suspension Control Arm and Ball Joint Assembly - Front Right Lower
ARM567	301181356700	FORD FOCUS III USA made 2012-	Suspension Control Arm and Ball Joint Assembly - Front Right Lower
ARM568	301181356800	FORD C-MAX III 2013-	Suspension Control Arm and Ball Joint Assembly - Front Left Lower
ARM568	301181356800	FORD FOCUS III USA made 2012-	Suspension Control Arm and Ball Joint Assembly - Front Left Lower
ARM569	301181356900	FORD FOCUS III 04/2011-	Lateral Arm - Rear Lower Forward
ARM570	301181357000	FORD FOCUS III 04/2011-	Suspension Control Arm and Ball Joint Assembly - Front Right Lower
ARM571	301181357100	FORD FOCUS III 04/2011-	Suspension Control Arm and Ball Joint Assembly - Front Left Lower
ARM572	301181357200	FORD TRANSIT CONNECT II 2013-	Suspension Control Arm and Ball Joint Assembly - Front Right
ARM573	301181357300	FORD TRANSIT CONNECT II 2013-	Suspension Control Arm and Ball Joint Assembly - Front Left
ARM574	301181357400	FORD TRANSIT V184 2000-06/2006	Suspension Control Arm - Front Right Lower
ARM574	301181357400	FORD TRANSIT V347-348 07/2006-04/2014	Suspension Control Arm - Front Right Lower
ARM575	301181357500	FORD TRANSIT V184 2000-06/2006	Suspension Control Arm - Front Left Lower
ARM575	301181357500	FORD TRANSIT V347-348 07/2006-04/2014	Suspension Control Arm - Front Left Lower
ARM576	301181357600	FORD TRANSIT V347-348 07/2006-04/2014	Suspension Control Arm - Front Right Lower
ARM577	301181357700	FORD TRANSIT V347-348 07/2006-04/2014	Suspension Control Arm - Front Left Lower
ARM578	301181357800	FORD TRANSIT V363 04/2014-	Suspension Control Arm - Front Right
ARM579	301181357900	FORD TRANSIT V363 04/2014-	Suspension Control Arm - Front Left
ARM580	301181358000	FORD TRANSIT CONNECT 04/2002-09/2013	Suspension Control Arm - Front Right Lower
ARM581	301181358100	FORD TRANSIT CONNECT 04/2002-09/2013	Suspension Control Arm - Front Left Lower



 SHORT LONG			DESCRIPTION
ARM582	301181358200	FORD TRANSIT CUSTOM 12/2012-	Suspension Control Arm - Front Right Lower
ARM583	301181358300	FORD TRANSIT CUSTOM 12/2012-	Suspension Control Arm - Front Left Lower
ARM584	301181358400	FORD GALAXY 05/2006-	Lateral Arm - Rear
ARM584	301181358400	FORD MONDEO IV 04/2007-08/2014	Lateral Arm - Rear
ARM584	301181358400	FORD S-MAX WA6 05/2006-	Lateral Arm - Rear
ARM585	301181358500	FORD MONDEO III 11/2000-03/2007	Lateral Arm - Rear Lower Forward
ARM586	301181358600	FORD MONDEO III 11/2000-03/2007	Lateral Arm - Rear Lower
ARM587	301181358700	FORD MONDEO III 11/2000-03/2007	Suspension Control Arm and Ball Joint Assembly - Front Right Lower
ARM587	301181358700	JAGUAR X-TYPE 06/2001-11/2009	Suspension Control Arm and Ball Joint Assembly - Front Right Lower
ARM588	301181358800	FORD MONDEO III 11/2000-03/2007	Suspension Control Arm and Ball Joint Assembly - Front Left Lower
ARM588	301181358800	JAGUAR X-TYPE 06/2001-11/2009	Suspension Control Arm and Ball Joint Assembly - Front Left Lower
ARM589	301181358900	FORD MONDEO III 11/2000-03/2007	Lateral Arm - Rear Upper Forward
ARM590	301181359000	FORD MONDEO III 11/2000-03/2007	Lateral Arm - Rear Upper Rearward
ARM591	301181359100	FORD MONDEO III 11/2000-03/2007	Lateral Arm - Rear Lower
ARM592	301181359200	FORD MONDEO III 11/2000-03/2007	Suspension Control Arm and Ball Joint Assembly - Front Right Lower
ARM593	301181359300	FORD MONDEO III 11/2000-03/2007	Suspension Control Arm and Ball Joint Assembly - Front Left Lower
ARM594	301181359400	FORD MONDEO IV 04/2007-08/2014	Lateral Arm - Rear Upper
ARM595	301181359500	FORD MONDEO IV 04/2007-08/2014	Lateral Arm - Rear
ARM596	301181359600	FORD GALAXY 05/2006-	Suspension Control Arm and Ball Joint Assembly - Front Right Lower
ARM596	301181359600	FORD MONDEO IV 04/2007-08/2014	Suspension Control Arm and Ball Joint Assembly - Front Right Lower
ARM596	301181359600	FORD S-MAX WA6 05/2006-	Suspension Control Arm and Ball Joint Assembly - Front Right Lower
ARM596	301181359600	VOLVO S60 II 04/2010-	Suspension Control Arm and Ball Joint Assembly - Front Right Lower
ARM596	301181359600	VOLVO S80 II (AS) 03/2006-2016	Suspension Control Arm and Ball Joint Assembly - Front Right Lower
ARM596	301181359600	VOLVO V70 III 08/2007-2016	Suspension Control Arm and Ball Joint Assembly - Front Right Lower
ARM597	301181359700	FORD GALAXY 05/2006-	Suspension Control Arm and Ball Joint Assembly - Front Left Lower
ARM597	301181359700	FORD MONDEO IV 04/2007-08/2014	Suspension Control Arm and Ball Joint Assembly - Front Left Lower
ARM597	301181359700	FORD S-MAX WA6 05/2006-	Suspension Control Arm and Ball Joint Assembly - Front Left Lower
ARM597	301181359700	VOLVO S60 II 04/2010-	Suspension Control Arm and Ball Joint Assembly - Front Left Lower
ARM597	301181359700	VOLVO S80 II (AS) 03/2006-2016	Suspension Control Arm and Ball Joint Assembly - Front Left Lower
ARM597	301181359700	VOLVO V70 III 08/2007-2016	Suspension Control Arm and Ball Joint Assembly - Front Left Lower





 SHORT LONG			DESCRIPTION
ARM598	301181359800	FORD ESCAPE 3rd Gen 2013-	Lateral Arm - Rear Lower
ARM598	301181359800	FORD KUGA II 03/2013-	Lateral Arm - Rear Lower
ARM599	301181359900	HYUNDAI ix35 01/2010-2015	Suspension Control Arm and Ball Joint Assembly - Front Right Lower
ARM599	301181359900	KIA SPORTAGE SL 07/2010-08/2015	Suspension Control Arm and Ball Joint Assembly - Front Right Lower
ARM600	301181360000	HYUNDAI ix35 01/2010-2015	Suspension Control Arm and Ball Joint Assembly - Front Left Lower
ARM600	301181360000	KIA SPORTAGE SL 07/2010-08/2015	Suspension Control Arm and Ball Joint Assembly - Front Left Lower
ARM601	301181360100	HYUNDAI ix35 01/2010-2015	Lateral Arm - Rear Upper
ARM601	301181360100	HYUNDAI SONATA VI 2011-2015	Lateral Arm - Rear Upper
ARM601	301181360100	HYUNDAI TUCSON 2nd Gen 2010-2015	Lateral Arm - Rear Upper
ARM601	301181360100	KIA SPORTAGE SL 07/2010-08/2015	Lateral Arm - Rear Upper
ARM602	301181360200	HYUNDAI TUCSON JM 08/2004-03/2010	Lateral Arm - Rear
ARM602	301181360200	KIA SPORTAGE JE 09/2004-06/2010	Lateral Arm - Rear
ARM603	301181360300	HYUNDAI ACCENT III, MC 11/2005-11/2010	Suspension Control Arm - Front Right Lower
ARM603	301181360300	KIA RIO JB 03/2005-08/2011	Suspension Control Arm - Front Right Lower
ARM603	301181360300	KIA RIO5 JB 03/2005-08/2011	Suspension Control Arm - Front Right Lower
ARM604	301181360400	HYUNDAI ACCENT III, MC 11/2005-11/2010	Suspension Control Arm - Front Left Lower
ARM604	301181360400	KIA RIO JB 03/2005-08/2011	Suspension Control Arm - Front Left Lower
ARM604	301181360400	KIA RIO5 JB 03/2005-08/2011	Suspension Control Arm - Front Left Lower
ARM605	301181360500	HYUNDAI I20 (PB,PBT) 09/2008-08/2014	Suspension Control Arm and Ball Joint Assembly - Front Right Lower
ARM606	301181360600	HYUNDAI I20 (PB,PBT) 09/2008-08/2014	Suspension Control Arm and Ball Joint Assembly - Front Left Lower
ARM607	301181360700	HYUNDAI ELANTRA Touring, Wagon 10/2007-11/2011	Suspension Control Arm - Front Right Lower
ARM607	301181360700	HYUNDAI I30 FD 10/2007-11/2011	Suspension Control Arm - Front Right Lower
ARM607	301181360700	KIA CEED I 12/2006-04/2012	Suspension Control Arm - Front Right Lower
ARM608	301181360800	HYUNDAI ELANTRA Touring, Wagon 10/2007-11/2011	Suspension Control Arm - Front Left Lower
ARM608	301181360800	HYUNDAI I30 FD 10/2007-11/2011	Suspension Control Arm - Front Left Lower
ARM608	301181360800	KIA CEED I 12/2006-04/2012	Suspension Control Arm - Front Left Lower
ARM609	301181360900	HYUNDAI Elantra GT 12/2011-	Suspension Control Arm and Ball Joint Assembly - Front Right Lower
ARM609	301181360900	HYUNDAI I30 GD 12/2011-	Suspension Control Arm and Ball Joint Assembly - Front Right Lower
ARM609	301181360900	HYUNDAI I30 PD 2017-	Suspension Control Arm and Ball Joint Assembly - Front Right Lower
ARM609	301181360900	KIA CEED II 05/2012-	Suspension Control Arm and Ball Joint Assembly - Front Right Lower
ARM610	301181361000	HYUNDAI Elantra GT 12/2011-	Suspension Control Arm and Ball Joint Assembly - Front Left Lower
ARM610	301181361000	HYUNDAI I30 GD 12/2011-	Suspension Control Arm and Ball Joint Assembly - Front Left Lower



			DESCRIPTION
SHORT	LONG		
ARM610	301181361000	HYUNDAI I30 PD 2017-	Suspension Control Arm and Ball Joint Assembly - Front Left Lower
ARM610	301181361000	KIA CEED II 05/2012-	Suspension Control Arm and Ball Joint Assembly - Front Left Lower
ARM611	301181361100	HYUNDAI I10 (PA) 02/2008-11/2013	Suspension Control Arm and Ball Joint Assembly - Front Right Lower
ARM612	301181361200	HYUNDAI I10 (PA) 02/2008-11/2013	Suspension Control Arm and Ball Joint Assembly - Front Left Lower
ARM613	301181361300	HYUNDAI i40 (VF) 2011-	Lateral Arm - Rear
ARM614	301181361400	HYUNDAI i40 (VF) 2011-	Suspension Control Arm and Ball Joint Assembly - Front Right
ARM615	301181361500	HYUNDAI i40 (VF) 2011-	Suspension Control Arm and Ball Joint Assembly - Front Left
ARM616	301181361600	HYUNDAI I20 II 11/2014-	Suspension Control Arm and Ball Joint Assembly - Front Right Lower
ARM617	301181361700	HYUNDAI I20 II 11/2014-	Suspension Control Arm and Ball Joint Assembly - Front Left Lower
ARM618	301181361800	HYUNDAI I30 GD 12/2011-	Lateral Arm - Rear
ARM618	301181361800	HYUNDAI I30 PD 2017-	Lateral Arm - Rear
ARM618	301181361800	KIA CEED JD 2012-	Lateral Arm - Rear
ARM619	301181361900	HYUNDAI Santa Fe I SM 02/2001-02/2006	Suspension Control Arm and Ball Joint Assembly - Front Right Lower
ARM620	301181362000	HYUNDAI Santa Fe I SM 02/2001-02/2006	Suspension Control Arm and Ball Joint Assembly - Front Left Lower
ARM621	301181362100	HYUNDAI Santa Fe II CM 03/2006-08/2012	Suspension Control Arm and Ball Joint Assembly - Front Right Lower
ARM622	301181362200	HYUNDAI Santa Fe II CM 03/2006-08/2012	Suspension Control Arm and Ball Joint Assembly - Front Left Lower
ARM623	301181362300	HYUNDAI Santa Fe III DM 09/2012-	Suspension Control Arm and Ball Joint Assembly - Front Right Lower
ARM624	301181362400	HYUNDAI Santa Fe III DM 09/2012-	Suspension Control Arm and Ball Joint Assembly - Front Left Lower
ARM625	301181362500	JEEP COMMANDER XK 2005-2010	Suspension Control Arm and Ball Joint Assembly - Front Right Lower
ARM625	301181362500	JEEP GRAND CHEROKEE III WH/WK 06/2005-12/2010	Suspension Control Arm and Ball Joint Assembly - Front Right Lower
ARM626	301181362600	JEEP COMMANDER XK 2005-2010	Suspension Control Arm and Ball Joint Assembly - Front Left Lower
ARM626	301181362600	JEEP GRAND CHEROKEE III WH/WK	Suspension Control Arm and Ball Joint Assembly - Front Left Lower
ARM627	301181362700	JEEP CHEROKEE KJ 01/2001-01/2008	Suspension Control Arm and Ball Joint Assembly - Front Right Lower
ARM627	301181362700	JEEP LIBERTY KJ 2001-2008	Suspension Control Arm and Ball Joint Assembly - Front Right Lower
ARM628	301181362800	JEEP CHEROKEE KJ 01/2001-01/2008	Suspension Control Arm and Ball Joint Assembly - Front Left Lower
ARM628	301181362800	JEEP LIBERTY KJ 2001-2008	Suspension Control Arm and Ball Joint Assembly - Front Left Lower
ARM629	301181362900	DODGE CALIBER 2007-2015	Suspension Control Arm and Ball Joint Assembly - Front Right





 SHORT LONG			DESCRIPTION
ARM629	301181362900	JEEP COMPASS MK49 06/2006-2015	Suspension Control Arm and Ball Joint Assembly - Front Right
ARM629	301181362900	JEEP PATRIOT 2007-2015	Suspension Control Arm and Ball Joint Assembly - Front Right
ARM630	301181363000	DODGE CALIBER 2007-2015	Suspension Control Arm and Ball Joint Assembly - Front Left
ARM630	301181363000	JEEP COMPASS MK49 06/2006-2015	Suspension Control Arm and Ball Joint Assembly - Front Left
ARM630	301181363000	JEEP PATRIOT 2007-2015	Suspension Control Arm and Ball Joint Assembly - Front Left
ARM631	301181363100	KIA SORENTO JC, BL 08/2002-10/2009	Suspension Control Arm and Ball Joint Assembly - Front Right Lower
ARM632	301181363200	KIA SORENTO JC, BL 08/2002-10/2009	Suspension Control Arm and Ball Joint Assembly - Front Left Lower
ARM633	301181363300	KIA SORENTO XM 2009-2014	Suspension Control Arm and Ball Joint Assembly - Front Right Lower
ARM634	301181363400	KIA SORENTO XM 2009-2014	Suspension Control Arm and Ball Joint Assembly - Front Left Lower
ARM635	301181363500	KIA RIO DC 09/2000-02/2005	Suspension Control Arm and Ball Joint Assembly - Front Right Lower
ARM636	301181363600	KIA PICANTO BA 05/2004-04/2011	Suspension Control Arm and Ball Joint Assembly - Front Right Lower
ARM637	301181363700	KIA PICANTO BA 05/2004-04/2011	Suspension Control Arm and Ball Joint Assembly - Front Left Lower
ARM638	301181363800	KIA PICANTO TA 05/2011-	Suspension Control Arm and Ball Joint Assembly - Front Right Lower
ARM639	301181363900	KIA PICANTO TA 05/2011-	Suspension Control Arm and Ball Joint Assembly - Front Left Lower
ARM640	301181364000	HYUNDAI TUCSON JM 08/2004-03/2010	Suspension Control Arm and Ball Joint Assembly - Front Right Lower
ARM640	301181364000	KIA SPORTAGE JE 09/2004-06/2010	Suspension Control Arm and Ball Joint Assembly - Front Right Lower
ARM641	301181364100	HYUNDAI TUCSON JM 08/2004-03/2010	Suspension Control Arm and Ball Joint Assembly - Front Left Lower
ARM641	301181364100	KIA SPORTAGE JE 09/2004-06/2010	Suspension Control Arm and Ball Joint Assembly - Front Left Lower
ARM642	301181364200	HYUNDAI I30 GD 12/2011-	Suspension Control Arm and Ball Joint Assembly - Front Right Lower
ARM642	301181364200	HYUNDAI I30 PD 2017-	Suspension Control Arm and Ball Joint Assembly - Front Right Lower
ARM642	301181364200	KIA CEED JD 2012-	Suspension Control Arm and Ball Joint Assembly - Front Right Lower
ARM643	301181364300	HYUNDAI I30 GD 12/2011-	Suspension Control Arm and Ball Joint Assembly - Front Left Lower
ARM643	301181364300	HYUNDAI I30 PD 2017-	Suspension Control Arm and Ball Joint Assembly - Front Left Lower
ARM643	301181364300	KIA CEED JD 2012-	Suspension Control Arm and Ball Joint Assembly - Front Left Lower
ARM644	301181364400	KIA RIO UB 09/2011-	Suspension Control Arm and Ball Joint Assembly - Front Right Lower



 SHORT LONG			DESCRIPTION
ARM645	301181364500	KIA RIO UB 09/2011-	Suspension Control Arm and Ball Joint Assembly - Front Left Lower
ARM646	301181364600	HYUNDAI ix20 (JC) 11/2010-	Suspension Control Arm and Ball Joint Assembly - Front Right Lower
ARM646	301181364600	KIA VENGA AM 02/2010-	Suspension Control Arm and Ball Joint Assembly - Front Right Lower
ARM647	301181364700	HYUNDAI ix20 (JC) 11/2010-	Suspension Control Arm and Ball Joint Assembly - Front Left Lower
ARM647	301181364700	KIA VENGA AM 02/2010-	Suspension Control Arm and Ball Joint Assembly - Front Left Lower
ARM648	301181364800	KIA SOUL AM 02/2009-2014	Suspension Control Arm and Ball Joint Assembly - Front Right Lower
ARM649	301181364900	KIA SOUL AM 02/2009-2014	Suspension Control Arm and Ball Joint Assembly - Front Left Lower
ARM650	301181365000	KIA SOUL AM 02/2009-2014	Suspension Control Arm and Ball Joint Assembly - Front Right Lower
ARM651	301181365100	KIA SOUL AM 02/2009-2014	Suspension Control Arm and Ball Joint Assembly - Front Left Lower
ARM652	301181365200	MERCEDES E280 (W210) 1995-2003	Suspension Control Arm - Front Right Lower
ARM652	301181365200	MERCEDES E300 (W210) 1995-2003	Suspension Control Arm - Front Right Lower
ARM652	301181365200	MERCEDES E320 (W210) 1995-2003	Suspension Control Arm - Front Right Lower
ARM652	301181365200	MERCEDES E420 (W210) 1995-2003	Suspension Control Arm - Front Right Lower
ARM652	301181365200	MERCEDES E430 (W210) 1995-2003	Suspension Control Arm - Front Right Lower
ARM652	301181365200	MERCEDES E500 (W210) 1995-2003	Suspension Control Arm - Front Right Lower
ARM652	301181365200	MERCEDES E55 AMG (W210) 1995-2003	Suspension Control Arm - Front Right Lower
ARM653	301181365300	MERCEDES E280 (W210) 1995-2003	Suspension Control Arm - Front Left Lower
ARM653	301181365300	MERCEDES E300 (W210) 1995-2003	Suspension Control Arm - Front Left Lower
ARM653	301181365300	MERCEDES E320 (W210) 1995-2003	Suspension Control Arm - Front Left Lower
ARM653	301181365300	MERCEDES E420 (W210) 1995-2003	Suspension Control Arm - Front Left Lower
ARM653	301181365300	MERCEDES E430 (W210) 1995-2003	Suspension Control Arm - Front Left Lower
ARM653	301181365300	MERCEDES E500 (W210) 1995-2003	Suspension Control Arm - Front Left Lower
ARM653	301181365300	MERCEDES E55 AMG (W210) 1995-2003	Suspension Control Arm - Front Left Lower
ARM654	301181365400	MERCEDES C220 (W202) 1993-2000	Suspension Control Arm and Ball Joint Assembly - Front Right Upper
ARM654	301181365400	MERCEDES C230 (W202) 1993-2000	Suspension Control Arm and Ball Joint Assembly - Front Right Upper
ARM654	301181365400	MERCEDES C280 (W202) 1993-2000	Suspension Control Arm and Ball Joint Assembly - Front Right Upper
ARM654	301181365400	MERCEDES C36 AMG (W202) 1993-2000	Suspension Control Arm and Ball Joint Assembly - Front Right Upper
ARM654	301181365400	MERCEDES C43 AMG (W202) 1993-2000	Suspension Control Arm and Ball Joint Assembly - Front Right Upper
ARM654	301181365400	MERCEDES E280 (W210) 1995-2003	Suspension Control Arm and Ball Joint Assembly - Front Right Upper
ARM654	301181365400	MERCEDES E300 (W210) 1995-2003	Suspension Control Arm and Ball Joint Assembly - Front Right Upper
ARM654	301181365400	MERCEDES E320 (W210) 1995-2003	Suspension Control Arm and Ball Joint Assembly - Front Right Upper





 SHORT LONG			DESCRIPTION
ARM654	301181365400	MERCEDES E420 (W210) 1995-2003	Suspension Control Arm and Ball Joint Assembly - Front Right Upper
ARM654	301181365400	MERCEDES E430 (W210) 1995-2003	Suspension Control Arm and Ball Joint Assembly - Front Right Upper
ARM654	301181365400	MERCEDES E500 (W210) 1995-2003	Suspension Control Arm and Ball Joint Assembly - Front Right Upper
ARM654	301181365400	MERCEDES E55 AMG (W210) 1995-2003	Suspension Control Arm and Ball Joint Assembly - Front Right Upper
ARM655	301181365500	MERCEDES C220 (W202) 1993-2000	Suspension Control Arm and Ball Joint Assembly - Front Left Upper
ARM655	301181365500	MERCEDES C230 (W202) 1993-2000	Suspension Control Arm and Ball Joint Assembly - Front Left Upper
ARM655	301181365500	MERCEDES C280 (W202) 1993-2000	Suspension Control Arm and Ball Joint Assembly - Front Left Upper
ARM655	301181365500	MERCEDES C36 AMG (W202) 1993-2000	Suspension Control Arm and Ball Joint Assembly - Front Left Upper
ARM655	301181365500	MERCEDES C43 AMG (W202) 1993-2000	Suspension Control Arm and Ball Joint Assembly - Front Left Upper
ARM655	301181365500	MERCEDES E280 (W210) 1995-2003	Suspension Control Arm and Ball Joint Assembly - Front Left Upper
ARM655	301181365500	MERCEDES E300 (W210) 1995-2003	Suspension Control Arm and Ball Joint Assembly - Front Left Upper
ARM655	301181365500	MERCEDES E320 (W210) 1995-2003	Suspension Control Arm and Ball Joint Assembly - Front Left Upper
ARM655	301181365500	MERCEDES E420 (W210) 1995-2003	Suspension Control Arm and Ball Joint Assembly - Front Left Upper
ARM655	301181365500	MERCEDES E430 (W210) 1995-2003	Suspension Control Arm and Ball Joint Assembly - Front Left Upper
ARM655	301181365500	MERCEDES E500 (W210) 1995-2003	Suspension Control Arm and Ball Joint Assembly - Front Left Upper
ARM655	301181365500	MERCEDES E55 AMG (W210) 1995-2003	Suspension Control Arm and Ball Joint Assembly - Front Left Upper
ARM656	301181365600	MERCEDES CITAN 415 11/2012-	Suspension Control Arm and Ball Joint Assembly - Front Right
ARM657	301181365700	MERCEDES CITAN 415 11/2012-	Suspension Control Arm and Ball Joint Assembly - Front Left
ARM658	301181365800	MERCEDES E200 (W212) 01/2009-2016	Suspension Control Arm and Ball Joint Assembly - Front Right Lower Forward
ARM658	301181365800	MERCEDES E250 (W212) 01/2009-2016	Suspension Control Arm and Ball Joint Assembly - Front Right Lower Forward
ARM658	301181365800	MERCEDES E280 (W212) 01/2009-2016	Suspension Control Arm and Ball Joint Assembly - Front Right Lower Forward
ARM658	301181365800	MERCEDES E300 (W212) 01/2009-2016	Suspension Control Arm and Ball Joint Assembly - Front Right Lower Forward
ARM658	301181365800	MERCEDES E320 (W212) 01/2009-2016	Suspension Control Arm and Ball Joint Assembly - Front Right Lower Forward
ARM658	301181365800	MERCEDES E400 (W212) 01/2009-2016	Suspension Control Arm and Ball Joint Assembly - Front Right Lower Forward
ARM658	301181365800	MERCEDES E500 (W212) 01/2009-2016	Suspension Control Arm and Ball Joint Assembly - Front Right Lower Forward



			DESCRIPTION
SHORT	LONG		
ARM658	301181365800	MERCEDES E550 (W212) 01/2009-2016	Suspension Control Arm and Ball Joint Assembly - Front Right Lower Forward
ARM658	301181365800	MERCEDES E63 AMG (W212) 01/2009-2016	Suspension Control Arm and Ball Joint Assembly - Front Right Lower Forward
ARM659	301181365900	MERCEDES E200 (W212) 01/2009-2016	Suspension Control Arm and Ball Joint Assembly - Front Left Lower Forward
ARM659	301181365900	MERCEDES E250 (W212) 01/2009-2016	Suspension Control Arm and Ball Joint Assembly - Front Left Lower Forward
ARM659	301181365900	MERCEDES E280 (W212) 01/2009-2016	Suspension Control Arm and Ball Joint Assembly - Front Left Lower Forward
ARM659	301181365900	MERCEDES E300 (W212) 01/2009-2016	Suspension Control Arm and Ball Joint Assembly - Front Left Lower Forward
ARM659	301181365900	MERCEDES E320 (W212) 01/2009-2016	Suspension Control Arm and Ball Joint Assembly - Front Left Lower Forward
ARM659	301181365900	MERCEDES E400 (W212) 01/2009-2016	Suspension Control Arm and Ball Joint Assembly - Front Left Lower Forward
ARM659	301181365900	MERCEDES E500 (W212) 01/2009-2016	Suspension Control Arm and Ball Joint Assembly - Front Left Lower Forward
ARM659	301181365900	MERCEDES E550 (W212) 01/2009-2016	Suspension Control Arm and Ball Joint Assembly - Front Left Lower Forward
ARM659	301181365900	MERCEDES E63 AMG (W212) 01/2009-2016	Suspension Control Arm and Ball Joint Assembly - Front Left Lower Forward
ARM660	301181366000	MERCEDES E200 (W212) 01/2009-2016	Suspension Control Arm - Front Right Lower Rearward
ARM660	301181366000	MERCEDES E250 (W212) 01/2009-2016	Suspension Control Arm - Front Right Lower Rearward
ARM660	301181366000	MERCEDES E280 (W212) 01/2009-2016	Suspension Control Arm - Front Right Lower Rearward
ARM660	301181366000	MERCEDES E300 (W212) 01/2009-2016	Suspension Control Arm - Front Right Lower Rearward
ARM660	301181366000	MERCEDES E320 (W212) 01/2009-2016	Suspension Control Arm - Front Right Lower Rearward
ARM660	301181366000	MERCEDES E400 (W212) 01/2009-2016	Suspension Control Arm - Front Right Lower Rearward
ARM660	301181366000	MERCEDES E500 (W212) 01/2009-2016	Suspension Control Arm - Front Right Lower Rearward
ARM660	301181366000	MERCEDES E550 (W212) 01/2009-2016	Suspension Control Arm - Front Right Lower Rearward
ARM660	301181366000	MERCEDES E63 AMG (W212) 01/2009-2016	Suspension Control Arm - Front Right Lower Rearward
ARM661	301181366100	MERCEDES E200 (W212) 01/2009-2016	Suspension Control Arm - Front Left Lower Rearward
ARM661	301181366100	MERCEDES E250 (W212) 01/2009-2016	Suspension Control Arm - Front Left Lower Rearward
ARM661	301181366100	MERCEDES E280 (W212) 01/2009-2016	Suspension Control Arm - Front Left Lower Rearward
ARM661	301181366100	MERCEDES E300 (W212) 01/2009-2016	Suspension Control Arm - Front Left Lower Rearward
ARM661	301181366100	MERCEDES E320 (W212) 01/2009-2016	Suspension Control Arm - Front Left Lower Rearward





 SHORT LONG			DESCRIPTION
ARM661	301181366100	MERCEDES E400 (W212) 01/2009-2016	Suspension Control Arm - Front Left Lower Rearward
ARM661	301181366100	MERCEDES E500 (W212) 01/2009-2016	Suspension Control Arm - Front Left Lower Rearward
ARM661	301181366100	MERCEDES E550 (W212) 01/2009-2016	Suspension Control Arm - Front Left Lower Rearward
ARM661	301181366100	MERCEDES E63 AMG (W212) 01/2009-2016	Suspension Control Arm - Front Left Lower Rearward
ARM662	301181366200	MERCEDES CLS350 (C218) 2011-2017	Suspension Control Arm and Ball Joint Assembly - Front Lower Rearward
ARM662	301181366200	MERCEDES CLS500 (C218) 2011-2017	Suspension Control Arm and Ball Joint Assembly - Front Lower Rearward
ARM662	301181366200	MERCEDES CLS55 AMG (C218) 2011-2017	Suspension Control Arm and Ball Joint Assembly - Front Lower Rearward
ARM662	301181366200	MERCEDES CLS63 AMG C218 2011-2017	Suspension Control Arm and Ball Joint Assembly - Front Lower Rearward
ARM662	301181366200	MERCEDES E250 (W212) AWD 01/2009-2016	Suspension Control Arm and Ball Joint Assembly - Front Lower Rearward
ARM662	301181366200	MERCEDES E350 (W212) AWD 01/2009-2016	Suspension Control Arm and Ball Joint Assembly - Front Lower Rearward
ARM662	301181366200	MERCEDES E400 (W212) AWD 01/2009-2016	Suspension Control Arm and Ball Joint Assembly - Front Lower Rearward
ARM662	301181366200	MERCEDES E550 (W212) AWD 01/2009-2016	Suspension Control Arm and Ball Joint Assembly - Front Lower Rearward
ARM662	301181366200	MERCEDES E63 AMG (W212) AWD 01/2009-2016	Suspension Control Arm and Ball Joint Assembly - Front Lower Rearward
ARM662	301181366200	MERCEDES E63 AMG S (W212) AWD 01/2009-2016	Suspension Control Arm and Ball Joint Assembly - Front Lower Rearward
ARM663	301181366300	MERCEDES GLK250 (X204) 06/2008-2016	Suspension Control Arm and Ball Joint Assembly - Front Lower Rearward
ARM663	301181366300	MERCEDES GLK280 (X204) 06/2008-2016	Suspension Control Arm and Ball Joint Assembly - Front Lower Rearward
ARM663	301181366300	MERCEDES GLK300 (X204) 06/2008-2016	Suspension Control Arm and Ball Joint Assembly - Front Lower Rearward
ARM663	301181366300	MERCEDES GLK350 (X204) 06/2008-2016	Suspension Control Arm and Ball Joint Assembly - Front Lower Rearward
ARM664	301181366400	MERCEDES GLK250 (X204) 06/2008-2016	Suspension Control Arm and Ball Joint Assembly - Front Right Lower Rearward
ARM664	301181366400	MERCEDES GLK280 (X204) 06/2008-2016	Suspension Control Arm and Ball Joint Assembly - Front Right Lower Rearward
ARM664	301181366400	MERCEDES GLK300 (X204) 06/2008-2016	Suspension Control Arm and Ball Joint Assembly - Front Right Lower Rearward
ARM664	301181366400	MERCEDES GLK350 (X204) 06/2008-2016	Suspension Control Arm and Ball Joint Assembly - Front Right Lower Rearward
ARM665	301181366500	MERCEDES GLK250 (X204) 06/2008-2016	Suspension Control Arm and Ball Joint Assembly - Front Left Lower Rearward
ARM665	301181366500	MERCEDES GLK280 (X204) 06/2008-2016	Suspension Control Arm and Ball Joint Assembly - Front Left Lower Rearward
ARM665	301181366500	MERCEDES GLK300 (X204) 06/2008-2016	Suspension Control Arm and Ball Joint Assembly - Front Left Lower Rearward



			DESCRIPTION
SHORT	LONG		
ARM665	301181366500	MERCEDES GLK350 (X204) 06/2008-2016	Suspension Control Arm and Ball Joint Assembly - Front Left Lower Rearward
ARM666	301181366600	MERCEDES 190D (W201) 1982-1993	Lateral Arm - Rear Lower Rearward
ARM666	301181366600	MERCEDES 190E (W201) 1982-1993	Lateral Arm - Rear Lower Rearward
ARM666	301181366600	MERCEDES C200 (W203) 05/2000-02/2007	Lateral Arm - Rear Lower Rearward
ARM666	301181366600	MERCEDES C220 (W202) 1993-2000	Lateral Arm - Rear Lower Rearward
ARM666	301181366600	MERCEDES C230 (W202) 1993-2000	Lateral Arm - Rear Lower Rearward
ARM666	301181366600	MERCEDES C230 (W203) 05/2000-02/2007	Lateral Arm - Rear Lower Rearward
ARM666	301181366600	MERCEDES C240 (W203) 05/2000-02/2007	Lateral Arm - Rear Lower Rearward
ARM666	301181366600	MERCEDES C280 (W202) 1993-2000	Lateral Arm - Rear Lower Rearward
ARM666	301181366600	MERCEDES C280 (W203) 05/2000-02/2007	Lateral Arm - Rear Lower Rearward
ARM666	301181366600	MERCEDES C32 AMG (W203) 05/2000-02/2007	Lateral Arm - Rear Lower Rearward
ARM666	301181366600	MERCEDES C320 (W203) 05/2000-02/2007	Lateral Arm - Rear Lower Rearward
ARM666	301181366600	MERCEDES C350 (W203) 05/2000-02/2007	Lateral Arm - Rear Lower Rearward
ARM666	301181366600	MERCEDES C36 AMG (W202) 1993-2000	Lateral Arm - Rear Lower Rearward
ARM666	301181366600	MERCEDES C43 AMG (W202) 1993-2000	Lateral Arm - Rear Lower Rearward
ARM666	301181366600	MERCEDES C55 AMG (W203) 05/2000-02/2007	Lateral Arm - Rear Lower Rearward
ARM666	301181366600	MERCEDES CLK280 (A209-C209) 06/2002-05/2009	Lateral Arm - Rear Lower Rearward
ARM666	301181366600	MERCEDES CLK320 (A209-C209) 06/2002-05/2009	Lateral Arm - Rear Lower Rearward
ARM666	301181366600	MERCEDES CLK350 (A209-C209) 06/2002-05/2009	Lateral Arm - Rear Lower Rearward
ARM666	301181366600	MERCEDES CLK430 (A209-C209) 06/2002-05/2009	Lateral Arm - Rear Lower Rearward
ARM666	301181366600	MERCEDES CLK500 (A209-C209) 06/2002-05/2009	Lateral Arm - Rear Lower Rearward
ARM666	301181366600	MERCEDES CLK55 AMG (A209-C209) 06/2002-05/2009	Lateral Arm - Rear Lower Rearward
ARM666	301181366600	MERCEDES CLK550 (A209-C209) 06/2002-05/2009	Lateral Arm - Rear Lower Rearward
ARM666	301181366600	MERCEDES CLK63 AMG (A209-C209) 06/2002-05/2009	Lateral Arm - Rear Lower Rearward
ARM666	301181366600	MERCEDES E280 (W210) 1995-2003	Lateral Arm - Rear Lower Rearward
ARM666	301181366600	MERCEDES E300 (W124) 1985-1996	Lateral Arm - Rear Lower Rearward
ARM666	301181366600	MERCEDES E300 (W210) 1995-2003	Lateral Arm - Rear Lower Rearward
ARM666	301181366600	MERCEDES E320 (W124) 1985-1996	Lateral Arm - Rear Lower Rearward
ARM666	301181366600	MERCEDES E320 (W210) 1995-2003	Lateral Arm - Rear Lower Rearward
ARM666	301181366600	MERCEDES E420 (W124) 1985-1996	Lateral Arm - Rear Lower Rearward
ARM666	301181366600	MERCEDES E420 (W210) 1995-2003	Lateral Arm - Rear Lower Rearward
ARM666	301181366600	MERCEDES E430 (W124) 1985-1996	Lateral Arm - Rear Lower Rearward
ARM666	301181366600	MERCEDES E430 (W210) 1995-2003	Lateral Arm - Rear Lower Rearward
ARM666	301181366600	MERCEDES E500 (W124) 1985-1996	Lateral Arm - Rear Lower Rearward





 SHORT LONG			DESCRIPTION
ARM666	301181366600	MERCEDES E500 (W210) 1995-2003	Lateral Arm - Rear Lower Rearward
ARM666	301181366600	MERCEDES E55 AMG (W124) 1985-1996	Lateral Arm - Rear Lower Rearward
ARM666	301181366600	MERCEDES E55 AMG (W210) 1995-2003	Lateral Arm - Rear Lower Rearward
ARM666	301181366600	MERCEDES SL500 (R129) 03/1989-12/2001	Lateral Arm - Rear Lower Rearward
ARM666	301181366600	MERCEDES SL600 (R129) 03/1989-12/2001	Lateral Arm - Rear Lower Rearward
ARM666	301181366600	MERCEDES SLK200 (R170) 1997-2004	Lateral Arm - Rear Lower Rearward
ARM667	301181366700	MERCEDES 190D (W201) 1982-1993	Lateral Arm - Rear Right Upper
ARM667	301181366700	MERCEDES 190E (W201) 1982-1993	Lateral Arm - Rear Right Upper
ARM667	301181366700	MERCEDES C200 (W203) 05/2000-02/2007	Lateral Arm - Rear Right Upper
ARM667	301181366700	MERCEDES C220 (W202) 1993-2000	Lateral Arm - Rear Right Upper
ARM667	301181366700	MERCEDES C230 (W202) 1993-2000	Lateral Arm - Rear Right Upper
ARM667	301181366700	MERCEDES C230 (W203) 05/2000-02/2007	Lateral Arm - Rear Right Upper
ARM667	301181366700	MERCEDES C240 (W203) 05/2000-02/2007	Lateral Arm - Rear Right Upper
ARM667	301181366700	MERCEDES C280 (W202) 1993-2000	Lateral Arm - Rear Right Upper
ARM667	301181366700	MERCEDES C280 (W203) 05/2000-02/2007	Lateral Arm - Rear Right Upper
ARM667	301181366700	MERCEDES C32 AMG (W203) 05/2000-02/2007	Lateral Arm - Rear Right Upper
ARM667	301181366700	MERCEDES C320 (W203) 05/2000-02/2007	Lateral Arm - Rear Right Upper
ARM667	301181366700	MERCEDES C350 (W203) 05/2000-02/2007	Lateral Arm - Rear Right Upper
ARM667	301181366700	MERCEDES C36 AMG (W202) 1993-2000	Lateral Arm - Rear Right Upper
ARM667	301181366700	MERCEDES C43 AMG (W202) 1993-2000	Lateral Arm - Rear Right Upper
ARM667	301181366700	MERCEDES C55 AMG (W203) 05/2000-02/2007	Lateral Arm - Rear Right Upper
ARM667	301181366700	MERCEDES CLK280 (A209-C209) 06/2002-05/2009	Lateral Arm - Rear Right Upper
ARM667	301181366700	MERCEDES CLK320 (A209-C209) 06/2002-05/2009	Lateral Arm - Rear Right Upper
ARM667	301181366700	MERCEDES CLK350 (A209-C209) 06/2002-05/2009	Lateral Arm - Rear Right Upper
ARM667	301181366700	MERCEDES CLK430 (A209-C209) 06/2002-05/2009	Lateral Arm - Rear Right Upper
ARM667	301181366700	MERCEDES CLK500 (A209-C209) 06/2002-05/2009	Lateral Arm - Rear Right Upper
ARM667	301181366700	MERCEDES CLK55 AMG (A209-C209) 06/2002-05/2009	Lateral Arm - Rear Right Upper
ARM667	301181366700	MERCEDES CLK550 (A209-C209) 06/2002-05/2009	Lateral Arm - Rear Right Upper
ARM667	301181366700	MERCEDES CLK63 AMG (A209-C209) 06/2002-05/2009	Lateral Arm - Rear Right Upper
ARM667	301181366700	MERCEDES E280 (W210) 1995-2003	Lateral Arm - Rear Right Upper
ARM667	301181366700	MERCEDES E300 (W124) 1985-1996	Lateral Arm - Rear Right Upper
ARM667	301181366700	MERCEDES E300 (W210) 1995-2003	Lateral Arm - Rear Right Upper
ARM667	301181366700	MERCEDES E320 (W124) 1985-1996	Lateral Arm - Rear Right Upper
ARM667	301181366700	MERCEDES E320 (W210) 1995-2003	Lateral Arm - Rear Right Upper
ARM667	301181366700	MERCEDES E420 (W124) 1985-1996	Lateral Arm - Rear Right Upper



			DESCRIPTION
SHORT	LONG		
ARM667	301181366700	MERCEDES E420 (W210) 1995-2003	Lateral Arm - Rear Right Upper
ARM667	301181366700	MERCEDES E430 (W124) 1985-1996	Lateral Arm - Rear Right Upper
ARM667	301181366700	MERCEDES E430 (W210) 1995-2003	Lateral Arm - Rear Right Upper
ARM667	301181366700	MERCEDES E500 (W124) 1985-1996	Lateral Arm - Rear Right Upper
ARM667	301181366700	MERCEDES E500 (W210) 1995-2003	Lateral Arm - Rear Right Upper
ARM667	301181366700	MERCEDES E55 AMG (W124) 1985-1996	Lateral Arm - Rear Right Upper
ARM667	301181366700	MERCEDES E55 AMG (W210) 1995-2003	Lateral Arm - Rear Right Upper
ARM667	301181366700	MERCEDES SL500 (R129) 03/1989-12/2001	Lateral Arm - Rear Right Upper
ARM667	301181366700	MERCEDES SL600 (R129) 03/1989-12/2001	Lateral Arm - Rear Right Upper
ARM667	301181366700	MERCEDES SLK200 (R170) 1997-2004	Lateral Arm - Rear Right Upper
ARM668	301181366800	MERCEDES 190D (W201) 1982-1993	Suspension Control Arm Kit - Rear Right Upper
ARM668	301181366800	MERCEDES 190E (W201) 1982-1993	Suspension Control Arm Kit - Rear Right Upper
ARM668	301181366800	MERCEDES C200 (W203) 05/2000-02/2007	Suspension Control Arm Kit - Rear Right Upper
ARM668	301181366800	MERCEDES C220 (W202) 1993-2000	Suspension Control Arm Kit - Rear Right Upper
ARM668	301181366800	MERCEDES C230 (W202) 1993-2000	Suspension Control Arm Kit - Rear Right Upper
ARM668	301181366800	MERCEDES C230 (W203) 05/2000-02/2007	Suspension Control Arm Kit - Rear Right Upper
ARM668	301181366800	MERCEDES C240 (W203) 05/2000-02/2007	Suspension Control Arm Kit - Rear Right Upper
ARM668	301181366800	MERCEDES C280 (W202) 1993-2000	Suspension Control Arm Kit - Rear Right Upper
ARM668	301181366800	MERCEDES C280 (W203) 05/2000-02/2007	Suspension Control Arm Kit - Rear Right Upper
ARM668	301181366800	MERCEDES C32 AMG (W203) 05/2000-02/2007	Suspension Control Arm Kit - Rear Right Upper
ARM668	301181366800	MERCEDES C320 (W203) 05/2000-02/2007	Suspension Control Arm Kit - Rear Right Upper
ARM668	301181366800	MERCEDES C350 (W203) 05/2000-02/2007	Suspension Control Arm Kit - Rear Right Upper
ARM668	301181366800	MERCEDES C36 AMG (W202) 1993-2000	Suspension Control Arm Kit - Rear Right Upper
ARM668	301181366800	MERCEDES C43 AMG (W202) 1993-2000	Suspension Control Arm Kit - Rear Right Upper
ARM668	301181366800	MERCEDES C55 AMG (W203) 05/2000-02/2007	Suspension Control Arm Kit - Rear Right Upper
ARM668	301181366800	MERCEDES CLK280 (A209-C209) 06/2002-05/2009	Suspension Control Arm Kit - Rear Right Upper
ARM668	301181366800	MERCEDES CLK320 (A209-C209) 06/2002-05/2009	Suspension Control Arm Kit - Rear Right Upper
ARM668	301181366800	MERCEDES CLK350 (A209-C209) 06/2002-05/2009	Suspension Control Arm Kit - Rear Right Upper
ARM668	301181366800	MERCEDES CLK430 (A209-C209) 06/2002-05/2009	Suspension Control Arm Kit - Rear Right Upper





 SHORT LONG			DESCRIPTION
ARM668	301181366800	MERCEDES CLK500 (A209-C209) 06/2002-05/2009	Suspension Control Arm Kit - Rear Right Upper
ARM668	301181366800	MERCEDES CLK55 AMG (A209-C209) 06/2002-05/2009	Suspension Control Arm Kit - Rear Right Upper
ARM668	301181366800	MERCEDES CLK550 (A209-C209) 06/2002-05/2009	Suspension Control Arm Kit - Rear Right Upper
ARM668	301181366800	MERCEDES CLK63 AMG (A209-C209) 06/2002-05/2009	Suspension Control Arm Kit - Rear Right Upper
ARM668	301181366800	MERCEDES E300 (W124) 1985-1996	Suspension Control Arm Kit - Rear Right Upper
ARM668	301181366800	MERCEDES E320 (W124) 1985-1996	Suspension Control Arm Kit - Rear Right Upper
ARM668	301181366800	MERCEDES E420 (W124) 1985-1996	Suspension Control Arm Kit - Rear Right Upper
ARM668	301181366800	MERCEDES E430 (W124) 1985-1996	Suspension Control Arm Kit - Rear Right Upper
ARM668	301181366800	MERCEDES E500 (W124) 1985-1996	Suspension Control Arm Kit - Rear Right Upper
ARM668	301181366800	MERCEDES E55 AMG (W124) 1985-1996	Suspension Control Arm Kit - Rear Right Upper
ARM668	301181366800	MERCEDES SLK200 (R170) 1997-2004	Suspension Control Arm Kit - Rear Right Upper
ARM669	301181366900	MERCEDES 190D (W201) 1982-1993	Lateral Arm - Rear Left Upper
ARM669	301181366900	MERCEDES 190E (W201) 1982-1993	Lateral Arm - Rear Left Upper
ARM669	301181366900	MERCEDES C200 (W203) 05/2000-02/2007	Lateral Arm - Rear Left Upper
ARM669	301181366900	MERCEDES C220 (W202) 1993-2000	Lateral Arm - Rear Left Upper
ARM669	301181366900	MERCEDES C230 (W202) 1993-2000	Lateral Arm - Rear Left Upper
ARM669	301181366900	MERCEDES C230 (W203) 05/2000-02/2007	Lateral Arm - Rear Left Upper
ARM669	301181366900	MERCEDES C240 (W203) 05/2000-02/2007	Lateral Arm - Rear Left Upper
ARM669	301181366900	MERCEDES C280 (W202) 1993-2000	Lateral Arm - Rear Left Upper
ARM669	301181366900	MERCEDES C280 (W203) 05/2000-02/2007	Lateral Arm - Rear Left Upper
ARM669	301181366900	MERCEDES C32 AMG (W203) 05/2000-02/2007	Lateral Arm - Rear Left Upper
ARM669	301181366900	MERCEDES C320 (W203) 05/2000-02/2007	Lateral Arm - Rear Left Upper
ARM669	301181366900	MERCEDES C350 (W203) 05/2000-02/2007	Lateral Arm - Rear Left Upper
ARM669	301181366900	MERCEDES C36 AMG (W202) 1993-2000	Lateral Arm - Rear Left Upper
ARM669	301181366900	MERCEDES C43 AMG (W202) 1993-2000	Lateral Arm - Rear Left Upper
ARM669	301181366900	MERCEDES C55 AMG (W203) 05/2000-02/2007	Lateral Arm - Rear Left Upper
ARM669	301181366900	MERCEDES CLK280 (A209-C209) 06/2002-05/2009	Lateral Arm - Rear Left Upper
ARM669	301181366900	MERCEDES CLK320 (A209-C209) 06/2002-05/2009	Lateral Arm - Rear Left Upper
ARM669	301181366900	MERCEDES CLK350 (A209-C209) 06/2002-05/2009	Lateral Arm - Rear Left Upper
ARM669	301181366900	MERCEDES CLK430 (A209-C209) 06/2002-05/2009	Lateral Arm - Rear Left Upper



 SHORT LONG			DESCRIPTION
ARM669	301181366900	MERCEDES CLK500 (A209-C209) 06/2002-05/2009	Lateral Arm - Rear Left Upper
ARM669	301181366900	MERCEDES CLK55 AMG (A209-C209) 06/2002-05/2009	Lateral Arm - Rear Left Upper
ARM669	301181366900	MERCEDES CLK550 (A209-C209) 06/2002-05/2009	Lateral Arm - Rear Left Upper
ARM669	301181366900	MERCEDES CLK63 AMG (A209-C209) 06/2002-05/2009	Lateral Arm - Rear Left Upper
ARM669	301181366900	MERCEDES E280 (W210) 1995-2003	Lateral Arm - Rear Left Upper
ARM669	301181366900	MERCEDES E300 (W124) 1985-1996	Lateral Arm - Rear Left Upper
ARM669	301181366900	MERCEDES E300 (W210) 1995-2003	Lateral Arm - Rear Left Upper
ARM669	301181366900	MERCEDES E320 (W124) 1985-1996	Lateral Arm - Rear Left Upper
ARM669	301181366900	MERCEDES E320 (W210) 1995-2003	Lateral Arm - Rear Left Upper
ARM669	301181366900	MERCEDES E420 (W124) 1985-1996	Lateral Arm - Rear Left Upper
ARM669	301181366900	MERCEDES E420 (W210) 1995-2003	Lateral Arm - Rear Left Upper
ARM669	301181366900	MERCEDES E430 (W124) 1985-1996	Lateral Arm - Rear Left Upper
ARM669	301181366900	MERCEDES E430 (W210) 1995-2003	Lateral Arm - Rear Left Upper
ARM669	301181366900	MERCEDES E500 (W124) 1985-1996	Lateral Arm - Rear Left Upper
ARM669	301181366900	MERCEDES E500 (W210) 1995-2003	Lateral Arm - Rear Left Upper
ARM669	301181366900	MERCEDES E55 AMG (W124) 1985-1996	Lateral Arm - Rear Left Upper
ARM669	301181366900	MERCEDES E55 AMG (W210) 1995-2003	Lateral Arm - Rear Left Upper
ARM669	301181366900	MERCEDES SL500 (R129) 03/1989-12/2001	Lateral Arm - Rear Left Upper
ARM669	301181366900	MERCEDES SL600 (R129) 03/1989-12/2001	Lateral Arm - Rear Left Upper
ARM669	301181366900	MERCEDES SLK200 (R170) 1997-2004	Lateral Arm - Rear Left Upper
ARM670	301181367000	MERCEDES 190D (W201) 1982-1993	Suspension Control Arm Kit - Rear Left Upper
ARM670	301181367000	MERCEDES 190E (W201) 1982-1993	Suspension Control Arm Kit - Rear Left Upper
ARM670	301181367000	MERCEDES C200 (W203) 05/2000-02/2007	Suspension Control Arm Kit - Rear Left Upper
ARM670	301181367000	MERCEDES C220 (W202) 1993-2000	Suspension Control Arm Kit - Rear Left Upper
ARM670	301181367000	MERCEDES C230 (W202) 1993-2000	Suspension Control Arm Kit - Rear Left Upper
ARM670	301181367000	MERCEDES C230 (W203) 05/2000-02/2007	Suspension Control Arm Kit - Rear Left Upper
ARM670	301181367000	MERCEDES C240 (W203) 05/2000-02/2007	Suspension Control Arm Kit - Rear Left Upper
ARM670	301181367000	MERCEDES C280 (W202) 1993-2000	Suspension Control Arm Kit - Rear Left Upper
ARM670	301181367000	MERCEDES C280 (W203) 05/2000-02/2007	Suspension Control Arm Kit - Rear Left Upper
ARM670	301181367000	MERCEDES C32 AMG (W203) 05/2000-02/2007	Suspension Control Arm Kit - Rear Left Upper
ARM670	301181367000	MERCEDES C320 (W203) 05/2000-02/2007	Suspension Control Arm Kit - Rear Left Upper
ARM670	301181367000	MERCEDES C350 (W203) 05/2000-02/2007	Suspension Control Arm Kit - Rear Left Upper
ARM670	301181367000	MERCEDES C36 AMG (W202) 1993-2000	Suspension Control Arm Kit - Rear Left Upper
ARM670	301181367000	MERCEDES C43 AMG (W202) 1993-2000	Suspension Control Arm Kit - Rear Left Upper
ARM670	301181367000	MERCEDES C55 AMG (W203) 05/2000-02/2007	Suspension Control Arm Kit - Rear Left Upper
ARM670	301181367000	MERCEDES CLK280 (A209-C209) 06/2002-05/2009	Suspension Control Arm Kit - Rear Left Upper





 SHORT LONG			DESCRIPTION
ARM670	301181367000	MERCEDES CLK320 (A209-C209) 06/2002-05/2009	Suspension Control Arm Kit - Rear Left Upper
ARM670	301181367000	MERCEDES CLK350 (A209-C209) 06/2002-05/2009	Suspension Control Arm Kit - Rear Left Upper
ARM670	301181367000	MERCEDES CLK430 (A209-C209) 06/2002-05/2009	Suspension Control Arm Kit - Rear Left Upper
ARM670	301181367000	MERCEDES CLK500 (A209-C209) 06/2002-05/2009	Suspension Control Arm Kit - Rear Left Upper
ARM670	301181367000	MERCEDES CLK55 AMG (A209-C209) 06/2002-05/2009	Suspension Control Arm Kit - Rear Left Upper
ARM670	301181367000	MERCEDES CLK550 (A209-C209) 06/2002-05/2009	Suspension Control Arm Kit - Rear Left Upper
ARM670	301181367000	MERCEDES CLK63 AMG (A209-C209) 06/2002-05/2009	Suspension Control Arm Kit - Rear Left Upper
ARM670	301181367000	MERCEDES E300 (W124) 1985-1996	Suspension Control Arm Kit - Rear Left Upper
ARM670	301181367000	MERCEDES E320 (W124) 1985-1996	Suspension Control Arm Kit - Rear Left Upper
ARM670	301181367000	MERCEDES E420 (W124) 1985-1996	Suspension Control Arm Kit - Rear Left Upper
ARM670	301181367000	MERCEDES E430 (W124) 1985-1996	Suspension Control Arm Kit - Rear Left Upper
ARM670	301181367000	MERCEDES E500 (W124) 1985-1996	Suspension Control Arm Kit - Rear Left Upper
ARM670	301181367000	MERCEDES E55 AMG (W124) 1985-1996	Suspension Control Arm Kit - Rear Left Upper
ARM670	301181367000	MERCEDES SLK200 (R170) 1997-2004	Suspension Control Arm Kit - Rear Left Upper
ARM671	301181367100	MERCEDES 190D (W201) 1982-1993	Lateral Arm - Rear Upper Forward
ARM671	301181367100	MERCEDES 190E (W201) 1982-1993	Lateral Arm - Rear Upper Forward
ARM671	301181367100	MERCEDES C200 (W203) 05/2000-02/2007	Lateral Arm - Rear Upper Forward
ARM671	301181367100	MERCEDES C220 (W202) 1993-2000	Lateral Arm - Rear Upper Forward
ARM671	301181367100	MERCEDES C230 (W202) 1993-2000	Lateral Arm - Rear Upper Forward
ARM671	301181367100	MERCEDES C230 (W203) 05/2000-02/2007	Lateral Arm - Rear Upper Forward
ARM671	301181367100	MERCEDES C240 (W203) 05/2000-02/2007	Lateral Arm - Rear Upper Forward
ARM671	301181367100	MERCEDES C280 (W202) 1993-2000	Lateral Arm - Rear Upper Forward
ARM671	301181367100	MERCEDES C280 (W203) 05/2000-02/2007	Lateral Arm - Rear Upper Forward
ARM671	301181367100	MERCEDES C32 AMG (W203) 05/2000-02/2007	Lateral Arm - Rear Upper Forward
ARM671	301181367100	MERCEDES C320 (W203) 05/2000-02/2007	Lateral Arm - Rear Upper Forward
ARM671	301181367100	MERCEDES C350 (W203) 05/2000-02/2007	Lateral Arm - Rear Upper Forward
ARM671	301181367100	MERCEDES C36 AMG (W202) 1993-2000	Lateral Arm - Rear Upper Forward
ARM671	301181367100	MERCEDES C43 AMG (W202) 1993-2000	Lateral Arm - Rear Upper Forward
ARM671	301181367100	MERCEDES C55 AMG (W203) 05/2000-02/2007	Lateral Arm - Rear Upper Forward
ARM671	301181367100	MERCEDES CLK280 (A209-C209) 06/2002-05/2009	Lateral Arm - Rear Upper Forward
ARM671	301181367100	MERCEDES CLK320 (A209-C209) 06/2002-05/2009	Lateral Arm - Rear Upper Forward
ARM671	301181367100	MERCEDES CLK350 (A209-C209) 06/2002-05/2009	Lateral Arm - Rear Upper Forward
ARM671	301181367100	MERCEDES CLK430 (A209-C209) 06/2002-05/2009	Lateral Arm - Rear Upper Forward



 SHORT LONG			DESCRIPTION
ARM671	301181367100	MERCEDES CLK500 (A209-C209) 06/2002-05/2009	Lateral Arm - Rear Upper Forward
ARM671	301181367100	MERCEDES CLK55 AMG (A209-C209) 06/2002-05/2009	Lateral Arm - Rear Upper Forward
ARM671	301181367100	MERCEDES CLK550 (A209-C209) 06/2002-05/2009	Lateral Arm - Rear Upper Forward
ARM671	301181367100	MERCEDES CLK63 AMG (A209-C209) 06/2002-05/2009	Lateral Arm - Rear Upper Forward
ARM671	301181367100	MERCEDES E280 (W210) 1995-2003	Lateral Arm - Rear Upper Forward
ARM671	301181367100	MERCEDES E300 (W124) 1985-1996	Lateral Arm - Rear Upper Forward
ARM671	301181367100	MERCEDES E300 (W210) 1995-2003	Lateral Arm - Rear Upper Forward
ARM671	301181367100	MERCEDES E320 (W124) 1985-1996	Lateral Arm - Rear Upper Forward
ARM671	301181367100	MERCEDES E320 (W210) 1995-2003	Lateral Arm - Rear Upper Forward
ARM671	301181367100	MERCEDES E420 (W124) 1985-1996	Lateral Arm - Rear Upper Forward
ARM671	301181367100	MERCEDES E420 (W210) 1995-2003	Lateral Arm - Rear Upper Forward
ARM671	301181367100	MERCEDES E430 (W124) 1985-1996	Lateral Arm - Rear Upper Forward
ARM671	301181367100	MERCEDES E430 (W210) 1995-2003	Lateral Arm - Rear Upper Forward
ARM671	301181367100	MERCEDES E500 (W124) 1985-1996	Lateral Arm - Rear Upper Forward
ARM671	301181367100	MERCEDES E500 (W210) 1995-2003	Lateral Arm - Rear Upper Forward
ARM671	301181367100	MERCEDES E55 AMG (W124) 1985-1996	Lateral Arm - Rear Upper Forward
ARM671	301181367100	MERCEDES E55 AMG (W210) 1995-2003	Lateral Arm - Rear Upper Forward
ARM671	301181367100	MERCEDES SL500 (R129) 03/1989-12/2001	Lateral Arm - Rear Upper Forward
ARM671	301181367100	MERCEDES SL600 (R129) 03/1989-12/2001	Lateral Arm - Rear Upper Forward
ARM671	301181367100	MERCEDES SLK200 (R170) 1997-2004	Lateral Arm - Rear Upper Forward
ARM672	301181367200	MERCEDES 190D (W201) 1982-1993	Lateral Arm - Rear Lower Forward
ARM672	301181367200	MERCEDES 190E (W201) 1982-1993	Lateral Arm - Rear Lower Forward
ARM672	301181367200	MERCEDES C200 (W203) 05/2000-02/2007	Lateral Arm - Rear Lower Forward
ARM672	301181367200	MERCEDES C220 (W202) 1993-2000	Lateral Arm - Rear Lower Forward
ARM672	301181367200	MERCEDES C230 (W202) 1993-2000	Lateral Arm - Rear Lower Forward
ARM672	301181367200	MERCEDES C230 (W203) 05/2000-02/2007	Lateral Arm - Rear Lower Forward
ARM672	301181367200	MERCEDES C240 (W203) 05/2000-02/2007	Lateral Arm - Rear Lower Forward
ARM672	301181367200	MERCEDES C280 (W202) 1993-2000	Lateral Arm - Rear Lower Forward
ARM672	301181367200	MERCEDES C280 (W203) 05/2000-02/2007	Lateral Arm - Rear Lower Forward
ARM672	301181367200	MERCEDES C32 AMG (W203) 05/2000-02/2007	Lateral Arm - Rear Lower Forward
ARM672	301181367200	MERCEDES C320 (W203) 05/2000-02/2007	Lateral Arm - Rear Lower Forward
ARM672	301181367200	MERCEDES C350 (W203) 05/2000-02/2007	Lateral Arm - Rear Lower Forward
ARM672	301181367200	MERCEDES C36 AMG (W202) 1993-2000	Lateral Arm - Rear Lower Forward
ARM672	301181367200	MERCEDES C43 AMG (W202) 1993-2000	Lateral Arm - Rear Lower Forward
ARM672	301181367200	MERCEDES C55 AMG (W203) 05/2000-02/2007	Lateral Arm - Rear Lower Forward
ARM672	301181367200	MERCEDES E280 (W210) 1995-2003	Lateral Arm - Rear Lower Forward
ARM672	301181367200	MERCEDES E300 (W124) 1985-1996	Lateral Arm - Rear Lower Forward





			DESCRIPTION
SHORT	LONG		
ARM672	301181367200	MERCEDES E300 (W210) 1995-2003	Lateral Arm - Rear Lower Forward
ARM672	301181367200	MERCEDES E320 (W124) 1985-1996	Lateral Arm - Rear Lower Forward
ARM672	301181367200	MERCEDES E320 (W210) 1995-2003	Lateral Arm - Rear Lower Forward
ARM672	301181367200	MERCEDES E420 (W124) 1985-1996	Lateral Arm - Rear Lower Forward
ARM672	301181367200	MERCEDES E420 (W210) 1995-2003	Lateral Arm - Rear Lower Forward
ARM672	301181367200	MERCEDES E430 (W124) 1985-1996	Lateral Arm - Rear Lower Forward
ARM672	301181367200	MERCEDES E430 (W210) 1995-2003	Lateral Arm - Rear Lower Forward
ARM672	301181367200	MERCEDES E500 (W124) 1985-1996	Lateral Arm - Rear Lower Forward
ARM672	301181367200	MERCEDES E500 (W210) 1995-2003	Lateral Arm - Rear Lower Forward
ARM672	301181367200	MERCEDES E55 AMG (W124) 1985-1996	Lateral Arm - Rear Lower Forward
ARM672	301181367200	MERCEDES E55 AMG (W210) 1995-2003	Lateral Arm - Rear Lower Forward
ARM672	301181367200	MERCEDES SLK200 (R170) 1997-2004	Lateral Arm - Rear Lower Forward
ARM673	301181367300	MERCEDES 190D (W201) 1982-1993	Suspension Control Arm Kit - Rear
ARM673	301181367300	MERCEDES 190E (W201) 1982-1993	Suspension Control Arm Kit - Rear
ARM673	301181367300	MERCEDES C200 (W203) 05/2000-02/2007	Suspension Control Arm Kit - Rear
ARM673	301181367300	MERCEDES C220 (W202) 1993-2000	Suspension Control Arm Kit - Rear
ARM673	301181367300	MERCEDES C230 (W202) 1993-2000	Suspension Control Arm Kit - Rear
ARM673	301181367300	MERCEDES C230 (W203) 05/2000-02/2007	Suspension Control Arm Kit - Rear
ARM673	301181367300	MERCEDES C240 (W203) 05/2000-02/2007	Suspension Control Arm Kit - Rear
ARM673	301181367300	MERCEDES C280 (W202) 1993-2000	Suspension Control Arm Kit - Rear
ARM673	301181367300	MERCEDES C280 (W203) 05/2000-02/2007	Suspension Control Arm Kit - Rear
ARM673	301181367300	MERCEDES C32 AMG (W203) 05/2000-02/2007	Suspension Control Arm Kit - Rear
ARM673	301181367300	MERCEDES C320 (W203) 05/2000-02/2007	Suspension Control Arm Kit - Rear
ARM673	301181367300	MERCEDES C350 (W203) 05/2000-02/2007	Suspension Control Arm Kit - Rear
ARM673	301181367300	MERCEDES C36 AMG (W202) 1993-2000	Suspension Control Arm Kit - Rear
ARM673	301181367300	MERCEDES C43 AMG (W202) 1993-2000	Suspension Control Arm Kit - Rear
ARM673	301181367300	MERCEDES C55 AMG (W203) 05/2000-02/2007	Suspension Control Arm Kit - Rear
ARM673	301181367300	MERCEDES E300 (W124) 1985-1996	Suspension Control Arm Kit - Rear
ARM673	301181367300	MERCEDES E320 (W124) 1985-1996	Suspension Control Arm Kit - Rear
ARM673	301181367300	MERCEDES E420 (W124) 1985-1996	Suspension Control Arm Kit - Rear
ARM673	301181367300	MERCEDES E430 (W124) 1985-1996	Suspension Control Arm Kit - Rear
ARM673	301181367300	MERCEDES E500 (W124) 1985-1996	Suspension Control Arm Kit - Rear
ARM673	301181367300	MERCEDES E55 AMG (W124) 1985-1996	Suspension Control Arm Kit - Rear
ARM673	301181367300	MERCEDES SLK200 (R170) 1997-2004	Suspension Control Arm Kit - Rear
ARM674	301181367400	MERCEDES A160 (W168) 1997-2004	Suspension Control Arm and Ball Joint Assembly - Front Right Lower
ARM674	301181367400	MERCEDES A190 (W168) 1997-2004	Suspension Control Arm and Ball Joint Assembly - Front Right Lower
ARM675	301181367500	MERCEDES A160 (W168) 1997-2004	Suspension Control Arm and Ball Joint Assembly - Front Left Lower



			DESCRIPTION
SHORT	LONG		
ARM675	301181367500	MERCEDES A190 (W168) 1997-2004	Suspension Control Arm and Ball Joint Assembly - Front Left Lower
ARM676	301181367600	MERCEDES A160 (W169) 09/2004-06/2012	Suspension Control Arm and Ball Joint Assembly - Front Right Lower
ARM676	301181367600	MERCEDES A190 (W169) 09/2004-06/2012	Suspension Control Arm and Ball Joint Assembly - Front Right Lower
ARM676	301181367600	MERCEDES B180 (W245) 03/2005-11/2011	Suspension Control Arm and Ball Joint Assembly - Front Right Lower
ARM676	301181367600	MERCEDES B200 (W245) 03/2005-11/2011	Suspension Control Arm and Ball Joint Assembly - Front Right Lower
ARM677	301181367700	MERCEDES A160 (W169) 09/2004-06/2012	Suspension Control Arm and Ball Joint Assembly - Front Left Lower
ARM677	301181367700	MERCEDES A190 (W169) 09/2004-06/2012	Suspension Control Arm and Ball Joint Assembly - Front Left Lower
ARM677	301181367700	MERCEDES B180 (W245) 03/2005-11/2011	Suspension Control Arm and Ball Joint Assembly - Front Left Lower
ARM677	301181367700	MERCEDES B200 (W245) 03/2005-11/2011	Suspension Control Arm and Ball Joint Assembly - Front Left Lower
ARM678	301181367800	MERCEDES C180 (W204) 10/2007-11/2013	Suspension Control Arm and Ball Joint Assembly - Front Right Forward
ARM678	301181367800	MERCEDES C200 (W204) 10/2007-11/2013	Suspension Control Arm and Ball Joint Assembly - Front Right Forward
ARM678	301181367800	MERCEDES C240 (W204) 2007-2014	Suspension Control Arm and Ball Joint Assembly - Front Right Forward
ARM678	301181367800	MERCEDES C300 (W204) 10/2007-11/2013	Suspension Control Arm and Ball Joint Assembly - Front Right Forward
ARM679	301181367900	MERCEDES C180 (W204) 10/2007-11/2013	Suspension Control Arm and Ball Joint Assembly - Front Left Forward
ARM679	301181367900	MERCEDES C200 (W204) 10/2007-11/2013	Suspension Control Arm and Ball Joint Assembly - Front Left Forward
ARM679	301181367900	MERCEDES C240 (W204) 2007-2014	Suspension Control Arm and Ball Joint Assembly - Front Left Forward
ARM679	301181367900	MERCEDES C300 (W204) 10/2007-11/2013	Suspension Control Arm and Ball Joint Assembly - Front Left Forward
ARM680	301181368000	MERCEDES A180 (W176) 06/2012-	Lateral Arm - Rear
ARM680	301181368000	MERCEDES A200 (W176) 06/2012-	Lateral Arm - Rear
ARM680	301181368000	MERCEDES A250 (W176) 06/2012-	Lateral Arm - Rear
ARM680	301181368000	MERCEDES CLA180 (W176) 06/2012-	Lateral Arm - Rear
ARM680	301181368000	MERCEDES CLA200 (W176) 06/2012-	Lateral Arm - Rear
ARM680	301181368000	MERCEDES CLA250 (W176) 06/2012-	Lateral Arm - Rear
ARM680	301181368000	MERCEDES GLA180 (X156) 12/2013-	Lateral Arm - Rear
ARM680	301181368000	MERCEDES GLA200 (X156) 12/2013-	Lateral Arm - Rear
ARM680	301181368000	MERCEDES GLA250 (X156) 12/2013-	Lateral Arm - Rear
ARM680	301181368000	MERCEDES GLA45 AMG (X156) 12/2013-	Lateral Arm - Rear
ARM681	301181368100	MERCEDES A180 (W176) 06/2012-	Lateral Arm - Rear Upper
ARM681	301181368100	MERCEDES A200 (W176) 06/2012-	Lateral Arm - Rear Upper
ARM681	301181368100	MERCEDES A250 (W176) 06/2012-	Lateral Arm - Rear Upper
ARM681	301181368100	MERCEDES CLA180 (W176) 06/2012-	Lateral Arm - Rear Upper





 SHORT LONG			DESCRIPTION
ARM681	301181368100	MERCEDES CLA200 (W176) 06/2012-	Lateral Arm - Rear Upper
ARM681	301181368100	MERCEDES CLA250 (W176) 06/2012-	Lateral Arm - Rear Upper
ARM681	301181368100	MERCEDES GLA180 (X156) 12/2013-	Lateral Arm - Rear Upper
ARM681	301181368100	MERCEDES GLA200 (X156) 12/2013-	Lateral Arm - Rear Upper
ARM681	301181368100	MERCEDES GLA250 (X156) 12/2013-	Lateral Arm - Rear Upper
ARM681	301181368100	MERCEDES GLA45 AMG (X156) 12/2013-	Lateral Arm - Rear Upper
ARM682	301181368200	MERCEDES A180 (W176) 06/2012-	Suspension Control Arm and Ball Joint Assembly - Front Right Lower
ARM682	301181368200	MERCEDES A200 (W176) 06/2012-	Suspension Control Arm and Ball Joint Assembly - Front Right Lower
ARM682	301181368200	MERCEDES A250 (W176) 06/2012-	Suspension Control Arm and Ball Joint Assembly - Front Right Lower
ARM682	301181368200	MERCEDES B180 (W246) 11/2011-2016	Suspension Control Arm and Ball Joint Assembly - Front Right Lower
ARM682	301181368200	MERCEDES B250 (W246) 11/2011-2016	Suspension Control Arm and Ball Joint Assembly - Front Right Lower
ARM682	301181368200	MERCEDES CLA180 (W176) 06/2012-	Suspension Control Arm and Ball Joint Assembly - Front Right Lower
ARM682	301181368200	MERCEDES CLA200 (W176) 06/2012-	Suspension Control Arm and Ball Joint Assembly - Front Right Lower
ARM682	301181368200	MERCEDES CLA250 (W176) 06/2012-	Suspension Control Arm and Ball Joint Assembly - Front Right Lower
ARM683	301181368300	MERCEDES A180 (W176) 06/2012-	Suspension Control Arm and Ball Joint Assembly - Front Left
ARM683	301181368300	MERCEDES A200 (W176) 06/2012-	Suspension Control Arm and Ball Joint Assembly - Front Left
ARM683	301181368300	MERCEDES A250 (W176) 06/2012-	Suspension Control Arm and Ball Joint Assembly - Front Left
ARM683	301181368300	MERCEDES B180 (W246) 11/2011-2016	Suspension Control Arm and Ball Joint Assembly - Front Left
ARM683	301181368300	MERCEDES B250 (W246) 11/2011-2016	Suspension Control Arm and Ball Joint Assembly - Front Left
ARM683	301181368300	MERCEDES CLA180 (W176) 06/2012-	Suspension Control Arm and Ball Joint Assembly - Front Left
ARM683	301181368300	MERCEDES CLA200 (W176) 06/2012-	Suspension Control Arm and Ball Joint Assembly - Front Left
ARM683	301181368300	MERCEDES CLA250 (W176) 06/2012-	Suspension Control Arm and Ball Joint Assembly - Front Left
ARM684	301181368400	MERCEDES VITO (W638) 03/1997-07/2003	Suspension Control Arm and Ball Joint Assembly - Front Right Lower
ARM685	301181368500	MERCEDES VITO (W638) 03/1997-07/2003	Suspension Control Arm and Ball Joint Assembly - Front Left Lower
ARM686	301181368600	MERCEDES VIANO (W447) 2014-	Suspension Control Arm and Ball Joint Assembly - Front Right Lower
ARM686	301181368600	MERCEDES VITO (W447) 2014-	Suspension Control Arm and Ball Joint Assembly - Front Right Lower
ARM687	301181368700	MERCEDES VIANO (W447) 2014-	Suspension Control Arm and Ball Joint Assembly - Front Left Lower
ARM687	301181368700	MERCEDES VITO (W447) 2014-	Suspension Control Arm and Ball Joint Assembly - Front Left Lower



			DESCRIPTION
SHORT	LONG		
ARM688	301181368800	MERCEDES ML250 (W166) 07/2011-	Lateral Arm - Rear Forward
ARM688	301181368800	MERCEDES ML350 (W166) 07/2011-	Lateral Arm - Rear Forward
ARM688	301181368800	MERCEDES ML400 (W166) 07/2011-	Lateral Arm - Rear Forward
ARM688	301181368800	MERCEDES ML500 (W166) 07/2011-	Lateral Arm - Rear Forward
ARM688	301181368800	MERCEDES ML550 (W166) 07/2011-	Lateral Arm - Rear Forward
ARM688	301181368800	MERCEDES ML63 AMG (W166) 07/2011-	Lateral Arm - Rear Forward
ARM689	301181368900	MERCEDES GL350 (X166) 07/2011-	Suspension Control Arm and Ball Joint Assembly - Front Right Upper
ARM689	301181368900	MERCEDES GL450 (X166) 07/2011-	Suspension Control Arm and Ball Joint Assembly - Front Right Upper
ARM689	301181368900	MERCEDES GL500 (X166) 07/2011-	Suspension Control Arm and Ball Joint Assembly - Front Right Upper
ARM689	301181368900	MERCEDES GL550 (X166) 07/2011-	Suspension Control Arm and Ball Joint Assembly - Front Right Upper
ARM689	301181368900	MERCEDES GL63 AMG (X166) 07/2011-	Suspension Control Arm and Ball Joint Assembly - Front Right Upper
ARM689	301181368900	MERCEDES ML250 (W166) 07/2011-	Suspension Control Arm and Ball Joint Assembly - Front Right Upper
ARM689	301181368900	MERCEDES ML350 (W166) 07/2011-	Suspension Control Arm and Ball Joint Assembly - Front Right Upper
ARM689	301181368900	MERCEDES ML400 (W166) 07/2011-	Suspension Control Arm and Ball Joint Assembly - Front Right Upper
ARM689	301181368900	MERCEDES ML500 (W166) 07/2011-	Suspension Control Arm and Ball Joint Assembly - Front Right Upper
ARM689	301181368900	MERCEDES ML550 (W166) 07/2011-	Suspension Control Arm and Ball Joint Assembly - Front Right Upper
ARM689	301181368900	MERCEDES ML63 AMG (W166) 07/2011-	Suspension Control Arm and Ball Joint Assembly - Front Right Upper
ARM690	301181369000	MERCEDES GL350 (X166) 07/2011-	Suspension Control Arm and Ball Joint Assembly - Front Left Upper
ARM690	301181369000	MERCEDES GL450 (X166) 07/2011-	Suspension Control Arm and Ball Joint Assembly - Front Left Upper
ARM690	301181369000	MERCEDES GL500 (X166) 07/2011-	Suspension Control Arm and Ball Joint Assembly - Front Left Upper
ARM690	301181369000	MERCEDES GL550 (X166) 07/2011-	Suspension Control Arm and Ball Joint Assembly - Front Left Upper
ARM690	301181369000	MERCEDES GL63 AMG (X166) 07/2011-	Suspension Control Arm and Ball Joint Assembly - Front Left Upper
ARM690	301181369000	MERCEDES ML250 (W166) 07/2011-	Suspension Control Arm and Ball Joint Assembly - Front Left Upper
ARM690	301181369000	MERCEDES ML350 (W166) 07/2011-	Suspension Control Arm and Ball Joint Assembly - Front Left Upper
ARM690	301181369000	MERCEDES ML400 (W166) 07/2011-	Suspension Control Arm and Ball Joint Assembly - Front Left Upper
ARM690	301181369000	MERCEDES ML500 (W166) 07/2011-	Suspension Control Arm and Ball Joint Assembly - Front Left Upper
ARM690	301181369000	MERCEDES ML550 (W166) 07/2011-	Suspension Control Arm and Ball Joint Assembly - Front Left Upper
ARM690	301181369000	MERCEDES ML63 AMG (W166) 07/2011-	Suspension Control Arm and Ball Joint Assembly - Front Left Upper



 SHORT LONG		 	DESCRIPTION
ARM691	301181369100	MERCEDES GL350 (X166) 07/2011-	Suspension Control Arm - Front Right Lower
ARM691	301181369100	MERCEDES GL450 (X166) 07/2011-	Suspension Control Arm - Front Right Lower
ARM691	301181369100	MERCEDES GL500 (X166) 07/2011-	Suspension Control Arm - Front Right Lower
ARM691	301181369100	MERCEDES GL550 (X166) 07/2011-	Suspension Control Arm - Front Right Lower
ARM691	301181369100	MERCEDES GL63 AMG (X166) 07/2011-	Suspension Control Arm - Front Right Lower
ARM691	301181369100	MERCEDES ML250 (W166) 07/2011-	Suspension Control Arm - Front Right Lower
ARM691	301181369100	MERCEDES ML350 (W166) 07/2011-	Suspension Control Arm - Front Right Lower
ARM691	301181369100	MERCEDES ML400 (W166) 07/2011-	Suspension Control Arm - Front Right Lower
ARM691	301181369100	MERCEDES ML500 (W166) 07/2011-	Suspension Control Arm - Front Right Lower
ARM691	301181369100	MERCEDES ML550 (W166) 07/2011-	Suspension Control Arm - Front Right Lower
ARM691	301181369100	MERCEDES ML63 AMG (W166) 07/2011-	Suspension Control Arm - Front Right Lower
ARM692	301181369200	MERCEDES GL350 (X166) 07/2011-	Suspension Control Arm - Front Left Lower
ARM692	301181369200	MERCEDES GL450 (X166) 07/2011-	Suspension Control Arm - Front Left Lower
ARM692	301181369200	MERCEDES GL500 (X166) 07/2011-	Suspension Control Arm - Front Left Lower
ARM692	301181369200	MERCEDES GL550 (X166) 07/2011-	Suspension Control Arm - Front Left Lower
ARM692	301181369200	MERCEDES GL63 AMG (X166) 07/2011-	Suspension Control Arm - Front Left Lower
ARM692	301181369200	MERCEDES ML250 (W166) 07/2011-	Suspension Control Arm - Front Left Lower
ARM692	301181369200	MERCEDES ML350 (W166) 07/2011-	Suspension Control Arm - Front Left Lower
ARM692	301181369200	MERCEDES ML400 (W166) 07/2011-	Suspension Control Arm - Front Left Lower
ARM692	301181369200	MERCEDES ML500 (W166) 07/2011-	Suspension Control Arm - Front Left Lower
ARM692	301181369200	MERCEDES ML550 (W166) 07/2011-	Suspension Control Arm - Front Left Lower
ARM692	301181369200	MERCEDES ML63 AMG (W166) 07/2011-	Suspension Control Arm - Front Left Lower
ARM693	301181369300	MERCEDES GL350 (X166) 07/2011-	Lateral Arm - Rear Right
ARM693	301181369300	MERCEDES GL450 (X166) 07/2011-	Lateral Arm - Rear Right
ARM693	301181369300	MERCEDES GL500 (X166) 07/2011-	Lateral Arm - Rear Right
ARM693	301181369300	MERCEDES GL550 (X166) 07/2011-	Lateral Arm - Rear Right
ARM693	301181369300	MERCEDES GL63 AMG (X166) 07/2011-	Lateral Arm - Rear Right
ARM693	301181369300	MERCEDES ML250 (W166) 07/2011-	Lateral Arm - Rear Right
ARM693	301181369300	MERCEDES ML350 (W166) 07/2011-	Lateral Arm - Rear Right
ARM693	301181369300	MERCEDES ML400 (W166) 07/2011-	Lateral Arm - Rear Right
ARM693	301181369300	MERCEDES ML500 (W166) 07/2011-	Lateral Arm - Rear Right
ARM693	301181369300	MERCEDES ML550 (W166) 07/2011-	Lateral Arm - Rear Right
ARM693	301181369300	MERCEDES ML63 AMG (W166) 07/2011-	Lateral Arm - Rear Right
ARM694	301181369400	MERCEDES GL350 (X166) 07/2011-	Lateral Arm - Rear Left
ARM694	301181369400	MERCEDES GL450 (X166) 07/2011-	Lateral Arm - Rear Left
ARM694	301181369400	MERCEDES GL500 (X166) 07/2011-	Lateral Arm - Rear Left
ARM694	301181369400	MERCEDES GL550 (X166) 07/2011-	Lateral Arm - Rear Left
ARM694	301181369400	MERCEDES GL63 AMG (X166) 07/2011-	Lateral Arm - Rear Left
ARM694	301181369400	MERCEDES ML250 (W166) 07/2011-	Lateral Arm - Rear Left
ARM694	301181369400	MERCEDES ML350 (W166) 07/2011-	Lateral Arm - Rear Left
ARM694	301181369400	MERCEDES ML400 (W166) 07/2011-	Lateral Arm - Rear Left



			DESCRIPTION
SHORT	LONG		
ARM694	301181369400	MERCEDES ML500 (W166) 07/2011-	Lateral Arm - Rear Left
ARM694	301181369400	MERCEDES ML550 (W166) 07/2011-	Lateral Arm - Rear Left
ARM694	301181369400	MERCEDES ML63 AMG (W166) 07/2011-	Lateral Arm - Rear Left
ARM695	301181369500	MERCEDES VIANO (W639) 03/2003-07/2014	Suspension Control Arm and Ball Joint Assembly - Front Right Lower
ARM695	301181369500	MERCEDES VITO (W639) 03/2003-07/2014	Suspension Control Arm and Ball Joint Assembly - Front Right Lower
ARM696	301181369600	MERCEDES VIANO (W639) 03/2003-07/2014	Suspension Control Arm and Ball Joint Assembly - Front Left Lower
ARM696	301181369600	MERCEDES VITO (W639) 03/2003-07/2014	Suspension Control Arm and Ball Joint Assembly - Front Left Lower
ARM697	301181369700	MERCEDES VIANO (W639) 03/2003-07/2014	Suspension Control Arm and Ball Joint Assembly - Front Right Lower
ARM697	301181369700	MERCEDES VITO (W639) 03/2003-07/2014	Suspension Control Arm and Ball Joint Assembly - Front Right Lower
ARM698	301181369800	MERCEDES VIANO (W639) 03/2003-07/2014	Suspension Control Arm and Ball Joint Assembly - Front Left Lower
ARM698	301181369800	MERCEDES VITO (W639) 03/2003-07/2014	Suspension Control Arm and Ball Joint Assembly - Front Left Lower
ARM699	301181369900	MERCEDES Vaneo (W414) 02/2002-07/2005	Suspension Control Arm and Ball Joint Assembly - Front Right Lower
ARM700	301181370000	MERCEDES Vaneo (W414) 02/2002-07/2005	Suspension Control Arm and Ball Joint Assembly - Front Left Lower
ARM701	301181370100	DODGE SPRINTER 2500 W901,W902,W903 01/1995-05/2006	Suspension Control Arm and Ball Joint Assembly - Front Right Lower
ARM701	301181370100	DODGE SPRINTER 3500 W901,W902,W903 01/1995-05/2006	Suspension Control Arm and Ball Joint Assembly - Front Right Lower
ARM701	301181370100	MERCEDES SPRINTER (W901,W902,W903) 01/1995-05/2006	Suspension Control Arm and Ball Joint Assembly - Front Right Lower
ARM701	301181370100	VOLKSWAGEN LT 28-35-46, Typ 2D 04/1996-07/2006	Suspension Control Arm and Ball Joint Assembly - Front Right Lower
ARM702	301181370200	DODGE SPRINTER 2500 W901,W902,W903 01/1995-05/2006	Suspension Control Arm and Ball Joint Assembly - Front Left Lower
ARM702	301181370200	DODGE SPRINTER 3500 W901,W902,W903 01/1995-05/2006	Suspension Control Arm and Ball Joint Assembly - Front Left Lower
ARM702	301181370200	MERCEDES SPRINTER (W901,W902,W903) 01/1995-05/2006	Suspension Control Arm and Ball Joint Assembly - Front Left Lower
ARM702	301181370200	VOLKSWAGEN LT 28-35-46, Typ 2D 04/1996-07/2006	Suspension Control Arm and Ball Joint Assembly - Front Left Lower
ARM703	301181370300	DODGE SPRINTER 2500 W906 06/2006-	Suspension Control Arm and Ball Joint Assembly - Front Right Lower
ARM703	301181370300	DODGE SPRINTER 3500 W906 06/2006-	Suspension Control Arm and Ball Joint Assembly - Front Right Lower
ARM703	301181370300	MERCEDES SPRINTER (W906) 06/2006-	Suspension Control Arm and Ball Joint Assembly - Front Right Lower
ARM703	301181370300	MERCEDES SPRINTER 2500 (W906) 06/2006-	Suspension Control Arm and Ball Joint Assembly - Front Right Lower
ARM703	301181370300	MERCEDES SPRINTER 3500 (W906) 06/2006-	Suspension Control Arm and Ball Joint Assembly - Front Right Lower
ARM703	301181370300	VOLKSWAGEN CRAFTER 04/2006-	Suspension Control Arm and Ball Joint Assembly - Front Right Lower



 SHORT LONG			DESCRIPTION
ARM704	301181370400	DODGE SPRINTER 2500 W906 06/2006-	Suspension Control Arm and Ball Joint Assembly - Front Left Lower
ARM704	301181370400	DODGE SPRINTER 3500 W906 06/2006-	Suspension Control Arm and Ball Joint Assembly - Front Left Lower
ARM704	301181370400	MERCEDES SPRINTER (W906) 06/2006-	Suspension Control Arm and Ball Joint Assembly - Front Left Lower
ARM704	301181370400	MERCEDES SPRINTER 2500 (W906) 06/2006-	Suspension Control Arm and Ball Joint Assembly - Front Left Lower
ARM704	301181370400	MERCEDES SPRINTER 3500 (W906) 06/2006-	Suspension Control Arm and Ball Joint Assembly - Front Left Lower
ARM704	301181370400	VOLKSWAGEN CRAFTER 04/2006-	Suspension Control Arm and Ball Joint Assembly - Front Left Lower
ARM705	301181370500	MERCEDES C200 (W203) 05/2000-02/2007	Suspension Control Arm and Ball Joint Assembly - Front Left Lower
ARM705	301181370500	MERCEDES C230 (W203) 05/2000-02/2007	Suspension Control Arm and Ball Joint Assembly - Front Left Lower
ARM705	301181370500	MERCEDES C240 (W203) 05/2000-02/2007	Suspension Control Arm and Ball Joint Assembly - Front Left Lower
ARM705	301181370500	MERCEDES C280 (W203) 05/2000-02/2007	Suspension Control Arm and Ball Joint Assembly - Front Left Lower
ARM705	301181370500	MERCEDES C32 AMG (W203) 05/2000-02/2007	Suspension Control Arm and Ball Joint Assembly - Front Left Lower
ARM705	301181370500	MERCEDES C320 (W203) 05/2000-02/2007	Suspension Control Arm and Ball Joint Assembly - Front Left Lower
ARM705	301181370500	MERCEDES C350 (W203) 05/2000-02/2007	Suspension Control Arm and Ball Joint Assembly - Front Left Lower
ARM705	301181370500	MERCEDES C55 AMG (W203) 05/2000-02/2007	Suspension Control Arm and Ball Joint Assembly - Front Left Lower
ARM705	301181370500	MERCEDES CLK280 (A209-C209) 06/2002-05/2009	Suspension Control Arm and Ball Joint Assembly - Front Left Lower
ARM705	301181370500	MERCEDES CLK320 (A209-C209) 06/2002-05/2009	Suspension Control Arm and Ball Joint Assembly - Front Left Lower
ARM705	301181370500	MERCEDES CLK350 (A209-C209) 06/2002-05/2009	Suspension Control Arm and Ball Joint Assembly - Front Left Lower
ARM705	301181370500	MERCEDES CLK430 (A209-C209) 06/2002-05/2009	Suspension Control Arm and Ball Joint Assembly - Front Left Lower
ARM705	301181370500	MERCEDES CLK500 (A209-C209) 06/2002-05/2009	Suspension Control Arm and Ball Joint Assembly - Front Left Lower
ARM705	301181370500	MERCEDES CLK55 AMG (A209-C209) 06/2002-05/2009	Suspension Control Arm and Ball Joint Assembly - Front Left Lower
ARM705	301181370500	MERCEDES CLK550 (A209-C209) 06/2002-05/2009	Suspension Control Arm and Ball Joint Assembly - Front Left Lower
ARM705	301181370500	MERCEDES CLK63 AMG (A209-C209) 06/2002-05/2009	Suspension Control Arm and Ball Joint Assembly - Front Left Lower
ARM705	301181370500	MERCEDES SLK200 (R171) 03/2004-02/2011	Suspension Control Arm and Ball Joint Assembly - Front Left Lower
ARM705	301181370500	MERCEDES SLK280 (R171) 03/2004-02/2011	Suspension Control Arm and Ball Joint Assembly - Front Left Lower
ARM705	301181370500	MERCEDES SLK300 (R171) 03/2004-02/2011	Suspension Control Arm and Ball Joint Assembly - Front Left Lower



			DESCRIPTION
SHORT	LONG		
ARM705	301181370500	MERCEDES SLK350 (R171) 03/2004-02/2011	Suspension Control Arm and Ball Joint Assembly - Front Left Lower
ARM705	301181370500	MERCEDES SLK55 AMG (R171) 03/2004-02/2011	Suspension Control Arm and Ball Joint Assembly - Front Left Lower
ARM706	301181370600	MERCEDES C200 (W203) 05/2000-02/2007	Suspension Control Arm and Ball Joint Assembly - Front Right Lower
ARM706	301181370600	MERCEDES C230 (W203) 05/2000-02/2007	Suspension Control Arm and Ball Joint Assembly - Front Right Lower
ARM706	301181370600	MERCEDES C240 (W203) 05/2000-02/2007	Suspension Control Arm and Ball Joint Assembly - Front Right Lower
ARM706	301181370600	MERCEDES C280 (W203) 05/2000-02/2007	Suspension Control Arm and Ball Joint Assembly - Front Right Lower
ARM706	301181370600	MERCEDES C32 AMG (W203) 05/2000-02/2007	Suspension Control Arm and Ball Joint Assembly - Front Right Lower
ARM706	301181370600	MERCEDES C320 (W203) 05/2000-02/2007	Suspension Control Arm and Ball Joint Assembly - Front Right Lower
ARM706	301181370600	MERCEDES C350 (W203) 05/2000-02/2007	Suspension Control Arm and Ball Joint Assembly - Front Right Lower
ARM706	301181370600	MERCEDES C55 AMG (W203) 05/2000-02/2007	Suspension Control Arm and Ball Joint Assembly - Front Right Lower
ARM706	301181370600	MERCEDES CLK280 (A209-C209) 06/2002-05/2009	Suspension Control Arm and Ball Joint Assembly - Front Right Lower
ARM706	301181370600	MERCEDES CLK320 (A209-C209) 06/2002-05/2009	Suspension Control Arm and Ball Joint Assembly - Front Right Lower
ARM706	301181370600	MERCEDES CLK350 (A209-C209) 06/2002-05/2009	Suspension Control Arm and Ball Joint Assembly - Front Right Lower
ARM706	301181370600	MERCEDES CLK430 (A209-C209) 06/2002-05/2009	Suspension Control Arm and Ball Joint Assembly - Front Right Lower
ARM706	301181370600	MERCEDES CLK500 (A209-C209) 06/2002-05/2009	Suspension Control Arm and Ball Joint Assembly - Front Right Lower
ARM706	301181370600	MERCEDES CLK55 AMG (A209-C209) 06/2002-05/2009	Suspension Control Arm and Ball Joint Assembly - Front Right Lower
ARM706	301181370600	MERCEDES CLK550 (A209-C209) 06/2002-05/2009	Suspension Control Arm and Ball Joint Assembly - Front Right Lower
ARM706	301181370600	MERCEDES CLK63 AMG (A209-C209) 06/2002-05/2009	Suspension Control Arm and Ball Joint Assembly - Front Right Lower
ARM706	301181370600	MERCEDES SLK200 (R171) 03/2004-02/2011	Suspension Control Arm and Ball Joint Assembly - Front Right Lower
ARM706	301181370600	MERCEDES SLK280 (R171) 03/2004-02/2011	Suspension Control Arm and Ball Joint Assembly - Front Right Lower
ARM706	301181370600	MERCEDES SLK300 (R171) 03/2004-02/2011	Suspension Control Arm and Ball Joint Assembly - Front Right Lower
ARM706	301181370600	MERCEDES SLK350 (R171) 03/2004-02/2011	Suspension Control Arm and Ball Joint Assembly - Front Right Lower
ARM706	301181370600	MERCEDES SLK55 AMG (R171) 03/2004-02/2011	Suspension Control Arm and Ball Joint Assembly - Front Right Lower
ARM707	301181370700	MERCEDES C180 (W204) 10/2007-11/2013	Suspension Control Arm and Ball Joint Assembly - Front Right Upper
ARM707	301181370700	MERCEDES C200 (W203) 05/2000-02/2007	Suspension Control Arm and Ball Joint Assembly - Front Right Upper





 SHORT LONG			DESCRIPTION
ARM707	301181370700	MERCEDES C200 (W204) 10/2007-11/2013	Suspension Control Arm and Ball Joint Assembly - Front Right Upper
ARM707	301181370700	MERCEDES C230 (W203) 05/2000-02/2007	Suspension Control Arm and Ball Joint Assembly - Front Right Upper
ARM707	301181370700	MERCEDES C230 (W204) 10/2007-11/2013	Suspension Control Arm and Ball Joint Assembly - Front Right Upper
ARM707	301181370700	MERCEDES C240 (W203) 05/2000-02/2007	Suspension Control Arm and Ball Joint Assembly - Front Right Upper
ARM707	301181370700	MERCEDES C250 (W204) 10/2007-11/2013	Suspension Control Arm and Ball Joint Assembly - Front Right Upper
ARM707	301181370700	MERCEDES C280 (W203) 05/2000-02/2007	Suspension Control Arm and Ball Joint Assembly - Front Right Upper
ARM707	301181370700	MERCEDES C280 (W204) 10/2007-11/2013	Suspension Control Arm and Ball Joint Assembly - Front Right Upper
ARM707	301181370700	MERCEDES C300 (W204) 10/2007-11/2013	Suspension Control Arm and Ball Joint Assembly - Front Right Upper
ARM707	301181370700	MERCEDES C32 AMG (W203) 05/2000-02/2007	Suspension Control Arm and Ball Joint Assembly - Front Right Upper
ARM707	301181370700	MERCEDES C320 (W203) 05/2000-02/2007	Suspension Control Arm and Ball Joint Assembly - Front Right Upper
ARM707	301181370700	MERCEDES C350 (W203) 05/2000-02/2007	Suspension Control Arm and Ball Joint Assembly - Front Right Upper
ARM707	301181370700	MERCEDES C350 (W204) 10/2007-11/2013	Suspension Control Arm and Ball Joint Assembly - Front Right Upper
ARM707	301181370700	MERCEDES C55 AMG (W203) 05/2000-02/2007	Suspension Control Arm and Ball Joint Assembly - Front Right Upper
ARM707	301181370700	MERCEDES C63 AMG (W204) 10/2007-11/2013	Suspension Control Arm and Ball Joint Assembly - Front Right Upper
ARM707	301181370700	MERCEDES CLK280 (A209-C209) 06/2002-05/2009	Suspension Control Arm and Ball Joint Assembly - Front Right Upper
ARM707	301181370700	MERCEDES CLK320 (A209-C209) 06/2002-05/2009	Suspension Control Arm and Ball Joint Assembly - Front Right Upper
ARM707	301181370700	MERCEDES CLK350 (A209-C209) 06/2002-05/2009	Suspension Control Arm and Ball Joint Assembly - Front Right Upper
ARM707	301181370700	MERCEDES CLK430 (A209-C209) 06/2002-05/2009	Suspension Control Arm and Ball Joint Assembly - Front Right Upper
ARM707	301181370700	MERCEDES CLK500 (A209-C209) 06/2002-05/2009	Suspension Control Arm and Ball Joint Assembly - Front Right Upper
ARM707	301181370700	MERCEDES CLK55 AMG (A209-C209) 06/2002-05/2009	Suspension Control Arm and Ball Joint Assembly - Front Right Upper
ARM707	301181370700	MERCEDES CLK550 (A209-C209) 06/2002-05/2009	Suspension Control Arm and Ball Joint Assembly - Front Right Upper
ARM707	301181370700	MERCEDES CLK63 AMG (A209-C209) 06/2002-05/2009	Suspension Control Arm and Ball Joint Assembly - Front Right Upper
ARM707	301181370700	MERCEDES SLK200 (R171) 03/2004-02/2011	Suspension Control Arm and Ball Joint Assembly - Front Right Upper
ARM707	301181370700	MERCEDES SLK280 (R171) 03/2004-02/2011	Suspension Control Arm and Ball Joint Assembly - Front Right Upper
ARM707	301181370700	MERCEDES SLK300 (R171) 03/2004-02/2011	Suspension Control Arm and Ball Joint Assembly - Front Right Upper



			DESCRIPTION
SHORT	LONG		
ARM707	301181370700	MERCEDES SLK350 (R171) 03/2004-02/2011	Suspension Control Arm and Ball Joint Assembly - Front Right Upper
ARM707	301181370700	MERCEDES SLK55 AMG (R171) 03/2004-02/2011	Suspension Control Arm and Ball Joint Assembly - Front Right Upper
ARM708	301181370800	MERCEDES C180 (W204) 10/2007-11/2013	Suspension Control Arm and Ball Joint Assembly - Front Left Upper
ARM708	301181370800	MERCEDES C200 (W203) 05/2000-02/2007	Suspension Control Arm and Ball Joint Assembly - Front Left Upper
ARM708	301181370800	MERCEDES C200 (W204) 10/2007-11/2013	Suspension Control Arm and Ball Joint Assembly - Front Left Upper
ARM708	301181370800	MERCEDES C230 (W203) 05/2000-02/2007	Suspension Control Arm and Ball Joint Assembly - Front Left Upper
ARM708	301181370800	MERCEDES C230 (W204) 10/2007-11/2013	Suspension Control Arm and Ball Joint Assembly - Front Left Upper
ARM708	301181370800	MERCEDES C240 (W203) 05/2000-02/2007	Suspension Control Arm and Ball Joint Assembly - Front Left Upper
ARM708	301181370800	MERCEDES C250 (W204) 10/2007-11/2013	Suspension Control Arm and Ball Joint Assembly - Front Left Upper
ARM708	301181370800	MERCEDES C280 (W203) 05/2000-02/2007	Suspension Control Arm and Ball Joint Assembly - Front Left Upper
ARM708	301181370800	MERCEDES C280 (W204) 10/2007-11/2013	Suspension Control Arm and Ball Joint Assembly - Front Left Upper
ARM708	301181370800	MERCEDES C300 (W204) 10/2007-11/2013	Suspension Control Arm and Ball Joint Assembly - Front Left Upper
ARM708	301181370800	MERCEDES C32 AMG (W203) 05/2000-02/2007	Suspension Control Arm and Ball Joint Assembly - Front Left Upper
ARM708	301181370800	MERCEDES C320 (W203) 05/2000-02/2007	Suspension Control Arm and Ball Joint Assembly - Front Left Upper
ARM708	301181370800	MERCEDES C350 (W203) 05/2000-02/2007	Suspension Control Arm and Ball Joint Assembly - Front Left Upper
ARM708	301181370800	MERCEDES C350 (W204) 10/2007-11/2013	Suspension Control Arm and Ball Joint Assembly - Front Left Upper
ARM708	301181370800	MERCEDES C55 AMG (W203) 05/2000-02/2007	Suspension Control Arm and Ball Joint Assembly - Front Left Upper
ARM708	301181370800	MERCEDES C63 AMG (W204) 10/2007-11/2013	Suspension Control Arm and Ball Joint Assembly - Front Left Upper
ARM708	301181370800	MERCEDES CLK280 (A209-C209) 06/2002-05/2009	Suspension Control Arm and Ball Joint Assembly - Front Left Upper
ARM708	301181370800	MERCEDES CLK320 (A209-C209) 06/2002-05/2009	Suspension Control Arm and Ball Joint Assembly - Front Left Upper
ARM708	301181370800	MERCEDES CLK350 (A209-C209) 06/2002-05/2009	Suspension Control Arm and Ball Joint Assembly - Front Left Upper
ARM708	301181370800	MERCEDES CLK430 (A209-C209) 06/2002-05/2009	Suspension Control Arm and Ball Joint Assembly - Front Left Upper
ARM708	301181370800	MERCEDES CLK500 (A209-C209) 06/2002-05/2009	Suspension Control Arm and Ball Joint Assembly - Front Left Upper
ARM708	301181370800	MERCEDES CLK55 AMG (A209-C209) 06/2002-05/2009	Suspension Control Arm and Ball Joint Assembly - Front Left Upper
ARM708	301181370800	MERCEDES CLK550 (A209-C209) 06/2002-05/2009	Suspension Control Arm and Ball Joint Assembly - Front Left Upper





 SHORT LONG			DESCRIPTION
ARM708	301181370800	MERCEDES CLK63 AMG (A209-C209) 06/2002-05/2009	Suspension Control Arm and Ball Joint Assembly - Front Left Upper
ARM708	301181370800	MERCEDES SLK200 (R171) 03/2004-02/2011	Suspension Control Arm and Ball Joint Assembly - Front Left Upper
ARM708	301181370800	MERCEDES SLK280 (R171) 03/2004-02/2011	Suspension Control Arm and Ball Joint Assembly - Front Left Upper
ARM708	301181370800	MERCEDES SLK300 (R171) 03/2004-02/2011	Suspension Control Arm and Ball Joint Assembly - Front Left Upper
ARM708	301181370800	MERCEDES SLK350 (R171) 03/2004-02/2011	Suspension Control Arm and Ball Joint Assembly - Front Left Upper
ARM708	301181370800	MERCEDES SLK55 AMG (R171) 03/2004-02/2011	Suspension Control Arm and Ball Joint Assembly - Front Left Upper
ARM709	301181370900	MERCEDES C180 (W204) 10/2007-11/2013	Suspension Control Arm and Ball Joint Assembly - Front Right Lower Rearward
ARM709	301181370900	MERCEDES C200 (W204) 10/2007-11/2013	Suspension Control Arm and Ball Joint Assembly - Front Right Lower Rearward
ARM709	301181370900	MERCEDES C230 (W204) 10/2007-11/2013	Suspension Control Arm and Ball Joint Assembly - Front Right Lower Rearward
ARM709	301181370900	MERCEDES C250 (W204) 10/2007-11/2013	Suspension Control Arm and Ball Joint Assembly - Front Right Lower Rearward
ARM709	301181370900	MERCEDES C280 (W204) 10/2007-11/2013	Suspension Control Arm and Ball Joint Assembly - Front Right Lower Rearward
ARM709	301181370900	MERCEDES C300 (W204) 10/2007-11/2013	Suspension Control Arm and Ball Joint Assembly - Front Right Lower Rearward
ARM709	301181370900	MERCEDES C350 (W204) 10/2007-11/2013	Suspension Control Arm and Ball Joint Assembly - Front Right Lower Rearward
ARM709	301181370900	MERCEDES C63 AMG (W204) 10/2007-11/2013	Suspension Control Arm and Ball Joint Assembly - Front Right Lower Rearward
ARM710	301181371000	MERCEDES C180 (W204) 10/2007-11/2013	Suspension Control Arm and Ball Joint Assembly - Front Left Lower Rearward
ARM710	301181371000	MERCEDES C200 (W204) 10/2007-11/2013	Suspension Control Arm and Ball Joint Assembly - Front Left Lower Rearward
ARM710	301181371000	MERCEDES C230 (W204) 10/2007-11/2013	Suspension Control Arm and Ball Joint Assembly - Front Left Lower Rearward
ARM710	301181371000	MERCEDES C250 (W204) 10/2007-11/2013	Suspension Control Arm and Ball Joint Assembly - Front Left Lower Rearward
ARM710	301181371000	MERCEDES C280 (W204) 10/2007-11/2013	Suspension Control Arm and Ball Joint Assembly - Front Left Lower Rearward
ARM710	301181371000	MERCEDES C300 (W204) 10/2007-11/2013	Suspension Control Arm and Ball Joint Assembly - Front Left Lower Rearward
ARM710	301181371000	MERCEDES C350 (W204) 10/2007-11/2013	Suspension Control Arm and Ball Joint Assembly - Front Left Lower Rearward
ARM710	301181371000	MERCEDES C63 AMG (W204) 10/2007-11/2013	Suspension Control Arm and Ball Joint Assembly - Front Left Lower Rearward
ARM711	301181371100	MERCEDES C180 (W204) 10/2007-11/2013	Lateral Arm - Rear Right Upper
ARM711	301181371100	MERCEDES C200 (W204) 10/2007-11/2013	Lateral Arm - Rear Right Upper
ARM711	301181371100	MERCEDES C230 (W204) 10/2007-11/2013	Lateral Arm - Rear Right Upper
ARM711	301181371100	MERCEDES C250 (W204) 10/2007-11/2013	Lateral Arm - Rear Right Upper
ARM711	301181371100	MERCEDES C280 (W204) 10/2007-11/2013	Lateral Arm - Rear Right Upper
ARM711	301181371100	MERCEDES C300 (W204) 10/2007-11/2013	Lateral Arm - Rear Right Upper



			DESCRIPTION
SHORT	LONG		
ARM711	301181371100	MERCEDES C350 (W204) 10/2007-11/2013	Lateral Arm - Rear Right Upper
ARM711	301181371100	MERCEDES C63 AMG (W204) 10/2007-11/2013	Lateral Arm - Rear Right Upper
ARM711	301181371100	MERCEDES E200 (W212) 01/2009-2016	Lateral Arm - Rear Right Upper
ARM711	301181371100	MERCEDES E250 (W212) 01/2009-2016	Lateral Arm - Rear Right Upper
ARM711	301181371100	MERCEDES E280 (W212) 01/2009-2016	Lateral Arm - Rear Right Upper
ARM711	301181371100	MERCEDES E300 (W212) 01/2009-2016	Lateral Arm - Rear Right Upper
ARM711	301181371100	MERCEDES E320 (W212) 01/2009-2016	Lateral Arm - Rear Right Upper
ARM711	301181371100	MERCEDES E400 (W212) 01/2009-2016	Lateral Arm - Rear Right Upper
ARM711	301181371100	MERCEDES E500 (W212) 01/2009-2016	Lateral Arm - Rear Right Upper
ARM711	301181371100	MERCEDES E550 (W212) 01/2009-2016	Lateral Arm - Rear Right Upper
ARM711	301181371100	MERCEDES E63 AMG (W212) 01/2009-2016	Lateral Arm - Rear Right Upper
ARM711	301181371100	MERCEDES GLK250 (X204) 06/2008-2016	Lateral Arm - Rear Right Upper
ARM711	301181371100	MERCEDES GLK280 (X204) 06/2008-2016	Lateral Arm - Rear Right Upper
ARM711	301181371100	MERCEDES GLK300 (X204) 06/2008-2016	Lateral Arm - Rear Right Upper
ARM711	301181371100	MERCEDES GLK350 (X204) 06/2008-2016	Lateral Arm - Rear Right Upper
ARM712	301181371200	MERCEDES C180 (W204) 10/2007-11/2013	Lateral Arm - Rear Left Upper
ARM712	301181371200	MERCEDES C200 (W204) 10/2007-11/2013	Lateral Arm - Rear Left Upper
ARM712	301181371200	MERCEDES C230 (W204) 10/2007-11/2013	Lateral Arm - Rear Left Upper
ARM712	301181371200	MERCEDES C250 (W204) 10/2007-11/2013	Lateral Arm - Rear Left Upper
ARM712	301181371200	MERCEDES C280 (W204) 10/2007-11/2013	Lateral Arm - Rear Left Upper
ARM712	301181371200	MERCEDES C300 (W204) 10/2007-11/2013	Lateral Arm - Rear Left Upper
ARM712	301181371200	MERCEDES C350 (W204) 10/2007-11/2013	Lateral Arm - Rear Left Upper
ARM712	301181371200	MERCEDES C63 AMG (W204) 10/2007-11/2013	Lateral Arm - Rear Left Upper
ARM712	301181371200	MERCEDES E200 (W212) 01/2009-2016	Lateral Arm - Rear Left Upper
ARM712	301181371200	MERCEDES E250 (W212) 01/2009-2016	Lateral Arm - Rear Left Upper
ARM712	301181371200	MERCEDES E280 (W212) 01/2009-2016	Lateral Arm - Rear Left Upper
ARM712	301181371200	MERCEDES E300 (W212) 01/2009-2016	Lateral Arm - Rear Left Upper
ARM712	301181371200	MERCEDES E320 (W212) 01/2009-2016	Lateral Arm - Rear Left Upper
ARM712	301181371200	MERCEDES E400 (W212) 01/2009-2016	Lateral Arm - Rear Left Upper
ARM712	301181371200	MERCEDES E500 (W212) 01/2009-2016	Lateral Arm - Rear Left Upper
ARM712	301181371200	MERCEDES E550 (W212) 01/2009-2016	Lateral Arm - Rear Left Upper
ARM712	301181371200	MERCEDES E63 AMG (W212) 01/2009-2016	Lateral Arm - Rear Left Upper
ARM712	301181371200	MERCEDES GLK250 (X204) 06/2008-2016	Lateral Arm - Rear Left Upper
ARM712	301181371200	MERCEDES GLK280 (X204) 06/2008-2016	Lateral Arm - Rear Left Upper
ARM712	301181371200	MERCEDES GLK300 (X204) 06/2008-2016	Lateral Arm - Rear Left Upper
ARM712	301181371200	MERCEDES GLK350 (X204) 06/2008-2016	Lateral Arm - Rear Left Upper
ARM713	301181371300	MERCEDES C180 (W204) 10/2007-11/2013	Lateral Arm - Rear Right
ARM713	301181371300	MERCEDES C180 (W205) RWD 12/2013-	Lateral Arm - Rear Right
ARM713	301181371300	MERCEDES C200 (W204) 10/2007-11/2013	Lateral Arm - Rear Right





			DESCRIPTION
SHORT	LONG		
ARM713	301181371300	MERCEDES C200 (W205) RWD 12/2013-	Lateral Arm - Rear Right
ARM713	301181371300	MERCEDES C230 (W204) 10/2007-11/2013	Lateral Arm - Rear Right
ARM713	301181371300	MERCEDES C250 (W204) 10/2007-11/2013	Lateral Arm - Rear Right
ARM713	301181371300	MERCEDES C250 (W205) RWD 12/2013-	Lateral Arm - Rear Right
ARM713	301181371300	MERCEDES C280 (W204) 10/2007-11/2013	Lateral Arm - Rear Right
ARM713	301181371300	MERCEDES C300 (W204) 10/2007-11/2013	Lateral Arm - Rear Right
ARM713	301181371300	MERCEDES C300 (W205) AWD 12/2013-	Lateral Arm - Rear Right
ARM713	301181371300	MERCEDES C300 (W205) RWD 12/2013-	Lateral Arm - Rear Right
ARM713	301181371300	MERCEDES C350 (W204) 10/2007-11/2013	Lateral Arm - Rear Right
ARM713	301181371300	MERCEDES C350 (W205) AWD 12/2013-	Lateral Arm - Rear Right
ARM713	301181371300	MERCEDES C350 (W205) RWD 12/2013-	Lateral Arm - Rear Right
ARM713	301181371300	MERCEDES C400 (W205) AWD 12/2013-	Lateral Arm - Rear Right
ARM713	301181371300	MERCEDES C450 AMG (W205) AWD 12/2013-	Lateral Arm - Rear Right
ARM713	301181371300	MERCEDES C63 AMG (W204) 10/2007-11/2013	Lateral Arm - Rear Right
ARM713	301181371300	MERCEDES C63 AMG (W205) RWD 12/2013-	Lateral Arm - Rear Right
ARM713	301181371300	MERCEDES C63 AMG S (W205) RWD 12/2013-	Lateral Arm - Rear Right
ARM713	301181371300	MERCEDES GLK250 (X204) 06/2008-2016	Lateral Arm - Rear Right
ARM713	301181371300	MERCEDES GLK280 (X204) 06/2008-2016	Lateral Arm - Rear Right
ARM713	301181371300	MERCEDES GLK300 (X204) 06/2008-2016	Lateral Arm - Rear Right
ARM713	301181371300	MERCEDES GLK350 (X204) 06/2008-2016	Lateral Arm - Rear Right
ARM714	301181371400	MERCEDES C180 (W204) 10/2007-11/2013	Lateral Arm - Rear Left
ARM714	301181371400	MERCEDES C180 (W205) RWD 12/2013-	Lateral Arm - Rear Left
ARM714	301181371400	MERCEDES C200 (W204) 10/2007-11/2013	Lateral Arm - Rear Left
ARM714	301181371400	MERCEDES C200 (W205) RWD 12/2013-	Lateral Arm - Rear Left
ARM714	301181371400	MERCEDES C230 (W204) 10/2007-11/2013	Lateral Arm - Rear Left
ARM714	301181371400	MERCEDES C250 (W204) 10/2007-11/2013	Lateral Arm - Rear Left
ARM714	301181371400	MERCEDES C250 (W205) RWD 12/2013-	Lateral Arm - Rear Left
ARM714	301181371400	MERCEDES C280 (W204) 10/2007-11/2013	Lateral Arm - Rear Left
ARM714	301181371400	MERCEDES C300 (W204) 10/2007-11/2013	Lateral Arm - Rear Left
ARM714	301181371400	MERCEDES C300 (W205) AWD 12/2013-	Lateral Arm - Rear Left
ARM714	301181371400	MERCEDES C300 (W205) RWD 12/2013-	Lateral Arm - Rear Left
ARM714	301181371400	MERCEDES C350 (W204) 10/2007-11/2013	Lateral Arm - Rear Left
ARM714	301181371400	MERCEDES C350 (W205) AWD 12/2013-	Lateral Arm - Rear Left
ARM714	301181371400	MERCEDES C350 (W205) RWD 12/2013-	Lateral Arm - Rear Left
ARM714	301181371400	MERCEDES C400 (W205) AWD 12/2013-	Lateral Arm - Rear Left
ARM714	301181371400	MERCEDES C450 AMG (W205) AWD 12/2013-	Lateral Arm - Rear Left
ARM714	301181371400	MERCEDES C63 AMG (W204) 10/2007-11/2013	Lateral Arm - Rear Left
ARM714	301181371400	MERCEDES C63 AMG (W205) RWD 12/2013-	Lateral Arm - Rear Left



 SHORT LONG			DESCRIPTION
ARM714	301181371400	MERCEDES C63 AMG S (W205) RWD 12/2013-	Lateral Arm - Rear Left
ARM714	301181371400	MERCEDES GLK250 (X204) 06/2008-2016	Lateral Arm - Rear Left
ARM714	301181371400	MERCEDES GLK280 (X204) 06/2008-2016	Lateral Arm - Rear Left
ARM714	301181371400	MERCEDES GLK300 (X204) 06/2008-2016	Lateral Arm - Rear Left
ARM714	301181371400	MERCEDES GLK350 (X204) 06/2008-2016	Lateral Arm - Rear Left
ARM715	301181371500	MERCEDES C180 (W204) 10/2007-11/2013	Lateral Arm - Rear Right Lower
ARM715	301181371500	MERCEDES C200 (W204) 10/2007-11/2013	Lateral Arm - Rear Right Lower
ARM715	301181371500	MERCEDES C230 (W204) 10/2007-11/2013	Lateral Arm - Rear Right Lower
ARM715	301181371500	MERCEDES C250 (W204) 10/2007-11/2013	Lateral Arm - Rear Right Lower
ARM715	301181371500	MERCEDES C280 (W204) 10/2007-11/2013	Lateral Arm - Rear Right Lower
ARM715	301181371500	MERCEDES C300 (W204) 10/2007-11/2013	Lateral Arm - Rear Right Lower
ARM715	301181371500	MERCEDES C350 (W204) 10/2007-11/2013	Lateral Arm - Rear Right Lower
ARM715	301181371500	MERCEDES C63 AMG (W204) 10/2007-11/2013	Lateral Arm - Rear Right Lower
ARM715	301181371500	MERCEDES E200 (W212) 01/2009-2016	Lateral Arm - Rear Right Lower
ARM715	301181371500	MERCEDES E250 (W212) 01/2009-2016	Lateral Arm - Rear Right Lower
ARM715	301181371500	MERCEDES E280 (W212) 01/2009-2016	Lateral Arm - Rear Right Lower
ARM715	301181371500	MERCEDES E300 (W212) 01/2009-2016	Lateral Arm - Rear Right Lower
ARM715	301181371500	MERCEDES E320 (W212) 01/2009-2016	Lateral Arm - Rear Right Lower
ARM715	301181371500	MERCEDES E400 (W212) 01/2009-2016	Lateral Arm - Rear Right Lower
ARM715	301181371500	MERCEDES E500 (W212) 01/2009-2016	Lateral Arm - Rear Right Lower
ARM715	301181371500	MERCEDES E550 (W212) 01/2009-2016	Lateral Arm - Rear Right Lower
ARM715	301181371500	MERCEDES E63 AMG (W212) 01/2009-2016	Lateral Arm - Rear Right Lower
ARM716	301181371600	MERCEDES C180 (W204) 10/2007-11/2013	Lateral Arm - Rear Left Lower
ARM716	301181371600	MERCEDES C200 (W204) 10/2007-11/2013	Lateral Arm - Rear Left Lower
ARM716	301181371600	MERCEDES C230 (W204) 10/2007-11/2013	Lateral Arm - Rear Left Lower
ARM716	301181371600	MERCEDES C250 (W204) 10/2007-11/2013	Lateral Arm - Rear Left Lower
ARM716	301181371600	MERCEDES C280 (W204) 10/2007-11/2013	Lateral Arm - Rear Left Lower
ARM716	301181371600	MERCEDES C300 (W204) 10/2007-11/2013	Lateral Arm - Rear Left Lower
ARM716	301181371600	MERCEDES C350 (W204) 10/2007-11/2013	Lateral Arm - Rear Left Lower
ARM716	301181371600	MERCEDES C63 AMG (W204) 10/2007-11/2013	Lateral Arm - Rear Left Lower
ARM716	301181371600	MERCEDES E200 (W212) 01/2009-2016	Lateral Arm - Rear Left Lower
ARM716	301181371600	MERCEDES E250 (W212) 01/2009-2016	Lateral Arm - Rear Left Lower
ARM716	301181371600	MERCEDES E280 (W212) 01/2009-2016	Lateral Arm - Rear Left Lower
ARM716	301181371600	MERCEDES E300 (W212) 01/2009-2016	Lateral Arm - Rear Left Lower
ARM716	301181371600	MERCEDES E320 (W212) 01/2009-2016	Lateral Arm - Rear Left Lower
ARM716	301181371600	MERCEDES E400 (W212) 01/2009-2016	Lateral Arm - Rear Left Lower
ARM716	301181371600	MERCEDES E500 (W212) 01/2009-2016	Lateral Arm - Rear Left Lower
ARM716	301181371600	MERCEDES E550 (W212) 01/2009-2016	Lateral Arm - Rear Left Lower
ARM716	301181371600	MERCEDES E63 AMG (W212) 01/2009-2016	Lateral Arm - Rear Left Lower





 SHORT LONG			DESCRIPTION
ARM717	301181371700	MERCEDES C180 (W204) 10/2007-11/2013	Lateral Arm - Rear Lower
ARM717	301181371700	MERCEDES C180 (W205) RWD 12/2013-	Lateral Arm - Rear Lower
ARM717	301181371700	MERCEDES C200 (W204) 10/2007-11/2013	Lateral Arm - Rear Lower
ARM717	301181371700	MERCEDES C200 (W205) RWD 12/2013-	Lateral Arm - Rear Lower
ARM717	301181371700	MERCEDES C230 (W204) 10/2007-11/2013	Lateral Arm - Rear Lower
ARM717	301181371700	MERCEDES C250 (W204) 10/2007-11/2013	Lateral Arm - Rear Lower
ARM717	301181371700	MERCEDES C250 (W205) RWD 12/2013-	Lateral Arm - Rear Lower
ARM717	301181371700	MERCEDES C280 (W204) 10/2007-11/2013	Lateral Arm - Rear Lower
ARM717	301181371700	MERCEDES C300 (W204) 10/2007-11/2013	Lateral Arm - Rear Lower
ARM717	301181371700	MERCEDES C300 (W205) AWD 12/2013-	Lateral Arm - Rear Lower
ARM717	301181371700	MERCEDES C300 (W205) RWD 12/2013-	Lateral Arm - Rear Lower
ARM717	301181371700	MERCEDES C350 (W204) 10/2007-11/2013	Lateral Arm - Rear Lower
ARM717	301181371700	MERCEDES C350 (W205) AWD 12/2013-	Lateral Arm - Rear Lower
ARM717	301181371700	MERCEDES C350 (W205) RWD 12/2013-	Lateral Arm - Rear Lower
ARM717	301181371700	MERCEDES C400 (W205) AWD 12/2013-	Lateral Arm - Rear Lower
ARM717	301181371700	MERCEDES C450 AMG (W205) AWD 12/2013-	Lateral Arm - Rear Lower
ARM717	301181371700	MERCEDES C63 AMG (W204) 10/2007-11/2013	Lateral Arm - Rear Lower
ARM717	301181371700	MERCEDES C63 AMG (W205) RWD 12/2013-	Lateral Arm - Rear Lower
ARM717	301181371700	MERCEDES C63 AMG S (W205) RWD 12/2013-	Lateral Arm - Rear Lower
ARM717	301181371700	MERCEDES E200 (W212) 01/2009-2016	Lateral Arm - Rear Lower
ARM717	301181371700	MERCEDES E250 (W212) 01/2009-2016	Lateral Arm - Rear Lower
ARM717	301181371700	MERCEDES E280 (W212) 01/2009-2016	Lateral Arm - Rear Lower
ARM717	301181371700	MERCEDES E300 (W212) 01/2009-2016	Lateral Arm - Rear Lower
ARM717	301181371700	MERCEDES E320 (W212) 01/2009-2016	Lateral Arm - Rear Lower
ARM717	301181371700	MERCEDES E400 (W212) 01/2009-2016	Lateral Arm - Rear Lower
ARM717	301181371700	MERCEDES E500 (W212) 01/2009-2016	Lateral Arm - Rear Lower
ARM717	301181371700	MERCEDES E550 (W212) 01/2009-2016	Lateral Arm - Rear Lower
ARM717	301181371700	MERCEDES E63 AMG (W212) 01/2009-2016	Lateral Arm - Rear Lower
ARM718	301181371800	MERCEDES C180 (W204) 10/2007-11/2013	Suspension Control Arm and Ball Joint Assembly - Front Right Upper
ARM718	301181371800	MERCEDES C200 (W204) 10/2007-11/2013	Suspension Control Arm and Ball Joint Assembly - Front Right Upper
ARM718	301181371800	MERCEDES C230 (W204) 10/2007-11/2013	Suspension Control Arm and Ball Joint Assembly - Front Right Upper
ARM718	301181371800	MERCEDES C250 (W204) 10/2007-11/2013	Suspension Control Arm and Ball Joint Assembly - Front Right Upper
ARM718	301181371800	MERCEDES C280 (W204) 10/2007-11/2013	Suspension Control Arm and Ball Joint Assembly - Front Right Upper
ARM718	301181371800	MERCEDES C300 (W204) 10/2007-11/2013	Suspension Control Arm and Ball Joint Assembly - Front Right Upper
ARM718	301181371800	MERCEDES C350 (W204) 10/2007-11/2013	Suspension Control Arm and Ball Joint Assembly - Front Right Upper



			DESCRIPTION
SHORT	LONG		
ARM719	301181371900	MERCEDES C180 (W204) 10/2007-11/2013	Suspension Control Arm and Ball Joint Assembly - Front Left Upper
ARM719	301181371900	MERCEDES C200 (W204) 10/2007-11/2013	Suspension Control Arm and Ball Joint Assembly - Front Left Upper
ARM719	301181371900	MERCEDES C230 (W204) 10/2007-11/2013	Suspension Control Arm and Ball Joint Assembly - Front Left Upper
ARM719	301181371900	MERCEDES C250 (W204) 10/2007-11/2013	Suspension Control Arm and Ball Joint Assembly - Front Left Upper
ARM719	301181371900	MERCEDES C300 (W204) 10/2007-11/2013	Suspension Control Arm and Ball Joint Assembly - Front Left Upper
ARM719	301181371900	MERCEDES C350 (W204) 10/2007-11/2013	Suspension Control Arm and Ball Joint Assembly - Front Left Upper
ARM720	301181372000	MERCEDES C300 (W205) AWD 12/2013-	Suspension Control Arm and Ball Joint Assembly - Front Lower
ARM720	301181372000	MERCEDES C350 (W205) AWD 12/2013-	Suspension Control Arm and Ball Joint Assembly - Front Lower
ARM720	301181372000	MERCEDES C400 (W205) AWD 12/2013-	Suspension Control Arm and Ball Joint Assembly - Front Lower
ARM720	301181372000	MERCEDES C450 AMG (W205) AWD 12/2013-	Suspension Control Arm and Ball Joint Assembly - Front Lower
ARM721	301181372100	MERCEDES ML350 (W163) 1998-06/2005	Suspension Control Arm and Ball Joint Assembly - Front Right
ARM721	301181372100	MERCEDES ML500 (W163) 1998-06/2005	Suspension Control Arm and Ball Joint Assembly - Front Right
ARM722	301181372200	MERCEDES ML350 (W163) 1998-06/2005	Suspension Control Arm and Ball Joint Assembly - Front Left
ARM722	301181372200	MERCEDES ML500 (W163) 1998-06/2005	Suspension Control Arm and Ball Joint Assembly - Front Left
ARM723	301181372300	MERCEDES ML350 (W163) 1998-06/2005	Lateral Arm - Rear Right Upper
ARM723	301181372300	MERCEDES ML500 (W163) 1998-06/2005	Lateral Arm - Rear Right Upper
ARM724	301181372400	MERCEDES ML350 (W163) 1998-06/2005	Lateral Arm - Rear Left Upper
ARM724	301181372400	MERCEDES ML500 (W163) 1998-06/2005	Lateral Arm - Rear Left Upper
ARM725	301181372500	MERCEDES ML350 (W163) 1998-06/2005	Lateral Arm - Rear Right Upper Rearward
ARM725	301181372500	MERCEDES ML500 (W163) 1998-06/2005	Lateral Arm - Rear Right Upper Rearward
ARM726	301181372600	MERCEDES ML350 (W163) 1998-06/2005	Lateral Arm - Rear Left Upper Rearward
ARM726	301181372600	MERCEDES ML500 (W163) 1998-06/2005	Lateral Arm - Rear Left Upper Rearward
ARM727	301181372700	MERCEDES GL320 (X164) 2006-2012	Suspension Control Arm - Front Right
ARM727	301181372700	MERCEDES GL350 (X164) 2006-2012	Suspension Control Arm - Front Right
ARM727	301181372700	MERCEDES GL450 (X164) 2006-2012	Suspension Control Arm - Front Right
ARM727	301181372700	MERCEDES GL500 (X164) 2006-2012	Suspension Control Arm - Front Right
ARM727	301181372700	MERCEDES GL550 (X164) 2006-2012	Suspension Control Arm - Front Right
ARM727	301181372700	MERCEDES ML350 (W164) 07/2005-05/2011	Suspension Control Arm - Front Right
ARM727	301181372700	MERCEDES ML500 (W164) 07/2005-05/2011	Suspension Control Arm - Front Right
ARM727	301181372700	MERCEDES ML550 (W164) 07/2005-05/2011	Suspension Control Arm - Front Right
ARM727	301181372700	MERCEDES ML63 AMG (W164) 07/2005-05/2011	Suspension Control Arm - Front Right
ARM728	301181372800	MERCEDES GL320 (X164) 2006-2012	Suspension Control Arm - Front Left





 SHORT LONG			DESCRIPTION
ARM728	301181372800	MERCEDES GL350 (X164) 2006-2012	Suspension Control Arm - Front Left
ARM728	301181372800	MERCEDES GL450 (X164) 2006-2012	Suspension Control Arm - Front Left
ARM728	301181372800	MERCEDES GL500 (X164) 2006-2012	Suspension Control Arm - Front Left
ARM728	301181372800	MERCEDES GL550 (X164) 2006-2012	Suspension Control Arm - Front Left
ARM728	301181372800	MERCEDES ML350 (W164) 07/2005-05/2011	Suspension Control Arm - Front Left
ARM728	301181372800	MERCEDES ML500 (W164) 07/2005-05/2011	Suspension Control Arm - Front Left
ARM728	301181372800	MERCEDES ML550 (W164) 07/2005-05/2011	Suspension Control Arm - Front Left
ARM728	301181372800	MERCEDES ML63 AMG (W164) 07/2005-05/2011	Suspension Control Arm - Front Left
ARM729	301181372900	MERCEDES GL320 (X164) 2006-2012	Lateral Arm - Rear
ARM729	301181372900	MERCEDES GL350 (X164) 2006-2012	Lateral Arm - Rear
ARM729	301181372900	MERCEDES GL350 (X166) 07/2011-	Lateral Arm - Rear
ARM729	301181372900	MERCEDES GL450 (X164) 2006-2012	Lateral Arm - Rear
ARM729	301181372900	MERCEDES GL450 (X166) 07/2011-	Lateral Arm - Rear
ARM729	301181372900	MERCEDES GL500 (X164) 2006-2012	Lateral Arm - Rear
ARM729	301181372900	MERCEDES GL500 (X166) 07/2011-	Lateral Arm - Rear
ARM729	301181372900	MERCEDES GL550 (X164) 2006-2012	Lateral Arm - Rear
ARM729	301181372900	MERCEDES GL550 (X166) 07/2011-	Lateral Arm - Rear
ARM729	301181372900	MERCEDES GL63 AMG (X164) 09/2006-	Lateral Arm - Rear
ARM729	301181372900	MERCEDES ML250 (W166) 07/2011-	Lateral Arm - Rear
ARM729	301181372900	MERCEDES ML350 (W164) 07/2005-05/2011	Lateral Arm - Rear
ARM729	301181372900	MERCEDES ML350 (W166) 07/2011-	Lateral Arm - Rear
ARM729	301181372900	MERCEDES ML400 (W166) 07/2011-	Lateral Arm - Rear
ARM729	301181372900	MERCEDES ML500 (W164) 07/2005-05/2011	Lateral Arm - Rear
ARM729	301181372900	MERCEDES ML500 (W166) 07/2011-	Lateral Arm - Rear
ARM729	301181372900	MERCEDES ML550 (W164) 07/2005-05/2011	Lateral Arm - Rear
ARM729	301181372900	MERCEDES ML550 (W166) 07/2011-	Lateral Arm - Rear
ARM729	301181372900	MERCEDES ML63 AMG (W164) 07/2005-05/2011	Lateral Arm - Rear
ARM729	301181372900	MERCEDES ML63 AMG (W166) 07/2011-	Lateral Arm - Rear
ARM729	301181372900	MERCEDES R320 (W251) 09/2006-08/2013	Lateral Arm - Rear
ARM729	301181372900	MERCEDES R350 (W251) 09/2006-08/2013	Lateral Arm - Rear
ARM729	301181372900	MERCEDES R500 (W251) 09/2006-08/2013	Lateral Arm - Rear
ARM729	301181372900	MERCEDES R550 (W251) 09/2006-08/2013	Lateral Arm - Rear
ARM729	301181372900	MERCEDES R63 AMG (W251) 09/2006-08/2013	Lateral Arm - Rear
ARM730	301181373000	MERCEDES ML350 (W164) 07/2005-05/2011	Lateral Arm - Rear Right
ARM730	301181373000	MERCEDES ML500 (W164) 07/2005-05/2011	Lateral Arm - Rear Right
ARM730	301181373000	MERCEDES ML550 (W164) 07/2005-05/2011	Lateral Arm - Rear Right
ARM730	301181373000	MERCEDES ML63 AMG (W164) 07/2005-05/2011	Lateral Arm - Rear Right
ARM731	301181373100	MERCEDES ML350 (W164) 07/2005-05/2011	Lateral Arm - Rear Left



			DESCRIPTION
SHORT	LONG		
ARM731	301181373100	MERCEDES ML500 (W164) 07/2005-05/2011	Lateral Arm - Rear Left
ARM731	301181373100	MERCEDES ML550 (W164) 07/2005-05/2011	Lateral Arm - Rear Left
ARM731	301181373100	MERCEDES ML63 AMG (W164) 07/2005-05/2011	Lateral Arm - Rear Left
ARM732	301181373200	MERCEDES ML350 (W164) 07/2005-05/2011	Lateral Arm - Rear
ARM732	301181373200	MERCEDES ML500 (W164) 07/2005-05/2011	Lateral Arm - Rear
ARM732	301181373200	MERCEDES ML550 (W164) 07/2005-05/2011	Lateral Arm - Rear
ARM732	301181373200	MERCEDES ML63 AMG (W164) 07/2005-05/2011	Lateral Arm - Rear
ARM733	301181373300	MERCEDES ML350 (W164) 07/2005-05/2011	Suspension Control Arm and Ball Joint Assembly - Front Right Upper
ARM733	301181373300	MERCEDES ML500 (W164) 07/2005-05/2011	Suspension Control Arm and Ball Joint Assembly - Front Right Upper
ARM733	301181373300	MERCEDES ML550 (W164) 07/2005-05/2011	Suspension Control Arm and Ball Joint Assembly - Front Right Upper
ARM733	301181373300	MERCEDES ML63 AMG (W164) 07/2005-05/2011	Suspension Control Arm and Ball Joint Assembly - Front Right Upper
ARM733	301181373300	MERCEDES R320 (W251) 09/2006-08/2013	Suspension Control Arm and Ball Joint Assembly - Front Right Upper
ARM733	301181373300	MERCEDES R350 (W251) 09/2006-08/2013	Suspension Control Arm and Ball Joint Assembly - Front Right Upper
ARM733	301181373300	MERCEDES R500 (W251) 09/2006-08/2013	Suspension Control Arm and Ball Joint Assembly - Front Right Upper
ARM733	301181373300	MERCEDES R550 (W251) 09/2006-08/2013	Suspension Control Arm and Ball Joint Assembly - Front Right Upper
ARM733	301181373300	MERCEDES R63 AMG (W251) 09/2006-08/2013	Suspension Control Arm and Ball Joint Assembly - Front Right Upper
ARM734	301181373400	MERCEDES ML350 (W164) 07/2005-05/2011	Suspension Control Arm and Ball Joint Assembly - Front Left Upper
ARM734	301181373400	MERCEDES ML500 (W164) 07/2005-05/2011	Suspension Control Arm and Ball Joint Assembly - Front Left Upper
ARM734	301181373400	MERCEDES ML550 (W164) 07/2005-05/2011	Suspension Control Arm and Ball Joint Assembly - Front Left Upper
ARM734	301181373400	MERCEDES ML63 AMG (W164) 07/2005-05/2011	Suspension Control Arm and Ball Joint Assembly - Front Left Upper
ARM734	301181373400	MERCEDES R320 (W251) 09/2006-08/2013	Suspension Control Arm and Ball Joint Assembly - Front Left Upper
ARM734	301181373400	MERCEDES R350 (W251) 09/2006-08/2013	Suspension Control Arm and Ball Joint Assembly - Front Left Upper
ARM734	301181373400	MERCEDES R500 (W251) 09/2006-08/2013	Suspension Control Arm and Ball Joint Assembly - Front Left Upper
ARM734	301181373400	MERCEDES R550 (W251) 09/2006-08/2013	Suspension Control Arm and Ball Joint Assembly - Front Left Upper
ARM734	301181373400	MERCEDES R63 AMG (W251) 09/2006-08/2013	Suspension Control Arm and Ball Joint Assembly - Front Left Upper
ARM735	301181373500	MERCEDES R320 (W251) 09/2006-08/2013	Suspension Control Arm - Front Right
ARM735	301181373500	MERCEDES R350 (W251) 09/2006-08/2013	Suspension Control Arm - Front Right
ARM735	301181373500	MERCEDES R500 (W251) 09/2006-08/2013	Suspension Control Arm - Front Right
ARM735	301181373500	MERCEDES R550 (W251) 09/2006-08/2013	Suspension Control Arm - Front Right





 SHORT LONG			DESCRIPTION
ARM735	301181373500	MERCEDES R63 AMG (W251) 09/2006-08/2013	Suspension Control Arm - Front Right
ARM736	301181373600	MERCEDES R320 (W251) 09/2006-08/2013	Suspension Control Arm - Front Left
ARM736	301181373600	MERCEDES R350 (W251) 09/2006-08/2013	Suspension Control Arm - Front Left
ARM736	301181373600	MERCEDES R500 (W251) 09/2006-08/2013	Suspension Control Arm - Front Left
ARM736	301181373600	MERCEDES R550 (W251) 09/2006-08/2013	Suspension Control Arm - Front Left
ARM736	301181373600	MERCEDES R63 AMG (W251) 09/2006-08/2013	Suspension Control Arm - Front Left
ARM737	301181373700	MERCEDES S320 (W220) 1999-2005	Lateral Arm - Rear Lower Rearward
ARM737	301181373700	MERCEDES S350 (W220) 1999-2005	Lateral Arm - Rear Lower Rearward
ARM737	301181373700	MERCEDES S420 (W220) 1999-2005	Lateral Arm - Rear Lower Rearward
ARM737	301181373700	MERCEDES S430 (W220) 1999-2005	Lateral Arm - Rear Lower Rearward
ARM737	301181373700	MERCEDES S500 (W220) 1999-2005	Lateral Arm - Rear Lower Rearward
ARM737	301181373700	MERCEDES S55 AMG (W220) 1999-2005	Lateral Arm - Rear Lower Rearward
ARM737	301181373700	MERCEDES S600 (W220) 1999-2005	Lateral Arm - Rear Lower Rearward
ARM737	301181373700	MERCEDES S65 AMG (W220) 1999-2005	Lateral Arm - Rear Lower Rearward
ARM738	301181373800	MERCEDES CL200 C215 03/1999-03/2006	Lateral Arm - Rear Upper Rearward
ARM738	301181373800	MERCEDES CL230 C215 03/1999-03/2006	Lateral Arm - Rear Upper Rearward
ARM738	301181373800	MERCEDES CL500 C215 03/1999-03/2006	Lateral Arm - Rear Upper Rearward
ARM738	301181373800	MERCEDES CL55 AMG C215 03/1999-03/2006	Lateral Arm - Rear Upper Rearward
ARM738	301181373800	MERCEDES CL600 C215 03/1999-03/2006	Lateral Arm - Rear Upper Rearward
ARM738	301181373800	MERCEDES CL65 AMG C215 03/1999-03/2006	Lateral Arm - Rear Upper Rearward
ARM738	301181373800	MERCEDES S320 (W220) 1999-2005	Lateral Arm - Rear Upper Rearward
ARM738	301181373800	MERCEDES S350 (W220) 1999-2005	Lateral Arm - Rear Upper Rearward
ARM738	301181373800	MERCEDES S420 (W220) 1999-2005	Lateral Arm - Rear Upper Rearward
ARM738	301181373800	MERCEDES S430 (W220) 1999-2005	Lateral Arm - Rear Upper Rearward
ARM738	301181373800	MERCEDES S500 (W220) 1999-2005	Lateral Arm - Rear Upper Rearward
ARM738	301181373800	MERCEDES S55 AMG (W220) 1999-2005	Lateral Arm - Rear Upper Rearward
ARM738	301181373800	MERCEDES S600 (W220) 1999-2005	Lateral Arm - Rear Upper Rearward
ARM738	301181373800	MERCEDES S65 AMG (W220) 1999-2005	Lateral Arm - Rear Upper Rearward
ARM739	301181373900	MERCEDES CL200 C215 03/1999-03/2006	Lateral Arm - Rear Upper Forward
ARM739	301181373900	MERCEDES CL230 C215 03/1999-03/2006	Lateral Arm - Rear Upper Forward
ARM739	301181373900	MERCEDES CL500 C215 03/1999-03/2006	Lateral Arm - Rear Upper Forward
ARM739	301181373900	MERCEDES CL55 AMG C215 03/1999-03/2006	Lateral Arm - Rear Upper Forward
ARM739	301181373900	MERCEDES CL600 C215 03/1999-03/2006	Lateral Arm - Rear Upper Forward
ARM739	301181373900	MERCEDES CL65 AMG C215 03/1999-03/2006	Lateral Arm - Rear Upper Forward
ARM739	301181373900	MERCEDES S320 (W220) 1999-2005	Lateral Arm - Rear Upper Forward
ARM739	301181373900	MERCEDES S350 (W220) 1999-2005	Lateral Arm - Rear Upper Forward
ARM739	301181373900	MERCEDES S420 (W220) 1999-2005	Lateral Arm - Rear Upper Forward



 SHORT LONG			DESCRIPTION
ARM739	301181373900	MERCEDES S430 (W220) 1999-2005	Lateral Arm - Rear Upper Forward
ARM739	301181373900	MERCEDES S500 (W220) 1999-2005	Lateral Arm - Rear Upper Forward
ARM739	301181373900	MERCEDES S55 AMG (W220) 1999-2005	Lateral Arm - Rear Upper Forward
ARM739	301181373900	MERCEDES S600 (W220) 1999-2005	Lateral Arm - Rear Upper Forward
ARM739	301181373900	MERCEDES S65 AMG (W220) 1999-2005	Lateral Arm - Rear Upper Forward
ARM740	301181374000	MERCEDES CL200 C215 03/1999-03/2006	Lateral Arm - Rear Lower Forward
ARM740	301181374000	MERCEDES CL230 C215 03/1999-03/2006	Lateral Arm - Rear Lower Forward
ARM740	301181374000	MERCEDES CL500 C215 03/1999-03/2006	Lateral Arm - Rear Lower Forward
ARM740	301181374000	MERCEDES CL55 AMG C215 03/1999-03/2006	Lateral Arm - Rear Lower Forward
ARM740	301181374000	MERCEDES CL600 C215 03/1999-03/2006	Lateral Arm - Rear Lower Forward
ARM740	301181374000	MERCEDES CL65 AMG C215 03/1999-03/2006	Lateral Arm - Rear Lower Forward
ARM740	301181374000	MERCEDES S320 (W220) 1999-2005	Lateral Arm - Rear Lower Forward
ARM740	301181374000	MERCEDES S350 (W220) 1999-2005	Lateral Arm - Rear Lower Forward
ARM740	301181374000	MERCEDES S420 (W220) 1999-2005	Lateral Arm - Rear Lower Forward
ARM740	301181374000	MERCEDES S430 (W220) 1999-2005	Lateral Arm - Rear Lower Forward
ARM740	301181374000	MERCEDES S500 (W220) 1999-2005	Lateral Arm - Rear Lower Forward
ARM740	301181374000	MERCEDES S55 AMG (W220) 1999-2005	Lateral Arm - Rear Lower Forward
ARM740	301181374000	MERCEDES S600 (W220) 1999-2005	Lateral Arm - Rear Lower Forward
ARM740	301181374000	MERCEDES S65 AMG (W220) 1999-2005	Lateral Arm - Rear Lower Forward
ARM741	301181374100	MERCEDES CL200 C215 03/1999-03/2006	Suspension Control Arm and Ball Joint Assembly - Front Right Lower Forward
ARM741	301181374100	MERCEDES CL230 C215 03/1999-03/2006	Suspension Control Arm and Ball Joint Assembly - Front Right Lower Forward
ARM741	301181374100	MERCEDES CL500 C215 03/1999-03/2006	Suspension Control Arm and Ball Joint Assembly - Front Right Lower Forward
ARM741	301181374100	MERCEDES CL55 AMG C215 03/1999-03/2006	Suspension Control Arm and Ball Joint Assembly - Front Right Lower Forward
ARM741	301181374100	MERCEDES CL600 C215 03/1999-03/2006	Suspension Control Arm and Ball Joint Assembly - Front Right Lower Forward
ARM741	301181374100	MERCEDES CL65 AMG C215 03/1999-03/2006	Suspension Control Arm and Ball Joint Assembly - Front Right Lower Forward
ARM741	301181374100	MERCEDES S320 (W220) 1999-2005	Suspension Control Arm and Ball Joint Assembly - Front Right Lower Forward
ARM741	301181374100	MERCEDES S350 (W220) 1999-2005	Suspension Control Arm and Ball Joint Assembly - Front Right Lower Forward
ARM741	301181374100	MERCEDES S420 (W220) 1999-2005	Suspension Control Arm and Ball Joint Assembly - Front Right Lower Forward
ARM741	301181374100	MERCEDES S430 (W220) 1999-2005	Suspension Control Arm and Ball Joint Assembly - Front Right Lower Forward
ARM741	301181374100	MERCEDES S500 (W220) 1999-2005	Suspension Control Arm and Ball Joint Assembly - Front Right Lower Forward
ARM741	301181374100	MERCEDES S55 AMG (W220) 1999-2005	Suspension Control Arm and Ball Joint Assembly - Front Right Lower Forward
ARM741	301181374100	MERCEDES S600 (W220) 1999-2005	Suspension Control Arm and Ball Joint Assembly - Front Right Lower Forward





 SHORT LONG			DESCRIPTION
ARM741	301181374100	MERCEDES S65 AMG (W220) 1999-2005	Suspension Control Arm and Ball Joint Assembly - Front Right Lower Forward
ARM742	301181374200	MERCEDES CL200 C215 03/1999-03/2006	Suspension Control Arm and Ball Joint Assembly - Front Left Lower Forward
ARM742	301181374200	MERCEDES CL230 C215 03/1999-03/2006	Suspension Control Arm and Ball Joint Assembly - Front Left Lower Forward
ARM742	301181374200	MERCEDES CL500 C215 03/1999-03/2006	Suspension Control Arm and Ball Joint Assembly - Front Left Lower Forward
ARM742	301181374200	MERCEDES CL55 AMG C215 03/1999-03/2006	Suspension Control Arm and Ball Joint Assembly - Front Left Lower Forward
ARM742	301181374200	MERCEDES CL600 C215 03/1999-03/2006	Suspension Control Arm and Ball Joint Assembly - Front Left Lower Forward
ARM742	301181374200	MERCEDES CL65 AMG C215 03/1999-03/2006	Suspension Control Arm and Ball Joint Assembly - Front Left Lower Forward
ARM742	301181374200	MERCEDES S320 (W220) 1999-2005	Suspension Control Arm and Ball Joint Assembly - Front Left Lower Forward
ARM742	301181374200	MERCEDES S350 (W220) 1999-2005	Suspension Control Arm and Ball Joint Assembly - Front Left Lower Forward
ARM742	301181374200	MERCEDES S420 (W220) 1999-2005	Suspension Control Arm and Ball Joint Assembly - Front Left Lower Forward
ARM742	301181374200	MERCEDES S430 (W220) 1999-2005	Suspension Control Arm and Ball Joint Assembly - Front Left Lower Forward
ARM742	301181374200	MERCEDES S500 (W220) 1999-2005	Suspension Control Arm and Ball Joint Assembly - Front Left Lower Forward
ARM742	301181374200	MERCEDES S55 AMG (W220) 1999-2005	Suspension Control Arm and Ball Joint Assembly - Front Left Lower Forward
ARM742	301181374200	MERCEDES S600 (W220) 1999-2005	Suspension Control Arm and Ball Joint Assembly - Front Left Lower Forward
ARM742	301181374200	MERCEDES S65 AMG (W220) 1999-2005	Suspension Control Arm and Ball Joint Assembly - Front Left Lower Forward
ARM743	301181374300	MERCEDES S320 (W220) 1999-2005	Suspension Control Arm and Ball Joint Assembly - Front Left Lower Rearward
ARM743	301181374300	MERCEDES S350 (W220) 1999-2005	Suspension Control Arm and Ball Joint Assembly - Front Left Lower Rearward
ARM743	301181374300	MERCEDES S420 (W220) 1999-2005	Suspension Control Arm and Ball Joint Assembly - Front Left Lower Rearward
ARM743	301181374300	MERCEDES S430 (W220) 1999-2005	Suspension Control Arm and Ball Joint Assembly - Front Left Lower Rearward
ARM743	301181374300	MERCEDES S500 (W220) 1999-2005	Suspension Control Arm and Ball Joint Assembly - Front Left Lower Rearward
ARM743	301181374300	MERCEDES S55 AMG (W220) 1999-2005	Suspension Control Arm and Ball Joint Assembly - Front Left Lower Rearward
ARM743	301181374300	MERCEDES S600 (W220) 1999-2005	Suspension Control Arm and Ball Joint Assembly - Front Left Lower Rearward
ARM743	301181374300	MERCEDES S65 AMG (W220) 1999-2005	Suspension Control Arm and Ball Joint Assembly - Front Left Lower Rearward
ARM744	301181374400	MERCEDES S320 (W220) 1999-2005	Suspension Control Arm and Ball Joint Assembly - Front Right Lower Rearward
ARM744	301181374400	MERCEDES S350 (W220) 1999-2005	Suspension Control Arm and Ball Joint Assembly - Front Right Lower Rearward



			DESCRIPTION
SHORT	LONG		
ARM744	301181374400	MERCEDES S420 (W220) 1999-2005	Suspension Control Arm and Ball Joint Assembly - Front Right Lower Rearward
ARM744	301181374400	MERCEDES S430 (W220) 1999-2005	Suspension Control Arm and Ball Joint Assembly - Front Right Lower Rearward
ARM744	301181374400	MERCEDES S500 (W220) 1999-2005	Suspension Control Arm and Ball Joint Assembly - Front Right Lower Rearward
ARM744	301181374400	MERCEDES S55 AMG (W220) 1999-2005	Suspension Control Arm and Ball Joint Assembly - Front Right Lower Rearward
ARM744	301181374400	MERCEDES S600 (W220) 1999-2005	Suspension Control Arm and Ball Joint Assembly - Front Right Lower Rearward
ARM744	301181374400	MERCEDES S65 AMG (W220) 1999-2005	Suspension Control Arm and Ball Joint Assembly - Front Right Lower Rearward
ARM745	301181374500	MERCEDES CLS350 (C219) RWD 10/2004-12/2010	Suspension Control Arm and Ball Joint Assembly - Front Left Lower Forward
ARM745	301181374500	MERCEDES CLS500 (C219) RWD 10/2004-12/2010	Suspension Control Arm and Ball Joint Assembly - Front Left Lower Forward
ARM745	301181374500	MERCEDES CLS55 AMG (C219) RWD 10/2004-12/2010	Suspension Control Arm and Ball Joint Assembly - Front Left Lower Forward
ARM745	301181374500	MERCEDES CLS550 (C219) RWD 10/2004-12/2010	Suspension Control Arm and Ball Joint Assembly - Front Left Lower Forward
ARM745	301181374500	MERCEDES CLS63 AMG (C219) RWD 10/2004-12/2010	Suspension Control Arm and Ball Joint Assembly - Front Left Lower Forward
ARM745	301181374500	MERCEDES E280 (W211) 03/2003-07/2009	Suspension Control Arm and Ball Joint Assembly - Front Left Lower Forward
ARM745	301181374500	MERCEDES E300 (W211) 03/2003-07/2009	Suspension Control Arm and Ball Joint Assembly - Front Left Lower Forward
ARM745	301181374500	MERCEDES E320 (W211) 03/2003-07/2009	Suspension Control Arm and Ball Joint Assembly - Front Left Lower Forward
ARM745	301181374500	MERCEDES E350 (W211) 03/2003-07/2009	Suspension Control Arm and Ball Joint Assembly - Front Left Lower Forward
ARM745	301181374500	MERCEDES E500 (W211) 03/2003-07/2009	Suspension Control Arm and Ball Joint Assembly - Front Left Lower Forward
ARM745	301181374500	MERCEDES E55 AMG (W211) 03/2003-07/2009	Suspension Control Arm and Ball Joint Assembly - Front Left Lower Forward
ARM745	301181374500	MERCEDES E550 (W211) 03/2003-07/2009	Suspension Control Arm and Ball Joint Assembly - Front Left Lower Forward
ARM745	301181374500	MERCEDES E63 AMG (W211) 03/2003-07/2009	Suspension Control Arm and Ball Joint Assembly - Front Left Lower Forward
ARM745	301181374500	MERCEDES SL500 (R230) 10/2001-01/2012	Suspension Control Arm and Ball Joint Assembly - Front Left Lower Forward
ARM745	301181374500	MERCEDES SL55 AMG (R230) 10/2001-01/2012	Suspension Control Arm and Ball Joint Assembly - Front Left Lower Forward
ARM745	301181374500	MERCEDES SL550 (R230) 10/2001-01/2012	Suspension Control Arm and Ball Joint Assembly - Front Left Lower Forward
ARM745	301181374500	MERCEDES SL600 (R230) 10/2001-01/2012	Suspension Control Arm and Ball Joint Assembly - Front Left Lower Forward
ARM745	301181374500	MERCEDES SL63 AMG (R230) 10/2001-01/2012	Suspension Control Arm and Ball Joint Assembly - Front Left Lower Forward
ARM745	301181374500	MERCEDES SL65 AMG (R230) 10/2001-01/2012	Suspension Control Arm and Ball Joint Assembly - Front Left Lower Forward





 SHORT LONG			DESCRIPTION
ARM746	301181374600	MERCEDES CLS350 (C219) RWD 10/2004-12/2010	Suspension Control Arm and Ball Joint Assembly - Front Right Lower Forward
ARM746	301181374600	MERCEDES CLS500 (C219) RWD 10/2004-12/2010	Suspension Control Arm and Ball Joint Assembly - Front Right Lower Forward
ARM746	301181374600	MERCEDES CLS55 AMG (C219) RWD 10/2004-12/2010	Suspension Control Arm and Ball Joint Assembly - Front Right Lower Forward
ARM746	301181374600	MERCEDES CLS550 (C219) RWD 10/2004-12/2010	Suspension Control Arm and Ball Joint Assembly - Front Right Lower Forward
ARM746	301181374600	MERCEDES CLS63 AMG (C219) RWD 10/2004-12/2010	Suspension Control Arm and Ball Joint Assembly - Front Right Lower Forward
ARM746	301181374600	MERCEDES E280 (W211) 03/2003-07/2009	Suspension Control Arm and Ball Joint Assembly - Front Right Lower Forward
ARM746	301181374600	MERCEDES E300 (W211) 03/2003-07/2009	Suspension Control Arm and Ball Joint Assembly - Front Right Lower Forward
ARM746	301181374600	MERCEDES E320 (W211) 03/2003-07/2009	Suspension Control Arm and Ball Joint Assembly - Front Right Lower Forward
ARM746	301181374600	MERCEDES E350 (W211) 03/2003-07/2009	Suspension Control Arm and Ball Joint Assembly - Front Right Lower Forward
ARM746	301181374600	MERCEDES E500 (W211) 03/2003-07/2009	Suspension Control Arm and Ball Joint Assembly - Front Right Lower Forward
ARM746	301181374600	MERCEDES E55 AMG (W211) 03/2003-07/2009	Suspension Control Arm and Ball Joint Assembly - Front Right Lower Forward
ARM746	301181374600	MERCEDES E550 (W211) 03/2003-07/2009	Suspension Control Arm and Ball Joint Assembly - Front Right Lower Forward
ARM746	301181374600	MERCEDES E63 AMG (W211) 03/2003-07/2009	Suspension Control Arm and Ball Joint Assembly - Front Right Lower Forward
ARM746	301181374600	MERCEDES SL500 (R230) 10/2001-01/2012	Suspension Control Arm and Ball Joint Assembly - Front Right Lower Forward
ARM746	301181374600	MERCEDES SL55 AMG (R230) 10/2001-01/2012	Suspension Control Arm and Ball Joint Assembly - Front Right Lower Forward
ARM746	301181374600	MERCEDES SL550 (R230) 10/2001-01/2012	Suspension Control Arm and Ball Joint Assembly - Front Right Lower Forward
ARM746	301181374600	MERCEDES SL600 (R230) 10/2001-01/2012	Suspension Control Arm and Ball Joint Assembly - Front Right Lower Forward
ARM746	301181374600	MERCEDES SL63 AMG (R230) 10/2001-01/2012	Suspension Control Arm and Ball Joint Assembly - Front Right Lower Forward
ARM746	301181374600	MERCEDES SL65 AMG (R230) 10/2001-01/2012	Suspension Control Arm and Ball Joint Assembly - Front Right Lower Forward
ARM747	301181374700	MERCEDES CLS350 (C219) RWD 10/2004-12/2010	Suspension Control Arm and Ball Joint Assembly - Front Left Lower Rearward
ARM747	301181374700	MERCEDES CLS500 (C219) RWD 10/2004-12/2010	Suspension Control Arm and Ball Joint Assembly - Front Left Lower Rearward
ARM747	301181374700	MERCEDES CLS55 AMG (C219) RWD 10/2004-12/2010	Suspension Control Arm and Ball Joint Assembly - Front Left Lower Rearward
ARM747	301181374700	MERCEDES CLS550 (C219) RWD 10/2004-12/2010	Suspension Control Arm and Ball Joint Assembly - Front Left Lower Rearward
ARM747	301181374700	MERCEDES CLS63 AMG (C219) RWD 10/2004-12/2010	Suspension Control Arm and Ball Joint Assembly - Front Left Lower Rearward
ARM747	301181374700	MERCEDES E280 (W211) 03/2003-07/2009	Suspension Control Arm and Ball Joint Assembly - Front Left Lower Rearward



			DESCRIPTION
SHORT	LONG		
ARM747	301181374700	MERCEDES E300 (W211) 03/2003-07/2009	Suspension Control Arm and Ball Joint Assembly - Front Left Lower Rearward
ARM747	301181374700	MERCEDES E320 (W211) 03/2003-07/2009	Suspension Control Arm and Ball Joint Assembly - Front Left Lower Rearward
ARM747	301181374700	MERCEDES E350 (W211) 03/2003-07/2009	Suspension Control Arm and Ball Joint Assembly - Front Left Lower Rearward
ARM747	301181374700	MERCEDES E500 (W211) 03/2003-07/2009	Suspension Control Arm and Ball Joint Assembly - Front Left Lower Rearward
ARM747	301181374700	MERCEDES E55 AMG (W211) 03/2003-07/2009	Suspension Control Arm and Ball Joint Assembly - Front Left Lower Rearward
ARM747	301181374700	MERCEDES E550 (W211) 03/2003-07/2009	Suspension Control Arm and Ball Joint Assembly - Front Left Lower Rearward
ARM747	301181374700	MERCEDES E63 AMG (W211) 03/2003-07/2009	Suspension Control Arm and Ball Joint Assembly - Front Left Lower Rearward
ARM747	301181374700	MERCEDES SL500 (R230) 10/2001-01/2012	Suspension Control Arm and Ball Joint Assembly - Front Left Lower Rearward
ARM747	301181374700	MERCEDES SL55 AMG (R230) 10/2001-01/2012	Suspension Control Arm and Ball Joint Assembly - Front Left Lower Rearward
ARM747	301181374700	MERCEDES SL550 (R230) 10/2001-01/2012	Suspension Control Arm and Ball Joint Assembly - Front Left Lower Rearward
ARM747	301181374700	MERCEDES SL600 (R230) 10/2001-01/2012	Suspension Control Arm and Ball Joint Assembly - Front Left Lower Rearward
ARM747	301181374700	MERCEDES SL63 AMG (R230) 10/2001-01/2012	Suspension Control Arm and Ball Joint Assembly - Front Left Lower Rearward
ARM747	301181374700	MERCEDES SL65 AMG (R230) 10/2001-01/2012	Suspension Control Arm and Ball Joint Assembly - Front Left Lower Rearward
ARM748	301181374800	MERCEDES CLS350 (C219) RWD 10/2004-12/2010	Suspension Control Arm and Ball Joint Assembly - Front Right Lower Rearward
ARM748	301181374800	MERCEDES CLS500 (C219) RWD 10/2004-12/2010	Suspension Control Arm and Ball Joint Assembly - Front Right Lower Rearward
ARM748	301181374800	MERCEDES CLS55 AMG (C219) RWD 10/2004-12/2010	Suspension Control Arm and Ball Joint Assembly - Front Right Lower Rearward
ARM748	301181374800	MERCEDES CLS550 (C219) RWD 10/2004-12/2010	Suspension Control Arm and Ball Joint Assembly - Front Right Lower Rearward
ARM748	301181374800	MERCEDES CLS63 AMG (C219) RWD 10/2004-12/2010	Suspension Control Arm and Ball Joint Assembly - Front Right Lower Rearward
ARM748	301181374800	MERCEDES E280 (W211) 03/2003-07/2009	Suspension Control Arm and Ball Joint Assembly - Front Right Lower Rearward
ARM748	301181374800	MERCEDES E300 (W211) 03/2003-07/2009	Suspension Control Arm and Ball Joint Assembly - Front Right Lower Rearward
ARM748	301181374800	MERCEDES E320 (W211) 03/2003-07/2009	Suspension Control Arm and Ball Joint Assembly - Front Right Lower Rearward
ARM748	301181374800	MERCEDES E350 (W211) 03/2003-07/2009	Suspension Control Arm and Ball Joint Assembly - Front Right Lower Rearward
ARM748	301181374800	MERCEDES E500 (W211) 03/2003-07/2009	Suspension Control Arm and Ball Joint Assembly - Front Right Lower Rearward
ARM748	301181374800	MERCEDES E55 AMG (W211) 03/2003-07/2009	Suspension Control Arm and Ball Joint Assembly - Front Right Lower Rearward
ARM748	301181374800	MERCEDES E550 (W211) 03/2003-07/2009	Suspension Control Arm and Ball Joint Assembly - Front Right Lower Rearward





 SHORT LONG			DESCRIPTION
ARM748	301181374800	MERCEDES E63 AMG (W211) 03/2003-07/2009	Suspension Control Arm and Ball Joint Assembly - Front Right Lower Rearward
ARM748	301181374800	MERCEDES SL500 (R230) 10/2001-01/2012	Suspension Control Arm and Ball Joint Assembly - Front Right Lower Rearward
ARM748	301181374800	MERCEDES SL55 AMG (R230) 10/2001-01/2012	Suspension Control Arm and Ball Joint Assembly - Front Right Lower Rearward
ARM748	301181374800	MERCEDES SL550 (R230) 10/2001-01/2012	Suspension Control Arm and Ball Joint Assembly - Front Right Lower Rearward
ARM748	301181374800	MERCEDES SL600 (R230) 10/2001-01/2012	Suspension Control Arm and Ball Joint Assembly - Front Right Lower Rearward
ARM748	301181374800	MERCEDES SL63 AMG (R230) 10/2001-01/2012	Suspension Control Arm and Ball Joint Assembly - Front Right Lower Rearward
ARM748	301181374800	MERCEDES SL65 AMG (R230) 10/2001-01/2012	Suspension Control Arm and Ball Joint Assembly - Front Right Lower Rearward
ARM749	301181374900	MERCEDES CL200 C215 03/1999-03/2006	Suspension Control Arm and Ball Joint Assembly - Front Right Upper
ARM749	301181374900	MERCEDES CL230 C215 03/1999-03/2006	Suspension Control Arm and Ball Joint Assembly - Front Right Upper
ARM749	301181374900	MERCEDES CL500 C215 03/1999-03/2006	Suspension Control Arm and Ball Joint Assembly - Front Right Upper
ARM749	301181374900	MERCEDES CL55 AMG C215 03/1999-03/2006	Suspension Control Arm and Ball Joint Assembly - Front Right Upper
ARM749	301181374900	MERCEDES CL600 C215 03/1999-03/2006	Suspension Control Arm and Ball Joint Assembly - Front Right Upper
ARM749	301181374900	MERCEDES CL65 AMG C215 03/1999-03/2006	Suspension Control Arm and Ball Joint Assembly - Front Right Upper
ARM749	301181374900	MERCEDES S320 (W220) 1999-2005	Suspension Control Arm and Ball Joint Assembly - Front Right Upper
ARM749	301181374900	MERCEDES S350 (W220) 1999-2005	Suspension Control Arm and Ball Joint Assembly - Front Right Upper
ARM749	301181374900	MERCEDES S420 (W220) 1999-2005	Suspension Control Arm and Ball Joint Assembly - Front Right Upper
ARM749	301181374900	MERCEDES S430 (W220) 1999-2005	Suspension Control Arm and Ball Joint Assembly - Front Right Upper
ARM749	301181374900	MERCEDES S500 (W220) 1999-2005	Suspension Control Arm and Ball Joint Assembly - Front Right Upper
ARM749	301181374900	MERCEDES S55 AMG (W220) 1999-2005	Suspension Control Arm and Ball Joint Assembly - Front Right Upper
ARM749	301181374900	MERCEDES S600 (W220) 1999-2005	Suspension Control Arm and Ball Joint Assembly - Front Right Upper
ARM749	301181374900	MERCEDES S65 AMG (W220) 1999-2005	Suspension Control Arm and Ball Joint Assembly - Front Right Upper
ARM750	301181375000	MERCEDES CL200 C215 03/1999-03/2006	Suspension Control Arm and Ball Joint Assembly - Front Left Upper
ARM750	301181375000	MERCEDES CL230 C215 03/1999-03/2006	Suspension Control Arm and Ball Joint Assembly - Front Left Upper
ARM750	301181375000	MERCEDES CL500 C215 03/1999-03/2006	Suspension Control Arm and Ball Joint Assembly - Front Left Upper
ARM750	301181375000	MERCEDES CL55 AMG C215 03/1999-03/2006	Suspension Control Arm and Ball Joint Assembly - Front Left Upper



			DESCRIPTION
SHORT	LONG		
ARM750	301181375000	MERCEDES CL600 C215 03/1999-03/2006	Suspension Control Arm and Ball Joint Assembly - Front Left Upper
ARM750	301181375000	MERCEDES CL65 AMG C215 03/1999-03/2006	Suspension Control Arm and Ball Joint Assembly - Front Left Upper
ARM750	301181375000	MERCEDES S320 (W220) 1999-2005	Suspension Control Arm and Ball Joint Assembly - Front Left Upper
ARM750	301181375000	MERCEDES S350 (W220) 1999-2005	Suspension Control Arm and Ball Joint Assembly - Front Left Upper
ARM750	301181375000	MERCEDES S420 (W220) 1999-2005	Suspension Control Arm and Ball Joint Assembly - Front Left Upper
ARM750	301181375000	MERCEDES S430 (W220) 1999-2005	Suspension Control Arm and Ball Joint Assembly - Front Left Upper
ARM750	301181375000	MERCEDES S500 (W220) 1999-2005	Suspension Control Arm and Ball Joint Assembly - Front Left Upper
ARM750	301181375000	MERCEDES S55 AMG (W220) 1999-2005	Suspension Control Arm and Ball Joint Assembly - Front Left Upper
ARM750	301181375000	MERCEDES S600 (W220) 1999-2005	Suspension Control Arm and Ball Joint Assembly - Front Left Upper
ARM750	301181375000	MERCEDES S65 AMG (W220) 1999-2005	Suspension Control Arm and Ball Joint Assembly - Front Left Upper
ARM751	301181375100	MERCEDES CLS350 (C219) RWD 10/2004-12/2010	Suspension Control Arm and Ball Joint Assembly - Front Right Lower
ARM751	301181375100	MERCEDES CLS500 (C219) RWD 10/2004-12/2010	Suspension Control Arm and Ball Joint Assembly - Front Right Lower
ARM751	301181375100	MERCEDES CLS55 AMG (C219) RWD 10/2004-12/2010	Suspension Control Arm and Ball Joint Assembly - Front Right Lower
ARM751	301181375100	MERCEDES CLS550 (C219) RWD 10/2004-12/2010	Suspension Control Arm and Ball Joint Assembly - Front Right Lower
ARM751	301181375100	MERCEDES CLS63 AMG (C219) RWD 10/2004-12/2010	Suspension Control Arm and Ball Joint Assembly - Front Right Lower
ARM751	301181375100	MERCEDES E280 (W211) 03/2003-07/2009	Suspension Control Arm and Ball Joint Assembly - Front Right Lower
ARM751	301181375100	MERCEDES E300 (W211) 03/2003-07/2009	Suspension Control Arm and Ball Joint Assembly - Front Right Lower
ARM751	301181375100	MERCEDES E320 (W211) 03/2003-07/2009	Suspension Control Arm and Ball Joint Assembly - Front Right Lower
ARM751	301181375100	MERCEDES E350 (W211) 03/2003-07/2009	Suspension Control Arm and Ball Joint Assembly - Front Right Lower
ARM751	301181375100	MERCEDES E500 (W211) 03/2003-07/2009	Suspension Control Arm and Ball Joint Assembly - Front Right Lower
ARM751	301181375100	MERCEDES E55 AMG (W211) 03/2003-07/2009	Suspension Control Arm and Ball Joint Assembly - Front Right Lower
ARM751	301181375100	MERCEDES E550 (W211) 03/2003-07/2009	Suspension Control Arm and Ball Joint Assembly - Front Right Lower
ARM751	301181375100	MERCEDES E63 AMG (W211) 03/2003-07/2009	Suspension Control Arm and Ball Joint Assembly - Front Right Lower
ARM752	301181375200	MERCEDES CLS350 (C219) RWD 10/2004-12/2010	Suspension Control Arm and Ball Joint Assembly - Front Left Lower
ARM752	301181375200	MERCEDES CLS500 (C219) RWD 10/2004-12/2010	Suspension Control Arm and Ball Joint Assembly - Front Left Lower





 SHORT LONG			DESCRIPTION
ARM752	301181375200	MERCEDES CLS55 AMG (C219) RWD 10/2004-12/2010	Suspension Control Arm and Ball Joint Assembly - Front Left Lower
ARM752	301181375200	MERCEDES CLS550 (C219) RWD 10/2004- 12/2010	Suspension Control Arm and Ball Joint Assembly - Front Left Lower
ARM752	301181375200	MERCEDES CLS63 AMG (C219) RWD 10/2004-12/2010	Suspension Control Arm and Ball Joint Assembly - Front Left Lower
ARM752	301181375200	MERCEDES E280 (W211) 03/2003-07/2009	Suspension Control Arm and Ball Joint Assembly - Front Left Lower
ARM752	301181375200	MERCEDES E300 (W211) 03/2003-07/2009	Suspension Control Arm and Ball Joint Assembly - Front Left Lower
ARM752	301181375200	MERCEDES E320 (W211) 03/2003-07/2009	Suspension Control Arm and Ball Joint Assembly - Front Left Lower
ARM752	301181375200	MERCEDES E350 (W211) 03/2003-07/2009	Suspension Control Arm and Ball Joint Assembly - Front Left Lower
ARM752	301181375200	MERCEDES E500 (W211) 03/2003-07/2009	Suspension Control Arm and Ball Joint Assembly - Front Left Lower
ARM752	301181375200	MERCEDES E55 AMG (W211) 03/2003- 07/2009	Suspension Control Arm and Ball Joint Assembly - Front Left Lower
ARM752	301181375200	MERCEDES E550 (W211) 03/2003-07/2009	Suspension Control Arm and Ball Joint Assembly - Front Left Lower
ARM752	301181375200	MERCEDES E63 AMG (W211) 03/2003- 07/2009	Suspension Control Arm and Ball Joint Assembly - Front Left Lower
ARM753	301181375300	MERCEDES CLS350 (C219) RWD 10/2004- 12/2010	Lateral Arm - Rear Right
ARM753	301181375300	MERCEDES CLS500 (C219) RWD 10/2004- 12/2010	Lateral Arm - Rear Right
ARM753	301181375300	MERCEDES CLS55 AMG (C219) RWD 10/2004-12/2010	Lateral Arm - Rear Right
ARM753	301181375300	MERCEDES CLS550 (C219) RWD 10/2004- 12/2010	Lateral Arm - Rear Right
ARM753	301181375300	MERCEDES CLS63 AMG (C219) RWD 10/2004-12/2010	Lateral Arm - Rear Right
ARM753	301181375300	MERCEDES E280 (W211) 03/2003-07/2009	Lateral Arm - Rear Right
ARM753	301181375300	MERCEDES E300 (W211) 03/2003-07/2009	Lateral Arm - Rear Right
ARM753	301181375300	MERCEDES E320 (W211) 03/2003-07/2009	Lateral Arm - Rear Right
ARM753	301181375300	MERCEDES E350 (W211) 03/2003-07/2009	Lateral Arm - Rear Right
ARM753	301181375300	MERCEDES E500 (W211) 03/2003-07/2009	Lateral Arm - Rear Right
ARM753	301181375300	MERCEDES E55 AMG (W211) 03/2003- 07/2009	Lateral Arm - Rear Right
ARM753	301181375300	MERCEDES E550 (W211) 03/2003-07/2009	Lateral Arm - Rear Right
ARM753	301181375300	MERCEDES E63 AMG (W211) 03/2003- 07/2009	Lateral Arm - Rear Right
ARM753	301181375300	MERCEDES SL500 (R230) 10/2001-01/2012	Lateral Arm - Rear Right
ARM753	301181375300	MERCEDES SL55 AMG (R230) 10/2001- 01/2012	Lateral Arm - Rear Right
ARM753	301181375300	MERCEDES SL550 (R230) 10/2001-01/2012	Lateral Arm - Rear Right
ARM753	301181375300	MERCEDES SL600 (R230) 10/2001-01/2012	Lateral Arm - Rear Right
ARM753	301181375300	MERCEDES SL63 AMG (R230) 10/2001- 01/2012	Lateral Arm - Rear Right



			DESCRIPTION
SHORT	LONG		
ARM753	301181375300	MERCEDES SL65 AMG (R230) 10/2001-01/2012	Lateral Arm - Rear Right
ARM754	301181375400	MERCEDES CLS350 (C219) RWD 10/2004-12/2010	Lateral Arm - Rear Left
ARM754	301181375400	MERCEDES CLS500 (C219) RWD 10/2004-12/2010	Lateral Arm - Rear Left
ARM754	301181375400	MERCEDES CLS55 AMG (C219) RWD 10/2004-12/2010	Lateral Arm - Rear Left
ARM754	301181375400	MERCEDES CLS550 (C219) RWD 10/2004-12/2010	Lateral Arm - Rear Left
ARM754	301181375400	MERCEDES CLS63 AMG (C219) RWD 10/2004-12/2010	Lateral Arm - Rear Left
ARM754	301181375400	MERCEDES E280 (W211) 03/2003-07/2009	Lateral Arm - Rear Left
ARM754	301181375400	MERCEDES E300 (W211) 03/2003-07/2009	Lateral Arm - Rear Left
ARM754	301181375400	MERCEDES E320 (W211) 03/2003-07/2009	Lateral Arm - Rear Left
ARM754	301181375400	MERCEDES E350 (W211) 03/2003-07/2009	Lateral Arm - Rear Left
ARM754	301181375400	MERCEDES E500 (W211) 03/2003-07/2009	Lateral Arm - Rear Left
ARM754	301181375400	MERCEDES E55 AMG (W211) 03/2003-07/2009	Lateral Arm - Rear Left
ARM754	301181375400	MERCEDES E550 (W211) 03/2003-07/2009	Lateral Arm - Rear Left
ARM754	301181375400	MERCEDES E63 AMG (W211) 03/2003-07/2009	Lateral Arm - Rear Left
ARM754	301181375400	MERCEDES SL500 (R230) 10/2001-01/2012	Lateral Arm - Rear Left
ARM754	301181375400	MERCEDES SL55 AMG (R230) 10/2001-01/2012	Lateral Arm - Rear Left
ARM754	301181375400	MERCEDES SL550 (R230) 10/2001-01/2012	Lateral Arm - Rear Left
ARM754	301181375400	MERCEDES SL600 (R230) 10/2001-01/2012	Lateral Arm - Rear Left
ARM754	301181375400	MERCEDES SL63 AMG (R230) 10/2001-01/2012	Lateral Arm - Rear Left
ARM754	301181375400	MERCEDES SL65 AMG (R230) 10/2001-01/2012	Lateral Arm - Rear Left
ARM755	301181375500	MERCEDES CLS350 (C219) RWD 10/2004-12/2010	Lateral Arm - Rear Lower
ARM755	301181375500	MERCEDES CLS500 (C219) RWD 10/2004-12/2010	Lateral Arm - Rear Lower
ARM755	301181375500	MERCEDES CLS55 AMG (C219) RWD 10/2004-12/2010	Lateral Arm - Rear Lower
ARM755	301181375500	MERCEDES CLS550 (C219) RWD 10/2004-12/2010	Lateral Arm - Rear Lower
ARM755	301181375500	MERCEDES CLS63 AMG (C219) RWD 10/2004-12/2010	Lateral Arm - Rear Lower
ARM755	301181375500	MERCEDES E280 (W211) 03/2003-07/2009	Lateral Arm - Rear Lower
ARM755	301181375500	MERCEDES E300 (W211) 03/2003-07/2009	Lateral Arm - Rear Lower
ARM755	301181375500	MERCEDES E320 (W211) 03/2003-07/2009	Lateral Arm - Rear Lower
ARM755	301181375500	MERCEDES E350 (W211) 03/2003-07/2009	Lateral Arm - Rear Lower
ARM755	301181375500	MERCEDES E500 (W211) 03/2003-07/2009	Lateral Arm - Rear Lower
ARM755	301181375500	MERCEDES E55 AMG (W211) 03/2003-07/2009	Lateral Arm - Rear Lower





 SHORT LONG			DESCRIPTION
ARM755	301181375500	MERCEDES E550 (W211) 03/2003-07/2009	Lateral Arm - Rear Lower
ARM755	301181375500	MERCEDES E63 AMG (W211) 03/2003-07/2009	Lateral Arm - Rear Lower
ARM755	301181375500	MERCEDES SL500 (R230) 10/2001-01/2012	Lateral Arm - Rear Lower
ARM755	301181375500	MERCEDES SL55 AMG (R230) 10/2001-01/2012	Lateral Arm - Rear Lower
ARM755	301181375500	MERCEDES SL550 (R230) 10/2001-01/2012	Lateral Arm - Rear Lower
ARM755	301181375500	MERCEDES SL600 (R230) 10/2001-01/2012	Lateral Arm - Rear Lower
ARM755	301181375500	MERCEDES SL63 AMG (R230) 10/2001-01/2012	Lateral Arm - Rear Lower
ARM755	301181375500	MERCEDES SL65 AMG (R230) 10/2001-01/2012	Lateral Arm - Rear Lower
ARM756	301181375600	MERCEDES CLS350 (C219) RWD 10/2004-12/2010	Lateral Arm - Rear Right Upper Forward
ARM756	301181375600	MERCEDES CLS500 (C219) RWD 10/2004-12/2010	Lateral Arm - Rear Right Upper Forward
ARM756	301181375600	MERCEDES CLS55 AMG (C219) RWD 10/2004-12/2010	Lateral Arm - Rear Right Upper Forward
ARM756	301181375600	MERCEDES CLS550 (C219) RWD 10/2004-12/2010	Lateral Arm - Rear Right Upper Forward
ARM756	301181375600	MERCEDES CLS63 AMG (C219) RWD 10/2004-12/2010	Lateral Arm - Rear Right Upper Forward
ARM756	301181375600	MERCEDES E280 (W211) 03/2003-07/2009	Lateral Arm - Rear Right Upper Forward
ARM756	301181375600	MERCEDES E300 (W211) 03/2003-07/2009	Lateral Arm - Rear Right Upper Forward
ARM756	301181375600	MERCEDES E320 (W211) 03/2003-07/2009	Lateral Arm - Rear Right Upper Forward
ARM756	301181375600	MERCEDES E350 (W211) 03/2003-07/2009	Lateral Arm - Rear Right Upper Forward
ARM756	301181375600	MERCEDES E500 (W211) 03/2003-07/2009	Lateral Arm - Rear Right Upper Forward
ARM756	301181375600	MERCEDES E55 AMG (W211) 03/2003-07/2009	Lateral Arm - Rear Right Upper Forward
ARM756	301181375600	MERCEDES E550 (W211) 03/2003-07/2009	Lateral Arm - Rear Right Upper Forward
ARM756	301181375600	MERCEDES E63 AMG (W211) 03/2003-07/2009	Lateral Arm - Rear Right Upper Forward
ARM756	301181375600	MERCEDES SL500 (R230) 10/2001-01/2012	Lateral Arm - Rear Right Upper Forward
ARM756	301181375600	MERCEDES SL55 AMG (R230) 10/2001-01/2012	Lateral Arm - Rear Right Upper Forward
ARM756	301181375600	MERCEDES SL550 (R230) 10/2001-01/2012	Lateral Arm - Rear Right Upper Forward
ARM756	301181375600	MERCEDES SL600 (R230) 10/2001-01/2012	Lateral Arm - Rear Right Upper Forward
ARM756	301181375600	MERCEDES SL63 AMG (R230) 10/2001-01/2012	Lateral Arm - Rear Right Upper Forward
ARM756	301181375600	MERCEDES SL65 AMG (R230) 10/2001-01/2012	Lateral Arm - Rear Right Upper Forward
ARM757	301181375700	MERCEDES CLS350 (C219) RWD 10/2004-12/2010	Lateral Arm - Rear Left Upper Forward
ARM757	301181375700	MERCEDES CLS500 (C219) RWD 10/2004-12/2010	Lateral Arm - Rear Left Upper Forward
ARM757	301181375700	MERCEDES CLS55 AMG (C219) RWD 10/2004-12/2010	Lateral Arm - Rear Left Upper Forward



			DESCRIPTION
SHORT	LONG		
ARM757	301181375700	MERCEDES CLS550 (C219) RWD 10/2004-12/2010	Lateral Arm - Rear Left Upper Forward
ARM757	301181375700	MERCEDES CLS63 AMG (C219) RWD 10/2004-12/2010	Lateral Arm - Rear Left Upper Forward
ARM757	301181375700	MERCEDES E280 (W211) 03/2003-07/2009	Lateral Arm - Rear Left Upper Forward
ARM757	301181375700	MERCEDES E300 (W211) 03/2003-07/2009	Lateral Arm - Rear Left Upper Forward
ARM757	301181375700	MERCEDES E320 (W211) 03/2003-07/2009	Lateral Arm - Rear Left Upper Forward
ARM757	301181375700	MERCEDES E350 (W211) 03/2003-07/2009	Lateral Arm - Rear Left Upper Forward
ARM757	301181375700	MERCEDES E500 (W211) 03/2003-07/2009	Lateral Arm - Rear Left Upper Forward
ARM757	301181375700	MERCEDES E55 AMG (W211) 03/2003-07/2009	Lateral Arm - Rear Left Upper Forward
ARM757	301181375700	MERCEDES E550 (W211) 03/2003-07/2009	Lateral Arm - Rear Left Upper Forward
ARM757	301181375700	MERCEDES E63 AMG (W211) 03/2003-07/2009	Lateral Arm - Rear Left Upper Forward
ARM757	301181375700	MERCEDES SL500 (R230) 10/2001-01/2012	Lateral Arm - Rear Left Upper Forward
ARM757	301181375700	MERCEDES SL55 AMG (R230) 10/2001-01/2012	Lateral Arm - Rear Left Upper Forward
ARM757	301181375700	MERCEDES SL550 (R230) 10/2001-01/2012	Lateral Arm - Rear Left Upper Forward
ARM757	301181375700	MERCEDES SL600 (R230) 10/2001-01/2012	Lateral Arm - Rear Left Upper Forward
ARM757	301181375700	MERCEDES SL63 AMG (R230) 10/2001-01/2012	Lateral Arm - Rear Left Upper Forward
ARM757	301181375700	MERCEDES SL65 AMG (R230) 10/2001-01/2012	Lateral Arm - Rear Left Upper Forward
ARM758	301181375800	MERCEDES CLS350 (C219) RWD 10/2004-12/2010	Lateral Arm - Rear Right Upper Rearward
ARM758	301181375800	MERCEDES CLS500 (C219) RWD 10/2004-12/2010	Lateral Arm - Rear Right Upper Rearward
ARM758	301181375800	MERCEDES CLS55 AMG (C219) RWD 10/2004-12/2010	Lateral Arm - Rear Right Upper Rearward
ARM758	301181375800	MERCEDES CLS550 (C219) RWD 10/2004-12/2010	Lateral Arm - Rear Right Upper Rearward
ARM758	301181375800	MERCEDES CLS63 AMG (C219) RWD 10/2004-12/2010	Lateral Arm - Rear Right Upper Rearward
ARM758	301181375800	MERCEDES E280 (W211) 03/2003-07/2009	Lateral Arm - Rear Right Upper Rearward
ARM758	301181375800	MERCEDES E300 (W211) 03/2003-07/2009	Lateral Arm - Rear Right Upper Rearward
ARM758	301181375800	MERCEDES E320 (W211) 03/2003-07/2009	Lateral Arm - Rear Right Upper Rearward
ARM758	301181375800	MERCEDES E350 (W211) 03/2003-07/2009	Lateral Arm - Rear Right Upper Rearward
ARM758	301181375800	MERCEDES E500 (W211) 03/2003-07/2009	Lateral Arm - Rear Right Upper Rearward
ARM758	301181375800	MERCEDES E55 AMG (W211) 03/2003-07/2009	Lateral Arm - Rear Right Upper Rearward
ARM758	301181375800	MERCEDES E550 (W211) 03/2003-07/2009	Lateral Arm - Rear Right Upper Rearward
ARM758	301181375800	MERCEDES E63 AMG (W211) 03/2003-07/2009	Lateral Arm - Rear Right Upper Rearward
ARM758	301181375800	MERCEDES SL500 (R230) 10/2001-01/2012	Lateral Arm - Rear Right Upper Rearward
ARM758	301181375800	MERCEDES SL55 AMG (R230) 10/2001-01/2012	Lateral Arm - Rear Right Upper Rearward
ARM758	301181375800	MERCEDES SL550 (R230) 10/2001-01/2012	Lateral Arm - Rear Right Upper Rearward





 SHORT LONG			DESCRIPTION
ARM758	301181375800	MERCEDES SL600 (R230) 10/2001-01/2012	Lateral Arm - Rear Right Upper Rearward
ARM758	301181375800	MERCEDES SL63 AMG (R230) 10/2001-01/2012	Lateral Arm - Rear Right Upper Rearward
ARM758	301181375800	MERCEDES SL65 AMG (R230) 10/2001-01/2012	Lateral Arm - Rear Right Upper Rearward
ARM759	301181375900	MERCEDES CLS350 (C219) RWD 10/2004-12/2010	Lateral Arm - Rear Left Upper Rearward
ARM759	301181375900	MERCEDES CLS500 (C219) RWD 10/2004-12/2010	Lateral Arm - Rear Left Upper Rearward
ARM759	301181375900	MERCEDES CLS55 AMG (C219) RWD 10/2004-12/2010	Lateral Arm - Rear Left Upper Rearward
ARM759	301181375900	MERCEDES CLS550 (C219) RWD 10/2004-12/2010	Lateral Arm - Rear Left Upper Rearward
ARM759	301181375900	MERCEDES CLS63 AMG (C219) RWD 10/2004-12/2010	Lateral Arm - Rear Left Upper Rearward
ARM759	301181375900	MERCEDES E280 (W211) 03/2003-07/2009	Lateral Arm - Rear Left Upper Rearward
ARM759	301181375900	MERCEDES E300 (W211) 03/2003-07/2009	Lateral Arm - Rear Left Upper Rearward
ARM759	301181375900	MERCEDES E320 (W211) 03/2003-07/2009	Lateral Arm - Rear Left Upper Rearward
ARM759	301181375900	MERCEDES E350 (W211) 03/2003-07/2009	Lateral Arm - Rear Left Upper Rearward
ARM759	301181375900	MERCEDES E500 (W211) 03/2003-07/2009	Lateral Arm - Rear Left Upper Rearward
ARM759	301181375900	MERCEDES E55 AMG (W211) 03/2003-07/2009	Lateral Arm - Rear Left Upper Rearward
ARM759	301181375900	MERCEDES E550 (W211) 03/2003-07/2009	Lateral Arm - Rear Left Upper Rearward
ARM759	301181375900	MERCEDES E63 AMG (W211) 03/2003-07/2009	Lateral Arm - Rear Left Upper Rearward
ARM759	301181375900	MERCEDES SL500 (R230) 10/2001-01/2012	Lateral Arm - Rear Left Upper Rearward
ARM759	301181375900	MERCEDES SL55 AMG (R230) 10/2001-01/2012	Lateral Arm - Rear Left Upper Rearward
ARM759	301181375900	MERCEDES SL550 (R230) 10/2001-01/2012	Lateral Arm - Rear Left Upper Rearward
ARM759	301181375900	MERCEDES SL600 (R230) 10/2001-01/2012	Lateral Arm - Rear Left Upper Rearward
ARM759	301181375900	MERCEDES SL63 AMG (R230) 10/2001-01/2012	Lateral Arm - Rear Left Upper Rearward
ARM759	301181375900	MERCEDES SL65 AMG (R230) 10/2001-01/2012	Lateral Arm - Rear Left Upper Rearward
ARM760	301181376000	MERCEDES S350 (W221) 10/2005-04/2013	Suspension Control Arm and Ball Joint Assembly - Front Right Lower Forward
ARM760	301181376000	MERCEDES S400 (W221) 10/2005-04/2013	Suspension Control Arm and Ball Joint Assembly - Front Right Lower Forward
ARM760	301181376000	MERCEDES S430 (W221) 10/2005-04/2013	Suspension Control Arm and Ball Joint Assembly - Front Right Lower Forward
ARM760	301181376000	MERCEDES S450 (W221) 10/2005-04/2013	Suspension Control Arm and Ball Joint Assembly - Front Right Lower Forward
ARM760	301181376000	MERCEDES S500 (W221) 10/2005-04/2013	Suspension Control Arm and Ball Joint Assembly - Front Right Lower Forward
ARM760	301181376000	MERCEDES S550 (W221) 10/2005-04/2013	Suspension Control Arm and Ball Joint Assembly - Front Right Lower Forward
ARM760	301181376000	MERCEDES S600 (W221) 10/2005-04/2013	Suspension Control Arm and Ball Joint Assembly - Front Right Lower Forward



			DESCRIPTION
SHORT	LONG		
ARM760	301181376000	MERCEDES S63 AMG (W221) 10/2005-04/2013	Suspension Control Arm and Ball Joint Assembly - Front Right Lower Forward
ARM760	301181376000	MERCEDES S65 AMG (W221) 10/2005-04/2013	Suspension Control Arm and Ball Joint Assembly - Front Right Lower Forward
ARM761	301181376100	MERCEDES S350 (W221) 10/2005-04/2013	Suspension Control Arm and Ball Joint Assembly - Front Left Lower Forward
ARM761	301181376100	MERCEDES S400 (W221) 10/2005-04/2013	Suspension Control Arm and Ball Joint Assembly - Front Left Lower Forward
ARM761	301181376100	MERCEDES S430 (W221) 10/2005-04/2013	Suspension Control Arm and Ball Joint Assembly - Front Left Lower Forward
ARM761	301181376100	MERCEDES S450 (W221) 10/2005-04/2013	Suspension Control Arm and Ball Joint Assembly - Front Left Lower Forward
ARM761	301181376100	MERCEDES S500 (W221) 10/2005-04/2013	Suspension Control Arm and Ball Joint Assembly - Front Left Lower Forward
ARM761	301181376100	MERCEDES S550 (W221) 10/2005-04/2013	Suspension Control Arm and Ball Joint Assembly - Front Left Lower Forward
ARM761	301181376100	MERCEDES S600 (W221) 10/2005-04/2013	Suspension Control Arm and Ball Joint Assembly - Front Left Lower Forward
ARM761	301181376100	MERCEDES S63 AMG (W221) 10/2005-04/2013	Suspension Control Arm and Ball Joint Assembly - Front Left Lower Forward
ARM761	301181376100	MERCEDES S65 AMG (W221) 10/2005-04/2013	Suspension Control Arm and Ball Joint Assembly - Front Left Lower Forward
ARM762	301181376200	MERCEDES S350 (W221) 10/2005-04/2013	Suspension Control Arm and Ball Joint Assembly - Front Right Lower
ARM762	301181376200	MERCEDES S400 (W221) 10/2005-04/2013	Suspension Control Arm and Ball Joint Assembly - Front Right Lower
ARM762	301181376200	MERCEDES S430 (W221) 10/2005-04/2013	Suspension Control Arm and Ball Joint Assembly - Front Right Lower
ARM762	301181376200	MERCEDES S450 (W221) 10/2005-04/2013	Suspension Control Arm and Ball Joint Assembly - Front Right Lower
ARM762	301181376200	MERCEDES S500 (W221) 10/2005-04/2013	Suspension Control Arm and Ball Joint Assembly - Front Right Lower
ARM762	301181376200	MERCEDES S550 (W221) 10/2005-04/2013	Suspension Control Arm and Ball Joint Assembly - Front Right Lower
ARM762	301181376200	MERCEDES S600 (W221) 10/2005-04/2013	Suspension Control Arm and Ball Joint Assembly - Front Right Lower
ARM762	301181376200	MERCEDES S63 AMG (W221) 10/2005-04/2013	Suspension Control Arm and Ball Joint Assembly - Front Right Lower
ARM762	301181376200	MERCEDES S65 AMG (W221) 10/2005-04/2013	Suspension Control Arm and Ball Joint Assembly - Front Right Lower
ARM763	301181376300	MERCEDES S350 (W221) 10/2005-04/2013	Suspension Control Arm and Ball Joint Assembly - Front Left Lower
ARM763	301181376300	MERCEDES S400 (W221) 10/2005-04/2013	Suspension Control Arm and Ball Joint Assembly - Front Left Lower
ARM763	301181376300	MERCEDES S430 (W221) 10/2005-04/2013	Suspension Control Arm and Ball Joint Assembly - Front Left Lower
ARM763	301181376300	MERCEDES S450 (W221) 10/2005-04/2013	Suspension Control Arm and Ball Joint Assembly - Front Left Lower
ARM763	301181376300	MERCEDES S500 (W221) 10/2005-04/2013	Suspension Control Arm and Ball Joint Assembly - Front Left Lower





 SHORT LONG			DESCRIPTION
ARM763	301181376300	MERCEDES S550 (W221) 10/2005-04/2013	Suspension Control Arm and Ball Joint Assembly - Front Left Lower
ARM763	301181376300	MERCEDES S600 (W221) 10/2005-04/2013	Suspension Control Arm and Ball Joint Assembly - Front Left Lower
ARM763	301181376300	MERCEDES S63 AMG (W221) 10/2005-04/2013	Suspension Control Arm and Ball Joint Assembly - Front Left Lower
ARM763	301181376300	MERCEDES S65 AMG (W221) 10/2005-04/2013	Suspension Control Arm and Ball Joint Assembly - Front Left Lower
ARM764	301181376400	MERCEDES S350 (W221) AWD 10/2005-04/2013	Suspension Control Arm and Ball Joint Assembly - Front Right Lower
ARM764	301181376400	MERCEDES S450 (W221) AWD 10/2005-04/2013	Suspension Control Arm and Ball Joint Assembly - Front Right Lower
ARM764	301181376400	MERCEDES S500 (W221) AWD 10/2005-04/2013	Suspension Control Arm and Ball Joint Assembly - Front Right Lower
ARM764	301181376400	MERCEDES S550 (W221) AWD 10/2005-04/2013	Suspension Control Arm and Ball Joint Assembly - Front Right Lower
ARM765	301181376500	MERCEDES S350 (W221) AWD 10/2005-04/2013	Suspension Control Arm and Ball Joint Assembly - Front Right Lower Forward
ARM765	301181376500	MERCEDES S450 (W221) AWD 10/2005-04/2013	Suspension Control Arm and Ball Joint Assembly - Front Right Lower Forward
ARM765	301181376500	MERCEDES S500 (W221) AWD 10/2005-04/2013	Suspension Control Arm and Ball Joint Assembly - Front Right Lower Forward
ARM765	301181376500	MERCEDES S550 (W221) AWD 10/2005-04/2013	Suspension Control Arm and Ball Joint Assembly - Front Right Lower Forward
ARM766	301181376600	MERCEDES S350 (W221) 10/2005-04/2013	Suspension Control Arm and Ball Joint Assembly - Front Right Upper
ARM766	301181376600	MERCEDES S350 (W221) AWD 10/2005-04/2013	Suspension Control Arm and Ball Joint Assembly - Front Right Upper
ARM766	301181376600	MERCEDES S400 (W221) 10/2005-04/2013	Suspension Control Arm and Ball Joint Assembly - Front Right Upper
ARM766	301181376600	MERCEDES S430 (W221) 10/2005-04/2013	Suspension Control Arm and Ball Joint Assembly - Front Right Upper
ARM766	301181376600	MERCEDES S450 (W221) 10/2005-04/2013	Suspension Control Arm and Ball Joint Assembly - Front Right Upper
ARM766	301181376600	MERCEDES S450 (W221) AWD 10/2005-04/2013	Suspension Control Arm and Ball Joint Assembly - Front Right Upper
ARM766	301181376600	MERCEDES S500 (W221) 10/2005-04/2013	Suspension Control Arm and Ball Joint Assembly - Front Right Upper
ARM766	301181376600	MERCEDES S500 (W221) AWD 10/2005-04/2013	Suspension Control Arm and Ball Joint Assembly - Front Right Upper
ARM766	301181376600	MERCEDES S550 (W221) 10/2005-04/2013	Suspension Control Arm and Ball Joint Assembly - Front Right Upper
ARM766	301181376600	MERCEDES S550 (W221) AWD 10/2005-04/2013	Suspension Control Arm and Ball Joint Assembly - Front Right Upper
ARM766	301181376600	MERCEDES S600 (W221) 10/2005-04/2013	Suspension Control Arm and Ball Joint Assembly - Front Right Upper
ARM766	301181376600	MERCEDES S63 AMG (W221) 10/2005-04/2013	Suspension Control Arm and Ball Joint Assembly - Front Right Upper
ARM766	301181376600	MERCEDES S65 AMG (W221) 10/2005-04/2013	Suspension Control Arm and Ball Joint Assembly - Front Right Upper



			DESCRIPTION
SHORT	LONG		
ARM767	301181376700	MERCEDES S350 (W221) 10/2005-04/2013	Suspension Control Arm and Ball Joint Assembly - Front Left Upper
ARM767	301181376700	MERCEDES S350 (W221) AWD 10/2005-04/2013	Suspension Control Arm and Ball Joint Assembly - Front Left Upper
ARM767	301181376700	MERCEDES S400 (W221) 10/2005-04/2013	Suspension Control Arm and Ball Joint Assembly - Front Left Upper
ARM767	301181376700	MERCEDES S430 (W221) 10/2005-04/2013	Suspension Control Arm and Ball Joint Assembly - Front Left Upper
ARM767	301181376700	MERCEDES S450 (W221) 10/2005-04/2013	Suspension Control Arm and Ball Joint Assembly - Front Left Upper
ARM767	301181376700	MERCEDES S450 (W221) AWD 10/2005-04/2013	Suspension Control Arm and Ball Joint Assembly - Front Left Upper
ARM767	301181376700	MERCEDES S500 (W221) 10/2005-04/2013	Suspension Control Arm and Ball Joint Assembly - Front Left Upper
ARM767	301181376700	MERCEDES S500 (W221) AWD 10/2005-04/2013	Suspension Control Arm and Ball Joint Assembly - Front Left Upper
ARM767	301181376700	MERCEDES S550 (W221) 10/2005-04/2013	Suspension Control Arm and Ball Joint Assembly - Front Left Upper
ARM767	301181376700	MERCEDES S550 (W221) AWD 10/2005-04/2013	Suspension Control Arm and Ball Joint Assembly - Front Left Upper
ARM767	301181376700	MERCEDES S600 (W221) 10/2005-04/2013	Suspension Control Arm and Ball Joint Assembly - Front Left Upper
ARM767	301181376700	MERCEDES S63 AMG (W221) 10/2005-04/2013	Suspension Control Arm and Ball Joint Assembly - Front Left Upper
ARM767	301181376700	MERCEDES S65 AMG (W221) 10/2005-04/2013	Suspension Control Arm and Ball Joint Assembly - Front Left Upper
ARM768	301181376800	MERCEDES S350 (W221) AWD 10/2005-04/2013	Suspension Control Arm and Ball Joint Assembly - Front Right
ARM768	301181376800	MERCEDES S450 (W221) AWD 10/2005-04/2013	Suspension Control Arm and Ball Joint Assembly - Front Right
ARM768	301181376800	MERCEDES S500 (W221) AWD 10/2005-04/2013	Suspension Control Arm and Ball Joint Assembly - Front Right
ARM768	301181376800	MERCEDES S550 (W221) AWD 10/2005-04/2013	Suspension Control Arm and Ball Joint Assembly - Front Right
ARM769	301181376900	MERCEDES S350 (W221) AWD 10/2005-04/2013	Suspension Control Arm and Ball Joint Assembly - Front Left
ARM769	301181376900	MERCEDES S450 (W221) AWD 10/2005-04/2013	Suspension Control Arm and Ball Joint Assembly - Front Left
ARM769	301181376900	MERCEDES S500 (W221) AWD 10/2005-04/2013	Suspension Control Arm and Ball Joint Assembly - Front Left
ARM769	301181376900	MERCEDES S550 (W221) AWD 10/2005-04/2013	Suspension Control Arm and Ball Joint Assembly - Front Left
ARM770	301181377000	MERCEDES S350 (W221) 10/2005-04/2013	Suspension Control Arm and Ball Joint Assembly - Front Right
ARM770	301181377000	MERCEDES S400 (W221) 10/2005-04/2013	Suspension Control Arm and Ball Joint Assembly - Front Right
ARM770	301181377000	MERCEDES S430 (W221) 10/2005-04/2013	Suspension Control Arm and Ball Joint Assembly - Front Right
ARM770	301181377000	MERCEDES S450 (W221) 10/2005-04/2013	Suspension Control Arm and Ball Joint Assembly - Front Right





 SHORT LONG			DESCRIPTION
ARM770	301181377000	MERCEDES S500 (W221) 10/2005-04/2013	Suspension Control Arm and Ball Joint Assembly - Front Right
ARM770	301181377000	MERCEDES S550 (W221) 10/2005-04/2013	Suspension Control Arm and Ball Joint Assembly - Front Right
ARM770	301181377000	MERCEDES S600 (W221) 10/2005-04/2013	Suspension Control Arm and Ball Joint Assembly - Front Right
ARM770	301181377000	MERCEDES S63 AMG (W221) 10/2005-04/2013	Suspension Control Arm and Ball Joint Assembly - Front Right
ARM770	301181377000	MERCEDES S65 AMG (W221) 10/2005-04/2013	Suspension Control Arm and Ball Joint Assembly - Front Right
ARM771	301181377100	MERCEDES S350 (W221) 10/2005-04/2013	Suspension Control Arm and Ball Joint Assembly - Front Left
ARM771	301181377100	MERCEDES S400 (W221) 10/2005-04/2013	Suspension Control Arm and Ball Joint Assembly - Front Left
ARM771	301181377100	MERCEDES S430 (W221) 10/2005-04/2013	Suspension Control Arm and Ball Joint Assembly - Front Left
ARM771	301181377100	MERCEDES S450 (W221) 10/2005-04/2013	Suspension Control Arm and Ball Joint Assembly - Front Left
ARM771	301181377100	MERCEDES S500 (W221) 10/2005-04/2013	Suspension Control Arm and Ball Joint Assembly - Front Left
ARM771	301181377100	MERCEDES S550 (W221) 10/2005-04/2013	Suspension Control Arm and Ball Joint Assembly - Front Left
ARM771	301181377100	MERCEDES S600 (W221) 10/2005-04/2013	Suspension Control Arm and Ball Joint Assembly - Front Left
ARM771	301181377100	MERCEDES S63 AMG (W221) 10/2005-04/2013	Suspension Control Arm and Ball Joint Assembly - Front Left
ARM771	301181377100	MERCEDES S65 AMG (W221) 10/2005-04/2013	Suspension Control Arm and Ball Joint Assembly - Front Left
ARM772	301181377200	MERCEDES S350 (W221) 10/2005-04/2013	Lateral Arm - Rear Right Lower Rearward
ARM772	301181377200	MERCEDES S400 (W221) 10/2005-04/2013	Lateral Arm - Rear Right Lower Rearward
ARM772	301181377200	MERCEDES S430 (W221) 10/2005-04/2013	Lateral Arm - Rear Right Lower Rearward
ARM772	301181377200	MERCEDES S450 (W221) 10/2005-04/2013	Lateral Arm - Rear Right Lower Rearward
ARM772	301181377200	MERCEDES S500 (W221) 10/2005-04/2013	Lateral Arm - Rear Right Lower Rearward
ARM772	301181377200	MERCEDES S550 (W221) 10/2005-04/2013	Lateral Arm - Rear Right Lower Rearward
ARM772	301181377200	MERCEDES S600 (W221) 10/2005-04/2013	Lateral Arm - Rear Right Lower Rearward
ARM772	301181377200	MERCEDES S63 AMG (W221) 10/2005-04/2013	Lateral Arm - Rear Right Lower Rearward
ARM772	301181377200	MERCEDES S65 AMG (W221) 10/2005-04/2013	Lateral Arm - Rear Right Lower Rearward
ARM773	301181377300	MERCEDES S350 (W221) 10/2005-04/2013	Lateral Arm - Rear Left Lower Rearward
ARM773	301181377300	MERCEDES S400 (W221) 10/2005-04/2013	Lateral Arm - Rear Left Lower Rearward
ARM773	301181377300	MERCEDES S430 (W221) 10/2005-04/2013	Lateral Arm - Rear Left Lower Rearward
ARM773	301181377300	MERCEDES S450 (W221) 10/2005-04/2013	Lateral Arm - Rear Left Lower Rearward
ARM773	301181377300	MERCEDES S500 (W221) 10/2005-04/2013	Lateral Arm - Rear Left Lower Rearward
ARM773	301181377300	MERCEDES S550 (W221) 10/2005-04/2013	Lateral Arm - Rear Left Lower Rearward
ARM773	301181377300	MERCEDES S600 (W221) 10/2005-04/2013	Lateral Arm - Rear Left Lower Rearward
ARM773	301181377300	MERCEDES S63 AMG (W221) 10/2005-04/2013	Lateral Arm - Rear Left Lower Rearward



			DESCRIPTION
SHORT	LONG		
ARM773	301181377300	MERCEDES S65 AMG (W221) 10/2005-04/2013	Lateral Arm - Rear Left Lower Rearward
ARM774	301181377400	MERCEDES S350 (W221) 10/2005-04/2013	Lateral Arm - Rear Right Lower
ARM774	301181377400	MERCEDES S400 (W221) 10/2005-04/2013	Lateral Arm - Rear Right Lower
ARM774	301181377400	MERCEDES S430 (W221) 10/2005-04/2013	Lateral Arm - Rear Right Lower
ARM774	301181377400	MERCEDES S450 (W221) 10/2005-04/2013	Lateral Arm - Rear Right Lower
ARM774	301181377400	MERCEDES S500 (W221) 10/2005-04/2013	Lateral Arm - Rear Right Lower
ARM774	301181377400	MERCEDES S550 (W221) 10/2005-04/2013	Lateral Arm - Rear Right Lower
ARM774	301181377400	MERCEDES S600 (W221) 10/2005-04/2013	Lateral Arm - Rear Right Lower
ARM774	301181377400	MERCEDES S63 AMG (W221) 10/2005-04/2013	Lateral Arm - Rear Right Lower
ARM774	301181377400	MERCEDES S65 AMG (W221) 10/2005-04/2013	Lateral Arm - Rear Right Lower
ARM775	301181377500	MERCEDES S350 (W221) 10/2005-04/2013	Lateral Arm - Rear Left Lower Forward
ARM775	301181377500	MERCEDES S400 (W221) 10/2005-04/2013	Lateral Arm - Rear Left Lower Forward
ARM775	301181377500	MERCEDES S430 (W221) 10/2005-04/2013	Lateral Arm - Rear Left Lower Forward
ARM775	301181377500	MERCEDES S450 (W221) 10/2005-04/2013	Lateral Arm - Rear Left Lower Forward
ARM775	301181377500	MERCEDES S500 (W221) 10/2005-04/2013	Lateral Arm - Rear Left Lower Forward
ARM775	301181377500	MERCEDES S550 (W221) 10/2005-04/2013	Lateral Arm - Rear Left Lower Forward
ARM775	301181377500	MERCEDES S600 (W221) 10/2005-04/2013	Lateral Arm - Rear Left Lower Forward
ARM775	301181377500	MERCEDES S63 AMG (W221) 10/2005-04/2013	Lateral Arm - Rear Left Lower Forward
ARM775	301181377500	MERCEDES S65 AMG (W221) 10/2005-04/2013	Lateral Arm - Rear Left Lower Forward
ARM776	301181377600	MERCEDES S350 (W221) 10/2005-04/2013	Lateral Arm - Rear Right Upper Forward
ARM776	301181377600	MERCEDES S400 (W221) 10/2005-04/2013	Lateral Arm - Rear Right Upper Forward
ARM776	301181377600	MERCEDES S430 (W221) 10/2005-04/2013	Lateral Arm - Rear Right Upper Forward
ARM776	301181377600	MERCEDES S450 (W221) 10/2005-04/2013	Lateral Arm - Rear Right Upper Forward
ARM776	301181377600	MERCEDES S500 (W221) 10/2005-04/2013	Lateral Arm - Rear Right Upper Forward
ARM776	301181377600	MERCEDES S550 (W221) 10/2005-04/2013	Lateral Arm - Rear Right Upper Forward
ARM776	301181377600	MERCEDES S600 (W221) 10/2005-04/2013	Lateral Arm - Rear Right Upper Forward
ARM776	301181377600	MERCEDES S63 AMG (W221) 10/2005-04/2013	Lateral Arm - Rear Right Upper Forward
ARM776	301181377600	MERCEDES S65 AMG (W221) 10/2005-04/2013	Lateral Arm - Rear Right Upper Forward
ARM777	301181377700	MERCEDES S350 (W221) 10/2005-04/2013	Lateral Arm - Rear Left Upper Forward
ARM777	301181377700	MERCEDES S400 (W221) 10/2005-04/2013	Lateral Arm - Rear Left Upper Forward
ARM777	301181377700	MERCEDES S430 (W221) 10/2005-04/2013	Lateral Arm - Rear Left Upper Forward
ARM777	301181377700	MERCEDES S450 (W221) 10/2005-04/2013	Lateral Arm - Rear Left Upper Forward
ARM777	301181377700	MERCEDES S500 (W221) 10/2005-04/2013	Lateral Arm - Rear Left Upper Forward
ARM777	301181377700	MERCEDES S550 (W221) 10/2005-04/2013	Lateral Arm - Rear Left Upper Forward
ARM777	301181377700	MERCEDES S600 (W221) 10/2005-04/2013	Lateral Arm - Rear Left Upper Forward
ARM777	301181377700	MERCEDES S63 AMG (W221) 10/2005-04/2013	Lateral Arm - Rear Left Upper Forward





 SHORT LONG			DESCRIPTION
ARM777	301181377700	MERCEDES S65 AMG (W221) 10/2005-04/2013	Lateral Arm - Rear Left Upper Forward
ARM778	301181377800	MERCEDES S350 (W221) 10/2005-04/2013	Lateral Arm - Rear Right Upper Rearward
ARM778	301181377800	MERCEDES S400 (W221) 10/2005-04/2013	Lateral Arm - Rear Right Upper Rearward
ARM778	301181377800	MERCEDES S430 (W221) 10/2005-04/2013	Lateral Arm - Rear Right Upper Rearward
ARM778	301181377800	MERCEDES S450 (W221) 10/2005-04/2013	Lateral Arm - Rear Right Upper Rearward
ARM778	301181377800	MERCEDES S500 (W221) 10/2005-04/2013	Lateral Arm - Rear Right Upper Rearward
ARM778	301181377800	MERCEDES S550 (W221) 10/2005-04/2013	Lateral Arm - Rear Right Upper Rearward
ARM778	301181377800	MERCEDES S600 (W221) 10/2005-04/2013	Lateral Arm - Rear Right Upper Rearward
ARM778	301181377800	MERCEDES S63 AMG (W221) 10/2005-04/2013	Lateral Arm - Rear Right Upper Rearward
ARM778	301181377800	MERCEDES S65 AMG (W221) 10/2005-04/2013	Lateral Arm - Rear Right Upper Rearward
ARM779	301181377900	MERCEDES S350 (W221) 10/2005-04/2013	Lateral Arm - Rear Left Upper Rearward
ARM779	301181377900	MERCEDES S400 (W221) 10/2005-04/2013	Lateral Arm - Rear Left Upper Rearward
ARM779	301181377900	MERCEDES S430 (W221) 10/2005-04/2013	Lateral Arm - Rear Left Upper Rearward
ARM779	301181377900	MERCEDES S450 (W221) 10/2005-04/2013	Lateral Arm - Rear Left Upper Rearward
ARM779	301181377900	MERCEDES S500 (W221) 10/2005-04/2013	Lateral Arm - Rear Left Upper Rearward
ARM779	301181377900	MERCEDES S550 (W221) 10/2005-04/2013	Lateral Arm - Rear Left Upper Rearward
ARM779	301181377900	MERCEDES S600 (W221) 10/2005-04/2013	Lateral Arm - Rear Left Upper Rearward
ARM779	301181377900	MERCEDES S63 AMG (W221) 10/2005-04/2013	Lateral Arm - Rear Left Upper Rearward
ARM779	301181377900	MERCEDES S65 AMG (W221) 10/2005-04/2013	Lateral Arm - Rear Left Upper Rearward
ARM780	301181378000	MERCEDES GLA180 (X156) 12/2013-	Lateral Arm - Rear Right Upper
ARM780	301181378000	MERCEDES GLA200 (X156) 12/2013-	Lateral Arm - Rear Right Upper
ARM780	301181378000	MERCEDES GLA250 (X156) 12/2013-	Lateral Arm - Rear Right Upper
ARM780	301181378000	MERCEDES GLA45 AMG (X156) 12/2013-	Lateral Arm - Rear Right Upper
ARM781	301181378100	MERCEDES GLA180 (X156) 12/2013-	Lateral Arm - Rear Left Upper
ARM781	301181378100	MERCEDES GLA200 (X156) 12/2013-	Lateral Arm - Rear Left Upper
ARM781	301181378100	MERCEDES GLA250 (X156) 12/2013-	Lateral Arm - Rear Left Upper
ARM781	301181378100	MERCEDES GLA45 AMG (X156) 12/2013-	Lateral Arm - Rear Left Upper
ARM782	301181378200	MERCEDES S350 (W221) 10/2005-04/2013	Suspension Control Arm and Ball Joint Assembly - Front Right
ARM782	301181378200	MERCEDES S400 (W221) 10/2005-04/2013	Suspension Control Arm and Ball Joint Assembly - Front Right
ARM782	301181378200	MERCEDES S430 (W221) 10/2005-04/2013	Suspension Control Arm and Ball Joint Assembly - Front Right
ARM782	301181378200	MERCEDES S450 (W221) 10/2005-04/2013	Suspension Control Arm and Ball Joint Assembly - Front Right
ARM782	301181378200	MERCEDES S500 (W221) 10/2005-04/2013	Suspension Control Arm and Ball Joint Assembly - Front Right
ARM782	301181378200	MERCEDES S550 (W221) 10/2005-04/2013	Suspension Control Arm and Ball Joint Assembly - Front Right
ARM782	301181378200	MERCEDES S600 (W221) 10/2005-04/2013	Suspension Control Arm and Ball Joint Assembly - Front Right



			DESCRIPTION
SHORT	LONG		
ARM782	301181378200	MERCEDES S63 AMG (W221) 10/2005-04/2013	Suspension Control Arm and Ball Joint Assembly - Front Right
ARM782	301181378200	MERCEDES S65 AMG (W221) 10/2005-04/2013	Suspension Control Arm and Ball Joint Assembly - Front Right
ARM783	301181378300	MERCEDES S350 (W221) 10/2005-04/2013	Suspension Control Arm and Ball Joint Assembly - Front Left
ARM783	301181378300	MERCEDES S400 (W221) 10/2005-04/2013	Suspension Control Arm and Ball Joint Assembly - Front Left
ARM783	301181378300	MERCEDES S430 (W221) 10/2005-04/2013	Suspension Control Arm and Ball Joint Assembly - Front Left
ARM783	301181378300	MERCEDES S450 (W221) 10/2005-04/2013	Suspension Control Arm and Ball Joint Assembly - Front Left
ARM783	301181378300	MERCEDES S500 (W221) 10/2005-04/2013	Suspension Control Arm and Ball Joint Assembly - Front Left
ARM783	301181378300	MERCEDES S550 (W221) 10/2005-04/2013	Suspension Control Arm and Ball Joint Assembly - Front Left
ARM783	301181378300	MERCEDES S600 (W221) 10/2005-04/2013	Suspension Control Arm and Ball Joint Assembly - Front Left
ARM783	301181378300	MERCEDES S63 AMG (W221) 10/2005-04/2013	Suspension Control Arm and Ball Joint Assembly - Front Left
ARM783	301181378300	MERCEDES S65 AMG (W221) 10/2005-04/2013	Suspension Control Arm and Ball Joint Assembly - Front Left
ARM784	301181378400	MERCEDES GLA180 (X156) 12/2013-	Suspension Control Arm and Ball Joint Assembly - Front Right
ARM784	301181378400	MERCEDES GLA200 (X156) 12/2013-	Suspension Control Arm and Ball Joint Assembly - Front Right
ARM784	301181378400	MERCEDES GLA250 (X156) 12/2013-	Suspension Control Arm and Ball Joint Assembly - Front Right
ARM784	301181378400	MERCEDES GLA45 AMG (X156) 12/2013-	Suspension Control Arm and Ball Joint Assembly - Front Right
ARM785	301181378500	MERCEDES GLA180 (X156) 12/2013-	Suspension Control Arm and Ball Joint Assembly - Front Left
ARM785	301181378500	MERCEDES GLA200 (X156) 12/2013-	Suspension Control Arm and Ball Joint Assembly - Front Left
ARM785	301181378500	MERCEDES GLA250 (X156) 12/2013-	Suspension Control Arm and Ball Joint Assembly - Front Left
ARM785	301181378500	MERCEDES GLA45 AMG (X156) 12/2013-	Suspension Control Arm and Ball Joint Assembly - Front Left
ARM786	301181378600	MERCEDES C180 (W205) RWD 12/2013-	Suspension Control Arm and Ball Joint Assembly - Front Right Upper
ARM786	301181378600	MERCEDES C200 (W205) RWD 12/2013-	Suspension Control Arm and Ball Joint Assembly - Front Right Upper
ARM786	301181378600	MERCEDES C250 (W205) RWD 12/2013-	Suspension Control Arm and Ball Joint Assembly - Front Right Upper
ARM786	301181378600	MERCEDES C300 (W205) RWD 12/2013-	Suspension Control Arm and Ball Joint Assembly - Front Right Upper
ARM786	301181378600	MERCEDES C350 (W205) RWD 12/2013-	Suspension Control Arm and Ball Joint Assembly - Front Right Upper
ARM786	301181378600	MERCEDES C63 AMG (W205) RWD 12/2013-	Suspension Control Arm and Ball Joint Assembly - Front Right Upper





 SHORT LONG			DESCRIPTION
ARM786	301181378600	MERCEDES C63 AMG S (W205) RWD 12/2013-	Suspension Control Arm and Ball Joint Assembly - Front Right Upper
ARM787	301181378700	MERCEDES C180 (W205) RWD 12/2013-	Suspension Control Arm and Ball Joint Assembly - Front Left Upper
ARM787	301181378700	MERCEDES C200 (W205) RWD 12/2013-	Suspension Control Arm and Ball Joint Assembly - Front Left Upper
ARM787	301181378700	MERCEDES C250 (W205) RWD 12/2013-	Suspension Control Arm and Ball Joint Assembly - Front Left Upper
ARM787	301181378700	MERCEDES C300 (W205) RWD 12/2013-	Suspension Control Arm and Ball Joint Assembly - Front Left Upper
ARM787	301181378700	MERCEDES C350 (W205) RWD 12/2013-	Suspension Control Arm and Ball Joint Assembly - Front Left Upper
ARM787	301181378700	MERCEDES C63 AMG (W205) RWD 12/2013-	Suspension Control Arm and Ball Joint Assembly - Front Left Upper
ARM787	301181378700	MERCEDES C63 AMG S (W205) RWD 12/2013-	Suspension Control Arm and Ball Joint Assembly - Front Left Upper
ARM788	301181378800	MERCEDES C180 (W205) RWD 12/2013-	Suspension Control Arm and Ball Joint Assembly - Front Right Lower Forward
ARM788	301181378800	MERCEDES C200 (W205) RWD 12/2013-	Suspension Control Arm and Ball Joint Assembly - Front Right Lower Forward
ARM788	301181378800	MERCEDES C250 (W205) RWD 12/2013-	Suspension Control Arm and Ball Joint Assembly - Front Right Lower Forward
ARM788	301181378800	MERCEDES C300 (W205) RWD 12/2013-	Suspension Control Arm and Ball Joint Assembly - Front Right Lower Forward
ARM788	301181378800	MERCEDES C350 (W205) RWD 12/2013-	Suspension Control Arm and Ball Joint Assembly - Front Right Lower Forward
ARM788	301181378800	MERCEDES C63 AMG (W205) RWD 12/2013-	Suspension Control Arm and Ball Joint Assembly - Front Right Lower Forward
ARM788	301181378800	MERCEDES C63 AMG S (W205) RWD 12/2013-	Suspension Control Arm and Ball Joint Assembly - Front Right Lower Forward
ARM789	301181378900	MERCEDES C180 (W205) RWD 12/2013-	Suspension Control Arm and Ball Joint Assembly - Front Left Lower Forward
ARM789	301181378900	MERCEDES C200 (W205) RWD 12/2013-	Suspension Control Arm and Ball Joint Assembly - Front Left Lower Forward
ARM789	301181378900	MERCEDES C250 (W205) RWD 12/2013-	Suspension Control Arm and Ball Joint Assembly - Front Left Lower Forward
ARM789	301181378900	MERCEDES C300 (W205) RWD 12/2013-	Suspension Control Arm and Ball Joint Assembly - Front Left Lower Forward
ARM789	301181378900	MERCEDES C350 (W205) RWD 12/2013-	Suspension Control Arm and Ball Joint Assembly - Front Left Lower Forward
ARM789	301181378900	MERCEDES C63 AMG (W205) RWD 12/2013-	Suspension Control Arm and Ball Joint Assembly - Front Left Lower Forward
ARM789	301181378900	MERCEDES C63 AMG S (W205) RWD 12/2013-	Suspension Control Arm and Ball Joint Assembly - Front Left Lower Forward
ARM790	301181379000	MERCEDES C180 (W205) 12/2013-	Suspension Control Arm and Ball Joint Assembly - Front Right Lower Rearward
ARM790	301181379000	MERCEDES C200 (W205) 12/2013-	Suspension Control Arm and Ball Joint Assembly - Front Right Lower Rearward
ARM790	301181379000	MERCEDES C250 (W205) 12/2013-	Suspension Control Arm and Ball Joint Assembly - Front Right Lower Rearward



			DESCRIPTION
SHORT	LONG		
ARM790	301181379000	MERCEDES C300 (W205) 12/2013-	Suspension Control Arm and Ball Joint Assembly - Front Right Lower Rearward
ARM790	301181379000	MERCEDES C350 (W205) 12/2013-	Suspension Control Arm and Ball Joint Assembly - Front Right Lower Rearward
ARM790	301181379000	MERCEDES C63 AMG (W205) 12/2013-	Suspension Control Arm and Ball Joint Assembly - Front Right Lower Rearward
ARM790	301181379000	MERCEDES C63 AMG S (W205) 12/2013-	Suspension Control Arm and Ball Joint Assembly - Front Right Lower Rearward
ARM791	301181379100	MERCEDES C180 (W205) 12/2013-	Suspension Control Arm and Ball Joint Assembly - Front Left Lower Rearward
ARM791	301181379100	MERCEDES C200 (W205) 12/2013-	Suspension Control Arm and Ball Joint Assembly - Front Left Lower Rearward
ARM791	301181379100	MERCEDES C250 (W205) 12/2013-	Suspension Control Arm and Ball Joint Assembly - Front Left Lower Rearward
ARM791	301181379100	MERCEDES C300 (W205) 12/2013-	Suspension Control Arm and Ball Joint Assembly - Front Left Lower Rearward
ARM791	301181379100	MERCEDES C350 (W205) 12/2013-	Suspension Control Arm and Ball Joint Assembly - Front Left Lower Rearward
ARM791	301181379100	MERCEDES C63 AMG (W205) 12/2013-	Suspension Control Arm and Ball Joint Assembly - Front Left Lower Rearward
ARM791	301181379100	MERCEDES C63 AMG S (W205) 12/2013-	Suspension Control Arm and Ball Joint Assembly - Front Left Lower Rearward
ARM792	301181379200	MERCEDES S320 (W220) 1999-2005	Suspension Control Arm - Front Lower Rearward
ARM792	301181379200	MERCEDES S350 (W220) 1999-2005	Suspension Control Arm - Front Lower Rearward
ARM792	301181379200	MERCEDES S500 (W220) 1999-2005	Suspension Control Arm - Front Lower Rearward
ARM793	301181379300	MAZDA 3 BK 10/2003-06/2009	Suspension Control Arm and Ball Joint Assembly - Front Right Lower
ARM793	301181379300	MAZDA 5 CR19, 2nd Gen 03/2005-08/2010	Suspension Control Arm and Ball Joint Assembly - Front Right Lower
ARM794	301181379400	MAZDA 3 BK 10/2003-06/2009	Suspension Control Arm and Ball Joint Assembly - Front Left Lower
ARM794	301181379400	MAZDA 5 CR19, 2nd Gen 03/2005-08/2010	Suspension Control Arm and Ball Joint Assembly - Front Left Lower
ARM795	301181379500	MAZDA 3 BL 07/2009-11/2014	Suspension Control Arm and Ball Joint Assembly - Front Right Lower
ARM796	301181379600	MAZDA 3 BL 07/2009-11/2014	Suspension Control Arm and Ball Joint Assembly - Front Left Lower
ARM797	301181379700	MAZDA 3 BM 12/2014-	Lateral Arm - Rear
ARM798	301181379800	MAZDA 3 BM 12/2014-	Lateral Arm - Rear Right
ARM799	301181379900	MAZDA 3 BM 12/2014-	Lateral Arm - Rear Left
ARM800	301181380000	MAZDA 3 BM 12/2014-	Suspension Control Arm and Ball Joint Assembly - Front Right Lower
ARM801	301181380100	MAZDA 3 BM 12/2014-	Suspension Control Arm and Ball Joint Assembly - Front Left Lower
ARM802	301181380200	MAZDA CX-7 ER 2007-	Suspension Control Arm and Ball Joint Assembly - Front Right Lower
ARM803	301181380300	MAZDA CX-7 ER 2007-	Suspension Control Arm and Ball Joint Assembly - Front Left Lower





 SHORT LONG			DESCRIPTION
ARM804	301181380400	MAZDA 6 GG 06/2002-07/2007	Suspension Control Arm and Ball Joint Assembly - Front Right Upper
ARM805	301181380500	MAZDA 6 GG 06/2002-07/2007	Suspension Control Arm and Ball Joint Assembly - Front Left Upper
ARM806	301181380600	MAZDA 6 GG 06/2002-07/2007	Suspension Control Arm and Ball Joint Assembly - Front Lower
ARM807	301181380700	MAZDA 6 GG 06/2002-07/2007	Lateral Arm - Rear
ARM808	301181380800	MAZDA 6 GH 08/2007-12/2012	Suspension Control Arm and Ball Joint Assembly - Front Right Lower
ARM809	301181380900	MAZDA 6 GH 08/2007-12/2012	Suspension Control Arm and Ball Joint Assembly - Front Left Lower
ARM810	301181381000	MAZDA 6 GH 08/2007-12/2012	Suspension Control Arm and Ball Joint Assembly - Front Right Upper
ARM811	301181381100	MAZDA 6 GH 08/2007-12/2012	Suspension Control Arm and Ball Joint Assembly - Front Left Upper
ARM812	301181381200	MAZDA 6 GJ 2013-	Suspension Control Arm and Ball Joint Assembly - Front Right Lower
ARM812	301181381200	MAZDA CX-5 KE 11/2011-	Suspension Control Arm and Ball Joint Assembly - Front Right Lower
ARM813	301181381300	MAZDA 6 GJ 2013-	Suspension Control Arm and Ball Joint Assembly - Front Left Lower
ARM813	301181381300	MAZDA CX-5 KE 11/2011-	Suspension Control Arm and Ball Joint Assembly - Front Left Lower
ARM814	301181381400	MAZDA CX-9 2007-	Suspension Control Arm and Ball Joint Assembly - Front Right Lower
ARM815	301181381500	MAZDA CX-9 2007-	Suspension Control Arm and Ball Joint Assembly - Front Left Lower
ARM816	301181381600	MINIBUS LANCER (CS, A) 09/2003-07/2008	Suspension Control Arm and Ball Joint Assembly - Front Right Lower
ARM817	301181381700	MINIBUS LANCER (CS, A) 09/2003-07/2008	Suspension Control Arm and Ball Joint Assembly - Front Left Lower
ARM818	301181381800	MINIBUS LANCER (CY2A-CZ4A) 06/2008-	Lateral Arm - Rear Forward
ARM819	301181381900	MINIBUS LANCER (CY2A-CZ4A) 06/2008-	Lateral Arm - Rear Upper
ARM820	301181382000	MINIBUS ASX (GA,W) 02/2010-	Lateral Arm - Rear Lower
ARM820	301181382000	MINIBUS LANCER (CY2A-CZ4A) 06/2008-	Lateral Arm - Rear Lower
ARM820	301181382000	MINIBUS OUTLANDER II 11/2006-07/2012	Lateral Arm - Rear Lower
ARM820	301181382000	MINIBUS Outlander Sport (GA,W) 02/2010-	Lateral Arm - Rear Lower
ARM821	301181382100	MINIBUS ASX (GA,W) 02/2010-	Suspension Control Arm and Ball Joint Assembly - Front Right Lower
ARM821	301181382100	MINIBUS LANCER (CY2A-CZ4A) 06/2008-	Suspension Control Arm and Ball Joint Assembly - Front Right Lower
ARM821	301181382100	MINIBUS OUTLANDER II 11/2006-07/2012	Suspension Control Arm and Ball Joint Assembly - Front Right Lower
ARM821	301181382100	MINIBUS OUTLANDER III 2012-	Suspension Control Arm and Ball Joint Assembly - Front Right Lower
ARM821	301181382100	MINIBUS Outlander Sport (GA,W) 02/2010-	Suspension Control Arm and Ball Joint Assembly - Front Right Lower
ARM821	301181382100	PEUGEOT 4007 02/2007-	Suspension Control Arm and Ball Joint Assembly - Front Right Lower



			DESCRIPTION
SHORT	LONG		
ARM822	301181382200	mitsubishi ASX (GA,W) 02/2010-	Suspension Control Arm and Ball Joint Assembly - Front Left Lower
ARM822	301181382200	mitsubishi LANCER (CY2A-CZ4A) 06/2008-	Suspension Control Arm and Ball Joint Assembly - Front Left Lower
ARM822	301181382200	mitsubishi OUTLANDER II 11/2006-07/2012	Suspension Control Arm and Ball Joint Assembly - Front Left Lower
ARM822	301181382200	mitsubishi OUTLANDER III 2012-	Suspension Control Arm and Ball Joint Assembly - Front Left Lower
ARM822	301181382200	mitsubishi Outlander Sport (GA,W) 02/2010-	Suspension Control Arm and Ball Joint Assembly - Front Left Lower
ARM822	301181382200	PEUGEOT 4007 02/2007-	Suspension Control Arm and Ball Joint Assembly - Front Left Lower
ARM823	301181382300	mitsubishi MONTERO III 04/2000-01/2007	Suspension Control Arm and Ball Joint Assembly - Front Right Upper
ARM823	301181382300	mitsubishi MONTERO IV 02/2007-	Suspension Control Arm and Ball Joint Assembly - Front Right Upper
ARM823	301181382300	mitsubishi PAJERO IV 02/2007-	Suspension Control Arm and Ball Joint Assembly - Front Right Upper
ARM824	301181382400	mitsubishi MONTERO III 04/2000-01/2007	Suspension Control Arm and Ball Joint Assembly - Front Left Upper
ARM824	301181382400	mitsubishi MONTERO IV 02/2007-	Suspension Control Arm and Ball Joint Assembly - Front Left Upper
ARM824	301181382400	mitsubishi PAJERO IV 02/2007-	Suspension Control Arm and Ball Joint Assembly - Front Left Upper
ARM825	301181382500	mitsubishi COLT VI 10/2002-06/2012	Suspension Control Arm and Ball Joint Assembly - Front Right Lower
ARM825	301181382500	SMART FORFOUR 454 06/2004-10/2012	Suspension Control Arm and Ball Joint Assembly - Front Right Lower
ARM826	301181382600	mitsubishi COLT VI 10/2002-06/2012	Suspension Control Arm and Ball Joint Assembly - Front Left Lower
ARM826	301181382600	SMART FORFOUR 454 06/2004-10/2012	Suspension Control Arm and Ball Joint Assembly - Front Left Lower
ARM827	301181382700	mitsubishi CARISMA 09/2000-06/2006	Suspension Control Arm and Ball Joint Assembly - Front Right Lower
ARM828	301181382800	mitsubishi CARISMA 09/2000-06/2006	Suspension Control Arm and Ball Joint Assembly - Front Left Lower
ARM829	301181382900	MINI Cooper (R50, R53) 05/2001-09/2006	Suspension Control Arm Kit - Front Right
ARM829	301181382900	MINI Cooper (R52) 07/2004-11/2007	Suspension Control Arm Kit - Front Right
ARM830	301181383000	MINI Cooper (R50, R53) 05/2001-09/2006	Suspension Control Arm Kit - Front Left
ARM830	301181383000	MINI Cooper (R52) 07/2004-11/2007	Suspension Control Arm Kit - Front Left
ARM831	301181383100	MINI Cooper (R55, R56) 09/2006-05/2010	Suspension Control Arm Kit - Front Right
ARM832	301181383200	MINI Cooper (R55, R56) 09/2006-05/2010	Suspension Control Arm Kit - Front Left Lower
ARM833	301181383300	MINI Cooper Countryman (R60) 06/2010-12/2014	Suspension Control Arm and Ball Joint Assembly - Front Right
ARM834	301181383400	MINI Cooper Countryman (R60) 06/2010-12/2014	Suspension Control Arm and Ball Joint Assembly - Front Left
ARM835	301181383500	NISSAN ALMERA (N15) 07/1995-06/2000	Suspension Control Arm and Ball Joint Assembly - Front Right Lower
ARM835	301181383500	NISSAN SENTRA (B14) 1995-1999	Suspension Control Arm and Ball Joint Assembly - Front Right Lower





 SHORT LONG			DESCRIPTION
ARM835	301181383500	NISSAN SUNNY (B14) 1995-1999	Suspension Control Arm and Ball Joint Assembly - Front Right Lower
ARM836	301181383600	NISSAN ALMERA (N15) 07/1995-06/2000	Suspension Control Arm and Ball Joint Assembly - Front Left Lower
ARM836	301181383600	NISSAN SENTRA (B14) 1995-1999	Suspension Control Arm and Ball Joint Assembly - Front Left Lower
ARM836	301181383600	NISSAN SUNNY (B14) 1995-1999	Suspension Control Arm and Ball Joint Assembly - Front Left Lower
ARM837	301181383700	INFINITI G20 1st Gen, P10 1990-1996	Suspension Control Arm - Front Right Upper
ARM837	301181383700	NISSAN PRIMERA (P10-W10-W11) 06/1990-06/1996	Suspension Control Arm - Front Right Upper
ARM837	301181383700	NISSAN PRIMERA (P11) 06/1996-12/2001	Suspension Control Arm - Front Right Upper
ARM838	301181383800	INFINITI G20 1st Gen, P10 1990-1996	Suspension Control Arm - Front Left Upper
ARM838	301181383800	NISSAN PRIMERA (P10-W10-W11) 06/1990-06/1996	Suspension Control Arm - Front Left Upper
ARM838	301181383800	NISSAN PRIMERA (P11) 06/1996-12/2001	Suspension Control Arm - Front Left Upper
ARM839	301181383900	INFINITI G20 1st Gen, P10 1990-1996	Suspension Control Arm and Ball Joint Assembly - Right Lower
ARM839	301181383900	NISSAN PRIMERA (P11) 06/1996-12/2001	Suspension Control Arm and Ball Joint Assembly - Right Lower
ARM840	301181384000	INFINITI G20 1st Gen, P10 1990-1996	Suspension Control Arm and Ball Joint Assembly - Left Lower
ARM840	301181384000	NISSAN PRIMERA (P11) 06/1996-12/2001	Suspension Control Arm and Ball Joint Assembly - Left Lower
ARM841	301181384100	NISSAN PRIMERA (P12) 01/2002-05/2008	Suspension Control Arm and Ball Joint Assembly - Right Lower
ARM842	301181384200	NISSAN PRIMERA (P12) 01/2002-05/2008	Suspension Control Arm and Ball Joint Assembly - Left Lower
ARM843	301181384300	NISSAN PRIMERA (P12) 01/2002-05/2008	Suspension Control Arm and Ball Joint Assembly - Front Right Upper
ARM844	301181384400	NISSAN PRIMERA (P12) 01/2002-05/2008	Suspension Control Arm and Ball Joint Assembly - Front Left Upper
ARM845	301181384500	NISSAN MICRA (K12) 02/2003-05/2010	Suspension Control Arm and Ball Joint Assembly - Front Right Lower
ARM845	301181384500	NISSAN NOTE (E11) 03/2006-05/2013	Suspension Control Arm and Ball Joint Assembly - Front Right Lower
ARM846	301181384600	NISSAN MICRA (K12) 02/2003-05/2010	Suspension Control Arm and Ball Joint Assembly - Front Left Lower
ARM846	301181384600	NISSAN NOTE (E11) 03/2006-05/2013	Suspension Control Arm and Ball Joint Assembly - Front Left Lower
ARM847	301181384700	NISSAN MICRA (K11) 08/1992-01/2003	Suspension Control Arm and Ball Joint Assembly - Front Right Lower
ARM848	301181384800	NISSAN MICRA (K11) 08/1992-01/2003	Suspension Control Arm and Ball Joint Assembly - Front Left Lower
ARM849	301181384900	NISSAN MICRA (K11) 08/1992-01/2003	Suspension Control Arm and Ball Joint Assembly - Front Right Lower
ARM850	301181385000	NISSAN MICRA (K11) 08/1992-01/2003	Suspension Control Arm and Ball Joint Assembly - Front Left Lower
ARM851	301181385100	NISSAN MARCH (K13) 06/2010-	Suspension Control Arm and Ball Joint Assembly - Front Right Lower



			DESCRIPTION
SHORT	LONG		
ARM851	301181385100	NISSAN MICRA (K13) 06/2010-	Suspension Control Arm and Ball Joint Assembly - Front Right Lower
ARM851	301181385100	NISSAN VERSA NOTE (E12) 06/2013-	Suspension Control Arm and Ball Joint Assembly - Front Right Lower
ARM852	301181385200	NISSAN MARCH (K13) 06/2010-	Suspension Control Arm and Ball Joint Assembly - Front Left Lower
ARM852	301181385200	NISSAN MICRA (K13) 06/2010-	Suspension Control Arm and Ball Joint Assembly - Front Left Lower
ARM852	301181385200	NISSAN VERSA NOTE (E12) 06/2013-	Suspension Control Arm and Ball Joint Assembly - Front Left Lower
ARM853	301181385300	NISSAN MURANO (Z50) 03/2003-10/2007	Suspension Control Arm and Ball Joint Assembly - Front Right
ARM854	301181385400	NISSAN MURANO (Z50) 03/2003-10/2007	Suspension Control Arm and Ball Joint Assembly - Front Left
ARM855	301181385500	INFINITI QX4 R50 1997-2004	Suspension Control Arm and Ball Joint Assembly - Front Right Lower
ARM855	301181385500	NISSAN PATHFINDER (R50) 1997-2004	Suspension Control Arm and Ball Joint Assembly - Front Right Lower
ARM856	301181385600	INFINITI QX4 R50 1997-2004	Suspension Control Arm and Ball Joint Assembly - Front Left Lower
ARM856	301181385600	NISSAN PATHFINDER (R50) 1997-2004	Suspension Control Arm and Ball Joint Assembly - Front Left Lower
ARM857	301181385700	NISSAN FRONTIER (D40) 07/2005-	Suspension Control Arm and Ball Joint Assembly - Right Lower
ARM857	301181385700	NISSAN NAVARA (D40) 07/2005-	Suspension Control Arm and Ball Joint Assembly - Right Lower
ARM857	301181385700	NISSAN PATHFINDER (R51) 03/2005-05/2014	Suspension Control Arm and Ball Joint Assembly - Right Lower
ARM858	301181385800	NISSAN FRONTIER (D40) 07/2005-	Suspension Control Arm and Ball Joint Assembly - Left Lower
ARM858	301181385800	NISSAN NAVARA (D40) 07/2005-	Suspension Control Arm and Ball Joint Assembly - Left Lower
ARM858	301181385800	NISSAN PATHFINDER (R51) 03/2005-05/2014	Suspension Control Arm and Ball Joint Assembly - Left Lower
ARM859	301181385900	NISSAN FRONTIER (D40) 07/2005-	Suspension Control Arm and Ball Joint Assembly - Front Right Upper
ARM859	301181385900	NISSAN NAVARA (D40) 07/2005-	Suspension Control Arm and Ball Joint Assembly - Front Right Upper
ARM859	301181385900	NISSAN PATHFINDER (R51) 03/2005-05/2014	Suspension Control Arm and Ball Joint Assembly - Front Right Upper
ARM860	301181386000	NISSAN FRONTIER (D40) 07/2005-	Suspension Control Arm and Ball Joint Assembly - Front Left Upper
ARM860	301181386000	NISSAN NAVARA (D40) 07/2005-	Suspension Control Arm and Ball Joint Assembly - Front Left Upper
ARM860	301181386000	NISSAN PATHFINDER (R51) 03/2005-05/2014	Suspension Control Arm and Ball Joint Assembly - Front Left Upper
ARM861	301181386100	NISSAN ALMERA (N16) 07/2000-09/2006	Suspension Control Arm and Ball Joint Assembly - Front Right Lower
ARM862	301181386200	NISSAN ALMERA (N16) 07/2000-09/2006	Suspension Control Arm and Ball Joint Assembly - Front Left Lower





 SHORT LONG			DESCRIPTION
ARM863	301181386300	NISSAN JUKE 06/2010-	Suspension Control Arm and Ball Joint Assembly - Front Right
ARM863	301181386300	NISSAN LEAF 2010-	Suspension Control Arm and Ball Joint Assembly - Front Right
ARM864	301181386400	NISSAN JUKE 06/2010-	Suspension Control Arm and Ball Joint Assembly - Front Left
ARM864	301181386400	NISSAN LEAF 2010-	Suspension Control Arm and Ball Joint Assembly - Front Left
ARM865	301181386500	NISSAN QASHQAI (J10, JJ10) 02/2007-01/2014	Suspension Control Arm and Ball Joint Assembly - Right Lower
ARM865	301181386500	NISSAN ROGUE 1st Gen 2008-2014	Suspension Control Arm and Ball Joint Assembly - Right Lower
ARM865	301181386500	NISSAN X-TRAIL 2nd Gen (T31) 06/2007-09/2013	Suspension Control Arm and Ball Joint Assembly - Right Lower
ARM865	301181386500	RENAULT KOLEOS 09/2008-	Suspension Control Arm and Ball Joint Assembly - Right Lower
ARM866	301181386600	NISSAN QASHQAI (J10, JJ10) 02/2007-01/2014	Suspension Control Arm and Ball Joint Assembly - Left Lower
ARM866	301181386600	NISSAN ROGUE 1st Gen 2008-2014	Suspension Control Arm and Ball Joint Assembly - Left Lower
ARM866	301181386600	NISSAN X-TRAIL 2nd Gen (T31) 06/2007-09/2013	Suspension Control Arm and Ball Joint Assembly - Left Lower
ARM866	301181386600	RENAULT KOLEOS 09/2008-	Suspension Control Arm and Ball Joint Assembly - Left Lower
ARM867	301181386700	NISSAN QASHQAI II (J11) 02/2014-	Suspension Control Arm and Ball Joint Assembly - Front Right
ARM867	301181386700	RENAULT KADJAR 2015-	Suspension Control Arm and Ball Joint Assembly - Front Right
ARM868	301181386800	NISSAN QASHQAI II (J11) 02/2014-	Suspension Control Arm and Ball Joint Assembly - Front Left
ARM868	301181386800	RENAULT KADJAR 2015-	Suspension Control Arm and Ball Joint Assembly - Front Left
ARM869	301181386900	CHEVROLET Chevy Monza / MONZA(MEXICO) 1994-2001	Suspension Control Arm and Ball Joint Assembly - Front Right Lower
ARM869	301181386900	OPEL CORSA (B) 73,78,79 08/1999-08/2000	Suspension Control Arm and Ball Joint Assembly - Front Right Lower
ARM869	301181386900	VAUXHALL CORSA 1993-1997	Suspension Control Arm and Ball Joint Assembly - Front Right Lower
ARM869	301181386900	VAUXHALL CORSA COMBO 1993-1997	Suspension Control Arm and Ball Joint Assembly - Front Right Lower
ARM869	301181386900	VAUXHALL TIGRA 1994-1997	Suspension Control Arm and Ball Joint Assembly - Front Right Lower
ARM870	301181387000	CHEVROLET Chevy Monza / MONZA(MEXICO) 1994-2001	Suspension Control Arm and Ball Joint Assembly - Front Left Lower
ARM870	301181387000	OPEL CORSA (B) 73,78,79 08/1999-08/2000	Suspension Control Arm and Ball Joint Assembly - Front Left Lower
ARM870	301181387000	VAUXHALL CORSA 1993-1997	Suspension Control Arm and Ball Joint Assembly - Front Left Lower
ARM870	301181387000	VAUXHALL CORSA COMBO 1993-1997	Suspension Control Arm and Ball Joint Assembly - Front Left Lower



			DESCRIPTION
SHORT	LONG		
ARM870	301181387000	VAUXHALL TIGRA 1994-1997	Suspension Control Arm and Ball Joint Assembly - Front Left Lower
ARM871	301181387100	CHEVROLET Chevy Pickup /MONZA/PICK-UPIMPORT 1999-2001	Suspension Control Arm and Ball Joint Assembly - Front Right Lower
ARM871	301181387100	OPEL COMBO (B) 03/1993-08/2000	Suspension Control Arm and Ball Joint Assembly - Front Right Lower
ARM871	301181387100	OPEL CORSA (B) 03/1993-08/2000	Suspension Control Arm and Ball Joint Assembly - Front Right Lower
ARM871	301181387100	VAUXHALL CORSA 1997-2000	Suspension Control Arm and Ball Joint Assembly - Front Right Lower
ARM871	301181387100	VAUXHALL CORSA COMBO 1997-	Suspension Control Arm and Ball Joint Assembly - Front Right Lower
ARM871	301181387100	VAUXHALL TIGRA 1997-	Suspension Control Arm and Ball Joint Assembly - Front Right Lower
ARM872	301181387200	CHEVROLET Chevy Pickup /MONZA/PICK-UPIMPORT 1999-2001	Suspension Control Arm and Ball Joint Assembly - Front Left Lower
ARM872	301181387200	OPEL COMBO (B) 03/1993-08/2000	Suspension Control Arm and Ball Joint Assembly - Front Left Lower
ARM872	301181387200	OPEL CORSA (B) 03/1993-08/2000	Suspension Control Arm and Ball Joint Assembly - Front Left Lower
ARM872	301181387200	VAUXHALL CORSA 1997-2000	Suspension Control Arm and Ball Joint Assembly - Front Left Lower
ARM872	301181387200	VAUXHALL CORSA COMBO 1997-	Suspension Control Arm and Ball Joint Assembly - Front Left Lower
ARM872	301181387200	VAUXHALL TIGRA 1997-	Suspension Control Arm and Ball Joint Assembly - Front Left Lower
ARM873	301181387300	CHEVROLET Chevy Pickup /MONZA/PICK-UPIMPORT 2001-2005	Suspension Control Arm and Ball Joint Assembly - Front Right Lower
ARM873	301181387300	CHEVROLET Tornado 2003-2016	Suspension Control Arm and Ball Joint Assembly - Front Right Lower
ARM873	301181387300	OPEL COMBO (C) 09/2000-07/2006	Suspension Control Arm and Ball Joint Assembly - Front Right Lower
ARM873	301181387300	OPEL CORSA (C) 09/2000-07/2006	Suspension Control Arm and Ball Joint Assembly - Front Right Lower
ARM873	301181387300	OPEL CORSA (Utility) 2003-2010	Suspension Control Arm and Ball Joint Assembly - Front Right Lower
ARM874	301181387400	CHEVROLET Chevy Pickup /MONZA/PICK-UPIMPORT 2001-2005	Suspension Control Arm and Ball Joint Assembly - Front Left Lower
ARM874	301181387400	CHEVROLET Tornado 2003-2016	Suspension Control Arm and Ball Joint Assembly - Front Left Lower
ARM874	301181387400	OPEL COMBO (C) 09/2000-07/2006	Suspension Control Arm and Ball Joint Assembly - Front Left Lower
ARM874	301181387400	OPEL CORSA (C) 09/2000-07/2006	Suspension Control Arm and Ball Joint Assembly - Front Left Lower
ARM874	301181387400	OPEL CORSA (Utility) 2003-2010	Suspension Control Arm and Ball Joint Assembly - Front Left Lower
ARM875	301181387500	OPEL MERIVA (A) 05/2003-05/2010	Suspension Control Arm and Ball Joint Assembly - Front Right Lower
ARM876	301181387600	OPEL MERIVA (A) 05/2003-05/2010	Suspension Control Arm and Ball Joint Assembly - Front Left Lower





 SHORT LONG			DESCRIPTION
ARM877	301181387700	OPEL AGILA (A) 09/2000-08/2007	Suspension Control Arm and Ball Joint Assembly - Front Lower
ARM877	301181387700	SUZUKI IGNIS I (FH) 10/2000-08/2003	Suspension Control Arm and Ball Joint Assembly - Front Lower
ARM878	301181387800	OPEL AGILA (A) 09/2000-08/2007	Lateral Arm - Rear Right
ARM879	301181387900	OPEL AGILA (A) 09/2000-08/2007	Lateral Arm - Rear Left
ARM880	301181388000	OPEL ADAM 10/2012-	Suspension Control Arm and Ball Joint Assembly - Front Right Lower
ARM880	301181388000	OPEL CORSA (D) 08/2006-08/2014	Suspension Control Arm and Ball Joint Assembly - Front Right Lower
ARM880	301181388000	OPEL CORSA (E) 09/2014-	Suspension Control Arm and Ball Joint Assembly - Front Right Lower
ARM881	301181388100	OPEL ADAM 10/2012-	Suspension Control Arm and Ball Joint Assembly - Front Left Lower
ARM881	301181388100	OPEL CORSA (D) 08/2006-08/2014	Suspension Control Arm and Ball Joint Assembly - Front Left Lower
ARM881	301181388100	OPEL CORSA (E) 09/2014-	Suspension Control Arm and Ball Joint Assembly - Front Left Lower
ARM882	301181388200	CHEVROLET TRAX 2014 -	Suspension Control Arm and Ball Joint Assembly - Front Right
ARM882	301181388200	OPEL MOKKA 06/2012-	Suspension Control Arm and Ball Joint Assembly - Front Right
ARM883	301181388300	CHEVROLET TRAX 2014 -	Suspension Control Arm and Ball Joint Assembly - Front Right Lower
ARM883	301181388300	OPEL MOKKA 06/2012-	Suspension Control Arm and Ball Joint Assembly - Front Right Lower
ARM884	301181388400	CHEVROLET TRAX 2014 -	Suspension Control Arm and Ball Joint Assembly - Front Left Lower
ARM884	301181388400	OPEL MOKKA 06/2012-	Suspension Control Arm and Ball Joint Assembly - Front Left Lower
ARM885	301181388500	OPEL ASTRA (G) 1998-2004	Suspension Control Arm and Ball Joint Assembly - Front Right Lower
ARM885	301181388500	OPEL VECTRA (B) 1996-07/2002	Suspension Control Arm and Ball Joint Assembly - Front Right Lower
ARM885	301181388500	OPEL ZAFIRA (A) 1998-2004	Suspension Control Arm and Ball Joint Assembly - Front Right Lower
ARM885	301181388500	VAUXHALL VECTRA 1996-	Suspension Control Arm and Ball Joint Assembly - Front Right Lower
ARM886	301181388600	OPEL ASTRA (G) 1998-2004	Suspension Control Arm and Ball Joint Assembly - Front Left Lower
ARM886	301181388600	OPEL VECTRA (B) 1996-07/2002	Suspension Control Arm and Ball Joint Assembly - Front Left Lower
ARM886	301181388600	OPEL ZAFIRA (A) 1998-2004	Suspension Control Arm and Ball Joint Assembly - Front Left Lower
ARM886	301181388600	VAUXHALL VECTRA 1996-	Suspension Control Arm and Ball Joint Assembly - Front Left Lower
ARM887	301181388700	OPEL ASTRA (H) 03/2004-11/2009	Suspension Control Arm and Ball Joint Assembly - Front Right Lower
ARM887	301181388700	OPEL MERIVA (B) 06/2010-	Suspension Control Arm and Ball Joint Assembly - Front Right Lower



			DESCRIPTION
SHORT	LONG		
ARM887	301181388700	OPEL ZAFIRA (B) (A05) 07/2005-09/2011	Suspension Control Arm and Ball Joint Assembly - Front Right Lower
ARM887	301181388700	SATURN ASTRA (H) 2008-2009	Suspension Control Arm and Ball Joint Assembly - Front Right Lower
ARM888	301181388800	OPEL ASTRA (H) 03/2004-11/2009	Suspension Control Arm and Ball Joint Assembly - Front Left Lower
ARM888	301181388800	OPEL MERIVA (B) 06/2010-	Suspension Control Arm and Ball Joint Assembly - Front Left Lower
ARM888	301181388800	OPEL ZAFIRA (B) (A05) 07/2005-09/2011	Suspension Control Arm and Ball Joint Assembly - Front Left Lower
ARM888	301181388800	SATURN ASTRA (H) 2008-2009	Suspension Control Arm and Ball Joint Assembly - Front Left Lower
ARM889	301181388900	OPEL VECTRA (C) 08/2002-09/2008	Lateral Arm - Rear Upper
ARM890	301181389000	BUICK VERANO 2012-2016	Suspension Control Arm and Ball Joint Assembly - Front Right Lower
ARM890	301181389000	OPEL ASTRA (J) 12/2009-05/2015	Suspension Control Arm and Ball Joint Assembly - Front Right Lower
ARM891	301181389100	BUICK VERANO 2012-2016	Suspension Control Arm and Ball Joint Assembly - Front Left Lower
ARM891	301181389100	OPEL ASTRA (J) 12/2009-05/2015	Suspension Control Arm and Ball Joint Assembly - Front Left Lower
ARM892	301181389200	OPEL ZAFIRA (C) (P12) 10/2011-	Suspension Control Arm and Ball Joint Assembly - Front Right Lower
ARM893	301181389300	OPEL ZAFIRA (C) (P12) 10/2011-	Suspension Control Arm and Ball Joint Assembly - Front Left
ARM894	301181389400	OPEL INSIGNIA 1st Gen 07/2008-2017	Suspension Control Arm and Ball Joint Assembly - Front Right Lower
ARM895	301181389500	OPEL INSIGNIA 1st Gen 07/2008-2017	Suspension Control Arm and Ball Joint Assembly - Front Left
ARM896	301181389600	OPEL ASTRA (K) 06/2015-	Suspension Control Arm and Ball Joint Assembly - Front Right
ARM897	301181389700	OPEL ASTRA (K) 06/2015-	Suspension Control Arm and Ball Joint Assembly - Front Left
ARM898	301181389800	CITROEN AX 1992-1998	Suspension Control Arm and Ball Joint Assembly - Front Right Lower
ARM898	301181389800	CITROEN SAXO 1996-2003	Suspension Control Arm and Ball Joint Assembly - Front Right Lower
ARM898	301181389800	PEUGEOT 106 08/1991-03/2004	Suspension Control Arm and Ball Joint Assembly - Front Right Lower
ARM899	301181389900	CITROEN AX 1992-1998	Suspension Control Arm and Ball Joint Assembly - Front Left Lower
ARM899	301181389900	CITROEN SAXO 1996-2003	Suspension Control Arm and Ball Joint Assembly - Front Left Lower
ARM899	301181389900	PEUGEOT 106 08/1991-03/2004	Suspension Control Arm and Ball Joint Assembly - Front Left Lower
ARM900	301181390000	CITROEN SAXO 1996-2003	Suspension Control Arm and Ball Joint Assembly - Front Right Lower
ARM900	301181390000	PEUGEOT 106 08/1991-03/2004	Suspension Control Arm and Ball Joint Assembly - Front Right Lower
ARM901	301181390100	CITROEN SAXO 1996-2003	Suspension Control Arm and Ball Joint Assembly - Front Left





 SHORT LONG			DESCRIPTION
ARM901	301181390100	PEUGEOT 106 08/1991-03/2004	Suspension Control Arm and Ball Joint Assembly - Front Left
ARM902	301181390200	CITROEN C1 06/2005-03/2014	Suspension Control Arm and Ball Joint Assembly - Front Right Lower
ARM902	301181390200	PEUGEOT 1007 (KM) 04/2005-2010	Suspension Control Arm and Ball Joint Assembly - Front Right Lower
ARM902	301181390200	PEUGEOT 107 06/2005-	Suspension Control Arm and Ball Joint Assembly - Front Right Lower
ARM902	301181390200	TOYOTA AYGO 07/2005-09/2014	Suspension Control Arm and Ball Joint Assembly - Front Right Lower
ARM903	301181390300	CITROEN C1 06/2005-03/2014	Suspension Control Arm and Ball Joint Assembly - Front Left Lower
ARM903	301181390300	PEUGEOT 1007 (KM) 04/2005-2010	Suspension Control Arm and Ball Joint Assembly - Front Left Lower
ARM903	301181390300	PEUGEOT 107 06/2005-	Suspension Control Arm and Ball Joint Assembly - Front Left Lower
ARM903	301181390300	TOYOTA AYGO 07/2005-09/2014	Suspension Control Arm and Ball Joint Assembly - Front Left Lower
ARM904	301181390400	PEUGEOT 206 08/1998-12/2008	Suspension Control Arm and Ball Joint Assembly - Front Right Lower
ARM904	301181390400	PEUGEOT 206+ 01/2009-12/2012	Suspension Control Arm and Ball Joint Assembly - Front Right Lower
ARM905	301181390500	PEUGEOT 206 08/1998-12/2008	Suspension Control Arm and Ball Joint Assembly - Front Left Lower
ARM905	301181390500	PEUGEOT 206+ 01/2009-12/2012	Suspension Control Arm and Ball Joint Assembly - Front Left Lower
ARM906	301181390600	PEUGEOT 206 08/1998-12/2008	Suspension Control Arm and Ball Joint Assembly - Front Right Lower
ARM907	301181390700	PEUGEOT 206 08/1998-12/2008	Suspension Control Arm and Ball Joint Assembly - Front Right Lower
ARM908	301181390800	PEUGEOT 206 08/1998-12/2008	Suspension Control Arm and Ball Joint Assembly - Front Left
ARM909	301181390900	PEUGEOT 206 08/1998-12/2008	Suspension Control Arm and Ball Joint Assembly - Front Left
ARM910	301181391000	PEUGEOT 206 08/1998-12/2008	Suspension Control Arm and Ball Joint Assembly - Front Right Lower
ARM911	301181391100	PEUGEOT 206 08/1998-12/2008	Suspension Control Arm and Ball Joint Assembly - Front Left
ARM912	301181391200	PEUGEOT 207 02/2006-11/2012	Suspension Control Arm and Ball Joint Assembly - Front Right Lower
ARM913	301181391300	PEUGEOT 207 02/2006-11/2012	Suspension Control Arm and Ball Joint Assembly - Front Left Lower
ARM914	301181391400	CITROEN C5 RC 04/2004-01/2008	Suspension Control Arm - Front Right Lower
ARM914	301181391400	CITROEN C6 TD 09/2005-09/2012	Suspension Control Arm - Front Right Lower
ARM914	301181391400	PEUGEOT 407 05/2004-12/2011	Suspension Control Arm - Front Right Lower
ARM915	301181391500	CITROEN C5 RC 04/2004-01/2008	Suspension Control Arm - Front Left Lower
ARM915	301181391500	CITROEN C6 TD 09/2005-09/2012	Suspension Control Arm - Front Left Lower
ARM915	301181391500	PEUGEOT 407 05/2004-12/2011	Suspension Control Arm - Front Left Lower
ARM916	301181391600	PEUGEOT 407 05/2004-12/2011	Suspension Control Arm - Front Right Lower



 SHORT LONG			DESCRIPTION
ARM917	301181391700	PEUGEOT 407 05/2004-12/2011	Suspension Control Arm - Front Left
ARM918	301181391800	CITROEN C5 RD 02/2008-	Lateral Arm - Rear Forward
ARM918	301181391800	PEUGEOT 407 05/2004-12/2011	Lateral Arm - Rear Forward
ARM919	301181391900	CITROEN C5 RD 02/2008-	Lateral Arm - Rear Upper Rearward
ARM919	301181391900	PEUGEOT 407 05/2004-12/2011	Lateral Arm - Rear Upper Rearward
ARM920	301181392000	CITROEN C5 RC 04/2004-01/2008	Suspension Control Arm - Front Right Lower
ARM920	301181392000	CITROEN C6 TD 09/2005-09/2012	Suspension Control Arm - Front Right Lower
ARM920	301181392000	PEUGEOT 407 05/2004-12/2011	Suspension Control Arm - Front Right Lower
ARM921	301181392100	CITROEN C5 RC 04/2004-01/2008	Suspension Control Arm - Front Left Lower
ARM921	301181392100	CITROEN C6 TD 09/2005-09/2012	Suspension Control Arm - Front Left Lower
ARM921	301181392100	PEUGEOT 407 05/2004-12/2011	Suspension Control Arm - Front Left Lower
ARM922	301181392200	PEUGEOT 208 03/2012-	Suspension Control Arm and Ball Joint Assembly - Front Right Lower
ARM922	301181392200	PEUGEOT 208 GTI 03/2012-	Suspension Control Arm and Ball Joint Assembly - Front Right Lower
ARM923	301181392300	PEUGEOT 208 03/2012-	Suspension Control Arm and Ball Joint Assembly - Front Left Lower
ARM923	301181392300	PEUGEOT 208 GTI 03/2012-	Suspension Control Arm and Ball Joint Assembly - Front Left Lower
ARM924	301181392400	CITROEN BERLINGO MF 07/1996-	Suspension Control Arm and Ball Joint Assembly - Front Right Lower
ARM924	301181392400	CITROEN XSARA 1997-2005	Suspension Control Arm and Ball Joint Assembly - Front Right Lower
ARM924	301181392400	CITROEN ZX 1991-1997	Suspension Control Arm and Ball Joint Assembly - Front Right Lower
ARM924	301181392400	PEUGEOT PARTNER I 05/1996-	Suspension Control Arm and Ball Joint Assembly - Front Right Lower
ARM925	301181392500	CITROEN BERLINGO MF 07/1996-	Suspension Control Arm and Ball Joint Assembly - Front Left Lower
ARM925	301181392500	CITROEN XSARA 1997-2005	Suspension Control Arm and Ball Joint Assembly - Front Left Lower
ARM925	301181392500	CITROEN ZX 1991-1997	Suspension Control Arm and Ball Joint Assembly - Front Left Lower
ARM925	301181392500	PEUGEOT PARTNER I 05/1996-	Suspension Control Arm and Ball Joint Assembly - Front Left Lower
ARM926	301181392600	CITROEN BERLINGO M 04/2008-	Suspension Control Arm - Front Right Lower
ARM926	301181392600	CITROEN C4 GRAND PICASSO UA 02/2007-01/2013	Suspension Control Arm - Front Right Lower
ARM926	301181392600	CITROEN C4 LA 11/2004-10/2009	Suspension Control Arm - Front Right Lower
ARM926	301181392600	PEUGEOT 307 08/2000-12/2008	Suspension Control Arm - Front Right Lower
ARM926	301181392600	PEUGEOT PARTNER II, Tepee 04/2008-	Suspension Control Arm - Front Right Lower
ARM927	301181392700	CITROEN BERLINGO M 04/2008-	Suspension Control Arm - Front Left
ARM927	301181392700	CITROEN C4 GRAND PICASSO UA 02/2007-01/2013	Suspension Control Arm - Front Left
ARM927	301181392700	CITROEN C4 LA 11/2004-10/2009	Suspension Control Arm - Front Left
ARM927	301181392700	PEUGEOT 307 08/2000-12/2008	Suspension Control Arm - Front Left





 SHORT LONG			DESCRIPTION
ARM927	301181392700	PEUGEOT PARTNER II, Tepee 04/2008-	Suspension Control Arm - Front Left
ARM928	301181392800	CITROEN C4 B7 11/2009-	Suspension Control Arm - Front Right Lower
ARM928	301181392800	PEUGEOT 3008 09/2009-2016	Suspension Control Arm - Front Right Lower
ARM928	301181392800	PEUGEOT 308 09/2007-10/2013	Suspension Control Arm - Front Right Lower
ARM928	301181392800	PEUGEOT 5008 09/2009-	Suspension Control Arm - Front Right Lower
ARM929	301181392900	CITROEN C4 B7 11/2009-	Suspension Control Arm - Front Left
ARM929	301181392900	PEUGEOT 3008 09/2009-2016	Suspension Control Arm - Front Left
ARM929	301181392900	PEUGEOT 308 09/2007-10/2013	Suspension Control Arm - Front Left
ARM929	301181392900	PEUGEOT 5008 09/2009-	Suspension Control Arm - Front Left
ARM930	301181393000	PEUGEOT 308 II 09/2013-	Suspension Control Arm and Ball Joint Assembly - Front Left Lower
ARM931	301181393100	PEUGEOT 308 II 09/2013-	Suspension Control Arm and Ball Joint Assembly - Front Right Lower
ARM932	301181393200	CITROEN C4 PICASSO II 2013-	Suspension Control Arm and Ball Joint Assembly - Front Right
ARM932	301181393200	PEUGEOT 308 II 09/2013-	Suspension Control Arm and Ball Joint Assembly - Front Right
ARM933	301181393300	CITROEN C4 PICASSO II 2013-	Suspension Control Arm and Ball Joint Assembly - Front Left
ARM933	301181393300	PEUGEOT 308 II 09/2013-	Suspension Control Arm and Ball Joint Assembly - Front Left
ARM934	301181393400	PEUGEOT 3008 II 2016-	Suspension Control Arm and Ball Joint Assembly - Front Right Lower
ARM935	301181393500	PEUGEOT 3008 II 2016-	Suspension Control Arm and Ball Joint Assembly - Front Left Lower
ARM936	301181393600	PEUGEOT 508 11/2010-	Suspension Control Arm and Ball Joint Assembly - Front Right
ARM937	301181393700	PEUGEOT 508 11/2010-	Suspension Control Arm and Ball Joint Assembly - Front Left
ARM938	301181393800	OPEL VIVARO II 10/2014-	Suspension Control Arm and Ball Joint Assembly - Front Right
ARM938	301181393800	RENAULT TRAFIC III 10/2014-	Suspension Control Arm and Ball Joint Assembly - Front Right
ARM939	301181393900	OPEL VIVARO II 10/2014-	Suspension Control Arm and Ball Joint Assembly - Front Left
ARM939	301181393900	RENAULT TRAFIC III 10/2014-	Suspension Control Arm and Ball Joint Assembly - Front Left
ARM940	301181394000	RENAULT CLIO III-HB 06/2005-09/2012	Suspension Control Arm and Ball Joint Assembly - Front Right Lower
ARM940	301181394000	RENAULT MODUS 12/2004-07/2014	Suspension Control Arm and Ball Joint Assembly - Front Right Lower
ARM941	301181394100	RENAULT CLIO III-HB 06/2005-09/2012	Suspension Control Arm and Ball Joint Assembly - Front Left Lower
ARM941	301181394100	RENAULT MODUS 12/2004-07/2014	Suspension Control Arm and Ball Joint Assembly - Front Left Lower
ARM942	301181394200	NISSAN INTERSTAR (X70) 07/2002-08/2010	Suspension Control Arm and Ball Joint Assembly - Front Right Lower
ARM942	301181394200	OPEL MOVANO (A) 07/1998-04/2010	Suspension Control Arm and Ball Joint Assembly - Front Right Lower



			DESCRIPTION
SHORT	LONG		
ARM942	301181394200	RENAULT MASTER I 07/1998-09/2003	Suspension Control Arm and Ball Joint Assembly - Front Right Lower
ARM943	301181394300	NISSAN INTERSTAR (X70) 07/2002-08/2010	Suspension Control Arm and Ball Joint Assembly - Front Left Lower
ARM943	301181394300	OPEL MOVANO (A) 07/1998-04/2010	Suspension Control Arm and Ball Joint Assembly - Front Left Lower
ARM943	301181394300	RENAULT MASTER I 07/1998-09/2003	Suspension Control Arm and Ball Joint Assembly - Front Left Lower
ARM944	301181394400	NISSAN INTERSTAR (X70) 07/2002-08/2010	Suspension Control Arm and Ball Joint Assembly - Front Right
ARM944	301181394400	OPEL MOVANO (A) 07/1998-04/2010	Suspension Control Arm and Ball Joint Assembly - Front Right
ARM944	301181394400	RENAULT MASTER II 10/2003-01/2010	Suspension Control Arm and Ball Joint Assembly - Front Right
ARM945	301181394500	NISSAN INTERSTAR (X70) 07/2002-08/2010	Suspension Control Arm and Ball Joint Assembly - Front Left
ARM945	301181394500	OPEL MOVANO (A) 07/1998-04/2010	Suspension Control Arm and Ball Joint Assembly - Front Left
ARM945	301181394500	RENAULT MASTER II 10/2003-01/2010	Suspension Control Arm and Ball Joint Assembly - Front Left
ARM946	301181394600	OPEL MOVANO (B) 05/2010-	Suspension Control Arm - Front Right Lower
ARM946	301181394600	RENAULT MASTER III 02/2010-	Suspension Control Arm - Front Right Lower
ARM947	301181394700	OPEL MOVANO (B) 05/2010-	Suspension Control Arm - Front Left Lower
ARM947	301181394700	RENAULT MASTER III 02/2010-	Suspension Control Arm - Front Left Lower
ARM948	301181394800	RENAULT CAPTUR 03/2013-	Suspension Control Arm and Ball Joint Assembly - Right Lower
ARM949	301181394900	RENAULT CAPTUR 03/2013-	Suspension Control Arm and Ball Joint Assembly - Left Lower
ARM950	301181395000	RENAULT MEGANE II 09/2003-04/2009	Suspension Control Arm and Ball Joint Assembly - Front Right Lower
ARM950	301181395000	RENAULT SCENIC II 06/2003-01/2009	Suspension Control Arm and Ball Joint Assembly - Front Right Lower
ARM951	301181395100	RENAULT MEGANE II 09/2003-04/2009	Suspension Control Arm and Ball Joint Assembly - Front Left Lower
ARM951	301181395100	RENAULT SCENIC II 06/2003-01/2009	Suspension Control Arm and Ball Joint Assembly - Front Left Lower
ARM952	301181395200	RENAULT MEGANE II 09/2003-04/2009	Suspension Control Arm and Ball Joint Assembly - Front Right Lower
ARM953	301181395300	RENAULT MEGANE II 09/2003-04/2009	Suspension Control Arm and Ball Joint Assembly - Front Left Lower
ARM954	301181395400	RENAULT LAGUNA II 04/2001-09/2007	Suspension Control Arm and Ball Joint Assembly - Front Right Lower
ARM955	301181395500	RENAULT LAGUNA II 04/2001-09/2007	Suspension Control Arm and Ball Joint Assembly - Front Left Lower
ARM956	301181395600	NISSAN PRIMASTAR (X83) 08/2002-06/2014	Suspension Control Arm and Ball Joint Assembly - Front Right Lower
ARM956	301181395600	OPEL VIVARO I 08/2001-06/2014	Suspension Control Arm and Ball Joint Assembly - Front Right Lower
ARM956	301181395600	RENAULT TRAFIC II 03/2001-09/2014	Suspension Control Arm and Ball Joint Assembly - Front Right Lower





 SHORT LONG			DESCRIPTION
ARM957	301181395700	NISSAN PRIMASTAR (X83) 08/2002-06/2014	Suspension Control Arm and Ball Joint Assembly - Front Left Lower
ARM957	301181395700	OPEL VIVARO I 08/2001-06/2014	Suspension Control Arm and Ball Joint Assembly - Front Left Lower
ARM957	301181395700	RENAULT TRAFIC II 03/2001-09/2014	Suspension Control Arm and Ball Joint Assembly - Front Left Lower
ARM958	301181395800	NISSAN PRIMASTAR (X83) 08/2002-06/2014	Suspension Control Arm and Ball Joint Assembly - Front Right Lower
ARM958	301181395800	OPEL VIVARO I 08/2001-06/2014	Suspension Control Arm and Ball Joint Assembly - Front Right Lower
ARM958	301181395800	RENAULT TRAFIC II 03/2001-09/2014	Suspension Control Arm and Ball Joint Assembly - Front Right Lower
ARM959	301181395900	NISSAN PRIMASTAR (X83) 08/2002-06/2014	Suspension Control Arm and Ball Joint Assembly - Front Left Lower
ARM959	301181395900	OPEL VIVARO I 08/2001-06/2014	Suspension Control Arm and Ball Joint Assembly - Front Left Lower
ARM959	301181395900	RENAULT TRAFIC II 03/2001-09/2014	Suspension Control Arm and Ball Joint Assembly - Front Left Lower
ARM960	301181396000	RENAULT FLUENCE 02/2010-	Suspension Control Arm and Ball Joint Assembly - Front Right Lower
ARM960	301181396000	RENAULT MEGANE III 05/2009-10/2015	Suspension Control Arm and Ball Joint Assembly - Front Right Lower
ARM960	301181396000	RENAULT SCENIC III 02/2009-	Suspension Control Arm and Ball Joint Assembly - Front Right Lower
ARM961	301181396100	RENAULT FLUENCE 02/2010-	Suspension Control Arm and Ball Joint Assembly - Front Left Lower
ARM961	301181396100	RENAULT MEGANE III 05/2009-10/2015	Suspension Control Arm and Ball Joint Assembly - Front Left Lower
ARM961	301181396100	RENAULT SCENIC III 02/2009-	Suspension Control Arm and Ball Joint Assembly - Front Left Lower
ARM962	301181396200	RENAULT CLIO II-SYMBOL 10/1998-2012	Suspension Control Arm and Ball Joint Assembly - Front Right Lower
ARM962	301181396200	RENAULT KANGOO I 03/1998-01/2008	Suspension Control Arm and Ball Joint Assembly - Front Right Lower
ARM963	301181396300	RENAULT CLIO II-SYMBOL 10/1998-2012	Suspension Control Arm and Ball Joint Assembly - Front Left Lower
ARM963	301181396300	RENAULT KANGOO I 03/1998-01/2008	Suspension Control Arm and Ball Joint Assembly - Front Left Lower
ARM964	301181396400	NISSAN KUBISTAR (X76) 08/2003-07/2007	Suspension Control Arm and Ball Joint Assembly - Front Right Lower
ARM964	301181396400	RENAULT CLIO II-SYMBOL 10/1998-2012	Suspension Control Arm and Ball Joint Assembly - Front Right Lower
ARM964	301181396400	RENAULT KANGOO I 03/1998-01/2008	Suspension Control Arm and Ball Joint Assembly - Front Right Lower
ARM965	301181396500	NISSAN KUBISTAR (X76) 08/2003-07/2007	Suspension Control Arm and Ball Joint Assembly - Front Left Lower
ARM965	301181396500	RENAULT CLIO II-SYMBOL 10/1998-2012	Suspension Control Arm and Ball Joint Assembly - Front Left Lower
ARM965	301181396500	RENAULT KANGOO I 03/1998-01/2008	Suspension Control Arm and Ball Joint Assembly - Front Left Lower





			DESCRIPTION
SHORT	LONG		
ARM966	301181396600	MERCEDES CITAN 415 11/2012-	Suspension Control Arm and Ball Joint Assembly - Front Right Lower
ARM966	301181396600	RENAULT KANGOO II 02/2008-	Suspension Control Arm and Ball Joint Assembly - Front Right Lower
ARM967	301181396700	MERCEDES CITAN 415 11/2012-	Suspension Control Arm and Ball Joint Assembly - Front Left Lower
ARM967	301181396700	RENAULT KANGOO II 02/2008-	Suspension Control Arm and Ball Joint Assembly - Front Left Lower
ARM968	301181396800	RENAULT CLIO II-SYMBOL 10/1998-2012	Suspension Control Arm and Ball Joint Assembly - Front Right Lower
ARM969	301181396900	RENAULT CLIO II-SYMBOL 10/1998-2012	Suspension Control Arm and Ball Joint Assembly - Front Left Lower
ARM970	301181397000	RENAULT CLIO IV-HB 10/2012-	Suspension Control Arm and Ball Joint Assembly - Front Right Lower
ARM971	301181397100	RENAULT CLIO IV-HB 10/2012-	Suspension Control Arm and Ball Joint Assembly - Front Left Lower
ARM972	301181397200	DACIA DOKKER 11/2012-	Suspension Control Arm and Ball Joint Assembly - Front Right Lower
ARM972	301181397200	DACIA LODGY 03/2012-	Suspension Control Arm and Ball Joint Assembly - Front Right Lower
ARM972	301181397200	DACIA LOGAN II 12/2012-	Suspension Control Arm and Ball Joint Assembly - Front Right Lower
ARM972	301181397200	DACIA SANDERO II 01/2013-	Suspension Control Arm and Ball Joint Assembly - Front Right Lower
ARM972	301181397200	RENAULT CLIO III-SYMBOL 2013-	Suspension Control Arm and Ball Joint Assembly - Front Right Lower
ARM973	301181397300	DACIA DOKKER 11/2012-	Suspension Control Arm and Ball Joint Assembly - Front Left Lower
ARM973	301181397300	DACIA LODGY 03/2012-	Suspension Control Arm and Ball Joint Assembly - Front Left Lower
ARM973	301181397300	DACIA LOGAN II 12/2012-	Suspension Control Arm and Ball Joint Assembly - Front Left Lower
ARM973	301181397300	DACIA SANDERO II 01/2013-	Suspension Control Arm and Ball Joint Assembly - Front Left Lower
ARM973	301181397300	RENAULT CLIO III-SYMBOL 2013-	Suspension Control Arm and Ball Joint Assembly - Front Left Lower
ARM974	301181397400	RENAULT TWINGO (C06) 03/1993-02/2007	Suspension Control Arm and Ball Joint Assembly - Front Right Lower
ARM975	301181397500	RENAULT TWINGO (C06) 03/1993-02/2007	Suspension Control Arm and Ball Joint Assembly - Front Left Lower
ARM976	301181397600	RENAULT TWINGO II (CNO) 03/2007-	Suspension Control Arm and Ball Joint Assembly - Front Right Lower
ARM977	301181397700	RENAULT TWINGO II (CNO) 03/2007-	Suspension Control Arm and Ball Joint Assembly - Front Left Lower
ARM978	301181397800	RENAULT LAGUNA III 10/2007-	Suspension Control Arm and Ball Joint Assembly - Front Right Lower
ARM979	301181397900	RENAULT LAGUNA III 10/2007-	Suspension Control Arm and Ball Joint Assembly - Front Left Lower
ARM980	301181398000	RENAULT MEGANE IV 2016-	Suspension Control Arm and Ball Joint Assembly - Front Right





 SHORT LONG			DESCRIPTION
ARM981	301181398100	RENAULT MEGANE IV 2016-	Suspension Control Arm and Ball Joint Assembly - Front Left
ARM982	301181398200	AUDI A3 8P1 06/2003-08/2012	Lateral Arm - Rear Right Lower
ARM982	301181398200	AUDI TT 8N3, ROADSTER, 8N9 02/1999-06/2006	Lateral Arm - Rear Right Lower
ARM982	301181398200	SEAT LEON 1P1 2006-2012	Lateral Arm - Rear Right Lower
ARM982	301181398200	SEAT TOLEDO III (5P2) 07/2006-05/2009	Lateral Arm - Rear Right Lower
ARM982	301181398200	SKODA OCTAVIA (1Z3), (1Z5) 06/2004-10/2012	Lateral Arm - Rear Right Lower
ARM982	301181398200	SKODA SUPERB (3T4) 04/2008-	Lateral Arm - Rear Right Lower
ARM982	301181398200	VOLKSWAGEN GOLF MK5/A5 10/2003-06/2009	Lateral Arm - Rear Right Lower
ARM982	301181398200	VOLKSWAGEN GTI MK5/A5 2006-2009	Lateral Arm - Rear Right Lower
ARM982	301181398200	VOLKSWAGEN Rabbit MK5/A5 10/2003-06/2009	Lateral Arm - Rear Right Lower
ARM983	301181398300	AUDI A3 8P1 06/2003-08/2012	Lateral Arm - Rear Left Lower
ARM983	301181398300	AUDI TT 8N3, ROADSTER, 8N9 02/1999-06/2006	Lateral Arm - Rear Left Lower
ARM983	301181398300	SEAT LEON 1P1 2006-2012	Lateral Arm - Rear Left Lower
ARM983	301181398300	SEAT TOLEDO III (5P2) 07/2006-05/2009	Lateral Arm - Rear Left Lower
ARM983	301181398300	SKODA OCTAVIA (1Z3), (1Z5) 06/2004-10/2012	Lateral Arm - Rear Left Lower
ARM983	301181398300	SKODA SUPERB (3T4) 04/2008-	Lateral Arm - Rear Left Lower
ARM983	301181398300	VOLKSWAGEN GOLF MK5/A5 10/2003-06/2009	Lateral Arm - Rear Left Lower
ARM983	301181398300	VOLKSWAGEN GTI MK5/A5 2006-2009	Lateral Arm - Rear Left Lower
ARM983	301181398300	VOLKSWAGEN Rabbit MK5/A5 10/2003-06/2009	Lateral Arm - Rear Left Lower
ARM984	301181398400	SEAT CORDOBA (6L2) 09/2002-11/2009	Suspension Control Arm and Ball Joint Assembly - Front Right Lower
ARM984	301181398400	SEAT IBIZA IV (6L1) 02/2002-11/2009	Suspension Control Arm and Ball Joint Assembly - Front Right Lower
ARM984	301181398400	SKODA FABIA (6Y2) 08/1999-11/2006	Suspension Control Arm and Ball Joint Assembly - Front Right Lower
ARM984	301181398400	VOLKSWAGEN POLO (9N) 10/2001-05/2009	Suspension Control Arm and Ball Joint Assembly - Front Right Lower
ARM985	301181398500	SEAT CORDOBA (6L2) 09/2002-11/2009	Suspension Control Arm and Ball Joint Assembly - Front Left Lower
ARM985	301181398500	SEAT IBIZA IV (6L1) 02/2002-11/2009	Suspension Control Arm and Ball Joint Assembly - Front Left Lower
ARM985	301181398500	SKODA FABIA (6Y2) 08/1999-11/2006	Suspension Control Arm and Ball Joint Assembly - Front Left Lower
ARM985	301181398500	VOLKSWAGEN POLO (9N) 10/2001-05/2009	Suspension Control Arm and Ball Joint Assembly - Front Left Lower
ARM986	301181398600	SEAT IBIZA V (6R) 03/2008-	Suspension Control Arm and Ball Joint Assembly - Front Right Lower
ARM986	301181398600	SKODA FABIA (5J) 12/2006-09/2014	Suspension Control Arm and Ball Joint Assembly - Front Right Lower



 SHORT LONG			DESCRIPTION
ARM986	301181398600	SKODA PRAKTIK 03/2007-	Suspension Control Arm and Ball Joint Assembly - Front Right Lower
ARM986	301181398600	SKODA ROOMSTER (5J) 07/2006-	Suspension Control Arm and Ball Joint Assembly - Front Right Lower
ARM987	301181398700	SEAT IBIZA V (6R) 03/2008-	Suspension Control Arm and Ball Joint Assembly - Front Left Lower
ARM987	301181398700	SKODA FABIA (5J) 12/2006-09/2014	Suspension Control Arm and Ball Joint Assembly - Front Left Lower
ARM987	301181398700	SKODA PRAKTIK 03/2007-	Suspension Control Arm and Ball Joint Assembly - Front Left Lower
ARM987	301181398700	SKODA ROOMSTER (5J) 07/2006-	Suspension Control Arm and Ball Joint Assembly - Front Left Lower
ARM988	301181398800	AUDI A3 8P1 06/2003-08/2012	Lateral Arm - Rear Lower
ARM988	301181398800	AUDI TT 8J3 07/2006-06/2014	Lateral Arm - Rear Lower
ARM988	301181398800	SEAT ALTEA V 03/2004-	Lateral Arm - Rear Lower
ARM988	301181398800	SEAT LEON 1P1 2006-2012	Lateral Arm - Rear Lower
ARM988	301181398800	SEAT TOLEDO III (5P2) 07/2006-05/2009	Lateral Arm - Rear Lower
ARM988	301181398800	SKODA YETI (5L) 05/2009-	Lateral Arm - Rear Lower
ARM988	301181398800	VOLKSWAGEN BEETLE A5 04/2011-	Lateral Arm - Rear Lower
ARM988	301181398800	VOLKSWAGEN GOLF MK5/A5 10/2003-06/2009	Lateral Arm - Rear Lower
ARM988	301181398800	VOLKSWAGEN GTI MK5/A5 2006-2009	Lateral Arm - Rear Lower
ARM988	301181398800	VOLKSWAGEN JETTA IV (162) 11/2010-	Lateral Arm - Rear Lower
ARM988	301181398800	VOLKSWAGEN PASSAT B7 08/2010-04/2015	Lateral Arm - Rear Lower
ARM988	301181398800	VOLKSWAGEN Rabbit MK5/A5 10/2003-06/2009	Lateral Arm - Rear Lower
ARM988	301181398800	VOLKSWAGEN TIGUAN 1st Gen 09/2007-2016	Lateral Arm - Rear Lower
ARM989	301181398900	SEAT LEON (5F1) 12/2012-	Suspension Control Arm and Ball Joint Assembly - Front Right Lower
ARM989	301181398900	SEAT LEON 1P1 2006-2012	Suspension Control Arm and Ball Joint Assembly - Front Right Lower
ARM989	301181398900	SEAT TOLEDO III (5P2) 07/2006-05/2009	Suspension Control Arm and Ball Joint Assembly - Front Right Lower
ARM989	301181398900	SKODA SUPERB (3T4) 04/2008-	Suspension Control Arm and Ball Joint Assembly - Front Right Lower
ARM989	301181398900	SKODA YETI (5L) 05/2009-	Suspension Control Arm and Ball Joint Assembly - Front Right Lower
ARM989	301181398900	VOLKSWAGEN GOLF MK6/A6 2010-2013	Suspension Control Arm and Ball Joint Assembly - Front Right Lower
ARM989	301181398900	VOLKSWAGEN JETTA MK5/A5 08/2005-10/2010	Suspension Control Arm and Ball Joint Assembly - Front Right Lower
ARM990	301181399000	SEAT LEON (5F1) 12/2012-	Suspension Control Arm and Ball Joint Assembly - Front Left Lower
ARM990	301181399000	SEAT LEON 1P1 2006-2012	Suspension Control Arm and Ball Joint Assembly - Front Left Lower
ARM990	301181399000	SEAT TOLEDO III (5P2) 07/2006-05/2009	Suspension Control Arm and Ball Joint Assembly - Front Left Lower



 SHORT LONG			DESCRIPTION
ARM990	301181399000	SKODA SUPERB (3T4) 04/2008-	Suspension Control Arm and Ball Joint Assembly - Front Left Lower
ARM990	301181399000	SKODA YETI (5L) 05/2009-	Suspension Control Arm and Ball Joint Assembly - Front Left Lower
ARM990	301181399000	VOLKSWAGEN GOLF MK6/A6 2010-2013	Suspension Control Arm and Ball Joint Assembly - Front Left Lower
ARM990	301181399000	VOLKSWAGEN JETTA MK5/A5 08/2005-10/2010	Suspension Control Arm and Ball Joint Assembly - Front Left Lower
ARM991	301181399100	CHEVROLET METRO 1998-2001	Suspension Control Arm and Ball Joint Assembly - Front Right
ARM991	301181399100	SUZUKI SWIFT II (AH,AJ) (EA,MA) 03/1989-12/2004	Suspension Control Arm and Ball Joint Assembly - Front Right
ARM992	301181399200	CHEVROLET METRO 1998-2001	Suspension Control Arm and Ball Joint Assembly - Front Left
ARM992	301181399200	SUZUKI SWIFT II (AH,AJ) (EA,MA) 03/1989-12/2004	Suspension Control Arm and Ball Joint Assembly - Front Left
ARM993	301181399300	OPEL AGILA (B) 09/2007-12/2014	Suspension Control Arm and Ball Joint Assembly - Front Right Lower
ARM993	301181399300	SUZUKI SPLASH 01/2008-	Suspension Control Arm and Ball Joint Assembly - Front Right Lower
ARM993	301181399300	SUZUKI SWIFT III (SG) 02/2005-09/2010	Suspension Control Arm and Ball Joint Assembly - Front Right Lower
ARM994	301181399400	OPEL AGILA (B) 09/2007-12/2014	Suspension Control Arm and Ball Joint Assembly - Front Left Lower
ARM994	301181399400	SUZUKI SPLASH 01/2008-	Suspension Control Arm and Ball Joint Assembly - Front Left Lower
ARM994	301181399400	SUZUKI SWIFT III (SG) 02/2005-09/2010	Suspension Control Arm and Ball Joint Assembly - Front Left Lower
ARM995	301181399500	FIAT SEDICI 06/2006-10/2014	Suspension Control Arm and Ball Joint Assembly - Front Right Lower
ARM995	301181399500	SUZUKI SX4 (GY) 06/2006-07/2013	Suspension Control Arm and Ball Joint Assembly - Front Right Lower
ARM996	301181399600	FIAT SEDICI 06/2006-10/2014	Suspension Control Arm and Ball Joint Assembly - Front Left Lower
ARM996	301181399600	SUZUKI SX4 (GY) 06/2006-07/2013	Suspension Control Arm and Ball Joint Assembly - Front Left Lower
ARM997	301181399700	LEXUS HS250h 2010-2012	Suspension Control Arm and Ball Joint Assembly - Front Right Lower
ARM997	301181399700	SCION TC 2nd Gen AGT20 2011-2016	Suspension Control Arm and Ball Joint Assembly - Front Right Lower
ARM997	301181399700	SCION XB 2nd Gen 2008-2013	Suspension Control Arm and Ball Joint Assembly - Front Right Lower
ARM997	301181399700	TOYOTA AURIS I 02/2007-06/2013	Suspension Control Arm and Ball Joint Assembly - Front Right Lower
ARM997	301181399700	TOYOTA AURIS II 07/2013-	Suspension Control Arm and Ball Joint Assembly - Front Right Lower
ARM997	301181399700	TOYOTA COROLLA E140 02/2007-06/2013	Suspension Control Arm and Ball Joint Assembly - Front Right Lower
ARM997	301181399700	TOYOTA COROLLA E170 07/2013-	Suspension Control Arm and Ball Joint Assembly - Front Right Lower



			DESCRIPTION
SHORT	LONG		
ARM998	301181399800	LEXUS HS250h 2010-2012	Suspension Control Arm and Ball Joint Assembly - Front Left Lower
ARM998	301181399800	SCION TC 2nd Gen AGT20 2011-2016	Suspension Control Arm and Ball Joint Assembly - Front Left Lower
ARM998	301181399800	SCION XB 2nd Gen 2008-2013	Suspension Control Arm and Ball Joint Assembly - Front Left Lower
ARM998	301181399800	TOYOTA AURIS I 02/2007-06/2013	Suspension Control Arm and Ball Joint Assembly - Front Left Lower
ARM998	301181399800	TOYOTA AURIS II 07/2013-	Suspension Control Arm and Ball Joint Assembly - Front Left Lower
ARM998	301181399800	TOYOTA COROLLA E140 02/2007-06/2013	Suspension Control Arm and Ball Joint Assembly - Front Left Lower
ARM998	301181399800	TOYOTA COROLLA E170 07/2013-	Suspension Control Arm and Ball Joint Assembly - Front Left Lower
ARM999	301181399900	LEXUS LX470 J100 1998-2007	Suspension Control Arm and Ball Joint Assembly - Front Right Upper
ARM999	301181399900	TOYOTA LAND CRUISER J100 01/1998-08/2007	Suspension Control Arm and Ball Joint Assembly - Front Right Upper
ARM1001	301181310010	LEXUS LX470 J100 1998-2007	Suspension Control Arm and Ball Joint Assembly - Front Left Upper
ARM1001	301181310010	TOYOTA LAND CRUISER J100 01/1998-08/2007	Suspension Control Arm and Ball Joint Assembly - Front Left Upper
ARM1002	301181310020	TOYOTA LAND CRUISER J100 01/1998-08/2007	Suspension Control Arm and Ball Joint Assembly - Front Right Lower
ARM1003	301181310030	TOYOTA LAND CRUISER J100 01/1998-08/2007	Suspension Control Arm and Ball Joint Assembly - Front Left Lower
ARM1004	301181310040	TOYOTA RAV4 XA10 1995-06/2000	Suspension Control Arm and Ball Joint Assembly - Front Right Lower
ARM1005	301181310050	TOYOTA RAV4 XA10 1995-06/2000	Suspension Control Arm and Ball Joint Assembly - Front Left Lower
ARM1006	301181310060	TOYOTA HILUX III 2WD Pick-Up 08/2005-2015	Suspension Control Arm and Ball Joint Assembly - Front Right Upper
ARM1007	301181310070	TOYOTA HILUX III 2WD Pick-Up 08/2005-2015	Suspension Control Arm and Ball Joint Assembly - Front Left Upper
ARM1008	301181310080	TOYOTA HILUX III 2WD Pick-Up 08/2005-2015	Suspension Control Arm and Ball Joint Assembly - Right Lower
ARM1009	301181310090	TOYOTA HILUX III 2WD Pick-Up 08/2005-2015	Suspension Control Arm and Ball Joint Assembly - Left Lower
ARM1010	301181310100	TOYOTA HILUX III 4WD Pick-Up 08/2005-2015	Suspension Control Arm and Ball Joint Assembly - Front Right Upper
ARM1011	301181310110	TOYOTA HILUX III 4WD Pick-Up 08/2005-2015	Suspension Control Arm and Ball Joint Assembly - Front Left Upper
ARM1012	301181310120	TOYOTA HILUX III 4WD Pick-Up 08/2005-2015	Suspension Control Arm and Ball Joint Assembly - Front Right Lower
ARM1013	301181310130	TOYOTA HILUX III 4WD Pick-Up 08/2005-2015	Suspension Control Arm and Ball Joint Assembly - Front Left Lower
ARM1014	301181310140	TOYOTA ECHO XP10 1999-2005	Suspension Control Arm and Ball Joint Assembly - Front Right Lower
ARM1014	301181310140	TOYOTA YARIS (P1) 04/1999-10/2005	Suspension Control Arm and Ball Joint Assembly - Front Right Lower





 SHORT LONG			DESCRIPTION
ARM1015	301181310150	TOYOTA ECHO XP10 1999-2005	Suspension Control Arm and Ball Joint Assembly - Front Left Lower
ARM1015	301181310150	TOYOTA YARIS (P1) 04/1999-10/2005	Suspension Control Arm and Ball Joint Assembly - Front Left Lower
ARM1016	301181310160	TOYOTA ECHO XP10 1999-2005	Suspension Control Arm and Ball Joint Assembly - Front Right Lower
ARM1016	301181310160	TOYOTA YARIS (P1) 04/1999-10/2005	Suspension Control Arm and Ball Joint Assembly - Front Right Lower
ARM1017	301181310170	TOYOTA ECHO XP10 1999-2005	Suspension Control Arm and Ball Joint Assembly - Front Left Lower
ARM1017	301181310170	TOYOTA YARIS (P1) 04/1999-10/2005	Suspension Control Arm and Ball Joint Assembly - Front Left Lower
ARM1018	301181310180	TOYOTA YARIS (P13) 10/2010-	Suspension Control Arm and Ball Joint Assembly - Front Right Lower
ARM1018	301181310180	TOYOTA YARIS (P9) 11/2005-09/2010	Suspension Control Arm and Ball Joint Assembly - Front Right Lower
ARM1019	301181310190	TOYOTA YARIS (P13) 10/2010-	Suspension Control Arm and Ball Joint Assembly - Front Left Lower
ARM1019	301181310190	TOYOTA YARIS (P9) 11/2005-09/2010	Suspension Control Arm and Ball Joint Assembly - Front Left Lower
ARM1022	301181310220	TOYOTA RAV4 XA20 07/2000-11/2005	Suspension Control Arm and Ball Joint Assembly - Front Right Lower
ARM1023	301181310230	TOYOTA RAV4 XA20 07/2000-11/2005	Suspension Control Arm and Ball Joint Assembly - Front Left Lower
ARM1024	301181310240	TOYOTA RAV4 XA30 12/2005-2012	Suspension Control Arm and Ball Joint Assembly - Front Right Lower
ARM1025	301181310250	TOYOTA RAV4 XA30 12/2005-2012	Suspension Control Arm and Ball Joint Assembly - Front Left Lower
ARM1026	301181310260	TOYOTA RAV4 XA40 2013-	Lateral Arm - Rear
ARM1027	301181310270	TOYOTA RAV4 XA40 2013-	Suspension Control Arm and Ball Joint Assembly - Front Right Lower
ARM1028	301181310280	TOYOTA RAV4 XA40 2013-	Suspension Control Arm and Ball Joint Assembly - Front Left Lower
ARM1029	301181310290	TOYOTA COROLLA E120 02/2002-01/2007	Suspension Control Arm and Ball Joint Assembly - Front Right Lower
ARM1030	301181310300	TOYOTA COROLLA E120 02/2002-01/2007	Suspension Control Arm and Ball Joint Assembly - Front Left Lower
ARM1031	301181310310	TOYOTA IQ 01/2009-2016	Suspension Control Arm and Ball Joint Assembly - Front Right Lower
ARM1032	301181310320	TOYOTA IQ 01/2009-2016	Suspension Control Arm and Ball Joint Assembly - Front Left Lower
ARM1033	301181310330	AUDI Q7 4L 03/2006-08/2010	Suspension Control Arm and Ball Joint Assembly - Front Upper
ARM1033	301181310330	PORSCHE CAYENNE 92A 2011-	Suspension Control Arm and Ball Joint Assembly - Front Upper
ARM1033	301181310330	PORSCHE CAYENNE 955 09/2002-08/2010	Suspension Control Arm and Ball Joint Assembly - Front Upper
ARM1033	301181310330	VOLKSWAGEN GOL 2002-2010	Suspension Control Arm and Ball Joint Assembly - Front Upper
ARM1033	301181310330	VOLKSWAGEN TOUAREG (7LA,7L6,7L7) 10/2002-05/2010	Suspension Control Arm and Ball Joint Assembly - Front Upper



 SHORT LONG			DESCRIPTION
ARM1034	301181310340	VOLKSWAGEN GOL 2002-2010	Lateral Arm - Rear Upper Forward
ARM1034	301181310340	VOLKSWAGEN TOUAREG (7LA,7L6,7L7) 10/2002-05/2010	Lateral Arm - Rear Upper Forward
ARM1035	301181310350	PORSCHE CAYENNE 955 09/2002-08/2010	Suspension Control Arm and Ball Joint Assembly - Front Right
ARM1035	301181310350	VOLKSWAGEN GOL 2002-2010	Suspension Control Arm and Ball Joint Assembly - Front Right
ARM1035	301181310350	VOLKSWAGEN TOUAREG (7LA,7L6,7L7) 10/2002-05/2010	Suspension Control Arm and Ball Joint Assembly - Front Right
ARM1036	301181310360	PORSCHE CAYENNE 955 09/2002-08/2010	Suspension Control Arm and Ball Joint Assembly - Front Left
ARM1036	301181310360	VOLKSWAGEN GOL 2002-2010	Suspension Control Arm and Ball Joint Assembly - Front Left
ARM1036	301181310360	VOLKSWAGEN TOUAREG (7LA,7L6,7L7) 10/2002-05/2010	Suspension Control Arm and Ball Joint Assembly - Front Left
ARM1037	301181310370	AUDI A3 8P1 06/2003-08/2012	Lateral Arm - Rear Right Forward
ARM1037	301181310370	AUDI TT 8J3 07/2006-06/2014	Lateral Arm - Rear Right Forward
ARM1037	301181310370	VOLKSWAGEN TOURAN (1T3) 06/2010-	Lateral Arm - Rear Right Forward
ARM1038	301181310380	AUDI A3 8P1 06/2003-08/2012	Lateral Arm - Rear Left Forward
ARM1038	301181310380	AUDI TT 8J3 07/2006-06/2014	Lateral Arm - Rear Left Forward
ARM1038	301181310380	VOLKSWAGEN TOURAN (1T3) 06/2010-	Lateral Arm - Rear Left Forward
ARM1039	301181310390	AUDI A3 8L1 09/1996-05/2003	Lateral Arm - Rear Lower
ARM1039	301181310390	AUDI Q3 8U 06/2011-2016	Lateral Arm - Rear Lower
ARM1039	301181310390	AUDI TT 8J3 07/2006-06/2014	Lateral Arm - Rear Lower
ARM1039	301181310390	SEAT ALTEA V 03/2004-	Lateral Arm - Rear Lower
ARM1039	301181310390	SEAT LEON (5F1) 12/2012-	Lateral Arm - Rear Lower
ARM1039	301181310390	SEAT LEON 1P1 2006-2012	Lateral Arm - Rear Lower
ARM1039	301181310390	SEAT TOLEDO III (5P2) 07/2006-05/2009	Lateral Arm - Rear Lower
ARM1039	301181310390	SKODA OCTAVIA (1Z3), (1Z5) 06/2004-10/2012	Lateral Arm - Rear Lower
ARM1039	301181310390	SKODA YETI (5L) 05/2009-	Lateral Arm - Rear Lower
ARM1039	301181310390	VOLKSWAGEN GOLF MK6/A6 2010-2013	Lateral Arm - Rear Lower
ARM1039	301181310390	VOLKSWAGEN GOLF MK7/MQB 11/2012-	Lateral Arm - Rear Lower
ARM1039	301181310390	VOLKSWAGEN JETTA IV (162) 11/2010-	Lateral Arm - Rear Lower
ARM1039	301181310390	VOLKSWAGEN JETTA MK5/A5 08/2005-10/2010	Lateral Arm - Rear Lower
ARM1039	301181310390	VOLKSWAGEN PASSAT B6 09/2005-07/2010	Lateral Arm - Rear Lower
ARM1039	301181310390	VOLKSWAGEN PASSAT B7 08/2010-04/2015	Lateral Arm - Rear Lower
ARM1039	301181310390	VOLKSWAGEN TIGUAN 1st Gen 09/2007-2016	Lateral Arm - Rear Lower
ARM1039	301181310390	VOLKSWAGEN TOURAN (1T1,1T2) 02/2003-05/2010	Lateral Arm - Rear Lower
ARM1039	301181310390	VOLKSWAGEN TOURAN (1T3) 06/2010-	Lateral Arm - Rear Lower
ARM1040	301181310400	VOLKSWAGEN BEETLE A5 04/2011-	Suspension Control Arm and Ball Joint Assembly - Front Right Lower





 SHORT LONG			DESCRIPTION
ARM1041	301181310410	VOLKSWAGEN BEETLE A5 04/2011-	Suspension Control Arm and Ball Joint Assembly - Front Left Lower
ARM1042	301181310420	VOLKSWAGEN AMAROK 09/2010-	Suspension Control Arm and Ball Joint Assembly - Front Right Upper
ARM1043	301181310430	VOLKSWAGEN AMAROK 09/2010-	Suspension Control Arm and Ball Joint Assembly - Front Left Upper
ARM1044	301181310440	VOLKSWAGEN AMAROK 09/2010-	Suspension Control Arm and Ball Joint Assembly - Front Right Lower
ARM1045	301181310450	VOLKSWAGEN AMAROK 09/2010-	Suspension Control Arm and Ball Joint Assembly - Front Left Lower
ARM1046	301181310460	AUDI Q3 8U 06/2011-2016	Suspension Control Arm and Ball Joint Assembly - Front Right
ARM1046	301181310460	VOLKSWAGEN JETTA MK5/A5 08/2005-10/2010	Suspension Control Arm and Ball Joint Assembly - Front Right
ARM1046	301181310460	VOLKSWAGEN PASSAT B6 09/2005-07/2010	Suspension Control Arm and Ball Joint Assembly - Front Right
ARM1046	301181310460	VOLKSWAGEN PASSAT B7 08/2010-04/2015	Suspension Control Arm and Ball Joint Assembly - Front Right
ARM1046	301181310460	VOLKSWAGEN TIGUAN 1st Gen 09/2007-2016	Suspension Control Arm and Ball Joint Assembly - Front Right
ARM1047	301181310470	AUDI Q3 8U 06/2011-2016	Suspension Control Arm and Ball Joint Assembly - Front Left
ARM1047	301181310470	VOLKSWAGEN JETTA MK5/A5 08/2005-10/2010	Suspension Control Arm and Ball Joint Assembly - Front Left
ARM1047	301181310470	VOLKSWAGEN PASSAT B6 09/2005-07/2010	Suspension Control Arm and Ball Joint Assembly - Front Left
ARM1047	301181310470	VOLKSWAGEN PASSAT B7 08/2010-04/2015	Suspension Control Arm and Ball Joint Assembly - Front Left
ARM1047	301181310470	VOLKSWAGEN TIGUAN 1st Gen 09/2007-2016	Suspension Control Arm and Ball Joint Assembly - Front Left
ARM1048	301181310480	AUDI A3 8P1 06/2003-08/2012	Suspension Control Arm and Ball Joint Assembly - Front Right Lower
ARM1048	301181310480	SEAT ALTEA V 03/2004-	Suspension Control Arm and Ball Joint Assembly - Front Right Lower
ARM1048	301181310480	SKODA OCTAVIA (1Z3), (1Z5) 06/2004-10/2012	Suspension Control Arm and Ball Joint Assembly - Front Right Lower
ARM1048	301181310480	VOLKSWAGEN CADDY Typ 2K 03/2004-04/2015	Suspension Control Arm and Ball Joint Assembly - Front Right Lower
ARM1048	301181310480	VOLKSWAGEN GOLF MK5/A5 10/2003-06/2009	Suspension Control Arm and Ball Joint Assembly - Front Right Lower
ARM1048	301181310480	VOLKSWAGEN GTI MK5/A5 2006-2009	Suspension Control Arm and Ball Joint Assembly - Front Right Lower
ARM1048	301181310480	VOLKSWAGEN Rabbit MK5/A5 10/2003-06/2009	Suspension Control Arm and Ball Joint Assembly - Front Right Lower
ARM1048	301181310480	VOLKSWAGEN TOURAN (1T1,1T2) 02/2003-05/2010	Suspension Control Arm and Ball Joint Assembly - Front Right Lower
ARM1049	301181310490	AUDI A3 8P1 06/2003-08/2012	Suspension Control Arm and Ball Joint Assembly - Front Left Lower
ARM1049	301181310490	SEAT ALTEA V 03/2004-	Suspension Control Arm and Ball Joint Assembly - Front Left Lower



 SHORT LONG			DESCRIPTION
ARM1049	301181310490	SKODA OCTAVIA (1Z3), (1Z5) 06/2004-10/2012	Suspension Control Arm and Ball Joint Assembly - Front Left Lower
ARM1049	301181310490	VOLKSWAGEN CADDY Typ 2K 03/2004-04/2015	Suspension Control Arm and Ball Joint Assembly - Front Left Lower
ARM1049	301181310490	VOLKSWAGEN GOLF MK5/A5 10/2003-06/2009	Suspension Control Arm and Ball Joint Assembly - Front Left Lower
ARM1049	301181310490	VOLKSWAGEN GTI MK5/A5 2006-2009	Suspension Control Arm and Ball Joint Assembly - Front Left Lower
ARM1049	301181310490	VOLKSWAGEN Rabbit MK5/A5 10/2003-06/2009	Suspension Control Arm and Ball Joint Assembly - Front Left Lower
ARM1049	301181310490	VOLKSWAGEN TOURAN (1T1,1T2) 02/2003-05/2010	Suspension Control Arm and Ball Joint Assembly - Front Left Lower
ARM1050	301181310500	AUDI A3 8P1 06/2003-08/2012	Suspension Control Arm and Ball Joint Assembly - Front Right Lower
ARM1050	301181310500	SEAT ALTEA V 03/2004-	Suspension Control Arm and Ball Joint Assembly - Front Right Lower
ARM1050	301181310500	SKODA OCTAVIA (1Z3), (1Z5) 06/2004-10/2012	Suspension Control Arm and Ball Joint Assembly - Front Right Lower
ARM1050	301181310500	VOLKSWAGEN CADDY Typ 2K 03/2004-04/2015	Suspension Control Arm and Ball Joint Assembly - Front Right Lower
ARM1050	301181310500	VOLKSWAGEN GOLF MK5/A5 10/2003-06/2009	Suspension Control Arm and Ball Joint Assembly - Front Right Lower
ARM1050	301181310500	VOLKSWAGEN GTI MK5/A5 2006-2009	Suspension Control Arm and Ball Joint Assembly - Front Right Lower
ARM1050	301181310500	VOLKSWAGEN Rabbit MK5/A5 10/2003-06/2009	Suspension Control Arm and Ball Joint Assembly - Front Right Lower
ARM1050	301181310500	VOLKSWAGEN TOURAN (1T1,1T2) 02/2003-05/2010	Suspension Control Arm and Ball Joint Assembly - Front Right Lower
ARM1050	301181310500	VOLKSWAGEN TOURAN (1T3) 06/2010-	Suspension Control Arm and Ball Joint Assembly - Front Right Lower
ARM1051	301181310510	AUDI A3 8P1 06/2003-08/2012	Suspension Control Arm and Ball Joint Assembly - Front Left Lower
ARM1051	301181310510	SEAT ALTEA V 03/2004-	Suspension Control Arm and Ball Joint Assembly - Front Left Lower
ARM1051	301181310510	SKODA OCTAVIA (1Z3), (1Z5) 06/2004-10/2012	Suspension Control Arm and Ball Joint Assembly - Front Left Lower
ARM1051	301181310510	VOLKSWAGEN CADDY Typ 2K 03/2004-04/2015	Suspension Control Arm and Ball Joint Assembly - Front Left Lower
ARM1051	301181310510	VOLKSWAGEN GOLF MK5/A5 10/2003-06/2009	Suspension Control Arm and Ball Joint Assembly - Front Left Lower
ARM1051	301181310510	VOLKSWAGEN GTI MK5/A5 2006-2009	Suspension Control Arm and Ball Joint Assembly - Front Left Lower
ARM1051	301181310510	VOLKSWAGEN Rabbit MK5/A5 10/2003-06/2009	Suspension Control Arm and Ball Joint Assembly - Front Left Lower
ARM1051	301181310510	VOLKSWAGEN TOURAN (1T1,1T2) 02/2003-05/2010	Suspension Control Arm and Ball Joint Assembly - Front Left Lower
ARM1051	301181310510	VOLKSWAGEN TOURAN (1T3) 06/2010-	Suspension Control Arm and Ball Joint Assembly - Front Left Lower
ARM1052	301181310520	SEAT Mii (KYF) 10/2011-	Suspension Control Arm and Ball Joint Assembly - Front Right Lower



 SHORT LONG			DESCRIPTION
ARM1052	301181310520	VOLKSWAGEN Up! 12/2011-2016	Suspension Control Arm and Ball Joint Assembly - Front Right Lower
ARM1053	301181310530	SEAT Mii (KYF) 10/2011-	Suspension Control Arm and Ball Joint Assembly - Front Left Lower
ARM1053	301181310530	VOLKSWAGEN Up! 12/2011-2016	Suspension Control Arm and Ball Joint Assembly - Front Left Lower
ARM1054	301181310540	AUDI A3 8P1 06/2003-08/2012	Lateral Arm - Rear Right Forward
ARM1054	301181310540	AUDI TT 8J3 07/2006-06/2014	Lateral Arm - Rear Right Forward
ARM1054	301181310540	SKODA SUPERB (3T4) 04/2008-	Lateral Arm - Rear Right Forward
ARM1054	301181310540	VOLKSWAGEN BEETLE A5 04/2011-	Lateral Arm - Rear Right Forward
ARM1054	301181310540	VOLKSWAGEN GOLF MK7/MQB 11/2012-	Lateral Arm - Rear Right Forward
ARM1055	301181310550	AUDI A3 8P1 06/2003-08/2012	Lateral Arm - Rear Left Forward
ARM1055	301181310550	AUDI TT 8J3 07/2006-06/2014	Lateral Arm - Rear Left Forward
ARM1055	301181310550	SKODA SUPERB (3T4) 04/2008-	Lateral Arm - Rear Left Forward
ARM1055	301181310550	VOLKSWAGEN BEETLE A5 04/2011-	Lateral Arm - Rear Left Forward
ARM1055	301181310550	VOLKSWAGEN GOLF MK7/MQB 11/2012-	Lateral Arm - Rear Left Forward
ARM1056	301181310560	SEAT LEON (5F1) 12/2012-	Lateral Arm - Rear Lower Forward
ARM1056	301181310560	VOLKSWAGEN GOLF MK7/MQB 11/2012-	Lateral Arm - Rear Lower Forward
ARM1057	301181310570	AUDI A3 8P1 06/2003-08/2012	Lateral Arm - Rear Upper
ARM1057	301181310570	AUDI A3 8V1 09/2012-	Lateral Arm - Rear Upper
ARM1057	301181310570	AUDI Q3 8U 06/2011-2016	Lateral Arm - Rear Upper
ARM1057	301181310570	AUDI TT 8J3 07/2006-06/2014	Lateral Arm - Rear Upper
ARM1057	301181310570	SEAT LEON (5F1) 12/2012-	Lateral Arm - Rear Upper
ARM1057	301181310570	SKODA OCTAVIA (5 E) 11/2012-	Lateral Arm - Rear Upper
ARM1057	301181310570	VOLKSWAGEN GOLF MK7/MQB 11/2012-	Lateral Arm - Rear Upper
ARM1057	301181310570	VOLKSWAGEN TOURAN (1T3) 06/2010-	Lateral Arm - Rear Upper
ARM1058	301181310580	VOLKSWAGEN GOLF MK7/MQB 11/2012-	Suspension Control Arm and Ball Joint Assembly - Front Right Lower
ARM1059	301181310590	VOLKSWAGEN GOLF MK7/MQB 11/2012-	Suspension Control Arm and Ball Joint Assembly - Front Left Lower
ARM1060	301181310600	VOLKSWAGEN JETTA IV (162) 11/2010-	Suspension Control Arm and Ball Joint Assembly - Front Right Lower
ARM1061	301181310610	VOLKSWAGEN JETTA IV (162) 11/2010-	Suspension Control Arm and Ball Joint Assembly - Front Left Lower
ARM1062	301181310620	VOLKSWAGEN CADDY Typ 2K 03/2004-04/2015	Suspension Control Arm and Ball Joint Assembly - Front Right Lower
ARM1063	301181310630	VOLKSWAGEN CADDY Typ 2K 03/2004-04/2015	Suspension Control Arm and Ball Joint Assembly - Front Left Lower
ARM1064	301181310640	VOLKSWAGEN PASSAT B7 08/2010-04/2015	Suspension Control Arm and Ball Joint Assembly - Front Right Lower
ARM1065	301181310650	VOLKSWAGEN PASSAT B7 08/2010-04/2015	Suspension Control Arm and Ball Joint Assembly - Front Left Lower
ARM1066	301181310660	SKODA KODIAQ (NS7) 2016-	Suspension Control Arm and Ball Joint Assembly - Front Right Lower
ARM1066	301181310660	VOLKSWAGEN PASSAT 3G2 2014-	Suspension Control Arm and Ball Joint Assembly - Front Right Lower



			DESCRIPTION
SHORT	LONG		
ARM1066	301181310660	VOLKSWAGEN TOURAN (5T1) 2015-	Suspension Control Arm and Ball Joint Assembly - Front Right Lower
ARM1067	301181310670	SKODA KODIAQ (NS7) 2016-	Suspension Control Arm and Ball Joint Assembly - Front Left Lower
ARM1067	301181310670	VOLKSWAGEN PASSAT 3G2 2014-	Suspension Control Arm and Ball Joint Assembly - Front Left Lower
ARM1067	301181310670	VOLKSWAGEN TOURAN (5T1) 2015-	Suspension Control Arm and Ball Joint Assembly - Front Left Lower
ARM1068	301181310680	VOLKSWAGEN TRANSPORTER T5 05/2003-04/2011	Suspension Control Arm - Front Right
ARM1069	301181310690	VOLKSWAGEN TRANSPORTER T5 05/2003-04/2011	Suspension Control Arm - Front Left
ARM1070	301181310700	FORD GALAXY 05/1995-04/2006	Suspension Control Arm - Front Right Lower
ARM1070	301181310700	SEAT ALHAMBRA (7V8,7V9) 04/1996-03/2010	Suspension Control Arm - Front Right Lower
ARM1070	301181310700	VOLKSWAGEN SHARAN (7M6,7M8,7M9) 05/1995-03/2010	Suspension Control Arm - Front Right Lower
ARM1071	301181310710	FORD GALAXY 05/1995-04/2006	Suspension Control Arm - Front Left
ARM1071	301181310710	SEAT ALHAMBRA (7V8,7V9) 04/1996-03/2010	Suspension Control Arm - Front Left
ARM1071	301181310710	VOLKSWAGEN SHARAN (7M6,7M8,7M9) 05/1995-03/2010	Suspension Control Arm - Front Left
ARM1072	301181310720	VOLKSWAGEN TRANSPORTER T5, facelift 05/2011-2016	Suspension Control Arm - Front Right Lower
ARM1072	301181310720	VOLKSWAGEN TRANSPORTER T6 2016-	Suspension Control Arm - Front Right Lower
ARM1073	301181310730	VOLKSWAGEN TRANSPORTER T5, facelift 05/2011-2016	Suspension Control Arm - Front Left Lower
ARM1073	301181310730	VOLKSWAGEN TRANSPORTER T6 2016-	Suspension Control Arm - Front Left Lower
ARM1074	301181310740	SEAT AROSA 05/1997-06/2004	Suspension Control Arm and Ball Joint Assembly - Front Right Lower
ARM1074	301181310740	VOLKSWAGEN POLO (6N1) 1994-09/2001	Suspension Control Arm and Ball Joint Assembly - Front Right Lower
ARM1075	301181310750	SEAT AROSA 05/1997-06/2004	Suspension Control Arm and Ball Joint Assembly - Front Left Lower
ARM1075	301181310750	VOLKSWAGEN POLO (6N1) 1994-09/2001	Suspension Control Arm and Ball Joint Assembly - Front Left Lower
ARM1076	301181310760	SKODA RAPID 07/2012-	Suspension Control Arm and Ball Joint Assembly - Front Right Lower
ARM1076	301181310760	VOLKSWAGEN POLO (6R) 06/2009-	Suspension Control Arm and Ball Joint Assembly - Front Right Lower
ARM1077	301181310770	SKODA RAPID 07/2012-	Suspension Control Arm and Ball Joint Assembly - Front Left Lower
ARM1077	301181310770	VOLKSWAGEN POLO (6R) 06/2009-	Suspension Control Arm and Ball Joint Assembly - Front Left Lower
ARM1078	301181310780	VOLVO S40 I (VS) 07/1995-12/2003	Suspension Control Arm and Ball Joint Assembly - Front Right Lower
ARM1078	301181310780	VOLVO V40 I (VW) 07/1995-06/2004	Suspension Control Arm and Ball Joint Assembly - Front Right Lower
ARM1079	301181310790	VOLVO S40 I (VS) 07/1995-12/2003	Suspension Control Arm and Ball Joint Assembly - Front Left Lower
ARM1079	301181310790	VOLVO V40 I (VW) 07/1995-06/2004	Suspension Control Arm and Ball Joint Assembly - Front Left Lower



			DESCRIPTION
SHORT	LONG		
ARM1080	301181310800	VOLVO S80 I (TS,XY) 05/1998-07/2006	Suspension Control Arm - Front Right Lower
ARM1081	301181310810	VOLVO S80 I (TS,XY) 05/1998-07/2006	Suspension Control Arm - Front Left
ARM1082	301181310820	VOLVO S60 I 07/2000-04/2010	Suspension Control Arm - Front Right
ARM1082	301181310820	VOLVO V70 II (P80) 03/2000-08/2007	Suspension Control Arm - Front Right
ARM1083	301181310830	VOLVO S60 I 07/2000-04/2010	Suspension Control Arm - Front Left
ARM1083	301181310830	VOLVO V70 II (P80) 03/2000-08/2007	Suspension Control Arm - Front Left
ARM1084	301181310840	VOLVO XC90 I 10/2002-10/2014	Suspension Control Arm - Front Right
ARM1085	301181310850	VOLVO XC90 I 10/2002-10/2014	Suspension Control Arm - Front Left
ARM1086	301181310860	VOLVO XC60 05/2008-2016	Suspension Control Arm and Ball Joint Assembly - Front Right Lower
ARM1087	301181310870	VOLVO XC60 05/2008-2016	Suspension Control Arm and Ball Joint Assembly - Front Left Lower
ARM1088	301181310880	VOLVO XC70 III 08/2007-	Suspension Control Arm and Ball Joint Assembly - Front Right Lower
ARM1089	301181310890	VOLVO XC70 III 08/2007-	Suspension Control Arm and Ball Joint Assembly - Front Left Lower
ARM1090	301181310900	VOLVO V40 II 03/2012-	Suspension Control Arm and Ball Joint Assembly - Front Right Lower
ARM1091	301181310910	VOLVO V40 II 03/2012-	Suspension Control Arm and Ball Joint Assembly - Front Left Lower
ARM1092	301181310920	TOYOTA LAND CRUISER J200 01/2008-	Suspension Control Arm and Ball Joint Assembly - Front Right Upper
ARM1093	301181310930	TOYOTA LAND CRUISER J200 01/2008-	Suspension Control Arm and Ball Joint Assembly - Front Left Upper
SSP0001	301191600010	BMW 740i E38 1994-2002	Steering Center Link - N/A
SSP0001	301191600010	BMW 740iL E38 1994-2002	Steering Center Link - N/A
SSP0001	301191600010	BMW 745i E38 1994-2002	Steering Center Link - N/A
SSP0001	301191600010	BMW 745Li E38 1994-2002	Steering Center Link - N/A
SSP0001	301191600010	BMW 750iL E38 1994-2002	Steering Center Link - N/A
SSP0002	301191600020	MERCEDES SLK200 (R170) 1997-2004	Steering Center Link - N/A
SSP0003	301191600030	AUDI A3 8L1 09/1996-05/2003	Steering Tie Rod - Front Inner
SSP0003	301191600030	SEAT LEON 1M1 03/1999-05/2006	Steering Tie Rod - Front Inner
SSP0003	301191600030	SEAT TOLEDO II (1M2) 03/1999-05/2006	Steering Tie Rod - Front Inner
SSP0003	301191600030	SKODA OCTAVIA (1U2), (1U5) 07/1996-05/2004	Steering Tie Rod - Front Inner
SSP0003	301191600030	VOLKSWAGEN BEETLE 9C1, 1C1 1998-2010	Steering Tie Rod - Front Inner
SSP0003	301191600030	VOLKSWAGEN GOLF MK4/A4 1998-09/2003	Steering Tie Rod - Front Inner
SSP0003	301191600030	VOLKSWAGEN JETTA MK4/A4 1998-09/2003	Steering Tie Rod - Front Inner
SSP0004	301191600040	AUDI A4 8D2, 8E5, B5 11/1994-10/2001	Steering Tie Rod - Front
SSP0004	301191600040	AUDI A4 8E2, 8E5, B6 12/2001-12/2004	Steering Tie Rod - Front
SSP0004	301191600040	AUDI A4 8EC, 8ED 11/2004-06/2008	Steering Tie Rod - Front
SSP0004	301191600040	AUDI A6 4B, C5 01/1997-01/2005	Steering Tie Rod - Front
SSP0004	301191600040	AUDI A8 4D2, 4D8 03/1994-09/2002	Steering Tie Rod - Front
SSP0004	301191600040	SKODA SUPERB (3U4) 02/2002-03/2008	Steering Tie Rod - Front





			DESCRIPTION
SHORT	LONG		
SSP0004	301191600040	VOLKSWAGEN PASSAT B5, B5.5 1997-08/2005	Steering Tie Rod - Front
SSP0005	301191600050	AUDI A3 8L1 09/1996-05/2003	Steering Tie Rod - Front
SSP0005	301191600050	SKODA OCTAVIA (1U2), (1U5) 07/1996-05/2004	Steering Tie Rod - Front
SSP0005	301191600050	VOLKSWAGEN BEETLE 9C1, 1C1 1998-2010	Steering Tie Rod - Front
SSP0005	301191600050	VOLKSWAGEN GOLF MK4/A4 1998-09/2003	Steering Tie Rod - Front
SSP0005	301191600050	VOLKSWAGEN JETTA MK4/A4 1998-09/2003	Steering Tie Rod - Front
SSP0006	301191600060	AUDI A4 8K2, 8K5 11/2007-06/2015	Steering Tie Rod - Front
SSP0006	301191600060	AUDI A5 8T3 2007-2015	Steering Tie Rod - Front
SSP0006	301191600060	AUDI Q5 8R 11/2008-2016	Steering Tie Rod - Front
SSP0007	301191600070	AUDI TT 8N3, ROADSTER, 8N9 02/1999-06/2006	Steering Tie Rod - Front
SSP0008	301191600080	AUDI A6 4F2, C6 02/2005-03/2011	Steering Tie Rod - Front
SSP0009	301191600090	AUDI A8 4E 10/2002-07/2010	Steering Tie Rod - Front
SSP0009	301191600090	VOLKSWAGEN PHAETON 04/2002-2016	Steering Tie Rod - Front
SSP0010	301191600100	AUDI A6 4G2, C5 04/2011-	Steering Tie Rod - Front
SSP0010	301191600100	AUDI A8 4H 08/2010-	Steering Tie Rod - Front
SSP0011	301191600110	AUDI A8 4H 08/2010-	Steering Tie Rod - Front Inner
SSP0011	301191600110	AUDI TT 8J3 07/2006-06/2014	Steering Tie Rod - Front Inner
SSP0012	301191600120	AUDI A2 02/2000-08/2005	Steering Tie Rod - Front
SSP0013	301191600130	AUDI A1 8X1 04/2010-	Steering Tie Rod - Front
SSP0014	301191600140	BMW 218i Active Tourer F45,F46 09/2014-	Steering Tie Rod - Front
SSP0014	301191600140	BMW 218i F 2014-	Steering Tie Rod - Front
SSP0014	301191600140	BMW 220i Active Tourer F45,F46 09/2014-	Steering Tie Rod - Front
SSP0014	301191600140	BMW 220i F 2014-	Steering Tie Rod - Front
SSP0014	301191600140	BMW 228i F 2014-	Steering Tie Rod - Front
SSP0014	301191600140	BMW 235i F 2014-	Steering Tie Rod - Front
SSP0014	301191600140	BMW X1 F48 2015-	Steering Tie Rod - Front
SSP0015	301191600150	BMW 120i E81, E82, E87, E88 09/2004-09/2012	Steering Tie Rod - Front
SSP0015	301191600150	BMW 125i E81, E82, E87, E88 09/2004-09/2012	Steering Tie Rod - Front
SSP0015	301191600150	BMW 128i E81, E82, E87, E88 09/2004-09/2012	Steering Tie Rod - Front
SSP0015	301191600150	BMW 130i E81, E82, E87, E88 09/2004-09/2012	Steering Tie Rod - Front
SSP0015	301191600150	BMW 135i E81, E82, E87, E88 09/2004-09/2012	Steering Tie Rod - Front
SSP0015	301191600150	BMW 323i E90/E91/E92/E93 01/2005-12/2011	Steering Tie Rod - Front
SSP0015	301191600150	BMW 325Ci E90/E91/E92/E93 01/2005-12/2011	Steering Tie Rod - Front
SSP0015	301191600150	BMW 325i E90/E91/E92/E93 01/2005-12/2011	Steering Tie Rod - Front
SSP0015	301191600150	BMW 328i E90/E91/E92/E93 01/2005-12/2011	Steering Tie Rod - Front



 SHORT LONG			DESCRIPTION
SSP0015	301191600150	BMW 330Ci E90/E91/E92/E93 01/2005-12/2011	Steering Tie Rod - Front
SSP0015	301191600150	BMW 330i E90/E91/E92/E93 01/2005-12/2011	Steering Tie Rod - Front
SSP0015	301191600150	BMW 335d E90/E91/E92/E93 01/2005-12/2011	Steering Tie Rod - Front
SSP0015	301191600150	BMW 335i E90/E91/E92/E93 01/2005-12/2011	Steering Tie Rod - Front
SSP0015	301191600150	BMW 335is E90/E91/E92/E93 01/2005-12/2011	Steering Tie Rod - Front
SSP0016	301191600160	BMW 120i E81, E82, E87, E88 09/2004-09/2012	Steering Tie Rod - Front Inner
SSP0016	301191600160	BMW 125i E81, E82, E87, E88 09/2004-09/2012	Steering Tie Rod - Front Inner
SSP0016	301191600160	BMW 128i E81, E82, E87, E88 09/2004-09/2012	Steering Tie Rod - Front Inner
SSP0016	301191600160	BMW 130i E81, E82, E87, E88 09/2004-09/2012	Steering Tie Rod - Front Inner
SSP0016	301191600160	BMW 135i E81, E82, E87, E88 09/2004-09/2012	Steering Tie Rod - Front Inner
SSP0016	301191600160	BMW 320i E90/E91/E92/E93 01/2005-12/2011	Steering Tie Rod - Front Inner
SSP0016	301191600160	BMW 323i E90/E91/E92/E93 01/2005-12/2011	Steering Tie Rod - Front Inner
SSP0016	301191600160	BMW 325Ci E90/E91/E92/E93 01/2005-12/2011	Steering Tie Rod - Front Inner
SSP0016	301191600160	BMW 325i E90/E91/E92/E93 01/2005-12/2011	Steering Tie Rod - Front Inner
SSP0016	301191600160	BMW 328i E90/E91/E92/E93 01/2005-12/2011	Steering Tie Rod - Front Inner
SSP0016	301191600160	BMW 330Ci E90/E91/E92/E93 01/2005-12/2011	Steering Tie Rod - Front Inner
SSP0016	301191600160	BMW 330i E90/E91/E92/E93 01/2005-12/2011	Steering Tie Rod - Front Inner
SSP0016	301191600160	BMW 335d E90/E91/E92/E93 01/2005-12/2011	Steering Tie Rod - Front Inner
SSP0016	301191600160	BMW 335i E90/E91/E92/E93 01/2005-12/2011	Steering Tie Rod - Front Inner
SSP0016	301191600160	BMW 335is E90/E91/E92/E93 01/2005-12/2011	Steering Tie Rod - Front Inner
SSP0017	301191600170	BMW 325xi E90/E91/E92/E93 (xDrive) 4x4 01/2005-12/2011	Steering Tie Rod - Front
SSP0017	301191600170	BMW 328i xDrive E90/E91/E92/E93 (xDrive) 4x4 01/2005-12/2011	Steering Tie Rod - Front
SSP0017	301191600170	BMW 328xi E90/E91/E92/E93 (xDrive) 4x4 01/2005-12/2011	Steering Tie Rod - Front
SSP0017	301191600170	BMW 330xi E90/E91/E92/E93 (xDrive) 4x4 01/2005-12/2011	Steering Tie Rod - Front
SSP0017	301191600170	BMW 335i xDrive E90/E91/E92/E93 (xDrive) 4x4 01/2005-12/2011	Steering Tie Rod - Front
SSP0017	301191600170	BMW 335xi E90/E91/E92/E93 (xDrive) 4x4 01/2005-12/2011	Steering Tie Rod - Front
SSP0017	301191600170	BMW X1 E84 (xDrive) 4x4 10/2009-2016	Steering Tie Rod - Front
SSP0018	301191600180	BMW 118i F 10/2011-	Steering Tie Rod - Front
SSP0018	301191600180	BMW 120i F 10/2011-	Steering Tie Rod - Front
SSP0018	301191600180	BMW 125i F 10/2011-	Steering Tie Rod - Front
SSP0018	301191600180	BMW 128i F 10/2011-	Steering Tie Rod - Front



 SHORT LONG			DESCRIPTION
SSP0018	301191600180	BMW 130i F 10/2011-	Steering Tie Rod - Front
SSP0018	301191600180	BMW 135i F 10/2011-	Steering Tie Rod - Front
SSP0018	301191600180	BMW 135is F 10/2011-	Steering Tie Rod - Front
SSP0018	301191600180	BMW 320i F 10/2011-	Steering Tie Rod - Front
SSP0018	301191600180	BMW 325i F 10/2011-	Steering Tie Rod - Front
SSP0018	301191600180	BMW 328d F 10/2011-	Steering Tie Rod - Front
SSP0018	301191600180	BMW 328i F 10/2011-	Steering Tie Rod - Front
SSP0018	301191600180	BMW 330i F 10/2011-	Steering Tie Rod - Front
SSP0018	301191600180	BMW 335i F 10/2011-	Steering Tie Rod - Front
SSP0018	301191600180	BMW 335is F 10/2011-	Steering Tie Rod - Front
SSP0018	301191600180	BMW 340i F 10/2011-	Steering Tie Rod - Front
SSP0018	301191600180	BMW 420i F 05/2014-	Steering Tie Rod - Front
SSP0018	301191600180	BMW 420i Gran Coupe F 05/2014-	Steering Tie Rod - Front
SSP0018	301191600180	BMW 428i F 05/2014-	Steering Tie Rod - Front
SSP0018	301191600180	BMW 428i Gran Coupe F 05/2014-	Steering Tie Rod - Front
SSP0018	301191600180	BMW 435i F 05/2014-	Steering Tie Rod - Front
SSP0018	301191600180	BMW 435i Gran Coupe F 05/2014-	Steering Tie Rod - Front
SSP0019	301191600190	BMW 525i E39 11/1995-06/2003	Steering Tie Rod - Front
SSP0019	301191600190	BMW 528i E39 11/1995-06/2003	Steering Tie Rod - Front
SSP0019	301191600190	BMW 530i E39 11/1995-06/2003	Steering Tie Rod - Front
SSP0020	301191600200	BMW 320i E46 02/1998-04/2005	Steering Tie Rod - Front
SSP0020	301191600200	BMW 323Ci E46 02/1998-04/2005	Steering Tie Rod - Front
SSP0020	301191600200	BMW 323i E46 02/1998-04/2005	Steering Tie Rod - Front
SSP0020	301191600200	BMW 325Ci E46 02/1998-04/2005	Steering Tie Rod - Front
SSP0020	301191600200	BMW 325i E46 02/1998-04/2005	Steering Tie Rod - Front
SSP0020	301191600200	BMW 330Ci E46 02/1998-04/2005	Steering Tie Rod - Front
SSP0020	301191600200	BMW 330i E46 02/1998-04/2005	Steering Tie Rod - Front
SSP0020	301191600200	BMW Z4 E85 02/2003-02/2009	Steering Tie Rod - Front
SSP0021	301191600210	BMW 745i E65, E66, E67 01/2001-09/2008	Steering Tie Rod - Front
SSP0021	301191600210	BMW 745Li E65, E66, E67 01/2001-09/2008	Steering Tie Rod - Front
SSP0021	301191600210	BMW 750i E65, E66, E67 01/2001-09/2008	Steering Tie Rod - Front
SSP0021	301191600210	BMW 750Li E65, E66, E67 01/2001-09/2008	Steering Tie Rod - Front
SSP0021	301191600210	BMW 760i E65, E66, E67 01/2001-09/2008	Steering Tie Rod - Front
SSP0021	301191600210	BMW 760Li E65, E66, E67 01/2001-09/2008	Steering Tie Rod - Front
SSP0022	301191600220	BMW 525i E60 - E61 07/2003-03/2010	Steering Tie Rod - Front
SSP0022	301191600220	BMW 528i E60 - E61 07/2003-03/2010	Steering Tie Rod - Front
SSP0022	301191600220	BMW 530i E60 - E61 07/2003-03/2010	Steering Tie Rod - Front
SSP0022	301191600220	BMW 535i E60 - E61 07/2003-03/2010	Steering Tie Rod - Front
SSP0022	301191600220	BMW 545i E60 - E61 07/2003-03/2010	Steering Tie Rod - Front
SSP0022	301191600220	BMW 550i E60 - E61 07/2003-03/2010	Steering Tie Rod - Front
SSP0022	301191600220	BMW 645Ci E63, E64 01/2004-11/2010	Steering Tie Rod - Front





 SHORT LONG			DESCRIPTION
SSP0022	301191600220	BMW 650Ci E63, E64 01/2004-11/2010	Steering Tie Rod - Front
SSP0022	301191600220	BMW 650i E63, E64 01/2004-11/2010	Steering Tie Rod - Front
SSP0023	301191600230	BMW X3 E83 01/2004-08/2010	Steering Tie Rod - Front
SSP0023	301191600230	BMW X5 E53 05/2000-01/2007	Steering Tie Rod - Front
SSP0023	301191600230	BMW X5 E70 02/2007-12/2012	Steering Tie Rod - Front
SSP0023	301191600230	BMW X6 E71, E72 04/2008-07/2014	Steering Tie Rod - Front
SSP0024	301191600240	BMW X5 F15,F85 11/2012-	Steering Tie Rod - Front
SSP0025	301191600250	BMW X3 F25 09/2010-2016	Steering Tie Rod - Front
SSP0025	301191600250	BMW X4 F26 04/2014-	Steering Tie Rod - Front
SSP0026	301191600260	BMW 520i F 2010-2016	Steering Tie Rod - Front
SSP0026	301191600260	BMW 528i F 2010-2016	Steering Tie Rod - Front
SSP0026	301191600260	BMW 530i F 2010-2016	Steering Tie Rod - Front
SSP0026	301191600260	BMW 535d F 2010-2016	Steering Tie Rod - Front
SSP0026	301191600260	BMW 535i F 2010-2016	Steering Tie Rod - Front
SSP0026	301191600260	BMW 550i F 2010-2016	Steering Tie Rod - Front
SSP0026	301191600260	BMW 640i F 2011-2016	Steering Tie Rod - Front
SSP0026	301191600260	BMW 640i Gran Coupe F 2011-2016	Steering Tie Rod - Front
SSP0026	301191600260	BMW 650i F 2011-2016	Steering Tie Rod - Front
SSP0026	301191600260	BMW 650i Gran Coupe F 2011-2016	Steering Tie Rod - Front
SSP0026	301191600260	BMW 740i F01, F02, F03,F04 06/2008-2016	Steering Tie Rod - Front
SSP0026	301191600260	BMW 740Li F01, F02, F03,F04 06/2008-2016	Steering Tie Rod - Front
SSP0026	301191600260	BMW 750i F01, F02, F03,F04 06/2008-2016	Steering Tie Rod - Front
SSP0026	301191600260	BMW 750Li F01, F02, F03,F04 06/2008-2016	Steering Tie Rod - Front
SSP0026	301191600260	BMW 760Li F01, F02, F03,F04 06/2008-2016	Steering Tie Rod - Front
SSP0027	301191600270	CHEVROLET EPICA V250 01/2005-03/2011	Steering Tie Rod - Front
SSP0028	301191600280	CHEVROLET CRUZE 05/2009-2016	Steering Tie Rod - Front
SSP0028	301191600280	CHEVROLET VOLT 1st Gen 2010-2015	Steering Tie Rod - Front
SSP0029	301191600290	CHEVROLET AVEO T250 05/2005-02/2011	Steering Tie Rod - Front
SSP0029	301191600290	DAEWOO KALOS (KLAS) 09/2002-03/2011	Steering Tie Rod - Front
SSP0029	301191600290	PONTIAC G3 2007-2009	Steering Tie Rod - Front
SSP0030	301191600300	CHEVROLET CAPTIVA SPORT 2012-2015	Steering Tie Rod - Front
SSP0030	301191600300	CHEVROLET EQUINOX 2005-2009	Steering Tie Rod - Front
SSP0030	301191600300	GMC TERRAIN 2010-	Steering Tie Rod - Front
SSP0030	301191600300	PONTIAC TORRENT 2006-2009	Steering Tie Rod - Front
SSP0030	301191600300	SUZUKI XL-7 2007-2009	Steering Tie Rod - Front
SSP0031	301191600310	CHEVROLET EQUINOX 2nd Gen 2010-2016	Steering Tie Rod - Front Inner
SSP0032	301191600320	CHEVROLET EQUINOX 2nd Gen 2010-2016	Steering Tie Rod - Front
SSP0032	301191600320	GMC TERRAIN 2010-	Steering Tie Rod - Front
SSP0033	301191600330	BUICK ENCORE 2012-2016	Steering Tie Rod - Front
SSP0033	301191600330	CHEVROLET AVEO T300 03/2011-2016	Steering Tie Rod - Front
SSP0033	301191600330	OPEL MOKKA 06/2012-	Steering Tie Rod - Front



			DESCRIPTION
SHORT	LONG		
SSP0034	301191600340	CHEVROLET LACETTI J200 (OPTRA) 03/2003-04/2012	Steering Tie Rod - Front
SSP0034	301191600340	CHEVROLET OPTRA J200 03/2003-04/2012	Steering Tie Rod - Front
SSP0035	301191600350	BUICK LACROSSE 2nd Gen 2010-2016	Steering Tie Rod - Front
SSP0035	301191600350	CHEVROLET MALIBU 8th Gen 2013-2016	Steering Tie Rod - Front
SSP0035	301191600350	OPEL INSIGNIA 1st Gen 07/2008-2017	Steering Tie Rod - Front
SSP0036	301191600360	CHEVROLET MALIBU 8th Gen 2013-2016	Steering Tie Rod - Front
SSP0036	301191600360	OPEL INSIGNIA 1st Gen 07/2008-2017	Steering Tie Rod - Front
SSP0037	301191600370	CHEVROLET MALIBU 8th Gen 2013-2016	Steering Tie Rod - Front
SSP0038	301191600380	CHEVROLET REZZO U100 (VIVANT) 2004-2009	Steering Tie Rod - Front
SSP0038	301191600380	CHEVROLET TACUMA 2000-2008	Steering Tie Rod - Front
SSP0038	301191600380	DAEWOO REZZO (KLAU) 09/2000-02/2011	Steering Tie Rod - Front
SSP0039	301191600390	CHEVROLET CORVETTE C5 01/1997-09/2004	Steering Tie Rod - Rear
SSP0040	301191600400	CHEVROLET CORVETTE C7 2014-	Steering Tie Rod - Front
SSP0041	301191600410	CHEVROLET CAPTIVA 06/2006-05/2010	Steering Tie Rod - Front
SSP0042	301191600420	CHEVROLET CAMARO 5th Gen 2010-2015	Steering Tie Rod - Front
SSP0043	301191600430	CHEVROLET Tornado 2003-2016	Steering Tie Rod - Front
SSP0043	301191600430	OPEL CORSA (Utility) 2003-2010	Steering Tie Rod - Front
SSP0044	301191600440	CHEVROLET N300 (Argentina) 06/2006-	Steering Tie Rod - Front
SSP0045	301191600450	CHEVROLET SPARK M300 03/2010-2016	Steering Tie Rod - Front
SSP0046	301191600460	CHEVROLET TAHOE 3rd Gen, GMT900 2007-2014	Steering Tie Rod - Front
SSP0046	301191600460	GMC YUKON GMT900 2007-2014	Steering Tie Rod - Front
SSP0047	301191600470	BUICK ENCLAVE 1st Gen 2008-2015	Steering Tie Rod - Front
SSP0047	301191600470	CHEVROLET TRAVERSE 1st Gen 2009-2015	Steering Tie Rod - Front
SSP0047	301191600470	GMC ACADIA 2007-2017	Steering Tie Rod - Front
SSP0048	301191600480	CHEVROLET TRACKER 2nd Gen 1998-2005	Steering Tie Rod - Front
SSP0049	301191600490	CITROEN XANTIA BREAK 1993-2003	Steering Tie Rod - Front
SSP0049	301191600490	PEUGEOT 205 1983-1998	Steering Tie Rod - Front
SSP0050	301191600500	CITROEN BERLINGO MF 07/1996-	Steering Tie Rod - Front
SSP0050	301191600500	CITROEN XSARA 1997-2005	Steering Tie Rod - Front
SSP0050	301191600500	CITROEN ZX 1991-1997	Steering Tie Rod - Front
SSP0050	301191600500	PEUGEOT PARTNER I 05/1996-	Steering Tie Rod - Front
SSP0051	301191600510	CITROEN AX 1986-1991	Steering Tie Rod - Front
SSP0051	301191600510	PEUGEOT 106 08/1991-03/2004	Steering Tie Rod - Front
SSP0052	301191600520	CITROEN C4 GRAND PICASSO UA 02/2007-01/2013	Steering Tie Rod - Front
SSP0053	301191600530	CITROEN C4 GRAND PICASSO II 2014-	Steering Tie Rod - Front
SSP0053	301191600530	CITROEN C4 PICASSO II 2013-	Steering Tie Rod - Front
SSP0053	301191600530	PEUGEOT 3008 II 2016-	Steering Tie Rod - Front
SSP0054	301191600540	CITROEN C-ELYSEE 11/2012-	Steering Tie Rod - Front





 SHORT LONG			DESCRIPTION
SSP0054	301191600540	PEUGEOT 301 11/2012-	Steering Tie Rod - Front
SSP0055	301191600550	CITROEN XSARA PICASSO 12/1999-2012	Steering Tie Rod - Front
SSP0056	301191600560	CITROEN XM BREAK 1994-2000	Steering Tie Rod - Front
SSP0056	301191600560	PEUGEOT 605 1989-1999	Steering Tie Rod - Front
SSP0057	301191600570	CITROEN C2 JM 09/2003-09/2009	Steering Tie Rod - Front
SSP0057	301191600570	CITROEN C3 FC 03/2003-10/2009	Steering Tie Rod - Front
SSP0058	301191600580	CITROEN C3 II 11/2009-2016	Steering Tie Rod - Front
SSP0058	301191600580	CITROEN DS3 II 2009-2016	Steering Tie Rod - Front
SSP0059	301191600590	CITROEN C5 DC 03/2001-08/2004	Steering Tie Rod - Front
SSP0060	301191600600	CITROEN C5 RD 02/2008-	Steering Tie Rod - Front
SSP0061	301191600610	CHRYSLER TOWN & COUNTRY V 2008-2016	Steering Tie Rod - Front
SSP0061	301191600610	DODGE CHARGER 6th Gen 2005-2010	Steering Tie Rod - Front
SSP0061	301191600610	DODGE GRAND CARAVAN V 2008-2016	Steering Tie Rod - Front
SSP0062	301191600620	CHRYSLER TOWN & COUNTRY V 2008-2016	Steering Tie Rod - Front
SSP0062	301191600620	DODGE GRAND CARAVAN V 2008-2016	Steering Tie Rod - Front
SSP0063	301191600630	CHRYSLER 200 1st Gen 2011-2014	Steering Tie Rod - Front
SSP0064	301191600640	CHRYSLER 300 2nd Gen 2011-2017	Steering Tie Rod - Front
SSP0064	301191600640	DODGE CHARGER LX 2011-	Steering Tie Rod - Front
SSP0065	301191600650	DACIA LOGAN (LS) 09/2004-11/2012	Steering Tie Rod - Front
SSP0065	301191600650	DACIA LOGAN MCV (KS) 02/2007-01/2013	Steering Tie Rod - Front
SSP0065	301191600650	DACIA SANDERO I 06/2008-12/2012	Steering Tie Rod - Front
SSP0066	301191600660	DACIA DUSTER 04/2010-	Steering Tie Rod - Front
SSP0067	301191600670	DODGE DURANGO 3rd Gen 2011-2017	Steering Tie Rod - Front
SSP0067	301191600670	JEEP GRAND CHEROKEE WK2 2011-	Steering Tie Rod - Front
SSP0068	301191600680	CHRYSLER 300 2nd Gen 2011-2017	Steering Tie Rod - Front
SSP0068	301191600680	DODGE CHALLENGER 4th Gen 2008-	Steering Tie Rod - Front
SSP0068	301191600680	DODGE CHARGER 7th Gen 2011-	Steering Tie Rod - Front
SSP0069	301191600690	CHRYSLER 200 2nd Gen 2015-	Steering Tie Rod - Front
SSP0069	301191600690	DODGE DART (PF) 2013-	Steering Tie Rod - Front
SSP0070	301191600700	FIAT EGEA 356, TIPO 10/2015-	Steering Tie Rod - Front
SSP0070	301191600700	FIAT TIPO 356 10/2015-	Steering Tie Rod - Front
SSP0071	301191600710	FIAT 127 PANAROMA 1971-1986	Steering Tie Rod - Front
SSP0071	301191600710	FIAT 128 PANORAMA 1983-1989	Steering Tie Rod - Front
SSP0071	301191600710	FIAT UNO CS 1983-1996	Steering Tie Rod - Front
SSP0071	301191600710	LANCIA Y 10 1985-1996	Steering Tie Rod - Front
SSP0071	301191600710	SEAT MARBELLA 1992-1998	Steering Tie Rod - Front
SSP0071	301191600710	SEAT RONDA 1982-1988	Steering Tie Rod - Front
SSP0071	301191600710	YUGO 101 ZASTAVA SPORT 1969-1986	Steering Tie Rod - Front
SSP0072	301191600720	FORD COURIER 08/1996-12/2001	Steering Tie Rod - Front
SSP0072	301191600720	FORD FIESTA IV Box JV 1996-1998	Steering Tie Rod - Front
SSP0072	301191600720	FORD IKON 1999-2007	Steering Tie Rod - Front



 SHORT LONG			DESCRIPTION
SSP0072	301191600720	FORD PUMA 03/1997-06/2002	Steering Tie Rod - Front
SSP0072	301191600720	MAZDA 121 III 03/1996-04/2003	Steering Tie Rod - Front
SSP0073	301191600730	FORD EDGE U387 2006-2014	Steering Tie Rod - Front
SSP0074	301191600740	FORD C-MAX II USA 2013-2015	Steering Tie Rod - Front
SSP0074	301191600740	FORD ESCAPE 3rd Gen 2013-	Steering Tie Rod - Front
SSP0074	301191600740	FORD FOCUS III USA made 2012-	Steering Tie Rod - Front
SSP0075	301191600750	FORD FIESTA VI 10/2008-2016	Steering Tie Rod - Front
SSP0076	301191600760	FORD FIESTA V 01/2002-09/2008	Steering Tie Rod - Front
SSP0076	301191600760	FORD FUSION 2003-2009	Steering Tie Rod - Front
SSP0076	301191600760	MAZDA 2 DY 04/2003-06/2007	Steering Tie Rod - Front
SSP0077	301191600770	FORD FIESTA III 1994-1996	Steering Tie Rod - Front Inner
SSP0077	301191600770	FORD KA RB 1996-2008	Steering Tie Rod - Front Inner
SSP0078	301191600780	FORD KA RB 1996-2008	Steering Tie Rod - Front
SSP0079	301191600790	FORD EXPLORER U502 2010-2015	Steering Tie Rod - Front
SSP0079	301191600790	FORD POLICE INTERCEPTOR UTILITY 2013-2016	Steering Tie Rod - Front
SSP0079	301191600790	LINCOLN MKT 2013-2015	Steering Tie Rod - Front
SSP0080	301191600800	FORD MONDEO V 09/2014-	Steering Tie Rod - Front
SSP0080	301191600800	VOLVO S60 II 04/2010-	Steering Tie Rod - Front
SSP0081	301191600810	FORD FOCUS II USA made 2005-2010	Steering Tie Rod - Front
SSP0082	301191600820	FORD FOCUS II USA made 2005-2010	Steering Tie Rod - Front
SSP0083	301191600830	FORD FOCUS I 10/1998-11/2004	Steering Tie Rod - Front
SSP0083	301191600830	FORD TRANSIT CONNECT 04/2002-09/2013	Steering Tie Rod - Front
SSP0083	301191600830	FORD TRANSIT CONNECT USA made 2010-2013	Steering Tie Rod - Front
SSP0084	301191600840	FORD C-MAX I 02/2007-11/2010	Steering Tie Rod - Front Inner
SSP0084	301191600840	FORD C-MAX II 12/2010-	Steering Tie Rod - Front Inner
SSP0084	301191600840	FORD FOCUS II 11/2004-03/2011	Steering Tie Rod - Front Inner
SSP0084	301191600840	FORD FOCUS III 04/2011-	Steering Tie Rod - Front Inner
SSP0084	301191600840	FORD KUGA I 02/2008-02/2013	Steering Tie Rod - Front Inner
SSP0084	301191600840	VOLVO C30 10/2006-12/2012	Steering Tie Rod - Front Inner
SSP0084	301191600840	VOLVO S40 II (MS) 01/2004-11/2012	Steering Tie Rod - Front Inner
SSP0084	301191600840	VOLVO V40 II 03/2012-	Steering Tie Rod - Front Inner
SSP0084	301191600840	VOLVO V50 04/2004-11/2012	Steering Tie Rod - Front Inner
SSP0085	301191600850	FORD FOCUS III 04/2011-	Steering Tie Rod - Front
SSP0086	301191600860	FORD FOCUS II 11/2004-03/2011	Steering Tie Rod - Front Inner
SSP0087	301191600870	FORD EXPEDITION 2nd Gen 2003-2006	Steering Tie Rod - Front
SSP0087	301191600870	LINCOLN NAVIGATOR UN173, U228 05/1997-12/2006	Steering Tie Rod - Front
SSP0088	301191600880	FORD EXPEDITION 3rd Gen U324 2007-2015	Steering Tie Rod - Front
SSP0089	301191600890	FORD F-150 12th Gen 2009-2015	Steering Tie Rod - Front
SSP0089	301191600890	FORD MUSTANG 6th Gen 2013-2016	Steering Tie Rod - Front





 SHORT LONG			DESCRIPTION
SSP0090	301191600900	FORD MUSTANG 5th Gen 2005-2010	Steering Tie Rod - Front
SSP0091	301191600910	FORD MUSTANG 5th Gen 2010-2015	Steering Tie Rod - Front
SSP0092	301191600920	FORD KUGA II 03/2013-	Steering Tie Rod - Front
SSP0092	301191600920	FORD TRANSIT CONNECT II 2013-	Steering Tie Rod - Front
SSP0093	301191600930	FORD FUSION 2nd Gen 2013-	Steering Tie Rod - Front
SSP0094	301191600940	FORD TRANSIT V184 2000-06/2006	Steering Tie Rod - Left
SSP0094	301191600940	FORD TRANSIT V347-348 07/2006-04/2014	Steering Tie Rod - Left
SSP0095	301191600950	FORD TRANSIT V184 2000-06/2006	Steering Tie Rod - Right
SSP0095	301191600950	FORD TRANSIT V347-348 07/2006-04/2014	Steering Tie Rod - Right
SSP0096	301191600960	FORD TRANSIT CUSTOM 12/2012-	Steering Tie Rod - Front
SSP0096	301191600960	FORD TRANSIT V363 04/2014-	Steering Tie Rod - Front
SSP0097	301191600970	FORD MONDEO II 06/1996-10/2000	Steering Tie Rod - Front
SSP0097	301191600970	FORD MONDEO III 11/2000-03/2007	Steering Tie Rod - Front
SSP0098	301191600980	FORD GALAXY 05/2006-	Steering Tie Rod - Front
SSP0098	301191600980	FORD MONDEO IV 04/2007-08/2014	Steering Tie Rod - Front
SSP0098	301191600980	FORD S-MAX WA6 05/2006-	Steering Tie Rod - Front
SSP0098	301191600980	VOLVO S60 II 04/2010-	Steering Tie Rod - Front
SSP0098	301191600980	VOLVO S80 II (AS) 03/2006-2016	Steering Tie Rod - Front
SSP0098	301191600980	VOLVO V70 III 08/2007-2016	Steering Tie Rod - Front
SSP0099	301191600990	HYUNDAI ix35 01/2010-2015	Steering Tie Rod - Front
SSP0099	301191600990	KIA SPORTAGE SL 07/2010-08/2015	Steering Tie Rod - Front
SSP0100	301191601000	HYUNDAI ix55 09/2008-	Steering Tie Rod - Front
SSP0100	301191601000	HYUNDAI VERACRUZ 2008-2015	Steering Tie Rod - Front
SSP0101	301191601010	HYUNDAI ACCENT IV, RB 2011-	Steering Tie Rod - Front
SSP0101	301191601010	KIA RIO UB 09/2011-	Steering Tie Rod - Front
SSP0102	301191601020	HYUNDAI H 1 I 02/2008-	Steering Tie Rod - Front Right
SSP0102	301191601020	HYUNDAI I800 800 10/2007-	Steering Tie Rod - Front Right
SSP0103	301191601030	HYUNDAI TUCSON JM 08/2004-03/2010	Steering Tie Rod - Front
SSP0103	301191601030	KIA SPORTAGE JE 09/2004-06/2010	Steering Tie Rod - Front
SSP0104	301191601040	HYUNDAI I20 (PB,PBT) 09/2008-08/2014	Steering Tie Rod - Front
SSP0105	301191601050	HYUNDAI ix20 (JC) 11/2010-	Steering Tie Rod - Front
SSP0105	301191601050	KIA SOUL AM 02/2009-2014	Steering Tie Rod - Front
SSP0105	301191601050	KIA VENGA AM 02/2010-	Steering Tie Rod - Front
SSP0106	301191601060	HYUNDAI ELANTRA Touring, Wagon 10/2007-11/2011	Steering Tie Rod - Front
SSP0106	301191601060	HYUNDAI I30 FD 10/2007-11/2011	Steering Tie Rod - Front
SSP0106	301191601060	KIA CEED I 12/2006-04/2012	Steering Tie Rod - Front
SSP0106	301191601060	KIA Forte 1st Gen 2010-2013	Steering Tie Rod - Front
SSP0106	301191601060	KIA Forte Koup 1st Gen 2010-2013	Steering Tie Rod - Front
SSP0106	301191601060	KIA Forte5 1st Gen 2010-2013	Steering Tie Rod - Front
SSP0107	301191601070	HYUNDAI Elantra GT 12/2011-	Steering Tie Rod - Front



 SHORT LONG			DESCRIPTION
SSP0107	301191601070	HYUNDAI I30 GD 12/2011-	Steering Tie Rod - Front
SSP0107	301191601070	HYUNDAI I30 PD 2017-	Steering Tie Rod - Front
SSP0107	301191601070	KIA CEED II 05/2012-	Steering Tie Rod - Front
SSP0108	301191601080	HYUNDAI I10 (PA) 02/2008-11/2013	Steering Tie Rod - Front
SSP0109	301191601090	HYUNDAI i40 (VF) 2011-	Steering Tie Rod - Front
SSP0110	301191601100	HYUNDAI I20 II 11/2014-	Steering Tie Rod - Front
SSP0111	301191601110	HYUNDAI COUPE 05/2002-08/2009	Steering Tie Rod - Front
SSP0111	301191601110	HYUNDAI ELANTRA 3th Gen, XD 06/2000-07/2006	Steering Tie Rod - Front
SSP0111	301191601110	HYUNDAI MATRIX 06/2001-08/2010	Steering Tie Rod - Front
SSP0111	301191601110	HYUNDAI Santa Fe I SM 02/2001-02/2006	Steering Tie Rod - Front
SSP0111	301191601110	HYUNDAI SONATA II 05/1993-06/1998	Steering Tie Rod - Front
SSP0112	301191601120	HYUNDAI Santa Fe II CM 03/2006-08/2012	Steering Tie Rod - Front
SSP0113	301191601130	HYUNDAI Santa Fe III DM 09/2012-	Steering Tie Rod - Front
SSP0114	301191601140	JEEP COMMANDER III WH/WK 2005-2010	Steering Tie Rod - Front
SSP0114	301191601140	JEEP GRAND CHEROKEE III WH/WK 06/2005-12/2010	Steering Tie Rod - Front
SSP0115	301191601150	KIA SORENTO JC, BL 08/2002-10/2009	Steering Tie Rod - Right
SSP0116	301191601160	KIA SORENTO JC, BL 08/2002-10/2009	Steering Tie Rod - Left
SSP0117	301191601170	KIA SORENTO XM 2009-2014	Steering Tie Rod - Left
SSP0118	301191601180	KIA SORENTO XM 2009-2014	Steering Tie Rod - Right
SSP0119	301191601190	KIA SORENTO UM, III 2015-2017	Steering Tie Rod - Front
SSP0120	301191601200	KIA RIO DC 09/2000-02/2005	Steering Tie Rod - Front
SSP0121	301191601210	KIA RIO JB 03/2005-08/2011	Steering Tie Rod - Right
SSP0121	301191601210	KIA RIO5 JB 03/2005-08/2011	Steering Tie Rod - Right
SSP0122	301191601220	KIA RIO JB 03/2005-08/2011	Steering Tie Rod - Left
SSP0122	301191601220	KIA RIO5 JB 03/2005-08/2011	Steering Tie Rod - Left
SSP0123	301191601230	KIA PICANTO BA 05/2004-04/2011	Steering Tie Rod - Front
SSP0124	301191601240	KIA PICANTO TA 05/2011-	Steering Tie Rod - Front
SSP0125	301191601250	MERCEDES E280 (W210) 1995-2003	Steering Tie Rod - Front
SSP0125	301191601250	MERCEDES E300 (W210) 1995-2003	Steering Tie Rod - Front
SSP0125	301191601250	MERCEDES E320 (W210) 1995-2003	Steering Tie Rod - Front
SSP0125	301191601250	MERCEDES E420 (W210) 1995-2003	Steering Tie Rod - Front
SSP0125	301191601250	MERCEDES E430 (W210) 1995-2003	Steering Tie Rod - Front
SSP0125	301191601250	MERCEDES E500 (W210) 1995-2003	Steering Tie Rod - Front
SSP0125	301191601250	MERCEDES E55 AMG (W210) 1995-2003	Steering Tie Rod - Front
SSP0126	301191601260	MERCEDES SLK200 (R171) 03/2004-02/2011	Steering Tie Rod - Front
SSP0126	301191601260	MERCEDES SLK280 (R171) 03/2004-02/2011	Steering Tie Rod - Front
SSP0126	301191601260	MERCEDES SLK300 (R171) 03/2004-02/2011	Steering Tie Rod - Front
SSP0126	301191601260	MERCEDES SLK350 (R171) 03/2004-02/2011	Steering Tie Rod - Front
SSP0126	301191601260	MERCEDES SLK55 AMG (R171) 03/2004-02/2011	Steering Tie Rod - Front





 SHORT LONG			DESCRIPTION
SSP0127	301191601270	MERCEDES E200 (W212) 01/2009-2016	Steering Tie Rod - Front Inner
SSP0127	301191601270	MERCEDES E250 (W212) 01/2009-2016	Steering Tie Rod - Front Inner
SSP0127	301191601270	MERCEDES E280 (W212) 01/2009-2016	Steering Tie Rod - Front Inner
SSP0127	301191601270	MERCEDES E300 (W212) 01/2009-2016	Steering Tie Rod - Front Inner
SSP0127	301191601270	MERCEDES E320 (W212) 01/2009-2016	Steering Tie Rod - Front Inner
SSP0127	301191601270	MERCEDES E400 (W212) 01/2009-2016	Steering Tie Rod - Front Inner
SSP0127	301191601270	MERCEDES E500 (W212) 01/2009-2016	Steering Tie Rod - Front Inner
SSP0127	301191601270	MERCEDES E550 (W212) 01/2009-2016	Steering Tie Rod - Front Inner
SSP0127	301191601270	MERCEDES E63 AMG (W212) 01/2009-2016	Steering Tie Rod - Front Inner
SSP0128	301191601280	MERCEDES C180 (W204) 10/2007-11/2013	Steering Tie Rod - Front
SSP0128	301191601280	MERCEDES C200 (W204) 10/2007-11/2013	Steering Tie Rod - Front
SSP0128	301191601280	MERCEDES C230 (W204) 10/2007-11/2013	Steering Tie Rod - Front
SSP0128	301191601280	MERCEDES C250 (W204) 10/2007-11/2013	Steering Tie Rod - Front
SSP0128	301191601280	MERCEDES C280 (W204) 10/2007-11/2013	Steering Tie Rod - Front
SSP0128	301191601280	MERCEDES C300 (W204) 10/2007-11/2013	Steering Tie Rod - Front
SSP0128	301191601280	MERCEDES C350 (W204) 10/2007-11/2013	Steering Tie Rod - Front
SSP0128	301191601280	MERCEDES E200 (W212) 01/2009-2016	Steering Tie Rod - Front
SSP0128	301191601280	MERCEDES E250 (W212) 01/2009-2016	Steering Tie Rod - Front
SSP0128	301191601280	MERCEDES E280 (W212) 01/2009-2016	Steering Tie Rod - Front
SSP0128	301191601280	MERCEDES E300 (W212) 01/2009-2016	Steering Tie Rod - Front
SSP0128	301191601280	MERCEDES E320 (W212) 01/2009-2016	Steering Tie Rod - Front
SSP0128	301191601280	MERCEDES E400 (W212) 01/2009-2016	Steering Tie Rod - Front
SSP0128	301191601280	MERCEDES E500 (W212) 01/2009-2016	Steering Tie Rod - Front
SSP0128	301191601280	MERCEDES E550 (W212) 01/2009-2016	Steering Tie Rod - Front
SSP0129	301191601290	MERCEDES E250 (W212) 01/2009-2016	Steering Tie Rod - Front
SSP0129	301191601290	MERCEDES E320 (W212) 01/2009-2016	Steering Tie Rod - Front
SSP0129	301191601290	MERCEDES E400 (W212) 01/2009-2016	Steering Tie Rod - Front
SSP0129	301191601290	MERCEDES E550 (W212) 01/2009-2016	Steering Tie Rod - Front
SSP0129	301191601290	MERCEDES E63 AMG (W212) 01/2009-2016	Steering Tie Rod - Front
SSP0129	301191601290	MERCEDES E63 AMG S (W212) 01/2009-2016	Steering Tie Rod - Front
SSP0129	301191601290	MERCEDES GLK250 (X204) 06/2008-2016	Steering Tie Rod - Front
SSP0129	301191601290	MERCEDES GLK280 (X204) 06/2008-2016	Steering Tie Rod - Front
SSP0129	301191601290	MERCEDES GLK300 (X204) 06/2008-2016	Steering Tie Rod - Front
SSP0129	301191601290	MERCEDES GLK350 (X204) 06/2008-2016	Steering Tie Rod - Front
SSP0129	301191601290	MERCEDES S400 (W222,V222,X222) 2014-	Steering Tie Rod - Front
SSP0129	301191601290	MERCEDES S500 (W222,V222,X222) 2014-	Steering Tie Rod - Front
SSP0129	301191601290	MERCEDES S550 (W222,V222,X222) 2014-	Steering Tie Rod - Front
SSP0129	301191601290	MERCEDES S63 AMG (W222,V222,X222) 2014-	Steering Tie Rod - Front
SSP0129	301191601290	MERCEDES S63L AMG (W222,V222,X222) 2014-	Steering Tie Rod - Front



			DESCRIPTION
SHORT	LONG		
SSP0130	301191601300	MERCEDES A160 (W168) 1997-2004	Steering Tie Rod - Front
SSP0130	301191601300	MERCEDES A190 (W168) 1997-2004	Steering Tie Rod - Front
SSP0131	301191601310	MERCEDES A160 (W169) 09/2004-06/2012	Steering Tie Rod - Front
SSP0131	301191601310	MERCEDES A190 (W169) 09/2004-06/2012	Steering Tie Rod - Front
SSP0131	301191601310	MERCEDES B180 (W245) 03/2005-11/2011	Steering Tie Rod - Front
SSP0131	301191601310	MERCEDES B200 (W245) 03/2005-11/2011	Steering Tie Rod - Front
SSP0132	301191601320	MERCEDES A180 (W176) 06/2012-	Steering Tie Rod - Front
SSP0132	301191601320	MERCEDES A200 (W176) 06/2012-	Steering Tie Rod - Front
SSP0132	301191601320	MERCEDES A250 (W176) 06/2012-	Steering Tie Rod - Front
SSP0132	301191601320	MERCEDES B180 (W246) 11/2011-2016	Steering Tie Rod - Front
SSP0132	301191601320	MERCEDES B250 (W246) 11/2011-2016	Steering Tie Rod - Front
SSP0132	301191601320	MERCEDES CLA180 (W176) 06/2012-	Steering Tie Rod - Front
SSP0132	301191601320	MERCEDES CLA200 (W176) 06/2012-	Steering Tie Rod - Front
SSP0132	301191601320	MERCEDES CLA250 (W176) 06/2012-	Steering Tie Rod - Front
SSP0132	301191601320	MERCEDES GLA180 (X156) 12/2013-	Steering Tie Rod - Front
SSP0132	301191601320	MERCEDES GLA200 (X156) 12/2013-	Steering Tie Rod - Front
SSP0132	301191601320	MERCEDES GLA250 (X156) 12/2013-	Steering Tie Rod - Front
SSP0132	301191601320	MERCEDES GLA45 AMG (X156) 12/2013-	Steering Tie Rod - Front
SSP0133	301191601330	MERCEDES VITO (W638) 03/1997-07/2003	Steering Tie Rod - Front
SSP0134	301191601340	MERCEDES VITO (W447) 2014-	Steering Tie Rod - Front
SSP0135	301191601350	MERCEDES GL350 (X166) 07/2011-	Steering Tie Rod - Front
SSP0135	301191601350	MERCEDES GL450 (X166) 07/2011-	Steering Tie Rod - Front
SSP0135	301191601350	MERCEDES GL500 (X166) 07/2011-	Steering Tie Rod - Front
SSP0135	301191601350	MERCEDES GL550 (X166) 07/2011-	Steering Tie Rod - Front
SSP0135	301191601350	MERCEDES GL63 AMG (X166) 07/2011-	Steering Tie Rod - Front
SSP0135	301191601350	MERCEDES ML250 (W166) 07/2011-	Steering Tie Rod - Front
SSP0135	301191601350	MERCEDES ML350 (W166) 07/2011-	Steering Tie Rod - Front
SSP0135	301191601350	MERCEDES ML400 (W166) 07/2011-	Steering Tie Rod - Front
SSP0135	301191601350	MERCEDES ML500 (W166) 07/2011-	Steering Tie Rod - Front
SSP0135	301191601350	MERCEDES ML550 (W166) 07/2011-	Steering Tie Rod - Front
SSP0135	301191601350	MERCEDES ML63 AMG (W166) 07/2011-	Steering Tie Rod - Front
SSP0136	301191601360	MERCEDES Vaneo (W414) 02/2002-07/2005	Steering Tie Rod - Front
SSP0137	301191601370	MERCEDES VIANO (W639) 03/2003-07/2014	Steering Tie Rod - Front
SSP0137	301191601370	MERCEDES VITO (W639) 03/2003-07/2014	Steering Tie Rod - Front
SSP0138	301191601380	DODGE SPRINTER 2500 W901,W902,W903 01/1995-05/2006	Steering Tie Rod - Front
SSP0138	301191601380	DODGE SPRINTER 3500 W901,W902,W903 01/1995-05/2006	Steering Tie Rod - Front
SSP0138	301191601380	MERCEDES SPRINTER (W901,W902,W903) 01/1995-05/2006	Steering Tie Rod - Front
SSP0138	301191601380	VOLKSWAGEN LT 28-35-46, Typ 2D 04/1996- 07/2006	Steering Tie Rod - Front





 SHORT LONG			DESCRIPTION
SSP0139	301191601390	DODGE SPRINTER 2500 W906 06/2006-	Steering Tie Rod - Front
SSP0139	301191601390	DODGE SPRINTER 3500 W906 06/2006-	Steering Tie Rod - Front
SSP0139	301191601390	MERCEDES SPRINTER (W906) 06/2006-	Steering Tie Rod - Front
SSP0139	301191601390	MERCEDES SPRINTER 2500 (W906) 06/2006-	Steering Tie Rod - Front
SSP0139	301191601390	MERCEDES SPRINTER 3500 (W906) 06/2006-	Steering Tie Rod - Front
SSP0139	301191601390	VOLKSWAGEN CRAFTER 04/2006-	Steering Tie Rod - Front
SSP0140	301191601400	MERCEDES C180 (W204) 10/2007-11/2013	Steering Tie Rod - Front Inner
SSP0140	301191601400	MERCEDES C200 (W204) 10/2007-11/2013	Steering Tie Rod - Front Inner
SSP0140	301191601400	MERCEDES C230 (W204) 10/2007-11/2013	Steering Tie Rod - Front Inner
SSP0140	301191601400	MERCEDES C250 (W204) 10/2007-11/2013	Steering Tie Rod - Front Inner
SSP0140	301191601400	MERCEDES C280 (W204) 10/2007-11/2013	Steering Tie Rod - Front Inner
SSP0140	301191601400	MERCEDES C300 (W204) 10/2007-11/2013	Steering Tie Rod - Front Inner
SSP0140	301191601400	MERCEDES C350 (W204) 10/2007-11/2013	Steering Tie Rod - Front Inner
SSP0140	301191601400	MERCEDES C63 AMG (W204) 10/2007-11/2013	Steering Tie Rod - Front Inner
SSP0141	301191601410	MERCEDES C300 (W205) AWD 12/2013-	Steering Tie Rod - Front
SSP0141	301191601410	MERCEDES C350 (W205) AWD 12/2013-	Steering Tie Rod - Front
SSP0141	301191601410	MERCEDES C400 (W205) AWD 12/2013-	Steering Tie Rod - Front
SSP0141	301191601410	MERCEDES C450 AMG (W205) AWD 12/2013-	Steering Tie Rod - Front
SSP0142	301191601420	MERCEDES C180 (W205) RWD 12/2013-	Steering Tie Rod - Front
SSP0142	301191601420	MERCEDES C200 (W205) RWD 12/2013-	Steering Tie Rod - Front
SSP0142	301191601420	MERCEDES C250 (W205) RWD 12/2013-	Steering Tie Rod - Front
SSP0142	301191601420	MERCEDES C300 (W205) RWD 12/2013-	Steering Tie Rod - Front
SSP0142	301191601420	MERCEDES C350 (W205) RWD 12/2013-	Steering Tie Rod - Front
SSP0142	301191601420	MERCEDES C63 AMG (W205) RWD 12/2013-	Steering Tie Rod - Front
SSP0142	301191601420	MERCEDES C63 AMG S (W205) RWD 12/2013-	Steering Tie Rod - Front
SSP0143	301191601430	MERCEDES ML350 (W163) 1998-06/2005	Steering Tie Rod - Front
SSP0143	301191601430	MERCEDES ML500 (W163) 1998-06/2005	Steering Tie Rod - Front
SSP0144	301191601440	MERCEDES ML350 (W164) 07/2005-05/2011	Steering Tie Rod - Front
SSP0144	301191601440	MERCEDES ML500 (W164) 07/2005-05/2011	Steering Tie Rod - Front
SSP0144	301191601440	MERCEDES ML550 (W164) 07/2005-05/2011	Steering Tie Rod - Front
SSP0144	301191601440	MERCEDES ML63 AMG (W164) 07/2005-05/2011	Steering Tie Rod - Front
SSP0145	301191601450	MERCEDES C200 (W203) 05/2000-02/2007	Steering Tie Rod - Front Inner
SSP0145	301191601450	MERCEDES C230 (W203) 05/2000-02/2007	Steering Tie Rod - Front Inner
SSP0145	301191601450	MERCEDES C240 (W203) 05/2000-02/2007	Steering Tie Rod - Front Inner
SSP0145	301191601450	MERCEDES C280 (W203) 05/2000-02/2007	Steering Tie Rod - Front Inner
SSP0145	301191601450	MERCEDES C32 AMG (W203) 05/2000-02/2007	Steering Tie Rod - Front Inner



			DESCRIPTION
SHORT	LONG		
SSP0145	301191601450	MERCEDES C320 (W203) 05/2000-02/2007	Steering Tie Rod - Front Inner
SSP0145	301191601450	MERCEDES C350 (W203) 05/2000-02/2007	Steering Tie Rod - Front Inner
SSP0145	301191601450	MERCEDES C55 AMG (W203) 05/2000-02/2007	Steering Tie Rod - Front Inner
SSP0145	301191601450	MERCEDES CL200 C215 03/1999-03/2006	Steering Tie Rod - Front Inner
SSP0145	301191601450	MERCEDES CL230 C215 03/1999-03/2006	Steering Tie Rod - Front Inner
SSP0145	301191601450	MERCEDES CL500 C215 03/1999-03/2006	Steering Tie Rod - Front Inner
SSP0145	301191601450	MERCEDES CL55 AMG C215 03/1999-03/2006	Steering Tie Rod - Front Inner
SSP0145	301191601450	MERCEDES CL600 C215 03/1999-03/2006	Steering Tie Rod - Front Inner
SSP0145	301191601450	MERCEDES CL65 AMG C215 03/1999-03/2006	Steering Tie Rod - Front Inner
SSP0145	301191601450	MERCEDES CLK280 (A209-C209) 06/2002-05/2009	Steering Tie Rod - Front Inner
SSP0145	301191601450	MERCEDES CLK320 (A209-C209) 06/2002-05/2009	Steering Tie Rod - Front Inner
SSP0145	301191601450	MERCEDES CLK350 (A209-C209) 06/2002-05/2009	Steering Tie Rod - Front Inner
SSP0145	301191601450	MERCEDES CLK430 (A209-C209) 06/2002-05/2009	Steering Tie Rod - Front Inner
SSP0145	301191601450	MERCEDES CLK500 (A209-C209) 06/2002-05/2009	Steering Tie Rod - Front Inner
SSP0145	301191601450	MERCEDES CLK55 AMG (A209-C209) 06/2002-05/2009	Steering Tie Rod - Front Inner
SSP0145	301191601450	MERCEDES CLK550 (A209-C209) 06/2002-05/2009	Steering Tie Rod - Front Inner
SSP0145	301191601450	MERCEDES CLK63 AMG (A209-C209) 06/2002-05/2009	Steering Tie Rod - Front Inner
SSP0145	301191601450	MERCEDES E280 (W211) 03/2003-07/2009	Steering Tie Rod - Front Inner
SSP0145	301191601450	MERCEDES E300 (W211) 03/2003-07/2009	Steering Tie Rod - Front Inner
SSP0145	301191601450	MERCEDES E320 (W211) 03/2003-07/2009	Steering Tie Rod - Front Inner
SSP0145	301191601450	MERCEDES E350 (W211) 03/2003-07/2009	Steering Tie Rod - Front Inner
SSP0145	301191601450	MERCEDES E500 (W211) 03/2003-07/2009	Steering Tie Rod - Front Inner
SSP0145	301191601450	MERCEDES E55 AMG (W211) 03/2003-07/2009	Steering Tie Rod - Front Inner
SSP0145	301191601450	MERCEDES E550 (W211) 03/2003-07/2009	Steering Tie Rod - Front Inner
SSP0145	301191601450	MERCEDES E63 AMG (W211) 03/2003-07/2009	Steering Tie Rod - Front Inner
SSP0145	301191601450	MERCEDES S320 (W220) 1999-2005	Steering Tie Rod - Front Inner
SSP0145	301191601450	MERCEDES S350 (W220) 1999-2005	Steering Tie Rod - Front Inner
SSP0145	301191601450	MERCEDES S420 (W220) 1999-2005	Steering Tie Rod - Front Inner
SSP0145	301191601450	MERCEDES S430 (W220) 1999-2005	Steering Tie Rod - Front Inner
SSP0145	301191601450	MERCEDES S500 (W220) 1999-2005	Steering Tie Rod - Front Inner
SSP0145	301191601450	MERCEDES S55 AMG (W220) 1999-2005	Steering Tie Rod - Front Inner
SSP0145	301191601450	MERCEDES S600 (W220) 1999-2005	Steering Tie Rod - Front Inner
SSP0145	301191601450	MERCEDES S65 AMG (W220) 1999-2005	Steering Tie Rod - Front Inner





 SHORT LONG			DESCRIPTION
SSP0145	301191601450	MERCEDES SL500 (R230) 10/2001-01/2012	Steering Tie Rod - Front Inner
SSP0145	301191601450	MERCEDES SL55 AMG (R230) 10/2001-01/2012	Steering Tie Rod - Front Inner
SSP0145	301191601450	MERCEDES SL550 (R230) 10/2001-01/2012	Steering Tie Rod - Front Inner
SSP0145	301191601450	MERCEDES SL600 (R230) 10/2001-01/2012	Steering Tie Rod - Front Inner
SSP0145	301191601450	MERCEDES SL63 AMG (R230) 10/2001-01/2012	Steering Tie Rod - Front Inner
SSP0145	301191601450	MERCEDES SL65 AMG (R230) 10/2001-01/2012	Steering Tie Rod - Front Inner
SSP0146	301191601460	MERCEDES S350 (W221) 10/2005-04/2013	Steering Tie Rod - Front
SSP0146	301191601460	MERCEDES S400 (W221) 10/2005-04/2013	Steering Tie Rod - Front
SSP0146	301191601460	MERCEDES S430 (W221) 10/2005-04/2013	Steering Tie Rod - Front
SSP0146	301191601460	MERCEDES S450 (W221) 10/2005-04/2013	Steering Tie Rod - Front
SSP0146	301191601460	MERCEDES S500 (W221) 10/2005-04/2013	Steering Tie Rod - Front
SSP0146	301191601460	MERCEDES S550 (W221) 10/2005-04/2013	Steering Tie Rod - Front
SSP0146	301191601460	MERCEDES S600 (W221) 10/2005-04/2013	Steering Tie Rod - Front
SSP0146	301191601460	MERCEDES S63 AMG (W221) 10/2005-04/2013	Steering Tie Rod - Front
SSP0146	301191601460	MERCEDES S65 AMG (W221) 10/2005-04/2013	Steering Tie Rod - Front
SSP0147	301191601470	MERCEDES GLK250 (X204) 06/2008-2016	Steering Tie Rod - Front Inner
SSP0147	301191601470	MERCEDES GLK280 (X204) 06/2008-2016	Steering Tie Rod - Front Inner
SSP0147	301191601470	MERCEDES GLK300 (X204) 06/2008-2016	Steering Tie Rod - Front Inner
SSP0147	301191601470	MERCEDES GLK350 (X204) 06/2008-2016	Steering Tie Rod - Front Inner
SSP0147	301191601470	MERCEDES S350 (W221) AWD 10/2005-04/2013	Steering Tie Rod - Front Inner
SSP0147	301191601470	MERCEDES S450 (W221) AWD 10/2005-04/2013	Steering Tie Rod - Front Inner
SSP0147	301191601470	MERCEDES S500 (W221) AWD 10/2005-04/2013	Steering Tie Rod - Front Inner
SSP0147	301191601470	MERCEDES S550 (W221) AWD 10/2005-04/2013	Steering Tie Rod - Front Inner
SSP0148	301191601480	MERCEDES E280 (W211) 03/2003-07/2009	Steering Tie Rod - Front
SSP0148	301191601480	MERCEDES E300 (W211) 03/2003-07/2009	Steering Tie Rod - Front
SSP0148	301191601480	MERCEDES E320 (W211) 03/2003-07/2009	Steering Tie Rod - Front
SSP0148	301191601480	MERCEDES E350 (W211) 03/2003-07/2009	Steering Tie Rod - Front
SSP0148	301191601480	MERCEDES E500 (W211) 03/2003-07/2009	Steering Tie Rod - Front
SSP0148	301191601480	MERCEDES E55 AMG (W211) 03/2003-07/2009	Steering Tie Rod - Front
SSP0148	301191601480	MERCEDES E550 (W211) 03/2003-07/2009	Steering Tie Rod - Front
SSP0148	301191601480	MERCEDES E63 AMG (W211) 03/2003-07/2009	Steering Tie Rod - Front
SSP0149	301191601490	MAZDA 2 DE 10/2007-2015	Steering Tie Rod - Front
SSP0150	301191601500	MAZDA 3 BK 10/2003-06/2009	Steering Tie Rod - Front
SSP0150	301191601500	MAZDA 3 BL 07/2009-11/2014	Steering Tie Rod - Front





			DESCRIPTION
SHORT	LONG		
SSP0150	301191601500	MAZDA 5 CR19, 2nd Gen 03/2005-08/2010	Steering Tie Rod - Front
SSP0151	301191601510	MAZDA 3 BM 12/2014-	Steering Tie Rod - Front
SSP0151	301191601510	MAZDA 6 GJ 2013-	Steering Tie Rod - Front
SSP0152	301191601520	MAZDA CX-7 ER 2007-	Steering Tie Rod - Front
SSP0153	301191601530	FORD FUSION 1st Gen USA made 2006-2012	Steering Tie Rod - Front
SSP0153	301191601530	LINCOLN MKZ 1st Gen 2006-2012	Steering Tie Rod - Front
SSP0153	301191601530	MAZDA 6 GG 06/2002-07/2007	Steering Tie Rod - Front
SSP0153	301191601530	MERCURY MILAN 2006-2011	Steering Tie Rod - Front
SSP0154	301191601540	MAZDA 6 GH 08/2007-12/2012	Steering Tie Rod - Front
SSP0155	301191601550	MAZDA CX-5 KE 11/2011-	Steering Tie Rod - Front
SSP0156	301191601560	MAZDA CX-9 2007-	Steering Tie Rod - Front
SSP0157	301191601570	MINI L200 (KB_T,KA_T) 11/2005-	Steering Tie Rod - Front
SSP0158	301191601580	MITSUBISHI LANCER (CS, A) 09/2003-07/2008	Steering Tie Rod - Front
SSP0159	301191601590	MITSUBISHI ASX (GA,W) 02/2010-	Steering Tie Rod - Front
SSP0159	301191601590	MITSUBISHI LANCER (CY2A-CZ4A) 06/2008-	Steering Tie Rod - Front
SSP0159	301191601590	MITSUBISHI Outlander Sport (GA,W) 02/2010-	Steering Tie Rod - Front
SSP0160	301191601600	MITSUBISHI OUTLANDER I 03/2001-10/2006	Steering Tie Rod - Front
SSP0160	301191601600	MITSUBISHI OUTLANDER II 11/2006-07/2012	Steering Tie Rod - Front
SSP0160	301191601600	MITSUBISHI OUTLANDER III 2012-	Steering Tie Rod - Front
SSP0160	301191601600	PEUGEOT 4007 02/2007-	Steering Tie Rod - Front
SSP0161	301191601610	MITSUBISHI MONTERO III 04/2000-01/2007	Steering Tie Rod - Front
SSP0161	301191601610	MITSUBISHI PAJERO III 04/2000-01/2007	Steering Tie Rod - Front
SSP0162	301191601620	MITSUBISHI MONTERO IV 02/2007-	Steering Tie Rod - Front
SSP0162	301191601620	MITSUBISHI PAJERO IV 02/2007-	Steering Tie Rod - Front
SSP0163	301191601630	MITSUBISHI PAJERO PININ 09/1999-06/2007	Steering Tie Rod - Front
SSP0164	301191601640	MITSUBISHI L200 (KB_T,KA_T) 11/2005-	Steering Tie Rod - Front
SSP0165	301191601650	MITSUBISHI CARISMA 07/1995-09/2000	Steering Tie Rod - Front
SSP0165	301191601650	VOLVO S40 I (VS) 07/1995-12/2003	Steering Tie Rod - Front
SSP0165	301191601650	VOLVO V40 I (VW) 07/1995-06/2004	Steering Tie Rod - Front
SSP0166	301191601660	MITSUBISHI CARISMA 09/2000-06/2006	Steering Tie Rod - Front
SSP0166	301191601660	MITSUBISHI SPACE STAR 1998-2004	Steering Tie Rod - Front
SSP0167	301191601670	MINI Cooper (R50, R53) 05/2001-09/2006	Steering Tie Rod - Front
SSP0167	301191601670	MINI Cooper (R52) 07/2004-11/2007	Steering Tie Rod - Front
SSP0168	301191601680	MINI Cooper (R55, R56) 09/2006-05/2010	Steering Tie Rod - Front
SSP0168	301191601680	MINI Cooper Countryman (R60) 06/2010-12/2014	Steering Tie Rod - Front
SSP0169	301191601690	MINI Cooper (F55,F56) 07/2014-	Steering Tie Rod - Front
SSP0170	301191601700	NISSAN PRIMERA (P10-W10-W11) 06/1990-06/1996	Steering Tie Rod - Front
SSP0170	301191601700	NISSAN PRIMERA (P11) 06/1996-12/2001	Steering Tie Rod - Front
SSP0171	301191601710	NISSAN ALMERA (N15) 07/1995-06/2000	Steering Tie Rod - Front





 SHORT LONG			DESCRIPTION
SSP0171	301191601710	NISSAN NX 100 (B13) 1990-1994	Steering Tie Rod - Front
SSP0171	301191601710	NISSAN PULSAR (N14) 1990-1995	Steering Tie Rod - Front
SSP0171	301191601710	NISSAN SENTRA (B13-N14) 1990-1995	Steering Tie Rod - Front
SSP0171	301191601710	NISSAN SUNNY (B13-N14) 1990-1995	Steering Tie Rod - Front
SSP0172	301191601720	NISSAN PRIMERA (P12) 01/2002-05/2008	Steering Tie Rod - Front
SSP0173	301191601730	NISSAN MICRA (K11) 08/1992-01/2003	Steering Tie Rod - Front
SSP0174	301191601740	NISSAN MICRA (K12) 02/2003-05/2010	Steering Tie Rod - Front
SSP0175	301191601750	NISSAN MARCH (K13) 06/2010-	Steering Tie Rod - Front
SSP0175	301191601750	NISSAN MICRA (K13) 06/2010-	Steering Tie Rod - Front
SSP0176	301191601760	NISSAN MURANO (Z50) 03/2003-10/2007	Steering Tie Rod - Front
SSP0177	301191601770	NISSAN MURANO (Z51) 11/2007-	Steering Tie Rod - Front
SSP0177	301191601770	NISSAN TEANA (J32) 2009-2013	Steering Tie Rod - Front
SSP0178	301191601780	INFINITI QX4 R50 1997-2004	Steering Tie Rod - Front
SSP0178	301191601780	NISSAN PATHFINDER (R50) 1997-2004	Steering Tie Rod - Front
SSP0179	301191601790	NISSAN FRONTIER (D40) 07/2005-	Steering Tie Rod - Front
SSP0179	301191601790	NISSAN NAVARA (D40) 07/2005-	Steering Tie Rod - Front
SSP0179	301191601790	NISSAN PATHFINDER (R51) 03/2005-05/2014	Steering Tie Rod - Front
SSP0180	301191601800	NISSAN ALMERA (N16) 07/2000-09/2006	Steering Tie Rod - Front
SSP0181	301191601810	NISSAN ALMERA (N16) 08/2000-07/2006	Steering Tie Rod - Front
SSP0182	301191601820	NISSAN JUKE 06/2010-	Steering Tie Rod - Front
SSP0183	301191601830	NISSAN QASHQAI (J10, JJ10) 02/2007-01/2014	Steering Tie Rod - Front
SSP0183	301191601830	NISSAN ROGUE 1st Gen 2008-2014	Steering Tie Rod - Front
SSP0183	301191601830	NISSAN X-TRAIL 2nd Gen (T31) 06/2007-09/2013	Steering Tie Rod - Front
SSP0183	301191601830	RENAULT KOLEOS 09/2008-	Steering Tie Rod - Front
SSP0184	301191601840	OPEL COMBO (C) 09/2000-07/2006	Steering Tie Rod - Front
SSP0184	301191601840	OPEL CORSA (C) 09/2000-07/2006	Steering Tie Rod - Front
SSP0185	301191601850	OPEL COMBO (B) 03/1993-08/2000	Steering Tie Rod - Front
SSP0185	301191601850	OPEL CORSA (B) 03/1993-08/2000	Steering Tie Rod - Front
SSP0185	301191601850	VAUXHALL CORSA 1997-2000	Steering Tie Rod - Front
SSP0185	301191601850	VAUXHALL TIGRA 1997-	Steering Tie Rod - Front
SSP0186	301191601860	OPEL COMBO (B) 03/1993-08/2000	Steering Tie Rod - Front
SSP0186	301191601860	OPEL CORSA (B) 03/1993-08/2000	Steering Tie Rod - Front
SSP0186	301191601860	VAUXHALL CORSA COMBO 1997-	Steering Tie Rod - Front
SSP0187	301191601870	OPEL CORSA (C) 09/2000-07/2006	Steering Tie Rod - Front
SSP0188	301191601880	OPEL COMBO (C) 09/2000-07/2006	Steering Tie Rod - Front
SSP0188	301191601880	OPEL CORSA (C) 09/2000-07/2006	Steering Tie Rod - Front
SSP0189	301191601890	OPEL MERIVA (A) 05/2003-05/2010	Steering Tie Rod - Front
SSP0190	301191601900	OPEL MERIVA (A) 05/2003-05/2010	Steering Tie Rod - Front Inner
SSP0191	301191601910	OPEL AGILA (A) 09/2000-08/2007	Steering Tie Rod - Front



 SHORT LONG			DESCRIPTION
SSP0191	301191601910	SUBARU JUSTY III 09/2003-12/2006	Steering Tie Rod - Front
SSP0191	301191601910	SUZUKI IGNIS II 09/2003-07/2008	Steering Tie Rod - Front
SSP0192	301191601920	OPEL MERIVA (B) 06/2010-	Steering Tie Rod - Front
SSP0193	301191601930	OPEL MERIVA (B) 06/2010-	Steering Tie Rod - Front
SSP0194	301191601940	CHEVROLET TRAX 2014 -	Steering Tie Rod - Front
SSP0194	301191601940	OPEL MOKKA 06/2012-	Steering Tie Rod - Front
SSP0195	301191601950	OPEL ASTRA (G) 1998-2004	Steering Tie Rod - Front
SSP0195	301191601950	OPEL ASTRA (H) 03/2004-11/2009	Steering Tie Rod - Front
SSP0195	301191601950	OPEL ZAFIRA (A) 1998-2004	Steering Tie Rod - Front
SSP0195	301191601950	SATURN ASTRA (H) 2008-2009	Steering Tie Rod - Front
SSP0195	301191601950	VAUXHALL ASTRA 1998-	Steering Tie Rod - Front
SSP0195	301191601950	VAUXHALL ASTRA COUPE 1998-	Steering Tie Rod - Front
SSP0195	301191601950	VAUXHALL ZAFIRA 1999-	Steering Tie Rod - Front
SSP0196	301191601960	OPEL ASTRA (H) 03/2004-11/2009	Steering Tie Rod - Front
SSP0196	301191601960	OPEL ZAFIRA (B) (A05) 07/2005-09/2011	Steering Tie Rod - Front
SSP0196	301191601960	SATURN ASTRA (H) 2008-2009	Steering Tie Rod - Front
SSP0197	301191601970	OPEL ZAFIRA (B) (A05) 07/2005-09/2011	Steering Tie Rod - Front
SSP0198	301191601980	OPEL VECTRA (C) 08/2002-09/2008	Steering Tie Rod - Front
SSP0198	301191601980	SAAB 9_3 2nd Gen 10/2002-01/2009	Steering Tie Rod - Front
SSP0199	301191601990	BUICK VERANO 2012-2016	Steering Tie Rod - Front
SSP0199	301191601990	OPEL ASTRA (J) 12/2009-05/2015	Steering Tie Rod - Front
SSP0200	301191602000	BUICK VERANO 2012-2016	Steering Tie Rod - Front
SSP0200	301191602000	OPEL ASTRA (J) 12/2009-05/2015	Steering Tie Rod - Front
SSP0201	301191602010	OPEL ZAFIRA (C) (P12) 10/2011-	Steering Tie Rod - Front
SSP0202	301191602020	OPEL INSIGNIA 1st Gen 07/2008-2017	Steering Tie Rod - Front Inner
SSP0203	301191602030	CHEVROLET CRUZE 2nd Gen 2016-	Steering Tie Rod - Front
SSP0203	301191602030	CHEVROLET VOLT 2nd Gen 2016-	Steering Tie Rod - Front
SSP0203	301191602030	OPEL ASTRA (K) 06/2015-	Steering Tie Rod - Front
SSP0204	301191602040	OPEL ASTRA GTC (J) 2011-	Steering Tie Rod - Front
SSP0205	301191602050	CITROEN C1 06/2005-03/2014	Steering Tie Rod - Front
SSP0205	301191602050	PEUGEOT 107 06/2005-	Steering Tie Rod - Front
SSP0205	301191602050	TOYOTA AYGO 07/2005-09/2014	Steering Tie Rod - Front
SSP0206	301191602060	CITROEN VISA C15 1982-1997	Steering Tie Rod - Front Inner
SSP0206	301191602060	CITROEN XANTIA BREAK 1993-2003	Steering Tie Rod - Front Inner
SSP0206	301191602060	PEUGEOT 205 1983-1998	Steering Tie Rod - Front Inner
SSP0207	301191602070	PEUGEOT 206 08/1998-12/2008	Steering Tie Rod - Front
SSP0207	301191602070	PEUGEOT 206+ 01/2009-12/2012	Steering Tie Rod - Front
SSP0208	301191602080	CITROEN C3 PICASSO 02/2009-	Steering Tie Rod - Front
SSP0208	301191602080	PEUGEOT 207 02/2006-11/2012	Steering Tie Rod - Front
SSP0209	301191602090	CITROEN BERLINGO M 04/2008-	Steering Tie Rod - Front
SSP0209	301191602090	PEUGEOT PARTNER II, Tepee 04/2008-	Steering Tie Rod - Front



			DESCRIPTION
SHORT	LONG		
SSP0210	301191602100	CITROEN C5 RC 04/2004-01/2008	Steering Tie Rod - Front
SSP0210	301191602100	CITROEN C6 TD 09/2005-09/2012	Steering Tie Rod - Front
SSP0210	301191602100	PEUGEOT 407 05/2004-12/2011	Steering Tie Rod - Front
SSP0211	301191602110	CITROEN C4 CACTUS 09/2014-	Steering Tie Rod - Front
SSP0211	301191602110	PEUGEOT 2008 2013-	Steering Tie Rod - Front
SSP0211	301191602110	PEUGEOT 208 03/2012-	Steering Tie Rod - Front
SSP0211	301191602110	PEUGEOT 208 GTI 03/2012-	Steering Tie Rod - Front
SSP0212	301191602120	CITROEN C4 LA 11/2004-10/2009	Steering Tie Rod - Front
SSP0212	301191602120	PEUGEOT 307 08/2000-12/2008	Steering Tie Rod - Front
SSP0213	301191602130	CITROEN C4 LA 11/2004-10/2009	Steering Tie Rod - Front
SSP0213	301191602130	PEUGEOT 307 08/2000-12/2008	Steering Tie Rod - Front
SSP0214	301191602140	CITROEN C4 B7 11/2009-	Steering Tie Rod - Front
SSP0214	301191602140	PEUGEOT 3008 09/2009-2016	Steering Tie Rod - Front
SSP0214	301191602140	PEUGEOT 308 09/2007-10/2013	Steering Tie Rod - Front
SSP0214	301191602140	PEUGEOT 5008 09/2009-	Steering Tie Rod - Front
SSP0215	301191602150	PEUGEOT 308 II 09/2013-	Steering Tie Rod - Front
SSP0216	301191602160	PEUGEOT 607 01/2000-11/2010	Steering Tie Rod - Front
SSP0217	301191602170	PEUGEOT 508 11/2010-	Steering Tie Rod - Front
SSP0218	301191602180	NISSAN QASHQAI II (J11) 02/2014-	Steering Tie Rod - Front
SSP0218	301191602180	RENAULT KADJAR 2015-	Steering Tie Rod - Front
SSP0219	301191602190	NISSAN MICRA (K12) 02/2003-05/2010	Steering Tie Rod - Front
SSP0219	301191602190	RENAULT CLIO III-HB 06/2005-09/2012	Steering Tie Rod - Front
SSP0219	301191602190	RENAULT MODUS 12/2004-07/2014	Steering Tie Rod - Front
SSP0220	301191602200	NISSAN INTERSTAR (X70) 07/2002-08/2010	Steering Tie Rod - Front
SSP0220	301191602200	OPEL MOVANO (A) 07/1998-04/2010	Steering Tie Rod - Front
SSP0220	301191602200	RENAULT MASTER I 07/1998-09/2003	Steering Tie Rod - Front
SSP0220	301191602200	RENAULT MASTER II 10/2003-01/2010	Steering Tie Rod - Front
SSP0221	301191602210	OPEL MOVANO (B) 05/2010-	Steering Tie Rod - Front
SSP0221	301191602210	RENAULT MASTER III 02/2010-	Steering Tie Rod - Front
SSP0222	301191602220	RENAULT MEGANE II 09/2003-04/2009	Steering Tie Rod - Front
SSP0222	301191602220	RENAULT SCENIC II 06/2003-01/2009	Steering Tie Rod - Front
SSP0223	301191602230	RENAULT LAGUNA II 04/2001-09/2007	Steering Tie Rod - Front
SSP0224	301191602240	RENAULT LAGUNA II 04/2001-09/2007	Steering Tie Rod - Front
SSP0225	301191602250	NISSAN PRIMASTAR (X83) 08/2002-06/2014	Steering Tie Rod - Front
SSP0225	301191602250	OPEL VIVARO I 08/2001-06/2014	Steering Tie Rod - Front
SSP0225	301191602250	OPEL VIVARO II 10/2014-	Steering Tie Rod - Front
SSP0225	301191602250	RENAULT TRAFIC II 03/2001-09/2014	Steering Tie Rod - Front
SSP0225	301191602250	RENAULT TRAFIC III 10/2014-	Steering Tie Rod - Front
SSP0226	301191602260	RENAULT ESPACE IV 11/2002-09/2014	Steering Tie Rod - Front
SSP0226	301191602260	RENAULT VEL SATIS 06/2002-07/2009	Steering Tie Rod - Front
SSP0227	301191602270	RENAULT CLIO II-SYMBOL 10/1998-2012	Steering Tie Rod - Front Inner





			DESCRIPTION
SHORT	LONG		
SSP0228	301191602280	RENAULT CLIO II-SYMBOL 10/1998-2012	Steering Tie Rod - Front
SSP0229	301191602290	RENAULT CLIO II-SYMBOL 10/1998-2012	Steering Tie Rod - Front
SSP0229	301191602290	RENAULT KANGOO I 03/1998-01/2008	Steering Tie Rod - Front
SSP0230	301191602300	RENAULT CLIO II-SYMBOL 10/1998-2012	Steering Tie Rod - Front
SSP0230	301191602300	RENAULT KANGOO I 03/1998-01/2008	Steering Tie Rod - Front
SSP0231	301191602310	RENAULT CLIO II 1998-2005	Steering Tie Rod - Front
SSP0232	301191602320	RENAULT CLIO II-SYMBOL 10/1998-2012	Steering Tie Rod - Front
SSP0233	301191602330	RENAULT KANGOO I 03/1998-01/2008	Steering Tie Rod - Front
SSP0234	301191602340	RENAULT KANGOO I 03/1998-01/2008	Steering Tie Rod - Front
SSP0235	301191602350	NISSAN KUBISTAR (X76) 08/2003-07/2007	Steering Tie Rod - Front
SSP0235	301191602350	RENAULT CLIO II-SYMBOL 10/1998-2012	Steering Tie Rod - Front
SSP0235	301191602350	RENAULT KANGOO I 03/1998-01/2008	Steering Tie Rod - Front
SSP0236	301191602360	NISSAN KUBISTAR (X76) 08/2003-07/2007	Steering Tie Rod - Front
SSP0236	301191602360	RENAULT CLIO II-SYMBOL 10/1998-2012	Steering Tie Rod - Front
SSP0236	301191602360	RENAULT KANGOO I 03/1998-01/2008	Steering Tie Rod - Front
SSP0237	301191602370	NISSAN KUBISTAR (X76) 08/2003-07/2007	Steering Tie Rod - Front Inner
SSP0237	301191602370	RENAULT CLIO II-SYMBOL 10/1998-2012	Steering Tie Rod - Front Inner
SSP0237	301191602370	RENAULT KANGOO I 03/1998-01/2008	Steering Tie Rod - Front Inner
SSP0237	301191602370	RENAULT TWINGO II (CNO) 03/2007-	Steering Tie Rod - Front Inner
SSP0238	301191602380	RENAULT CLIO II-SYMBOL 10/1998-2012	Steering Tie Rod - Front
SSP0239	301191602390	MERCEDES CITAN 415 11/2012-	Steering Tie Rod - Front
SSP0239	301191602390	RENAULT FLUENCE 02/2010-	Steering Tie Rod - Front
SSP0239	301191602390	RENAULT KANGOO II 02/2008-	Steering Tie Rod - Front
SSP0239	301191602390	RENAULT MEGANE III 05/2009-10/2015	Steering Tie Rod - Front
SSP0239	301191602390	RENAULT SCENIC III 02/2009-	Steering Tie Rod - Front
SSP0240	301191602400	RENAULT CAPTUR 03/2013-	Steering Tie Rod - Front
SSP0240	301191602400	RENAULT CLIO IV-HB 10/2012-	Steering Tie Rod - Front
SSP0241	301191602410	DACIA DOKKER 11/2012-	Steering Tie Rod - Front
SSP0241	301191602410	DACIA LODGY 03/2012-	Steering Tie Rod - Front
SSP0241	301191602410	DACIA LOGAN II 12/2012-	Steering Tie Rod - Front
SSP0241	301191602410	DACIA SANDERO II 01/2013-	Steering Tie Rod - Front
SSP0241	301191602410	RENAULT CLIO III-SYMBOL 2013-	Steering Tie Rod - Front
SSP0242	301191602420	RENAULT TWINGO (C06) 03/1993-02/2007	Steering Tie Rod - Front
SSP0242	301191602420	RENAULT TWINGO II (CNO) 03/2007-	Steering Tie Rod - Front
SSP0243	301191602430	RENAULT TWINGO (C06) 03/1993-02/2007	Steering Tie Rod - Front
SSP0244	301191602440	RENAULT LAGUNA III 10/2007-	Steering Tie Rod - Front
SSP0245	301191602450	RENAULT MEGANE IV 2016-	Steering Tie Rod - Front
SSP0246	301191602460	RENAULT TALISMAN 1st Gen 2015-	Steering Tie Rod - Front
SSP0247	301191602470	SKODA FABIA (6Y2) 08/1999-11/2006	Steering Tie Rod - Front
SSP0247	301191602470	VOLKSWAGEN POLO (9N) 10/2001-05/2009	Steering Tie Rod - Front
SSP0248	301191602480	SKODA FABIA (5J) 12/2006-09/2014	Steering Tie Rod - Front



 SHORT LONG			DESCRIPTION
SSP0248	301191602480	SKODA PRAKTIK 03/2007-	Steering Tie Rod - Front
SSP0248	301191602480	SKODA ROOMSTER (5J) 07/2006-	Steering Tie Rod - Front
SSP0249	301191602490	OPEL AGILA (B) 09/2007-12/2014	Steering Tie Rod - Front
SSP0249	301191602490	SUZUKI SPLASH 01/2008-	Steering Tie Rod - Front
SSP0249	301191602490	SUZUKI SWIFT III (SG) 02/2005-09/2010	Steering Tie Rod - Front
SSP0250	301191602500	LEXUS LX470 J100 1998-2007	Steering Tie Rod - Front Inner
SSP0250	301191602500	TOYOTA LAND CRUISER J100 01/1998-08/2007	Steering Tie Rod - Front Inner
SSP0251	301191602510	LEXUS GX470 J120 2003-2010	Steering Tie Rod - Front
SSP0251	301191602510	TOYOTA LAND CRUISER J120 01/2003-02/2010	Steering Tie Rod - Front
SSP0252	301191602520	LEXUS LX470 J100 1998-2007	Steering Tie Rod - Front
SSP0252	301191602520	TOYOTA LAND CRUISER J100 01/1998-08/2007	Steering Tie Rod - Front
SSP0253	301191602530	TOYOTA HILUX III 2WD Pick-Up 08/2005-2015	Steering Tie Rod - Front
SSP0253	301191602530	TOYOTA HILUX III 4WD Pick-Up 08/2005-2015	Steering Tie Rod - Front
SSP0254	301191602540	TOYOTA ECHO XP10 1999-2005	Steering Tie Rod - Front
SSP0254	301191602540	TOYOTA YARIS (P1) 04/1999-10/2005	Steering Tie Rod - Front
SSP0255	301191602550	TOYOTA ECHO XP10 1999-2005	Steering Tie Rod - Front Inner
SSP0255	301191602550	TOYOTA YARIS (P1) 04/1999-10/2005	Steering Tie Rod - Front Inner
SSP0256	301191602560	TOYOTA YARIS (P9) 11/2005-09/2010	Steering Tie Rod - Front
SSP0257	301191602570	TOYOTA RAV4 XA10 1995-06/2000	Steering Tie Rod - Front
SSP0258	301191602580	TOYOTA RAV4 XA20 07/2000-11/2005	Steering Tie Rod - Front
SSP0259	301191602590	TOYOTA RAV4 XA20 07/2000-11/2005	Steering Tie Rod - Front
SSP0260	301191602600	TOYOTA AVENSIS (T25) 04/2003-01/2009	Steering Tie Rod - Front
SSP0260	301191602600	TOYOTA COROLLA Verso 04/2004-04/2009	Steering Tie Rod - Front
SSP0261	301191602610	TOYOTA INNOVA AN40 2005-2015	Steering Tie Rod - Front
SSP0262	301191602620	TOYOTA COROLLA E120 02/2002-01/2007	Steering Tie Rod - Front
SSP0263	301191602630	TOYOTA IQ 01/2009-2016	Steering Tie Rod - Front
SSP0264	301191602640	TOYOTA COROLLA E140 02/2007-06/2013	Steering Tie Rod - Front
SSP0265	301191602650	TOYOTA LAND CRUISER J200 01/2008-	Steering Tie Rod - Front
SSP0266	301191602660	TOYOTA LAND CRUISER J150 03/2010-	Steering Tie Rod - Front
SSP0267	301191602670	AUDI Q7 4L 03/2006-08/2010	Steering Tie Rod - Front
SSP0267	301191602670	PORSCHE CAYENNE 92A 2011-	Steering Tie Rod - Front
SSP0267	301191602670	PORSCHE CAYENNE 955 09/2002-08/2010	Steering Tie Rod - Front
SSP0267	301191602670	VOLKSWAGEN AMAROK 09/2010-	Steering Tie Rod - Front
SSP0267	301191602670	VOLKSWAGEN GOL 2002-2010	Steering Tie Rod - Front
SSP0267	301191602670	VOLKSWAGEN TOUAREG (7LA,7L6,7L7) 10/2002-05/2010	Steering Tie Rod - Front
SSP0268	301191602680	SKODA KODIAQ (NS7) 2016-	Steering Tie Rod - Front Inner
SSP0268	301191602680	SKODA SUPERB (3V3) 2015-	Steering Tie Rod - Front Inner





 SHORT LONG			DESCRIPTION
SSP0268	301191602680	VOLKSWAGEN BEETLE A5 04/2011-	Steering Tie Rod - Front Inner
SSP0268	301191602680	VOLKSWAGEN PASSAT 3G2 2014-	Steering Tie Rod - Front Inner
SSP0269	301191602690	AUDI A3 8P1 06/2003-08/2012	Steering Tie Rod - Front Inner
SSP0269	301191602690	AUDI A3 8V1 09/2012-	Steering Tie Rod - Front Inner
SSP0269	301191602690	SEAT ALTEA V 03/2004-	Steering Tie Rod - Front Inner
SSP0269	301191602690	SEAT LEON (5F1) 12/2012-	Steering Tie Rod - Front Inner
SSP0269	301191602690	SEAT LEON 1P1 2006-2012	Steering Tie Rod - Front Inner
SSP0269	301191602690	SEAT TOLEDO III (5P2) 07/2006-05/2009	Steering Tie Rod - Front Inner
SSP0269	301191602690	SKODA OCTAVIA (1Z3), (1Z5) 06/2004-10/2012	Steering Tie Rod - Front Inner
SSP0269	301191602690	SKODA OCTAVIA (5 E) 11/2012-	Steering Tie Rod - Front Inner
SSP0269	301191602690	SKODA SUPERB (3T4) 04/2008-	Steering Tie Rod - Front Inner
SSP0269	301191602690	SKODA YETI (5L) 05/2009-	Steering Tie Rod - Front Inner
SSP0269	301191602690	VOLKSWAGEN EOS 2006-2016	Steering Tie Rod - Front Inner
SSP0269	301191602690	VOLKSWAGEN GOLF MK5/A5 10/2003-06/2009	Steering Tie Rod - Front Inner
SSP0269	301191602690	VOLKSWAGEN GOLF MK6/A6 2010-2013	Steering Tie Rod - Front Inner
SSP0269	301191602690	VOLKSWAGEN GOLF MK7/MQB 11/2012-	Steering Tie Rod - Front Inner
SSP0269	301191602690	VOLKSWAGEN GTI MK5/A5 2006-2009	Steering Tie Rod - Front Inner
SSP0269	301191602690	VOLKSWAGEN JETTA IV (162) 11/2010-	Steering Tie Rod - Front Inner
SSP0269	301191602690	VOLKSWAGEN JETTA MK5/A5 08/2005-10/2010	Steering Tie Rod - Front Inner
SSP0269	301191602690	VOLKSWAGEN PASSAT B6 09/2005-07/2010	Steering Tie Rod - Front Inner
SSP0269	301191602690	VOLKSWAGEN PASSAT B7 08/2010-04/2015	Steering Tie Rod - Front Inner
SSP0269	301191602690	VOLKSWAGEN Rabbit MK5/A5 10/2003-06/2009	Steering Tie Rod - Front Inner
SSP0269	301191602690	VOLKSWAGEN SHARAN (7M6,7M8,7M9) 05/1995-03/2010	Steering Tie Rod - Front Inner
SSP0269	301191602690	VOLKSWAGEN SHARAN (7N) 04/2010-	Steering Tie Rod - Front Inner
SSP0269	301191602690	VOLKSWAGEN TIGUAN 1st Gen 09/2007-2016	Steering Tie Rod - Front Inner
SSP0269	301191602690	VOLKSWAGEN TOURAN (1T1,1T2) 02/2003-05/2010	Steering Tie Rod - Front Inner
SSP0269	301191602690	VOLKSWAGEN TOURAN (1T3) 06/2010-	Steering Tie Rod - Front Inner
SSP0270	301191602700	SEAT Mii (KYF) 10/2011-	Steering Tie Rod - Front
SSP0270	301191602700	VOLKSWAGEN Up! 12/2011-2016	Steering Tie Rod - Front
SSP0271	301191602710	VOLKSWAGEN TRANSPORTER T5 05/2003-04/2011	Steering Tie Rod - Front
SSP0271	301191602710	VOLKSWAGEN TRANSPORTER T5, facelift 05/2011-2016	Steering Tie Rod - Front
SSP0271	301191602710	VOLKSWAGEN TRANSPORTER T6 2016-	Steering Tie Rod - Front
SSP0272	301191602720	FORD GALAXY 05/1995-04/2006	Steering Tie Rod - Front Inner
SSP0272	301191602720	SEAT ALHAMBRA (7V8,7V9) 04/1996-03/2010	Steering Tie Rod - Front Inner
SSP0272	301191602720	VOLKSWAGEN SHARAN (7M6,7M8,7M9) 05/1995-03/2010	Steering Tie Rod - Front Inner





			DESCRIPTION
SHORT	LONG		
SSP0273	301191602730	SEAT AROSA 05/1997-06/2004	Steering Tie Rod - Front
SSP0273	301191602730	VOLKSWAGEN LUPO 09/1998-07/2005	Steering Tie Rod - Front
SSP0273	301191602730	VOLKSWAGEN POLO (6N1) 1994-09/2001	Steering Tie Rod - Front
SSP0274	301191602740	SEAT AROSA 05/1997-06/2004	Steering Tie Rod - Front
SSP0274	301191602740	VOLKSWAGEN LUPO 09/1998-07/2005	Steering Tie Rod - Front
SSP0274	301191602740	VOLKSWAGEN POLO (6N1) 1994-09/2001	Steering Tie Rod - Front
SSP0275	301191602750	SEAT AROSA 05/1997-06/2004	Steering Tie Rod - Front
SSP0275	301191602750	VOLKSWAGEN LUPO 09/1998-07/2005	Steering Tie Rod - Front
SSP0275	301191602750	VOLKSWAGEN POLO (6N1) 1994-09/2001	Steering Tie Rod - Front
SSP0276	301191602760	AUDI A1 8X1 04/2010-	Steering Tie Rod - Front
SSP0276	301191602760	AUDI A2 02/2000-08/2005	Steering Tie Rod - Front
SSP0276	301191602760	SEAT IBIZA V (6R) 03/2008-	Steering Tie Rod - Front
SSP0276	301191602760	SKODA RAPID 07/2012-	Steering Tie Rod - Front
SSP0276	301191602760	VOLKSWAGEN POLO (6R) 06/2009-	Steering Tie Rod - Front
SSP0277	301191602770	VOLVO S80 I (TS,XY) 05/1998-07/2006	Steering Tie Rod - Front
SSP0277	301191602770	VOLVO V70 II (P80) 03/2000-08/2007	Steering Tie Rod - Front
SSP0278	301191602780	VOLVO S80 I (TS,XY) 05/1998-07/2006	Steering Tie Rod - Front
SSP0279	301191602790	VOLVO S60 I 07/2000-04/2010	Steering Tie Rod - Front Inner
SSP0279	301191602790	VOLVO S80 I (TS,XY) 05/1998-07/2006	Steering Tie Rod - Front Inner
SSP0279	301191602790	VOLVO XC70 II Cross Country 03/2000-08/2007	Steering Tie Rod - Front Inner
SSP0279	301191602790	VOLVO XC90 I 10/2002-10/2014	Steering Tie Rod - Front Inner
SSP0280	301191602800	VOLVO XC60 05/2008-2016	Steering Tie Rod - Front
SSP0281	301191602810	VOLVO S60 II 04/2010-	Steering Tie Rod - Front
SSP0281	301191602810	VOLVO XC60 05/2008-2016	Steering Tie Rod - Front
SSP0282	301191602820	AUDI 80 1979-1986	Steering Tie Rod End - Front
SSP0282	301191602820	AUDI 80 1987-1991	Steering Tie Rod End - Front
SSP0282	301191602820	AUDI 80 1992-1994	Steering Tie Rod End - Front
SSP0282	301191602820	AUDI 90 1980-1986	Steering Tie Rod End - Front
SSP0282	301191602820	AUDI 90 1987-1991	Steering Tie Rod End - Front
SSP0282	301191602820	AUDI 90 1992-1994	Steering Tie Rod End - Front
SSP0282	301191602820	AUDI CABRIOLET 1991-2000	Steering Tie Rod End - Front
SSP0282	301191602820	AUDI COUPE 1982-1988	Steering Tie Rod End - Front
SSP0282	301191602820	AUDI COUPE 1988-1996	Steering Tie Rod End - Front
SSP0282	301191602820	AUDI COUPE QUATTRO 1988-1995	Steering Tie Rod End - Front
SSP0282	301191602820	VOLKSWAGEN BEETLE 1980-1988	Steering Tie Rod End - Front
SSP0282	301191602820	VOLKSWAGEN PASSAT B2 1980-1988	Steering Tie Rod End - Front
SSP0283	301191602830	AUDI A1 8X1 04/2010-	Steering Tie Rod End - Front Right
SSP0283	301191602830	AUDI A3 8L1 09/1996-05/2003	Steering Tie Rod End - Front Right
SSP0283	301191602830	SEAT LEON 1M1 03/1999-05/2006	Steering Tie Rod End - Front Right
SSP0283	301191602830	SEAT TOLEDO II (1M2) 03/1999-05/2006	Steering Tie Rod End - Front Right



 SHORT LONG			DESCRIPTION
SSP0283	301191602830	SKODA OCTAVIA (1U2), (1U5) 07/1996-05/2004	Steering Tie Rod End - Front Right
SSP0283	301191602830	VOLKSWAGEN BEETLE 9C1, 1C1 1998-2010	Steering Tie Rod End - Front Right
SSP0283	301191602830	VOLKSWAGEN GOLF MK4/A4 1998-09/2003	Steering Tie Rod End - Front Right
SSP0283	301191602830	VOLKSWAGEN JETTA MK4/A4 1998-09/2003	Steering Tie Rod End - Front Right
SSP0284	301191602840	AUDI A1 8X1 04/2010-	Steering Tie Rod End - Front Left
SSP0284	301191602840	AUDI A3 8L1 09/1996-05/2003	Steering Tie Rod End - Front Left
SSP0284	301191602840	SEAT LEON 1M1 03/1999-05/2006	Steering Tie Rod End - Front Left
SSP0284	301191602840	SEAT TOLEDO II (1M2) 03/1999-05/2006	Steering Tie Rod End - Front Left
SSP0284	301191602840	SKODA OCTAVIA (1U2), (1U5) 07/1996-05/2004	Steering Tie Rod End - Front Left
SSP0284	301191602840	VOLKSWAGEN BEETLE 9C1, 1C1 1998-2010	Steering Tie Rod End - Front Left
SSP0284	301191602840	VOLKSWAGEN GOLF MK4/A4 1998-09/2003	Steering Tie Rod End - Front Left
SSP0284	301191602840	VOLKSWAGEN JETTA MK4/A4 1998-09/2003	Steering Tie Rod End - Front Left
SSP0285	301191602850	AUDI A3 8L1 09/1996-05/2003	Steering Tie Rod End - Front Right Outer
SSP0285	301191602850	SKODA OCTAVIA (1U2), (1U5) 07/1996-05/2004	Steering Tie Rod End - Front Right Outer
SSP0285	301191602850	VOLKSWAGEN BEETLE 9C1, 1C1 1998-2010	Steering Tie Rod End - Front Right Outer
SSP0285	301191602850	VOLKSWAGEN GOLF MK4/A4 1998-09/2003	Steering Tie Rod End - Front Right Outer
SSP0285	301191602850	VOLKSWAGEN JETTA MK4/A4 1998-09/2003	Steering Tie Rod End - Front Right Outer
SSP0286	301191602860	AUDI A3 8L1 09/1996-05/2003	Steering Tie Rod End - Front Left Outer
SSP0286	301191602860	SKODA OCTAVIA (1U2), (1U5) 07/1996-05/2004	Steering Tie Rod End - Front Left Outer
SSP0286	301191602860	VOLKSWAGEN BEETLE 9C1, 1C1 1998-2010	Steering Tie Rod End - Front Left Outer
SSP0286	301191602860	VOLKSWAGEN GOLF MK4/A4 1998-09/2003	Steering Tie Rod End - Front Left Outer
SSP0286	301191602860	VOLKSWAGEN JETTA MK4/A4 1998-09/2003	Steering Tie Rod End - Front Left Outer
SSP0287	301191602870	AUDI A4 8D2, 8E5, B5 11/1994-10/2001	Steering Tie Rod End - Front
SSP0287	301191602870	AUDI A6 4B, C5 01/1997-01/2005	Steering Tie Rod End - Front
SSP0287	301191602870	AUDI A8 4D2, 4D8 03/1994-09/2002	Steering Tie Rod End - Front
SSP0287	301191602870	SKODA SUPERB (3U4) 02/2002-03/2008	Steering Tie Rod End - Front
SSP0287	301191602870	VOLKSWAGEN PASSAT B5, B5.5 1997-08/2005	Steering Tie Rod End - Front
SSP0288	301191602880	AUDI A4 8K2, 8K5 11/2007-06/2015	Steering Tie Rod End - Front Right Outer
SSP0288	301191602880	AUDI A5 8T3 2007-2015	Steering Tie Rod End - Front Right Outer
SSP0288	301191602880	AUDI Q5 8R 11/2008-2016	Steering Tie Rod End - Front Right Outer
SSP0289	301191602890	AUDI A4 8K2, 8K5 11/2007-06/2015	Steering Tie Rod End - Front Left Outer
SSP0289	301191602890	AUDI A5 8T3 2007-2015	Steering Tie Rod End - Front Left Outer
SSP0289	301191602890	AUDI Q5 8R 11/2008-2016	Steering Tie Rod End - Front Left Outer
SSP0290	301191602900	AUDI TT 8N3, ROADSTER, 8N9 02/1999-06/2006	Steering Tie Rod End - Front Right
SSP0291	301191602910	AUDI TT 8N3, ROADSTER, 8N9 02/1999-06/2006	Steering Tie Rod End - Front Left
SSP0292	301191602920	AUDI A4 8EC, 8ED 11/2004-06/2008	Steering Tie Rod End - Front





 SHORT LONG			DESCRIPTION
SSP0292	301191602920	AUDI A6 4F2, C6 02/2005-03/2011	Steering Tie Rod End - Front
SSP0293	301191602930	AUDI A6 4G2, C5 04/2011-	Steering Tie Rod End - Front Right
SSP0293	301191602930	AUDI A7 4 GA Sportback 10/2010-	Steering Tie Rod End - Front Right
SSP0293	301191602930	AUDI Q5 8R 11/2008-2016	Steering Tie Rod End - Front Right
SSP0294	301191602940	AUDI A6 4G2, C5 04/2011-	Steering Tie Rod End - Front Left
SSP0294	301191602940	AUDI A7 4 GA Sportback 10/2010-	Steering Tie Rod End - Front Left
SSP0294	301191602940	AUDI Q5 8R 11/2008-2016	Steering Tie Rod End - Front Left
SSP0295	301191602950	AUDI TT 8J3 07/2006-06/2014	Steering Tie Rod End - Front Right
SSP0296	301191602960	AUDI TT 8J3 07/2006-06/2014	Steering Tie Rod End - Front Left
SSP0297	301191602970	AUDI TT FV3 2014-	Steering Tie Rod End - Front Right
SSP0298	301191602980	AUDI TT FV3 2014-	Steering Tie Rod End - Front Left
SSP0299	301191602990	AUDI A8 4E 10/2002-07/2010	Steering Tie Rod End - Front
SSP0299	301191602990	VOLKSWAGEN PHAETON 04/2002-2016	Steering Tie Rod End - Front
SSP0300	301191603000	AUDI A8 4H 08/2010-	Steering Tie Rod End - Front Right
SSP0301	301191603010	AUDI A8 4H 08/2010-	Steering Tie Rod End - Front Left
SSP0302	301191603020	BMW 218i Active Tourer F45,F46 09/2014-	Steering Tie Rod End - Front Right
SSP0302	301191603020	BMW 218i F 2014-	Steering Tie Rod End - Front Right
SSP0302	301191603020	BMW 220i Active Tourer F45,F46 09/2014-	Steering Tie Rod End - Front Right
SSP0302	301191603020	BMW 220i F 2014-	Steering Tie Rod End - Front Right
SSP0302	301191603020	BMW 228i F 2014-	Steering Tie Rod End - Front Right
SSP0302	301191603020	BMW 235i F 2014-	Steering Tie Rod End - Front Right
SSP0302	301191603020	BMW X1 F48 2015-	Steering Tie Rod End - Front Right
SSP0302	301191603020	MINI Cooper (F55,F56) 07/2014-	Steering Tie Rod End - Front Right
SSP0303	301191603030	BMW 218i Active Tourer F45,F46 09/2014-	Steering Tie Rod End - Front Left
SSP0303	301191603030	BMW 218i F 2014-	Steering Tie Rod End - Front Left
SSP0303	301191603030	BMW 220i Active Tourer F45,F46 09/2014-	Steering Tie Rod End - Front Left
SSP0303	301191603030	BMW 220i F 2014-	Steering Tie Rod End - Front Left
SSP0303	301191603030	BMW 228i F 2014-	Steering Tie Rod End - Front Left
SSP0303	301191603030	BMW 235i F 2014-	Steering Tie Rod End - Front Left
SSP0303	301191603030	BMW X1 F48 2015-	Steering Tie Rod End - Front Left
SSP0303	301191603030	MINI Cooper (F55,F56) 07/2014-	Steering Tie Rod End - Front Left
SSP0304	301191603040	BMW 120i E81, E82, E87, E88 09/2004-09/2012	Steering Tie Rod End - Front Right
SSP0304	301191603040	BMW 125i E81, E82, E87, E88 09/2004-09/2012	Steering Tie Rod End - Front Right
SSP0304	301191603040	BMW 128i E81, E82, E87, E88 09/2004-09/2012	Steering Tie Rod End - Front Right
SSP0304	301191603040	BMW 130i E81, E82, E87, E88 09/2004-09/2012	Steering Tie Rod End - Front Right
SSP0304	301191603040	BMW 135i E81, E82, E87, E88 09/2004-09/2012	Steering Tie Rod End - Front Right
SSP0304	301191603040	BMW 323i E90/E91/E92/E93 01/2005-12/2011	Steering Tie Rod End - Front Right





 SHORT LONG			DESCRIPTION
SSP0304	301191603040	BMW 325Ci E90/E91/E92/E93 01/2005-12/2011	Steering Tie Rod End - Front Right
SSP0304	301191603040	BMW 325i E90/E91/E92/E93 01/2005-12/2011	Steering Tie Rod End - Front Right
SSP0304	301191603040	BMW 328i E90/E91/E92/E93 01/2005-12/2011	Steering Tie Rod End - Front Right
SSP0304	301191603040	BMW 330Ci E90/E91/E92/E93 01/2005-12/2011	Steering Tie Rod End - Front Right
SSP0304	301191603040	BMW 330i E90/E91/E92/E93 01/2005-12/2011	Steering Tie Rod End - Front Right
SSP0304	301191603040	BMW 335d E90/E91/E92/E93 01/2005-12/2011	Steering Tie Rod End - Front Right
SSP0304	301191603040	BMW 335i E90/E91/E92/E93 01/2005-12/2011	Steering Tie Rod End - Front Right
SSP0304	301191603040	BMW 335is E90/E91/E92/E93 01/2005-12/2011	Steering Tie Rod End - Front Right
SSP0304	301191603040	BMW X1 E84 10/2009-2016	Steering Tie Rod End - Front Right
SSP0305	301191603050	BMW 120i E81, E82, E87, E88 09/2004-09/2012	Steering Tie Rod End - Front Left
SSP0305	301191603050	BMW 125i E81, E82, E87, E88 09/2004-09/2012	Steering Tie Rod End - Front Left
SSP0305	301191603050	BMW 128i E81, E82, E87, E88 09/2004-09/2012	Steering Tie Rod End - Front Left
SSP0305	301191603050	BMW 130i E81, E82, E87, E88 09/2004-09/2012	Steering Tie Rod End - Front Left
SSP0305	301191603050	BMW 135i E81, E82, E87, E88 09/2004-09/2012	Steering Tie Rod End - Front Left
SSP0305	301191603050	BMW 323i E90/E91/E92/E93 01/2005-12/2011	Steering Tie Rod End - Front Left
SSP0305	301191603050	BMW 325Ci E90/E91/E92/E93 01/2005-12/2011	Steering Tie Rod End - Front Left
SSP0305	301191603050	BMW 325i E90/E91/E92/E93 01/2005-12/2011	Steering Tie Rod End - Front Left
SSP0305	301191603050	BMW 328i E90/E91/E92/E93 01/2005-12/2011	Steering Tie Rod End - Front Left
SSP0305	301191603050	BMW 330Ci E90/E91/E92/E93 01/2005-12/2011	Steering Tie Rod End - Front Left
SSP0305	301191603050	BMW 330i E90/E91/E92/E93 01/2005-12/2011	Steering Tie Rod End - Front Left
SSP0305	301191603050	BMW 335d E90/E91/E92/E93 01/2005-12/2011	Steering Tie Rod End - Front Left
SSP0305	301191603050	BMW 335i E90/E91/E92/E93 01/2005-12/2011	Steering Tie Rod End - Front Left
SSP0305	301191603050	BMW 335is E90/E91/E92/E93 01/2005-12/2011	Steering Tie Rod End - Front Left
SSP0305	301191603050	BMW X1 E84 10/2009-2016	Steering Tie Rod End - Front Left
SSP0306	301191603060	BMW 325xi E90/E91/E92/E93 (xDrive) 4x4 01/2005-12/2011	Steering Tie Rod End - Front Right
SSP0306	301191603060	BMW 328i xDrive E90/E91/E92/E93 (xDrive) 4x4 01/2005-12/2011	Steering Tie Rod End - Front Right
SSP0306	301191603060	BMW 328xi E90/E91/E92/E93 (xDrive) 4x4 01/2005-12/2011	Steering Tie Rod End - Front Right
SSP0306	301191603060	BMW 330xi E90/E91/E92/E93 (xDrive) 4x4 01/2005-12/2011	Steering Tie Rod End - Front Right
SSP0306	301191603060	BMW 335i xDrive E90/E91/E92/E93 (xDrive) 4x4 01/2005-12/2011	Steering Tie Rod End - Front Right
SSP0306	301191603060	BMW 335xi E90/E91/E92/E93 (xDrive) 4x4 01/2005-12/2011	Steering Tie Rod End - Front Right
SSP0306	301191603060	BMW X1 E84 (xDrive) 4x4 10/2009-2016	Steering Tie Rod End - Front Right





 SHORT LONG			DESCRIPTION
SSP0307	301191603070	BMW 325xi E90/E91/E92/E93 (xDrive) 4x4 01/2005-12/2011	Steering Tie Rod End - Front Left
SSP0307	301191603070	BMW 328i xDrive E90/E91/E92/E93 (xDrive) 4x4 01/2005-12/2011	Steering Tie Rod End - Front Left
SSP0307	301191603070	BMW 328xi E90/E91/E92/E93 (xDrive) 4x4 01/2005-12/2011	Steering Tie Rod End - Front Left
SSP0307	301191603070	BMW 330xi E90/E91/E92/E93 (xDrive) 4x4 01/2005-12/2011	Steering Tie Rod End - Front Left
SSP0307	301191603070	BMW 335i xDrive E90/E91/E92/E93 (xDrive) 4x4 01/2005-12/2011	Steering Tie Rod End - Front Left
SSP0307	301191603070	BMW 335xi E90/E91/E92/E93 (xDrive) 4x4 01/2005-12/2011	Steering Tie Rod End - Front Left
SSP0307	301191603070	BMW X1 E84 (xDrive) 4x4 10/2009-2016	Steering Tie Rod End - Front Left
SSP0308	301191603080	BMW 118i F 10/2011-	Steering Tie Rod End - Front Right
SSP0308	301191603080	BMW 120i F 10/2011-	Steering Tie Rod End - Front Right
SSP0308	301191603080	BMW 125i F 10/2011-	Steering Tie Rod End - Front Right
SSP0308	301191603080	BMW 128i F 10/2011-	Steering Tie Rod End - Front Right
SSP0308	301191603080	BMW 130i F 10/2011-	Steering Tie Rod End - Front Right
SSP0308	301191603080	BMW 135i F 10/2011-	Steering Tie Rod End - Front Right
SSP0308	301191603080	BMW 135is F 10/2011-	Steering Tie Rod End - Front Right
SSP0308	301191603080	BMW 320i F 10/2011-	Steering Tie Rod End - Front Right
SSP0308	301191603080	BMW 325i F 10/2011-	Steering Tie Rod End - Front Right
SSP0308	301191603080	BMW 328d F 10/2011-	Steering Tie Rod End - Front Right
SSP0308	301191603080	BMW 328i F 10/2011-	Steering Tie Rod End - Front Right
SSP0308	301191603080	BMW 330i F 10/2011-	Steering Tie Rod End - Front Right
SSP0308	301191603080	BMW 335i F 10/2011-	Steering Tie Rod End - Front Right
SSP0308	301191603080	BMW 335is F 10/2011-	Steering Tie Rod End - Front Right
SSP0308	301191603080	BMW 340i F 10/2011-	Steering Tie Rod End - Front Right
SSP0308	301191603080	BMW 420i F 05/2014-	Steering Tie Rod End - Front Right
SSP0308	301191603080	BMW 420i Gran Coupe F 05/2014-	Steering Tie Rod End - Front Right
SSP0308	301191603080	BMW 428i F 05/2014-	Steering Tie Rod End - Front Right
SSP0308	301191603080	BMW 428i Gran Coupe F 05/2014-	Steering Tie Rod End - Front Right
SSP0308	301191603080	BMW 435i F 05/2014-	Steering Tie Rod End - Front Right
SSP0308	301191603080	BMW 435i Gran Coupe F 05/2014-	Steering Tie Rod End - Front Right
SSP0309	301191603090	BMW 118i F 10/2011-	Steering Tie Rod End - Front Left
SSP0309	301191603090	BMW 120i F 10/2011-	Steering Tie Rod End - Front Left
SSP0309	301191603090	BMW 125i F 10/2011-	Steering Tie Rod End - Front Left
SSP0309	301191603090	BMW 128i F 10/2011-	Steering Tie Rod End - Front Left
SSP0309	301191603090	BMW 130i F 10/2011-	Steering Tie Rod End - Front Left
SSP0309	301191603090	BMW 135i F 10/2011-	Steering Tie Rod End - Front Left
SSP0309	301191603090	BMW 135is F 10/2011-	Steering Tie Rod End - Front Left
SSP0309	301191603090	BMW 320i F 10/2011-	Steering Tie Rod End - Front Left
SSP0309	301191603090	BMW 325i F 10/2011-	Steering Tie Rod End - Front Left



 SHORT LONG			DESCRIPTION
SSP0309	301191603090	BMW 328d F 10/2011-	Steering Tie Rod End - Front Left
SSP0309	301191603090	BMW 328i F 10/2011-	Steering Tie Rod End - Front Left
SSP0309	301191603090	BMW 330i F 10/2011-	Steering Tie Rod End - Front Left
SSP0309	301191603090	BMW 335i F 10/2011-	Steering Tie Rod End - Front Left
SSP0309	301191603090	BMW 335is F 10/2011-	Steering Tie Rod End - Front Left
SSP0309	301191603090	BMW 340i F 10/2011-	Steering Tie Rod End - Front Left
SSP0309	301191603090	BMW 420i F 05/2014-	Steering Tie Rod End - Front Left
SSP0309	301191603090	BMW 420i Gran Coupe F 05/2014-	Steering Tie Rod End - Front Left
SSP0309	301191603090	BMW 428i F 05/2014-	Steering Tie Rod End - Front Left
SSP0309	301191603090	BMW 428i Gran Coupe F 05/2014-	Steering Tie Rod End - Front Left
SSP0309	301191603090	BMW 435i F 05/2014-	Steering Tie Rod End - Front Left
SSP0309	301191603090	BMW 435i Gran Coupe F 05/2014-	Steering Tie Rod End - Front Left
SSP0310	301191603100	BMW 525i E39 11/1995-06/2003	Steering Tie Rod End - Front Right Outer
SSP0310	301191603100	BMW 528i E39 11/1995-06/2003	Steering Tie Rod End - Front Right Outer
SSP0310	301191603100	BMW 530i E39 11/1995-06/2003	Steering Tie Rod End - Front Right Outer
SSP0311	301191603110	BMW 525i E39 11/1995-06/2003	Steering Tie Rod End - Front Left Outer
SSP0311	301191603110	BMW 528i E39 11/1995-06/2003	Steering Tie Rod End - Front Left Outer
SSP0311	301191603110	BMW 530i E39 11/1995-06/2003	Steering Tie Rod End - Front Left Outer
SSP0312	301191603120	BMW 525i E39 11/1995-06/2003	Steering Tie Rod End - Front Right
SSP0312	301191603120	BMW 528i E39 11/1995-06/2003	Steering Tie Rod End - Front Right
SSP0312	301191603120	BMW 530i E39 11/1995-06/2003	Steering Tie Rod End - Front Right
SSP0312	301191603120	BMW 540i E39 11/1995-06/2003	Steering Tie Rod End - Front Right
SSP0313	301191603130	BMW 525i E39 11/1995-06/2003	Steering Tie Rod End - Front Left
SSP0313	301191603130	BMW 528i E39 11/1995-06/2003	Steering Tie Rod End - Front Left
SSP0313	301191603130	BMW 530i E39 11/1995-06/2003	Steering Tie Rod End - Front Left
SSP0313	301191603130	BMW 540i E39 11/1995-06/2003	Steering Tie Rod End - Front Left
SSP0314	301191603140	BMW 320i E46 02/1998-04/2005	Steering Tie Rod End - Front Right
SSP0314	301191603140	BMW 323Ci E46 02/1998-04/2005	Steering Tie Rod End - Front Right
SSP0314	301191603140	BMW 323i E46 02/1998-04/2005	Steering Tie Rod End - Front Right
SSP0314	301191603140	BMW 325Ci E46 02/1998-04/2005	Steering Tie Rod End - Front Right
SSP0314	301191603140	BMW 325i E46 02/1998-04/2005	Steering Tie Rod End - Front Right
SSP0314	301191603140	BMW 330Ci E46 02/1998-04/2005	Steering Tie Rod End - Front Right
SSP0314	301191603140	BMW 330i E46 02/1998-04/2005	Steering Tie Rod End - Front Right
SSP0314	301191603140	BMW Z4 E85 02/2003-02/2009	Steering Tie Rod End - Front Right
SSP0315	301191603150	BMW 320i E46 02/1998-04/2005	Steering Tie Rod End - Front Left
SSP0315	301191603150	BMW 323Ci E46 02/1998-04/2005	Steering Tie Rod End - Front Left
SSP0315	301191603150	BMW 323i E46 02/1998-04/2005	Steering Tie Rod End - Front Left
SSP0315	301191603150	BMW 325Ci E46 02/1998-04/2005	Steering Tie Rod End - Front Left
SSP0315	301191603150	BMW 325i E46 02/1998-04/2005	Steering Tie Rod End - Front Left
SSP0315	301191603150	BMW 330Ci E46 02/1998-04/2005	Steering Tie Rod End - Front Left
SSP0315	301191603150	BMW 330i E46 02/1998-04/2005	Steering Tie Rod End - Front Left



 SHORT LONG			DESCRIPTION
SSP0315	301191603150	BMW Z4 E85 02/2003-02/2009	Steering Tie Rod End - Front Left
SSP0316	301191603160	BMW 525i E60 - E61 07/2003-03/2010	Steering Tie Rod End - Front
SSP0316	301191603160	BMW 528i E60 - E61 07/2003-03/2010	Steering Tie Rod End - Front
SSP0316	301191603160	BMW 530i E60 - E61 07/2003-03/2010	Steering Tie Rod End - Front
SSP0316	301191603160	BMW 535i E60 - E61 07/2003-03/2010	Steering Tie Rod End - Front
SSP0316	301191603160	BMW 545i E60 - E61 07/2003-03/2010	Steering Tie Rod End - Front
SSP0316	301191603160	BMW 550i E60 - E61 07/2003-03/2010	Steering Tie Rod End - Front
SSP0316	301191603160	BMW 645Ci E63, E64 01/2004-11/2010	Steering Tie Rod End - Front
SSP0316	301191603160	BMW 650Ci E63, E64 01/2004-11/2010	Steering Tie Rod End - Front
SSP0316	301191603160	BMW 650i E63, E64 01/2004-11/2010	Steering Tie Rod End - Front
SSP0316	301191603160	BMW 745i E65, E66, E67 01/2001-09/2008	Steering Tie Rod End - Front
SSP0316	301191603160	BMW 745Li E65, E66, E67 01/2001-09/2008	Steering Tie Rod End - Front
SSP0316	301191603160	BMW 750i E65, E66, E67 01/2001-09/2008	Steering Tie Rod End - Front
SSP0316	301191603160	BMW 750Li E65, E66, E67 01/2001-09/2008	Steering Tie Rod End - Front
SSP0316	301191603160	BMW 760i E65, E66, E67 01/2001-09/2008	Steering Tie Rod End - Front
SSP0316	301191603160	BMW 760Li E65, E66, E67 01/2001-09/2008	Steering Tie Rod End - Front
SSP0317	301191603170	BMW 740i E38 1994-2002	Steering Tie Rod End - Front Right
SSP0317	301191603170	BMW 740iL E38 1994-2002	Steering Tie Rod End - Front Right
SSP0317	301191603170	BMW 745i E38 1994-2002	Steering Tie Rod End - Front Right
SSP0317	301191603170	BMW 745Li E38 1994-2002	Steering Tie Rod End - Front Right
SSP0317	301191603170	BMW 750iL E38 1994-2002	Steering Tie Rod End - Front Right
SSP0318	301191603180	BMW 740i E38 1994-2002	Steering Tie Rod End - Front Left
SSP0318	301191603180	BMW 740iL E38 1994-2002	Steering Tie Rod End - Front Left
SSP0318	301191603180	BMW 745i E38 1994-2002	Steering Tie Rod End - Front Left
SSP0318	301191603180	BMW 745Li E38 1994-2002	Steering Tie Rod End - Front Left
SSP0318	301191603180	BMW 750iL E38 1994-2002	Steering Tie Rod End - Front Left
SSP0319	301191603190	BMW X5 F15,F85 11/2012-	Steering Tie Rod End - Front Right
SSP0320	301191603200	BMW X5 F15,F85 11/2012-	Steering Tie Rod End - Front Left
SSP0321	301191603210	BMW X5 E53 05/2000-01/2007	Steering Tie Rod End - Front Outer
SSP0322	301191603220	BMW X5 E53 05/2000-01/2007	Steering Tie Rod End - Front Outer
SSP0323	301191603230	BMW X5 E70 02/2007-12/2012	Steering Tie Rod End - Front
SSP0323	301191603230	BMW X6 E71, E72 04/2008-07/2014	Steering Tie Rod End - Front
SSP0324	301191603240	BMW X3 F25 09/2010-2016	Steering Tie Rod End - Front
SSP0324	301191603240	BMW X4 F26 04/2014-	Steering Tie Rod End - Front
SSP0325	301191603250	BMW 520i F 2010-2016	Steering Tie Rod End - Front Right
SSP0325	301191603250	BMW 528i F 2010-2016	Steering Tie Rod End - Front Right
SSP0325	301191603250	BMW 530i F 2010-2016	Steering Tie Rod End - Front Right
SSP0325	301191603250	BMW 535d F 2010-2016	Steering Tie Rod End - Front Right
SSP0325	301191603250	BMW 535i F 2010-2016	Steering Tie Rod End - Front Right
SSP0325	301191603250	BMW 550i F 2010-2016	Steering Tie Rod End - Front Right
SSP0325	301191603250	BMW 640i F 2011-2016	Steering Tie Rod End - Front Right



 SHORT LONG			DESCRIPTION
SSP0325	301191603250	BMW 640i Gran Coupe F 2011-2016	Steering Tie Rod End - Front Right
SSP0325	301191603250	BMW 650i F 2011-2016	Steering Tie Rod End - Front Right
SSP0325	301191603250	BMW 650i Gran Coupe F 2011-2016	Steering Tie Rod End - Front Right
SSP0325	301191603250	BMW 740i F01, F02, F03,F04 06/2008-2016	Steering Tie Rod End - Front Right
SSP0325	301191603250	BMW 740Li F01, F02, F03,F04 06/2008-2016	Steering Tie Rod End - Front Right
SSP0325	301191603250	BMW 750i F01, F02, F03,F04 06/2008-2016	Steering Tie Rod End - Front Right
SSP0325	301191603250	BMW 750Li F01, F02, F03,F04 06/2008-2016	Steering Tie Rod End - Front Right
SSP0325	301191603250	BMW 760Li F01, F02, F03,F04 06/2008-2016	Steering Tie Rod End - Front Right
SSP0326	301191603260	BMW 520i F 2010-2016	Steering Tie Rod End - Front Left
SSP0326	301191603260	BMW 528i F 2010-2016	Steering Tie Rod End - Front Left
SSP0326	301191603260	BMW 530i F 2010-2016	Steering Tie Rod End - Front Left
SSP0326	301191603260	BMW 535d F 2010-2016	Steering Tie Rod End - Front Left
SSP0326	301191603260	BMW 535i F 2010-2016	Steering Tie Rod End - Front Left
SSP0326	301191603260	BMW 550i F 2010-2016	Steering Tie Rod End - Front Left
SSP0326	301191603260	BMW 640i F 2011-2016	Steering Tie Rod End - Front Left
SSP0326	301191603260	BMW 640i Gran Coupe F 2011-2016	Steering Tie Rod End - Front Left
SSP0326	301191603260	BMW 650i F 2011-2016	Steering Tie Rod End - Front Left
SSP0326	301191603260	BMW 650i Gran Coupe F 2011-2016	Steering Tie Rod End - Front Left
SSP0326	301191603260	BMW 740i F01, F02, F03,F04 06/2008-2016	Steering Tie Rod End - Front Left
SSP0326	301191603260	BMW 740Li F01, F02, F03,F04 06/2008-2016	Steering Tie Rod End - Front Left
SSP0326	301191603260	BMW 750i F01, F02, F03,F04 06/2008-2016	Steering Tie Rod End - Front Left
SSP0326	301191603260	BMW 750Li F01, F02, F03,F04 06/2008-2016	Steering Tie Rod End - Front Left
SSP0326	301191603260	BMW 760Li F01, F02, F03,F04 06/2008-2016	Steering Tie Rod End - Front Left
SSP0327	301191603270	BMW 525xi E60 - E61, AWD 07/2003-03/2010	Steering Tie Rod End - Front
SSP0327	301191603270	BMW 528i xDrive E60 - E61, AWD 07/2003-03/2010	Steering Tie Rod End - Front
SSP0327	301191603270	BMW 528xi E60 - E61, AWD 07/2003-03/2010	Steering Tie Rod End - Front
SSP0327	301191603270	BMW 530xi E60 - E61, AWD 07/2003-03/2010	Steering Tie Rod End - Front
SSP0327	301191603270	BMW 535i xDrive E60 - E61, AWD 07/2003-03/2010	Steering Tie Rod End - Front
SSP0327	301191603270	BMW 535xi E60 - E61, AWD 07/2003-03/2010	Steering Tie Rod End - Front
SSP0327	301191603270	BMW 545i E60 - E61 07/2003-03/2010	Steering Tie Rod End - Front
SSP0328	301191603280	CHEVROLET EVANDA V200 03/2003-09/2006	Steering Tie Rod End - Front
SSP0329	301191603290	CHEVROLET EPICA V250 01/2005-03/2011	Steering Tie Rod End - Front
SSP0330	301191603300	CHEVROLET IMPALA 8th, 9th Gen 2000-2013	Steering Tie Rod End - Front Outer
SSP0331	301191603310	CHEVROLET IMPALA 8th, 9th Gen 2000-2013	Steering Tie Rod End - Front
SSP0332	301191603320	BUICK LACROSSE 2nd Gen 2010-2016	Steering Tie Rod End - Front
SSP0332	301191603320	BUICK REGAL 5th Gen 2011-2016	Steering Tie Rod End - Front
SSP0332	301191603320	CHEVROLET IMPALA 10th Gen 2014-	Steering Tie Rod End - Front
SSP0333	301191603330	BUICK RAINIER 1st Gen 2003-2007	Steering Tie Rod End - Front Right Outer
SSP0333	301191603330	CHEVROLET TRAILBLAZER 1st Gen 2002-2008	Steering Tie Rod End - Front Right Outer



 SHORT LONG			DESCRIPTION
SSP0334	301191603340	BUICK RAINIER 1st Gen 2003-2007	Steering Tie Rod End - Front Left Outer
SSP0334	301191603340	CHEVROLET TRAILBLAZER 1st Gen 2002-2008	Steering Tie Rod End - Front Left Outer
SSP0335	301191603350	CHEVROLET AVEO T250 05/2005-02/2011	Steering Tie Rod End - Front Right
SSP0335	301191603350	DAEWOO KALOS (KLAS) 09/2002-03/2011	Steering Tie Rod End - Front Right
SSP0335	301191603350	PONTIAC G3 2007-2009	Steering Tie Rod End - Front Right
SSP0336	301191603360	CHEVROLET AVEO T250 05/2005-02/2011	Steering Tie Rod End - Front Left
SSP0336	301191603360	DAEWOO KALOS (KLAS) 09/2002-03/2011	Steering Tie Rod End - Front Left
SSP0336	301191603360	PONTIAC G3 2007-2009	Steering Tie Rod End - Front Left
SSP0337	301191603370	CHEVROLET COBALT 2005-2010	Steering Tie Rod End - Front
SSP0337	301191603370	CHEVROLET EQUINOX 2005-2009	Steering Tie Rod End - Front
SSP0337	301191603370	CHEVROLET HHR 2006-2011	Steering Tie Rod End - Front
SSP0337	301191603370	GMC TERRAIN 2010-	Steering Tie Rod End - Front
SSP0338	301191603380	CHEVROLET EQUINOX 2nd Gen 2010-2016	Steering Tie Rod End - Front
SSP0338	301191603380	GMC TERRAIN 2010-	Steering Tie Rod End - Front
SSP0339	301191603390	CHEVROLET EQUINOX 2nd Gen 2010-2016	Steering Tie Rod End - Front
SSP0339	301191603390	GMC TERRAIN 2010-	Steering Tie Rod End - Front
SSP0340	301191603400	CHEVROLET AVEO T300 03/2011-2016	Steering Tie Rod End - Front
SSP0341	301191603410	CHEVROLET AVEO T300 03/2011-2016	Steering Tie Rod End - Front
SSP0342	301191603420	CHEVROLET LACETTI J200 (OPTRA) 03/2003-04/2012	Steering Tie Rod End - Front Right
SSP0342	301191603420	CHEVROLET OPTRA J200 03/2003-04/2012	Steering Tie Rod End - Front Right
SSP0342	301191603420	DAEWOO NUBIRA II (1.6i, 1.8i) 07/2003-2009	Steering Tie Rod End - Front Right
SSP0342	301191603420	SUZUKI RENO 1st Gen J200 2004-2008	Steering Tie Rod End - Front Right
SSP0343	301191603430	CHEVROLET LACETTI J200 (OPTRA) 03/2003-04/2012	Steering Tie Rod End - Front Left
SSP0343	301191603430	CHEVROLET OPTRA J200 03/2003-04/2012	Steering Tie Rod End - Front Left
SSP0343	301191603430	DAEWOO NUBIRA II (1.6i, 1.8i) 07/2003-2009	Steering Tie Rod End - Front Left
SSP0343	301191603430	SUZUKI RENO 1st Gen J200 2004-2008	Steering Tie Rod End - Front Left
SSP0344	301191603440	CHEVROLET MALIBU 7th Gen 2004-2012	Steering Tie Rod End - Front
SSP0345	301191603450	CHEVROLET MALIBU 8th Gen 2013-2016	Steering Tie Rod End - Front Right
SSP0345	301191603450	CHEVROLET MALIBU LIMITED 9th Gen 2016-	Steering Tie Rod End - Front Right
SSP0346	301191603460	CHEVROLET MALIBU 8th Gen 2013-2016	Steering Tie Rod End - Front Left
SSP0346	301191603460	CHEVROLET MALIBU LIMITED 9th Gen 2016-	Steering Tie Rod End - Front Left
SSP0347	301191603470	CHEVROLET MALIBU 6th Gen 1997-2005	Steering Tie Rod End - Front Outer
SSP0348	301191603480	CHEVROLET REZZO U100 (VIVANT) 2004-2009	Steering Tie Rod End - Front Right
SSP0348	301191603480	CHEVROLET TACUMA 2000-2008	Steering Tie Rod End - Front Right
SSP0348	301191603480	DAEWOO REZZO (KLAU) 09/2000-02/2011	Steering Tie Rod End - Front Right
SSP0349	301191603490	CHEVROLET REZZO U100 (VIVANT) 2004-2009	Steering Tie Rod End - Front Left



			DESCRIPTION
SHORT	LONG		
SSP0349	301191603490	CHEVROLET TACUMA 2000-2008	Steering Tie Rod End - Front Left
SSP0349	301191603490	DAEWOO REZZO (KLAU) 09/2000-02/2011	Steering Tie Rod End - Front Left
SSP0350	301191603500	CHEVROLET EXPRESS 1500 1st Gen 2003-2014	Steering Tie Rod End - Front
SSP0350	301191603500	CHEVROLET EXPRESS 2500 2003-	Steering Tie Rod End - Front
SSP0350	301191603500	GMC SAVANA 1500 2003-	Steering Tie Rod End - Front
SSP0350	301191603500	GMC SAVANA 2500 2003-	Steering Tie Rod End - Front
SSP0351	301191603510	CHEVROLET CORVETTE C5 01/1997-09/2004	Steering Tie Rod End - Front
SSP0351	301191603510	CHEVROLET CORVETTE C6 2005-2011	Steering Tie Rod End - Front
SSP0352	301191603520	CHEVROLET CORVETTE C7 2014-	Steering Tie Rod End - Front Right
SSP0353	301191603530	CHEVROLET CORVETTE C7 2014-	Steering Tie Rod End - Front Left
SSP0354	301191603540	CHEVROLET CAPTIVA 06/2006-05/2010	Steering Tie Rod End - Front
SSP0354	301191603540	OPEL ANTARA 05/2006-	Steering Tie Rod End - Front
SSP0355	301191603550	CHEVROLET CAPTIVA SPORT 1st Gen 2012-	Steering Tie Rod End - Front
SSP0355	301191603550	CHEVROLET EQUINOX 1st Gen 2009-	Steering Tie Rod End - Front
SSP0356	301191603560	CHEVROLET CAMARO 5th Gen 2010-2015	Steering Tie Rod End - Front
SSP0357	301191603570	CHEVROLET CAMARO 4th Gen 1993-2002	Steering Tie Rod End - Front Outer
SSP0358	301191603580	CHEVROLET N300 (Argentina) 06/2006-	Steering Tie Rod End - Front Right
SSP0359	301191603590	CHEVROLET N300 (Argentina) 06/2006-	Steering Tie Rod End - Front Left
SSP0360	301191603600	CHEVROLET SPARK M300 03/2010-2016	Steering Tie Rod End - Front
SSP0361	301191603610	CHEVROLET HHR 2006-2011	Steering Tie Rod End - Front
SSP0362	301191603620	CHEVROLET COLORADO 1st Gen 2003-2012	Steering Tie Rod End - Front Outer
SSP0362	301191603620	GMC CANYON 1st Gen (2004-2007) 2004-2012	Steering Tie Rod End - Front Outer
SSP0363	301191603630	CHEVROLET CAVALIER 3rd Gen 1995-2005	Steering Tie Rod End - Front
SSP0364	301191603640	CADILLAC ESCALADE 3rd Gen 2007-2014	Steering Tie Rod End - Front Outer
SSP0364	301191603640	CHEVROLET TAHOE 3rd Gen, GMT900 2007-2014	Steering Tie Rod End - Front Outer
SSP0364	301191603640	GMC YUKON GMT900 2007-2014	Steering Tie Rod End - Front Outer
SSP0365	301191603650	BUICK ENCLAVE 1st Gen 2008-2015	Steering Tie Rod End - Front
SSP0365	301191603650	CHEVROLET TRAVERSE 1st Gen 2009-2015	Steering Tie Rod End - Front
SSP0365	301191603650	GMC ACADIA 2007-2017	Steering Tie Rod End - Front
SSP0366	301191603660	CHEVROLET TRACKER 2nd Gen 1998-2005	Steering Tie Rod End - Front Right
SSP0367	301191603670	CHEVROLET TRACKER 2nd Gen 1998-2005	Steering Tie Rod End - Front Left
SSP0368	301191603680	CITROEN AX 1992-1998	Steering Tie Rod End - Front Right
SSP0368	301191603680	CITROEN C4 LA 11/2004-10/2009	Steering Tie Rod End - Front Right
SSP0368	301191603680	CITROEN SAXO 1996-2003	Steering Tie Rod End - Front Right
SSP0368	301191603680	CITROEN XANTIA BREAK 1993-2003	Steering Tie Rod End - Front Right
SSP0368	301191603680	CITROEN XM BREAK 1994-2000	Steering Tie Rod End - Front Right
SSP0368	301191603680	PEUGEOT 106 08/1991-03/2004	Steering Tie Rod End - Front Right
SSP0368	301191603680	PEUGEOT 206 08/1998-12/2008	Steering Tie Rod End - Front Right





 SHORT LONG			DESCRIPTION
SSP0368	301191603680	PEUGEOT 206+ 01/2009-12/2012	Steering Tie Rod End - Front Right
SSP0368	301191603680	PEUGEOT 307 08/2000-12/2008	Steering Tie Rod End - Front Right
SSP0368	301191603680	PEUGEOT 605 1989-1999	Steering Tie Rod End - Front Right
SSP0369	301191603690	CITROEN AX 1986-1991	Steering Tie Rod End - Front Left
SSP0369	301191603690	CITROEN C4 LA 11/2004-10/2009	Steering Tie Rod End - Front Left
SSP0369	301191603690	CITROEN SAXO 1996-2003	Steering Tie Rod End - Front Left
SSP0369	301191603690	CITROEN XANTIA BREAK 1993-2003	Steering Tie Rod End - Front Left
SSP0369	301191603690	CITROEN XM BREAK 1994-2000	Steering Tie Rod End - Front Left
SSP0369	301191603690	PEUGEOT 106 08/1991-03/2004	Steering Tie Rod End - Front Left
SSP0369	301191603690	PEUGEOT 206 08/1998-12/2008	Steering Tie Rod End - Front Left
SSP0369	301191603690	PEUGEOT 206+ 01/2009-12/2012	Steering Tie Rod End - Front Left
SSP0369	301191603690	PEUGEOT 307 08/2000-12/2008	Steering Tie Rod End - Front Left
SSP0369	301191603690	PEUGEOT 605 1989-1999	Steering Tie Rod End - Front Left
SSP0370	301191603700	CITROEN C4 GRAND PICASSO UA 02/2007-01/2013	Steering Tie Rod End - Front Right
SSP0371	301191603710	CITROEN C4 GRAND PICASSO UA 02/2007-01/2013	Steering Tie Rod End - Front Left
SSP0372	301191603720	CITROEN C2 JM 09/2003-09/2009	Steering Tie Rod End - Front Right
SSP0372	301191603720	CITROEN C3 FC 03/2003-10/2009	Steering Tie Rod End - Front Right
SSP0373	301191603730	CITROEN C2 JM 09/2003-09/2009	Steering Tie Rod End - Front Left
SSP0373	301191603730	CITROEN C3 FC 03/2003-10/2009	Steering Tie Rod End - Front Left
SSP0374	301191603740	CITROEN C3 II 11/2009-2016	Steering Tie Rod End - Front Right
SSP0374	301191603740	CITROEN DS3 II 2009-2016	Steering Tie Rod End - Front Right
SSP0375	301191603750	CITROEN C3 II 11/2009-2016	Steering Tie Rod End - Front Left
SSP0375	301191603750	CITROEN DS3 II 2009-2016	Steering Tie Rod End - Front Left
SSP0376	301191603760	CITROEN C5 DC 03/2001-08/2004	Steering Tie Rod End - Front Right
SSP0377	301191603770	CITROEN C5 DC 03/2001-08/2004	Steering Tie Rod End - Front Left
SSP0378	301191603780	CITROEN C5 RD 02/2008-	Steering Tie Rod End - Front Right
SSP0379	301191603790	CITROEN C5 RD 02/2008-	Steering Tie Rod End - Front Left
SSP0380	301191603800	CITROEN DS5 11/2011-	Steering Tie Rod End - Front
SSP0381	301191603810	CHRYSLER TOWN & COUNTRY V 2008-2016	Steering Tie Rod End -
SSP0381	301191603810	DODGE GRAND CARAVAN V 2008-2016	Steering Tie Rod End -
SSP0382	301191603820	CHRYSLER TOWN & COUNTRY V 2008-2016	Steering Tie Rod End - Front
SSP0382	301191603820	DODGE GRAND CARAVAN V 2008-2016	Steering Tie Rod End - Front
SSP0383	301191603830	CHRYSLER SEBRING FJ/JX 1995-2000	Steering Tie Rod End - Front Right Outer
SSP0383	301191603830	CHRYSLER SEBRING ST22/JR 2001-2006	Steering Tie Rod End - Front Right Outer
SSP0383	301191603830	DODGE STRATUS 2nd Gen 1995-2006	Steering Tie Rod End - Front Right Outer
SSP0383	301191603830	PLYMOUTH BREEZE 1st Gen 1996-2000	Steering Tie Rod End - Front Right Outer
SSP0384	301191603840	CHRYSLER SEBRING FJ/JX 1995-2000	Steering Tie Rod End - Front Left Outer
SSP0384	301191603840	CHRYSLER SEBRING ST22/JR 2001-2006	Steering Tie Rod End - Front Left Outer
SSP0384	301191603840	DODGE STRATUS 2nd Gen 1995-2006	Steering Tie Rod End - Front Left Outer



 SHORT LONG			DESCRIPTION
SSP0384	301191603840	PLYMOUTH BREEZE 1st Gen 1996-2000	Steering Tie Rod End - Front Left Outer
SSP0385	301191603850	CHRYSLER 300M 1st Gen 1998-2004	Steering Tie Rod End - Front
SSP0385	301191603850	CHRYSLER CONCORDE 2nd Gen 1998-2004	Steering Tie Rod End - Front
SSP0386	301191603860	DACIA DOKKER 11/2012-	Steering Tie Rod End - Front Right
SSP0386	301191603860	DACIA LODGY 03/2012-	Steering Tie Rod End - Front Right
SSP0386	301191603860	DACIA LOGAN (LS) 09/2004-11/2012	Steering Tie Rod End - Front Right
SSP0386	301191603860	DACIA LOGAN II 12/2012-	Steering Tie Rod End - Front Right
SSP0386	301191603860	DACIA LOGAN MCV (KS) 02/2007-01/2013	Steering Tie Rod End - Front Right
SSP0386	301191603860	DACIA SANDERO I 06/2008-12/2012	Steering Tie Rod End - Front Right
SSP0386	301191603860	DACIA SANDERO II 01/2013-	Steering Tie Rod End - Front Right
SSP0386	301191603860	RENAULT CLIO III-SYMBOL 2013-	Steering Tie Rod End - Front Right
SSP0387	301191603870	DACIA DOKKER 11/2012-	Steering Tie Rod End - Front Left
SSP0387	301191603870	DACIA LODGY 03/2012-	Steering Tie Rod End - Front Left
SSP0387	301191603870	DACIA LOGAN (LS) 09/2004-11/2012	Steering Tie Rod End - Front Left
SSP0387	301191603870	DACIA LOGAN II 12/2012-	Steering Tie Rod End - Front Left
SSP0387	301191603870	DACIA LOGAN MCV (KS) 02/2007-01/2013	Steering Tie Rod End - Front Left
SSP0387	301191603870	DACIA SANDERO I 06/2008-12/2012	Steering Tie Rod End - Front Left
SSP0387	301191603870	RENAULT CLIO III-SYMBOL 2013-	Steering Tie Rod End - Front Left
SSP0388	301191603880	DACIA DUSTER 04/2010-	Steering Tie Rod End - Front Right
SSP0389	301191603890	DACIA DUSTER 04/2010-	Steering Tie Rod End - Front Left
SSP0390	301191603900	DODGE NITRO 2007-2012	Steering Tie Rod End - Front Right
SSP0390	301191603900	JEEP LIBERTY KK 2008-2014	Steering Tie Rod End - Front Right
SSP0391	301191603910	DODGE NITRO 2007-2012	Steering Tie Rod End - Front Left
SSP0391	301191603910	JEEP LIBERTY KK 2008-2014	Steering Tie Rod End - Front Left
SSP0392	301191603920	DODGE DURANGO 3rd Gen 2011-2017	Steering Tie Rod End - Front Right
SSP0392	301191603920	JEEP GRAND CHEROKEE WK2 2011-	Steering Tie Rod End - Front Right
SSP0393	301191603930	DODGE DURANGO 3rd Gen 2011-2017	Steering Tie Rod End - Front Left
SSP0393	301191603930	JEEP GRAND CHEROKEE WK2 2011-	Steering Tie Rod End - Front Left
SSP0394	301191603940	CHRYSLER 300 2nd Gen 2011-2017	Steering Tie Rod End - Front Right
SSP0394	301191603940	DODGE CHARGER 7th Gen 2011-	Steering Tie Rod End - Front Right
SSP0395	301191603950	CHRYSLER 300 2nd Gen 2011-2017	Steering Tie Rod End - Front Left
SSP0395	301191603950	DODGE CHARGER 7th Gen 2011-	Steering Tie Rod End - Front Left
SSP0396	301191603960	CHRYSLER 300 2nd Gen 2011-2017	Steering Tie Rod End - Front
SSP0396	301191603960	DODGE CHALLENGER 4th Gen 2008-	Steering Tie Rod End - Front
SSP0396	301191603960	DODGE CHARGER 7th Gen 2011-	Steering Tie Rod End - Front
SSP0397	301191603970	CHRYSLER 200 2nd Gen 2015-	Steering Tie Rod End - Front Right
SSP0397	301191603970	DODGE DART (PF) 2013-	Steering Tie Rod End - Front Right
SSP0398	301191603980	CHRYSLER 200 2nd Gen 2015-	Steering Tie Rod End - Front Left
SSP0398	301191603980	DODGE DART (PF) 2013-	Steering Tie Rod End - Front Left
SSP0399	301191603990	FIAT PANDA 312 02/2012-	Steering Tie Rod End - Front
SSP0399	301191603990	LANCIA YPSILON 312, 846 05/2011-	Steering Tie Rod End - Front





 SHORT LONG			DESCRIPTION
SSP0400	301191604000	FIAT 500L 09/2012-	Steering Tie Rod End - Front Right
SSP0401	301191604010	FIAT 500L 09/2012-	Steering Tie Rod End - Front Left
SSP0402	301191604020	FIAT 500X 01/2015-	Steering Tie Rod End - Front Right
SSP0402	301191604020	JEEP RENEGADE 07/2014-	Steering Tie Rod End - Front Right
SSP0403	301191604030	FIAT 500X 01/2015-	Steering Tie Rod End - Front Left
SSP0403	301191604030	JEEP RENEGADE 07/2014-	Steering Tie Rod End - Front Left
SSP0404	301191604040	FIAT EGEA 356, TIPO 10/2015-	Steering Tie Rod End - Front
SSP0404	301191604040	FIAT TIPO 356 10/2015-	Steering Tie Rod End - Front
SSP0405	301191604050	FORD FUSION 1st Gen USA made 2006-2012	Steering Tie Rod End - Front Right
SSP0405	301191604050	LINCOLN MKZ 1st Gen 2006-2012	Steering Tie Rod End - Front Right
SSP0405	301191604050	MERCURY MILAN 2006-2011	Steering Tie Rod End - Front Right
SSP0406	301191604060	FORD FUSION 1st Gen USA made 2006-2012	Steering Tie Rod End - Front Left
SSP0406	301191604060	LINCOLN MKZ 1st Gen 2006-2012	Steering Tie Rod End - Front Left
SSP0406	301191604060	MERCURY MILAN 2006-2011	Steering Tie Rod End - Front Left
SSP0407	301191604070	FORD EDGE U387 2006-2014	Steering Tie Rod End - Front Right
SSP0407	301191604070	LINCOLN MKX 1st Gen 2007-2014	Steering Tie Rod End - Front Right
SSP0408	301191604080	FORD EDGE U387 2006-2014	Steering Tie Rod End - Front Left
SSP0408	301191604080	LINCOLN MKX 1st Gen 2007-2014	Steering Tie Rod End - Front Left
SSP0409	301191604090	FORD FIESTA USA type 2011-	Steering Tie Rod End - Front Right
SSP0409	301191604090	FORD FIESTA VI 10/2008-2016	Steering Tie Rod End - Front Right
SSP0410	301191604100	FORD FIESTA USA type 2011-	Steering Tie Rod End - Front Left
SSP0410	301191604100	FORD FIESTA VI 10/2008-2016	Steering Tie Rod End - Front Left
SSP0411	301191604110	FORD FIESTA V 01/2002-09/2008	Steering Tie Rod End - Front Right
SSP0411	301191604110	FORD FUSION 2003-2009	Steering Tie Rod End - Front Right
SSP0411	301191604110	MAZDA 2 DY 04/2003-06/2007	Steering Tie Rod End - Front Right
SSP0412	301191604120	FORD FIESTA V 01/2002-09/2008	Steering Tie Rod End - Front Left
SSP0412	301191604120	FORD FUSION 2003-2009	Steering Tie Rod End - Front Left
SSP0412	301191604120	MAZDA 2 DY 04/2003-06/2007	Steering Tie Rod End - Front Left
SSP0413	301191604130	FORD KA RB 1996-2008	Steering Tie Rod End - Front
SSP0414	301191604140	FORD EXPLORER U502 2010-2015	Steering Tie Rod End - Front
SSP0415	301191604150	FORD MONDEO V 09/2014-	Steering Tie Rod End - Front Right
SSP0416	301191604160	FORD MONDEO V 09/2014-	Steering Tie Rod End - Front Left
SSP0417	301191604170	FORD FOCUS II USA made 2005-2010	Steering Tie Rod End - Front Right
SSP0418	301191604180	FORD FOCUS II USA made 2005-2010	Steering Tie Rod End - Front Left
SSP0419	301191604190	FORD FOCUS I 10/1998-11/2004	Steering Tie Rod End - Front Right
SSP0420	301191604200	FORD FOCUS I 10/1998-11/2004	Steering Tie Rod End - Front Left
SSP0421	301191604210	FORD C-MAX I 02/2007-11/2010	Steering Tie Rod End - Front Right
SSP0421	301191604210	FORD FOCUS II 11/2004-03/2011	Steering Tie Rod End - Front Right
SSP0421	301191604210	VOLVO C30 10/2006-12/2012	Steering Tie Rod End - Front Right
SSP0421	301191604210	VOLVO S40 II (MS) 01/2004-11/2012	Steering Tie Rod End - Front Right
SSP0421	301191604210	VOLVO V50 04/2004-11/2012	Steering Tie Rod End - Front Right



 SHORT LONG			DESCRIPTION
SSP0422	301191604220	FORD C-MAX I 02/2007-11/2010	Steering Tie Rod End - Front Left
SSP0422	301191604220	FORD FOCUS II 11/2004-03/2011	Steering Tie Rod End - Front Left
SSP0422	301191604220	VOLVO C30 10/2006-12/2012	Steering Tie Rod End - Front Left
SSP0422	301191604220	VOLVO S40 II (MS) 01/2004-11/2012	Steering Tie Rod End - Front Left
SSP0422	301191604220	VOLVO V50 04/2004-11/2012	Steering Tie Rod End - Front Left
SSP0423	301191604230	FORD C-MAX II 12/2010-	Steering Tie Rod End - Front Right
SSP0423	301191604230	FORD ESCAPE 3rd Gen 2013-	Steering Tie Rod End - Front Right
SSP0423	301191604230	FORD FOCUS III 04/2011-	Steering Tie Rod End - Front Right
SSP0423	301191604230	FORD FOCUS III USA made 2012-	Steering Tie Rod End - Front Right
SSP0423	301191604230	FORD KUGA II 03/2013-	Steering Tie Rod End - Front Right
SSP0423	301191604230	LINCOLN MKC 2015-2016	Steering Tie Rod End - Front Right
SSP0424	301191604240	FORD C-MAX II 12/2010-	Steering Tie Rod End - Front Left
SSP0424	301191604240	FORD ESCAPE 3rd Gen 2013-	Steering Tie Rod End - Front Left
SSP0424	301191604240	FORD FOCUS III 04/2011-	Steering Tie Rod End - Front Left
SSP0424	301191604240	FORD FOCUS III USA made 2012-	Steering Tie Rod End - Front Left
SSP0424	301191604240	FORD KUGA II 03/2013-	Steering Tie Rod End - Front Left
SSP0424	301191604240	FORD MUSTANG 5th Gen 2010-2015	Steering Tie Rod End - Front Left
SSP0425	301191604250	FORD EXPEDITION 1st Gen 1997-2002	Steering Tie Rod End - Front
SSP0425	301191604250	FORD F-150 10th Gen 1997-2003	Steering Tie Rod End - Front
SSP0425	301191604250	LINCOLN BLACKWOOD 2002-2003	Steering Tie Rod End - Front
SSP0425	301191604250	LINCOLN NAVIGATOR UN173, U228 05/1997-12/2006	Steering Tie Rod End - Front
SSP0426	301191604260	FORD EXPEDITION 3rd Gen U324 2007-2015	Steering Tie Rod End - Front Right
SSP0426	301191604260	FORD F-150 12th Gen 2009-2015	Steering Tie Rod End - Front Right
SSP0426	301191604260	LINCOLN NAVIGATOR 3rd Gen, U326 2007-2017	Steering Tie Rod End - Front Right
SSP0427	301191604270	FORD EXPEDITION 3rd Gen U324 2007-2015	Steering Tie Rod End - Front Left
SSP0427	301191604270	FORD F-150 12th Gen 2009-2015	Steering Tie Rod End - Front Left
SSP0427	301191604270	LINCOLN NAVIGATOR 3rd Gen, U326 2007-2017	Steering Tie Rod End - Front Left
SSP0428	301191604280	FORD KUGA I 02/2008-02/2013	Steering Tie Rod End - Front Right
SSP0429	301191604290	FORD KUGA I 02/2008-02/2013	Steering Tie Rod End - Front Left
SSP0430	301191604300	FORD FUSION 2nd Gen 2013-	Steering Tie Rod End - Front Right
SSP0431	301191604310	FORD FUSION 2nd Gen 2013-	Steering Tie Rod End - Front Left
SSP0432	301191604320	FORD MUSTANG 6th Gen 2013-2016	Steering Tie Rod End - Front
SSP0433	301191604330	FORD TRANSIT CONNECT 04/2002-09/2013	Steering Tie Rod End - Front
SSP0434	301191604340	FORD TRANSIT V184 2000-06/2006	Steering Tie Rod End - Front
SSP0434	301191604340	FORD TRANSIT V347-348 07/2006-04/2014	Steering Tie Rod End - Front
SSP0435	301191604350	FORD TRANSIT CONNECT 04/2002-09/2013	Steering Tie Rod End - Front
SSP0436	301191604360	FORD TRANSIT CUSTOM 12/2012-	Steering Tie Rod End - Front
SSP0436	301191604360	FORD TRANSIT V363 04/2014-	Steering Tie Rod End - Front
SSP0437	301191604370	FORD MONDEO III 11/2000-03/2007	Steering Tie Rod End - Front





 SHORT LONG			DESCRIPTION
SSP0437	301191604370	JAGUAR X-TYPE 06/2001-11/2009	Steering Tie Rod End - Front
SSP0438	301191604380	FORD GALAXY 05/2006-	Steering Tie Rod End - Front Right
SSP0438	301191604380	FORD MONDEO IV 04/2007-08/2014	Steering Tie Rod End - Front Right
SSP0438	301191604380	FORD S-MAX WA6 05/2006-	Steering Tie Rod End - Front Right
SSP0438	301191604380	LAND ROVER FREELANDER II 10/2006-08/2014	Steering Tie Rod End - Front Right
SSP0438	301191604380	LAND ROVER LR2 L359 2006-2015	Steering Tie Rod End - Front Right
SSP0438	301191604380	VOLVO XC60 05/2008-2016	Steering Tie Rod End - Front Right
SSP0439	301191604390	FORD GALAXY 05/2006-	Steering Tie Rod End - Front Left
SSP0439	301191604390	FORD MONDEO IV 04/2007-08/2014	Steering Tie Rod End - Front Left
SSP0439	301191604390	FORD S-MAX WA6 05/2006-	Steering Tie Rod End - Front Left
SSP0439	301191604390	LAND ROVER FREELANDER II 10/2006-08/2014	Steering Tie Rod End - Front Left
SSP0439	301191604390	LAND ROVER LR2 L359 2006-2015	Steering Tie Rod End - Front Left
SSP0439	301191604390	VOLVO XC60 05/2008-2016	Steering Tie Rod End - Front Left
SSP0440	301191604400	HYUNDAI ix35 01/2010-2015	Steering Tie Rod End - Front Right
SSP0440	301191604400	KIA SPORTAGE SL 07/2010-08/2015	Steering Tie Rod End - Front Right
SSP0441	301191604410	HYUNDAI ix35 01/2010-2015	Steering Tie Rod End - Front Left
SSP0441	301191604410	KIA SPORTAGE SL 07/2010-08/2015	Steering Tie Rod End - Front Left
SSP0442	301191604420	HYUNDAI ATOS PRIMA/AMICA 02/1998-11/2008	Steering Tie Rod End - Front
SSP0442	301191604420	HYUNDAI ELANTRA 1st Gen, J1 10/1990-11/1995	Steering Tie Rod End - Front
SSP0442	301191604420	MINI R50 05/1991-12/2004	Steering Tie Rod End - Front
SSP0443	301191604430	HYUNDAI ACCENT II 02/2000-11/2005	Steering Tie Rod End - Front
SSP0443	301191604430	HYUNDAI COUPE 05/2002-08/2009	Steering Tie Rod End - Front
SSP0443	301191604430	HYUNDAI ELANTRA 3th Gen, XD 06/2000-07/2006	Steering Tie Rod End - Front
SSP0443	301191604430	HYUNDAI MATRIX 06/2001-08/2010	Steering Tie Rod End - Front
SSP0443	301191604430	HYUNDAI TIBURON 1997-2008	Steering Tie Rod End - Front
SSP0443	301191604430	KIA CERATO (LD) 03/2004-07/2011	Steering Tie Rod End - Front
SSP0443	301191604430	KIA SPECTRA 1st Gen, LD 2004-2009	Steering Tie Rod End - Front
SSP0444	301191604440	HYUNDAI H 1 I 02/2008-	Steering Tie Rod End - Front Right
SSP0444	301191604440	HYUNDAI I800 800 10/2007-	Steering Tie Rod End - Front Right
SSP0445	301191604450	HYUNDAI H 1 I 02/2008-	Steering Tie Rod End - Front Left
SSP0445	301191604450	HYUNDAI I800 800 10/2007-	Steering Tie Rod End - Front Left
SSP0446	301191604460	HYUNDAI ACCENT IV, RB 2011-	Steering Tie Rod End - Front Right
SSP0446	301191604460	KIA RIO UB 09/2011-	Steering Tie Rod End - Front Right
SSP0447	301191604470	HYUNDAI ACCENT IV, RB 2011-	Steering Tie Rod End - Front Left
SSP0447	301191604470	KIA RIO UB 09/2011-	Steering Tie Rod End - Front Left
SSP0448	301191604480	HYUNDAI TUCSON JM 08/2004-03/2010	Steering Tie Rod End - Front Right
SSP0448	301191604480	KIA SPORTAGE JE 09/2004-06/2010	Steering Tie Rod End - Front Right
SSP0449	301191604490	HYUNDAI TUCSON JM 08/2004-03/2010	Steering Tie Rod End - Front Left



			DESCRIPTION
SHORT	LONG		
SSP0449	301191604490	KIA SPORTAGE JE 09/2004-06/2010	Steering Tie Rod End - Front Left
SSP0450	301191604500	HYUNDAI I20 (PB,PBT) 09/2008-08/2014	Steering Tie Rod End - Front Right
SSP0450	301191604500	HYUNDAI ix20 (JC) 11/2010-	Steering Tie Rod End - Front Right
SSP0450	301191604500	KIA SOUL AM 02/2009-2014	Steering Tie Rod End - Front Right
SSP0450	301191604500	KIA VENGA AM 02/2010-	Steering Tie Rod End - Front Right
SSP0451	301191604510	HYUNDAI I20 (PB,PBT) 09/2008-08/2014	Steering Tie Rod End - Front Left
SSP0451	301191604510	HYUNDAI ix20 (JC) 11/2010-	Steering Tie Rod End - Front Left
SSP0451	301191604510	KIA SOUL AM 02/2009-2014	Steering Tie Rod End - Front Left
SSP0451	301191604510	KIA VENGA AM 02/2010-	Steering Tie Rod End - Front Left
SSP0452	301191604520	HYUNDAI ELANTRA Touring, Wagon 10/2007-11/2011	Steering Tie Rod End - Front Right
SSP0452	301191604520	HYUNDAI I30 FD 10/2007-11/2011	Steering Tie Rod End - Front Right
SSP0452	301191604520	KIA CEED I 12/2006-04/2012	Steering Tie Rod End - Front Right
SSP0452	301191604520	KIA Forte 1st Gen 2010-2013	Steering Tie Rod End - Front Right
SSP0452	301191604520	KIA Forte Koup 1st Gen 2010-2013	Steering Tie Rod End - Front Right
SSP0452	301191604520	KIA Forte5 1st Gen 2010-2013	Steering Tie Rod End - Front Right
SSP0453	301191604530	HYUNDAI ELANTRA Touring, Wagon 10/2007-11/2011	Steering Tie Rod End - Front Left
SSP0453	301191604530	HYUNDAI I30 FD 10/2007-11/2011	Steering Tie Rod End - Front Left
SSP0453	301191604530	KIA CEED I 12/2006-04/2012	Steering Tie Rod End - Front Left
SSP0453	301191604530	KIA Forte 1st Gen 2010-2013	Steering Tie Rod End - Front Left
SSP0453	301191604530	KIA Forte Koup 1st Gen 2010-2013	Steering Tie Rod End - Front Left
SSP0453	301191604530	KIA Forte5 1st Gen 2010-2013	Steering Tie Rod End - Front Left
SSP0454	301191604540	HYUNDAI ELANTRA 5th Gen, MD/UD 2012-2015	Steering Tie Rod End - Front Right
SSP0454	301191604540	HYUNDAI Elantra GT 12/2011-	Steering Tie Rod End - Front Right
SSP0454	301191604540	HYUNDAI I30 GD 12/2011-	Steering Tie Rod End - Front Right
SSP0454	301191604540	HYUNDAI I30 PD 2017-	Steering Tie Rod End - Front Right
SSP0455	301191604550	HYUNDAI ELANTRA 5th Gen, MD/UD 2012-2015	Steering Tie Rod End - Front Left
SSP0455	301191604550	HYUNDAI Elantra GT 12/2011-	Steering Tie Rod End - Front Left
SSP0455	301191604550	HYUNDAI I30 GD 12/2011-	Steering Tie Rod End - Front Left
SSP0455	301191604550	HYUNDAI I30 PD 2017-	Steering Tie Rod End - Front Left
SSP0456	301191604560	HYUNDAI I10 (PA) 02/2008-11/2013	Steering Tie Rod End - Front
SSP0457	301191604570	HYUNDAI i40 (VF) 2011-	Steering Tie Rod End - Front Right Outer
SSP0457	301191604570	KIA OPTIMA 3rd Gen 01/2010-	Steering Tie Rod End - Front Right Outer
SSP0458	301191604580	HYUNDAI i40 (VF) 2011-	Steering Tie Rod End - Front Left Outer
SSP0458	301191604580	KIA OPTIMA 3rd Gen 01/2010-	Steering Tie Rod End - Front Left Outer
SSP0459	301191604590	HYUNDAI I20 II 11/2014-	Steering Tie Rod End - Front Right
SSP0460	301191604600	HYUNDAI I20 II 11/2014-	Steering Tie Rod End - Front Left
SSP0461	301191604610	HYUNDAI GETZ (TB) 08/2002-06/2011	Steering Tie Rod End - Front
SSP0461	301191604610	HYUNDAI Santa Fe I SM 02/2001-02/2006	Steering Tie Rod End - Front





 SHORT LONG			DESCRIPTION
SSP0461	301191604610	HYUNDAI SONATA I 09/1988-05/1993	Steering Tie Rod End - Front
SSP0462	301191604620	HYUNDAI ix55 09/2008-	Steering Tie Rod End - Front Right
SSP0462	301191604620	HYUNDAI Santa Fe II CM 03/2006-08/2012	Steering Tie Rod End - Front Right
SSP0462	301191604620	HYUNDAI VERACRUZ 2008-2015	Steering Tie Rod End - Front Right
SSP0462	301191604620	KIA SORENTO XM 2009-2014	Steering Tie Rod End - Front Right
SSP0463	301191604630	HYUNDAI ix55 09/2008-	Steering Tie Rod End - Front Left
SSP0463	301191604630	HYUNDAI Santa Fe II CM 03/2006-08/2012	Steering Tie Rod End - Front Left
SSP0463	301191604630	HYUNDAI VERACRUZ 2008-2015	Steering Tie Rod End - Front Left
SSP0463	301191604630	KIA SORENTO XM 2009-2014	Steering Tie Rod End - Front Left
SSP0464	301191604640	HYUNDAI Santa Fe III DM 09/2012-	Steering Tie Rod End - Front Right
SSP0465	301191604650	HYUNDAI Santa Fe III DM 09/2012-	Steering Tie Rod End - Front Left
SSP0466	301191604660	JEEP GRAND CHEROKEE II WJ, WG 06/1999-05/2005	Steering Tie Rod End - Front Right
SSP0467	301191604670	JEEP GRAND CHEROKEE II WJ, WG 06/1999-05/2005	Steering Tie Rod End - Front Left
SSP0468	301191604680	KIA SORENTO JC, BL 08/2002-10/2009	Steering Tie Rod End - Front Right
SSP0469	301191604690	KIA SORENTO JC, BL 08/2002-10/2009	Steering Tie Rod End - Front Left
SSP0470	301191604700	KIA SORENTO UM, III 2015-2017	Steering Tie Rod End - Front Right
SSP0471	301191604710	KIA SORENTO UM, III 2015-2017	Steering Tie Rod End - Front Left
SSP0472	301191604720	KIA RIO DC 09/2000-02/2005	Steering Tie Rod End - Front
SSP0473	301191604730	KIA RIO JB 03/2005-08/2011	Steering Tie Rod End - Front Right
SSP0473	301191604730	KIA RIO5 JB 03/2005-08/2011	Steering Tie Rod End - Front Right
SSP0474	301191604740	KIA RIO JB 03/2005-08/2011	Steering Tie Rod End - Front Left
SSP0474	301191604740	KIA RIO5 JB 03/2005-08/2011	Steering Tie Rod End - Front Left
SSP0475	301191604750	KIA PICANTO BA 05/2004-04/2011	Steering Tie Rod End - Front
SSP0476	301191604760	KIA PICANTO TA 05/2011-	Steering Tie Rod End - Front Right
SSP0477	301191604770	KIA PICANTO TA 05/2011-	Steering Tie Rod End - Front Left
SSP0478	301191604780	KIA PICANTO TA 05/2011-	Steering Tie Rod End - Front Right
SSP0479	301191604790	KIA PICANTO TA 05/2011-	Steering Tie Rod End - Front Left
SSP0480	301191604800	MERCEDES C220 (W202) 1993-2000	Steering Tie Rod End - Front
SSP0480	301191604800	MERCEDES C230 (W202) 1993-2000	Steering Tie Rod End - Front
SSP0480	301191604800	MERCEDES C280 (W202) 1993-2000	Steering Tie Rod End - Front
SSP0480	301191604800	MERCEDES C36 AMG (W202) 1993-2000	Steering Tie Rod End - Front
SSP0480	301191604800	MERCEDES C43 AMG (W202) 1993-2000	Steering Tie Rod End - Front
SSP0480	301191604800	MERCEDES SLK200 (R170) 1997-2004	Steering Tie Rod End - Front
SSP0481	301191604810	MERCEDES E280 (W210) 1995-2003	Steering Tie Rod End - Front Right Outer
SSP0481	301191604810	MERCEDES E300 (W210) 1995-2003	Steering Tie Rod End - Front Right Outer
SSP0481	301191604810	MERCEDES E320 (W210) 1995-2003	Steering Tie Rod End - Front Right Outer
SSP0481	301191604810	MERCEDES E420 (W210) 1995-2003	Steering Tie Rod End - Front Right Outer
SSP0481	301191604810	MERCEDES E430 (W210) 1995-2003	Steering Tie Rod End - Front Right Outer
SSP0481	301191604810	MERCEDES E500 (W210) 1995-2003	Steering Tie Rod End - Front Right Outer





			DESCRIPTION
SHORT	LONG		
SSP0481	301191604810	MERCEDES E55 AMG (W210) 1995-2003	Steering Tie Rod End - Front Right Outer
SSP0482	301191604820	MERCEDES E280 (W210) 1995-2003	Steering Tie Rod End - Front Left Outer
SSP0482	301191604820	MERCEDES E300 (W210) 1995-2003	Steering Tie Rod End - Front Left Outer
SSP0482	301191604820	MERCEDES E320 (W210) 1995-2003	Steering Tie Rod End - Front Left Outer
SSP0482	301191604820	MERCEDES E420 (W210) 1995-2003	Steering Tie Rod End - Front Left Outer
SSP0482	301191604820	MERCEDES E430 (W210) 1995-2003	Steering Tie Rod End - Front Left Outer
SSP0482	301191604820	MERCEDES E500 (W210) 1995-2003	Steering Tie Rod End - Front Left Outer
SSP0482	301191604820	MERCEDES E55 AMG (W210) 1995-2003	Steering Tie Rod End - Front Left Outer
SSP0483	301191604830	MERCEDES C180 (W204) 10/2007-11/2013	Steering Tie Rod End - Front Right
SSP0484	301191604840	MERCEDES C180 (W204) 10/2007-11/2013	Steering Tie Rod End - Front Left
SSP0485	301191604850	MERCEDES C180 (W204) 10/2007-11/2013	Steering Tie Rod End - Front Right Outer
SSP0485	301191604850	MERCEDES C200 (W204) 10/2007-11/2013	Steering Tie Rod End - Front Right Outer
SSP0485	301191604850	MERCEDES C230 (W204) 10/2007-11/2013	Steering Tie Rod End - Front Right Outer
SSP0485	301191604850	MERCEDES C250 (W204) 10/2007-11/2013	Steering Tie Rod End - Front Right Outer
SSP0485	301191604850	MERCEDES C280 (W204) 10/2007-11/2013	Steering Tie Rod End - Front Right Outer
SSP0485	301191604850	MERCEDES C300 (W204) 10/2007-11/2013	Steering Tie Rod End - Front Right Outer
SSP0485	301191604850	MERCEDES C350 (W204) 10/2007-11/2013	Steering Tie Rod End - Front Right Outer
SSP0485	301191604850	MERCEDES C63 AMG (W204) 10/2007-11/2013	Steering Tie Rod End - Front Right Outer
SSP0486	301191604860	MERCEDES C180 (W204) 10/2007-11/2013	Steering Tie Rod End - Front Left Outer
SSP0486	301191604860	MERCEDES C200 (W204) 10/2007-11/2013	Steering Tie Rod End - Front Left Outer
SSP0486	301191604860	MERCEDES C230 (W204) 10/2007-11/2013	Steering Tie Rod End - Front Left Outer
SSP0486	301191604860	MERCEDES C250 (W204) 10/2007-11/2013	Steering Tie Rod End - Front Left Outer
SSP0486	301191604860	MERCEDES C280 (W204) 10/2007-11/2013	Steering Tie Rod End - Front Left Outer
SSP0486	301191604860	MERCEDES C300 (W204) 10/2007-11/2013	Steering Tie Rod End - Front Left Outer
SSP0486	301191604860	MERCEDES C350 (W204) 10/2007-11/2013	Steering Tie Rod End - Front Left Outer
SSP0486	301191604860	MERCEDES C63 AMG (W204) 10/2007-11/2013	Steering Tie Rod End - Front Left Outer
SSP0487	301191604870	MERCEDES E280 (W210) 1995-2003	Steering Tie Rod End - Front Right
SSP0487	301191604870	MERCEDES E300 (W210) 1995-2003	Steering Tie Rod End - Front Right
SSP0487	301191604870	MERCEDES E320 (W210) 1995-2003	Steering Tie Rod End - Front Right
SSP0487	301191604870	MERCEDES E420 (W210) 1995-2003	Steering Tie Rod End - Front Right
SSP0487	301191604870	MERCEDES E430 (W210) 1995-2003	Steering Tie Rod End - Front Right
SSP0487	301191604870	MERCEDES E500 (W210) 1995-2003	Steering Tie Rod End - Front Right
SSP0487	301191604870	MERCEDES E55 AMG (W210) 1995-2003	Steering Tie Rod End - Front Right
SSP0488	301191604880	MERCEDES E280 (W210) 1995-2003	Steering Tie Rod End - Front Left
SSP0488	301191604880	MERCEDES E300 (W210) 1995-2003	Steering Tie Rod End - Front Left
SSP0488	301191604880	MERCEDES E320 (W210) 1995-2003	Steering Tie Rod End - Front Left
SSP0488	301191604880	MERCEDES E420 (W210) 1995-2003	Steering Tie Rod End - Front Left
SSP0488	301191604880	MERCEDES E430 (W210) 1995-2003	Steering Tie Rod End - Front Left
SSP0488	301191604880	MERCEDES E500 (W210) 1995-2003	Steering Tie Rod End - Front Left





 SHORT LONG			DESCRIPTION
SSP0488	301191604880	MERCEDES E55 AMG (W210) 1995-2003	Steering Tie Rod End - Front Left
SSP0489	301191604890	MERCEDES E200 (W212) 01/2009-2016	Steering Tie Rod End - Front Right Outer
SSP0489	301191604890	MERCEDES E250 (W212) 01/2009-2016	Steering Tie Rod End - Front Right Outer
SSP0489	301191604890	MERCEDES E280 (W212) 01/2009-2016	Steering Tie Rod End - Front Right Outer
SSP0489	301191604890	MERCEDES E300 (W212) 01/2009-2016	Steering Tie Rod End - Front Right Outer
SSP0489	301191604890	MERCEDES E320 (W212) 01/2009-2016	Steering Tie Rod End - Front Right Outer
SSP0489	301191604890	MERCEDES E400 (W212) 01/2009-2016	Steering Tie Rod End - Front Right Outer
SSP0489	301191604890	MERCEDES E500 (W212) 01/2009-2016	Steering Tie Rod End - Front Right Outer
SSP0489	301191604890	MERCEDES E550 (W212) 01/2009-2016	Steering Tie Rod End - Front Right Outer
SSP0489	301191604890	MERCEDES E63 AMG (W212) 01/2009-2016	Steering Tie Rod End - Front Right Outer
SSP0490	301191604900	MERCEDES E200 (W212) 01/2009-2016	Steering Tie Rod End - Front Left Outer
SSP0490	301191604900	MERCEDES E250 (W212) 01/2009-2016	Steering Tie Rod End - Front Left Outer
SSP0490	301191604900	MERCEDES E280 (W212) 01/2009-2016	Steering Tie Rod End - Front Left Outer
SSP0490	301191604900	MERCEDES E300 (W212) 01/2009-2016	Steering Tie Rod End - Front Left Outer
SSP0490	301191604900	MERCEDES E320 (W212) 01/2009-2016	Steering Tie Rod End - Front Left Outer
SSP0490	301191604900	MERCEDES E400 (W212) 01/2009-2016	Steering Tie Rod End - Front Left Outer
SSP0490	301191604900	MERCEDES E500 (W212) 01/2009-2016	Steering Tie Rod End - Front Left Outer
SSP0490	301191604900	MERCEDES E550 (W212) 01/2009-2016	Steering Tie Rod End - Front Left Outer
SSP0490	301191604900	MERCEDES E63 AMG (W212) 01/2009-2016	Steering Tie Rod End - Front Left Outer
SSP0491	301191604910	MERCEDES E250 (W212) 01/2009-2016	Steering Tie Rod End - Front Right
SSP0491	301191604910	MERCEDES E300 (W212) 01/2009-2016	Steering Tie Rod End - Front Right
SSP0491	301191604910	MERCEDES E320 (W212) 01/2009-2016	Steering Tie Rod End - Front Right
SSP0491	301191604910	MERCEDES E400 (W212) 01/2009-2016	Steering Tie Rod End - Front Right
SSP0491	301191604910	MERCEDES E550 (W212) 01/2009-2016	Steering Tie Rod End - Front Right
SSP0491	301191604910	MERCEDES E63 AMG (W212) 01/2009-2016	Steering Tie Rod End - Front Right
SSP0491	301191604910	MERCEDES E63 AMG S (W212) 01/2009-2016	Steering Tie Rod End - Front Right
SSP0492	301191604920	MERCEDES E250 (W212) 01/2009-2016	Steering Tie Rod End - Front Left
SSP0492	301191604920	MERCEDES E300 (W212) 01/2009-2016	Steering Tie Rod End - Front Left
SSP0492	301191604920	MERCEDES E320 (W212) 01/2009-2016	Steering Tie Rod End - Front Left
SSP0492	301191604920	MERCEDES E400 (W212) 01/2009-2016	Steering Tie Rod End - Front Left
SSP0492	301191604920	MERCEDES E550 (W212) 01/2009-2016	Steering Tie Rod End - Front Left
SSP0492	301191604920	MERCEDES E63 AMG (W212) 01/2009-2016	Steering Tie Rod End - Front Left
SSP0492	301191604920	MERCEDES E63 AMG S (W212) 01/2009-2016	Steering Tie Rod End - Front Left
SSP0493	301191604930	MERCEDES GLK250 (X204) 06/2008-2016	Steering Tie Rod End - Front Right
SSP0493	301191604930	MERCEDES GLK280 (X204) 06/2008-2016	Steering Tie Rod End - Front Right
SSP0493	301191604930	MERCEDES GLK300 (X204) 06/2008-2016	Steering Tie Rod End - Front Right
SSP0493	301191604930	MERCEDES GLK350 (X204) 06/2008-2016	Steering Tie Rod End - Front Right
SSP0494	301191604940	MERCEDES GLK250 (X204) 06/2008-2016	Steering Tie Rod End - Front Left
SSP0494	301191604940	MERCEDES GLK280 (X204) 06/2008-2016	Steering Tie Rod End - Front Left



 SHORT LONG			DESCRIPTION
SSP0494	301191604940	MERCEDES GLK300 (X204) 06/2008-2016	Steering Tie Rod End - Front Left
SSP0494	301191604940	MERCEDES GLK350 (X204) 06/2008-2016	Steering Tie Rod End - Front Left
SSP0495	301191604950	MERCEDES A160 (W168) 1997-2004	Steering Tie Rod End - Front Right
SSP0495	301191604950	MERCEDES A190 (W168) 1997-2004	Steering Tie Rod End - Front Right
SSP0496	301191604960	MERCEDES A160 (W168) 1997-2004	Steering Tie Rod End - Front Left
SSP0496	301191604960	MERCEDES A190 (W168) 1997-2004	Steering Tie Rod End - Front Left
SSP0497	301191604970	MERCEDES A160 (W169) 09/2004-06/2012	Steering Tie Rod End - Front Right
SSP0497	301191604970	MERCEDES A190 (W169) 09/2004-06/2012	Steering Tie Rod End - Front Right
SSP0497	301191604970	MERCEDES B180 (W245) 03/2005-11/2011	Steering Tie Rod End - Front Right
SSP0497	301191604970	MERCEDES B200 (W245) 03/2005-11/2011	Steering Tie Rod End - Front Right
SSP0498	301191604980	MERCEDES A160 (W169) 09/2004-06/2012	Steering Tie Rod End - Front Left
SSP0498	301191604980	MERCEDES A190 (W169) 09/2004-06/2012	Steering Tie Rod End - Front Left
SSP0498	301191604980	MERCEDES B180 (W245) 03/2005-11/2011	Steering Tie Rod End - Front Left
SSP0498	301191604980	MERCEDES B200 (W245) 03/2005-11/2011	Steering Tie Rod End - Front Left
SSP0499	301191604990	MERCEDES S400 (W222,V222,X222) 2014-	Steering Tie Rod End - Front Right
SSP0499	301191604990	MERCEDES S450 (W222,V222,X222) 2014-	Steering Tie Rod End - Front Right
SSP0499	301191604990	MERCEDES S500 (W222,V222,X222) 2014-	Steering Tie Rod End - Front Right
SSP0499	301191604990	MERCEDES S63 AMG (W222,V222,X222) 2014-	Steering Tie Rod End - Front Right
SSP0500	301191605000	MERCEDES S400 (W222,V222,X222) 2014-	Steering Tie Rod End - Front Left
SSP0500	301191605000	MERCEDES S450 (W222,V222,X222) 2014-	Steering Tie Rod End - Front Left
SSP0500	301191605000	MERCEDES S500 (W222,V222,X222) 2014-	Steering Tie Rod End - Front Left
SSP0500	301191605000	MERCEDES S63 AMG (W222,V222,X222) 2014-	Steering Tie Rod End - Front Left
SSP0501	301191605010	MERCEDES A180 (W176) 06/2012-	Steering Tie Rod End - Front Right
SSP0501	301191605010	MERCEDES A200 (W176) 06/2012-	Steering Tie Rod End - Front Right
SSP0501	301191605010	MERCEDES A250 (W176) 06/2012-	Steering Tie Rod End - Front Right
SSP0501	301191605010	MERCEDES B180 (W246) 11/2011-2016	Steering Tie Rod End - Front Right
SSP0501	301191605010	MERCEDES B250 (W246) 11/2011-2016	Steering Tie Rod End - Front Right
SSP0501	301191605010	MERCEDES CLA180 (W176) 06/2012-	Steering Tie Rod End - Front Right
SSP0501	301191605010	MERCEDES CLA200 (W176) 06/2012-	Steering Tie Rod End - Front Right
SSP0501	301191605010	MERCEDES CLA250 (W176) 06/2012-	Steering Tie Rod End - Front Right
SSP0501	301191605010	MERCEDES GLA180 (X156) 12/2013-	Steering Tie Rod End - Front Right
SSP0501	301191605010	MERCEDES GLA200 (X156) 12/2013-	Steering Tie Rod End - Front Right
SSP0501	301191605010	MERCEDES GLA250 (X156) 12/2013-	Steering Tie Rod End - Front Right
SSP0501	301191605010	MERCEDES GLA45 AMG (X156) 12/2013-	Steering Tie Rod End - Front Right
SSP0502	301191605020	MERCEDES A180 (W176) 06/2012-	Steering Tie Rod End - Front Left
SSP0502	301191605020	MERCEDES A200 (W176) 06/2012-	Steering Tie Rod End - Front Left
SSP0502	301191605020	MERCEDES A250 (W176) 06/2012-	Steering Tie Rod End - Front Left
SSP0502	301191605020	MERCEDES B180 (W246) 11/2011-2016	Steering Tie Rod End - Front Left
SSP0502	301191605020	MERCEDES B250 (W246) 11/2011-2016	Steering Tie Rod End - Front Left





 SHORT LONG			DESCRIPTION
SSP0502	301191605020	MERCEDES CLA180 (W176) 06/2012-	Steering Tie Rod End - Front Left
SSP0502	301191605020	MERCEDES CLA200 (W176) 06/2012-	Steering Tie Rod End - Front Left
SSP0502	301191605020	MERCEDES CLA250 (W176) 06/2012-	Steering Tie Rod End - Front Left
SSP0502	301191605020	MERCEDES GLA180 (X156) 12/2013-	Steering Tie Rod End - Front Left
SSP0502	301191605020	MERCEDES GLA200 (X156) 12/2013-	Steering Tie Rod End - Front Left
SSP0502	301191605020	MERCEDES GLA250 (X156) 12/2013-	Steering Tie Rod End - Front Left
SSP0502	301191605020	MERCEDES GLA45 AMG (X156) 12/2013-	Steering Tie Rod End - Front Left
SSP0503	301191605030	MERCEDES C240 (W203) 05/2000-02/2007	Steering Tie Rod End - Front Right
SSP0503	301191605030	MERCEDES C280 (W203) 05/2000-02/2007	Steering Tie Rod End - Front Right
SSP0503	301191605030	MERCEDES C320 (W203) 05/2000-02/2007	Steering Tie Rod End - Front Right
SSP0503	301191605030	MERCEDES C350 (W203) 05/2000-02/2007	Steering Tie Rod End - Front Right
SSP0504	301191605040	MERCEDES C240 (W203) 05/2000-02/2007	Steering Tie Rod End - Front Left
SSP0504	301191605040	MERCEDES C280 (W203) 05/2000-02/2007	Steering Tie Rod End - Front Left
SSP0504	301191605040	MERCEDES C320 (W203) 05/2000-02/2007	Steering Tie Rod End - Front Left
SSP0504	301191605040	MERCEDES C350 (W203) 05/2000-02/2007	Steering Tie Rod End - Front Left
SSP0505	301191605050	MERCEDES VITO (W638) 03/1997-07/2003	Steering Tie Rod End - Front
SSP0506	301191605060	MERCEDES VIANO (W447) 2014-	Steering Tie Rod End - Front Right
SSP0506	301191605060	MERCEDES VITO (W447) 2014-	Steering Tie Rod End - Front Right
SSP0507	301191605070	MERCEDES VIANO (W447) 2014-	Steering Tie Rod End - Front Left
SSP0507	301191605070	MERCEDES VITO (W447) 2014-	Steering Tie Rod End - Front Left
SSP0508	301191605080	MERCEDES GL350 (X166) 07/2011-	Steering Tie Rod End - Front
SSP0508	301191605080	MERCEDES GL450 (X166) 07/2011-	Steering Tie Rod End - Front
SSP0508	301191605080	MERCEDES GL500 (X166) 07/2011-	Steering Tie Rod End - Front
SSP0508	301191605080	MERCEDES GL550 (X166) 07/2011-	Steering Tie Rod End - Front
SSP0508	301191605080	MERCEDES GL63 AMG (X166) 07/2011-	Steering Tie Rod End - Front
SSP0508	301191605080	MERCEDES ML250 (W166) 07/2011-	Steering Tie Rod End - Front
SSP0508	301191605080	MERCEDES ML350 (W166) 07/2011-	Steering Tie Rod End - Front
SSP0508	301191605080	MERCEDES ML400 (W166) 07/2011-	Steering Tie Rod End - Front
SSP0508	301191605080	MERCEDES ML500 (W166) 07/2011-	Steering Tie Rod End - Front
SSP0508	301191605080	MERCEDES ML550 (W166) 07/2011-	Steering Tie Rod End - Front
SSP0508	301191605080	MERCEDES ML63 AMG (W166) 07/2011-	Steering Tie Rod End - Front
SSP0509	301191605090	MERCEDES Vaneo (W414) 02/2002-07/2005	Steering Tie Rod End - Front Right
SSP0510	301191605100	MERCEDES Vaneo (W414) 02/2002-07/2005	Steering Tie Rod End - Front Left
SSP0511	301191605110	MERCEDES VIANO (W639) 03/2003-07/2014	Steering Tie Rod End - Front Right
SSP0511	301191605110	MERCEDES VITO (W639) 03/2003-07/2014	Steering Tie Rod End - Front Right
SSP0512	301191605120	MERCEDES VIANO (W639) 03/2003-07/2014	Steering Tie Rod End - Front Left
SSP0512	301191605120	MERCEDES VITO (W639) 03/2003-07/2014	Steering Tie Rod End - Front Left
SSP0513	301191605130	MERCEDES E250 (W212) 01/2009-2016	Steering Tie Rod End - Front Right
SSP0514	301191605140	MERCEDES E250 (W212) 01/2009-2016	Steering Tie Rod End - Front Left
SSP0515	301191605150	DODGE SPRINTER 2500 W901,W902,W903 01/1995-05/2006	Steering Tie Rod End - Front





			DESCRIPTION
SHORT	LONG		
SSP0515	301191605150	DODGE SPRINTER 3500 W901,W902,W903 01/1995-05/2006	Steering Tie Rod End - Front
SSP0515	301191605150	MERCEDES SPRINTER (W901,W902,W903) 01/1995-05/2006	Steering Tie Rod End - Front
SSP0515	301191605150	VOLKSWAGEN LT 28-35-46, Typ 2D 04/1996-07/2006	Steering Tie Rod End - Front
SSP0516	301191605160	DODGE SPRINTER 2500 W906 06/2006-	Steering Tie Rod End - Front
SSP0516	301191605160	DODGE SPRINTER 3500 W906 06/2006-	Steering Tie Rod End - Front
SSP0516	301191605160	MERCEDES SPRINTER (W906) 06/2006-	Steering Tie Rod End - Front
SSP0516	301191605160	MERCEDES SPRINTER 2500 (W906) 06/2006-	Steering Tie Rod End - Front
SSP0516	301191605160	MERCEDES SPRINTER 3500 (W906) 06/2006-	Steering Tie Rod End - Front
SSP0516	301191605160	VOLKSWAGEN CRAFTER 04/2006-	Steering Tie Rod End - Front
SSP0517	301191605170	MERCEDES C200 (W203) 05/2000-02/2007	Steering Tie Rod End - Front Right Outer
SSP0517	301191605170	MERCEDES C230 (W203) 05/2000-02/2007	Steering Tie Rod End - Front Right Outer
SSP0517	301191605170	MERCEDES C240 (W203) 05/2000-02/2007	Steering Tie Rod End - Front Right Outer
SSP0517	301191605170	MERCEDES C280 (W203) 05/2000-02/2007	Steering Tie Rod End - Front Right Outer
SSP0517	301191605170	MERCEDES C32 AMG (W203) 05/2000-02/2007	Steering Tie Rod End - Front Right Outer
SSP0517	301191605170	MERCEDES C320 (W203) 05/2000-02/2007	Steering Tie Rod End - Front Right Outer
SSP0517	301191605170	MERCEDES C350 (W203) 05/2000-02/2007	Steering Tie Rod End - Front Right Outer
SSP0517	301191605170	MERCEDES C55 AMG (W203) 05/2000-02/2007	Steering Tie Rod End - Front Right Outer
SSP0517	301191605170	MERCEDES CLK280 (A209-C209) 06/2002-05/2009	Steering Tie Rod End - Front Right Outer
SSP0517	301191605170	MERCEDES CLK320 (A209-C209) 06/2002-05/2009	Steering Tie Rod End - Front Right Outer
SSP0517	301191605170	MERCEDES CLK350 (A209-C209) 06/2002-05/2009	Steering Tie Rod End - Front Right Outer
SSP0517	301191605170	MERCEDES CLK430 (A209-C209) 06/2002-05/2009	Steering Tie Rod End - Front Right Outer
SSP0517	301191605170	MERCEDES CLK500 (A209-C209) 06/2002-05/2009	Steering Tie Rod End - Front Right Outer
SSP0517	301191605170	MERCEDES CLK55 AMG (A209-C209) 06/2002-05/2009	Steering Tie Rod End - Front Right Outer
SSP0517	301191605170	MERCEDES CLK550 (A209-C209) 06/2002-05/2009	Steering Tie Rod End - Front Right Outer
SSP0517	301191605170	MERCEDES CLK63 AMG (A209-C209) 06/2002-05/2009	Steering Tie Rod End - Front Right Outer
SSP0517	301191605170	MERCEDES SLK200 (R171) 03/2004-02/2011	Steering Tie Rod End - Front Right Outer
SSP0517	301191605170	MERCEDES SLK280 (R171) 03/2004-02/2011	Steering Tie Rod End - Front Right Outer
SSP0517	301191605170	MERCEDES SLK300 (R171) 03/2004-02/2011	Steering Tie Rod End - Front Right Outer
SSP0517	301191605170	MERCEDES SLK350 (R171) 03/2004-02/2011	Steering Tie Rod End - Front Right Outer
SSP0517	301191605170	MERCEDES SLK55 AMG (R171) 03/2004-02/2011	Steering Tie Rod End - Front Right Outer
SSP0518	301191605180	MERCEDES C200 (W203) 05/2000-02/2007	Steering Tie Rod End - Front Left Outer





 SHORT LONG			DESCRIPTION
SSP0518	301191605180	MERCEDES C230 (W203) 05/2000-02/2007	Steering Tie Rod End - Front Left Outer
SSP0518	301191605180	MERCEDES C240 (W203) 05/2000-02/2007	Steering Tie Rod End - Front Left Outer
SSP0518	301191605180	MERCEDES C280 (W203) 05/2000-02/2007	Steering Tie Rod End - Front Left Outer
SSP0518	301191605180	MERCEDES C32 AMG (W203) 05/2000-02/2007	Steering Tie Rod End - Front Left Outer
SSP0518	301191605180	MERCEDES C320 (W203) 05/2000-02/2007	Steering Tie Rod End - Front Left Outer
SSP0518	301191605180	MERCEDES C350 (W203) 05/2000-02/2007	Steering Tie Rod End - Front Left Outer
SSP0518	301191605180	MERCEDES C55 AMG (W203) 05/2000-02/2007	Steering Tie Rod End - Front Left Outer
SSP0518	301191605180	MERCEDES CLK280 (A209-C209) 06/2002-05/2009	Steering Tie Rod End - Front Left Outer
SSP0518	301191605180	MERCEDES CLK320 (A209-C209) 06/2002-05/2009	Steering Tie Rod End - Front Left Outer
SSP0518	301191605180	MERCEDES CLK350 (A209-C209) 06/2002-05/2009	Steering Tie Rod End - Front Left Outer
SSP0518	301191605180	MERCEDES CLK430 (A209-C209) 06/2002-05/2009	Steering Tie Rod End - Front Left Outer
SSP0518	301191605180	MERCEDES CLK500 (A209-C209) 06/2002-05/2009	Steering Tie Rod End - Front Left Outer
SSP0518	301191605180	MERCEDES CLK55 AMG (A209-C209) 06/2002-05/2009	Steering Tie Rod End - Front Left Outer
SSP0518	301191605180	MERCEDES CLK550 (A209-C209) 06/2002-05/2009	Steering Tie Rod End - Front Left Outer
SSP0518	301191605180	MERCEDES CLK63 AMG (A209-C209) 06/2002-05/2009	Steering Tie Rod End - Front Left Outer
SSP0518	301191605180	MERCEDES SLK200 (R171) 03/2004-02/2011	Steering Tie Rod End - Front Left Outer
SSP0518	301191605180	MERCEDES SLK280 (R171) 03/2004-02/2011	Steering Tie Rod End - Front Left Outer
SSP0518	301191605180	MERCEDES SLK300 (R171) 03/2004-02/2011	Steering Tie Rod End - Front Left Outer
SSP0518	301191605180	MERCEDES SLK350 (R171) 03/2004-02/2011	Steering Tie Rod End - Front Left Outer
SSP0518	301191605180	MERCEDES SLK55 AMG (R171) 03/2004-02/2011	Steering Tie Rod End - Front Left Outer
SSP0519	301191605190	MERCEDES C300 (W205) AWD 12/2013-	Steering Tie Rod End - Front Right
SSP0519	301191605190	MERCEDES C350 (W205) AWD 12/2013-	Steering Tie Rod End - Front Right
SSP0519	301191605190	MERCEDES C400 (W205) AWD 12/2013-	Steering Tie Rod End - Front Right
SSP0519	301191605190	MERCEDES C450 AMG (W205) AWD 12/2013-	Steering Tie Rod End - Front Right
SSP0520	301191605200	MERCEDES C300 (W205) AWD 12/2013-	Steering Tie Rod End - Front Left
SSP0520	301191605200	MERCEDES C350 (W205) AWD 12/2013-	Steering Tie Rod End - Front Left
SSP0520	301191605200	MERCEDES C400 (W205) AWD 12/2013-	Steering Tie Rod End - Front Left
SSP0520	301191605200	MERCEDES C450 AMG (W205) AWD 12/2013-	Steering Tie Rod End - Front Left
SSP0521	301191605210	MERCEDES C180 (W205) RWD 12/2013-	Steering Tie Rod End - Front Right
SSP0521	301191605210	MERCEDES C200 (W205) RWD 12/2013-	Steering Tie Rod End - Front Right
SSP0521	301191605210	MERCEDES C250 (W205) RWD 12/2013-	Steering Tie Rod End - Front Right
SSP0521	301191605210	MERCEDES C300 (W205) RWD 12/2013-	Steering Tie Rod End - Front Right
SSP0521	301191605210	MERCEDES C350 (W205) RWD 12/2013-	Steering Tie Rod End - Front Right



 SHORT LONG			DESCRIPTION
SSP0521	301191605210	MERCEDES C63 AMG (W205) RWD 12/2013-	Steering Tie Rod End - Front Right
SSP0521	301191605210	MERCEDES C63 AMG S (W205) RWD 12/2013-	Steering Tie Rod End - Front Right
SSP0522	301191605220	MERCEDES C180 (W205) RWD 12/2013-	Steering Tie Rod End - Front Left
SSP0522	301191605220	MERCEDES C200 (W205) RWD 12/2013-	Steering Tie Rod End - Front Left
SSP0522	301191605220	MERCEDES C250 (W205) RWD 12/2013-	Steering Tie Rod End - Front Left
SSP0522	301191605220	MERCEDES C300 (W205) RWD 12/2013-	Steering Tie Rod End - Front Left
SSP0522	301191605220	MERCEDES C350 (W205) RWD 12/2013-	Steering Tie Rod End - Front Left
SSP0522	301191605220	MERCEDES C63 AMG (W205) RWD 12/2013-	Steering Tie Rod End - Front Left
SSP0522	301191605220	MERCEDES C63 AMG S (W205) RWD 12/2013-	Steering Tie Rod End - Front Left
SSP0523	301191605230	MERCEDES ML350 (W163) 1998-06/2005	Steering Tie Rod End - Front Right
SSP0523	301191605230	MERCEDES ML500 (W163) 1998-06/2005	Steering Tie Rod End - Front Right
SSP0524	301191605240	MERCEDES ML350 (W163) 1998-06/2005	Steering Tie Rod End - Front Left
SSP0524	301191605240	MERCEDES ML500 (W163) 1998-06/2005	Steering Tie Rod End - Front Left
SSP0525	301191605250	MERCEDES ML350 (W164) 07/2005-05/2011	Steering Tie Rod End - Front Right
SSP0525	301191605250	MERCEDES ML500 (W164) 07/2005-05/2011	Steering Tie Rod End - Front Right
SSP0525	301191605250	MERCEDES ML550 (W164) 07/2005-05/2011	Steering Tie Rod End - Front Right
SSP0525	301191605250	MERCEDES ML63 AMG (W164) 07/2005-05/2011	Steering Tie Rod End - Front Right
SSP0526	301191605260	MERCEDES ML350 (W164) 07/2005-05/2011	Steering Tie Rod End - Front Left
SSP0526	301191605260	MERCEDES ML500 (W164) 07/2005-05/2011	Steering Tie Rod End - Front Left
SSP0526	301191605260	MERCEDES ML550 (W164) 07/2005-05/2011	Steering Tie Rod End - Front Left
SSP0526	301191605260	MERCEDES ML63 AMG (W164) 07/2005-05/2011	Steering Tie Rod End - Front Left
SSP0527	301191605270	MERCEDES R320 (W251) 09/2006-08/2013	Steering Tie Rod End - Front Right
SSP0527	301191605270	MERCEDES R350 (W251) 09/2006-08/2013	Steering Tie Rod End - Front Right
SSP0527	301191605270	MERCEDES R500 (W251) 09/2006-08/2013	Steering Tie Rod End - Front Right
SSP0527	301191605270	MERCEDES R550 (W251) 09/2006-08/2013	Steering Tie Rod End - Front Right
SSP0527	301191605270	MERCEDES R63 AMG (W251) 09/2006-08/2013	Steering Tie Rod End - Front Right
SSP0528	301191605280	MERCEDES R320 (W251) 09/2006-08/2013	Steering Tie Rod End - Front Left
SSP0528	301191605280	MERCEDES R350 (W251) 09/2006-08/2013	Steering Tie Rod End - Front Left
SSP0528	301191605280	MERCEDES R500 (W251) 09/2006-08/2013	Steering Tie Rod End - Front Left
SSP0528	301191605280	MERCEDES R550 (W251) 09/2006-08/2013	Steering Tie Rod End - Front Left
SSP0528	301191605280	MERCEDES R63 AMG (W251) 09/2006-08/2013	Steering Tie Rod End - Front Left
SSP0529	301191605290	MERCEDES CL200 C215 03/1999-03/2006	Steering Tie Rod End - Front
SSP0529	301191605290	MERCEDES CL230 C215 03/1999-03/2006	Steering Tie Rod End - Front
SSP0529	301191605290	MERCEDES CL500 C215 03/1999-03/2006	Steering Tie Rod End - Front
SSP0529	301191605290	MERCEDES CL55 AMG C215 03/1999-03/2006	Steering Tie Rod End - Front
SSP0529	301191605290	MERCEDES CL600 C215 03/1999-03/2006	Steering Tie Rod End - Front





 SHORT LONG			DESCRIPTION
SSP0529	301191605290	MERCEDES CL65 AMG C215 03/1999-03/2006	Steering Tie Rod End - Front
SSP0529	301191605290	MERCEDES S320 (W220) 1999-2005	Steering Tie Rod End - Front
SSP0529	301191605290	MERCEDES S350 (W220) 1999-2005	Steering Tie Rod End - Front
SSP0529	301191605290	MERCEDES S420 (W220) 1999-2005	Steering Tie Rod End - Front
SSP0529	301191605290	MERCEDES S430 (W220) 1999-2005	Steering Tie Rod End - Front
SSP0529	301191605290	MERCEDES S500 (W220) 1999-2005	Steering Tie Rod End - Front
SSP0529	301191605290	MERCEDES S55 AMG (W220) 1999-2005	Steering Tie Rod End - Front
SSP0529	301191605290	MERCEDES S600 (W220) 1999-2005	Steering Tie Rod End - Front
SSP0529	301191605290	MERCEDES S65 AMG (W220) 1999-2005	Steering Tie Rod End - Front
SSP0529	301191605290	MERCEDES SL500 (R230) 10/2001-01/2012	Steering Tie Rod End - Front
SSP0529	301191605290	MERCEDES SL55 AMG (R230) 10/2001-01/2012	Steering Tie Rod End - Front
SSP0529	301191605290	MERCEDES SL550 (R230) 10/2001-01/2012	Steering Tie Rod End - Front
SSP0529	301191605290	MERCEDES SL600 (R230) 10/2001-01/2012	Steering Tie Rod End - Front
SSP0529	301191605290	MERCEDES SL63 AMG (R230) 10/2001-01/2012	Steering Tie Rod End - Front
SSP0529	301191605290	MERCEDES SL65 AMG (R230) 10/2001-01/2012	Steering Tie Rod End - Front
SSP0530	301191605300	MERCEDES CLS350 (C219) RWD 10/2004-12/2010	Steering Tie Rod End - Front Right
SSP0530	301191605300	MERCEDES CLS500 (C219) RWD 10/2004-12/2010	Steering Tie Rod End - Front Right
SSP0530	301191605300	MERCEDES CLS55 AMG (C219) RWD 10/2004-12/2010	Steering Tie Rod End - Front Right
SSP0530	301191605300	MERCEDES CLS550 (C219) RWD 10/2004-12/2010	Steering Tie Rod End - Front Right
SSP0530	301191605300	MERCEDES CLS63 AMG (C219) RWD 10/2004-12/2010	Steering Tie Rod End - Front Right
SSP0530	301191605300	MERCEDES E280 (W211) 03/2003-07/2009	Steering Tie Rod End - Front Right
SSP0530	301191605300	MERCEDES E300 (W211) 03/2003-07/2009	Steering Tie Rod End - Front Right
SSP0530	301191605300	MERCEDES E320 (W211) 03/2003-07/2009	Steering Tie Rod End - Front Right
SSP0530	301191605300	MERCEDES E350 (W211) 03/2003-07/2009	Steering Tie Rod End - Front Right
SSP0530	301191605300	MERCEDES E500 (W211) 03/2003-07/2009	Steering Tie Rod End - Front Right
SSP0530	301191605300	MERCEDES E55 AMG (W211) 03/2003-07/2009	Steering Tie Rod End - Front Right
SSP0530	301191605300	MERCEDES E550 (W211) 03/2003-07/2009	Steering Tie Rod End - Front Right
SSP0530	301191605300	MERCEDES E63 AMG (W211) 03/2003-07/2009	Steering Tie Rod End - Front Right
SSP0531	301191605310	MERCEDES CLS350 (C219) RWD 10/2004-12/2010	Steering Tie Rod End - Front Left
SSP0531	301191605310	MERCEDES CLS500 (C219) RWD 10/2004-12/2010	Steering Tie Rod End - Front Left
SSP0531	301191605310	MERCEDES CLS55 AMG (C219) RWD 10/2004-12/2010	Steering Tie Rod End - Front Left
SSP0531	301191605310	MERCEDES CLS550 (C219) RWD 10/2004-12/2010	Steering Tie Rod End - Front Left





 SHORT LONG			DESCRIPTION
SSP0531	301191605310	MERCEDES CLS63 AMG (C219) RWD 10/2004-12/2010	Steering Tie Rod End - Front Left
SSP0531	301191605310	MERCEDES E280 (W211) 03/2003-07/2009	Steering Tie Rod End - Front Left
SSP0531	301191605310	MERCEDES E300 (W211) 03/2003-07/2009	Steering Tie Rod End - Front Left
SSP0531	301191605310	MERCEDES E320 (W211) 03/2003-07/2009	Steering Tie Rod End - Front Left
SSP0531	301191605310	MERCEDES E350 (W211) 03/2003-07/2009	Steering Tie Rod End - Front Left
SSP0531	301191605310	MERCEDES E500 (W211) 03/2003-07/2009	Steering Tie Rod End - Front Left
SSP0531	301191605310	MERCEDES E55 AMG (W211) 03/2003-07/2009	Steering Tie Rod End - Front Left
SSP0531	301191605310	MERCEDES E550 (W211) 03/2003-07/2009	Steering Tie Rod End - Front Left
SSP0531	301191605310	MERCEDES E63 AMG (W211) 03/2003-07/2009	Steering Tie Rod End - Front Left
SSP0532	301191605320	MERCEDES S350 (W221) 10/2005-04/2013	Steering Tie Rod End - Front
SSP0532	301191605320	MERCEDES S400 (W221) 10/2005-04/2013	Steering Tie Rod End - Front
SSP0532	301191605320	MERCEDES S430 (W221) 10/2005-04/2013	Steering Tie Rod End - Front
SSP0532	301191605320	MERCEDES S450 (W221) 10/2005-04/2013	Steering Tie Rod End - Front
SSP0532	301191605320	MERCEDES S500 (W221) 10/2005-04/2013	Steering Tie Rod End - Front
SSP0532	301191605320	MERCEDES S550 (W221) 10/2005-04/2013	Steering Tie Rod End - Front
SSP0532	301191605320	MERCEDES S600 (W221) 10/2005-04/2013	Steering Tie Rod End - Front
SSP0532	301191605320	MERCEDES S63 AMG (W221) 10/2005-04/2013	Steering Tie Rod End - Front
SSP0532	301191605320	MERCEDES S65 AMG (W221) 10/2005-04/2013	Steering Tie Rod End - Front
SSP0533	301191605330	MERCEDES S350 (W221) AWD 10/2005-04/2013	Steering Tie Rod End - Front Right
SSP0533	301191605330	MERCEDES S450 (W221) AWD 10/2005-04/2013	Steering Tie Rod End - Front Right
SSP0533	301191605330	MERCEDES S500 (W221) AWD 10/2005-04/2013	Steering Tie Rod End - Front Right
SSP0533	301191605330	MERCEDES S550 (W221) AWD 10/2005-04/2013	Steering Tie Rod End - Front Right
SSP0534	301191605340	MERCEDES S350 (W221) AWD 10/2005-04/2013	Steering Tie Rod End - Front Left
SSP0534	301191605340	MERCEDES S450 (W221) AWD 10/2005-04/2013	Steering Tie Rod End - Front Left
SSP0534	301191605340	MERCEDES S500 (W221) AWD 10/2005-04/2013	Steering Tie Rod End - Front Left
SSP0534	301191605340	MERCEDES S550 (W221) AWD 10/2005-04/2013	Steering Tie Rod End - Front Left
SSP0535	301191605350	MAZDA 2 DE 10/2007-2015	Steering Tie Rod End - Front Right
SSP0536	301191605360	MAZDA 2 DE 10/2007-2015	Steering Tie Rod End - Front Left
SSP0537	301191605370	MAZDA 3 BK 10/2003-06/2009	Steering Tie Rod End - Front Right
SSP0537	301191605370	MAZDA 3 BL 07/2009-11/2014	Steering Tie Rod End - Front Right
SSP0537	301191605370	MAZDA 5 CR19, 2nd Gen 03/2005-08/2010	Steering Tie Rod End - Front Right
SSP0538	301191605380	MAZDA 3 BK 10/2003-06/2009	Steering Tie Rod End - Front Left
SSP0538	301191605380	MAZDA 3 BL 07/2009-11/2014	Steering Tie Rod End - Front Left





 SHORT LONG			DESCRIPTION
SSP0553	301191605530	PEUGEOT 4007 02/2007-	Steering Tie Rod End - Front
SSP0554	301191605540	MITSUBISHI L200 (KB_T,KA_T) 11/2005-	Steering Tie Rod End - Front Right
SSP0554	301191605540	MITSUBISHI MONTERO III 04/2000-01/2007	Steering Tie Rod End - Front Right
SSP0554	301191605540	MITSUBISHI PAJERO III 04/2000-01/2007	Steering Tie Rod End - Front Right
SSP0555	301191605550	MITSUBISHI L200 (KB_T,KA_T) 11/2005-	Steering Tie Rod End - Front Left
SSP0555	301191605550	MITSUBISHI MONTERO III 04/2000-01/2007	Steering Tie Rod End - Front Left
SSP0555	301191605550	MITSUBISHI PAJERO III 04/2000-01/2007	Steering Tie Rod End - Front Left
SSP0556	301191605560	MITSUBISHI MONTERO IV 02/2007-	Steering Tie Rod End - Front Right
SSP0556	301191605560	MITSUBISHI PAJERO IV 02/2007-	Steering Tie Rod End - Front Right
SSP0557	301191605570	MITSUBISHI MONTERO IV 02/2007-	Steering Tie Rod End - Front Left
SSP0557	301191605570	MITSUBISHI PAJERO IV 02/2007-	Steering Tie Rod End - Front Left
SSP0558	301191605580	MITSUBISHI COLT VI 10/2002-06/2012	Steering Tie Rod End - Front
SSP0558	301191605580	SMART FORFOUR 454 06/2004-10/2012	Steering Tie Rod End - Front
SSP0559	301191605590	MITSUBISHI CARISMA 09/2000-06/2006	Steering Tie Rod End - Front
SSP0559	301191605590	MITSUBISHI SPACE STAR 1998-2004	Steering Tie Rod End - Front
SSP0560	301191605600	MINI Cooper (R50, R53) 05/2001-09/2006	Steering Tie Rod End - Front Right
SSP0561	301191605610	MINI Cooper (R50, R53) 05/2001-09/2006	Steering Tie Rod End - Front Left
SSP0562	301191605620	MINI Cooper (R50, R53) 05/2001-09/2006	Steering Tie Rod End - Front Right
SSP0562	301191605620	MINI Cooper (R52) 07/2004-11/2007	Steering Tie Rod End - Front Right
SSP0563	301191605630	MINI Cooper (R50, R53) 05/2001-09/2006	Steering Tie Rod End - Front Left
SSP0563	301191605630	MINI Cooper (R52) 07/2004-11/2007	Steering Tie Rod End - Front Left
SSP0564	301191605640	MINI Cooper (R55, R56) 09/2006-05/2010	Steering Tie Rod End - Front Right
SSP0565	301191605650	MINI Cooper (R55, R56) 09/2006-05/2010	Steering Tie Rod End - Front Left
SSP0566	301191605660	MINI Cooper Countryman (R60) 06/2010-12/2014	Steering Tie Rod End - Front Right
SSP0567	301191605670	MINI Cooper Countryman (R60) 06/2010-12/2014	Steering Tie Rod End - Front Left
SSP0568	301191605680	MINI Cooper Countryman (R60) 06/2010-12/2014	Steering Tie Rod End - Front Right
SSP0569	301191605690	MINI Cooper Countryman (R60) 06/2010-12/2014	Steering Tie Rod End - Front Left
SSP0570	301191605700	NISSAN MICRA (K11) 08/1992-01/2003	Steering Tie Rod End - Front
SSP0571	301191605710	NISSAN MICRA (K12) 02/2003-05/2010	Steering Tie Rod End - Front Right
SSP0572	301191605720	NISSAN MICRA (K12) 02/2003-05/2010	Steering Tie Rod End - Front Left
SSP0573	301191605730	NISSAN MARCH (K13) 06/2010-	Steering Tie Rod End - Front Right
SSP0573	301191605730	NISSAN MICRA (K13) 06/2010-	Steering Tie Rod End - Front Right
SSP0574	301191605740	NISSAN MARCH (K13) 06/2010-	Steering Tie Rod End - Front Left
SSP0574	301191605740	NISSAN MICRA (K13) 06/2010-	Steering Tie Rod End - Front Left
SSP0575	301191605750	NISSAN MURANO (Z50) 03/2003-10/2007	Steering Tie Rod End - Front
SSP0576	301191605760	NISSAN ALTIMA 4th Gen (L32A, D32) 2007-2012	Steering Tie Rod End - Front Right
SSP0576	301191605760	NISSAN MURANO (Z51) 11/2007-	Steering Tie Rod End - Front Right
SSP0576	301191605760	NISSAN TEANA (J32) 2009-2013	Steering Tie Rod End - Front Right





 SHORT LONG			DESCRIPTION
SSP0577	301191605770	NISSAN ALTIMA 4th Gen (L32A, D32) 2007-2012	Steering Tie Rod End - Front Left
SSP0577	301191605770	NISSAN MURANO (Z51) 11/2007-	Steering Tie Rod End - Front Left
SSP0577	301191605770	NISSAN TEANA (J32) 2009-2013	Steering Tie Rod End - Front Left
SSP0578	301191605780	INFINITI QX4 R50 1997-2004	Steering Tie Rod End - Front Outer
SSP0578	301191605780	NISSAN PATHFINDER (R50) 1997-2004	Steering Tie Rod End - Front Outer
SSP0578	301191605780	NISSAN Pickup (D22) (4WD) 03/1998-07/2012	Steering Tie Rod End - Front Outer
SSP0578	301191605780	NISSAN X-TRAIL 1st Gen (T30) 06/2001-05/2007	Steering Tie Rod End - Front Outer
SSP0579	301191605790	NISSAN FRONTIER (D40) 07/2005-	Steering Tie Rod End - Front Right
SSP0579	301191605790	NISSAN NAVARA (D40) 07/2005-	Steering Tie Rod End - Front Right
SSP0579	301191605790	NISSAN PATHFINDER (R51) 03/2005-05/2014	Steering Tie Rod End - Front Right
SSP0580	301191605800	NISSAN FRONTIER (D40) 07/2005-	Steering Tie Rod End - Front Left
SSP0580	301191605800	NISSAN NAVARA (D40) 07/2005-	Steering Tie Rod End - Front Left
SSP0580	301191605800	NISSAN PATHFINDER (R51) 03/2005-05/2014	Steering Tie Rod End - Front Left
SSP0581	301191605810	NISSAN ALMERA (N15) 07/1995-06/2000	Steering Tie Rod End - Front
SSP0582	301191605820	NISSAN ALMERA (N16) 07/2000-09/2006	Steering Tie Rod End - Front Outer
SSP0583	301191605830	NISSAN ALMERA (N16) 07/2000-09/2006	Steering Tie Rod End - Front
SSP0584	301191605840	NISSAN ALMERA (N16) 08/2000-07/2006	Steering Tie Rod End - Front
SSP0585	301191605850	NISSAN PRIMERA (P10-W10-W11) 06/1990-06/1996	Steering Tie Rod End - Front
SSP0585	301191605850	NISSAN PRIMERA (P11) 06/1996-12/2001	Steering Tie Rod End - Front
SSP0585	301191605850	NISSAN PRIMERA (P12) 01/2002-05/2008	Steering Tie Rod End - Front
SSP0585	301191605850	NISSAN SERENA MK I C23 07/1992-09/2001	Steering Tie Rod End - Front
SSP0585	301191605850	NISSAN VANETTE (HC 23) CARGO 09/1994-08/1999	Steering Tie Rod End - Front
SSP0586	301191605860	NISSAN NOTE (E11) 03/2006-05/2013	Steering Tie Rod End - Front Right
SSP0586	301191605860	NISSAN TIIDA (C11) 07/2004-08/2012	Steering Tie Rod End - Front Right
SSP0586	301191605860	NISSAN VERSA 2004-2012	Steering Tie Rod End - Front Right
SSP0587	301191605870	NISSAN NOTE (E11) 03/2006-05/2013	Steering Tie Rod End - Front Left
SSP0587	301191605870	NISSAN TIIDA (C11) 07/2004-08/2012	Steering Tie Rod End - Front Left
SSP0587	301191605870	NISSAN VERSA 2004-2012	Steering Tie Rod End - Front Left
SSP0588	301191605880	NISSAN JUKE 06/2010-	Steering Tie Rod End - Front Right
SSP0589	301191605890	NISSAN JUKE 06/2010-	Steering Tie Rod End - Front Left
SSP0590	301191605900	NISSAN QASHQAI (J10, JJ10) 02/2007-01/2014	Steering Tie Rod End - Front Right
SSP0590	301191605900	NISSAN X-TRAIL 2nd Gen (T31) 06/2007-09/2013	Steering Tie Rod End - Front Right
SSP0591	301191605910	NISSAN QASHQAI (J10, JJ10) 02/2007-01/2014	Steering Tie Rod End - Front Left
SSP0591	301191605910	NISSAN X-TRAIL 2nd Gen (T31) 06/2007-09/2013	Steering Tie Rod End - Front Left
SSP0592	301191605920	NISSAN QASHQAI II (J11) 02/2014-	Steering Tie Rod End - Front Right
SSP0592	301191605920	RENAULT KADJAR 2015-	Steering Tie Rod End - Front Right





 SHORT LONG			DESCRIPTION
SSP0593	301191605930	NISSAN QASHQAI II (J11) 02/2014-	Steering Tie Rod End - Front Left
SSP0593	301191605930	RENAULT KADJAR 2015-	Steering Tie Rod End - Front Left
SSP0594	301191605940	OPEL COMBO (C) 09/2000-07/2006	Steering Tie Rod End - Front
SSP0594	301191605940	OPEL CORSA (A) 09/1982-02/1993	Steering Tie Rod End - Front
SSP0594	301191605940	OPEL CORSA (B) 73,78,79 08/1999-08/2000	Steering Tie Rod End - Front
SSP0594	301191605940	OPEL CORSA (C) 09/2000-07/2006	Steering Tie Rod End - Front
SSP0594	301191605940	VAUXHALL CORSA 1997-2000	Steering Tie Rod End - Front
SSP0594	301191605940	VAUXHALL NOVA 1982-1993	Steering Tie Rod End - Front
SSP0594	301191605940	VAUXHALL TIGRA 1997-	Steering Tie Rod End - Front
SSP0595	301191605950	OPEL COMBO (B) 03/1993-08/2000	Steering Tie Rod End - Front
SSP0595	301191605950	OPEL CORSA (B) 03/1993-08/2000	Steering Tie Rod End - Front
SSP0596	301191605960	OPEL MERIVA (A) 05/2003-05/2010	Steering Tie Rod End - Front
SSP0597	301191605970	OPEL AGILA (A) 09/2000-08/2007	Steering Tie Rod End - Front
SSP0597	301191605970	SUBARU JUSTY III 09/2003-12/2006	Steering Tie Rod End - Front
SSP0597	301191605970	SUZUKI IGNIS II 09/2003-07/2008	Steering Tie Rod End - Front
SSP0598	301191605980	BUICK ENCORE 2012-2016	Steering Tie Rod End - Front
SSP0598	301191605980	CHEVROLET TRAX 2014 -	Steering Tie Rod End - Front
SSP0598	301191605980	OPEL MOKKA 06/2012-	Steering Tie Rod End - Front
SSP0599	301191605990	BUICK ENCORE 2012-2016	Steering Tie Rod End - Front
SSP0599	301191605990	OPEL MOKKA 06/2012-	Steering Tie Rod End - Front
SSP0600	301191606000	OPEL ASTRA (G) 1998-2004	Steering Tie Rod End - Front
SSP0600	301191606000	OPEL ZAFIRA (A) 1998-2004	Steering Tie Rod End - Front
SSP0600	301191606000	VAUXHALL ASTRA 1998-	Steering Tie Rod End - Front
SSP0600	301191606000	VAUXHALL ASTRA COUPE 1998-	Steering Tie Rod End - Front
SSP0600	301191606000	VAUXHALL ZAFIRA 1999-	Steering Tie Rod End - Front
SSP0601	301191606010	OPEL ASTRA (G) 1998-2004	Steering Tie Rod End - Front
SSP0601	301191606010	OPEL ZAFIRA (A) 1998-2004	Steering Tie Rod End - Front
SSP0601	301191606010	VAUXHALL ASTRA 1998-	Steering Tie Rod End - Front
SSP0601	301191606010	VAUXHALL ASTRA COUPE 1998-	Steering Tie Rod End - Front
SSP0601	301191606010	VAUXHALL ZAFIRA 1999-	Steering Tie Rod End - Front
SSP0602	301191606020	OPEL ASTRA (H) 03/2004-11/2009	Steering Tie Rod End - Front Right
SSP0602	301191606020	OPEL MERIVA (B) 06/2010-	Steering Tie Rod End - Front Right
SSP0602	301191606020	OPEL ZAFIRA (B) (A05) 07/2005-09/2011	Steering Tie Rod End - Front Right
SSP0602	301191606020	SATURN ASTRA (H) 2008-2009	Steering Tie Rod End - Front Right
SSP0603	301191606030	OPEL ASTRA (H) 03/2004-11/2009	Steering Tie Rod End - Front Left
SSP0603	301191606030	OPEL MERIVA (B) 06/2010-	Steering Tie Rod End - Front Left
SSP0603	301191606030	OPEL ZAFIRA (B) (A05) 07/2005-09/2011	Steering Tie Rod End - Front Left
SSP0603	301191606030	SATURN ASTRA (H) 2008-2009	Steering Tie Rod End - Front Left
SSP0604	301191606040	BUICK VERANO 2012-2016	Steering Tie Rod End - Front
SSP0604	301191606040	CHEVROLET CRUZE 05/2009-2016	Steering Tie Rod End - Front
SSP0604	301191606040	CHEVROLET VOLT 1st Gen 2010-2015	Steering Tie Rod End - Front





			DESCRIPTION
SHORT	LONG		
SSP0604	301191606040	OPEL ASTRA (J) 12/2009-05/2015	Steering Tie Rod End - Front
SSP0604	301191606040	OPEL INSIGNIA 1st Gen 07/2008-2017	Steering Tie Rod End - Front
SSP0604	301191606040	OPEL ZAFIRA (C) (P12) 10/2011-	Steering Tie Rod End - Front
SSP0605	301191606050	CHEVROLET CRUZE 2nd Gen 2016-	Steering Tie Rod End - Front Right
SSP0605	301191606050	CHEVROLET VOLT 2nd Gen 2016-	Steering Tie Rod End - Front Right
SSP0605	301191606050	OPEL ASTRA (K) 06/2015-	Steering Tie Rod End - Front Right
SSP0606	301191606060	CHEVROLET CRUZE 2nd Gen 2016-	Steering Tie Rod End - Front Left
SSP0606	301191606060	CHEVROLET VOLT 2nd Gen 2016-	Steering Tie Rod End - Front Left
SSP0606	301191606060	OPEL ASTRA (K) 06/2015-	Steering Tie Rod End - Front Left
SSP0607	301191606070	OPEL ASTRA GTC (J) 2011-	Steering Tie Rod End - Front Right
SSP0608	301191606080	OPEL ASTRA GTC (J) 2011-	Steering Tie Rod End - Front Left
SSP0609	301191606090	BUICK LACROSSE 2nd Gen 2010-2016	Steering Tie Rod End - Front Right
SSP0609	301191606090	OPEL INSIGNIA 1st Gen 07/2008-2017	Steering Tie Rod End - Front Right
SSP0610	301191606100	BUICK LACROSSE 2nd Gen 2010-2016	Steering Tie Rod End - Front Left
SSP0610	301191606100	OPEL INSIGNIA 1st Gen 07/2008-2017	Steering Tie Rod End - Front Left
SSP0611	301191606110	OPEL CORSA (C) 09/2000-07/2006	Steering Tie Rod End - Front
SSP0612	301191606120	CITROEN BERLINGO MF 07/1996-	Steering Tie Rod End - Front
SSP0612	301191606120	CITROEN VISA C15 1982-1997	Steering Tie Rod End - Front
SSP0612	301191606120	CITROEN XSARA 1997-2005	Steering Tie Rod End - Front
SSP0612	301191606120	CITROEN XSARA PICASSO 12/1999-2012	Steering Tie Rod End - Front
SSP0612	301191606120	CITROEN ZX 1991-1997	Steering Tie Rod End - Front
SSP0612	301191606120	PEUGEOT 104 1972-1988	Steering Tie Rod End - Front
SSP0612	301191606120	PEUGEOT 205 1983-1998	Steering Tie Rod End - Front
SSP0612	301191606120	PEUGEOT 305 1977-1984	Steering Tie Rod End - Front
SSP0612	301191606120	PEUGEOT 306 1993-2001	Steering Tie Rod End - Front
SSP0612	301191606120	PEUGEOT 309 1985-1993	Steering Tie Rod End - Front
SSP0612	301191606120	PEUGEOT 504 1968-1993	Steering Tie Rod End - Front
SSP0612	301191606120	PEUGEOT 505 1968-1993	Steering Tie Rod End - Front
SSP0612	301191606120	PEUGEOT PARTNER I 05/1996-	Steering Tie Rod End - Front
SSP0612	301191606120	TALBOT SAMBA TAGORA 1981-1986	Steering Tie Rod End - Front
SSP0613	301191606130	CITROEN C1 06/2005-03/2014	Steering Tie Rod End - Front Right Outer
SSP0613	301191606130	PEUGEOT 1007 (KM) 04/2005-2010	Steering Tie Rod End - Front Right Outer
SSP0613	301191606130	PEUGEOT 107 06/2005-	Steering Tie Rod End - Front Right Outer
SSP0613	301191606130	TOYOTA AYGO 07/2005-09/2014	Steering Tie Rod End - Front Right Outer
SSP0614	301191606140	CITROEN C1 06/2005-03/2014	Steering Tie Rod End - Front Left Outer
SSP0614	301191606140	PEUGEOT 1007 (KM) 04/2005-2010	Steering Tie Rod End - Front Left Outer
SSP0614	301191606140	PEUGEOT 107 06/2005-	Steering Tie Rod End - Front Left Outer
SSP0614	301191606140	TOYOTA AYGO 07/2005-09/2014	Steering Tie Rod End - Front Left Outer
SSP0615	301191606150	PEUGEOT 1007 (KM) 04/2005-2010	Steering Tie Rod End - Front Right
SSP0616	301191606160	PEUGEOT 1007 (KM) 04/2005-2010	Steering Tie Rod End - Front Left
SSP0617	301191606170	CITROEN C3 PICASSO 02/2009-	Steering Tie Rod End - Front Right





 SHORT LONG			DESCRIPTION
SSP0617	301191606170	CITROEN C-ELYSEE 11/2012-	Steering Tie Rod End - Front Right
SSP0617	301191606170	PEUGEOT 207 02/2006-11/2012	Steering Tie Rod End - Front Right
SSP0617	301191606170	PEUGEOT 208 GTI 03/2012-	Steering Tie Rod End - Front Right
SSP0617	301191606170	PEUGEOT 301 11/2012-	Steering Tie Rod End - Front Right
SSP0618	301191606180	CITROEN C3 PICASSO 02/2009-	Steering Tie Rod End - Front Left
SSP0618	301191606180	CITROEN C-ELYSEE 11/2012-	Steering Tie Rod End - Front Left
SSP0618	301191606180	PEUGEOT 207 02/2006-11/2012	Steering Tie Rod End - Front Left
SSP0618	301191606180	PEUGEOT 208 GTI 03/2012-	Steering Tie Rod End - Front Left
SSP0618	301191606180	PEUGEOT 301 11/2012-	Steering Tie Rod End - Front Left
SSP0619	301191606190	CITROEN C5 RC 04/2004-01/2008	Steering Tie Rod End - Front Right Outer
SSP0619	301191606190	CITROEN C6 TD 09/2005-09/2012	Steering Tie Rod End - Front Right Outer
SSP0619	301191606190	PEUGEOT 407 05/2004-12/2011	Steering Tie Rod End - Front Right Outer
SSP0620	301191606200	CITROEN C5 RC 04/2004-01/2008	Steering Tie Rod End - Front Left Outer
SSP0620	301191606200	CITROEN C6 TD 09/2005-09/2012	Steering Tie Rod End - Front Left Outer
SSP0620	301191606200	PEUGEOT 407 05/2004-12/2011	Steering Tie Rod End - Front Left Outer
SSP0621	301191606210	PEUGEOT 407 05/2004-12/2011	Steering Tie Rod End - Front Right
SSP0622	301191606220	PEUGEOT 407 05/2004-12/2011	Steering Tie Rod End - Front Left Outer
SSP0623	301191606230	CITROEN C4 CACTUS 09/2014-	Steering Tie Rod End - Front Right
SSP0623	301191606230	PEUGEOT 2008 2013-	Steering Tie Rod End - Front Right
SSP0623	301191606230	PEUGEOT 208 03/2012-	Steering Tie Rod End - Front Right
SSP0624	301191606240	CITROEN C4 CACTUS 09/2014-	Steering Tie Rod End - Front Left
SSP0624	301191606240	PEUGEOT 2008 2013-	Steering Tie Rod End - Front Left
SSP0624	301191606240	PEUGEOT 208 03/2012-	Steering Tie Rod End - Front Left
SSP0625	301191606250	CITROEN BERLINGO M 04/2008-	Steering Tie Rod End - Front Right
SSP0625	301191606250	CITROEN C4 B7 11/2009-	Steering Tie Rod End - Front Right
SSP0625	301191606250	PEUGEOT 3008 09/2009-2016	Steering Tie Rod End - Front Right
SSP0625	301191606250	PEUGEOT 308 09/2007-10/2013	Steering Tie Rod End - Front Right
SSP0625	301191606250	PEUGEOT 5008 09/2009-	Steering Tie Rod End - Front Right
SSP0625	301191606250	PEUGEOT PARTNER II, Tepee 04/2008-	Steering Tie Rod End - Front Right
SSP0626	301191606260	CITROEN BERLINGO M 04/2008-	Steering Tie Rod End - Front Left
SSP0626	301191606260	CITROEN C4 B7 11/2009-	Steering Tie Rod End - Front Left
SSP0626	301191606260	PEUGEOT 3008 09/2009-2016	Steering Tie Rod End - Front Left
SSP0626	301191606260	PEUGEOT 308 09/2007-10/2013	Steering Tie Rod End - Front Left
SSP0626	301191606260	PEUGEOT 5008 09/2009-	Steering Tie Rod End - Front Left
SSP0626	301191606260	PEUGEOT PARTNER II, Tepee 04/2008-	Steering Tie Rod End - Front Left
SSP0627	301191606270	CITROEN C4 PICASSO II 2013-	Steering Tie Rod End - Front Right
SSP0627	301191606270	PEUGEOT 3008 II 2016-	Steering Tie Rod End - Front Right
SSP0627	301191606270	PEUGEOT 308 II 09/2013-	Steering Tie Rod End - Front Right
SSP0628	301191606280	CITROEN C4 PICASSO II 2013-	Steering Tie Rod End - Front Left
SSP0628	301191606280	PEUGEOT 3008 II 2016-	Steering Tie Rod End - Front Left
SSP0628	301191606280	PEUGEOT 308 II 09/2013-	Steering Tie Rod End - Front Left





 SHORT LONG			DESCRIPTION
SSP0629	301191606290	PEUGEOT 607 01/2000-11/2010	Steering Tie Rod End - Front Right
SSP0630	301191606300	PEUGEOT 607 01/2000-11/2010	Steering Tie Rod End - Front Left
SSP0631	301191606310	PEUGEOT 508 11/2010-	Steering Tie Rod End - Front Right
SSP0632	301191606320	PEUGEOT 508 11/2010-	Steering Tie Rod End - Front Left
SSP0633	301191606330	NISSAN INTERSTAR (X70) 07/2002-08/2010	Steering Tie Rod End - Front Right
SSP0633	301191606330	OPEL MOVANO (A) 07/1998-04/2010	Steering Tie Rod End - Front Right
SSP0633	301191606330	RENAULT MASTER I 07/1998-09/2003	Steering Tie Rod End - Front Right
SSP0633	301191606330	RENAULT MASTER II 10/2003-01/2010	Steering Tie Rod End - Front Right
SSP0634	301191606340	NISSAN INTERSTAR (X70) 07/2002-08/2010	Steering Tie Rod End - Front Left
SSP0634	301191606340	OPEL MOVANO (A) 07/1998-04/2010	Steering Tie Rod End - Front Left
SSP0634	301191606340	RENAULT MASTER I 07/1998-09/2003	Steering Tie Rod End - Front Left
SSP0634	301191606340	RENAULT MASTER II 10/2003-01/2010	Steering Tie Rod End - Front Left
SSP0635	301191606350	OPEL MOVANO (B) 05/2010-	Steering Tie Rod End - Front Right
SSP0635	301191606350	RENAULT MASTER III 02/2010-	Steering Tie Rod End - Front Right
SSP0636	301191606360	OPEL MOVANO (B) 05/2010-	Steering Tie Rod End - Front Left
SSP0636	301191606360	RENAULT MASTER III 02/2010-	Steering Tie Rod End - Front Left
SSP0637	301191606370	NISSAN ROGUE 1st Gen 2008-2014	Steering Tie Rod End - Front Right
SSP0637	301191606370	RENAULT KOLEOS 09/2008-	Steering Tie Rod End - Front Right
SSP0638	301191606380	NISSAN ROGUE 1st Gen 2008-2014	Steering Tie Rod End - Front Left
SSP0638	301191606380	RENAULT KOLEOS 09/2008-	Steering Tie Rod End - Front Left
SSP0639	301191606390	RENAULT MEGANE II 09/2003-04/2009	Steering Tie Rod End - Front Right
SSP0639	301191606390	RENAULT SCENIC II 06/2003-01/2009	Steering Tie Rod End - Front Right
SSP0640	301191606400	RENAULT MEGANE II 09/2003-04/2009	Steering Tie Rod End - Front Left
SSP0640	301191606400	RENAULT SCENIC II 06/2003-01/2009	Steering Tie Rod End - Front Left
SSP0641	301191606410	NISSAN PRIMASTAR (X83) 08/2002-06/2014	Steering Tie Rod End - Front Right
SSP0641	301191606410	OPEL VIVARO I 08/2001-06/2014	Steering Tie Rod End - Front Right
SSP0641	301191606410	OPEL VIVARO II 10/2014-	Steering Tie Rod End - Front Right
SSP0641	301191606410	RENAULT ESPACE IV 11/2002-09/2014	Steering Tie Rod End - Front Right
SSP0641	301191606410	RENAULT LAGUNA II 04/2001-09/2007	Steering Tie Rod End - Front Right
SSP0641	301191606410	RENAULT TRAFIC II 03/2001-09/2014	Steering Tie Rod End - Front Right
SSP0641	301191606410	RENAULT TRAFIC III 10/2014-	Steering Tie Rod End - Front Right
SSP0641	301191606410	RENAULT VEL SATIS 06/2002-07/2009	Steering Tie Rod End - Front Right
SSP0642	301191606420	NISSAN PRIMASTAR (X83) 08/2002-06/2014	Steering Tie Rod End - Front Left
SSP0642	301191606420	OPEL VIVARO I 08/2001-06/2014	Steering Tie Rod End - Front Left
SSP0642	301191606420	OPEL VIVARO II 10/2014-	Steering Tie Rod End - Front Left
SSP0642	301191606420	RENAULT ESPACE IV 11/2002-09/2014	Steering Tie Rod End - Front Left
SSP0642	301191606420	RENAULT LAGUNA II 04/2001-09/2007	Steering Tie Rod End - Front Left
SSP0642	301191606420	RENAULT TRAFIC II 03/2001-09/2014	Steering Tie Rod End - Front Left
SSP0642	301191606420	RENAULT TRAFIC III 10/2014-	Steering Tie Rod End - Front Left
SSP0642	301191606420	RENAULT VEL SATIS 06/2002-07/2009	Steering Tie Rod End - Front Left
SSP0643	301191606430	RENAULT FLUENCE 02/2010-	Steering Tie Rod End - Front Right



 SHORT LONG			DESCRIPTION
SSP0643	301191606430	RENAULT MEGANE III 05/2009-10/2015	Steering Tie Rod End - Front Right
SSP0643	301191606430	RENAULT SCENIC III 02/2009-	Steering Tie Rod End - Front Right
SSP0644	301191606440	RENAULT FLUENCE 02/2010-	Steering Tie Rod End - Front Left
SSP0644	301191606440	RENAULT MEGANE III 05/2009-10/2015	Steering Tie Rod End - Front Left
SSP0644	301191606440	RENAULT SCENIC III 02/2009-	Steering Tie Rod End - Front Left
SSP0645	301191606450	RENAULT CLIO I 05/1990-09/1998	Steering Tie Rod End - Front Right
SSP0645	301191606450	RENAULT CLIO II-SYMBOL 10/1998-2012	Steering Tie Rod End - Front Right
SSP0646	301191606460	RENAULT CLIO I 05/1990-09/1998	Steering Tie Rod End - Front Left
SSP0646	301191606460	RENAULT CLIO II-SYMBOL 10/1998-2012	Steering Tie Rod End - Front Left
SSP0647	301191606470	RENAULT CLIO II-SYMBOL 10/1998-2012	Steering Tie Rod End - Front Right
SSP0647	301191606470	RENAULT KANGOO I 03/1998-01/2008	Steering Tie Rod End - Front Right
SSP0648	301191606480	RENAULT CLIO II-SYMBOL 10/1998-2012	Steering Tie Rod End - Front Left
SSP0648	301191606480	RENAULT KANGOO I 03/1998-01/2008	Steering Tie Rod End - Front Left
SSP0649	301191606490	NISSAN KUBISTAR (X76) 08/2003-07/2007	Steering Tie Rod End - Front Right Outer
SSP0649	301191606490	NISSAN MICRA (K12) 02/2003-05/2010	Steering Tie Rod End - Front Right Outer
SSP0649	301191606490	RENAULT CLIO III-HB 06/2005-09/2012	Steering Tie Rod End - Front Right Outer
SSP0649	301191606490	RENAULT CLIO II-SYMBOL 10/1998-2012	Steering Tie Rod End - Front Right Outer
SSP0649	301191606490	RENAULT KANGOO I 03/1998-01/2008	Steering Tie Rod End - Front Right Outer
SSP0649	301191606490	RENAULT MODUS 12/2004-07/2014	Steering Tie Rod End - Front Right Outer
SSP0649	301191606490	RENAULT SCENIC I 1997-2002	Steering Tie Rod End - Front Right Outer
SSP0649	301191606490	RENAULT TWINGO II (CNO) 03/2007-	Steering Tie Rod End - Front Right Outer
SSP0650	301191606500	NISSAN KUBISTAR (X76) 08/2003-07/2007	Steering Tie Rod End - Front Left Outer
SSP0650	301191606500	NISSAN MICRA (K12) 02/2003-05/2010	Steering Tie Rod End - Front Left Outer
SSP0650	301191606500	RENAULT CLIO III-HB 06/2005-09/2012	Steering Tie Rod End - Front Left Outer
SSP0650	301191606500	RENAULT CLIO II-SYMBOL 10/1998-2012	Steering Tie Rod End - Front Left Outer
SSP0650	301191606500	RENAULT KANGOO I 03/1998-01/2008	Steering Tie Rod End - Front Left Outer
SSP0650	301191606500	RENAULT MODUS 12/2004-07/2014	Steering Tie Rod End - Front Left Outer
SSP0650	301191606500	RENAULT SCENIC I 1997-2002	Steering Tie Rod End - Front Left Outer
SSP0650	301191606500	RENAULT TWINGO II (CNO) 03/2007-	Steering Tie Rod End - Front Left Outer
SSP0651	301191606510	MERCEDES CITAN 415 11/2012-	Steering Tie Rod End - Front Right
SSP0651	301191606510	RENAULT KANGOO II 02/2008-	Steering Tie Rod End - Front Right
SSP0652	301191606520	MERCEDES CITAN 415 11/2012-	Steering Tie Rod End - Front Left
SSP0652	301191606520	RENAULT KANGOO II 02/2008-	Steering Tie Rod End - Front Left
SSP0653	301191606530	RENAULT CAPTUR 03/2013-	Steering Tie Rod End - Front Right
SSP0653	301191606530	RENAULT CLIO IV-HB 10/2012-	Steering Tie Rod End - Front Right
SSP0654	301191606540	RENAULT CAPTUR 03/2013-	Steering Tie Rod End - Front Left
SSP0654	301191606540	RENAULT CLIO IV-HB 10/2012-	Steering Tie Rod End - Front Left
SSP0655	301191606550	RENAULT TWINGO (C06) 03/1993-02/2007	Steering Tie Rod End - Front Right
SSP0656	301191606560	RENAULT TWINGO (C06) 03/1993-02/2007	Steering Tie Rod End - Front Left
SSP0657	301191606570	RENAULT LAGUNA III 10/2007-	Steering Tie Rod End - Front Right
SSP0658	301191606580	RENAULT LAGUNA III 10/2007-	Steering Tie Rod End - Front Left



 SHORT LONG			DESCRIPTION
SSP0659	301191606590	RENAULT MEGANE IV 2016-	Steering Tie Rod End - Front Right
SSP0659	301191606590	RENAULT TALISMAN 1st Gen 2015-	Steering Tie Rod End - Front Right
SSP0660	301191606600	RENAULT MEGANE IV 2016-	Steering Tie Rod End - Front Left
SSP0660	301191606600	RENAULT TALISMAN 1st Gen 2015-	Steering Tie Rod End - Front Left
SSP0661	301191606610	SEAT CORDOBA (6L2) 09/2002-11/2009	Steering Tie Rod End - Front Right
SSP0661	301191606610	SEAT IBIZA IV (6L1) 02/2002-11/2009	Steering Tie Rod End - Front Right
SSP0662	301191606620	SEAT CORDOBA (6L2) 09/2002-11/2009	Steering Tie Rod End - Front Left
SSP0662	301191606620	SEAT IBIZA IV (6L1) 02/2002-11/2009	Steering Tie Rod End - Front Left
SSP0663	301191606630	AUDI A2 02/2000-08/2005	Steering Tie Rod End - Front Right Outer
SSP0663	301191606630	SEAT IBIZA IV (6L1) 02/2002-11/2009	Steering Tie Rod End - Front Right Outer
SSP0663	301191606630	SEAT IBIZA V (6R) 03/2008-	Steering Tie Rod End - Front Right Outer
SSP0663	301191606630	SKODA FABIA (5J) 12/2006-09/2014	Steering Tie Rod End - Front Right Outer
SSP0663	301191606630	SKODA FABIA (6Y2) 08/1999-11/2006	Steering Tie Rod End - Front Right Outer
SSP0663	301191606630	SKODA PRAKTIK 03/2007-	Steering Tie Rod End - Front Right Outer
SSP0663	301191606630	SKODA RAPID 07/2012-	Steering Tie Rod End - Front Right Outer
SSP0663	301191606630	SKODA ROOMSTER (5J) 07/2006-	Steering Tie Rod End - Front Right Outer
SSP0663	301191606630	VOLKSWAGEN POLO (6R) 06/2009-	Steering Tie Rod End - Front Right Outer
SSP0663	301191606630	VOLKSWAGEN POLO (9N) 10/2001-05/2009	Steering Tie Rod End - Front Right Outer
SSP0664	301191606640	AUDI A2 02/2000-08/2005	Steering Tie Rod End - Front Left Outer
SSP0664	301191606640	SEAT IBIZA IV (6L1) 02/2002-11/2009	Steering Tie Rod End - Front Left Outer
SSP0664	301191606640	SEAT IBIZA V (6R) 03/2008-	Steering Tie Rod End - Front Left Outer
SSP0664	301191606640	SKODA FABIA (5J) 12/2006-09/2014	Steering Tie Rod End - Front Left Outer
SSP0664	301191606640	SKODA FABIA (6Y2) 08/1999-11/2006	Steering Tie Rod End - Front Left Outer
SSP0664	301191606640	SKODA PRAKTIK 03/2007-	Steering Tie Rod End - Front Left Outer
SSP0664	301191606640	SKODA RAPID 07/2012-	Steering Tie Rod End - Front Left Outer
SSP0664	301191606640	SKODA ROOMSTER (5J) 07/2006-	Steering Tie Rod End - Front Left Outer
SSP0664	301191606640	VOLKSWAGEN POLO (6R) 06/2009-	Steering Tie Rod End - Front Left Outer
SSP0664	301191606640	VOLKSWAGEN POLO (9N) 10/2001-05/2009	Steering Tie Rod End - Front Left Outer
SSP0665	301191606650	OPEL AGILA (B) 09/2007-12/2014	Steering Tie Rod End - Front
SSP0665	301191606650	SUZUKI ALTO IV (FF) 07/2002-12/2009	Steering Tie Rod End - Front
SSP0665	301191606650	SUZUKI SPLASH 01/2008-	Steering Tie Rod End - Front
SSP0665	301191606650	SUZUKI SWIFT III (SG) 02/2005-09/2010	Steering Tie Rod End - Front
SSP0666	301191606660	LEXUS ES300 XV10, XV20 1991-2001	Steering Tie Rod End - Front
SSP0666	301191606660	LEXUS RX300 1999-2003	Steering Tie Rod End - Front
SSP0666	301191606660	TOYOTA AYGO 1995-2004	Steering Tie Rod End - Front
SSP0666	301191606660	TOYOTA CAMRY XV10 06/1991-08/1996	Steering Tie Rod End - Front
SSP0666	301191606660	TOYOTA CAMRY XV20 09/1996-10/2001	Steering Tie Rod End - Front
SSP0666	301191606660	TOYOTA SIENNA XL10 1998-2003	Steering Tie Rod End - Front
SSP0666	301191606660	TOYOTA SOLARA XV20 1999-2003	Steering Tie Rod End - Front
SSP0667	301191606670	LEXUS LX470 J100 1998-2007	Steering Tie Rod End - Front Right





			DESCRIPTION
SHORT	LONG		
SSP0667	301191606670	TOYOTA LAND CRUISER J100 01/1998-08/2007	Steering Tie Rod End - Front Right
SSP0668	301191606680	LEXUS LX470 J100 1998-2007	Steering Tie Rod End - Front Left
SSP0668	301191606680	TOYOTA LAND CRUISER J100 01/1998-08/2007	Steering Tie Rod End - Front Left
SSP0669	301191606690	LEXUS GX470 J120 2003-2010	Steering Tie Rod End - Front
SSP0669	301191606690	TOYOTA LAND CRUISER J120 01/2003-02/2010	Steering Tie Rod End - Front
SSP0670	301191606700	TOYOTA HILUX III 2WD Pick-Up 08/2005-2015	Steering Tie Rod End - Front
SSP0671	301191606710	TOYOTA HILUX III 4WD Pick-Up 08/2005-2015	Steering Tie Rod End - Front
SSP0672	301191606720	TOYOTA ECHO XP10 1999-2005	Steering Tie Rod End - Front Right
SSP0672	301191606720	TOYOTA YARIS (P1) 04/1999-10/2005	Steering Tie Rod End - Front Right
SSP0673	301191606730	TOYOTA ECHO XP10 1999-2005	Steering Tie Rod End - Front Left
SSP0673	301191606730	TOYOTA YARIS (P1) 04/1999-10/2005	Steering Tie Rod End - Front Left
SSP0674	301191606740	TOYOTA YARIS (P13) 10/2010-	Steering Tie Rod End - Front Right
SSP0674	301191606740	TOYOTA YARIS (P9) 11/2005-09/2010	Steering Tie Rod End - Front Right
SSP0675	301191606750	TOYOTA YARIS (P13) 10/2010-	Steering Tie Rod End - Front Left
SSP0675	301191606750	TOYOTA YARIS (P9) 11/2005-09/2010	Steering Tie Rod End - Front Left
SSP0676	301191606760	TOYOTA COROLLA E100 07/1992-03/1997	Steering Tie Rod End - Front
SSP0676	301191606760	TOYOTA COROLLA E110 04/1997-01/2002	Steering Tie Rod End - Front
SSP0676	301191606760	TOYOTA COROLLA E80 05/1983-06/1987	Steering Tie Rod End - Front
SSP0676	301191606760	TOYOTA COROLLA E90 07/1987-12/1992	Steering Tie Rod End - Front
SSP0676	301191606760	TOYOTA RAV4 XA10 1995-06/2000	Steering Tie Rod End - Front
SSP0677	301191606770	TOYOTA RAV4 XA20 07/2000-11/2005	Steering Tie Rod End - Front Left
SSP0678	301191606780	TOYOTA RAV4 XA20 07/2000-11/2005	Steering Tie Rod End - Front Right
SSP0679	301191606790	TOYOTA RAV4 XA30 12/2005-2012	Steering Tie Rod End - Front Right
SSP0679	301191606790	TOYOTA RAV4 XA40 2013-	Steering Tie Rod End - Front Right
SSP0680	301191606800	TOYOTA RAV4 XA30 12/2005-2012	Steering Tie Rod End - Front Left
SSP0680	301191606800	TOYOTA RAV4 XA40 2013-	Steering Tie Rod End - Front Left
SSP0681	301191606810	TOYOTA AVENTIS (T25) 04/2003-01/2009	Steering Tie Rod End - Front
SSP0681	301191606810	TOYOTA COROLLA Verso 04/2004-04/2009	Steering Tie Rod End - Front
SSP0682	301191606820	TOYOTA INNOVA AN40 2005-2015	Steering Tie Rod End - Front
SSP0683	301191606830	TOYOTA COROLLA E120 02/2002-01/2007	Steering Tie Rod End - Front Right
SSP0684	301191606840	TOYOTA COROLLA E120 02/2002-01/2007	Steering Tie Rod End - Front Left
SSP0685	301191606850	SCION XB 2nd Gen 2008-2013	Steering Tie Rod End - Front Right
SSP0685	301191606850	TOYOTA AURIS I 02/2007-06/2013	Steering Tie Rod End - Front Right
SSP0685	301191606850	TOYOTA COROLLA E140 02/2007-06/2013	Steering Tie Rod End - Front Right
SSP0686	301191606860	SCION XB 2nd Gen 2008-2013	Steering Tie Rod End - Front Left
SSP0686	301191606860	TOYOTA AURIS I 02/2007-06/2013	Steering Tie Rod End - Front Left
SSP0686	301191606860	TOYOTA COROLLA E140 02/2007-06/2013	Steering Tie Rod End - Front Left
SSP0687	301191606870	TOYOTA AURIS II 07/2013-	Steering Tie Rod End - Front Right



			DESCRIPTION
SHORT	LONG		
SSP0687	301191606870	TOYOTA COROLLA E170 07/2013-	Steering Tie Rod End - Front Right
SSP0688	301191606880	TOYOTA AURIS II 07/2013-	Steering Tie Rod End - Front Left
SSP0688	301191606880	TOYOTA COROLLA E170 07/2013-	Steering Tie Rod End - Front Left
SSP0689	301191606890	TOYOTA LAND CRUISER J80 01/1990-12/1997	Steering Tie Rod End - Front Right
SSP0690	301191606900	TOYOTA LAND CRUISER J80 01/1990-12/1997	Steering Tie Rod End - Front Left
SSP0691	301191606910	TOYOTA 4RUNNER N180 3rd Gen 1996-2002	Steering Tie Rod End - Front Right Outer
SSP0691	301191606910	TOYOTA LAND CRUISER J90 1996-2002	Steering Tie Rod End - Front Right Outer
SSP0692	301191606920	TOYOTA 4RUNNER N180 3rd Gen 1996-2002	Steering Tie Rod End - Front Left Outer
SSP0692	301191606920	TOYOTA LAND CRUISER J90 1996-2002	Steering Tie Rod End - Front Left Outer
SSP0693	301191606930	TOYOTA LAND CRUISER J200 01/2008-	Steering Tie Rod End - Front Right
SSP0694	301191606940	TOYOTA LAND CRUISER J200 01/2008-	Steering Tie Rod End - Front Left
SSP0695	301191606950	TOYOTA LAND CRUISER J150 03/2010-	Steering Tie Rod End - Front
SSP0696	301191606960	AUDI Q7 4L 03/2006-08/2010	Steering Tie Rod End - Front Right
SSP0696	301191606960	PORSCHE CAYENNE 92A 2011-	Steering Tie Rod End - Front Right
SSP0696	301191606960	PORSCHE CAYENNE 955 09/2002-08/2010	Steering Tie Rod End - Front Right
SSP0696	301191606960	VOLKSWAGEN AMAROK 09/2010-	Steering Tie Rod End - Front Right
SSP0696	301191606960	VOLKSWAGEN GOL 2002-2010	Steering Tie Rod End - Front Right
SSP0696	301191606960	VOLKSWAGEN TOUAREG (7LA,7L6,7L7) 10/2002-05/2010	Steering Tie Rod End - Front Right
SSP0697	301191606970	AUDI Q7 4L 03/2006-08/2010	Steering Tie Rod End - Front Left
SSP0697	301191606970	PORSCHE CAYENNE 955 09/2002-08/2010	Steering Tie Rod End - Front Left
SSP0697	301191606970	VOLKSWAGEN AMAROK 09/2010-	Steering Tie Rod End - Front Left
SSP0697	301191606970	VOLKSWAGEN GOL 2002-2010	Steering Tie Rod End - Front Left
SSP0697	301191606970	VOLKSWAGEN TOUAREG (7LA,7L6,7L7) 10/2002-05/2010	Steering Tie Rod End - Front Left
SSP0698	301191606980	SEAT AROSA 05/1997-06/2004	Steering Tie Rod End - Front Right
SSP0698	301191606980	SEAT CORDOBA III 1993-1999	Steering Tie Rod End - Front Right
SSP0698	301191606980	SEAT IBIZA II 01/1994-08/1999	Steering Tie Rod End - Front Right
SSP0698	301191606980	SEAT TOLEDO I (1L) - CORDOBA - IBIZA III 1993-1999	Steering Tie Rod End - Front Right
SSP0698	301191606980	VOLKSWAGEN CORRADO 531 08/1987-12/1995	Steering Tie Rod End - Front Right
SSP0698	301191606980	VOLKSWAGEN GOLF MK2/A2 1983-1992	Steering Tie Rod End - Front Right
SSP0698	301191606980	VOLKSWAGEN GOLF MK3/A3 1991-1998	Steering Tie Rod End - Front Right
SSP0698	301191606980	VOLKSWAGEN JETTA MK2/A2 1983-1992	Steering Tie Rod End - Front Right
SSP0698	301191606980	VOLKSWAGEN JETTA MK3/A3 1991-1998	Steering Tie Rod End - Front Right
SSP0698	301191606980	VOLKSWAGEN LUPO 09/1998-07/2005	Steering Tie Rod End - Front Right
SSP0698	301191606980	VOLKSWAGEN PASSAT B3, B4 1988-1997	Steering Tie Rod End - Front Right
SSP0698	301191606980	VOLKSWAGEN POLO (6N1) 1994-09/2001	Steering Tie Rod End - Front Right
SSP0698	301191606980	VOLKSWAGEN POLO CLASSIC - CADDY II 1995-2001	Steering Tie Rod End - Front Right



 SHORT LONG			DESCRIPTION
SSP0698	301191606980	VOLKSWAGEN VENTO MK3/A3 1991-1998	Steering Tie Rod End - Front Right
SSP0699	301191606990	SEAT AROSA 05/1997-06/2004	Steering Tie Rod End - Front Left Outer
SSP0699	301191606990	SEAT CORDOBA III 1993-1999	Steering Tie Rod End - Front Left Outer
SSP0699	301191606990	SEAT IBIZA II 01/1994-08/1999	Steering Tie Rod End - Front Left Outer
SSP0699	301191606990	SEAT TOLEDO I (1L) - CORDOBA - IBIZA III 1993-1999	Steering Tie Rod End - Front Left Outer
SSP0699	301191606990	VOLKSWAGEN CORRADO 531 08/1987-12/1995	Steering Tie Rod End - Front Left Outer
SSP0699	301191606990	VOLKSWAGEN GOLF MK2/A2 1983-1992	Steering Tie Rod End - Front Left Outer
SSP0699	301191606990	VOLKSWAGEN GOLF MK3/A3 1991-1998	Steering Tie Rod End - Front Left Outer
SSP0699	301191606990	VOLKSWAGEN JETTA MK2/A2 1983-1992	Steering Tie Rod End - Front Left Outer
SSP0699	301191606990	VOLKSWAGEN JETTA MK3/A3 1991-1998	Steering Tie Rod End - Front Left Outer
SSP0699	301191606990	VOLKSWAGEN LUPO 09/1998-07/2005	Steering Tie Rod End - Front Left Outer
SSP0699	301191606990	VOLKSWAGEN PASSAT B3, B4 1988-1997	Steering Tie Rod End - Front Left Outer
SSP0699	301191606990	VOLKSWAGEN POLO (6N1) 1994-09/2001	Steering Tie Rod End - Front Left Outer
SSP0699	301191606990	VOLKSWAGEN POLO CLASSIC - CADDY II 1995-2001	Steering Tie Rod End - Front Left Outer
SSP0699	301191606990	VOLKSWAGEN VENTO MK3/A3 1991-1998	Steering Tie Rod End - Front Left Outer
SSP0700	301191607000	AUDI A3 8P1 06/2003-08/2012	Steering Tie Rod End - Front Right
SSP0700	301191607000	AUDI A3 8V1 09/2012-	Steering Tie Rod End - Front Right
SSP0700	301191607000	AUDI Q3 8U 06/2011-2016	Steering Tie Rod End - Front Right
SSP0700	301191607000	SEAT ALTEA V 03/2004-	Steering Tie Rod End - Front Right
SSP0700	301191607000	SEAT LEON (5F1) 12/2012-	Steering Tie Rod End - Front Right
SSP0700	301191607000	SEAT LEON 1P1 2006-2012	Steering Tie Rod End - Front Right
SSP0700	301191607000	SEAT TOLEDO III (5P2) 07/2006-05/2009	Steering Tie Rod End - Front Right
SSP0700	301191607000	SKODA KODIAQ (NS7) 2016-	Steering Tie Rod End - Front Right
SSP0700	301191607000	SKODA OCTAVIA (1Z3), (1Z5) 06/2004-10/2012	Steering Tie Rod End - Front Right
SSP0700	301191607000	SKODA OCTAVIA (5 E) 11/2012-	Steering Tie Rod End - Front Right
SSP0700	301191607000	SKODA SUPERB (3T4) 04/2008-	Steering Tie Rod End - Front Right
SSP0700	301191607000	SKODA YETI (5L) 05/2009-	Steering Tie Rod End - Front Right
SSP0700	301191607000	VOLKSWAGEN BEETLE A5 04/2011-	Steering Tie Rod End - Front Right
SSP0700	301191607000	VOLKSWAGEN CADDY Typ 2K 03/2004-04/2015	Steering Tie Rod End - Front Right
SSP0700	301191607000	VOLKSWAGEN EOS 2006-2016	Steering Tie Rod End - Front Right
SSP0700	301191607000	VOLKSWAGEN GOLF MK5/A5 10/2003-06/2009	Steering Tie Rod End - Front Right
SSP0700	301191607000	VOLKSWAGEN GOLF MK6/A6 2010-2013	Steering Tie Rod End - Front Right
SSP0700	301191607000	VOLKSWAGEN GOLF MK7/MQB 11/2012-	Steering Tie Rod End - Front Right
SSP0700	301191607000	VOLKSWAGEN GTI MK5/A5 2006-2009	Steering Tie Rod End - Front Right
SSP0700	301191607000	VOLKSWAGEN JETTA IV (162) 11/2010-	Steering Tie Rod End - Front Right
SSP0700	301191607000	VOLKSWAGEN JETTA MK5/A5 08/2005-10/2010	Steering Tie Rod End - Front Right





 SHORT LONG			DESCRIPTION
SSP0700	301191607000	VOLKSWAGEN PASSAT 3G2 2014-	Steering Tie Rod End - Front Right
SSP0700	301191607000	VOLKSWAGEN PASSAT B6 09/2005-07/2010	Steering Tie Rod End - Front Right
SSP0700	301191607000	VOLKSWAGEN PASSAT B7 08/2010-04/2015	Steering Tie Rod End - Front Right
SSP0700	301191607000	VOLKSWAGEN Rabbit MK5/A5 10/2003-06/2009	Steering Tie Rod End - Front Right
SSP0700	301191607000	VOLKSWAGEN SHARAN (7N) 04/2010-	Steering Tie Rod End - Front Right
SSP0700	301191607000	VOLKSWAGEN TIGUAN 1st Gen 09/2007-2016	Steering Tie Rod End - Front Right
SSP0700	301191607000	VOLKSWAGEN TOURAN (1T1,1T2) 02/2003-05/2010	Steering Tie Rod End - Front Right
SSP0700	301191607000	VOLKSWAGEN TOURAN (1T3) 06/2010-	Steering Tie Rod End - Front Right
SSP0701	301191607010	AUDI A3 8P1 06/2003-08/2012	Steering Tie Rod End - Front Left
SSP0701	301191607010	AUDI A3 8V1 09/2012-	Steering Tie Rod End - Front Left
SSP0701	301191607010	AUDI Q3 8U 06/2011-2016	Steering Tie Rod End - Front Left
SSP0701	301191607010	SEAT ALTEA V 03/2004-	Steering Tie Rod End - Front Left
SSP0701	301191607010	SEAT LEON (5F1) 12/2012-	Steering Tie Rod End - Front Left
SSP0701	301191607010	SEAT LEON 1P1 2006-2012	Steering Tie Rod End - Front Left
SSP0701	301191607010	SEAT TOLEDO III (5P2) 07/2006-05/2009	Steering Tie Rod End - Front Left
SSP0701	301191607010	SKODA KODIAQ (NS7) 2016-	Steering Tie Rod End - Front Left
SSP0701	301191607010	SKODA OCTAVIA (1Z3), (1Z5) 06/2004-10/2012	Steering Tie Rod End - Front Left
SSP0701	301191607010	SKODA OCTAVIA (5 E) 11/2012-	Steering Tie Rod End - Front Left
SSP0701	301191607010	SKODA SUPERB (3T4) 04/2008-	Steering Tie Rod End - Front Left
SSP0701	301191607010	SKODA YETI (5L) 05/2009-	Steering Tie Rod End - Front Left
SSP0701	301191607010	VOLKSWAGEN BEETLE A5 04/2011-	Steering Tie Rod End - Front Left
SSP0701	301191607010	VOLKSWAGEN CADDY Typ 2K 03/2004-04/2015	Steering Tie Rod End - Front Left
SSP0701	301191607010	VOLKSWAGEN EOS 2006-2016	Steering Tie Rod End - Front Left
SSP0701	301191607010	VOLKSWAGEN GOLF MK5/A5 10/2003-06/2009	Steering Tie Rod End - Front Left
SSP0701	301191607010	VOLKSWAGEN GOLF MK6/A6 2010-2013	Steering Tie Rod End - Front Left
SSP0701	301191607010	VOLKSWAGEN GOLF MK7/MQB 11/2012-	Steering Tie Rod End - Front Left
SSP0701	301191607010	VOLKSWAGEN GTI MK5/A5 2006-2009	Steering Tie Rod End - Front Left
SSP0701	301191607010	VOLKSWAGEN JETTA IV (162) 11/2010-	Steering Tie Rod End - Front Left
SSP0701	301191607010	VOLKSWAGEN JETTA MK5/A5 08/2005-10/2010	Steering Tie Rod End - Front Left
SSP0701	301191607010	VOLKSWAGEN PASSAT 3G2 2014-	Steering Tie Rod End - Front Left
SSP0701	301191607010	VOLKSWAGEN PASSAT B6 09/2005-07/2010	Steering Tie Rod End - Front Left
SSP0701	301191607010	VOLKSWAGEN PASSAT B7 08/2010-04/2015	Steering Tie Rod End - Front Left
SSP0701	301191607010	VOLKSWAGEN Rabbit MK5/A5 10/2003-06/2009	Steering Tie Rod End - Front Left
SSP0701	301191607010	VOLKSWAGEN SHARAN (7N) 04/2010-	Steering Tie Rod End - Front Left
SSP0701	301191607010	VOLKSWAGEN TIGUAN 1st Gen 09/2007-2016	Steering Tie Rod End - Front Left



			DESCRIPTION
SHORT	LONG		
SSP0701	301191607010	VOLKSWAGEN TOURAN (1T1,1T2) 02/2003-05/2010	Steering Tie Rod End - Front Left
SSP0702	301191607020	SEAT Mii (KYF) 10/2011-	Steering Tie Rod End - Front Right
SSP0702	301191607020	VOLKSWAGEN Up! 12/2011-2016	Steering Tie Rod End - Front Right
SSP0703	301191607030	SEAT Mii (KYF) 10/2011-	Steering Tie Rod End - Front Left
SSP0703	301191607030	VOLKSWAGEN Up! 12/2011-2016	Steering Tie Rod End - Front Left
SSP0704	301191607040	VOLKSWAGEN TRANSPORTER T5 05/2003-04/2011	Steering Tie Rod End - Front Right
SSP0704	301191607040	VOLKSWAGEN TRANSPORTER T5, facelift 05/2011-2016	Steering Tie Rod End - Front Right
SSP0704	301191607040	VOLKSWAGEN TRANSPORTER T6 2016-	Steering Tie Rod End - Front Right
SSP0705	301191607050	VOLKSWAGEN TRANSPORTER T5 05/2003-04/2011	Steering Tie Rod End - Front Left
SSP0705	301191607050	VOLKSWAGEN TRANSPORTER T5, facelift 05/2011-2016	Steering Tie Rod End - Front Left
SSP0705	301191607050	VOLKSWAGEN TRANSPORTER T6 2016-	Steering Tie Rod End - Front Left
SSP0706	301191607060	FORD GALAXY 05/1995-04/2006	Steering Tie Rod End - Front Right
SSP0706	301191607060	SEAT ALHAMBRA (7V8,7V9) 04/1996-03/2010	Steering Tie Rod End - Front Right
SSP0706	301191607060	VOLKSWAGEN SHARAN (7M6,7M8,7M9) 05/1995-03/2010	Steering Tie Rod End - Front Right
SSP0707	301191607070	FORD GALAXY 05/1995-04/2006	Steering Tie Rod End - Front Left
SSP0707	301191607070	SEAT ALHAMBRA (7V8,7V9) 04/1996-03/2010	Steering Tie Rod End - Front Left
SSP0707	301191607070	VOLKSWAGEN SHARAN (7M6,7M8,7M9) 05/1995-03/2010	Steering Tie Rod End - Front Left
SSP0708	301191607080	MITSUBISHI CARISMA 07/1995-09/2000	Steering Tie Rod End - Front
SSP0708	301191607080	MITSUBISHI LANCER (CS, A) 09/2003-07/2008	Steering Tie Rod End - Front
SSP0708	301191607080	PROTON PERSONA 02/1994-11/2000	Steering Tie Rod End - Front
SSP0708	301191607080	VOLVO S40 I (VS) 07/1995-12/2003	Steering Tie Rod End - Front
SSP0708	301191607080	VOLVO V40 I (VW) 07/1995-06/2004	Steering Tie Rod End - Front
SSP0709	301191607090	VOLVO S60 I 07/2000-04/2010	Steering Tie Rod End - Front Right Outer
SSP0709	301191607090	VOLVO S80 I (TS,XY) 05/1998-07/2006	Steering Tie Rod End - Front Right Outer
SSP0709	301191607090	VOLVO V70 II (P80) 03/2000-08/2007	Steering Tie Rod End - Front Right Outer
SSP0709	301191607090	VOLVO XC70 II Cross Country 03/2000-08/2007	Steering Tie Rod End - Front Right Outer
SSP0710	301191607100	VOLVO S60 I 07/2000-04/2010	Steering Tie Rod End - Front Left Outer
SSP0710	301191607100	VOLVO S80 I (TS,XY) 05/1998-07/2006	Steering Tie Rod End - Front Left Outer
SSP0710	301191607100	VOLVO V70 II (P80) 03/2000-08/2007	Steering Tie Rod End - Front Left Outer
SSP0710	301191607100	VOLVO XC70 II Cross Country 03/2000-08/2007	Steering Tie Rod End - Front Left Outer
SSP0711	301191607110	VOLVO S80 I (TS,XY) 05/1998-07/2006	Steering Tie Rod End - Front Right
SSP0712	301191607120	VOLVO S80 I (TS,XY) 05/1998-07/2006	Steering Tie Rod End - Front Left
SSP0713	301191607130	VOLVO XC90 I 10/2002-10/2014	Steering Tie Rod End - Front Right
SSP0714	301191607140	VOLVO XC90 I 10/2002-10/2014	Steering Tie Rod End - Front Left
SSP0715	301191607150	VOLVO S60 II 04/2010-	Steering Tie Rod End - Front Right





 SHORT LONG			DESCRIPTION
SSP0715	301191607150	VOLVO S80 II (AS) 03/2006-2016	Steering Tie Rod End - Front Right
SSP0715	301191607150	VOLVO V70 III 08/2007-2016	Steering Tie Rod End - Front Right
SSP0716	301191607160	VOLVO S60 II 04/2010-	Steering Tie Rod End - Front Left
SSP0716	301191607160	VOLVO S80 II (AS) 03/2006-2016	Steering Tie Rod End - Front Left
SSP0716	301191607160	VOLVO V70 III 08/2007-2016	Steering Tie Rod End - Front Left
SSP0717	301191607170	VOLVO V40 II 03/2012-	Steering Tie Rod End - Front Right
SSP0718	301191607180	VOLVO V40 II 03/2012-	Steering Tie Rod End - Front Left
SSP1181	301181311810	ALFA ROMEO 147 937 11/2000-03/2010	Lateral Arm - Rear Center
SSP1181	301181311810	ALFA ROMEO 156 932 09/1997-05/2006	Lateral Arm - Rear Center
SSP1182	301181311820	ALFA ROMEO 147 937 11/2000-03/2010	Lateral Arm - Rear Rearward
SSP1182	301181311820	ALFA ROMEO 156 932 09/1997-05/2006	Lateral Arm - Rear Rearward
SSP1183	301181311830	ALFA ROMEO GIULIETTA 940 04/2010-	Suspension Ball Joint - Front Lower
SSP1184	301181311840	CHRYSLER GRAND VOYAGER III 01/1995-03/2001	Suspension Ball Joint - Front Lower
SSP1184	301181311840	DODGE CARAVAN/G. CARAVAN 1995-2001	Suspension Ball Joint - Front Lower
SSP1184	301181311840	DODGE GRAND VOYAGER III 1995-2001	Suspension Ball Joint - Front Lower
SSP1184	301181311840	PLYMOUTH GRAND VOYAGER 3rd Gen 1995-2001	Suspension Ball Joint - Front Lower
SSP1185	301181311850	CHRYSLER GRAND VOYAGER IV 2000-2008	Suspension Ball Joint - Front Lower
SSP1185	301181311850	CHRYSLER TOWN & COUNTRY IV 2001-2007	Suspension Ball Joint - Front Lower
SSP1185	301181311850	DODGE CARAVAN/G. CARAVAN 1995-2001	Suspension Ball Joint - Front Lower
SSP1186	301181311860	CHRYSLER 200 1st Gen 2011-2014	Suspension Ball Joint - Front Lower
SSP1186	301181311860	DODGE JOURNEY 01/2009-	Suspension Ball Joint - Front Lower
SSP1186	301181311860	FIAT FREEMONT (JC) 08/2011-	Suspension Ball Joint - Front Lower
SSP1187	301181311870	FIAT PANDA 141A 1980-08/2003	Suspension Ball Joint - Front Upper
SSP1187	301181311870	FIAT UNO 146A/E 02/1983-2001	Suspension Ball Joint - Front Upper
SSP1187	301181311870	LANCIA Y 10 1985-1996	Suspension Ball Joint - Front Upper
SSP1187	301181311870	SEAT MARBELLA 1992-1998	Suspension Ball Joint - Front Upper
SSP1188	301181311880	ALFA ROMEO MITO 09/2008-	Suspension Ball Joint - Front
SSP1188	301181311880	CITROEN NEMO 2008-	Suspension Ball Joint - Front
SSP1188	301181311880	FIAT FIORINO 2008-	Suspension Ball Joint - Front
SSP1188	301181311880	FIAT GRANDE PUNTO 199 10/2005-2012	Suspension Ball Joint - Front
SSP1188	301181311880	FIAT LINEA 323 06/2007-2016	Suspension Ball Joint - Front
SSP1188	301181311880	FIAT PUNTO EVO 07/2008-02/2012	Suspension Ball Joint - Front
SSP1188	301181311880	OPEL ADAM 10/2012-	Suspension Ball Joint - Front
SSP1188	301181311880	OPEL CORSA (D) 08/2006-08/2014	Suspension Ball Joint - Front
SSP1188	301181311880	OPEL CORSA (E) 09/2014-	Suspension Ball Joint - Front
SSP1188	301181311880	PEUGEOT BIPPER 02/2008-	Suspension Ball Joint - Front
SSP1189	301181311890	FIAT ALBEA 178 09/1996-05/2013	Suspension Ball Joint - Front Lower
SSP1189	301181311890	FIAT PALIO - SIENA 04/1996-05/2013	Suspension Ball Joint - Front Lower
SSP1191	301181311910	FIAT PALIO - SIENA 04/1996-05/2013	Suspension Ball Joint - Front Lower



 SHORT LONG			DESCRIPTION
SSP1192	301181311920	FIAT BRAVO II 198 04/2007-	Suspension Ball Joint - Front Lower
SSP1192	301181311920	FIAT STILO 192 10/2001-11/2010	Suspension Ball Joint - Front Lower
SSP1192	301181311920	LANCIA DELTA III (844) 09/2008-	Suspension Ball Joint - Front Lower
SSP1193	301181311930	FIAT DOBLO 119 03/2001-01/2010	Suspension Ball Joint - Front Lower
SSP1193	301181311930	FIAT STRADA 178E 1999-2012	Suspension Ball Joint - Front Lower
SSP1194	301181311940	FIAT ALBEA 178 09/1996-05/2013	Suspension Ball Joint - Front
SSP1194	301181311940	FIAT DOBLO 119 03/2001-01/2010	Suspension Ball Joint - Front
SSP1194	301181311940	FIAT PALIO - SIENA 04/1996-05/2013	Suspension Ball Joint - Front
SSP1194	301181311940	FIAT STRADA 178E 1999-2012	Suspension Ball Joint - Front
SSP1195	301181311950	FIAT 500L 09/2012-	Suspension Ball Joint - Front Lower
SSP1195	301181311950	FIAT DOBLO II 152 02/2010-	Suspension Ball Joint - Front Lower
SSP1196	301181311960	CITROEN JUMPER I 03/1994-04/2002	Suspension Ball Joint - Front Lower
SSP1196	301181311960	FIAT DUCATO 10Q-14Q-1.8Q 1994-04/2002	Suspension Ball Joint - Front Lower
SSP1196	301181311960	PEUGEOT BOXER (1.4Q-1.8Q) 04/1994-04/2002	Suspension Ball Joint - Front Lower
SSP1197	301181311970	CITROEN JUMPER I 03/1994-04/2002	Suspension Ball Joint - Front Lower
SSP1197	301181311970	FIAT DUCATO 10Q-14Q-1.8Q 1994-04/2002	Suspension Ball Joint - Front Lower
SSP1197	301181311970	LDV MAXUS 2005-	Suspension Ball Joint - Front Lower
SSP1197	301181311970	PEUGEOT BOXER (1.4Q-1.8Q) 04/1994-04/2002	Suspension Ball Joint - Front Lower
SSP1198	301181311980	CITROEN JUMPER II 05/2002-05/2006	Suspension Ball Joint - Front Lower
SSP1198	301181311980	FIAT DUCATO 14Q-1.8Q 05/2002-05/2006	Suspension Ball Joint - Front Lower
SSP1198	301181311980	PEUGEOT BOXER (1.4Q-1.8Q) 05/2002-05/2005	Suspension Ball Joint - Front Lower
SSP1199	301181311990	CITROEN JUMPER II 05/2002-05/2006	Suspension Ball Joint - Front Lower
SSP1199	301181311990	FIAT DUCATO 14Q-1.8Q 05/2002-05/2006	Suspension Ball Joint - Front Lower
SSP1199	301181311990	PEUGEOT BOXER (1.4Q-1.8Q) 05/2002-05/2005	Suspension Ball Joint - Front Lower
SSP1201	301181312010	CITROEN JUMPER III 06/2006-	Suspension Ball Joint - Front Lower
SSP1201	301181312010	FIAT DUCATO 06/2006-2016	Suspension Ball Joint - Front Lower
SSP1201	301181312010	PEUGEOT BOXER (1.1Q-1.5Q-1.7Q,H-2.0Q) 06/2006-	Suspension Ball Joint - Front Lower
SSP1202	301181312020	IVECO DAILY III 05/1999-05/2006	Suspension Ball Joint - Front
SSP1203	301181312030	IVECO DAILY III 05/1999-05/2006	Suspension Ball Joint - Front Lower
SSP1204	301181312040	IVECO DAILY I-GRINTA 1978-1998	Suspension Ball Joint - Front Lower
SSP1205	301181312050	JEEP CHEROKEE 2nd Gen, XJ 10/1984-03/2001	Suspension Ball Joint - Front Lower
SSP1205	301181312050	JEEP GRAND CHEROKEE I ZJ 09/1991-05/1999	Suspension Ball Joint - Front Lower
SSP1206	301181312060	JEEP CHEROKEE 2nd Gen, XJ 10/1984-03/2001	Suspension Ball Joint - Front Upper
SSP1206	301181312060	JEEP GRAND CHEROKEE I ZJ 09/1991-05/1999	Suspension Ball Joint - Front Upper
SSP1207	301181312070	DODGE NITRO 2007-2012	Suspension Ball Joint - Front Lower





 SHORT LONG			DESCRIPTION
SSP1207	301181312070	JEEP COMMANDER XK 2005-2010	Suspension Ball Joint - Front Lower
SSP1207	301181312070	JEEP GRAND CHEROKEE III WH/WK 06/2005-12/2010	Suspension Ball Joint - Front Lower
SSP1207	301181312070	JEEP LIBERTY KK 2008-2014	Suspension Ball Joint - Front Lower
SSP1208	301181312080	JEEP CHEROKEE KJ 01/2001-01/2008	Suspension Ball Joint - Front Lower
SSP1208	301181312080	JEEP CHEROKEE KK 01/2008-2013	Suspension Ball Joint - Front Lower
SSP1208	301181312080	JEEP LIBERTY KJ 2001-2008	Suspension Ball Joint - Front Lower
SSP1209	301181312090	JEEP CHEROKEE 2nd Gen, XJ 10/1984-03/2001	Suspension Ball Joint - Front Lower
SSP1287	301181312870	ALFA ROMEO 159 939 09/2005-11/2011	Suspension Stabilizer Bar Link - Rear Right
SSP1288	301181312880	ALFA ROMEO 159 939 09/2005-11/2011	Suspension Stabilizer Bar Link - Rear Left
SSP1289	301181312890	ALFA ROMEO 159 939 09/2005-11/2011	Suspension Stabilizer Bar Link - Front Left
SSP1291	301181312910	ALFA ROMEO 159 939 09/2005-11/2011	Suspension Stabilizer Bar Link - Front Right
SSP1292	301181312920	ALFA ROMEO 147 937 11/2000-03/2010	Suspension Stabilizer Bar Link - Front
SSP1292	301181312920	ALFA ROMEO 156 932 09/1997-05/2006	Suspension Stabilizer Bar Link - Front
SSP1292	301181312920	ALFA ROMEO GT 937 11/2003-09/2010	Suspension Stabilizer Bar Link - Front
SSP1293	301181312930	ALFA ROMEO 147 937 11/2000-03/2010	Suspension Stabilizer Bar Link - Rear
SSP1293	301181312930	ALFA ROMEO 156 932 09/1997-05/2006	Suspension Stabilizer Bar Link - Rear
SSP1293	301181312930	ALFA ROMEO GT 937 11/2003-09/2010	Suspension Stabilizer Bar Link - Rear
SSP1294	301181312940	ALFA ROMEO 166 936 09/1998-06/2007	Suspension Stabilizer Bar Link - Front
SSP1295	301181312950	ALFA ROMEO 166 936 09/1998-06/2007	Suspension Stabilizer Bar Link - Rear Right
SSP1296	301181312960	ALFA ROMEO 166 936 09/1998-06/2007	Suspension Stabilizer Bar Link - Rear Left
SSP1297	301181312970	ALFA ROMEO GIULIETTA 940 04/2010-	Suspension Stabilizer Bar Link - Front
SSP1297	301181312970	FIAT 500L 09/2012-	Suspension Stabilizer Bar Link - Front
SSP1298	301181312980	ALFA ROMEO GIULIETTA 940 04/2010-	Suspension Stabilizer Bar Link - Rear Right
SSP1299	301181312990	ALFA ROMEO GIULIETTA 940 04/2010-	Suspension Stabilizer Bar Link - Rear Left
SSP1301	301181313010	CHRYSLER GRAND VOYAGER III 01/1995-03/2001	Suspension Stabilizer Bar Link - Front
SSP1301	301181313010	CHRYSLER GRAND VOYAGER IV 2000-2008	Suspension Stabilizer Bar Link - Front
SSP1301	301181313010	CHRYSLER TOWN & COUNTRY II 1991-1995	Suspension Stabilizer Bar Link - Front
SSP1301	301181313010	CHRYSLER TOWN & COUNTRY III 1995-2001	Suspension Stabilizer Bar Link - Front
SSP1301	301181313010	CHRYSLER TOWN & COUNTRY IV 2001-2007	Suspension Stabilizer Bar Link - Front
SSP1301	301181313010	DODGE CARAVAN/G. CARAVAN 1995-2001	Suspension Stabilizer Bar Link - Front
SSP1301	301181313010	PLYMOUTH GRAND VOYAGER 3rd Gen 1995-2001	Suspension Stabilizer Bar Link - Front
SSP1301	301181313010	PLYMOUTH VOYAGER 3rd Gen 1995-2001	Suspension Stabilizer Bar Link - Front
SSP1302	301181313020	CHRYSLER GRAND VOYAGER III 01/1995-03/2001	Suspension Stabilizer Bar Link - Rear
SSP1302	301181313020	CHRYSLER GRAND VOYAGER IV 2000-2008	Suspension Stabilizer Bar Link - Rear
SSP1302	301181313020	CHRYSLER TOWN & COUNTRY II 1991-1995	Suspension Stabilizer Bar Link - Rear
SSP1302	301181313020	CHRYSLER TOWN & COUNTRY III 1995-2001	Suspension Stabilizer Bar Link - Rear



 SHORT LONG			DESCRIPTION
SSP1302	301181313020	CHRYSLER TOWN & COUNTRY IV 2001-2007	Suspension Stabilizer Bar Link - Rear
SSP1302	301181313020	DODGE CARAVAN/G. CARAVAN 1995-2001	Suspension Stabilizer Bar Link - Rear
SSP1302	301181313020	PLYMOUTH GRAND VOYAGER 3rd Gen 1995-2001	Suspension Stabilizer Bar Link - Rear
SSP1302	301181313020	PLYMOUTH VOYAGER 3rd Gen 1995-2001	Suspension Stabilizer Bar Link - Rear
SSP1304	301181313040	CHRYSLER 300 1st Gen 2005-2010	Suspension Stabilizer Bar Link - Rear
SSP1304	301181313040	DODGE CHALLENGER 4th Gen 2008-	Suspension Stabilizer Bar Link - Rear
SSP1304	301181313040	DODGE CHARGER 6th Gen 2005-2010	Suspension Stabilizer Bar Link - Rear
SSP1304	301181313040	DODGE CHARGER 7th Gen 2011-	Suspension Stabilizer Bar Link - Rear
SSP1305	301181313050	CHRYSLER 300 1st Gen 2005-2010	Suspension Stabilizer Bar Link - Front Right
SSP1305	301181313050	DODGE CHALLENGER 4th Gen 2008-	Suspension Stabilizer Bar Link - Front Right
SSP1305	301181313050	DODGE CHARGER 6th Gen 2005-2010	Suspension Stabilizer Bar Link - Front Right
SSP1305	301181313050	DODGE CHARGER 7th Gen 2011-	Suspension Stabilizer Bar Link - Front Right
SSP1306	301181313060	CHRYSLER 300 1st Gen 2005-2010	Suspension Stabilizer Bar Link - Front Left
SSP1306	301181313060	DODGE CHALLENGER 4th Gen 2008-	Suspension Stabilizer Bar Link - Front Left
SSP1306	301181313060	DODGE CHARGER 6th Gen 2005-2010	Suspension Stabilizer Bar Link - Front Left
SSP1306	301181313060	DODGE CHARGER 7th Gen 2011-	Suspension Stabilizer Bar Link - Front Left
SSP1307	301181313070	DODGE JOURNEY 01/2009-	Suspension Stabilizer Bar Link - Front
SSP1307	301181313070	FIAT FREEMONT (JC) 08/2011-	Suspension Stabilizer Bar Link - Front
SSP1308	301181313080	DODGE JOURNEY 01/2009-	Suspension Stabilizer Bar Link - Rear
SSP1308	301181313080	FIAT FREEMONT (JC) 08/2011-	Suspension Stabilizer Bar Link - Rear
SSP1309	301181313090	FIAT PANDA 169 09/2003-02/2012	Suspension Stabilizer Bar Link - Rear
SSP1311	301181313110	FIAT PANDA 169 09/2003-02/2012	Suspension Stabilizer Bar Link - Front
SSP1312	301181313120	FIAT PANDA 169 09/2003-02/2012	Suspension Stabilizer Bar Link - Front
SSP1313	301181313130	FIAT 500 10/2007-2016	Suspension Stabilizer Bar Link - Front
SSP1313	301181313130	FIAT PANDA 312 02/2012-	Suspension Stabilizer Bar Link - Front
SSP1313	301181313130	FORD KA II 12/2008-	Suspension Stabilizer Bar Link - Front
SSP1313	301181313130	LANCIA YPSILON 312, 846 05/2011-	Suspension Stabilizer Bar Link - Front
SSP1314	301181313140	ALFA ROMEO 145 930 1994-2001	Suspension Stabilizer Bar Link - Front
SSP1314	301181313140	ALFA ROMEO 146 930 1994-2001	Suspension Stabilizer Bar Link - Front
SSP1314	301181313140	ALFA ROMEO 155 167 1992-1998	Suspension Stabilizer Bar Link - Front
SSP1314	301181313140	ALFA ROMEO GTV 167 1992-1998	Suspension Stabilizer Bar Link - Front
SSP1314	301181313140	ALFA ROMEO SPIDER 167 1992-1998	Suspension Stabilizer Bar Link - Front
SSP1314	301181313140	FIAT BRAVO & BRAVA 182 1995-2002	Suspension Stabilizer Bar Link - Front
SSP1314	301181313140	FIAT MAREA 185 06/1996-12/2007	Suspension Stabilizer Bar Link - Front
SSP1314	301181313140	FIAT TEMPRA 1988-1997	Suspension Stabilizer Bar Link - Front
SSP1314	301181313140	FIAT TIPO 1987-2000	Suspension Stabilizer Bar Link - Front
SSP1314	301181313140	LANCIA DEDRA 835 1989-1999	Suspension Stabilizer Bar Link - Front
SSP1315	301181313150	FIAT COUPE FA-175 11/1993-2000	Suspension Stabilizer Bar Link - Front
SSP1315	301181313150	FIAT MAREA 185 06/1996-12/2007	Suspension Stabilizer Bar Link - Front



 SHORT LONG			DESCRIPTION
SSP1315	301181313150	FIAT MULTIPLA 04/1999-12/2010	Suspension Stabilizer Bar Link - Front
SSP1315	301181313150	LANCIA DEDRA 835 1989-1999	Suspension Stabilizer Bar Link - Front
SSP1316	301181313160	ALFA ROMEO MITO 09/2008-	Suspension Stabilizer Bar Link - Front
SSP1316	301181313160	FIAT GRANDE PUNTO 199 10/2005-2012	Suspension Stabilizer Bar Link - Front
SSP1316	301181313160	FIAT PUNTO EVO 07/2008-02/2012	Suspension Stabilizer Bar Link - Front
SSP1316	301181313160	OPEL CORSA (D) 08/2006-08/2014	Suspension Stabilizer Bar Link - Front
SSP1317	301181313170	CITROEN NEMO 2008-	Suspension Stabilizer Bar Link - Front
SSP1317	301181313170	FIAT FIORINO 2008-	Suspension Stabilizer Bar Link - Front
SSP1317	301181313170	FIAT LINEA 323 06/2007-2016	Suspension Stabilizer Bar Link - Front
SSP1317	301181313170	PEUGEOT BIPPER 02/2008-	Suspension Stabilizer Bar Link - Front
SSP1318	301181313180	FIAT BRAVO II 198 04/2007-	Suspension Stabilizer Bar Link - Front
SSP1318	301181313180	FIAT MAREA 185 06/1996-12/2007	Suspension Stabilizer Bar Link - Front
SSP1319	301181313190	LANCIA KAPPA 08/1994-10/2001	Suspension Stabilizer Bar Link - Front
SSP1321	301181313210	FIAT DOBLO 119 03/2001-01/2010	Suspension Stabilizer Bar Link - Rear
SSP1322	301181313220	FIAT DOBLO 119 03/2001-01/2010	Suspension Stabilizer Bar Link - Rear
SSP1323	301181313230	FIAT BRAVO II 198 04/2007-	Suspension Stabilizer Bar Link - Front
SSP1323	301181313230	FIAT STILO 192 10/2001-11/2010	Suspension Stabilizer Bar Link - Front
SSP1323	301181313230	LANCIA DELTA III (844) 09/2008-	Suspension Stabilizer Bar Link - Front
SSP1324	301181313240	FIAT DOBLO II 152 02/2010-	Suspension Stabilizer Bar Link - Rear
SSP1325	301181313250	FIAT DOBLO II 152 02/2010-	Suspension Stabilizer Bar Link - Front
SSP1326	301181313260	CITROEN JUMPY EVANSION 1995-2003	Suspension Stabilizer Bar Link - Front
SSP1326	301181313260	CITROEN JUMPY II 04/2004-12/2006	Suspension Stabilizer Bar Link - Front
SSP1326	301181313260	FIAT SCUDO 02/1996-08/2002	Suspension Stabilizer Bar Link - Front
SSP1326	301181313260	FIAT ULYSSE 121 06/1994-08/2002	Suspension Stabilizer Bar Link - Front
SSP1326	301181313260	LANCIA Z 2004-2010	Suspension Stabilizer Bar Link - Front
SSP1326	301181313260	PEUGEOT 806 06/1994-08/2002	Suspension Stabilizer Bar Link - Front
SSP1326	301181313260	PEUGEOT EXPERT 224 07/1995-12/2006	Suspension Stabilizer Bar Link - Front
SSP1327	301181313270	CITROEN JUMPER I 03/1994-04/2002	Suspension Stabilizer Bar Link - Front
SSP1327	301181313270	FIAT DUCATO 10Q-14Q-1.8Q 1994-04/2002	Suspension Stabilizer Bar Link - Front
SSP1327	301181313270	PEUGEOT BOXER (1.4Q-1.8Q) 04/1994-04/2002	Suspension Stabilizer Bar Link - Front
SSP1328	301181313280	CITROEN JUMPER III 06/2006-	Suspension Stabilizer Bar Link - Front
SSP1328	301181313280	FIAT DUCATO 06/2006-2016	Suspension Stabilizer Bar Link - Front
SSP1328	301181313280	PEUGEOT BOXER (1.1Q-1.5Q-1.7Q,H-2.0Q) 06/2006-	Suspension Stabilizer Bar Link - Front
SSP1329	301181313290	CITROEN JUMPER III 06/2006-	Suspension Stabilizer Bar Link - Rear
SSP1329	301181313290	FIAT DUCATO 06/2006-2016	Suspension Stabilizer Bar Link - Rear
SSP1329	301181313290	PEUGEOT BOXER (1.1Q-1.5Q-1.7Q,H-2.0Q) 06/2006-	Suspension Stabilizer Bar Link - Rear
SSP1331	301181313310	CITROEN JUMPY III 01/2007-	Suspension Stabilizer Bar Link - Front
SSP1331	301181313310	FIAT SCUDO 272 01/2007-	Suspension Stabilizer Bar Link - Front
SSP1331	301181313310	PEUGEOT EXPERT 01/2007-	Suspension Stabilizer Bar Link - Front





 SHORT LONG			DESCRIPTION
SSP1332	301181313320	IVECO DAILY III 05/1999-05/2006	Suspension Stabilizer Bar Link - Front Right
SSP1333	301181313330	IVECO DAILY III 05/1999-05/2006	Suspension Stabilizer Bar Link - Front Left
SSP1334	301181313340	JEEP COMMANDER XK 2005-2010	Suspension Stabilizer Bar Link - Rear
SSP1334	301181313340	JEEP GRAND CHEROKEE III WH/WK 06/2005-12/2010	Suspension Stabilizer Bar Link - Rear
SSP1335	301181313350	JEEP COMMANDER XK 2005-2010	Suspension Stabilizer Bar Link - Front
SSP1335	301181313350	JEEP GRAND CHEROKEE III WH/WK 06/2005-12/2010	Suspension Stabilizer Bar Link - Front
SSP1336	301181313360	JEEP CHEROKEE KJ 01/2001-01/2008	Suspension Stabilizer Bar Link - Front
SSP1336	301181313360	JEEP LIBERTY KJ 2001-2008	Suspension Stabilizer Bar Link - Front
SSP1337	301181313370	JEEP COMPASS MK49 06/2006-2015	Suspension Stabilizer Bar Link - Rear
SSP1338	301181313380	JEEP COMPASS MK49 06/2006-2015	Suspension Stabilizer Bar Link - Front
SSP1339	301181313390	FIAT CROMA 194 1.9DMULTIJET 06/2005- 2011	Suspension Stabilizer Bar Link - Front
SSP1339	301181313390	OPEL SIGNUM 03/2003-08/2008	Suspension Stabilizer Bar Link - Front
SSP1339	301181313390	OPEL VECTRA (C) 08/2002-09/2008	Suspension Stabilizer Bar Link - Front
SSP1339	301181313390	SAAB 9_3 2nd Gen 10/2002-01/2009	Suspension Stabilizer Bar Link - Front
SSP1341	301181313410	CITROEN C8 07/2002-07/2014	Suspension Stabilizer Bar Link - Front
SSP1341	301181313410	FIAT ULYSSE 179AX 09/2002-2011	Suspension Stabilizer Bar Link - Front
SSP1341	301181313410	LANCIA PHEDRA 09/2002-11/2010	Suspension Stabilizer Bar Link - Front
SSP1341	301181313410	PEUGEOT 807 06/2002-08/2014	Suspension Stabilizer Bar Link - Front
SSP1342	301181313420	CHRYSLER 300 1st Gen 2005-2010	Rubber to Metal
SSP1343	301181313430	FIAT SEDICI 06/2006-10/2014	Suspension Stabilizer Bar Link - Front
SSP1343	301181313430	SUZUKI GRAND VITARA 4th Gen 2015-	Suspension Stabilizer Bar Link - Front
SSP1343	301181313430	SUZUKI SWIFT (IV) 10/2010-	Suspension Stabilizer Bar Link - Front
SSP1343	301181313430	SUZUKI SX4 (GY) 06/2006-07/2013	Suspension Stabilizer Bar Link - Front
SSP1344	301181313440	ALFA ROMEO 159 939 09/2005-11/2011	Steering Tie Rod - Front
SSP1345	301181313450	ALFA ROMEO 145 930 1994-2001	Steering Tie Rod - Front Inner
SSP1345	301181313450	ALFA ROMEO 146 930 1994-2001	Steering Tie Rod - Front Inner
SSP1345	301181313450	ALFA ROMEO 155 167 1992-1998	Steering Tie Rod - Front Inner
SSP1345	301181313450	ALFA ROMEO GTV 167 1992-1998	Steering Tie Rod - Front Inner
SSP1345	301181313450	ALFA ROMEO SPIDER 167 1992-1998	Steering Tie Rod - Front Inner
SSP1345	301181313450	LANCIA THEMA 1984-1994	Steering Tie Rod - Front Inner
SSP1346	301181313460	ALFA ROMEO 145 930 1994-2001	Steering Tie Rod - Front Inner
SSP1346	301181313460	ALFA ROMEO 146 930 1994-2001	Steering Tie Rod - Front Inner
SSP1346	301181313460	ALFA ROMEO 155 167 1992-1998	Steering Tie Rod - Front Inner
SSP1346	301181313460	ALFA ROMEO GTV 167 1992-1998	Steering Tie Rod - Front Inner
SSP1346	301181313460	ALFA ROMEO SPIDER 167 1992-1998	Steering Tie Rod - Front Inner
SSP1346	301181313460	FIAT COUPE FA-175 11/1993-2000	Steering Tie Rod - Front Inner
SSP1346	301181313460	LANCIA DELTA II 1993-2000	Steering Tie Rod - Front Inner
SSP1347	301181313470	ALFA ROMEO 147 937 11/2000-03/2010	Steering Tie Rod - Front
SSP1347	301181313470	ALFA ROMEO 156 932 09/1997-05/2006	Steering Tie Rod - Front





 SHORT LONG			DESCRIPTION
SSP1347	301181313470	ALFA ROMEO GT 937 11/2003-09/2010	Steering Tie Rod - Front
SSP1348	301181313480	ALFA ROMEO 166 936 09/1998-06/2007	Steering Tie Rod - Front Inner
SSP1348	301181313480	ALFA ROMEO GT 937 11/2003-09/2010	Steering Tie Rod - Front Inner
SSP1349	301181313490	ALFA ROMEO GIULIETTA 940 04/2010-	Steering Tie Rod - Front
SSP1351	301181313510	CHRYSLER GRAND VOYAGER III 01/1995-03/2001	Steering Tie Rod - Front
SSP1351	301181313510	CHRYSLER GRAND VOYAGER IV 2000-2008	Steering Tie Rod - Front
SSP1352	301181313520	CHRYSLER 300 1st Gen 2005-2010	Steering Tie Rod - Front
SSP1352	301181313520	DODGE CHARGER 6th Gen 2005-2010	Steering Tie Rod - Front
SSP1353	301181313530	FIAT 131 1974-2001	Steering Tie Rod - Front
SSP1353	301181313530	LANCIA DELTA II 1993-2000	Steering Tie Rod - Front
SSP1354	301181313540	FIAT UNO 146A/E 02/1983-2001	Steering Tie Rod - Front
SSP1355	301181313550	FIAT FIORINO NUOVA 1988-1998	Steering Tie Rod - Front
SSP1355	301181313550	FIAT PANDA 141A 1980-08/2003	Steering Tie Rod - Front
SSP1356	301181313560	FIAT PANDA 169 09/2003-02/2012	Steering Tie Rod - Front Inner
SSP1357	301181313570	FIAT PANDA 169 09/2003-02/2012	Steering Tie Rod - Front
SSP1358	301181313580	FIAT CINQUECENTO 1992-1998	Steering Tie Rod - Front
SSP1358	301181313580	FIAT SEICENTO 1998-2007	Steering Tie Rod - Front
SSP1359	301181313590	FIAT 500 10/2007-2016	Steering Tie Rod - Front
SSP1361	301181313610	FIAT BRAVO & BRAVA 182 1995-2002	Steering Tie Rod - Front Inner
SSP1361	301181313610	FIAT REGATA 1983-1991	Steering Tie Rod - Front Inner
SSP1361	301181313610	FIAT RITMO 1984-1988	Steering Tie Rod - Front Inner
SSP1361	301181313610	FIAT TEMPRA 1988-1997	Steering Tie Rod - Front Inner
SSP1361	301181313610	FIAT TIPO 1987-2000	Steering Tie Rod - Front Inner
SSP1361	301181313610	FIAT UNO 146A/E 02/1983-2001	Steering Tie Rod - Front Inner
SSP1361	301181313610	LANCIA DEDRA 835 1989-1999	Steering Tie Rod - Front Inner
SSP1361	301181313610	SEAT IBIZA I 06/1984-12/1993	Steering Tie Rod - Front Inner
SSP1361	301181313610	SEAT IBIZA II 01/1994-08/1999	Steering Tie Rod - Front Inner
SSP1362	301181313620	FIAT BRAVO & BRAVA 182 1995-2002	Steering Tie Rod - Front Inner
SSP1362	301181313620	FIAT CROMA 154 12/1985-12/1996	Steering Tie Rod - Front Inner
SSP1362	301181313620	FIAT TEMPRA 1988-1997	Steering Tie Rod - Front Inner
SSP1362	301181313620	FIAT TIPO 1987-2000	Steering Tie Rod - Front Inner
SSP1362	301181313620	LANCIA DEDRA 835 1989-1999	Steering Tie Rod - Front Inner
SSP1362	301181313620	LANCIA DELTA II 1993-2000	Steering Tie Rod - Front Inner
SSP1363	301181313630	FIAT PUNTO 176 04/1994-09/1999	Steering Tie Rod - Front
SSP1363	301181313630	LANCIA Y 11/1995-09/2003	Steering Tie Rod - Front
SSP1364	301181313640	FIAT BARCHETTA 1995-2005	Steering Tie Rod - Front
SSP1364	301181313640	FIAT PUNTO 176 04/1994-09/1999	Steering Tie Rod - Front
SSP1364	301181313640	LANCIA Y 11/1995-09/2003	Steering Tie Rod - Front
SSP1365	301181313650	CITROEN JUMPY II 04/2004-12/2006	Steering Tie Rod - Front Inner
SSP1365	301181313650	FIAT COUPE FA-175 11/1993-2000	Steering Tie Rod - Front Inner





 SHORT LONG			DESCRIPTION
SSP1365	301181313650	FIAT MAREA 185 06/1996-12/2007	Steering Tie Rod - Front Inner
SSP1365	301181313650	FIAT MULTIPLA 04/1999-12/2010	Steering Tie Rod - Front Inner
SSP1365	301181313650	FIAT SCUDO 02/1996-08/2002	Steering Tie Rod - Front Inner
SSP1365	301181313650	LANCIA Z 2004-2010	Steering Tie Rod - Front Inner
SSP1365	301181313650	PEUGEOT EXPERT 224 07/1995-12/2006	Steering Tie Rod - Front Inner
SSP1366	301181313660	FIAT PUNTO 188 10/1999-10/2009	Steering Tie Rod - Front
SSP1367	301181313670	FIAT GRANDE PUNTO 199 10/2005-2012	Steering Tie Rod - Front
SSP1367	301181313670	FIAT PUNTO EVO 07/2008-02/2012	Steering Tie Rod - Front
SSP1367	301181313670	OPEL ADAM 10/2012-	Steering Tie Rod - Front
SSP1367	301181313670	OPEL CORSA (E) 09/2014-	Steering Tie Rod - Front
SSP1368	301181313680	FIAT LINEA 323 06/2007-2016	Steering Tie Rod - Front
SSP1369	301181313690	CITROEN NEMO 2008-	Steering Tie Rod - Front
SSP1369	301181313690	FIAT FIORINO 2008-	Steering Tie Rod - Front
SSP1369	301181313690	PEUGEOT BIPPER 02/2008-	Steering Tie Rod - Front
SSP1371	301181313710	FIAT ALBEA 178 09/1996-05/2013	Steering Tie Rod - Front
SSP1371	301181313710	FIAT PALIO - SIENA 04/1996-05/2013	Steering Tie Rod - Front
SSP1372	301181313720	FIAT ALBEA 178 09/1996-05/2013	Steering Tie Rod - Front
SSP1372	301181313720	FIAT PALIO - SIENA 04/1996-05/2013	Steering Tie Rod - Front
SSP1373	301181313730	FIAT ALBEA 178 09/1996-05/2013	Steering Tie Rod - Front
SSP1373	301181313730	FIAT PALIO - SIENA 04/1996-05/2013	Steering Tie Rod - Front
SSP1373	301181313730	FIAT STRADA 178E 1999-2012	Steering Tie Rod - Front
SSP1374	301181313740	FIAT DOBLO 119 03/2001-01/2010	Steering Tie Rod - Front
SSP1375	301181313750	FIAT DOBLO 119 03/2001-01/2010	Steering Tie Rod - Front
SSP1376	301181313760	FIAT BRAVO II 198 04/2007-	Steering Tie Rod - Front
SSP1376	301181313760	FIAT STILO 192 10/2001-11/2010	Steering Tie Rod - Front
SSP1376	301181313760	LANCIA DELTA III (844) 09/2008-	Steering Tie Rod - Front
SSP1377	301181313770	FIAT DOBLO II 152 02/2010-	Steering Tie Rod - Front
SSP1378	301181313780	FIAT DOBLO II 152 02/2010-	Steering Tie Rod - Front
SSP1379	301181313790	FIAT 127 PANAROMA 1971-1986	Steering Tie Rod - Front
SSP1379	301181313790	FIAT 128 FAMILIARE 1969-1982	Steering Tie Rod - Front
SSP1379	301181313790	FIAT 128 PANORAMA 1969-1982	Steering Tie Rod - Front
SSP1379	301181313790	FIAT PANDA 141A 1980-08/2003	Steering Tie Rod - Front
SSP1379	301181313790	SEAT MARBELLA 1986-1992	Steering Tie Rod - Front
SSP1381	301181313810	CITROEN JUMPY EVANSION 1995-2003	Steering Tie Rod - Front Inner
SSP1381	301181313810	FIAT ULYSSE 121 06/1994-08/2002	Steering Tie Rod - Front Inner
SSP1381	301181313810	LANCIA LYBRA 07/1999-10/2005	Steering Tie Rod - Front Inner
SSP1381	301181313810	LANCIA Z 1994-2003	Steering Tie Rod - Front Inner
SSP1381	301181313810	PEUGEOT 806 06/1994-08/2002	Steering Tie Rod - Front Inner
SSP1381	301181313810	PEUGEOT EXPERT 224 07/1995-12/2006	Steering Tie Rod - Front Inner
SSP1382	301181313820	CITROEN JUMPER I 03/1994-04/2002	Steering Tie Rod - Front
SSP1382	301181313820	CITROEN JUMPER II 05/2002-05/2006	Steering Tie Rod - Front





 SHORT LONG			DESCRIPTION
SSP1382	301181313820	FIAT DUCATO 10Q-14Q-1.8Q 1994-04/2002	Steering Tie Rod - Front
SSP1382	301181313820	FIAT DUCATO 14Q-1.8Q 05/2002-05/2006	Steering Tie Rod - Front
SSP1382	301181313820	PEUGEOT BOXER (1.4Q-1.8Q) 05/2002-05/2005	Steering Tie Rod - Front
SSP1383	301181313830	CITROEN JUMPER I 03/1994-04/2002	Steering Tie Rod - Front
SSP1383	301181313830	FIAT DUCATO 10Q-14Q-1.8Q 1994-04/2002	Steering Tie Rod - Front
SSP1383	301181313830	PEUGEOT BOXER (1.4Q-1.8Q) 04/1994-04/2002	Steering Tie Rod - Front
SSP1384	301181313840	CITROEN C8 07/2002-07/2014	Steering Tie Rod - Front
SSP1384	301181313840	FIAT ULYSSE 179AX 09/2002-2011	Steering Tie Rod - Front
SSP1384	301181313840	LANCIA PHEDRA 09/2002-11/2010	Steering Tie Rod - Front
SSP1384	301181313840	PEUGEOT 807 06/2002-08/2014	Steering Tie Rod - Front
SSP1385	301181313850	CITROEN JUMPER III 06/2006-	Steering Tie Rod - Front
SSP1385	301181313850	FIAT DUCATO 06/2006-2016	Steering Tie Rod - Front
SSP1385	301181313850	PEUGEOT BOXER (1.1Q-1.5Q-1.7Q,H-2.0Q) 06/2006-	Steering Tie Rod - Front
SSP1386	301181313860	LANCIA YPSILON 843 10/2003-12/2011	Steering Tie Rod - Front
SSP1387	301181313870	CITROEN JUMPY III 01/2007-	Steering Tie Rod - Front
SSP1387	301181313870	FIAT SCUDO 272 01/2007-	Steering Tie Rod - Front
SSP1387	301181313870	PEUGEOT EXPERT 01/2007-	Steering Tie Rod - Front
SSP1388	301181313880	IVECO DAILY III 05/1999-05/2006	Steering Tie Rod - Front
SSP1388	301181313880	IVECO DAILY IV 06/2006-	Steering Tie Rod - Front
SSP1389	301181313890	FIAT IDEA 2003-2012	Steering Tie Rod - Front
SSP1389	301181313890	LANCIA MUSA 350 10/2004-	Steering Tie Rod - Front
SSP1391	301181313910	JEEP COMPASS MK49 06/2006-2015	Steering Tie Rod - Front
SSP1392	301181313920	ALFA ROMEO MITO 09/2008-	Steering Tie Rod - Front
SSP1392	301181313920	OPEL CORSA (D) 08/2006-08/2014	Steering Tie Rod - Front
SSP1393	301181313930	FIAT CROMA 194 1.9DMULTIJET 06/2005-2011	Steering Tie Rod - Front Inner
SSP1393	301181313930	OPEL SIGNUM 03/2003-08/2008	Steering Tie Rod - Front Inner
SSP1393	301181313930	OPEL VECTRA (C) 08/2002-09/2008	Steering Tie Rod - Front Inner
SSP1393	301181313930	SAAB 9_3 2nd Gen 10/2002-01/2009	Steering Tie Rod - Front Inner
SSP1394	301181313940	FIAT SEDICI 06/2006-10/2014	Steering Tie Rod - Right
SSP1394	301181313940	SUZUKI SX4 (GY) 06/2006-07/2013	Steering Tie Rod - Right
SSP1395	301181313950	FIAT SEDICI 06/2006-10/2014	Steering Tie Rod - Left
SSP1395	301181313950	SUZUKI SX4 (GY) 06/2006-07/2013	Steering Tie Rod - Left
SSP1396	301181313960	ALFA ROMEO 159 939 09/2005-11/2011	Steering Tie Rod End - Front Right
SSP1397	301181313970	ALFA ROMEO 159 939 09/2005-11/2011	Steering Tie Rod End - Front Left
SSP1398	301181313980	ALFA ROMEO 155 167 1992-1998	Steering Tie Rod End - Front Right Outer
SSP1398	301181313980	ALFA ROMEO GTV 167 1992-1998	Steering Tie Rod End - Front Right Outer
SSP1398	301181313980	ALFA ROMEO SPIDER 167 1992-1998	Steering Tie Rod End - Front Right Outer
SSP1398	301181313980	FIAT COUPE FA-175 11/1993-2000	Steering Tie Rod End - Front Right Outer





 SHORT LONG			DESCRIPTION
SSP1398	301181313980	LANCIA DELTA II 1993-2000	Steering Tie Rod End - Front Right Outer
SSP1399	301181313990	ALFA ROMEO 155 167 1992-1998	Steering Tie Rod End - Front Left Outer
SSP1399	301181313990	ALFA ROMEO GTV 167 1992-1998	Steering Tie Rod End - Front Left Outer
SSP1399	301181313990	ALFA ROMEO SPIDER 167 1992-1998	Steering Tie Rod End - Front Left Outer
SSP1399	301181313990	FIAT COUPE FA-175 11/1993-2000	Steering Tie Rod End - Front Left Outer
SSP1399	301181313990	LANCIA DELTA II 1993-2000	Steering Tie Rod End - Front Left Outer
SSP1401	301181314010	ALFA ROMEO 147 937 11/2000-03/2010	Steering Tie Rod End - Front Right
SSP1401	301181314010	ALFA ROMEO 156 932 09/1997-05/2006	Steering Tie Rod End - Front Right
SSP1401	301181314010	ALFA ROMEO 166 936 09/1998-06/2007	Steering Tie Rod End - Front Right
SSP1401	301181314010	ALFA ROMEO GT 937 11/2003-09/2010	Steering Tie Rod End - Front Right
SSP1402	301181314020	ALFA ROMEO 147 937 11/2000-03/2010	Steering Tie Rod End - Front Left
SSP1402	301181314020	ALFA ROMEO 156 932 09/1997-05/2006	Steering Tie Rod End - Front Left
SSP1402	301181314020	ALFA ROMEO 166 936 09/1998-06/2007	Steering Tie Rod End - Front Left
SSP1402	301181314020	ALFA ROMEO GT 937 11/2003-09/2010	Steering Tie Rod End - Front Left
SSP1403	301181314030	ALFA ROMEO GIULIETTA 940 04/2010-	Steering Tie Rod End - Front Right
SSP1404	301181314040	ALFA ROMEO GIULIETTA 940 04/2010-	Steering Tie Rod End - Front Left
SSP1405	301181314050	CHRYSLER GRAND VOYAGER III 01/1995-03/2001	Steering Tie Rod End - Front
SSP1405	301181314050	CHRYSLER TOWN & COUNTRY III 1995-2001	Steering Tie Rod End - Front
SSP1405	301181314050	DODGE CARAVAN/G. CARAVAN 1995-2001	Steering Tie Rod End - Front
SSP1405	301181314050	PLYMOUTH GRAND VOYAGER 3rd Gen 1995-2001	Steering Tie Rod End - Front
SSP1405	301181314050	PLYMOUTH VOYAGER 3rd Gen 1995-2001	Steering Tie Rod End - Front
SSP1406	301181314060	CHRYSLER GRAND VOYAGER IV 2000-2008	Steering Tie Rod End - Front
SSP1406	301181314060	CHRYSLER SEBRING JS 3rd Gen 07/2007-12/2010	Steering Tie Rod End - Front
SSP1406	301181314060	DODGE JOURNEY 01/2009-	Steering Tie Rod End - Front
SSP1406	301181314060	FIAT FREEMONT (JC) 08/2011-	Steering Tie Rod End - Front
SSP1406	301181314060	JEEP COMPASS MK49 06/2006-2015	Steering Tie Rod End - Front
SSP1407	301181314070	CHRYSLER PT CRUISER 06/2000-12/2010	Steering Tie Rod End - Front
SSP1407	301181314070	DODGE NEON 2003-2005	Steering Tie Rod End - Front
SSP1408	301181314080	CHRYSLER 300 1st Gen 2005-2010	Steering Tie Rod End - Front Outer
SSP1408	301181314080	DODGE CHALLENGER 4th Gen 2008-	Steering Tie Rod End - Front Outer
SSP1408	301181314080	DODGE CHARGER 6th Gen 2005-2010	Steering Tie Rod End - Front Outer
SSP1408	301181314080	DODGE DAKOTA RWD 2000-2003	Steering Tie Rod End - Front Outer
SSP1408	301181314080	MINI COOPER S 55 01/2006-01/2010	Steering Tie Rod End - Front Outer
SSP1408	301181314080	MITSUBISHI RAIDER 2006-2009	Steering Tie Rod End - Front Outer
SSP1409	301181314090	FIAT 127 PANAROMA 1971-1986	Steering Tie Rod End - Front
SSP1409	301181314090	FIAT UNO 146A/E 02/1983-2001	Steering Tie Rod End - Front
SSP1411	301181314110	FIAT PANDA 141A 1980-08/2003	Steering Tie Rod End - Front
SSP1411	301181314110	LANCIA Y 10 1985-1996	Steering Tie Rod End - Front
SSP1411	301181314110	SEAT MARBELLA 1992-1998	Steering Tie Rod End - Front



 SHORT LONG			DESCRIPTION
SSP1412	301181314120	FIAT 500 10/2007-2016	Steering Tie Rod End - Front Right
SSP1412	301181314120	FIAT PANDA 169 09/2003-02/2012	Steering Tie Rod End - Front Right
SSP1412	301181314120	FORD KA II 12/2008-	Steering Tie Rod End - Front Right
SSP1413	301181314130	FIAT 500 10/2007-2016	Steering Tie Rod End - Front Left
SSP1413	301181314130	FIAT PANDA 169 09/2003-02/2012	Steering Tie Rod End - Front Left
SSP1413	301181314130	FORD KA II 12/2008-	Steering Tie Rod End - Front Left
SSP1414	301181314140	ALFA ROMEO 145 930 1994-2001	Steering Tie Rod End - Front Right
SSP1414	301181314140	ALFA ROMEO 146 930 1994-2001	Steering Tie Rod End - Front Right
SSP1414	301181314140	FIAT BRAVO & BRAVA 182 1995-2002	Steering Tie Rod End - Front Right
SSP1414	301181314140	FIAT COUPE FA-175 11/1993-2000	Steering Tie Rod End - Front Right
SSP1414	301181314140	FIAT TEMPRA 1988-1997	Steering Tie Rod End - Front Right
SSP1414	301181314140	FIAT TIPO 1987-2000	Steering Tie Rod End - Front Right
SSP1414	301181314140	LANCIA DEDRA 835 1989-1999	Steering Tie Rod End - Front Right
SSP1414	301181314140	LANCIA DELTA II 1993-2000	Steering Tie Rod End - Front Right
SSP1415	301181314150	ALFA ROMEO 145 930 1994-2001	Steering Tie Rod End - Front Left
SSP1415	301181314150	ALFA ROMEO 146 930 1994-2001	Steering Tie Rod End - Front Left
SSP1415	301181314150	FIAT BRAVO & BRAVA 182 1995-2002	Steering Tie Rod End - Front Left
SSP1415	301181314150	FIAT COUPE FA-175 11/1993-2000	Steering Tie Rod End - Front Left
SSP1415	301181314150	FIAT TEMPRA 1988-1997	Steering Tie Rod End - Front Left
SSP1415	301181314150	FIAT TIPO 1987-2000	Steering Tie Rod End - Front Left
SSP1415	301181314150	LANCIA DEDRA 835 1989-1999	Steering Tie Rod End - Front Left
SSP1415	301181314150	LANCIA DELTA II 1993-2000	Steering Tie Rod End - Front Left
SSP1416	301181314160	FIAT BARCHETTA 1995-2005	Steering Tie Rod End - Front
SSP1416	301181314160	FIAT PUNTO 176 04/1994-09/1999	Steering Tie Rod End - Front
SSP1416	301181314160	FIAT PUNTO 188 10/1999-10/2009	Steering Tie Rod End - Front
SSP1416	301181314160	LANCIA Y 11/1995-09/2003	Steering Tie Rod End - Front
SSP1417	301181314170	FIAT COUPE FA-175 11/1993-2000	Steering Tie Rod End - Front
SSP1417	301181314170	FIAT DOBLO 119 03/2001-01/2010	Steering Tie Rod End - Front
SSP1417	301181314170	FIAT MAREA 185 06/1996-12/2007	Steering Tie Rod End - Front
SSP1417	301181314170	FIAT MULTIPLA 04/1999-12/2010	Steering Tie Rod End - Front
SSP1418	301181314180	ALFA ROMEO 145 930 1994-2001	Steering Tie Rod End - Front
SSP1418	301181314180	ALFA ROMEO 146 930 1994-2001	Steering Tie Rod End - Front
SSP1418	301181314180	FIAT MAREA 185 06/1996-12/2007	Steering Tie Rod End - Front
SSP1418	301181314180	LANCIA LYBRA 07/1999-10/2005	Steering Tie Rod End - Front
SSP1419	301181314190	ALFA ROMEO MITO 09/2008-	Steering Tie Rod End - Front Right
SSP1419	301181314190	FIAT GRANDE PUNTO 199 10/2005-2012	Steering Tie Rod End - Front Right
SSP1419	301181314190	FIAT PUNTO EVO 07/2008-02/2012	Steering Tie Rod End - Front Right
SSP1419	301181314190	OPEL ADAM 10/2012-	Steering Tie Rod End - Front Right
SSP1419	301181314190	OPEL CORSA (D) 08/2006-08/2014	Steering Tie Rod End - Front Right
SSP1419	301181314190	OPEL CORSA (E) 09/2014-	Steering Tie Rod End - Front Right
SSP1421	301181314210	ALFA ROMEO MITO 09/2008-	Steering Tie Rod End - Front Left



 SHORT LONG			DESCRIPTION
SSP1421	301181314210	FIAT GRANDE PUNTO 199 10/2005-2012	Steering Tie Rod End - Front Left
SSP1421	301181314210	FIAT PUNTO EVO 07/2008-02/2012	Steering Tie Rod End - Front Left
SSP1421	301181314210	OPEL ADAM 10/2012-	Steering Tie Rod End - Front Left
SSP1421	301181314210	OPEL CORSA (D) 08/2006-08/2014	Steering Tie Rod End - Front Left
SSP1421	301181314210	OPEL CORSA (E) 09/2014-	Steering Tie Rod End - Front Left
SSP1422	301181314220	CITROEN NEMO 2008-	Steering Tie Rod End - Front Right
SSP1422	301181314220	FIAT FIORINO 2008-	Steering Tie Rod End - Front Right
SSP1422	301181314220	FIAT LINEA 323 06/2007-2016	Steering Tie Rod End - Front Right
SSP1422	301181314220	PEUGEOT BIPPER 02/2008-	Steering Tie Rod End - Front Right
SSP1423	301181314230	CITROEN NEMO 2008-	Steering Tie Rod End - Front Left
SSP1423	301181314230	FIAT FIORINO 2008-	Steering Tie Rod End - Front Left
SSP1423	301181314230	FIAT LINEA 323 06/2007-2016	Steering Tie Rod End - Front Left
SSP1423	301181314230	PEUGEOT BIPPER 02/2008-	Steering Tie Rod End - Front Left
SSP1424	301181314240	FIAT ALBEA 178 09/1996-05/2013	Steering Tie Rod End - Front Right
SSP1424	301181314240	FIAT DOBLO 119 03/2001-01/2010	Steering Tie Rod End - Front Right
SSP1424	301181314240	FIAT PALIO - SIENA 04/1996-05/2013	Steering Tie Rod End - Front Right
SSP1424	301181314240	FIAT STRADA 178E 1999-2012	Steering Tie Rod End - Front Right
SSP1425	301181314250	FIAT ALBEA 178 09/1996-05/2013	Steering Tie Rod End - Front Left
SSP1425	301181314250	FIAT DOBLO 119 03/2001-01/2010	Steering Tie Rod End - Front Left
SSP1425	301181314250	FIAT PALIO - SIENA 04/1996-05/2013	Steering Tie Rod End - Front Left
SSP1425	301181314250	FIAT STRADA 178E 1999-2012	Steering Tie Rod End - Front Left
SSP1426	301181314260	FIAT BRAVO II 198 04/2007-	Steering Tie Rod End - Front
SSP1426	301181314260	FIAT STILO 192 10/2001-11/2010	Steering Tie Rod End - Front
SSP1426	301181314260	LANCIA DELTA III (844) 09/2008-	Steering Tie Rod End - Front
SSP1427	301181314270	FIAT DOBLO II 152 02/2010-	Steering Tie Rod End - Front Right
SSP1428	301181314280	FIAT DOBLO II 152 02/2010-	Steering Tie Rod End - Front Left
SSP1429	301181314290	CITROEN JUMPY EVANSION 1995-2003	Steering Tie Rod End - Front Outer
SSP1429	301181314290	CITROEN JUMPY II 04/2004-12/2006	Steering Tie Rod End - Front Outer
SSP1429	301181314290	FIAT ULYSSE 121 06/1994-08/2002	Steering Tie Rod End - Front Outer
SSP1429	301181314290	LANCIA Z 1994-2003	Steering Tie Rod End - Front Outer
SSP1429	301181314290	PEUGEOT 806 06/1994-08/2002	Steering Tie Rod End - Front Outer
SSP1429	301181314290	PEUGEOT EXPERT 224 07/1995-12/2006	Steering Tie Rod End - Front Outer
SSP1431	301181314310	CITROEN JUMPER I 03/1994-04/2002	Steering Tie Rod End - Front
SSP1431	301181314310	FIAT DUCATO 10Q-14Q-1.8Q 1994-04/2002	Steering Tie Rod End - Front
SSP1431	301181314310	PEUGEOT BOXER (1.4Q-1.8Q) 04/1994-04/2002	Steering Tie Rod End - Front
SSP1432	301181314320	CITROEN C8 07/2002-07/2014	Steering Tie Rod End - Front Outer
SSP1432	301181314320	FIAT SCUDO 02/1996-08/2002	Steering Tie Rod End - Front Outer
SSP1432	301181314320	FIAT ULYSSE 179AX 09/2002-2011	Steering Tie Rod End - Front Outer
SSP1432	301181314320	LANCIA PHEDRA 09/2002-11/2010	Steering Tie Rod End - Front Outer
SSP1432	301181314320	PEUGEOT 807 06/2002-08/2014	Steering Tie Rod End - Front Outer





 SHORT LONG			DESCRIPTION
SSP1432	301181314320	PEUGEOT EXPERT 224 07/1995-12/2006	Steering Tie Rod End - Front Outer
SSP1433	301181314330	CITROEN JUMPER III 06/2006-	Steering Tie Rod End - Front Right
SSP1433	301181314330	FIAT DUCATO 06/2006-2016	Steering Tie Rod End - Front Right
SSP1433	301181314330	PEUGEOT BOXER (1.1Q-1.5Q-1.7Q,H-2.0Q) 06/2006-	Steering Tie Rod End - Front Right
SSP1434	301181314340	CITROEN JUMPER III 06/2006-	Steering Tie Rod End - Front Left
SSP1434	301181314340	FIAT DUCATO 06/2006-2016	Steering Tie Rod End - Front Left
SSP1434	301181314340	PEUGEOT BOXER (1.1Q-1.5Q-1.7Q,H-2.0Q) 06/2006-	Steering Tie Rod End - Front Left
SSP1435	301181314350	LANCIA YPSILON 843 10/2003-12/2011	Steering Tie Rod End - Front
SSP1436	301181314360	CITROEN JUMPY III 01/2007-	Steering Tie Rod End - Front
SSP1436	301181314360	FIAT SCUDO 272 01/2007-	Steering Tie Rod End - Front
SSP1436	301181314360	PEUGEOT EXPERT 01/2007-	Steering Tie Rod End - Front
SSP1437	301181314370	FIAT CINQUECENTO 1992-1998	Steering Tie Rod End - Front
SSP1437	301181314370	FIAT REGATA 1983-1991	Steering Tie Rod End - Front
SSP1437	301181314370	FIAT RITMO 1984-1988	Steering Tie Rod End - Front
SSP1437	301181314370	FIAT SEICENTO 1998-2007	Steering Tie Rod End - Front
SSP1437	301181314370	SEAT IBIZA I 06/1984-12/1993	Steering Tie Rod End - Front
SSP1437	301181314370	SEAT IBIZA II 01/1994-08/1999	Steering Tie Rod End - Front
SSP1437	301181314370	SEAT RONDA 1982-1988	Steering Tie Rod End - Front
SSP1437	301181314370	SEAT TERRA 1984-1990	Steering Tie Rod End - Front
SSP1438	301181314380	IVECO DAILY III 05/1999-05/2006	Steering Tie Rod End - Front
SSP1438	301181314380	IVECO DAILY IV 06/2006-	Steering Tie Rod End - Front
SSP1439	301181314390	FIAT IDEA 2003-2012	Steering Tie Rod End - Front
SSP1439	301181314390	LANCIA MUSA 350 10/2004-	Steering Tie Rod End - Front
SSP1441	301181314410	JEEP CHEROKEE XJ 1991-1999	Steering Tie Rod End - Front Left
SSP1441	301181314410	JEEP GRAND CHEROKEE I ZJ 09/1991-05/1999	Steering Tie Rod End - Front Left
SSP1442	301181314420	JEEP CHEROKEE KJ 01/2001-01/2008	Steering Tie Rod End - Front Right Outer
SSP1443	301181314430	JEEP CHEROKEE KJ 01/2001-01/2008	Steering Tie Rod End - Front Left
SSP1444	301181314440	JEEP COMMANDER XK 2005-2010	Steering Tie Rod End - Front Right
SSP1444	301181314440	JEEP GRAND CHEROKEE III WH/WK 06/2005-12/2010	Steering Tie Rod End - Front Right
SSP1445	301181314450	JEEP COMMANDER XK 2005-2010	Steering Tie Rod End - Front Left
SSP1445	301181314450	JEEP GRAND CHEROKEE III WH/WK 06/2005-12/2010	Steering Tie Rod End - Front Left
SSP1446	301181314460	JEEP CHEROKEE KJ 01/2001-01/2008	Steering Tie Rod End - Front Right Outer
SSP1446	301181314460	JEEP LIBERTY KJ 2001-2008	Steering Tie Rod End - Front Right Outer
SSP1447	301181314470	JEEP CHEROKEE KJ 01/2001-01/2008	Steering Tie Rod End - Front Left Outer
SSP1447	301181314470	JEEP CHEROKEE KK 01/2008-2013	Steering Tie Rod End - Front Left Outer
SSP1447	301181314470	JEEP LIBERTY KJ 2001-2008	Steering Tie Rod End - Front Left Outer
SSP1448	301181314480	FIAT CROMA 194 1.9DMULTIJET 06/2005-2011	Steering Tie Rod End - Front Right



			DESCRIPTION
SHORT	LONG		
SSP1448	301181314480	OPEL SIGNUM 03/2003-08/2008	Steering Tie Rod End - Front Right
SSP1448	301181314480	OPEL VECTRA (C) 08/2002-09/2008	Steering Tie Rod End - Front Right
SSP1448	301181314480	SAAB 9_3 2nd Gen 10/2002-01/2009	Steering Tie Rod End - Front Right
SSP1448	301181314480	SAAB 9_5 1st Gen YS3E 07/2002-04/2010	Steering Tie Rod End - Front Right
SSP1448	301181314480	VAUXHALL VECTRA C 2002-	Steering Tie Rod End - Front Right
SSP1449	301181314490	FIAT CROMA 194 1.9DMULTIJET 06/2005-2011	Steering Tie Rod End - Front Left
SSP1449	301181314490	OPEL SIGNUM 03/2003-08/2008	Steering Tie Rod End - Front Left
SSP1449	301181314490	OPEL VECTRA (C) 08/2002-09/2008	Steering Tie Rod End - Front Left
SSP1449	301181314490	SAAB 9_3 2nd Gen 10/2002-01/2009	Steering Tie Rod End - Front Left
SSP1449	301181314490	SAAB 9_5 1st Gen YS3E 07/2002-04/2010	Steering Tie Rod End - Front Left
SSP1449	301181314490	VAUXHALL VECTRA C 2002-	Steering Tie Rod End - Front Left
SSP1451	301181314510	CITROEN JUMPER II 05/2002-05/2006	Steering Tie Rod End - Front
SSP1451	301181314510	FIAT DUCATO 14Q-1.8Q 05/2002-05/2006	Steering Tie Rod End - Front
SSP1451	301181314510	PEUGEOT BOXER (1.4Q-1.8Q) 05/2002-05/2005	Steering Tie Rod End - Front
SSP1452	301181314520	FIAT SEDICI 06/2006-10/2014	Steering Tie Rod End - Front
SSP1452	301181314520	SUZUKI S-CROSS (GY) 2013-	Steering Tie Rod End - Front
SSP1773	301191617730	AUDI 80 1992-1994	Suspension Ball Joint - Front Left Lower
SSP1773	301191617730	AUDI 90 1992-1994	Suspension Ball Joint - Front Left Lower
SSP1773	301191617730	AUDI CABRIOLET 1991-2000	Suspension Ball Joint - Front Left Lower
SSP1773	301191617730	AUDI COUPE 1982-1988	Suspension Ball Joint - Front Left Lower
SSP1773	301191617730	AUDI COUPE 1988-1996	Suspension Ball Joint - Front Left Lower
SSP1773	301191617730	AUDI COUPE QUATTRO 1988-1995	Suspension Ball Joint - Front Left Lower
SSP1774	301191617740	AUDI 80 1992-1994	Suspension Ball Joint - Front Right Lower
SSP1774	301191617740	AUDI 90 1992-1994	Suspension Ball Joint - Front Right Lower
SSP1774	301191617740	AUDI CABRIOLET 1991-2000	Suspension Ball Joint - Front Right Lower
SSP1774	301191617740	AUDI COUPE 1982-1988	Suspension Ball Joint - Front Right Lower
SSP1774	301191617740	AUDI COUPE 1988-1996	Suspension Ball Joint - Front Right Lower
SSP1774	301191617740	AUDI COUPE QUATTRO 1988-1995	Suspension Ball Joint - Front Right Lower
SSP1775	301191617750	AUDI A3 8L1 09/1996-05/2003	Suspension Ball Joint - Front Lower
SSP1775	301191617750	AUDI TT 8N3, ROADSTER, 8N9 02/1999-06/2006	Suspension Ball Joint - Front Lower
SSP1775	301191617750	SEAT LEON 1M1 03/1999-05/2006	Suspension Ball Joint - Front Lower
SSP1775	301191617750	SEAT TOLEDO II (1M2) 03/1999-05/2006	Suspension Ball Joint - Front Lower
SSP1775	301191617750	VOLKSWAGEN BEETLE 9C1, 1C1 1998-2010	Suspension Ball Joint - Front Lower
SSP1775	301191617750	VOLKSWAGEN GOLF MK4/A4 1998-09/2003	Suspension Ball Joint - Front Lower
SSP1775	301191617750	VOLKSWAGEN JETTA MK4/A4 1998-09/2003	Suspension Ball Joint - Front Lower
SSP1776	301191617760	AUDI A3 8L1 09/1996-05/2003	Suspension Ball Joint - Front Right Lower
SSP1776	301191617760	SEAT LEON 1M1 03/1999-05/2006	Suspension Ball Joint - Front Right Lower
SSP1776	301191617760	SEAT TOLEDO II (1M2) 03/1999-05/2006	Suspension Ball Joint - Front Right Lower



 SHORT LONG			DESCRIPTION
SSP1776	301191617760	SKODA OCTAVIA (1U2), (1U5) 07/1996-05/2004	Suspension Ball Joint - Front Right Lower
SSP1776	301191617760	VOLKSWAGEN BEETLE 9C1, 1C1 1998-2010	Suspension Ball Joint - Front Right Lower
SSP1776	301191617760	VOLKSWAGEN GOLF MK4/A4 1998-09/2003	Suspension Ball Joint - Front Right Lower
SSP1776	301191617760	VOLKSWAGEN JETTA MK4/A4 1998-09/2003	Suspension Ball Joint - Front Right Lower
SSP1777	301191617770	AUDI A3 8L1 09/1996-05/2003	Suspension Ball Joint - Front Right Lower
SSP1777	301191617770	SEAT LEON 1M1 03/1999-05/2006	Suspension Ball Joint - Front Right Lower
SSP1777	301191617770	SEAT TOLEDO II (1M2) 03/1999-05/2006	Suspension Ball Joint - Front Right Lower
SSP1777	301191617770	SKODA OCTAVIA (1U2), (1U5) 07/1996-05/2004	Suspension Ball Joint - Front Right Lower
SSP1777	301191617770	VOLKSWAGEN BEETLE 9C1, 1C1 1998-2010	Suspension Ball Joint - Front Right Lower
SSP1777	301191617770	VOLKSWAGEN GOLF MK4/A4 1998-09/2003	Suspension Ball Joint - Front Right Lower
SSP1777	301191617770	VOLKSWAGEN JETTA MK4/A4 1998-09/2003	Suspension Ball Joint - Front Right Lower
SSP1778	301191617780	AUDI A3 8L1 09/1996-05/2003	Suspension Ball Joint - Front Left Lower
SSP1778	301191617780	SEAT LEON 1M1 03/1999-05/2006	Suspension Ball Joint - Front Left Lower
SSP1778	301191617780	SEAT TOLEDO II (1M2) 03/1999-05/2006	Suspension Ball Joint - Front Left Lower
SSP1778	301191617780	SKODA OCTAVIA (1U2), (1U5) 07/1996-05/2004	Suspension Ball Joint - Front Left Lower
SSP1778	301191617780	VOLKSWAGEN BEETLE 9C1, 1C1 1998-2010	Suspension Ball Joint - Front Left Lower
SSP1778	301191617780	VOLKSWAGEN GOLF MK4/A4 1998-09/2003	Suspension Ball Joint - Front Left Lower
SSP1778	301191617780	VOLKSWAGEN JETTA MK4/A4 1998-09/2003	Suspension Ball Joint - Front Left Lower
SSP1779	301191617790	AUDI A3 8L1 09/1996-05/2003	Suspension Ball Joint - Front Left Lower
SSP1779	301191617790	SEAT LEON 1M1 03/1999-05/2006	Suspension Ball Joint - Front Left Lower
SSP1779	301191617790	SEAT TOLEDO II (1M2) 03/1999-05/2006	Suspension Ball Joint - Front Left Lower
SSP1779	301191617790	SKODA OCTAVIA (1U2), (1U5) 07/1996-05/2004	Suspension Ball Joint - Front Left Lower
SSP1779	301191617790	VOLKSWAGEN BEETLE 9C1, 1C1 1998-2010	Suspension Ball Joint - Front Left Lower
SSP1779	301191617790	VOLKSWAGEN GOLF MK4/A4 1998-09/2003	Suspension Ball Joint - Front Left Lower
SSP1779	301191617790	VOLKSWAGEN JETTA MK4/A4 1998-09/2003	Suspension Ball Joint - Front Left Lower
SSP1780	301191617800	AUDI A4 8K2, 8K5 11/2007-06/2015	Suspension Ball Joint - Front Lower
SSP1780	301191617800	AUDI A5 8T3 2007-2015	Suspension Ball Joint - Front Lower
SSP1780	301191617800	AUDI A7 4 GA Sportback 10/2010-	Suspension Ball Joint - Front Lower
SSP1780	301191617800	AUDI Q5 8R 11/2008-2016	Suspension Ball Joint - Front Lower
SSP1781	301191617810	AUDI TT 8J3 07/2006-06/2014	Suspension Ball Joint - Front Right Lower
SSP1781	301191617810	AUDI TT FV3 2014-	Suspension Ball Joint - Front Right Lower
SSP1782	301191617820	AUDI TT 8J3 07/2006-06/2014	Suspension Ball Joint - Front Left Lower
SSP1782	301191617820	AUDI TT FV3 2014-	Suspension Ball Joint - Front Left Lower
SSP1783	301191617830	AUDI A4 8K2, 8K5 11/2007-06/2015	Suspension Ball Joint - Front Lower
SSP1783	301191617830	AUDI A5 8T3 2007-2015	Suspension Ball Joint - Front Lower
SSP1783	301191617830	AUDI A6 4G2, C5 04/2011-	Suspension Ball Joint - Front Lower
SSP1783	301191617830	AUDI Q5 8R 11/2008-2016	Suspension Ball Joint - Front Lower
SSP1784	301191617840	AUDI A8 4H 08/2010-	Suspension Ball Joint - Front Lower



 SHORT LONG			DESCRIPTION
SSP1785	301191617850	BMW 325xi E90/E91/E92/E93 (xDrive) 4x4 01/2005-12/2011	Suspension Ball Joint - Front Lower
SSP1785	301191617850	BMW 328i xDrive E90/E91/E92/E93 (xDrive) 4x4 01/2005-12/2011	Suspension Ball Joint - Front Lower
SSP1785	301191617850	BMW 328xi E90/E91/E92/E93 (xDrive) 4x4 01/2005-12/2011	Suspension Ball Joint - Front Lower
SSP1785	301191617850	BMW 330xi E90/E91/E92/E93 (xDrive) 4x4 01/2005-12/2011	Suspension Ball Joint - Front Lower
SSP1785	301191617850	BMW 335i xDrive E90/E91/E92/E93 (xDrive) 4x4 01/2005-12/2011	Suspension Ball Joint - Front Lower
SSP1785	301191617850	BMW 335xi E90/E91/E92/E93 (xDrive) 4x4 01/2005-12/2011	Suspension Ball Joint - Front Lower
SSP1786	301191617860	BMW X5 E53 05/2000-01/2007	Suspension Ball Joint - Front Lower
SSP1787	301191617870	BMW X3 E83 01/2004-08/2010	Suspension Ball Joint - Front Lower
SSP1788	301191617880	BMW X3 E83 01/2004-08/2010	Suspension Ball Joint - Front Lower Forward
SSP1789	301191617890	BMW X3 F25 09/2010-2016	Suspension Ball Joint - Front Lower
SSP1789	301191617890	BMW X4 F26 04/2014-	Suspension Ball Joint - Front Lower
SSP1790	301191617900	BMW 740i F01, F02, F03,F04 06/2008-2016	Suspension Ball Joint - Front Lower
SSP1790	301191617900	BMW 740Li F01, F02, F03,F04 06/2008-2016	Suspension Ball Joint - Front Lower
SSP1790	301191617900	BMW 750i F01, F02, F03,F04 06/2008-2016	Suspension Ball Joint - Front Lower
SSP1790	301191617900	BMW 750Li F01, F02, F03,F04 06/2008-2016	Suspension Ball Joint - Front Lower
SSP1790	301191617900	BMW 760Li F01, F02, F03,F04 06/2008-2016	Suspension Ball Joint - Front Lower
SSP1791	301191617910	BMW 525xi E60 - E61, AWD 07/2003-03/2010	Suspension Ball Joint - Front
SSP1791	301191617910	BMW 528i E60 - E61 07/2003-03/2010	Suspension Ball Joint - Front
SSP1791	301191617910	BMW 528i xDrive E60 - E61, AWD 07/2003- 03/2010	Suspension Ball Joint - Front
SSP1791	301191617910	BMW 528xi E60 - E61, AWD 07/2003-03/2010	Suspension Ball Joint - Front
SSP1791	301191617910	BMW 530i E60 - E61 07/2003-03/2010	Suspension Ball Joint - Front
SSP1791	301191617910	BMW 530xi E60 - E61, AWD 07/2003-03/2010	Suspension Ball Joint - Front
SSP1791	301191617910	BMW 535i E60 - E61 07/2003-03/2010	Suspension Ball Joint - Front
SSP1791	301191617910	BMW 535i xDrive E60 - E61, AWD 07/2003- 03/2010	Suspension Ball Joint - Front
SSP1791	301191617910	BMW 535xi E60 - E61, AWD 07/2003-03/2010	Suspension Ball Joint - Front
SSP1791	301191617910	BMW 545i E60 - E61 07/2003-03/2010	Suspension Ball Joint - Front
SSP1791	301191617910	BMW 550i E60 - E61 07/2003-03/2010	Suspension Ball Joint - Front
SSP1792	301191617920	BUICK LACROSSE 2nd Gen 2010-2016	Suspension Ball Joint - Front Upper
SSP1792	301191617920	BUICK REGAL 5th Gen 2011-2016	Suspension Ball Joint - Front Upper
SSP1792	301191617920	OPEL ASTRA GTC (J) 2011-	Suspension Ball Joint - Front Upper
SSP1792	301191617920	OPEL INSIGNIA 1st Gen 07/2008-2017	Suspension Ball Joint - Front Upper
SSP1793	301191617930	CADILLAC ESCALADE 2nd Gen (GMT 800) 2001-2006	Suspension Ball Joint - Front Upper
SSP1793	301191617930	CHEVROLET SILVERADO 1500 1st Gen, GMT800 1999-2006	Suspension Ball Joint - Front Upper
SSP1793	301191617930	CHEVROLET TAHOE 2nd Gen, GMT800 2000-2006	Suspension Ball Joint - Front Upper





 SHORT LONG			DESCRIPTION
SSP1793	301191617930	GMC YUKON 2nd Gen GMT800 2000-2006	Suspension Ball Joint - Front Upper
SSP1794	301191617940	CHEVROLET EVANDA V200 03/2003-09/2006	Suspension Ball Joint - Front
SSP1795	301191617950	CHEVROLET EPICA V250 01/2005-03/2011	Suspension Ball Joint - Front
SSP1796	301191617960	BUICK RAINIER 1st Gen 2003-2007	Suspension Ball Joint - Front Lower
SSP1796	301191617960	CHEVROLET TRAILBLAZER 1st Gen 2002-2008	Suspension Ball Joint - Front Lower
SSP1796	301191617960	SAAB 9_7X 2005-2009	Suspension Ball Joint - Front Lower
SSP1797	301191617970	CHEVROLET TRAILBLAZER 1st Gen 2002-2008	Suspension Ball Joint - Front Upper
SSP1798	301191617980	CHEVROLET AVEO T250 05/2005-02/2011	Suspension Ball Joint - Front Lower
SSP1798	301191617980	DAEWOO KALOS (KLAS) 09/2002-03/2011	Suspension Ball Joint - Front Lower
SSP1798	301191617980	PONTIAC G3 2007-2009	Suspension Ball Joint - Front Lower
SSP1799	301191617990	CHEVROLET EQUINOX 2nd Gen 2010-2016	Suspension Ball Joint - Front Lower
SSP1799	301191617990	GMC TERRAIN 2010-	Suspension Ball Joint - Front Lower
SSP1800	301191618000	BUICK ENCORE 2012-2016	Suspension Ball Joint - Front Lower
SSP1800	301191618000	CHEVROLET AVEO T300 03/2011-2016	Suspension Ball Joint - Front Lower
SSP1800	301191618000	CHEVROLET TRAX 2014 -	Suspension Ball Joint - Front Lower
SSP1800	301191618000	OPEL MOKKA 06/2012-	Suspension Ball Joint - Front Lower
SSP1801	301191618010	CHEVROLET LACETTI J200 (OPTRA) 03/2003-04/2012	Suspension Ball Joint - Front
SSP1801	301191618010	CHEVROLET OPTRA J200 03/2003-04/2012	Suspension Ball Joint - Front
SSP1801	301191618010	DAEWOO NUBIRA II (1.6i, 1.8i) 07/2003-2009	Suspension Ball Joint - Front
SSP1801	301191618010	SUZUKI RENO 1st Gen J200 2004-2008	Suspension Ball Joint - Front
SSP1802	301191618020	CHEVROLET LACETTI J200 (OPTRA) 03/2003-04/2012	Suspension Ball Joint - Front Lower
SSP1803	301191618030	CHEVROLET COLORADO 1st Gen 2003-2012	Suspension Ball Joint - Front Upper
SSP1803	301191618030	GMC YUKON 2004-2012	Suspension Ball Joint - Front Upper
SSP1804	301191618040	CHEVROLET REZZO U100 (VIVANT) 2004-2009	Suspension Ball Joint - Front
SSP1804	301191618040	CHEVROLET TACUMA 2000-2008	Suspension Ball Joint - Front
SSP1804	301191618040	DAEWOO REZZO (KLAU) 09/2000-02/2011	Suspension Ball Joint - Front
SSP1805	301191618050	CHEVROLET EXPRESS 2500 2003-	Suspension Ball Joint - Front Lower
SSP1806	301191618060	CHEVROLET BLAZER 2nd Gen 1995-2005	Suspension Ball Joint - Front Lower
SSP1807	301191618070	CHEVROLET BLAZER 2nd Gen 1995-2005	Suspension Ball Joint - Front Upper
SSP1808	301191618080	BUICK LESABRE 2000-2005	Suspension Ball Joint - Front Lower
SSP1808	301191618080	BUICK REGAL 1998-2003	Suspension Ball Joint - Front Lower
SSP1808	301191618080	CADILLAC DEVILLE 2000-2005	Suspension Ball Joint - Front Lower
SSP1808	301191618080	CHEVROLET CAPTIVA 06/2006-05/2010	Suspension Ball Joint - Front Lower
SSP1808	301191618080	CHEVROLET EQUINOX 2005-2009	Suspension Ball Joint - Front Lower
SSP1808	301191618080	CHEVROLET IMPALA 8th, 9th Gen 2000-2013	Suspension Ball Joint - Front Lower
SSP1808	301191618080	OPEL ANTARA 05/2006-	Suspension Ball Joint - Front Lower
SSP1809	301191618090	CHEVROLET SPARK M300 03/2010-2016	Suspension Ball Joint - Front Lower





 SHORT LONG			DESCRIPTION
SSP1810	301191618100	CHEVROLET SILVERADO 1500 2nd Gen, GMT900 2009-2013	Suspension Ball Joint - Front Lower
SSP1810	301191618100	CHEVROLET TAHOE 3rd Gen, GMT900 2007-2014	Suspension Ball Joint - Front Lower
SSP1810	301191618100	GMC SIERRA 1500 2nd Gen, GMT900 2007-2013	Suspension Ball Joint - Front Lower
SSP1810	301191618100	GMC YUKON GMT900 2007-2014	Suspension Ball Joint - Front Lower
SSP1811	301191618110	CADILLAC ESCALADE 1st Gen 1992-2000	Suspension Ball Joint - Front Lower
SSP1811	301191618110	CHEVROLET TAHOE 1st Gen 1992-2000	Suspension Ball Joint - Front Lower
SSP1811	301191618110	GMC YUKON 1st Gen 1992-2000	Suspension Ball Joint - Front Lower
SSP1812	301191618120	CHEVROLET CAVALIER 3rd Gen 1995-2005	Suspension Ball Joint - Front Lower
SSP1813	301191618130	CADILLAC ESCALADE 2nd Gen (GMT 800) 2001-2006	Suspension Ball Joint - Front Lower
SSP1813	301191618130	CHEVROLET TAHOE 2nd Gen, GMT800 2000-2006	Suspension Ball Joint - Front Lower
SSP1813	301191618130	CHEVROLET TAHOE 3rd Gen, GMT900 2007-2014	Suspension Ball Joint - Front Lower
SSP1814	301191618140	BUICK ENCLAVE 1st Gen 2008-2015	Suspension Ball Joint - Front
SSP1814	301191618140	CHEVROLET TRAVERSE 1st Gen 2009-2015	Suspension Ball Joint - Front
SSP1814	301191618140	GMC ACADIA 2007-2017	Suspension Ball Joint - Front
SSP1815	301191618150	CITROEN BERLINGO MF 07/1996-	Suspension Ball Joint - Front Lower
SSP1815	301191618150	CITROEN XSARA 1997-2005	Suspension Ball Joint - Front Lower
SSP1815	301191618150	CITROEN ZX 1991-1997	Suspension Ball Joint - Front Lower
SSP1816	301191618160	CITROEN BERLINGO MF 07/1996-	Suspension Ball Joint - Front Lower
SSP1816	301191618160	CITROEN XSARA 1997-2005	Suspension Ball Joint - Front Lower
SSP1816	301191618160	CITROEN ZX 1991-1997	Suspension Ball Joint - Front Lower
SSP1816	301191618160	PEUGEOT PARTNER I 05/1996-	Suspension Ball Joint - Front Lower
SSP1817	301191618170	CITROEN AX 1992-1998	Suspension Ball Joint - Front Lower
SSP1817	301191618170	CITROEN SAXO 1996-2003	Suspension Ball Joint - Front Lower
SSP1817	301191618170	PEUGEOT 106 08/1991-03/2004	Suspension Ball Joint - Front Lower
SSP1818	301191618180	CITROEN C4 PICASSO II 2013-	Suspension Ball Joint - Front Lower
SSP1818	301191618180	PEUGEOT 3008 II 2016-	Suspension Ball Joint - Front Lower
SSP1818	301191618180	PEUGEOT 308 II 09/2013-	Suspension Ball Joint - Front Lower
SSP1819	301191618190	CITROEN C2 JM 09/2003-09/2009	Suspension Ball Joint - Front Lower
SSP1819	301191618190	CITROEN C3 FC 03/2003-10/2009	Suspension Ball Joint - Front Lower
SSP1819	301191618190	CITROEN C3 PICASSO 02/2009-	Suspension Ball Joint - Front Lower
SSP1819	301191618190	PEUGEOT 207 02/2006-11/2012	Suspension Ball Joint - Front Lower
SSP1820	301191618200	CITROEN C3 II 11/2009-2016	Suspension Ball Joint - Front Lower
SSP1820	301191618200	CITROEN C4 CACTUS 09/2014-	Suspension Ball Joint - Front Lower
SSP1820	301191618200	CITROEN C-ELYSEE 11/2012-	Suspension Ball Joint - Front Lower
SSP1820	301191618200	CITROEN DS3 II 2009-2016	Suspension Ball Joint - Front Lower
SSP1820	301191618200	PEUGEOT 2008 2013-	Suspension Ball Joint - Front Lower
SSP1820	301191618200	PEUGEOT 301 11/2012-	Suspension Ball Joint - Front Lower



 SHORT LONG			DESCRIPTION
SSP1821	301191618210	CHRYSLER 300 1st Gen 2005-2010	Suspension Ball Joint - Front Lower
SSP1821	301191618210	DODGE CHALLENGER 4th Gen 2008-	Suspension Ball Joint - Front Lower
SSP1822	301191618220	CHRYSLER TOWN & COUNTRY V 2008-2016	Suspension Ball Joint - Front Lower
SSP1823	301191618230	DACIA DUSTER 04/2010-	Suspension Ball Joint - Front Lower
SSP1824	301191618240	DODGE DURANGO 3rd Gen 2011-2017	Suspension Ball Joint - Front Upper
SSP1824	301191618240	JEEP GRAND CHEROKEE WK2 2011-	Suspension Ball Joint - Front Upper
SSP1825	301191618250	DODGE DURANGO 3rd Gen 2011-2017	Suspension Ball Joint - Front Lower
SSP1825	301191618250	JEEP GRAND CHEROKEE WK2 2011-	Suspension Ball Joint - Front Lower
SSP1826	301191618260	FIAT 500X 01/2015-	Suspension Ball Joint - Front Lower
SSP1826	301191618260	JEEP RENEGADE 07/2014-	Suspension Ball Joint - Front Lower
SSP1827	301191618270	FIAT EGEA 356, TIPO 10/2015-	Suspension Ball Joint - Front Lower
SSP1827	301191618270	FIAT TIPO 356 10/2015-	Suspension Ball Joint - Front Lower
SSP1828	301191618280	IVECO DAILY III 05/1999-05/2006	Suspension Ball Joint - Front Lower
SSP1829	301191618290	FORD EXPLORER SPORT TRAC 2nd Gen 2007-2010	Suspension Ball Joint - Front Upper
SSP1829	301191618290	FORD EXPLORER U251 2006-2010	Suspension Ball Joint - Front Upper
SSP1830	301191618300	FORD EXPLORER 3rd Gen 2002-2005	Suspension Ball Joint - Front Lower
SSP1830	301191618300	FORD RANGER I 10/1999-05/2006	Suspension Ball Joint - Front Lower
SSP1830	301191618300	FORD RANGER II 06/2006-03/2011	Suspension Ball Joint - Front Lower
SSP1830	301191618300	LINCOLN AVIATOR 2002-2005	Suspension Ball Joint - Front Lower
SSP1831	301191618310	FORD COURIER 1994-1996	Suspension Ball Joint - Front
SSP1831	301191618310	FORD FIESTA III 1994-1996	Suspension Ball Joint - Front
SSP1831	301191618310	FORD FIESTA IV Box JV 1996-1998	Suspension Ball Joint - Front
SSP1831	301191618310	FORD IKON 1999-2007	Suspension Ball Joint - Front
SSP1831	301191618310	FORD KA RB 1996-2008	Suspension Ball Joint - Front
SSP1831	301191618310	FORD PUMA 03/1997-06/2002	Suspension Ball Joint - Front
SSP1831	301191618310	MAZDA 121 III 03/1996-04/2003	Suspension Ball Joint - Front
SSP1832	301191618320	FORD B-MAX I 2012-	Suspension Ball Joint - Front Lower
SSP1832	301191618320	FORD COURIER I 2014-	Suspension Ball Joint - Front Lower
SSP1832	301191618320	FORD FIESTA USA type 2011-	Suspension Ball Joint - Front Lower
SSP1832	301191618320	FORD FIESTA VI 10/2008-2016	Suspension Ball Joint - Front Lower
SSP1832	301191618320	MAZDA 2 DE 10/2007-2015	Suspension Ball Joint - Front Lower
SSP1833	301191618330	FORD FIESTA V 01/2002-09/2008	Suspension Ball Joint - Front Lower
SSP1833	301191618330	FORD FUSION 2003-2009	Suspension Ball Joint - Front Lower
SSP1833	301191618330	MAZDA 2 DY 04/2003-06/2007	Suspension Ball Joint - Front Lower
SSP1834	301191618340	FORD FOCUS II USA made 2005-2010	Suspension Ball Joint - Front Lower
SSP1835	301191618350	FORD FOCUS I 10/1998-11/2004	Suspension Ball Joint - Front
SSP1836	301191618360	FORD C-MAX I 02/2007-11/2010	Suspension Ball Joint - Front Lower
SSP1836	301191618360	FORD FOCUS II 11/2004-03/2011	Suspension Ball Joint - Front Lower
SSP1836	301191618360	VOLVO S40 II (MS) 01/2004-11/2012	Suspension Ball Joint - Front Lower
SSP1837	301191618370	FORD C-MAX I 02/2007-11/2010	Suspension Ball Joint - Front



 SHORT LONG			DESCRIPTION
SSP1837	301191618370	FORD FOCUS II 11/2004-03/2011	Suspension Ball Joint - Front
SSP1837	301191618370	VOLVO C30 10/2006-12/2012	Suspension Ball Joint - Front
SSP1837	301191618370	VOLVO S40 II (MS) 01/2004-11/2012	Suspension Ball Joint - Front
SSP1837	301191618370	VOLVO V50 04/2004-11/2012	Suspension Ball Joint - Front
SSP1838	301191618380	FORD EXPEDITION 3rd Gen U324 2007-2015	Suspension Ball Joint - Front Lower
SSP1838	301191618380	FORD F-150 12th Gen 2009-2015	Suspension Ball Joint - Front Lower
SSP1838	301191618380	LINCOLN NAVIGATOR 3rd Gen, U326 2007-2017	Suspension Ball Joint - Front Lower
SSP1839	301191618390	FORD MUSTANG 5th Gen 2005-2015	Suspension Ball Joint - Front Lower
SSP1840	301191618400	FORD MUSTANG 5th Gen 2005-2015	Suspension Ball Joint - Front Lower
SSP1841	301191618410	FORD KUGA I 02/2008-02/2013	Suspension Ball Joint - Front Right Lower
SSP1842	301191618420	FORD KUGA I 02/2008-02/2013	Suspension Ball Joint - Front Left Lower
SSP1843	301191618430	FORD EXPLORER 2nd Gen 1995-2001	Suspension Ball Joint - Front Upper
SSP1843	301191618430	FORD EXPLORER 3rd Gen 2002-2005	Suspension Ball Joint - Front Upper
SSP1843	301191618430	FORD RANGER I USA made 1998-2003	Suspension Ball Joint - Front Upper
SSP1844	301191618440	FORD TRANSIT CONNECT II 2013-	Suspension Ball Joint - Front Right Lower
SSP1845	301191618450	FORD TRANSIT CONNECT II 2013-	Suspension Ball Joint - Front Right Lower
SSP1846	301191618460	FORD TRANSIT CONNECT 04/2002-09/2013	Suspension Ball Joint - Front Lower
SSP1846	301191618460	FORD TRANSIT V184 2000-06/2006	Suspension Ball Joint - Front Lower
SSP1846	301191618460	FORD TRANSIT V347-348 07/2006-04/2014	Suspension Ball Joint - Front Lower
SSP1847	301191618470	FORD TRANSIT V347-348 07/2006-04/2014	Suspension Ball Joint - Front Lower
SSP1848	301191618480	FORD TRANSIT V363 04/2014-	Suspension Ball Joint - Front Lower
SSP1849	301191618490	FORD TRANSIT CUSTOM 12/2012-	Suspension Ball Joint - Front Lower
SSP1849	301191618490	FORD TRANSIT V363 04/2014-	Suspension Ball Joint - Front Lower
SSP1850	301191618500	FORD MONDEO III 11/2000-03/2007	Suspension Ball Joint - Front Lower
SSP1851	301191618510	FORD MONDEO III 11/2000-03/2007	Suspension Ball Joint - Front
SSP1851	301191618510	JAGUAR X-TYPE 06/2001-11/2009	Suspension Ball Joint - Front
SSP1852	301191618520	FORD GALAXY 05/2006-	Suspension Ball Joint - Front
SSP1852	301191618520	FORD MONDEO IV 04/2007-08/2014	Suspension Ball Joint - Front
SSP1852	301191618520	FORD S-MAX WA6 05/2006-	Suspension Ball Joint - Front
SSP1852	301191618520	VOLVO S60 II 04/2010-	Suspension Ball Joint - Front
SSP1852	301191618520	VOLVO S80 II (AS) 03/2006-2016	Suspension Ball Joint - Front
SSP1852	301191618520	VOLVO V70 III 08/2007-2016	Suspension Ball Joint - Front
SSP1853	301191618530	HYUNDAI ix35 01/2010-2015	Suspension Ball Joint - Front Lower
SSP1853	301191618530	KIA SPORTAGE SL 07/2010-08/2015	Suspension Ball Joint - Front Lower
SSP1854	301191618540	HYUNDAI ACCENT I 01/1994-01/2000	Suspension Ball Joint - Front
SSP1854	301191618540	HYUNDAI ACCENT II 02/2000-11/2005	Suspension Ball Joint - Front
SSP1854	301191618540	HYUNDAI AVANTE TOURING 1995-2000	Suspension Ball Joint - Front
SSP1854	301191618540	HYUNDAI COUPE 05/2002-08/2009	Suspension Ball Joint - Front
SSP1854	301191618540	HYUNDAI ELANTRA 3th Gen, XD 06/2000-07/2006	Suspension Ball Joint - Front





			DESCRIPTION
SHORT	LONG		
SSP1854	301191618540	HYUNDAI ELANTRA J2/RD 11/1995-09/2000	Suspension Ball Joint - Front
SSP1854	301191618540	HYUNDAI EXCEL 1994-1998	Suspension Ball Joint - Front
SSP1854	301191618540	HYUNDAI GETZ (TB) 08/2002-06/2011	Suspension Ball Joint - Front
SSP1854	301191618540	HYUNDAI I20 (PB,PBT) 09/2008-08/2014	Suspension Ball Joint - Front
SSP1854	301191618540	HYUNDAI ix20 (JC) 11/2010-	Suspension Ball Joint - Front
SSP1854	301191618540	HYUNDAI MATRIX 06/2001-08/2010	Suspension Ball Joint - Front
SSP1854	301191618540	KIA CERATO (LD) 03/2004-07/2011	Suspension Ball Joint - Front
SSP1854	301191618540	KIA SPECTRA 1st Gen, LD 2004-2009	Suspension Ball Joint - Front
SSP1854	301191618540	KIA VENGA AM 02/2010-	Suspension Ball Joint - Front
SSP1855	301191618550	HYUNDAI H 1 I 02/2008-	Suspension Ball Joint - Front Lower
SSP1855	301191618550	HYUNDAI I800 800 10/2007-	Suspension Ball Joint - Front Lower
SSP1855	301191618550	HYUNDAI ix55 09/2008-	Suspension Ball Joint - Front Lower
SSP1855	301191618550	HYUNDAI VERACRUZ 2008-2015	Suspension Ball Joint - Front Lower
SSP1855	301191618550	KIA SEDONA III 06/2006-2014	Suspension Ball Joint - Front Lower
SSP1856	301191618560	HYUNDAI ACCENT IV, RB 2011-	Suspension Ball Joint - Front Lower
SSP1856	301191618560	HYUNDAI ELANTRA 5th Gen, MD/UD 2012-2015	Suspension Ball Joint - Front Lower
SSP1856	301191618560	HYUNDAI I20 II 11/2014-	Suspension Ball Joint - Front Lower
SSP1857	301191618570	HYUNDAI ACCENT III, MC 11/2005-11/2010	Suspension Ball Joint - Front
SSP1857	301191618570	KIA RIO JB 03/2005-08/2011	Suspension Ball Joint - Front
SSP1857	301191618570	KIA RIO5 JB 03/2005-08/2011	Suspension Ball Joint - Front
SSP1858	301191618580	HYUNDAI ELANTRA Touring, Wagon 10/2007-11/2011	Suspension Ball Joint - Front
SSP1858	301191618580	HYUNDAI I30 FD 10/2007-11/2011	Suspension Ball Joint - Front
SSP1858	301191618580	KIA CEED I 12/2006-04/2012	Suspension Ball Joint - Front
SSP1858	301191618580	KIA Forte 1st Gen 2010-2013	Suspension Ball Joint - Front
SSP1858	301191618580	KIA Forte Koup 1st Gen 2010-2013	Suspension Ball Joint - Front
SSP1858	301191618580	KIA Forte5 1st Gen 2010-2013	Suspension Ball Joint - Front
SSP1859	301191618590	HYUNDAI Elantra GT 12/2011-	Suspension Ball Joint - Front
SSP1859	301191618590	HYUNDAI I30 GD 12/2011-	Suspension Ball Joint - Front
SSP1859	301191618590	HYUNDAI I30 PD 2017-	Suspension Ball Joint - Front
SSP1859	301191618590	HYUNDAI Santa Fe III DM 09/2012-	Suspension Ball Joint - Front
SSP1859	301191618590	KIA CEED II 05/2012-	Suspension Ball Joint - Front
SSP1859	301191618590	KIA OPTIMA 3rd Gen 01/2010-	Suspension Ball Joint - Front
SSP1860	301191618600	HYUNDAI Santa Fe I SM 02/2001-02/2006	Suspension Ball Joint - Front Lower
SSP1860	301191618600	HYUNDAI Santa Fe II CM 03/2006-08/2012	Suspension Ball Joint - Front Lower
SSP1860	301191618600	KIA SORENTO XM 2009-2014	Suspension Ball Joint - Front Lower
SSP1861	301191618610	JEEP CHEROKEE 2nd Gen, XJ 10/1984-03/2001	Suspension Ball Joint - Front
SSP1861	301191618610	JEEP GRAND CHEROKEE I ZJ 09/1991-05/1999	Suspension Ball Joint - Front
SSP1862	301191618620	JEEP COMMANDER XK 2005-2010	Suspension Ball Joint - Front Upper





			DESCRIPTION
SHORT	LONG		
SSP1862	301191618620	JEEP GRAND CHEROKEE III WH/WK 06/2005-12/2010	Suspension Ball Joint - Front Upper
SSP1863	301191618630	JEEP GRAND CHEROKEE II WJ, WG 06/1999-05/2005	Suspension Ball Joint - Front Lower
SSP1863	301191618630	JEEP WRANGLER I 1991-1996	Suspension Ball Joint - Front Lower
SSP1863	301191618630	JEEP WRANGLER JK 04/2007-	Suspension Ball Joint - Front Lower
SSP1863	301191618630	JEEP WRANGLER TJ 08/1996-03/2007	Suspension Ball Joint - Front Lower
SSP1864	301191618640	JEEP GRAND CHEROKEE II WJ, WG 06/1999-05/2005	Suspension Ball Joint - Front Upper
SSP1864	301191618640	JEEP WRANGLER I 1991-1996	Suspension Ball Joint - Front Upper
SSP1864	301191618640	JEEP WRANGLER JK 04/2007-	Suspension Ball Joint - Front Upper
SSP1864	301191618640	JEEP WRANGLER TJ 08/1996-03/2007	Suspension Ball Joint - Front Upper
SSP1865	301191618650	DODGE CALIBER 2007-2015	Suspension Ball Joint - Front Lower
SSP1865	301191618650	JEEP COMPASS MK49 06/2006-2015	Suspension Ball Joint - Front Lower
SSP1865	301191618650	JEEP PATRIOT 2007-2015	Suspension Ball Joint - Front Lower
SSP1866	301191618660	KIA SORENTO JC, BL 08/2002-10/2009	Suspension Ball Joint - Front Lower
SSP1867	301191618670	KIA SORENTO JC, BL 08/2002-10/2009	Suspension Ball Joint - Front
SSP1868	301191618680	KIA SORENTO UM, III 2015-2017	Suspension Ball Joint - Front Lower
SSP1869	301191618690	HYUNDAI I10 (PA) 02/2008-11/2013	Suspension Ball Joint - Front Lower
SSP1869	301191618690	KIA PICANTO BA 05/2004-04/2011	Suspension Ball Joint - Front Lower
SSP1870	301191618700	HYUNDAI TUCSON JM 08/2004-03/2010	Suspension Ball Joint - Front
SSP1870	301191618700	KIA SPORTAGE JE 09/2004-06/2010	Suspension Ball Joint - Front
SSP1871	301191618710	HYUNDAI TUCSON JM 08/2004-03/2010	Suspension Ball Joint - Front Lower
SSP1871	301191618710	KIA SPORTAGE JE 09/2004-06/2010	Suspension Ball Joint - Front Lower
SSP1872	301191618720	KIA CEED I 12/2006-04/2012	Suspension Ball Joint - Front Lower
SSP1873	301191618730	HYUNDAI Grand i10 IA/BA 12/2013-	Suspension Ball Joint - Front Lower
SSP1873	301191618730	KIA PICANTO TA 05/2011-	Suspension Ball Joint - Front Lower
SSP1873	301191618730	KIA RIO UB 09/2011-	Suspension Ball Joint - Front Lower
SSP1873	301191618730	KIA SOUL AM 02/2009-2014	Suspension Ball Joint - Front Lower
SSP1874	301191618740	MERCEDES C220 (W202) 1993-2000	Suspension Ball Joint - Front Lower
SSP1874	301191618740	MERCEDES C230 (W202) 1993-2000	Suspension Ball Joint - Front Lower
SSP1874	301191618740	MERCEDES C280 (W202) 1993-2000	Suspension Ball Joint - Front Lower
SSP1874	301191618740	MERCEDES C36 AMG (W202) 1993-2000	Suspension Ball Joint - Front Lower
SSP1874	301191618740	MERCEDES C43 AMG (W202) 1993-2000	Suspension Ball Joint - Front Lower
SSP1874	301191618740	MERCEDES E280 (W210) 1995-2003	Suspension Ball Joint - Front Lower
SSP1874	301191618740	MERCEDES E300 (W210) 1995-2003	Suspension Ball Joint - Front Lower
SSP1874	301191618740	MERCEDES E320 (W210) 1995-2003	Suspension Ball Joint - Front Lower
SSP1874	301191618740	MERCEDES E420 (W210) 1995-2003	Suspension Ball Joint - Front Lower
SSP1874	301191618740	MERCEDES E430 (W210) 1995-2003	Suspension Ball Joint - Front Lower
SSP1874	301191618740	MERCEDES E500 (W210) 1995-2003	Suspension Ball Joint - Front Lower
SSP1874	301191618740	MERCEDES E55 AMG (W210) 1995-2003	Suspension Ball Joint - Front Lower
SSP1874	301191618740	MERCEDES SLK200 (R170) 1997-2004	Suspension Ball Joint - Front Lower





 SHORT LONG			DESCRIPTION
SSP1875	301191618750	MERCEDES C220 (W202) 1993-2000	Suspension Ball Joint - Front
SSP1875	301191618750	MERCEDES C230 (W202) 1993-2000	Suspension Ball Joint - Front
SSP1875	301191618750	MERCEDES C280 (W202) 1993-2000	Suspension Ball Joint - Front
SSP1875	301191618750	MERCEDES C36 AMG (W202) 1993-2000	Suspension Ball Joint - Front
SSP1875	301191618750	MERCEDES C43 AMG (W202) 1993-2000	Suspension Ball Joint - Front
SSP1875	301191618750	MERCEDES E280 (W210) 1995-2003	Suspension Ball Joint - Front
SSP1875	301191618750	MERCEDES E300 (W210) 1995-2003	Suspension Ball Joint - Front
SSP1875	301191618750	MERCEDES E320 (W210) 1995-2003	Suspension Ball Joint - Front
SSP1875	301191618750	MERCEDES E420 (W210) 1995-2003	Suspension Ball Joint - Front
SSP1875	301191618750	MERCEDES E430 (W210) 1995-2003	Suspension Ball Joint - Front
SSP1875	301191618750	MERCEDES E500 (W210) 1995-2003	Suspension Ball Joint - Front
SSP1875	301191618750	MERCEDES E55 AMG (W210) 1995-2003	Suspension Ball Joint - Front
SSP1876	301191618760	MERCEDES E200 (W212) 01/2009-2016	Suspension Ball Joint - Front Lower
SSP1876	301191618760	MERCEDES E250 (W212) 01/2009-2016	Suspension Ball Joint - Front Lower
SSP1876	301191618760	MERCEDES E280 (W212) 01/2009-2016	Suspension Ball Joint - Front Lower
SSP1876	301191618760	MERCEDES E300 (W212) 01/2009-2016	Suspension Ball Joint - Front Lower
SSP1876	301191618760	MERCEDES E320 (W212) 01/2009-2016	Suspension Ball Joint - Front Lower
SSP1876	301191618760	MERCEDES E400 (W212) 01/2009-2016	Suspension Ball Joint - Front Lower
SSP1876	301191618760	MERCEDES E500 (W212) 01/2009-2016	Suspension Ball Joint - Front Lower
SSP1876	301191618760	MERCEDES E550 (W212) 01/2009-2016	Suspension Ball Joint - Front Lower
SSP1876	301191618760	MERCEDES E63 AMG (W212) 01/2009-2016	Suspension Ball Joint - Front Lower
SSP1877	301191618770	MERCEDES A160 (W168) 1997-2004	Suspension Ball Joint - Front
SSP1877	301191618770	MERCEDES A190 (W168) 1997-2004	Suspension Ball Joint - Front
SSP1878	301191618780	MERCEDES A160 (W169) 09/2004-06/2012	Suspension Ball Joint - Front
SSP1878	301191618780	MERCEDES A190 (W169) 09/2004-06/2012	Suspension Ball Joint - Front
SSP1878	301191618780	MERCEDES B180 (W245) 03/2005-11/2011	Suspension Ball Joint - Front
SSP1878	301191618780	MERCEDES B200 (W245) 03/2005-11/2011	Suspension Ball Joint - Front
SSP1879	301191618790	MERCEDES VITO (W638) 03/1997-07/2003	Suspension Ball Joint - Front Lower
SSP1880	301191618800	MERCEDES VITO (W447) 2014-	Suspension Ball Joint - Front Lower
SSP1881	301191618810	MERCEDES GL350 (X166) 07/2011-	Suspension Ball Joint - Front Lower
SSP1881	301191618810	MERCEDES GL450 (X166) 07/2011-	Suspension Ball Joint - Front Lower
SSP1881	301191618810	MERCEDES GL500 (X166) 07/2011-	Suspension Ball Joint - Front Lower
SSP1881	301191618810	MERCEDES GL550 (X166) 07/2011-	Suspension Ball Joint - Front Lower
SSP1881	301191618810	MERCEDES GL63 AMG (X166) 07/2011-	Suspension Ball Joint - Front Lower
SSP1881	301191618810	MERCEDES ML250 (W166) 07/2011-	Suspension Ball Joint - Front Lower
SSP1881	301191618810	MERCEDES ML350 (W166) 07/2011-	Suspension Ball Joint - Front Lower
SSP1881	301191618810	MERCEDES ML400 (W166) 07/2011-	Suspension Ball Joint - Front Lower
SSP1881	301191618810	MERCEDES ML500 (W166) 07/2011-	Suspension Ball Joint - Front Lower
SSP1881	301191618810	MERCEDES ML550 (W166) 07/2011-	Suspension Ball Joint - Front Lower
SSP1881	301191618810	MERCEDES ML63 AMG (W166) 07/2011-	Suspension Ball Joint - Front Lower
SSP1882	301191618820	MERCEDES VIANO (W639) 03/2003-07/2014	Suspension Ball Joint - Front



 SHORT LONG			DESCRIPTION
SSP1882	301191618820	MERCEDES VITO (W639) 03/2003-07/2014	Suspension Ball Joint - Front
SSP1883	301191618830	MERCEDES Vaneo (W414) 02/2002-07/2005	Suspension Ball Joint - Front Lower
SSP1884	301191618840	DODGE SPRINTER 2500 W901,W902,W903 01/1995-05/2006	Suspension Ball Joint - Front Lower
SSP1884	301191618840	DODGE SPRINTER 3500 W901,W902,W903 01/1995-05/2006	Suspension Ball Joint - Front Lower
SSP1884	301191618840	MERCEDES SPRINTER (W901,W902,W903) 01/1995-05/2006	Suspension Ball Joint - Front Lower
SSP1884	301191618840	VOLKSWAGEN LT 28-35-46, Typ 2D 04/1996- 07/2006	Suspension Ball Joint - Front Lower
SSP1885	301191618850	DODGE SPRINTER 2500 W901,W902,W903 01/1995-05/2006	Suspension Ball Joint - Front
SSP1885	301191618850	DODGE SPRINTER 3500 W901,W902,W903 01/1995-05/2006	Suspension Ball Joint - Front
SSP1885	301191618850	MERCEDES SPRINTER (W901,W902,W903) 01/1995-05/2006	Suspension Ball Joint - Front
SSP1886	301191618860	DODGE SPRINTER 2500 W906 06/2006-	Suspension Ball Joint - Front Lower
SSP1886	301191618860	DODGE SPRINTER 3500 W906 06/2006-	Suspension Ball Joint - Front Lower
SSP1886	301191618860	MERCEDES SPRINTER (W906) 06/2006-	Suspension Ball Joint - Front Lower
SSP1886	301191618860	MERCEDES SPRINTER 2500 (W906) 06/2006-	Suspension Ball Joint - Front Lower
SSP1886	301191618860	MERCEDES SPRINTER 3500 (W906) 06/2006-	Suspension Ball Joint - Front Lower
SSP1886	301191618860	VOLKSWAGEN CRAFTER 04/2006-	Suspension Ball Joint - Front Lower
SSP1887	301191618870	MERCEDES ML350 (W163) 1998-06/2005	Suspension Ball Joint - Front Lower
SSP1887	301191618870	MERCEDES ML500 (W163) 1998-06/2005	Suspension Ball Joint - Front Lower
SSP1888	301191618880	MERCEDES ML350 (W163) 1998-06/2005	Suspension Ball Joint - Rear
SSP1888	301191618880	MERCEDES ML500 (W163) 1998-06/2005	Suspension Ball Joint - Rear
SSP1889	301191618890	MERCEDES ML350 (W164) 07/2005-05/2011	Suspension Ball Joint - Front Lower
SSP1889	301191618890	MERCEDES ML500 (W164) 07/2005-05/2011	Suspension Ball Joint - Front Lower
SSP1889	301191618890	MERCEDES ML550 (W164) 07/2005-05/2011	Suspension Ball Joint - Front Lower
SSP1889	301191618890	MERCEDES ML63 AMG (W164) 07/2005- 05/2011	Suspension Ball Joint - Front Lower
SSP1889	301191618890	MERCEDES R320 (W251) 09/2006-08/2013	Suspension Ball Joint - Front Lower
SSP1889	301191618890	MERCEDES R350 (W251) 09/2006-08/2013	Suspension Ball Joint - Front Lower
SSP1889	301191618890	MERCEDES R500 (W251) 09/2006-08/2013	Suspension Ball Joint - Front Lower
SSP1889	301191618890	MERCEDES R550 (W251) 09/2006-08/2013	Suspension Ball Joint - Front Lower
SSP1889	301191618890	MERCEDES R63 AMG (W251) 09/2006- 08/2013	Suspension Ball Joint - Front Lower
SSP1890	301191618900	MERCEDES ML350 (W164) 07/2005-05/2011	Suspension Ball Joint - Rear
SSP1890	301191618900	MERCEDES ML500 (W164) 07/2005-05/2011	Suspension Ball Joint - Rear
SSP1890	301191618900	MERCEDES ML550 (W164) 07/2005-05/2011	Suspension Ball Joint - Rear
SSP1890	301191618900	MERCEDES ML63 AMG (W164) 07/2005- 05/2011	Suspension Ball Joint - Rear
SSP1890	301191618900	MERCEDES R320 (W251) 09/2006-08/2013	Suspension Ball Joint - Rear
SSP1890	301191618900	MERCEDES R350 (W251) 09/2006-08/2013	Suspension Ball Joint - Rear





 SHORT LONG			DESCRIPTION
SSP1890	301191618900	MERCEDES R500 (W251) 09/2006-08/2013	Suspension Ball Joint - Rear
SSP1890	301191618900	MERCEDES R550 (W251) 09/2006-08/2013	Suspension Ball Joint - Rear
SSP1890	301191618900	MERCEDES R63 AMG (W251) 09/2006-08/2013	Suspension Ball Joint - Rear
SSP1891	301191618910	MERCEDES CL200 C215 03/1999-03/2006	Suspension Ball Joint - Front Lower
SSP1891	301191618910	MERCEDES CL230 C215 03/1999-03/2006	Suspension Ball Joint - Front Lower
SSP1891	301191618910	MERCEDES CL500 C215 03/1999-03/2006	Suspension Ball Joint - Front Lower
SSP1891	301191618910	MERCEDES CL55 AMG C215 03/1999-03/2006	Suspension Ball Joint - Front Lower
SSP1891	301191618910	MERCEDES CL600 C215 03/1999-03/2006	Suspension Ball Joint - Front Lower
SSP1891	301191618910	MERCEDES CL65 AMG C215 03/1999-03/2006	Suspension Ball Joint - Front Lower
SSP1891	301191618910	MERCEDES CLS350 (C219) RWD 10/2004-12/2010	Suspension Ball Joint - Front Lower
SSP1891	301191618910	MERCEDES CLS500 (C219) RWD 10/2004-12/2010	Suspension Ball Joint - Front Lower
SSP1891	301191618910	MERCEDES CLS55 AMG (C219) RWD 10/2004-12/2010	Suspension Ball Joint - Front Lower
SSP1891	301191618910	MERCEDES CLS550 (C219) RWD 10/2004-12/2010	Suspension Ball Joint - Front Lower
SSP1891	301191618910	MERCEDES CLS63 AMG (C219) RWD 10/2004-12/2010	Suspension Ball Joint - Front Lower
SSP1891	301191618910	MERCEDES E280 (W211) 03/2003-07/2009	Suspension Ball Joint - Front Lower
SSP1891	301191618910	MERCEDES E300 (W211) 03/2003-07/2009	Suspension Ball Joint - Front Lower
SSP1891	301191618910	MERCEDES E320 (W211) 03/2003-07/2009	Suspension Ball Joint - Front Lower
SSP1891	301191618910	MERCEDES E350 (W211) 03/2003-07/2009	Suspension Ball Joint - Front Lower
SSP1891	301191618910	MERCEDES E500 (W211) 03/2003-07/2009	Suspension Ball Joint - Front Lower
SSP1891	301191618910	MERCEDES E55 AMG (W211) 03/2003-07/2009	Suspension Ball Joint - Front Lower
SSP1891	301191618910	MERCEDES E550 (W211) 03/2003-07/2009	Suspension Ball Joint - Front Lower
SSP1891	301191618910	MERCEDES E63 AMG (W211) 03/2003-07/2009	Suspension Ball Joint - Front Lower
SSP1891	301191618910	MERCEDES S320 (W220) 1999-2005	Suspension Ball Joint - Front Lower
SSP1891	301191618910	MERCEDES S350 (W220) 1999-2005	Suspension Ball Joint - Front Lower
SSP1891	301191618910	MERCEDES S420 (W220) 1999-2005	Suspension Ball Joint - Front Lower
SSP1891	301191618910	MERCEDES S430 (W220) 1999-2005	Suspension Ball Joint - Front Lower
SSP1891	301191618910	MERCEDES S500 (W220) 1999-2005	Suspension Ball Joint - Front Lower
SSP1891	301191618910	MERCEDES S55 AMG (W220) 1999-2005	Suspension Ball Joint - Front Lower
SSP1891	301191618910	MERCEDES S600 (W220) 1999-2005	Suspension Ball Joint - Front Lower
SSP1891	301191618910	MERCEDES S65 AMG (W220) 1999-2005	Suspension Ball Joint - Front Lower
SSP1891	301191618910	MERCEDES SL500 (R230) 10/2001-01/2012	Suspension Ball Joint - Front Lower
SSP1891	301191618910	MERCEDES SL55 AMG (R230) 10/2001-01/2012	Suspension Ball Joint - Front Lower
SSP1891	301191618910	MERCEDES SL550 (R230) 10/2001-01/2012	Suspension Ball Joint - Front Lower
SSP1891	301191618910	MERCEDES SL600 (R230) 10/2001-01/2012	Suspension Ball Joint - Front Lower



			DESCRIPTION
SHORT	LONG		
SSP1891	301191618910	MERCEDES SL63 AMG (R230) 10/2001-01/2012	Suspension Ball Joint - Front Lower
SSP1891	301191618910	MERCEDES SL65 AMG (R230) 10/2001-01/2012	Suspension Ball Joint - Front Lower
SSP1892	301191618920	MERCEDES CLS350 (C219) RWD 10/2004-12/2010	Suspension Ball Joint - Front Lower
SSP1892	301191618920	MERCEDES CLS500 (C219) RWD 10/2004-12/2010	Suspension Ball Joint - Front Lower
SSP1892	301191618920	MERCEDES CLS55 AMG (C219) RWD 10/2004-12/2010	Suspension Ball Joint - Front Lower
SSP1892	301191618920	MERCEDES CLS550 (C219) RWD 10/2004-12/2010	Suspension Ball Joint - Front Lower
SSP1892	301191618920	MERCEDES CLS63 AMG (C219) RWD 10/2004-12/2010	Suspension Ball Joint - Front Lower
SSP1892	301191618920	MERCEDES E280 (W211) 03/2003-07/2009	Suspension Ball Joint - Front Lower
SSP1892	301191618920	MERCEDES E300 (W211) 03/2003-07/2009	Suspension Ball Joint - Front Lower
SSP1892	301191618920	MERCEDES E320 (W211) 03/2003-07/2009	Suspension Ball Joint - Front Lower
SSP1892	301191618920	MERCEDES E350 (W211) 03/2003-07/2009	Suspension Ball Joint - Front Lower
SSP1892	301191618920	MERCEDES E500 (W211) 03/2003-07/2009	Suspension Ball Joint - Front Lower
SSP1892	301191618920	MERCEDES E55 AMG (W211) 03/2003-07/2009	Suspension Ball Joint - Front Lower
SSP1892	301191618920	MERCEDES E550 (W211) 03/2003-07/2009	Suspension Ball Joint - Front Lower
SSP1892	301191618920	MERCEDES E63 AMG (W211) 03/2003-07/2009	Suspension Ball Joint - Front Lower
SSP1892	301191618920	MERCEDES SL500 (R230) 10/2001-01/2012	Suspension Ball Joint - Front Lower
SSP1892	301191618920	MERCEDES SL55 AMG (R230) 10/2001-01/2012	Suspension Ball Joint - Front Lower
SSP1892	301191618920	MERCEDES SL550 (R230) 10/2001-01/2012	Suspension Ball Joint - Front Lower
SSP1892	301191618920	MERCEDES SL600 (R230) 10/2001-01/2012	Suspension Ball Joint - Front Lower
SSP1892	301191618920	MERCEDES SL63 AMG (R230) 10/2001-01/2012	Suspension Ball Joint - Front Lower
SSP1892	301191618920	MERCEDES SL65 AMG (R230) 10/2001-01/2012	Suspension Ball Joint - Front Lower
SSP1893	301191618930	MERCEDES CLS350 (C219) RWD 10/2004-12/2010	Suspension Ball Joint - Front
SSP1893	301191618930	MERCEDES CLS500 (C219) RWD 10/2004-12/2010	Suspension Ball Joint - Front
SSP1893	301191618930	MERCEDES CLS55 AMG (C219) RWD 10/2004-12/2010	Suspension Ball Joint - Front
SSP1893	301191618930	MERCEDES CLS550 (C219) RWD 10/2004-12/2010	Suspension Ball Joint - Front
SSP1893	301191618930	MERCEDES CLS63 AMG (C219) RWD 10/2004-12/2010	Suspension Ball Joint - Front
SSP1893	301191618930	MERCEDES E280 (W211) 03/2003-07/2009	Suspension Ball Joint - Front
SSP1893	301191618930	MERCEDES E300 (W211) 03/2003-07/2009	Suspension Ball Joint - Front
SSP1893	301191618930	MERCEDES E320 (W211) 03/2003-07/2009	Suspension Ball Joint - Front
SSP1893	301191618930	MERCEDES E350 (W211) 03/2003-07/2009	Suspension Ball Joint - Front
SSP1893	301191618930	MERCEDES E500 (W211) 03/2003-07/2009	Suspension Ball Joint - Front





 SHORT LONG			DESCRIPTION
SSP1893	301191618930	MERCEDES E55 AMG (W211) 03/2003-07/2009	Suspension Ball Joint - Front
SSP1893	301191618930	MERCEDES E550 (W211) 03/2003-07/2009	Suspension Ball Joint - Front
SSP1893	301191618930	MERCEDES E63 AMG (W211) 03/2003-07/2009	Suspension Ball Joint - Front
SSP1894	301191618940	MERCEDES E280 (W211) 03/2003-07/2009	Suspension Ball Joint - Front Upper
SSP1894	301191618940	MERCEDES E300 (W211) 03/2003-07/2009	Suspension Ball Joint - Front Upper
SSP1894	301191618940	MERCEDES E320 (W211) 03/2003-07/2009	Suspension Ball Joint - Front Upper
SSP1894	301191618940	MERCEDES E350 (W211) 03/2003-07/2009	Suspension Ball Joint - Front Upper
SSP1894	301191618940	MERCEDES E500 (W211) 03/2003-07/2009	Suspension Ball Joint - Front Upper
SSP1894	301191618940	MERCEDES E55 AMG (W211) 03/2003-07/2009	Suspension Ball Joint - Front Upper
SSP1894	301191618940	MERCEDES E550 (W211) 03/2003-07/2009	Suspension Ball Joint - Front Upper
SSP1894	301191618940	MERCEDES E63 AMG (W211) 03/2003-07/2009	Suspension Ball Joint - Front Upper
SSP1894	301191618940	MERCEDES SL500 (R230) 10/2001-01/2012	Suspension Ball Joint - Front Upper
SSP1894	301191618940	MERCEDES SL55 AMG (R230) 10/2001-01/2012	Suspension Ball Joint - Front Upper
SSP1894	301191618940	MERCEDES SL550 (R230) 10/2001-01/2012	Suspension Ball Joint - Front Upper
SSP1894	301191618940	MERCEDES SL600 (R230) 10/2001-01/2012	Suspension Ball Joint - Front Upper
SSP1894	301191618940	MERCEDES SL63 AMG (R230) 10/2001-01/2012	Suspension Ball Joint - Front Upper
SSP1894	301191618940	MERCEDES SL65 AMG (R230) 10/2001-01/2012	Suspension Ball Joint - Front Upper
SSP1895	301191618950	MAZDA 3 BK 10/2003-06/2009	Suspension Ball Joint - Front
SSP1895	301191618950	MAZDA 5 CR19, 2nd Gen 03/2005-08/2010	Suspension Ball Joint - Front
SSP1896	301191618960	MAZDA 3 BL 07/2009-11/2014	Suspension Ball Joint - Front
SSP1897	301191618970	MAZDA CX-7 ER 2007-	Suspension Ball Joint - Front
SSP1898	301191618980	FORD FUSION 1st Gen USA made 2006-2012	Suspension Ball Joint - Front Upper
SSP1898	301191618980	LINCOLN MKZ 1st Gen 2006-2012	Suspension Ball Joint - Front Upper
SSP1898	301191618980	MAZDA 6 GG 06/2002-07/2007	Suspension Ball Joint - Front Upper
SSP1898	301191618980	MERCURY MILAN 2006-2011	Suspension Ball Joint - Front Upper
SSP1899	301191618990	HYUNDAI GALOPPER II 08/1998-12/2003	Suspension Ball Joint - Front Upper
SSP1899	301191618990	MINI COOPER L200 2000-10/2005	Suspension Ball Joint - Front Upper
SSP1899	301191618990	MINI COOPER L300 2nd Gen 1978-1982	Suspension Ball Joint - Front Upper
SSP1900	301191619000	HYUNDAI H100 PICK-UP 1992-1997	Suspension Ball Joint - Front Lower
SSP1900	301191619000	HYUNDAI H100 VAN 05/1993-10/2004	Suspension Ball Joint - Front Lower
SSP1900	301191619000	KIA BONGO 1997-2005	Suspension Ball Joint - Front Lower
SSP1900	301191619000	MINI COOPER L300 1986-02/2006	Suspension Ball Joint - Front Lower
SSP1901	301191619010	HYUNDAI H100 PICK-UP 1992-1997	Suspension Ball Joint - Front Upper
SSP1901	301191619010	HYUNDAI H100 VAN 05/1993-10/2004	Suspension Ball Joint - Front Upper
SSP1901	301191619010	HYUNDAI STAREX (H1) 01/1996-11/2007	Suspension Ball Joint - Front Upper
SSP1901	301191619010	KIA BONGO 1997-2005	Suspension Ball Joint - Front Upper



 SHORT LONG			DESCRIPTION	
SSP1901	301191619010	mitsubishi	mitsubishi L300 1986-02/2006	Suspension Ball Joint - Front Upper
SSP1902	301191619020	mitsubishi	mitsubishi LANCER (CS, A) 09/2003-07/2008	Suspension Ball Joint - Front Lower
SSP1902	301191619020	mitsubishi	mitsubishi OUTLANDER I 03/2001-10/2006	Suspension Ball Joint - Front Lower
SSP1903	301191619030	mitsubishi	mitsubishi ASX (GA,W) 02/2010-	Suspension Ball Joint - Front Lower
SSP1903	301191619030	mitsubishi	mitsubishi LANCER (CY2A-CZ4A) 06/2008-	Suspension Ball Joint - Front Lower
SSP1903	301191619030	mitsubishi	mitsubishi OUTLANDER II 11/2006-07/2012	Suspension Ball Joint - Front Lower
SSP1903	301191619030	mitsubishi	mitsubishi OUTLANDER III 2012-	Suspension Ball Joint - Front Lower
SSP1903	301191619030	mitsubishi	mitsubishi Outlander Sport (GA,W) 02/2010-	Suspension Ball Joint - Front Lower
SSP1903	301191619030	peugeot	PEUGEOT 4007 02/2007-	Suspension Ball Joint - Front Lower
SSP1904	301191619040	mitsubishi	mitsubishi MONTERO II 1990-2000	Suspension Ball Joint - Front Upper
SSP1904	301191619040	mitsubishi	mitsubishi PAJERO III 04/2000-01/2007	Suspension Ball Joint - Front Upper
SSP1904	301191619040	mitsubishi	mitsubishi PAJERO PININ 09/1999-06/2007	Suspension Ball Joint - Front Upper
SSP1905	301191619050	mitsubishi	mitsubishi MONTERO II 1990-2000	Suspension Ball Joint - Front Left Lower
SSP1905	301191619050	mitsubishi	mitsubishi PAJERO PININ 09/1999-06/2007	Suspension Ball Joint - Front Left Lower
SSP1906	301191619060	mitsubishi	mitsubishi MONTERO II 1990-2000	Suspension Ball Joint - Front Right Lower
SSP1906	301191619060	mitsubishi	mitsubishi PAJERO PININ 09/1999-06/2007	Suspension Ball Joint - Front Right Lower
SSP1907	301191619070	mitsubishi	mitsubishi L200 (KB_T,KA_T) 11/2005-	Suspension Ball Joint - Front Lower
SSP1907	301191619070	mitsubishi	mitsubishi MONTERO III 04/2000-01/2007	Suspension Ball Joint - Front Lower
SSP1907	301191619070	mitsubishi	mitsubishi MONTERO IV 02/2007-	Suspension Ball Joint - Front Lower
SSP1907	301191619070	mitsubishi	mitsubishi PAJERO IV 02/2007-	Suspension Ball Joint - Front Lower
SSP1908	301191619080	mitsubishi	mitsubishi L200 (KB_T,KA_T) 11/2005-	Suspension Ball Joint - Front Upper
SSP1908	301191619080	mitsubishi	mitsubishi MONTERO IV 02/2007-	Suspension Ball Joint - Front Upper
SSP1908	301191619080	mitsubishi	mitsubishi PAJERO IV 02/2007-	Suspension Ball Joint - Front Upper
SSP1909	301191619090	mini	MINI Cooper (R50, R53) 05/2001-09/2006	Suspension Ball Joint - Front Lower
SSP1909	301191619090	mini	MINI Cooper (R52) 07/2004-11/2007	Suspension Ball Joint - Front Lower
SSP1910	301191619100	mini	MINI Cooper (R50, R53) 05/2001-09/2006	Suspension Ball Joint - Front Right
SSP1910	301191619100	mini	MINI Cooper (R52) 07/2004-11/2007	Suspension Ball Joint - Front Right
SSP1911	301191619110	mini	MINI Cooper (R50, R53) 05/2001-09/2006	Suspension Ball Joint - Front Left
SSP1911	301191619110	mini	MINI Cooper (R52) 07/2004-11/2007	Suspension Ball Joint - Front Left
SSP1912	301191619120	mini	MINI Cooper (R55, R56) 09/2006-05/2010	Suspension Ball Joint - Front
SSP1913	301191619130	mini	MINI Cooper (R55, R56) 09/2006-05/2010	Suspension Ball Joint - Front Right Lower
SSP1914	301191619140	mini	MINI Cooper (R55, R56) 09/2006-05/2010	Suspension Ball Joint - Front Left Lower
SSP1915	301191619150	mini	MINI Cooper Countryman (R60) 06/2010-12/2014	Suspension Ball Joint - Front
SSP1916	301191619160	infiniti	INFINITI G20 1st Gen, P10 1990-1996	Suspension Ball Joint - Front Lower
SSP1916	301191619160	nissan	NISSAN ALMERA (N16) 07/2000-09/2006	Suspension Ball Joint - Front Lower
SSP1916	301191619160	nissan	NISSAN PRIMERA (P10-W10-W11) 06/1990-06/1996	Suspension Ball Joint - Front Lower
SSP1916	301191619160	nissan	NISSAN SENTRA (B12-N13) 1985-1990	Suspension Ball Joint - Front Lower
SSP1916	301191619160	nissan	NISSAN SUNNY (B12-N13) 1985-1990	Suspension Ball Joint - Front Lower
SSP1917	301191619170	infiniti	INFINITI G20 1st Gen, P10 1990-1996	Suspension Ball Joint - Front Lower





		 	DESCRIPTION
SHORT	LONG		
SSP1917	301191619170	NISSAN ALMERA (N15) 07/1995-06/2000	Suspension Ball Joint - Front Lower
SSP1917	301191619170	NISSAN NX 100 (B13) 1990-1994	Suspension Ball Joint - Front Lower
SSP1917	301191619170	NISSAN PRIMERA (P11) 06/1996-12/2001	Suspension Ball Joint - Front Lower
SSP1917	301191619170	NISSAN PULSAR (N14) 1990-1995	Suspension Ball Joint - Front Lower
SSP1917	301191619170	NISSAN SENTRA (B13-N14) 1990-1995	Suspension Ball Joint - Front Lower
SSP1917	301191619170	NISSAN SENTRA (B14) 1995-1999	Suspension Ball Joint - Front Lower
SSP1917	301191619170	NISSAN SUNNY (B13-N14) 1990-1995	Suspension Ball Joint - Front Lower
SSP1917	301191619170	NISSAN SUNNY (B14) 1995-1999	Suspension Ball Joint - Front Lower
SSP1918	301191619180	NISSAN MICRA (K11) 08/1992-01/2003	Suspension Ball Joint - Front Lower
SSP1919	301191619190	NISSAN MICRA (K12) 02/2003-05/2010	Suspension Ball Joint - Front
SSP1919	301191619190	NISSAN NOTE (E11) 03/2006-05/2013	Suspension Ball Joint - Front
SSP1920	301191619200	NISSAN MARCH (K13) 06/2010-	Suspension Ball Joint - Front
SSP1920	301191619200	NISSAN MICRA (K13) 06/2010-	Suspension Ball Joint - Front
SSP1920	301191619200	NISSAN VERSA NOTE (E12) 06/2013-	Suspension Ball Joint - Front
SSP1921	301191619210	INFINITI QX4 R50 1997-2004	Suspension Ball Joint - Front Lower
SSP1921	301191619210	NISSAN PATHFINDER (R50) 1997-2004	Suspension Ball Joint - Front Lower
SSP1922	301191619220	NISSAN FRONTIER (D40) 07/2005-	Suspension Ball Joint - Front Lower
SSP1922	301191619220	NISSAN NAVARA (D40) 07/2005-	Suspension Ball Joint - Front Lower
SSP1922	301191619220	NISSAN PATHFINDER (R51) 03/2005-05/2014	Suspension Ball Joint - Front Lower
SSP1923	301191619230	NISSAN FRONTIER (D40) 07/2005-	Suspension Ball Joint - Front
SSP1923	301191619230	NISSAN NAVARA (D40) 07/2005-	Suspension Ball Joint - Front
SSP1923	301191619230	NISSAN PATHFINDER (R51) 03/2005-05/2014	Suspension Ball Joint - Front
SSP1924	301191619240	NISSAN ALMERA (N16) 08/2000-07/2006	Suspension Ball Joint - Front Lower
SSP1924	301191619240	NISSAN MAXIMA (A33), MAXIMA QX 1999-2003	Suspension Ball Joint - Front Lower
SSP1924	301191619240	NISSAN PRIMERA (P12) 01/2002-05/2008	Suspension Ball Joint - Front Lower
SSP1925	301191619250	NISSAN CUBE 3rd Gen, (Z12) 2009-2014	Suspension Ball Joint - Front Lower
SSP1925	301191619250	NISSAN JUKE 06/2010-	Suspension Ball Joint - Front Lower
SSP1925	301191619250	NISSAN LEAF 2010-	Suspension Ball Joint - Front Lower
SSP1925	301191619250	NISSAN SENTRA (B16) 2007-2012	Suspension Ball Joint - Front Lower
SSP1925	301191619250	NISSAN TIIDA (C11) 07/2004-08/2012	Suspension Ball Joint - Front Lower
SSP1925	301191619250	NISSAN VERSA 2004-2012	Suspension Ball Joint - Front Lower
SSP1926	301191619260	NISSAN QASHQAI (J10, JJ10) 02/2007-01/2014	Suspension Ball Joint - Front Lower
SSP1926	301191619260	NISSAN QASHQAI II (J11) 02/2014-	Suspension Ball Joint - Front Lower
SSP1926	301191619260	NISSAN ROGUE 1st Gen 2008-2014	Suspension Ball Joint - Front Lower
SSP1926	301191619260	NISSAN ROGUE 2nd Gen 2013-	Suspension Ball Joint - Front Lower
SSP1926	301191619260	NISSAN X-TRAIL 2nd Gen (T31) 06/2007-09/2013	Suspension Ball Joint - Front Lower
SSP1926	301191619260	NISSAN X-TRAIL 3rd Gen (T32) 2013-	Suspension Ball Joint - Front Lower
SSP1926	301191619260	RENAULT KADJAR 2015-	Suspension Ball Joint - Front Lower
SSP1926	301191619260	RENAULT KOLEOS 09/2008-	Suspension Ball Joint - Front Lower



 SHORT LONG			DESCRIPTION
SSP1927	301191619270	CHEVROLET Chevy Monza / MONZA(MEXICO) 1994-2001	Suspension Ball Joint - Front
SSP1927	301191619270	OPEL CORSA (A) 09/1982-02/1993	Suspension Ball Joint - Front
SSP1927	301191619270	OPEL CORSA (B) 73,78,79 08/1999-08/2000	Suspension Ball Joint - Front
SSP1927	301191619270	VAUXHALL CORSA 1993-1997	Suspension Ball Joint - Front
SSP1927	301191619270	VAUXHALL CORSA COMBO 1993-1997	Suspension Ball Joint - Front
SSP1927	301191619270	VAUXHALL NOVA 1982-1993	Suspension Ball Joint - Front
SSP1927	301191619270	VAUXHALL TIGRA 1994-1997	Suspension Ball Joint - Front
SSP1928	301191619280	CHEVROLET Chevy Pickup /MONZA/PICK-UPIMPORT 1999-2001	Suspension Ball Joint - Front
SSP1928	301191619280	OPEL COMBO (B) 03/1993-08/2000	Suspension Ball Joint - Front
SSP1928	301191619280	OPEL CORSA (B) 03/1993-08/2000	Suspension Ball Joint - Front
SSP1928	301191619280	VAUXHALL CORSA 1997-2000	Suspension Ball Joint - Front
SSP1928	301191619280	VAUXHALL CORSA COMBO 1997-	Suspension Ball Joint - Front
SSP1928	301191619280	VAUXHALL TIGRA 1997-	Suspension Ball Joint - Front
SSP1929	301191619290	CHEVROLET Chevy Pickup /MONZA/PICK-UPIMPORT 2001-2005	Suspension Ball Joint - Front
SSP1929	301191619290	CHEVROLET Tornado 2003-2016	Suspension Ball Joint - Front
SSP1929	301191619290	OPEL COMBO (C) 09/2000-07/2006	Suspension Ball Joint - Front
SSP1929	301191619290	OPEL CORSA (C) 09/2000-07/2006	Suspension Ball Joint - Front
SSP1929	301191619290	OPEL CORSA (Utility) 2003-2010	Suspension Ball Joint - Front
SSP1930	301191619300	OPEL MERIVA (A) 05/2003-05/2010	Suspension Ball Joint - Front Right
SSP1931	301191619310	OPEL MERIVA (A) 05/2003-05/2010	Suspension Ball Joint - Front Left
SSP1932	301191619320	OPEL ASTRA (G) 1998-2004	Suspension Ball Joint - Front
SSP1932	301191619320	OPEL ASTRA (H) 03/2004-11/2009	Suspension Ball Joint - Front
SSP1932	301191619320	OPEL MERIVA (B) 06/2010-	Suspension Ball Joint - Front
SSP1932	301191619320	OPEL OMEGA (B) 04/1994-07/2003	Suspension Ball Joint - Front
SSP1932	301191619320	OPEL VECTRA (B) 1996-07/2002	Suspension Ball Joint - Front
SSP1932	301191619320	OPEL ZAFIRA (A) 1998-2004	Suspension Ball Joint - Front
SSP1932	301191619320	OPEL ZAFIRA (B) (A05) 07/2005-09/2011	Suspension Ball Joint - Front
SSP1932	301191619320	SAAB 9_5 1st Gen YS3E 04/1997-06/2002	Suspension Ball Joint - Front
SSP1932	301191619320	SATURN ASTRA (H) 2008-2009	Suspension Ball Joint - Front
SSP1932	301191619320	VAUXHALL ASTRA 1998-	Suspension Ball Joint - Front
SSP1932	301191619320	VAUXHALL ASTRA COUPE 1998-	Suspension Ball Joint - Front
SSP1932	301191619320	VAUXHALL VECTRA 1996-	Suspension Ball Joint - Front
SSP1932	301191619320	VAUXHALL ZAFIRA 1999-	Suspension Ball Joint - Front
SSP1933	301191619330	OPEL ASTRA (K) 06/2015-	Suspension Ball Joint - Front Lower
SSP1934	301191619340	CITROEN C5 DC 03/2001-08/2004	Suspension Ball Joint - Front Lower
SSP1934	301191619340	CITROEN XANTIA BREAK 1993-2003	Suspension Ball Joint - Front Lower
SSP1934	301191619340	CITROEN XM BREAK 1994-2000	Suspension Ball Joint - Front Lower
SSP1934	301191619340	PEUGEOT 406 10/1995-10/2004	Suspension Ball Joint - Front Lower
SSP1934	301191619340	PEUGEOT 605 1989-1999	Suspension Ball Joint - Front Lower





			DESCRIPTION
SHORT	LONG		
SSP1934	301191619340	PEUGEOT 607 01/2000-11/2010	Suspension Ball Joint - Front Lower
SSP1935	301191619350	CITROEN C6 TD 09/2005-09/2012	Suspension Ball Joint - Front Lower
SSP1935	301191619350	PEUGEOT 407 05/2004-12/2011	Suspension Ball Joint - Front Lower
SSP1936	301191619360	CITROEN C5 RC 04/2004-01/2008	Suspension Ball Joint - Front Upper
SSP1936	301191619360	CITROEN C5 RD 02/2008-	Suspension Ball Joint - Front Upper
SSP1936	301191619360	CITROEN C6 TD 09/2005-09/2012	Suspension Ball Joint - Front Upper
SSP1936	301191619360	PEUGEOT 407 05/2004-12/2011	Suspension Ball Joint - Front Upper
SSP1937	301191619370	PEUGEOT 208 03/2012-	Suspension Ball Joint - Front Lower
SSP1937	301191619370	PEUGEOT 208 GTI 03/2012-	Suspension Ball Joint - Front Lower
SSP1938	301191619380	CITROEN BERLINGO MF 07/1996-	Suspension Ball Joint - Front
SSP1938	301191619380	CITROEN XSARA 1997-2005	Suspension Ball Joint - Front
SSP1938	301191619380	CITROEN ZX 1991-1997	Suspension Ball Joint - Front
SSP1938	301191619380	PEUGEOT PARTNER I 05/1996-	Suspension Ball Joint - Front
SSP1939	301191619390	CITROEN BERLINGO M 04/2008-	Suspension Ball Joint - Front Lower
SSP1939	301191619390	CITROEN C4 GRAND PICASSO UA 02/2007-01/2013	Suspension Ball Joint - Front Lower
SSP1939	301191619390	CITROEN C4 LA 11/2004-10/2009	Suspension Ball Joint - Front Lower
SSP1939	301191619390	PEUGEOT 307 08/2000-12/2008	Suspension Ball Joint - Front Lower
SSP1939	301191619390	PEUGEOT PARTNER II, Tepee 04/2008-	Suspension Ball Joint - Front Lower
SSP1940	301191619400	CITROEN C4 B7 11/2009-	Suspension Ball Joint - Front
SSP1940	301191619400	CITROEN DS5 11/2011-	Suspension Ball Joint - Front
SSP1940	301191619400	PEUGEOT 3008 09/2009-2016	Suspension Ball Joint - Front
SSP1940	301191619400	PEUGEOT 308 09/2007-10/2013	Suspension Ball Joint - Front
SSP1940	301191619400	PEUGEOT 5008 09/2009-	Suspension Ball Joint - Front
SSP1941	301191619410	PEUGEOT 308 II 09/2013-	Suspension Ball Joint - Front Lower
SSP1942	301191619420	PEUGEOT 508 11/2010-	Suspension Ball Joint - Front
SSP1943	301191619430	OPEL VIVARO II 10/2014-	Suspension Ball Joint - Front
SSP1943	301191619430	RENAULT TRAFIC III 10/2014-	Suspension Ball Joint - Front
SSP1944	301191619440	DACIA SOLENZO (S.NOVA) 2003-2007	Suspension Ball Joint - Front Lower
SSP1944	301191619440	RENAULT 19 1991-2001	Suspension Ball Joint - Front Lower
SSP1944	301191619440	RENAULT 21 MANAGER 1986-1994	Suspension Ball Joint - Front Lower
SSP1944	301191619440	RENAULT 9_11 1981-2000	Suspension Ball Joint - Front Lower
SSP1944	301191619440	RENAULT CLIO I 05/1990-09/1998	Suspension Ball Joint - Front Lower
SSP1944	301191619440	RENAULT CLIO II-SYMBOL 10/1998-2012	Suspension Ball Joint - Front Lower
SSP1944	301191619440	RENAULT EXPRESS EXTRA (VAN) 07/1985-03/1998	Suspension Ball Joint - Front Lower
SSP1944	301191619440	RENAULT KANGOO I 03/1998-01/2008	Suspension Ball Joint - Front Lower
SSP1944	301191619440	RENAULT MEGANE I 01/1995-08/2003	Suspension Ball Joint - Front Lower
SSP1944	301191619440	RENAULT SCENIC I 1997-2002	Suspension Ball Joint - Front Lower
SSP1944	301191619440	RENAULT TWINGO (C06) 03/1993-02/2007	Suspension Ball Joint - Front Lower
SSP1945	301191619450	NISSAN KUBISTAR (X76) 08/2003-07/2007	Suspension Ball Joint - Front Lower





 SHORT LONG			DESCRIPTION
SSP1945	301191619450	RENAULT 9_11 1981-2000	Suspension Ball Joint - Front Lower
SSP1945	301191619450	RENAULT CLIO II-SYMBOL 10/1998-2012	Suspension Ball Joint - Front Lower
SSP1945	301191619450	RENAULT KANGOO I 03/1998-01/2008	Suspension Ball Joint - Front Lower
SSP1946	301191619460	NISSAN INTERSTAR (X70) 07/2002-08/2010	Suspension Ball Joint - Front Upper
SSP1946	301191619460	OPEL MOVANO (A) 07/1998-04/2010	Suspension Ball Joint - Front Upper
SSP1946	301191619460	RENAULT MASTER I 07/1998-09/2003	Suspension Ball Joint - Front Upper
SSP1946	301191619460	RENAULT MASTER II 10/2003-01/2010	Suspension Ball Joint - Front Upper
SSP1947	301191619470	NISSAN INTERSTAR (X70) 07/2002-08/2010	Suspension Ball Joint - Front Lower
SSP1947	301191619470	OPEL MOVANO (A) 07/1998-04/2010	Suspension Ball Joint - Front Lower
SSP1947	301191619470	RENAULT MASTER I 07/1998-09/2003	Suspension Ball Joint - Front Lower
SSP1948	301191619480	NISSAN INTERSTAR (X70) 07/2002-08/2010	Suspension Ball Joint - Front
SSP1948	301191619480	OPEL MOVANO (A) 07/1998-04/2010	Suspension Ball Joint - Front
SSP1948	301191619480	RENAULT MASTER I 07/1998-09/2003	Suspension Ball Joint - Front
SSP1948	301191619480	RENAULT MASTER II 10/2003-01/2010	Suspension Ball Joint - Front
SSP1949	301191619490	NISSAN INTERSTAR (X70) 07/2002-08/2010	Suspension Ball Joint - Front Lower
SSP1949	301191619490	OPEL MOVANO (A) 07/1998-04/2010	Suspension Ball Joint - Front Lower
SSP1949	301191619490	RENAULT MASTER II 10/2003-01/2010	Suspension Ball Joint - Front Lower
SSP1950	301191619500	OPEL MOVANO (B) 05/2010-	Suspension Ball Joint - Front Left Lower
SSP1950	301191619500	RENAULT MASTER III 02/2010-	Suspension Ball Joint - Front Left Lower
SSP1951	301191619510	OPEL MOVANO (B) 05/2010-	Suspension Ball Joint - Front Right Lower
SSP1951	301191619510	RENAULT MASTER III 02/2010-	Suspension Ball Joint - Front Right Lower
SSP1952	301191619520	DACIA LOGAN (LS) 09/2004-11/2012	Suspension Ball Joint - Front
SSP1952	301191619520	DACIA LOGAN MCV (KS) 02/2007-01/2013	Suspension Ball Joint - Front
SSP1952	301191619520	DACIA SANDERO I 06/2008-12/2012	Suspension Ball Joint - Front
SSP1952	301191619520	RENAULT CLIO III-HB 06/2005-09/2012	Suspension Ball Joint - Front
SSP1952	301191619520	RENAULT CLIO IV-HB 10/2012-	Suspension Ball Joint - Front
SSP1952	301191619520	RENAULT MEGANE II 09/2003-04/2009	Suspension Ball Joint - Front
SSP1952	301191619520	RENAULT MODUS 12/2004-07/2014	Suspension Ball Joint - Front
SSP1952	301191619520	RENAULT SCENIC II 06/2003-01/2009	Suspension Ball Joint - Front
SSP1953	301191619530	RENAULT MEGANE II 09/2003-04/2009	Suspension Ball Joint - Front Lower
SSP1954	301191619540	NISSAN PRIMASTAR (X83) 08/2002-06/2014	Suspension Ball Joint - Front Lower
SSP1954	301191619540	OPEL VIVARO I 08/2001-06/2014	Suspension Ball Joint - Front Lower
SSP1954	301191619540	RENAULT LAGUNA II 04/2001-09/2007	Suspension Ball Joint - Front Lower
SSP1954	301191619540	RENAULT TRAFIC II 03/2001-09/2014	Suspension Ball Joint - Front Lower
SSP1955	301191619550	OPEL VIVARO I 08/2001-06/2014	Suspension Ball Joint - Front Lower
SSP1955	301191619550	RENAULT TRAFIC II 03/2001-09/2014	Suspension Ball Joint - Front Lower
SSP1956	301191619560	RENAULT FLUENCE 02/2010-	Suspension Ball Joint - Front Lower
SSP1956	301191619560	RENAULT MEGANE III 05/2009-10/2015	Suspension Ball Joint - Front Lower
SSP1956	301191619560	RENAULT SCENIC III 02/2009-	Suspension Ball Joint - Front Lower
SSP1957	301191619570	RENAULT TWINGO II (CNO) 03/2007-	Suspension Ball Joint - Front Lower
SSP1958	301191619580	RENAULT LAGUNA III 10/2007-	Suspension Ball Joint - Front Lower





			DESCRIPTION
SHORT	LONG		
SSP1959	301191619590	RENAULT MEGANE IV 2016-	Suspension Ball Joint - Front
SSP1960	301191619600	RENAULT ESPACE 2015-	Suspension Ball Joint - Front
SSP1960	301191619600	RENAULT TALISMAN 1st Gen 2015-	Suspension Ball Joint - Front
SSP1961	301191619610	SEAT CORDOBA (6L2) 09/2002-11/2009	Suspension Ball Joint - Front Right Lower
SSP1961	301191619610	SEAT IBIZA IV (6L1) 02/2002-11/2009	Suspension Ball Joint - Front Right Lower
SSP1961	301191619610	SKODA FABIA (6Y2) 08/1999-11/2006	Suspension Ball Joint - Front Right Lower
SSP1961	301191619610	VOLKSWAGEN POLO (9N) 10/2001-05/2009	Suspension Ball Joint - Front Right Lower
SSP1962	301191619620	SEAT CORDOBA (6L2) 09/2002-11/2009	Suspension Ball Joint - Front Left Lower
SSP1962	301191619620	SEAT IBIZA IV (6L1) 02/2002-11/2009	Suspension Ball Joint - Front Left Lower
SSP1962	301191619620	SKODA FABIA (6Y2) 08/1999-11/2006	Suspension Ball Joint - Front Left Lower
SSP1962	301191619620	VOLKSWAGEN POLO (9N) 10/2001-05/2009	Suspension Ball Joint - Front Left Lower
SSP1963	301191619630	AUDI A1 8X1 04/2010-	Suspension Ball Joint - Front Right Lower
SSP1963	301191619630	SEAT IBIZA V (6R) 03/2008-	Suspension Ball Joint - Front Right Lower
SSP1963	301191619630	SEAT Mii (KYF) 10/2011-	Suspension Ball Joint - Front Right Lower
SSP1963	301191619630	SKODA FABIA (5J) 12/2006-09/2014	Suspension Ball Joint - Front Right Lower
SSP1963	301191619630	SKODA PRAKTIK 03/2007-	Suspension Ball Joint - Front Right Lower
SSP1963	301191619630	SKODA RAPID 07/2012-	Suspension Ball Joint - Front Right Lower
SSP1963	301191619630	SKODA ROOMSTER (5J) 07/2006-	Suspension Ball Joint - Front Right Lower
SSP1963	301191619630	VOLKSWAGEN POLO (6R) 06/2009-	Suspension Ball Joint - Front Right Lower
SSP1963	301191619630	VOLKSWAGEN Up! 12/2011-2016	Suspension Ball Joint - Front Right Lower
SSP1964	301191619640	AUDI A1 8X1 04/2010-	Suspension Ball Joint - Front Left Lower
SSP1964	301191619640	SEAT IBIZA V (6R) 03/2008-	Suspension Ball Joint - Front Left Lower
SSP1964	301191619640	SEAT Mii (KYF) 10/2011-	Suspension Ball Joint - Front Left Lower
SSP1964	301191619640	SKODA FABIA (5J) 12/2006-09/2014	Suspension Ball Joint - Front Left Lower
SSP1964	301191619640	SKODA PRAKTIK 03/2007-	Suspension Ball Joint - Front Left Lower
SSP1964	301191619640	SKODA RAPID 07/2012-	Suspension Ball Joint - Front Left Lower
SSP1964	301191619640	SKODA ROOMSTER (5J) 07/2006-	Suspension Ball Joint - Front Left Lower
SSP1964	301191619640	VOLKSWAGEN POLO (6R) 06/2009-	Suspension Ball Joint - Front Left Lower
SSP1964	301191619640	VOLKSWAGEN Up! 12/2011-2016	Suspension Ball Joint - Front Left Lower
SSP1965	301191619650	CHEVROLET METRO 1998-2001	Suspension Ball Joint - Front Lower
SSP1965	301191619650	SUZUKI SWIFT II (AH,AJ) (EA,MA) 03/1989-12/2004	Suspension Ball Joint - Front Lower
SSP1966	301191619660	LEXUS LX470 J100 1998-2007	Suspension Ball Joint - Front Lower
SSP1966	301191619660	TOYOTA LAND CRUISER J100 01/1998-08/2007	Suspension Ball Joint - Front Lower
SSP1967	301191619670	TOYOTA LAND CRUISER J100 01/1998-08/2007	Suspension Ball Joint - Upper
SSP1968	301191619680	TOYOTA RAV4 XA10 1995-06/2000	Suspension Ball Joint - Front
SSP1969	301191619690	TOYOTA HILUX III 2WD Pick-Up 08/2005-2015	Suspension Ball Joint - Front Lower
SSP1969	301191619690	TOYOTA HILUX III 4WD Pick-Up 08/2005-2015	Suspension Ball Joint - Front Lower





 SHORT LONG			DESCRIPTION
SSP1970	301191619700	TOYOTA HILUX III 2WD Pick-Up 08/2005-2015	Suspension Ball Joint - Front
SSP1970	301191619700	TOYOTA HILUX III 4WD Pick-Up 08/2005-2015	Suspension Ball Joint - Front
SSP1971	301191619710	CITROEN C1 06/2005-03/2014	Suspension Ball Joint - Front Lower
SSP1971	301191619710	PEUGEOT 1007 (KM) 04/2005-2010	Suspension Ball Joint - Front Lower
SSP1971	301191619710	PEUGEOT 107 06/2005-	Suspension Ball Joint - Front Lower
SSP1971	301191619710	TOYOTA AYGO 07/2005-09/2014	Suspension Ball Joint - Front Lower
SSP1971	301191619710	TOYOTA ECHO XP10 1999-2005	Suspension Ball Joint - Front Lower
SSP1971	301191619710	TOYOTA IQ 01/2009-2016	Suspension Ball Joint - Front Lower
SSP1971	301191619710	TOYOTA YARIS (P1) 04/1999-10/2005	Suspension Ball Joint - Front Lower
SSP1971	301191619710	TOYOTA YARIS (P13) 10/2010-	Suspension Ball Joint - Front Lower
SSP1971	301191619710	TOYOTA YARIS (P9) 11/2005-09/2010	Suspension Ball Joint - Front Lower
SSP1972	301191619720	TOYOTA CELICA 08/1999-09/2005	Suspension Ball Joint - Front Lower
SSP1972	301191619720	TOYOTA COROLLA E120 02/2002-01/2007	Suspension Ball Joint - Front Lower
SSP1972	301191619720	TOYOTA PRIUS XW30 01/2009-2015	Suspension Ball Joint - Front Lower
SSP1972	301191619720	TOYOTA RAV4 XA20 07/2000-11/2005	Suspension Ball Joint - Front Lower
SSP1973	301191619730	TOYOTA COROLLA Verso 04/2004-04/2009	Suspension Ball Joint - Front Lower
SSP1974	301191619740	LEXUS HS250h 2010-2012	Suspension Ball Joint - Front
SSP1974	301191619740	SCION XB 2nd Gen 2008-2013	Suspension Ball Joint - Front
SSP1974	301191619740	TOYOTA AURIS I 02/2007-06/2013	Suspension Ball Joint - Front
SSP1974	301191619740	TOYOTA AURIS II 07/2013-	Suspension Ball Joint - Front
SSP1974	301191619740	TOYOTA COROLLA E140 02/2007-06/2013	Suspension Ball Joint - Front
SSP1974	301191619740	TOYOTA COROLLA E170 07/2013-	Suspension Ball Joint - Front
SSP1974	301191619740	TOYOTA RAV4 XA30 12/2005-2012	Suspension Ball Joint - Front
SSP1974	301191619740	TOYOTA RAV4 XA40 2013-	Suspension Ball Joint - Front
SSP1975	301191619750	TOYOTA 4RUNNER N180 3rd Gen 1996-2002	Suspension Ball Joint - Front Upper
SSP1975	301191619750	TOYOTA LAND CRUISER J90 1996-2002	Suspension Ball Joint - Front Upper
SSP1975	301191619750	TOYOTA SEQUOIA 1st Gen 2000-2007	Suspension Ball Joint - Front Upper
SSP1975	301191619750	TOYOTA TUNDRA 1st Gen 2000-2007	Suspension Ball Joint - Front Upper
SSP1976	301191619760	AUDI A3 8P1 06/2003-08/2012	Suspension Ball Joint - Front Right Lower
SSP1976	301191619760	AUDI A3 8V1 09/2012-	Suspension Ball Joint - Front Right Lower
SSP1976	301191619760	AUDI Q3 8U 06/2011-2016	Suspension Ball Joint - Front Right Lower
SSP1976	301191619760	SEAT ALTEA V 03/2004-	Suspension Ball Joint - Front Right Lower
SSP1976	301191619760	SEAT LEON (5F1) 12/2012-	Suspension Ball Joint - Front Right Lower
SSP1976	301191619760	SEAT LEON 1P1 2006-2012	Suspension Ball Joint - Front Right Lower
SSP1976	301191619760	SEAT TOLEDO III (5P2) 07/2006-05/2009	Suspension Ball Joint - Front Right Lower
SSP1976	301191619760	SKODA OCTAVIA (1Z3), (1Z5) 06/2004-10/2012	Suspension Ball Joint - Front Right Lower
SSP1976	301191619760	SKODA OCTAVIA (5 E) 11/2012-	Suspension Ball Joint - Front Right Lower
SSP1976	301191619760	SKODA YETI (5L) 05/2009-	Suspension Ball Joint - Front Right Lower
SSP1976	301191619760	VOLKSWAGEN BEETLE A5 04/2011-	Suspension Ball Joint - Front Right Lower





 SHORT LONG			DESCRIPTION
SSP1976	301191619760	VOLKSWAGEN CADDY Typ 2K 03/2004-04/2015	Suspension Ball Joint - Front Right Lower
SSP1976	301191619760	VOLKSWAGEN EOS 2006-2016	Suspension Ball Joint - Front Right Lower
SSP1976	301191619760	VOLKSWAGEN GOLF MK5/A5 10/2003-06/2009	Suspension Ball Joint - Front Right Lower
SSP1976	301191619760	VOLKSWAGEN GOLF MK6/A6 2010-2013	Suspension Ball Joint - Front Right Lower
SSP1976	301191619760	VOLKSWAGEN GTI MK5/A5 2006-2009	Suspension Ball Joint - Front Right Lower
SSP1976	301191619760	VOLKSWAGEN JETTA IV (162) 11/2010-	Suspension Ball Joint - Front Right Lower
SSP1976	301191619760	VOLKSWAGEN JETTA MK5/A5 08/2005-10/2010	Suspension Ball Joint - Front Right Lower
SSP1976	301191619760	VOLKSWAGEN Rabbit MK5/A5 10/2003-06/2009	Suspension Ball Joint - Front Right Lower
SSP1976	301191619760	VOLKSWAGEN TOURAN (1T1,1T2) 02/2003-05/2010	Suspension Ball Joint - Front Right Lower
SSP1976	301191619760	VOLKSWAGEN TOURAN (1T3) 06/2010-	Suspension Ball Joint - Front Right Lower
SSP1977	301191619770	AUDI A3 8P1 06/2003-08/2012	Suspension Ball Joint - Front Left Lower
SSP1977	301191619770	AUDI A3 8V1 09/2012-	Suspension Ball Joint - Front Left Lower
SSP1977	301191619770	AUDI Q3 8U 06/2011-2016	Suspension Ball Joint - Front Left Lower
SSP1977	301191619770	SEAT ALTEA V 03/2004-	Suspension Ball Joint - Front Left Lower
SSP1977	301191619770	SEAT LEON (5F1) 12/2012-	Suspension Ball Joint - Front Left Lower
SSP1977	301191619770	SEAT LEON 1P1 2006-2012	Suspension Ball Joint - Front Left Lower
SSP1977	301191619770	SEAT TOLEDO III (5P2) 07/2006-05/2009	Suspension Ball Joint - Front Left Lower
SSP1977	301191619770	SKODA OCTAVIA (1Z3), (1Z5) 06/2004-10/2012	Suspension Ball Joint - Front Left Lower
SSP1977	301191619770	SKODA OCTAVIA (5 E) 11/2012-	Suspension Ball Joint - Front Left Lower
SSP1977	301191619770	SKODA SUPERB (3T4) 04/2008-	Suspension Ball Joint - Front Left Lower
SSP1977	301191619770	SKODA YETI (5L) 05/2009-	Suspension Ball Joint - Front Left Lower
SSP1977	301191619770	VOLKSWAGEN BEETLE A5 04/2011-	Suspension Ball Joint - Front Left Lower
SSP1977	301191619770	VOLKSWAGEN CADDY Typ 2K 03/2004-04/2015	Suspension Ball Joint - Front Left Lower
SSP1977	301191619770	VOLKSWAGEN EOS 2006-2016	Suspension Ball Joint - Front Left Lower
SSP1977	301191619770	VOLKSWAGEN GOLF MK5/A5 10/2003-06/2009	Suspension Ball Joint - Front Left Lower
SSP1977	301191619770	VOLKSWAGEN GOLF MK6/A6 2010-2013	Suspension Ball Joint - Front Left Lower
SSP1977	301191619770	VOLKSWAGEN GTI MK5/A5 2006-2009	Suspension Ball Joint - Front Left Lower
SSP1977	301191619770	VOLKSWAGEN JETTA IV (162) 11/2010-	Suspension Ball Joint - Front Left Lower
SSP1977	301191619770	VOLKSWAGEN JETTA MK5/A5 08/2005-10/2010	Suspension Ball Joint - Front Left Lower
SSP1977	301191619770	VOLKSWAGEN Rabbit MK5/A5 10/2003-06/2009	Suspension Ball Joint - Front Left Lower
SSP1977	301191619770	VOLKSWAGEN TOURAN (1T1,1T2) 02/2003-05/2010	Suspension Ball Joint - Front Left Lower
SSP1977	301191619770	VOLKSWAGEN TOURAN (1T3) 06/2010-	Suspension Ball Joint - Front Left Lower
SSP1978	301191619780	VOLKSWAGEN GOLF MK7/MQB 11/2012-	Suspension Ball Joint - Front Right Lower
SSP1979	301191619790	VOLKSWAGEN GOLF MK7/MQB 11/2012-	Suspension Ball Joint - Front Left Lower





 SHORT LONG			DESCRIPTION
SSP1980	301191619800	VOLKSWAGEN JETTA MK5/A5 08/2005-10/2010	Suspension Ball Joint - Right
SSP1980	301191619800	VOLKSWAGEN PASSAT B6 09/2005-07/2010	Suspension Ball Joint - Right
SSP1980	301191619800	VOLKSWAGEN PASSAT B7 08/2010-04/2015	Suspension Ball Joint - Right
SSP1980	301191619800	VOLKSWAGEN TIGUAN 1st Gen 09/2007-2016	Suspension Ball Joint - Right
SSP1981	301191619810	VOLKSWAGEN JETTA MK5/A5 08/2005-10/2010	Suspension Ball Joint - Front Left
SSP1981	301191619810	VOLKSWAGEN PASSAT B6 09/2005-07/2010	Suspension Ball Joint - Front Left
SSP1981	301191619810	VOLKSWAGEN PASSAT B7 08/2010-04/2015	Suspension Ball Joint - Front Left
SSP1981	301191619810	VOLKSWAGEN TIGUAN 1st Gen 09/2007-2016	Suspension Ball Joint - Front Left
SSP1982	301191619820	VOLKSWAGEN TRANSPORTER T5 05/2003-04/2011	Suspension Ball Joint - Front Lower
SSP1982	301191619820	VOLKSWAGEN TRANSPORTER T5, facelift 05/2011-2016	Suspension Ball Joint - Front Lower
SSP1982	301191619820	VOLKSWAGEN TRANSPORTER T6 2016-	Suspension Ball Joint - Front Lower
SSP1983	301191619830	VOLKSWAGEN TRANSPORTER T5 05/2003-04/2011	Suspension Ball Joint - Front
SSP1983	301191619830	VOLKSWAGEN TRANSPORTER T5, facelift 05/2011-2016	Suspension Ball Joint - Front
SSP1983	301191619830	VOLKSWAGEN TRANSPORTER T6 2016-	Suspension Ball Joint - Front
SSP1984	301191619840	FORD GALAXY 05/1995-04/2006	Suspension Ball Joint - Front
SSP1984	301191619840	SEAT ALHAMBRA (7V8,7V9) 04/1996-03/2010	Suspension Ball Joint - Front
SSP1984	301191619840	VOLKSWAGEN SHARAN (7M6,7M8,7M9) 05/1995-03/2010	Suspension Ball Joint - Front
SSP1985	301191619850	SEAT AROSA 05/1997-06/2004	Suspension Ball Joint - Right
SSP1985	301191619850	VOLKSWAGEN LUPO 09/1998-07/2005	Suspension Ball Joint - Right
SSP1985	301191619850	VOLKSWAGEN POLO (6N1) 1994-09/2001	Suspension Ball Joint - Right
SSP1986	301191619860	SEAT AROSA 05/1997-06/2004	Suspension Ball Joint - Front Left Lower
SSP1986	301191619860	VOLKSWAGEN LUPO 09/1998-07/2005	Suspension Ball Joint - Front Left Lower
SSP1986	301191619860	VOLKSWAGEN POLO (6N1) 1994-09/2001	Suspension Ball Joint - Front Left Lower
SSP1987	301191619870	MITSUBISHI CARISMA 07/1995-09/2000	Suspension Ball Joint - Front
SSP1987	301191619870	MITSUBISHI GALANT III 06/1983-10/1988	Suspension Ball Joint - Front
SSP1987	301191619870	VOLVO S40 I (VS) 07/1995-12/2003	Suspension Ball Joint - Front
SSP1987	301191619870	VOLVO V40 I (VW) 07/1995-06/2004	Suspension Ball Joint - Front
SSP1988	301191619880	VOLVO S60 I 07/2000-04/2010	Suspension Ball Joint - Front Lower
SSP1988	301191619880	VOLVO S80 I (TS,XY) 05/1998-07/2006	Suspension Ball Joint - Front Lower
SSP1988	301191619880	VOLVO V70 II (P80) 03/2000-08/2007	Suspension Ball Joint - Front Lower
SSP1988	301191619880	VOLVO XC70 II Cross Country 03/2000-08/2007	Suspension Ball Joint - Front Lower
SSP1989	301191619890	VOLVO XC90 I 10/2002-10/2014	Suspension Ball Joint - Front Lower
SSP1990	301191619900	VOLVO XC60 05/2008-2016	Suspension Ball Joint - Front Lower
SSP1990	301191619900	VOLVO XC70 III 08/2007-	Suspension Ball Joint - Front Lower
SSP1991	301191619910	VOLVO V40 II 03/2012-	Suspension Ball Joint - Front Right





 SHORT LONG			DESCRIPTION
SSP1992	301191619920	VOLVO V40 II 03/2012-	Suspension Ball Joint - Front Left
SSP1993	301191619930	AUDI TT 8J3 07/2006-06/2014	Suspension Ball Joint Kit - Front Right Lower
SSP1994	301191619940	AUDI TT 8J3 07/2006-06/2014	Suspension Ball Joint Kit - Front Left Lower
SSP1995	301191619950	MITSUBISHI PAJERO III 04/2000-01/2007	Suspension Ball Joint Kit - Front Lower
SSP1996	301191619960	CITROEN C5 RD 02/2008-	Suspension Ball Joint Kit - Front Lower
SSP1996	301191619960	CITROEN C6 TD 09/2005-09/2012	Suspension Ball Joint Kit - Front Lower
SSP1996	301191619960	PEUGEOT 407 05/2004-12/2011	Suspension Ball Joint Kit - Front Lower
SSP1997	301191619970	VOLKSWAGEN TRANSPORTER T5 05/2003-04/2011	Suspension Ball Joint Kit - Front Lower
SSP1998	301191619980	SEAT AROSA 05/1997-06/2004	Suspension Ball Joint Kit - Front Right
SSP1998	301191619980	VOLKSWAGEN LUPO 09/1998-07/2005	Suspension Ball Joint Kit - Front Right
SSP1998	301191619980	VOLKSWAGEN POLO (6N1) 1994-09/2001	Suspension Ball Joint Kit - Front Right
SSP1999	301191619990	SEAT AROSA 05/1997-06/2004	Suspension Ball Joint Kit - Front Left
SSP1999	301191619990	VOLKSWAGEN LUPO 09/1998-07/2005	Suspension Ball Joint Kit - Front Left
SSP1999	301191619990	VOLKSWAGEN POLO (6N1) 1994-09/2001	Suspension Ball Joint Kit - Front Left
SSP2000	301191620000	AUDI 80 1992-1994	Suspension Stabilizer Bar Link - Rear Right
SSP2000	301191620000	AUDI 90 1992-1994	Suspension Stabilizer Bar Link - Rear Right
SSP2000	301191620000	AUDI A4 8D2, 8E5, B5 11/1994-10/2001	Suspension Stabilizer Bar Link - Rear Right
SSP2000	301191620000	AUDI COUPE 1988-1996	Suspension Stabilizer Bar Link - Rear Right
SSP2000	301191620000	AUDI COUPE QUATTRO 1984-1987	Suspension Stabilizer Bar Link - Rear Right
SSP2001	301191620010	AUDI 80 1992-1994	Suspension Stabilizer Bar Link - Rear Left
SSP2001	301191620010	AUDI 90 1992-1994	Suspension Stabilizer Bar Link - Rear Left
SSP2001	301191620010	AUDI A4 8D2, 8E5, B5 11/1994-10/2001	Suspension Stabilizer Bar Link - Rear Left
SSP2001	301191620010	AUDI COUPE 1988-1996	Suspension Stabilizer Bar Link - Rear Left
SSP2001	301191620010	AUDI COUPE QUATTRO 1984-1987	Suspension Stabilizer Bar Link - Rear Left
SSP2002	301191620020	AUDI A3 8L1 09/1996-05/2003	Suspension Stabilizer Bar Link - Front Left
SSP2002	301191620020	AUDI TT 8N3, ROADSTER, 8N9 02/1999-06/2006	Suspension Stabilizer Bar Link - Front Left
SSP2002	301191620020	SEAT LEON 1M1 03/1999-05/2006	Suspension Stabilizer Bar Link - Front Left
SSP2002	301191620020	SEAT TOLEDO II (1M2) 03/1999-05/2006	Suspension Stabilizer Bar Link - Front Left
SSP2002	301191620020	VOLKSWAGEN BEETLE 9C1, 1C1 1998-2010	Suspension Stabilizer Bar Link - Front Left
SSP2002	301191620020	VOLKSWAGEN GOLF MK4/A4 1998-09/2003	Suspension Stabilizer Bar Link - Front Left
SSP2002	301191620020	VOLKSWAGEN JETTA MK4/A4 1998-09/2003	Suspension Stabilizer Bar Link - Front Left
SSP2003	301191620030	AUDI A3 8L1 09/1996-05/2003	Suspension Stabilizer Bar Link - Front Left
SSP2003	301191620030	AUDI TT 8N3, ROADSTER, 8N9 02/1999-06/2006	Suspension Stabilizer Bar Link - Front Left
SSP2003	301191620030	SEAT TOLEDO II (1M2) 03/1999-05/2006	Suspension Stabilizer Bar Link - Front Left
SSP2003	301191620030	VOLKSWAGEN GOLF MK4/A4 1998-09/2003	Suspension Stabilizer Bar Link - Front Left
SSP2004	301191620040	AUDI A3 8L1 09/1996-05/2003	Suspension Stabilizer Bar Link - Front Right
SSP2004	301191620040	AUDI TT 8N3, ROADSTER, 8N9 02/1999-06/2006	Suspension Stabilizer Bar Link - Front Right
SSP2004	301191620040	SEAT LEON 1M1 03/1999-05/2006	Suspension Stabilizer Bar Link - Front Right



 SHORT LONG			DESCRIPTION
SSP2004	301191620040	SEAT TOLEDO II (1M2) 03/1999-05/2006	Suspension Stabilizer Bar Link - Front Right
SSP2004	301191620040	VOLKSWAGEN BEETLE 9C1, 1C1 1998-2010	Suspension Stabilizer Bar Link - Front Right
SSP2004	301191620040	VOLKSWAGEN GOLF MK4/A4 1998-09/2003	Suspension Stabilizer Bar Link - Front Right
SSP2004	301191620040	VOLKSWAGEN JETTA MK4/A4 1998-09/2003	Suspension Stabilizer Bar Link - Front Right
SSP2005	301191620050	AUDI A4 8D2, 8E5, B5 11/1994-10/2001	Suspension Stabilizer Bar Link - Front
SSP2005	301191620050	AUDI A6 4B, C5 01/1997-01/2005	Suspension Stabilizer Bar Link - Front
SSP2005	301191620050	AUDI A8 4D2, 4D8 03/1994-09/2002	Suspension Stabilizer Bar Link - Front
SSP2005	301191620050	VOLKSWAGEN PASSAT B5, B5.5 1997-08/2005	Suspension Stabilizer Bar Link - Front
SSP2006	301191620060	AUDI A2 02/2000-08/2005	Suspension Stabilizer Bar Link - Front
SSP2007	301191620070	AUDI A4 8D2, 8E5, B5 11/1994-10/2001	Suspension Stabilizer Bar Link - Front Right
SSP2007	301191620070	AUDI A6 4B, C5 01/1997-01/2005	Suspension Stabilizer Bar Link - Front Right
SSP2007	301191620070	SKODA SUPERB (3U4) 02/2002-03/2008	Suspension Stabilizer Bar Link - Front Right
SSP2007	301191620070	VOLKSWAGEN PASSAT B5, B5.5 1997-08/2005	Suspension Stabilizer Bar Link - Front Right
SSP2008	301191620080	AUDI A4 8D2, 8E5, B5 11/1994-10/2001	Suspension Stabilizer Bar Link - Front Left
SSP2008	301191620080	AUDI A6 4B, C5 01/1997-01/2005	Suspension Stabilizer Bar Link - Front Left
SSP2008	301191620080	SKODA SUPERB (3U4) 02/2002-03/2008	Suspension Stabilizer Bar Link - Front Left
SSP2008	301191620080	VOLKSWAGEN PASSAT B5, B5.5 1997-08/2005	Suspension Stabilizer Bar Link - Front Left
SSP2009	301191620090	AUDI A4 8D2, 8E5, B5 11/1994-10/2001	Suspension Stabilizer Bar Link - Front
SSP2009	301191620090	AUDI A6 4B, C5 01/1997-01/2005	Suspension Stabilizer Bar Link - Front
SSP2009	301191620090	VOLKSWAGEN PASSAT B5, B5.5 1997-08/2005	Suspension Stabilizer Bar Link - Front
SSP2010	301191620100	AUDI A8 4D2, 4D8 03/1994-09/2002	Suspension Stabilizer Bar Link - Rear
SSP2011	301191620110	AUDI A6 4A, 4C 1994-1997	Suspension Stabilizer Bar Link - Rear
SSP2011	301191620110	AUDI A8 4D2, 4D8 03/1994-09/2002	Suspension Stabilizer Bar Link - Rear
SSP2012	301191620120	AUDI A8 4D2, 4D8 03/1994-09/2002	Suspension Stabilizer Bar Link - Rear Right
SSP2012	301191620120	AUDI A8 4E 10/2002-07/2010	Suspension Stabilizer Bar Link - Rear Right
SSP2012	301191620120	VOLKSWAGEN PHAETON 04/2002-2016	Suspension Stabilizer Bar Link - Rear Right
SSP2013	301191620130	AUDI A8 4D2, 4D8 03/1994-09/2002	Suspension Stabilizer Bar Link - Rear Left
SSP2013	301191620130	AUDI A8 4E 10/2002-07/2010	Suspension Stabilizer Bar Link - Rear Left
SSP2013	301191620130	VOLKSWAGEN PHAETON 04/2002-2016	Suspension Stabilizer Bar Link - Rear Left
SSP2014	301191620140	AUDI A4 8E2, 8E5, B6 12/2001-12/2004	Suspension Stabilizer Bar Link - Front Right
SSP2014	301191620140	AUDI A4 8EC, 8ED 11/2004-06/2008	Suspension Stabilizer Bar Link - Front Right
SSP2014	301191620140	SEAT EXEO 2008-2013	Suspension Stabilizer Bar Link - Front Right
SSP2015	301191620150	AUDI A4 8E2, 8E5, B6 12/2001-12/2004	Suspension Stabilizer Bar Link - Front Left
SSP2015	301191620150	AUDI A4 8EC, 8ED 11/2004-06/2008	Suspension Stabilizer Bar Link - Front Left
SSP2015	301191620150	SEAT EXEO 2008-2013	Suspension Stabilizer Bar Link - Front Left
SSP2016	301191620160	AUDI A4 8E2, 8E5, B6 12/2001-12/2004	Suspension Stabilizer Bar Link - Rear
SSP2017	301191620170	AUDI A4 8E2, 8E5, B6 12/2001-12/2004	Suspension Stabilizer Bar Link - Rear
SSP2018	301191620180	VOLKSWAGEN PASSAT B5, B5.5 1997-08/2005	Suspension Stabilizer Bar Link - Rear



 SHORT LONG			DESCRIPTION
SSP2019	301191620190	AUDI A6 4F2, C6 02/2005-03/2011	Suspension Stabilizer Bar Link - Rear
SSP2020	301191620200	AUDI A6 4F2, C6 02/2005-03/2011	Suspension Stabilizer Bar Link - Front
SSP2020	301191620200	AUDI A8 4E 10/2002-07/2010	Suspension Stabilizer Bar Link - Front
SSP2020	301191620200	VOLKSWAGEN PHAETON 04/2002-2016	Suspension Stabilizer Bar Link - Front
SSP2021	301191620210	AUDI A6 4F2, C6 02/2005-03/2011	Suspension Stabilizer Bar Link - Rear
SSP2022	301191620220	AUDI A4 8K2, 8K5 11/2007-06/2015	Suspension Stabilizer Bar Link - Front
SSP2022	301191620220	AUDI A5 8T3 2007-2015	Suspension Stabilizer Bar Link - Front
SSP2022	301191620220	AUDI A8 4H 08/2010-	Suspension Stabilizer Bar Link - Front
SSP2023	301191620230	AUDI A3 8L1 09/1996-05/2003	Suspension Stabilizer Bar Link - Rear
SSP2023	301191620230	AUDI TT 8N3, ROADSTER, 8N9 02/1999-06/2006	Suspension Stabilizer Bar Link - Rear
SSP2023	301191620230	VOLKSWAGEN BEETLE 9C1, 1C1 1998-2010	Suspension Stabilizer Bar Link - Rear
SSP2023	301191620230	VOLKSWAGEN GOLF MK4/A4 1998-09/2003	Suspension Stabilizer Bar Link - Rear
SSP2023	301191620230	VOLKSWAGEN JETTA MK4/A4 1998-09/2003	Suspension Stabilizer Bar Link - Rear
SSP2024	301191620240	AUDI A4 8K2, 8K5 11/2007-06/2015	Suspension Stabilizer Bar Link - Front
SSP2024	301191620240	AUDI A5 8T3 2007-2015	Suspension Stabilizer Bar Link - Front
SSP2024	301191620240	AUDI Q5 8R 11/2008-2016	Suspension Stabilizer Bar Link - Front
SSP2025	301191620250	AUDI A6 4G2, C5 04/2011-	Suspension Stabilizer Bar Link - Front
SSP2025	301191620250	AUDI A7 4 GA Sportback 10/2010-	Suspension Stabilizer Bar Link - Front
SSP2025	301191620250	AUDI Q5 8R 11/2008-2016	Suspension Stabilizer Bar Link - Front
SSP2027	301191620270	AUDI A4 8K2, 8K5 11/2007-06/2015	Suspension Stabilizer Bar Link - Front
SSP2027	301191620270	AUDI A5 8T3 2007-2015	Suspension Stabilizer Bar Link - Front
SSP2027	301191620270	AUDI A6 4G2, C5 04/2011-	Suspension Stabilizer Bar Link - Front
SSP2027	301191620270	AUDI A7 4 GA Sportback 10/2010-	Suspension Stabilizer Bar Link - Front
SSP2027	301191620270	AUDI Q5 8R 11/2008-2016	Suspension Stabilizer Bar Link - Front
SSP2027	301191620270	AUDI Q7 4M 2017-	Suspension Stabilizer Bar Link - Front
SSP2028	301191620280	AUDI A1 8X1 04/2010-	Suspension Stabilizer Bar Link - Front
SSP2029	301191620290	ALFA ROMEO 159 939 09/2005-11/2011	Suspension Stabilizer Bar Link - Rear Right
SSP2030	301191620300	ALFA ROMEO 159 939 09/2005-11/2011	Suspension Stabilizer Bar Link - Rear Left
SSP2031	301191620310	ALFA ROMEO 147 937 11/2000-03/2010	Suspension Stabilizer Bar Link - Front
SSP2031	301191620310	ALFA ROMEO 156 932 09/1997-05/2006	Suspension Stabilizer Bar Link - Front
SSP2031	301191620310	ALFA ROMEO GT 937 11/2003-09/2010	Suspension Stabilizer Bar Link - Front
SSP2032	301191620320	BMW 218i Active Tourer F45,F46 09/2014-	Suspension Stabilizer Bar Link - Front
SSP2032	301191620320	BMW 220i Active Tourer F45,F46 09/2014-	Suspension Stabilizer Bar Link - Front
SSP2032	301191620320	MINI Cooper Clubman (F55,F56) 07/2014-	Suspension Stabilizer Bar Link - Front
SSP2033	301191620330	BMW 120i E81, E82, E87, E88 09/2004-09/2012	Suspension Stabilizer Bar Link - Front Right
SSP2033	301191620330	BMW 125i E81, E82, E87, E88 09/2004-09/2012	Suspension Stabilizer Bar Link - Front Right
SSP2033	301191620330	BMW 128i E81, E82, E87, E88 09/2004-09/2012	Suspension Stabilizer Bar Link - Front Right
SSP2033	301191620330	BMW 130i E81, E82, E87, E88 09/2004-09/2012	Suspension Stabilizer Bar Link - Front Right



 SHORT LONG			DESCRIPTION
SSP2033	301191620330	BMW 135i E81, E82, E87, E88 09/2004-09/2012	Suspension Stabilizer Bar Link - Front Right
SSP2033	301191620330	BMW 323i E90/E91/E92/E93 01/2005-12/2011	Suspension Stabilizer Bar Link - Front Right
SSP2033	301191620330	BMW 325Ci E90/E91/E92/E93 01/2005-12/2011	Suspension Stabilizer Bar Link - Front Right
SSP2033	301191620330	BMW 325i E90/E91/E92/E93 01/2005-12/2011	Suspension Stabilizer Bar Link - Front Right
SSP2033	301191620330	BMW 328i E90/E91/E92/E93 01/2005-12/2011	Suspension Stabilizer Bar Link - Front Right
SSP2033	301191620330	BMW 330Ci E90/E91/E92/E93 01/2005-12/2011	Suspension Stabilizer Bar Link - Front Right
SSP2033	301191620330	BMW 330i E90/E91/E92/E93 01/2005-12/2011	Suspension Stabilizer Bar Link - Front Right
SSP2033	301191620330	BMW 335d E90/E91/E92/E93 01/2005-12/2011	Suspension Stabilizer Bar Link - Front Right
SSP2033	301191620330	BMW 335i E90/E91/E92/E93 01/2005-12/2011	Suspension Stabilizer Bar Link - Front Right
SSP2033	301191620330	BMW 335is E90/E91/E92/E93 01/2005-12/2011	Suspension Stabilizer Bar Link - Front Right
SSP2033	301191620330	BMW X1 E84 10/2009-2016	Suspension Stabilizer Bar Link - Front Right
SSP2034	301191620340	BMW 120i E81, E82, E87, E88 09/2004-09/2012	Suspension Stabilizer Bar Link - Front Left
SSP2034	301191620340	BMW 125i E81, E82, E87, E88 09/2004-09/2012	Suspension Stabilizer Bar Link - Front Left
SSP2034	301191620340	BMW 128i E81, E82, E87, E88 09/2004-09/2012	Suspension Stabilizer Bar Link - Front Left
SSP2034	301191620340	BMW 130i E81, E82, E87, E88 09/2004-09/2012	Suspension Stabilizer Bar Link - Front Left
SSP2034	301191620340	BMW 135i E81, E82, E87, E88 09/2004-09/2012	Suspension Stabilizer Bar Link - Front Left
SSP2034	301191620340	BMW 323i E90/E91/E92/E93 01/2005-12/2011	Suspension Stabilizer Bar Link - Front Left
SSP2034	301191620340	BMW 325Ci E90/E91/E92/E93 01/2005-12/2011	Suspension Stabilizer Bar Link - Front Left
SSP2034	301191620340	BMW 325i E90/E91/E92/E93 01/2005-12/2011	Suspension Stabilizer Bar Link - Front Left
SSP2034	301191620340	BMW 328i E90/E91/E92/E93 01/2005-12/2011	Suspension Stabilizer Bar Link - Front Left
SSP2034	301191620340	BMW 330Ci E90/E91/E92/E93 01/2005-12/2011	Suspension Stabilizer Bar Link - Front Left
SSP2034	301191620340	BMW 330i E90/E91/E92/E93 01/2005-12/2011	Suspension Stabilizer Bar Link - Front Left
SSP2034	301191620340	BMW 335d E90/E91/E92/E93 01/2005-12/2011	Suspension Stabilizer Bar Link - Front Left
SSP2034	301191620340	BMW 335i E90/E91/E92/E93 01/2005-12/2011	Suspension Stabilizer Bar Link - Front Left
SSP2034	301191620340	BMW 335is E90/E91/E92/E93 01/2005-12/2011	Suspension Stabilizer Bar Link - Front Left
SSP2034	301191620340	BMW X1 E84 10/2009-2016	Suspension Stabilizer Bar Link - Front Left
SSP2035	301191620350	BMW 120i E81, E82, E87, E88 09/2004-09/2012	Suspension Stabilizer Bar Link - Rear
SSP2035	301191620350	BMW 125i E81, E82, E87, E88 09/2004-09/2012	Suspension Stabilizer Bar Link - Rear
SSP2035	301191620350	BMW 128i E81, E82, E87, E88 09/2004-09/2012	Suspension Stabilizer Bar Link - Rear
SSP2035	301191620350	BMW 130i E81, E82, E87, E88 09/2004-09/2012	Suspension Stabilizer Bar Link - Rear
SSP2035	301191620350	BMW 135i E81, E82, E87, E88 09/2004-09/2012	Suspension Stabilizer Bar Link - Rear





			DESCRIPTION
SHORT	LONG		
SSP2035	301191620350	BMW 323i E90/E91/E92/E93 01/2005-12/2011	Suspension Stabilizer Bar Link - Rear
SSP2035	301191620350	BMW 325Ci E90/E91/E92/E93 01/2005-12/2011	Suspension Stabilizer Bar Link - Rear
SSP2035	301191620350	BMW 325i E90/E91/E92/E93 01/2005-12/2011	Suspension Stabilizer Bar Link - Rear
SSP2035	301191620350	BMW 328i E90/E91/E92/E93 01/2005-12/2011	Suspension Stabilizer Bar Link - Rear
SSP2035	301191620350	BMW 330Ci E90/E91/E92/E93 01/2005-12/2011	Suspension Stabilizer Bar Link - Rear
SSP2035	301191620350	BMW 330i E90/E91/E92/E93 01/2005-12/2011	Suspension Stabilizer Bar Link - Rear
SSP2035	301191620350	BMW 335d E90/E91/E92/E93 01/2005-12/2011	Suspension Stabilizer Bar Link - Rear
SSP2035	301191620350	BMW 335i E90/E91/E92/E93 01/2005-12/2011	Suspension Stabilizer Bar Link - Rear
SSP2035	301191620350	BMW 335is E90/E91/E92/E93 01/2005-12/2011	Suspension Stabilizer Bar Link - Rear
SSP2035	301191620350	BMW X1 E84 10/2009-2016	Suspension Stabilizer Bar Link - Rear
SSP2036	301191620360	BMW 325xi E90/E91/E92/E93 (xDrive) 4x4 01/2005-12/2011	Suspension Stabilizer Bar Link - Front Right
SSP2036	301191620360	BMW 328i xDrive E90/E91/E92/E93 (xDrive) 4x4 01/2005-12/2011	Suspension Stabilizer Bar Link - Front Right
SSP2036	301191620360	BMW 328xi E90/E91/E92/E93 (xDrive) 4x4 01/2005-12/2011	Suspension Stabilizer Bar Link - Front Right
SSP2036	301191620360	BMW 330xi E90/E91/E92/E93 (xDrive) 4x4 01/2005-12/2011	Suspension Stabilizer Bar Link - Front Right
SSP2036	301191620360	BMW 335i xDrive E90/E91/E92/E93 (xDrive) 4x4 01/2005-12/2011	Suspension Stabilizer Bar Link - Front Right
SSP2036	301191620360	BMW 335xi E90/E91/E92/E93 (xDrive) 4x4 01/2005-12/2011	Suspension Stabilizer Bar Link - Front Right
SSP2036	301191620360	BMW X1 E84 (xDrive) 4x4 10/2009-2016	Suspension Stabilizer Bar Link - Front Right
SSP2037	301191620370	BMW 325xi E90/E91/E92/E93 (xDrive) 4x4 01/2005-12/2011	Suspension Stabilizer Bar Link - Front Left
SSP2037	301191620370	BMW 328i xDrive E90/E91/E92/E93 (xDrive) 4x4 01/2005-12/2011	Suspension Stabilizer Bar Link - Front Left
SSP2037	301191620370	BMW 328xi E90/E91/E92/E93 (xDrive) 4x4 01/2005-12/2011	Suspension Stabilizer Bar Link - Front Left
SSP2037	301191620370	BMW 330xi E90/E91/E92/E93 (xDrive) 4x4 01/2005-12/2011	Suspension Stabilizer Bar Link - Front Left
SSP2037	301191620370	BMW 335i xDrive E90/E91/E92/E93 (xDrive) 4x4 01/2005-12/2011	Suspension Stabilizer Bar Link - Front Left
SSP2037	301191620370	BMW 335xi E90/E91/E92/E93 (xDrive) 4x4 01/2005-12/2011	Suspension Stabilizer Bar Link - Front Left
SSP2037	301191620370	BMW X1 E84 (xDrive) 4x4 10/2009-2016	Suspension Stabilizer Bar Link - Front Left
SSP2038	301191620380	BMW 118i F 10/2011-	Suspension Stabilizer Bar Link - Front Right
SSP2038	301191620380	BMW 120i F 10/2011-	Suspension Stabilizer Bar Link - Front Right
SSP2038	301191620380	BMW 125i F 10/2011-	Suspension Stabilizer Bar Link - Front Right
SSP2038	301191620380	BMW 128i F 10/2011-	Suspension Stabilizer Bar Link - Front Right
SSP2038	301191620380	BMW 130i F 10/2011-	Suspension Stabilizer Bar Link - Front Right
SSP2038	301191620380	BMW 135i F 10/2011-	Suspension Stabilizer Bar Link - Front Right
SSP2038	301191620380	BMW 135is F 10/2011-	Suspension Stabilizer Bar Link - Front Right
SSP2038	301191620380	BMW 320i F 10/2011-	Suspension Stabilizer Bar Link - Front Right





 SHORT LONG			DESCRIPTION
SSP2038	301191620380	BMW 325i F 10/2011-	Suspension Stabilizer Bar Link - Front Right
SSP2038	301191620380	BMW 328d F 10/2011-	Suspension Stabilizer Bar Link - Front Right
SSP2038	301191620380	BMW 328i F 10/2011-	Suspension Stabilizer Bar Link - Front Right
SSP2038	301191620380	BMW 328i xDrive F 10/2011 -	Suspension Stabilizer Bar Link - Front Right
SSP2038	301191620380	BMW 328xi F 10/2011 -	Suspension Stabilizer Bar Link - Front Right
SSP2038	301191620380	BMW 330i F 10/2011-	Suspension Stabilizer Bar Link - Front Right
SSP2038	301191620380	BMW 330xi F 10/2011-	Suspension Stabilizer Bar Link - Front Right
SSP2038	301191620380	BMW 335i F 10/2011-	Suspension Stabilizer Bar Link - Front Right
SSP2038	301191620380	BMW 335is F 10/2011-	Suspension Stabilizer Bar Link - Front Right
SSP2038	301191620380	BMW 340i F 10/2011-	Suspension Stabilizer Bar Link - Front Right
SSP2038	301191620380	BMW 420i Gran Coupe F 05/2014-	Suspension Stabilizer Bar Link - Front Right
SSP2038	301191620380	BMW 428i F 05/2014-	Suspension Stabilizer Bar Link - Front Right
SSP2038	301191620380	BMW 428i Gran Coupe F 05/2014-	Suspension Stabilizer Bar Link - Front Right
SSP2038	301191620380	BMW 435i F 05/2014-	Suspension Stabilizer Bar Link - Front Right
SSP2038	301191620380	BMW 435i Gran Coupe F 05/2014-	Suspension Stabilizer Bar Link - Front Right
SSP2039	301191620390	BMW 118i F 10/2011-	Suspension Stabilizer Bar Link - Front
SSP2039	301191620390	BMW 120i F 10/2011-	Suspension Stabilizer Bar Link - Front
SSP2039	301191620390	BMW 125i F 10/2011-	Suspension Stabilizer Bar Link - Front
SSP2039	301191620390	BMW 128i F 10/2011-	Suspension Stabilizer Bar Link - Front
SSP2039	301191620390	BMW 130i F 10/2011-	Suspension Stabilizer Bar Link - Front
SSP2039	301191620390	BMW 135i F 10/2011-	Suspension Stabilizer Bar Link - Front
SSP2039	301191620390	BMW 135is F 10/2011-	Suspension Stabilizer Bar Link - Front
SSP2039	301191620390	BMW 320i F 10/2011-	Suspension Stabilizer Bar Link - Front
SSP2039	301191620390	BMW 325i F 10/2011-	Suspension Stabilizer Bar Link - Front
SSP2039	301191620390	BMW 328d F 10/2011-	Suspension Stabilizer Bar Link - Front
SSP2039	301191620390	BMW 328i F 10/2011-	Suspension Stabilizer Bar Link - Front
SSP2039	301191620390	BMW 330i F 10/2011-	Suspension Stabilizer Bar Link - Front
SSP2039	301191620390	BMW 335i F 10/2011-	Suspension Stabilizer Bar Link - Front
SSP2039	301191620390	BMW 335is F 10/2011-	Suspension Stabilizer Bar Link - Front
SSP2039	301191620390	BMW 340i F 10/2011-	Suspension Stabilizer Bar Link - Front
SSP2039	301191620390	BMW 420i F 05/2014-	Suspension Stabilizer Bar Link - Front
SSP2039	301191620390	BMW 420i Gran Coupe F 05/2014-	Suspension Stabilizer Bar Link - Front
SSP2039	301191620390	BMW 428i F 05/2014-	Suspension Stabilizer Bar Link - Front
SSP2039	301191620390	BMW 428i Gran Coupe F 05/2014-	Suspension Stabilizer Bar Link - Front
SSP2039	301191620390	BMW 435i F 05/2014-	Suspension Stabilizer Bar Link - Front
SSP2039	301191620390	BMW 435i Gran Coupe F 05/2014-	Suspension Stabilizer Bar Link - Front
SSP2040	301191620400	BMW 118i F 10/2011-	Suspension Stabilizer Bar Link - Rear Right
SSP2040	301191620400	BMW 120i F 10/2011-	Suspension Stabilizer Bar Link - Rear Right
SSP2040	301191620400	BMW 125i F 10/2011-	Suspension Stabilizer Bar Link - Rear Right
SSP2040	301191620400	BMW 128i F 10/2011-	Suspension Stabilizer Bar Link - Rear Right
SSP2040	301191620400	BMW 130i F 10/2011-	Suspension Stabilizer Bar Link - Rear Right





		 	DESCRIPTION
SHORT	LONG		
SSP2040	301191620400	BMW 135i F 10/2011-	Suspension Stabilizer Bar Link - Rear Right
SSP2040	301191620400	BMW 135is F 10/2011-	Suspension Stabilizer Bar Link - Rear Right
SSP2040	301191620400	BMW 320i F 10/2011-	Suspension Stabilizer Bar Link - Rear Right
SSP2040	301191620400	BMW 325i F 10/2011-	Suspension Stabilizer Bar Link - Rear Right
SSP2040	301191620400	BMW 328d F 10/2011-	Suspension Stabilizer Bar Link - Rear Right
SSP2040	301191620400	BMW 328i F 10/2011-	Suspension Stabilizer Bar Link - Rear Right
SSP2040	301191620400	BMW 330i F 10/2011-	Suspension Stabilizer Bar Link - Rear Right
SSP2040	301191620400	BMW 335i F 10/2011-	Suspension Stabilizer Bar Link - Rear Right
SSP2040	301191620400	BMW 335is F 10/2011-	Suspension Stabilizer Bar Link - Rear Right
SSP2040	301191620400	BMW 340i F 10/2011-	Suspension Stabilizer Bar Link - Rear Right
SSP2040	301191620400	BMW 420i F 05/2014-	Suspension Stabilizer Bar Link - Rear Right
SSP2040	301191620400	BMW 420i Gran Coupe F 05/2014-	Suspension Stabilizer Bar Link - Rear Right
SSP2040	301191620400	BMW 428i F 05/2014-	Suspension Stabilizer Bar Link - Rear Right
SSP2040	301191620400	BMW 428i Gran Coupe F 05/2014-	Suspension Stabilizer Bar Link - Rear Right
SSP2040	301191620400	BMW 435i F 05/2014-	Suspension Stabilizer Bar Link - Rear Right
SSP2040	301191620400	BMW 435i Gran Coupe F 05/2014-	Suspension Stabilizer Bar Link - Rear Right
SSP2040	301191620400	BMW i8 2014-	Suspension Stabilizer Bar Link - Rear Right
SSP2041	301191620410	BMW 118i F 10/2011-	Suspension Stabilizer Bar Link - Rear Left
SSP2041	301191620410	BMW 120i F 10/2011-	Suspension Stabilizer Bar Link - Rear Left
SSP2041	301191620410	BMW 125i F 10/2011-	Suspension Stabilizer Bar Link - Rear Left
SSP2041	301191620410	BMW 128i F 10/2011-	Suspension Stabilizer Bar Link - Rear Left
SSP2041	301191620410	BMW 130i F 10/2011-	Suspension Stabilizer Bar Link - Rear Left
SSP2041	301191620410	BMW 135i F 10/2011-	Suspension Stabilizer Bar Link - Rear Left
SSP2041	301191620410	BMW 135is F 10/2011-	Suspension Stabilizer Bar Link - Rear Left
SSP2041	301191620410	BMW 320i F 10/2011-	Suspension Stabilizer Bar Link - Rear Left
SSP2041	301191620410	BMW 325i F 10/2011-	Suspension Stabilizer Bar Link - Rear Left
SSP2041	301191620410	BMW 328d F 10/2011-	Suspension Stabilizer Bar Link - Rear Left
SSP2041	301191620410	BMW 328i F 10/2011-	Suspension Stabilizer Bar Link - Rear Left
SSP2041	301191620410	BMW 330i F 10/2011-	Suspension Stabilizer Bar Link - Rear Left
SSP2041	301191620410	BMW 335i F 10/2011-	Suspension Stabilizer Bar Link - Rear Left
SSP2041	301191620410	BMW 335is F 10/2011-	Suspension Stabilizer Bar Link - Rear Left
SSP2041	301191620410	BMW 340i F 10/2011-	Suspension Stabilizer Bar Link - Rear Left
SSP2041	301191620410	BMW 420i F 05/2014-	Suspension Stabilizer Bar Link - Rear Left
SSP2041	301191620410	BMW 420i Gran Coupe F 05/2014-	Suspension Stabilizer Bar Link - Rear Left
SSP2041	301191620410	BMW 428i F 05/2014-	Suspension Stabilizer Bar Link - Rear Left
SSP2041	301191620410	BMW 428i Gran Coupe F 05/2014-	Suspension Stabilizer Bar Link - Rear Left
SSP2041	301191620410	BMW 435i F 05/2014-	Suspension Stabilizer Bar Link - Rear Left
SSP2041	301191620410	BMW 435i Gran Coupe F 05/2014-	Suspension Stabilizer Bar Link - Rear Left
SSP2042	301191620420	BMW 525i E39 11/1995-06/2003	Suspension Stabilizer Bar Link - Front
SSP2042	301191620420	BMW 528i E39 11/1995-06/2003	Suspension Stabilizer Bar Link - Front
SSP2042	301191620420	BMW 530i E39 11/1995-06/2003	Suspension Stabilizer Bar Link - Front





 SHORT LONG			DESCRIPTION
SSP2042	301191620420	BMW 540i E39 11/1995-06/2003	Suspension Stabilizer Bar Link - Front
SSP2043	301191620430	BMW 525i E39 11/1995-06/2003	Suspension Stabilizer Bar Link - Front Left
SSP2043	301191620430	BMW 528i E39 11/1995-06/2003	Suspension Stabilizer Bar Link - Front Left
SSP2043	301191620430	BMW 530i E39 11/1995-06/2003	Suspension Stabilizer Bar Link - Front Left
SSP2044	301191620440	BMW 525i E39 11/1995-06/2003	Suspension Stabilizer Bar Link - Front Left
SSP2044	301191620440	BMW 528i E39 11/1995-06/2003	Suspension Stabilizer Bar Link - Front Left
SSP2044	301191620440	BMW 530i E39 11/1995-06/2003	Suspension Stabilizer Bar Link - Front Left
SSP2044	301191620440	BMW 540i E39 11/1995-06/2003	Suspension Stabilizer Bar Link - Front Left
SSP2045	301191620450	BMW 525i E39 11/1995-06/2003	Suspension Stabilizer Bar Link - Front Right
SSP2045	301191620450	BMW 528i E39 11/1995-06/2003	Suspension Stabilizer Bar Link - Front Right
SSP2045	301191620450	BMW 530i E39 11/1995-06/2003	Suspension Stabilizer Bar Link - Front Right
SSP2046	301191620460	BMW 525i E39 11/1995-06/2003	Suspension Stabilizer Bar Link - Front Right
SSP2046	301191620460	BMW 528i E39 11/1995-06/2003	Suspension Stabilizer Bar Link - Front Right
SSP2046	301191620460	BMW 530i E39 11/1995-06/2003	Suspension Stabilizer Bar Link - Front Right
SSP2046	301191620460	BMW 540i E39 11/1995-06/2003	Suspension Stabilizer Bar Link - Front Right
SSP2047	301191620470	BMW 525i E39 11/1995-06/2003	Suspension Stabilizer Bar Link - Rear
SSP2047	301191620470	BMW 528i E39 11/1995-06/2003	Suspension Stabilizer Bar Link - Rear
SSP2047	301191620470	BMW 530i E39 11/1995-06/2003	Suspension Stabilizer Bar Link - Rear
SSP2047	301191620470	BMW 540i E39 11/1995-06/2003	Suspension Stabilizer Bar Link - Rear
SSP2048	301191620480	BMW 525i E39 11/1995-06/2003	Suspension Stabilizer Bar Link - Rear
SSP2048	301191620480	BMW 528i E39 11/1995-06/2003	Suspension Stabilizer Bar Link - Rear
SSP2048	301191620480	BMW 530i E39 11/1995-06/2003	Suspension Stabilizer Bar Link - Rear
SSP2048	301191620480	BMW 540i E39 11/1995-06/2003	Suspension Stabilizer Bar Link - Rear
SSP2049	301191620490	BMW 525i E39 11/1995-06/2003	Suspension Stabilizer Bar Link - Rear
SSP2049	301191620490	BMW 528i E39 11/1995-06/2003	Suspension Stabilizer Bar Link - Rear
SSP2049	301191620490	BMW 530i E39 11/1995-06/2003	Suspension Stabilizer Bar Link - Rear
SSP2050	301191620500	BMW 320i E46 02/1998-04/2005	Suspension Stabilizer Bar Link - Rear
SSP2050	301191620500	BMW 323Ci E46 02/1998-04/2005	Suspension Stabilizer Bar Link - Rear
SSP2050	301191620500	BMW 323i E46 02/1998-04/2005	Suspension Stabilizer Bar Link - Rear
SSP2050	301191620500	BMW 325Ci E46 02/1998-04/2005	Suspension Stabilizer Bar Link - Rear
SSP2050	301191620500	BMW 325i E46 02/1998-04/2005	Suspension Stabilizer Bar Link - Rear
SSP2050	301191620500	BMW 330Ci E46 02/1998-04/2005	Suspension Stabilizer Bar Link - Rear
SSP2050	301191620500	BMW 330i E46 02/1998-04/2005	Suspension Stabilizer Bar Link - Rear
SSP2050	301191620500	BMW Z4 E85 02/2003-02/2009	Suspension Stabilizer Bar Link - Rear
SSP2051	301191620510	BMW 320i E46 02/1998-04/2005	Suspension Stabilizer Bar Link - Front
SSP2051	301191620510	BMW 323Ci E46 02/1998-04/2005	Suspension Stabilizer Bar Link - Front
SSP2051	301191620510	BMW 323i E46 02/1998-04/2005	Suspension Stabilizer Bar Link - Front
SSP2051	301191620510	BMW 325Ci E46 02/1998-04/2005	Suspension Stabilizer Bar Link - Front
SSP2051	301191620510	BMW 325i E46 02/1998-04/2005	Suspension Stabilizer Bar Link - Front
SSP2051	301191620510	BMW 330Ci E46 02/1998-04/2005	Suspension Stabilizer Bar Link - Front
SSP2051	301191620510	BMW 330i E46 02/1998-04/2005	Suspension Stabilizer Bar Link - Front



 SHORT LONG			DESCRIPTION
SSP2051	301191620510	BMW Z4 E85 02/2003-02/2009	Suspension Stabilizer Bar Link - Front
SSP2052	301191620520	BMW 318i E46 02/1998-04/2005	Suspension Stabilizer Bar Link - Front
SSP2052	301191620520	BMW 318is E46 02/1998-04/2005	Suspension Stabilizer Bar Link - Front
SSP2052	301191620520	BMW 318ti E46 02/1998-04/2005	Suspension Stabilizer Bar Link - Front
SSP2052	301191620520	BMW 320i E46 02/1998-04/2005	Suspension Stabilizer Bar Link - Front
SSP2052	301191620520	BMW 323Ci E46 02/1998-04/2005	Suspension Stabilizer Bar Link - Front
SSP2052	301191620520	BMW 323i E46 02/1998-04/2005	Suspension Stabilizer Bar Link - Front
SSP2052	301191620520	BMW 323is E46 02/1998-04/2005	Suspension Stabilizer Bar Link - Front
SSP2052	301191620520	BMW 323ti E46 02/1998-04/2005	Suspension Stabilizer Bar Link - Front
SSP2052	301191620520	BMW 325Ci E46 02/1998-04/2005	Suspension Stabilizer Bar Link - Front
SSP2052	301191620520	BMW 325i E46 02/1998-04/2005	Suspension Stabilizer Bar Link - Front
SSP2052	301191620520	BMW 328Ci E46 02/1998-04/2005	Suspension Stabilizer Bar Link - Front
SSP2052	301191620520	BMW 328i E46 02/1998-04/2005	Suspension Stabilizer Bar Link - Front
SSP2052	301191620520	BMW 328is E46 02/1998-04/2005	Suspension Stabilizer Bar Link - Front
SSP2052	301191620520	BMW 330Ci E46 02/1998-04/2005	Suspension Stabilizer Bar Link - Front
SSP2052	301191620520	BMW 330i E46 02/1998-04/2005	Suspension Stabilizer Bar Link - Front
SSP2052	301191620520	BMW Z4 E85 02/2003-02/2009	Suspension Stabilizer Bar Link - Front
SSP2053	301191620530	BMW 320i E46 02/1998-04/2005	Suspension Stabilizer Bar Link - Front Right
SSP2053	301191620530	BMW 323Ci E46 02/1998-04/2005	Suspension Stabilizer Bar Link - Front Right
SSP2053	301191620530	BMW 323i E46 02/1998-04/2005	Suspension Stabilizer Bar Link - Front Right
SSP2053	301191620530	BMW 325Ci E46 02/1998-04/2005	Suspension Stabilizer Bar Link - Front Right
SSP2053	301191620530	BMW 325i E46 02/1998-04/2005	Suspension Stabilizer Bar Link - Front Right
SSP2053	301191620530	BMW 330Ci E46 02/1998-04/2005	Suspension Stabilizer Bar Link - Front Right
SSP2053	301191620530	BMW 330i E46 02/1998-04/2005	Suspension Stabilizer Bar Link - Front Right
SSP2054	301191620540	BMW 320i E46 02/1998-04/2005	Suspension Stabilizer Bar Link - Front Left
SSP2054	301191620540	BMW 323Ci E46 02/1998-04/2005	Suspension Stabilizer Bar Link - Front Left
SSP2054	301191620540	BMW 323i E46 02/1998-04/2005	Suspension Stabilizer Bar Link - Front Left
SSP2054	301191620540	BMW 325Ci E46 02/1998-04/2005	Suspension Stabilizer Bar Link - Front Left
SSP2054	301191620540	BMW 325i E46 02/1998-04/2005	Suspension Stabilizer Bar Link - Front Left
SSP2054	301191620540	BMW 330Ci E46 02/1998-04/2005	Suspension Stabilizer Bar Link - Front Left
SSP2054	301191620540	BMW 330i E46 02/1998-04/2005	Suspension Stabilizer Bar Link - Front Left
SSP2055	301191620550	BMW 525xi E60 - E61, AWD 07/2003-03/2010	Suspension Stabilizer Bar Link - Rear
SSP2055	301191620550	BMW 528i xDrive E60 - E61, AWD 07/2003-03/2010	Suspension Stabilizer Bar Link - Rear
SSP2055	301191620550	BMW 528xi E60 - E61, AWD 07/2003-03/2010	Suspension Stabilizer Bar Link - Rear
SSP2055	301191620550	BMW 530xi E60 - E61, AWD 07/2003-03/2010	Suspension Stabilizer Bar Link - Rear
SSP2055	301191620550	BMW 535i xDrive E60 - E61, AWD 07/2003-03/2010	Suspension Stabilizer Bar Link - Rear
SSP2055	301191620550	BMW 535xi E60 - E61, AWD 07/2003-03/2010	Suspension Stabilizer Bar Link - Rear
SSP2056	301191620560	BMW 525i E60 - E61 07/2003-03/2010	Suspension Stabilizer Bar Link - Front Right
SSP2056	301191620560	BMW 528i E60 - E61 07/2003-03/2010	Suspension Stabilizer Bar Link - Front Right





			DESCRIPTION
SHORT	LONG		
SSP2063	301191620630	BMW 760i E65, E66, E67 01/2001-09/2008	Suspension Stabilizer Bar Link - Rear
SSP2063	301191620630	BMW 760Li E65, E66, E67 01/2001-09/2008	Suspension Stabilizer Bar Link - Rear
SSP2064	301191620640	BMW 745i E65, E66, E67 01/2001-09/2008	Suspension Stabilizer Bar Link - Rear
SSP2064	301191620640	BMW 745Li E65, E66, E67 01/2001-09/2008	Suspension Stabilizer Bar Link - Rear
SSP2064	301191620640	BMW 750i E65, E66, E67 01/2001-09/2008	Suspension Stabilizer Bar Link - Rear
SSP2064	301191620640	BMW 750Li E65, E66, E67 01/2001-09/2008	Suspension Stabilizer Bar Link - Rear
SSP2064	301191620640	BMW 760i E65, E66, E67 01/2001-09/2008	Suspension Stabilizer Bar Link - Rear
SSP2064	301191620640	BMW 760Li E65, E66, E67 01/2001-09/2008	Suspension Stabilizer Bar Link - Rear
SSP2065	301191620650	BMW 640i F 2011-2016	Suspension Stabilizer Bar Link - Rear
SSP2065	301191620650	BMW 640i Gran Coupe F 2011-2016	Suspension Stabilizer Bar Link - Rear
SSP2065	301191620650	BMW 650i F 2011-2016	Suspension Stabilizer Bar Link - Rear
SSP2065	301191620650	BMW 650i Gran Coupe F 2011-2016	Suspension Stabilizer Bar Link - Rear
SSP2066	301191620660	BMW 740i E38 1994-2002	Suspension Stabilizer Bar Link - Front
SSP2066	301191620660	BMW 740iL E38 1994-2002	Suspension Stabilizer Bar Link - Front
SSP2066	301191620660	BMW 745i E38 1994-2002	Suspension Stabilizer Bar Link - Front
SSP2066	301191620660	BMW 745Li E38 1994-2002	Suspension Stabilizer Bar Link - Front
SSP2066	301191620660	BMW 750iL E38 1994-2002	Suspension Stabilizer Bar Link - Front
SSP2067	301191620670	BMW 740i E38 1994-2002	Suspension Stabilizer Bar Link - Rear
SSP2067	301191620670	BMW 740iL E38 1994-2002	Suspension Stabilizer Bar Link - Rear
SSP2067	301191620670	BMW 745i E38 1994-2002	Suspension Stabilizer Bar Link - Rear
SSP2067	301191620670	BMW 745Li E38 1994-2002	Suspension Stabilizer Bar Link - Rear
SSP2067	301191620670	BMW 750iL E38 1994-2002	Suspension Stabilizer Bar Link - Rear
SSP2068	301191620680	BMW X5 E53 05/2000-01/2007	Suspension Stabilizer Bar Link - Front Right
SSP2069	301191620690	BMW X5 E53 05/2000-01/2007	Suspension Stabilizer Bar Link - Front Left
SSP2070	301191620700	BMW X5 E53 05/2000-01/2007	Suspension Stabilizer Bar Link - Rear
SSP2071	301191620710	BMW X3 E83 01/2004-08/2010	Suspension Stabilizer Bar Link - Front Right
SSP2072	301191620720	BMW X3 E83 01/2004-08/2010	Suspension Stabilizer Bar Link - Front Left
SSP2073	301191620730	BMW X3 E83 01/2004-08/2010	Suspension Stabilizer Bar Link - Rear
SSP2074	301191620740	BMW X5 E70 02/2007-12/2012	Suspension Stabilizer Bar Link - Rear
SSP2074	301191620740	BMW X6 E71, E72 04/2008-07/2014	Suspension Stabilizer Bar Link - Rear
SSP2075	301191620750	BMW X5 E70 02/2007-12/2012	Suspension Stabilizer Bar Link - Front Right
SSP2075	301191620750	BMW X6 E71, E72 04/2008-07/2014	Suspension Stabilizer Bar Link - Front Right
SSP2076	301191620760	BMW X5 E70 02/2007-12/2012	Suspension Stabilizer Bar Link - Front Left
SSP2076	301191620760	BMW X6 E71, E72 04/2008-07/2014	Suspension Stabilizer Bar Link - Front Left
SSP2077	301191620770	BMW X5 E70 02/2007-12/2012	Suspension Stabilizer Bar Link - Front Right
SSP2077	301191620770	BMW X6 E71, E72 04/2008-07/2014	Suspension Stabilizer Bar Link - Front Right
SSP2078	301191620780	BMW X5 E70 02/2007-12/2012	Suspension Stabilizer Bar Link - Front Left
SSP2078	301191620780	BMW X6 E71, E72 04/2008-07/2014	Suspension Stabilizer Bar Link - Front Left
SSP2079	301191620790	BMW X3 F25 09/2010-2016	Suspension Stabilizer Bar Link - Rear
SSP2079	301191620790	BMW X4 F26 04/2014-	Suspension Stabilizer Bar Link - Rear
SSP2080	301191620800	BMW X3 F25 09/2010-2016	Suspension Stabilizer Bar Link - Front Right



 SHORT LONG			DESCRIPTION
SSP2080	301191620800	BMW X4 F26 04/2014-	Suspension Stabilizer Bar Link - Front Right
SSP2081	301191620810	BMW X3 F25 09/2010-2016	Suspension Stabilizer Bar Link - Front Left
SSP2081	301191620810	BMW X4 F26 04/2014-	Suspension Stabilizer Bar Link - Front Left
SSP2082	301191620820	BMW 520i F 2010-2016	Suspension Stabilizer Bar Link - Rear Forward
SSP2082	301191620820	BMW 528i F 2010-2016	Suspension Stabilizer Bar Link - Rear Forward
SSP2082	301191620820	BMW 530i F 2010-2016	Suspension Stabilizer Bar Link - Rear Forward
SSP2082	301191620820	BMW 535d F 2010-2016	Suspension Stabilizer Bar Link - Rear Forward
SSP2082	301191620820	BMW 535i F 2010-2016	Suspension Stabilizer Bar Link - Rear Forward
SSP2082	301191620820	BMW 550i F 2010-2016	Suspension Stabilizer Bar Link - Rear Forward
SSP2082	301191620820	BMW 640i F 2011-2016	Suspension Stabilizer Bar Link - Rear Forward
SSP2082	301191620820	BMW 640i Gran Coupe F 2011-2016	Suspension Stabilizer Bar Link - Rear Forward
SSP2082	301191620820	BMW 650i F 2011-2016	Suspension Stabilizer Bar Link - Rear Forward
SSP2082	301191620820	BMW 650i Gran Coupe F 2011-2016	Suspension Stabilizer Bar Link - Rear Forward
SSP2082	301191620820	BMW 740i F01, F02, F03,F04 06/2008-2016	Suspension Stabilizer Bar Link - Rear Forward
SSP2082	301191620820	BMW 740Li F01, F02, F03,F04 06/2008-2016	Suspension Stabilizer Bar Link - Rear Forward
SSP2082	301191620820	BMW 750i F01, F02, F03,F04 06/2008-2016	Suspension Stabilizer Bar Link - Rear Forward
SSP2082	301191620820	BMW 750Li F01, F02, F03,F04 06/2008-2016	Suspension Stabilizer Bar Link - Rear Forward
SSP2082	301191620820	BMW 760Li F01, F02, F03,F04 06/2008-2016	Suspension Stabilizer Bar Link - Rear Forward
SSP2083	301191620830	BMW 520i F 2010-2016	Suspension Stabilizer Bar Link - Front
SSP2083	301191620830	BMW 528i F 2010-2016	Suspension Stabilizer Bar Link - Front
SSP2083	301191620830	BMW 530i F 2010-2016	Suspension Stabilizer Bar Link - Front
SSP2083	301191620830	BMW 535d F 2010-2016	Suspension Stabilizer Bar Link - Front
SSP2083	301191620830	BMW 535i F 2010-2016	Suspension Stabilizer Bar Link - Front
SSP2083	301191620830	BMW 550i F 2010-2016	Suspension Stabilizer Bar Link - Front
SSP2083	301191620830	BMW 640i F 2011-2016	Suspension Stabilizer Bar Link - Front
SSP2083	301191620830	BMW 640i Gran Coupe F 2011-2016	Suspension Stabilizer Bar Link - Front
SSP2083	301191620830	BMW 650i F 2011-2016	Suspension Stabilizer Bar Link - Front
SSP2083	301191620830	BMW 650i Gran Coupe F 2011-2016	Suspension Stabilizer Bar Link - Front
SSP2083	301191620830	BMW 740i F01, F02, F03,F04 06/2008-2016	Suspension Stabilizer Bar Link - Front
SSP2083	301191620830	BMW 740Li F01, F02, F03,F04 06/2008-2016	Suspension Stabilizer Bar Link - Front
SSP2083	301191620830	BMW 750i F01, F02, F03,F04 06/2008-2016	Suspension Stabilizer Bar Link - Front
SSP2083	301191620830	BMW 750Li F01, F02, F03,F04 06/2008-2016	Suspension Stabilizer Bar Link - Front
SSP2083	301191620830	BMW 760Li F01, F02, F03,F04 06/2008-2016	Suspension Stabilizer Bar Link - Front
SSP2084	301191620840	BMW 520i F 2010-2016	Suspension Stabilizer Bar Link - Rear
SSP2084	301191620840	BMW 528i F 2010-2016	Suspension Stabilizer Bar Link - Rear
SSP2084	301191620840	BMW 530i F 2010-2016	Suspension Stabilizer Bar Link - Rear
SSP2084	301191620840	BMW 535d F 2010-2016	Suspension Stabilizer Bar Link - Rear
SSP2084	301191620840	BMW 535i F 2010-2016	Suspension Stabilizer Bar Link - Rear
SSP2084	301191620840	BMW 550i F 2010-2016	Suspension Stabilizer Bar Link - Rear
SSP2084	301191620840	BMW 740i F01, F02, F03,F04 06/2008-2016	Suspension Stabilizer Bar Link - Rear
SSP2084	301191620840	BMW 740Li F01, F02, F03,F04 06/2008-2016	Suspension Stabilizer Bar Link - Rear



				DESCRIPTION
SHORT	LONG			
SSP2084	301191620840	BMW 750i F01, F02, F03,F04 06/2008-2016		Suspension Stabilizer Bar Link - Rear
SSP2084	301191620840	BMW 750Li F01, F02, F03,F04 06/2008-2016		Suspension Stabilizer Bar Link - Rear
SSP2084	301191620840	BMW 760Li F01, F02, F03,F04 06/2008-2016		Suspension Stabilizer Bar Link - Rear
SSP2085	301191620850	BMW 520i F 2010-2016		Suspension Stabilizer Bar Link - Rear Forward
SSP2085	301191620850	BMW 528i F 2010-2016		Suspension Stabilizer Bar Link - Rear Forward
SSP2085	301191620850	BMW 530i F 2010-2016		Suspension Stabilizer Bar Link - Rear Forward
SSP2085	301191620850	BMW 535d F 2010-2016		Suspension Stabilizer Bar Link - Rear Forward
SSP2085	301191620850	BMW 535i F 2010-2016		Suspension Stabilizer Bar Link - Rear Forward
SSP2085	301191620850	BMW 550i F 2010-2016		Suspension Stabilizer Bar Link - Rear Forward
SSP2085	301191620850	BMW 640i F 2011-2016		Suspension Stabilizer Bar Link - Rear Forward
SSP2085	301191620850	BMW 640i Gran Coupe F 2011-2016		Suspension Stabilizer Bar Link - Rear Forward
SSP2085	301191620850	BMW 650i F 2011-2016		Suspension Stabilizer Bar Link - Rear Forward
SSP2085	301191620850	BMW 650i Gran Coupe F 2011-2016		Suspension Stabilizer Bar Link - Rear Forward
SSP2085	301191620850	BMW 740i F01, F02, F03,F04 06/2008-2016		Suspension Stabilizer Bar Link - Rear Forward
SSP2085	301191620850	BMW 740Li F01, F02, F03,F04 06/2008-2016		Suspension Stabilizer Bar Link - Rear Forward
SSP2085	301191620850	BMW 750i F01, F02, F03,F04 06/2008-2016		Suspension Stabilizer Bar Link - Rear Forward
SSP2085	301191620850	BMW 750Li F01, F02, F03,F04 06/2008-2016		Suspension Stabilizer Bar Link - Rear Forward
SSP2085	301191620850	BMW 760Li F01, F02, F03,F04 06/2008-2016		Suspension Stabilizer Bar Link - Rear Forward
SSP2086	301191620860	BMW 525xi E60 - E61, AWD 07/2003-03/2010		Suspension Stabilizer Bar Link - Front Right
SSP2086	301191620860	BMW 528i xDrive E60 - E61, AWD 07/2003-03/2010		Suspension Stabilizer Bar Link - Front Right
SSP2086	301191620860	BMW 528xi E60 - E61, AWD 07/2003-03/2010		Suspension Stabilizer Bar Link - Front Right
SSP2086	301191620860	BMW 530xi E60 - E61, AWD 07/2003-03/2010		Suspension Stabilizer Bar Link - Front Right
SSP2086	301191620860	BMW 535i xDrive E60 - E61, AWD 07/2003-03/2010		Suspension Stabilizer Bar Link - Front Right
SSP2086	301191620860	BMW 535xi E60 - E61, AWD 07/2003-03/2010		Suspension Stabilizer Bar Link - Front Right
SSP2087	301191620870	BMW 525xi E60 - E61, AWD 07/2003-03/2010		Suspension Stabilizer Bar Link - Front Left
SSP2087	301191620870	BMW 528i xDrive E60 - E61, AWD 07/2003-03/2010		Suspension Stabilizer Bar Link - Front Left
SSP2087	301191620870	BMW 528xi E60 - E61, AWD 07/2003-03/2010		Suspension Stabilizer Bar Link - Front Left
SSP2087	301191620870	BMW 530xi E60 - E61, AWD 07/2003-03/2010		Suspension Stabilizer Bar Link - Front Left
SSP2087	301191620870	BMW 535i xDrive E60 - E61, AWD 07/2003-03/2010		Suspension Stabilizer Bar Link - Front Left
SSP2087	301191620870	BMW 535xi E60 - E61, AWD 07/2003-03/2010		Suspension Stabilizer Bar Link - Front Left
SSP2088	301191620880	BMW X5 F15,F85 11/2012-		Suspension Stabilizer Bar Link - Rear
SSP2089	301191620890	BMW X5 F15,F85 11/2012-		Suspension Stabilizer Bar Link - Front Right
SSP2090	301191620900	BMW X5 F15,F85 11/2012-		Suspension Stabilizer Bar Link - Front Left
SSP2091	301191620910	CADILLAC ESCALADE 2nd Gen (GMT 800) 2001-2006		Suspension Stabilizer Bar Link - Front
SSP2091	301191620910	CHEVROLET ASTRO 2nd Gen 1995-2005		Suspension Stabilizer Bar Link - Front
SSP2091	301191620910	CHEVROLET SILVERADO 1500 1st Gen, GMT800 1999-2006		Suspension Stabilizer Bar Link - Front
SSP2092	301191620920	BUICK REGAL 5th Gen 2011-2016		Suspension Stabilizer Bar Link - Rear



 SHORT LONG			DESCRIPTION
SSP2092	301191620920	CHEVROLET IMPALA 10th Gen 2014-	Suspension Stabilizer Bar Link - Rear
SSP2093	301191620930	CHEVROLET EPICA V250 01/2005-03/2011	Suspension Stabilizer Bar Link - Front Right
SSP2093	301191620930	CHEVROLET EVANDA V200 03/2003-09/2006	Suspension Stabilizer Bar Link - Front Right
SSP2093	301191620930	DAEWOO LEGANZA 1997-2004	Suspension Stabilizer Bar Link - Front Right
SSP2094	301191620940	CHEVROLET EPICA V250 01/2005-03/2011	Suspension Stabilizer Bar Link - Front Left
SSP2094	301191620940	CHEVROLET EVANDA V200 03/2003-09/2006	Suspension Stabilizer Bar Link - Front Left
SSP2094	301191620940	DAEWOO LEGANZA 1997-2004	Suspension Stabilizer Bar Link - Front Left
SSP2095	301191620950	CHEVROLET EPICA V250 01/2005-03/2011	Suspension Stabilizer Bar Link - Rear
SSP2096	301191620960	CHEVROLET EPICA V250 01/2005-03/2011	Suspension Stabilizer Bar Link - Rear
SSP2097	301191620970	CHEVROLET IMPALA 8th, 9th Gen 2000-2013	Suspension Stabilizer Bar Link - Front
SSP2098	301191620980	CHEVROLET IMPALA 8th, 9th Gen 2000-2013	Suspension Stabilizer Bar Link - Rear
SSP2099	301191620990	BUICK RAINIER 1st Gen 2003-2007	Suspension Stabilizer Bar Link - Front Right
SSP2099	301191620990	CHEVROLET TRAILBLAZER 1st Gen 2002-2008	Suspension Stabilizer Bar Link - Front Right
SSP2099	301191620990	SAAB 9_7X 2005-2009	Suspension Stabilizer Bar Link - Front Right
SSP2100	301191621000	BUICK RAINIER 1st Gen 2003-2007	Suspension Stabilizer Bar Link - Front Left
SSP2100	301191621000	CHEVROLET TRAILBLAZER 1st Gen 2002-2008	Suspension Stabilizer Bar Link - Front Left
SSP2100	301191621000	SAAB 9_7X 2005-2009	Suspension Stabilizer Bar Link - Front Left
SSP2101	301191621010	BUICK RAINIER 1st Gen 2003-2007	Suspension Stabilizer Bar Link - Rear Left
SSP2101	301191621010	CHEVROLET TRAILBLAZER 1st Gen 2002-2008	Suspension Stabilizer Bar Link - Rear Left
SSP2102	301191621020	BUICK RAINIER 1st Gen 2003-2007	Suspension Stabilizer Bar Link - Rear Right
SSP2102	301191621020	CHEVROLET TRAILBLAZER 1st Gen 2002-2008	Suspension Stabilizer Bar Link - Rear Right
SSP2103	301191621030	CHEVROLET CAPTIVA SPORT 2012-2015	Suspension Stabilizer Bar Link - Rear
SSP2103	301191621030	CHEVROLET EQUINOX 2005-2009	Suspension Stabilizer Bar Link - Rear
SSP2103	301191621030	GMC TERRAIN 2010-	Suspension Stabilizer Bar Link - Rear
SSP2103	301191621030	PONTIAC TORRENT 2006-2009	Suspension Stabilizer Bar Link - Rear
SSP2104	301191621040	CHEVROLET EQUINOX 2005-2009	Suspension Stabilizer Bar Link - Front Right
SSP2104	301191621040	GMC TERRAIN 2010-	Suspension Stabilizer Bar Link - Front Right
SSP2105	301191621050	CHEVROLET EQUINOX 2005-2009	Suspension Stabilizer Bar Link - Front Left
SSP2105	301191621050	GMC TERRAIN 2010-	Suspension Stabilizer Bar Link - Front Left
SSP2106	301191621060	CHEVROLET EQUINOX 2nd Gen 2010-2016	Suspension Stabilizer Bar Link - Rear
SSP2107	301191621070	CHEVROLET AVEO T300 03/2011-2016	Suspension Stabilizer Bar Link - Front
SSP2108	301191621080	CHEVROLET LACETTI J200 (OPTRA) 03/2003-04/2012	Suspension Stabilizer Bar Link - Front Right
SSP2108	301191621080	CHEVROLET OPTRA J200 03/2003-04/2012	Suspension Stabilizer Bar Link - Front Right
SSP2108	301191621080	DAEWOO NUBIRA II (1.6i, 1.8i) 07/2003-2009	Suspension Stabilizer Bar Link - Front Right
SSP2108	301191621080	SUZUKI RENO 1st Gen J200 2004-2008	Suspension Stabilizer Bar Link - Front Right
SSP2109	301191621090	CHEVROLET LACETTI J200 (OPTRA) 03/2003-04/2012	Suspension Stabilizer Bar Link - Front Left
SSP2109	301191621090	CHEVROLET OPTRA J200 03/2003-04/2012	Suspension Stabilizer Bar Link - Front Left





 SHORT LONG			DESCRIPTION
SSP2109	301191621090	DAEWOO NUBIRA II (1.6i, 1.8i) 07/2003-2009	Suspension Stabilizer Bar Link - Front Left
SSP2109	301191621090	SUZUKI RENO 1st Gen J200 2004-2008	Suspension Stabilizer Bar Link - Front Left
SSP2110	301191621100	CHEVROLET LACETTI J200 (OPTRA) 03/2003-04/2012	Suspension Stabilizer Bar Link - Rear
SSP2110	301191621100	CHEVROLET OPTRA J200 03/2003-04/2012	Suspension Stabilizer Bar Link - Rear
SSP2110	301191621100	DAEWOO NUBIRA II (1.6i, 1.8i) 07/2003-2009	Suspension Stabilizer Bar Link - Rear
SSP2110	301191621100	SUZUKI RENO 1st Gen J200 2004-2008	Suspension Stabilizer Bar Link - Rear
SSP2111	301191621110	CHEVROLET MALIBU 7th Gen 2004-2012	Suspension Stabilizer Bar Link - Front
SSP2112	301191621120	CHEVROLET MALIBU 8th Gen 2013-2016	Suspension Stabilizer Bar Link - Front
SSP2113	301191621130	CHEVROLET UPLANDER 2005-2008	Suspension Stabilizer Bar Link - Rear
SSP2114	301191621140	CHEVROLET UPLANDER 2005-2008	Suspension Stabilizer Bar Link - Rear
SSP2115	301191621150	CHEVROLET COLORADO 1st Gen 2003-2012	Suspension Stabilizer Bar Link - Rear
SSP2116	301191621160	CHEVROLET COLORADO 1st Gen 2003-2012	Suspension Stabilizer Bar Link - Front Right
SSP2117	301191621170	CHEVROLET COLORADO 1st Gen 2003-2012	Suspension Stabilizer Bar Link - Front Left
SSP2118	301191621180	CHEVROLET EXPRESS 1500 1st Gen 2003-2014	Suspension Stabilizer Bar Link - Front
SSP2118	301191621180	CHEVROLET EXPRESS 2500 2003-	Suspension Stabilizer Bar Link - Front
SSP2118	301191621180	FORD MUSTANG 4th Gen 1994-2004	Suspension Stabilizer Bar Link - Front
SSP2119	301191621190	CHEVROLET SILVERADO 3500 2001-2010	Suspension Stabilizer Bar Link - Rear
SSP2119	301191621190	GMC SIERRA 3500 2001-2010	Suspension Stabilizer Bar Link - Rear
SSP2120	301191621200	CHEVROLET CORVETTE C5 01/1997-09/2004	Suspension Stabilizer Bar Link - Rear
SSP2120	301191621200	CHEVROLET CORVETTE C6 2005-2011	Suspension Stabilizer Bar Link - Rear
SSP2121	301191621210	CHEVROLET BLAZER 2nd Gen 1995-2005	Suspension Stabilizer Bar Link - Rear
SSP2121	301191621210	GMC JIMMY 2nd Gen 1995-2001	Suspension Stabilizer Bar Link - Rear
SSP2121	301191621210	OLDSMOBILE BRAVADA 2nd Gen 1996-2001	Suspension Stabilizer Bar Link - Rear
SSP2122	301191621220	CHEVROLET BLAZER 2nd Gen 1995-2005	Suspension Stabilizer Bar Link - Front
SSP2122	301191621220	CHEVROLET S-10 1st Gen 1982-1993	Suspension Stabilizer Bar Link - Front
SSP2123	301191621230	CHEVROLET CAPTIVA 06/2006-05/2010	Suspension Stabilizer Bar Link - Rear
SSP2123	301191621230	OPEL ANTARA 05/2006-	Suspension Stabilizer Bar Link - Rear
SSP2124	301191621240	CHEVROLET CAPTIVA 06/2006-05/2010	Suspension Stabilizer Bar Link - Rear
SSP2124	301191621240	OPEL ANTARA 05/2006-	Suspension Stabilizer Bar Link - Rear
SSP2125	301191621250	CHEVROLET CAPTIVA 06/2006-05/2010	Suspension Stabilizer Bar Link - Front Right
SSP2125	301191621250	OPEL ANTARA 05/2006-	Suspension Stabilizer Bar Link - Front Right
SSP2126	301191621260	CHEVROLET CAPTIVA 06/2006-05/2010	Suspension Stabilizer Bar Link - Front Left
SSP2126	301191621260	OPEL ANTARA 05/2006-	Suspension Stabilizer Bar Link - Front Left
SSP2127	301191621270	CHEVROLET CAMARO 5th Gen 2010-2015	Suspension Stabilizer Bar Link - Rear
SSP2128	301191621280	CHEVROLET CAMARO 5th Gen 2010-2015	Suspension Stabilizer Bar Link - Front Right
SSP2129	301191621290	CHEVROLET CAMARO 5th Gen 2010-2015	Suspension Stabilizer Bar Link - Front Left
SSP2130	301191621300	CHEVROLET SPARK M300 03/2010-2016	Suspension Stabilizer Bar Link - Front
SSP2131	301191621310	CHEVROLET CAVALIER 3rd Gen 1995-2005	Suspension Stabilizer Bar Link - Front
SSP2131	301191621310	GMC JIMMY 2nd Gen 1995-2001	Suspension Stabilizer Bar Link - Front





 SHORT LONG			DESCRIPTION
SSP2131	301191621310	PONTIAC SUNFIRE 1st Gen 1995-2005	Suspension Stabilizer Bar Link - Front
SSP2132	301191621320	CHEVROLET SUBURBAN 8th Gen 1992-2000	Suspension Stabilizer Bar Link - Rear
SSP2132	301191621320	CHEVROLET TAHOE 1st Gen 1992-2000	Suspension Stabilizer Bar Link - Rear
SSP2132	301191621320	GMC YUKON 1st Gen 1992-2000	Suspension Stabilizer Bar Link - Rear
SSP2133	301191621330	CHEVROLET TAHOE 3rd Gen, GMT900 2007-2014	Suspension Stabilizer Bar Link - Front
SSP2133	301191621330	GMC YUKON GMT900 2007-2014	Suspension Stabilizer Bar Link - Front
SSP2134	301191621340	CHEVROLET TAHOE 3rd Gen, GMT900 2007-2014	Suspension Stabilizer Bar Link - Rear
SSP2134	301191621340	GMC YUKON GMT900 2007-2014	Suspension Stabilizer Bar Link - Rear
SSP2135	301191621350	BUICK ENCLAVE 1st Gen 2008-2015	Suspension Stabilizer Bar Link - Front
SSP2135	301191621350	CHEVROLET TRAVERSE 1st Gen 2009-2015	Suspension Stabilizer Bar Link - Front
SSP2135	301191621350	GMC ACADIA 2007-2017	Suspension Stabilizer Bar Link - Front
SSP2136	301191621360	BUICK ENCLAVE 1st Gen 2008-2015	Suspension Stabilizer Bar Link - Rear
SSP2136	301191621360	CHEVROLET TRAVERSE 1st Gen 2009-2015	Suspension Stabilizer Bar Link - Rear
SSP2136	301191621360	GMC ACADIA 2007-2017	Suspension Stabilizer Bar Link - Rear
SSP2137	301191621370	CITROEN BERLINGO MF 07/1996-	Suspension Stabilizer Bar Link - Front
SSP2137	301191621370	CITROEN XSARA 1997-2005	Suspension Stabilizer Bar Link - Front
SSP2137	301191621370	CITROEN XSARA PICASSO 12/1999-2012	Suspension Stabilizer Bar Link - Front
SSP2137	301191621370	CITROEN ZX 1991-1997	Suspension Stabilizer Bar Link - Front
SSP2137	301191621370	PEUGEOT 306 1993-2001	Suspension Stabilizer Bar Link - Front
SSP2137	301191621370	PEUGEOT PARTNER I 05/1996-	Suspension Stabilizer Bar Link - Front
SSP2138	301191621380	CITROEN SAXO 1996-2003	Suspension Stabilizer Bar Link - Front
SSP2138	301191621380	CITROEN XANTIA BREAK 1993-2003	Suspension Stabilizer Bar Link - Front
SSP2138	301191621380	PEUGEOT 106 08/1991-03/2004	Suspension Stabilizer Bar Link - Front
SSP2139	301191621390	CITROEN AX 1992-1998	Suspension Stabilizer Bar Link - Front
SSP2139	301191621390	CITROEN SAXO 1996-2003	Suspension Stabilizer Bar Link - Front
SSP2139	301191621390	CITROEN XANTIA BREAK 1993-2003	Suspension Stabilizer Bar Link - Front
SSP2139	301191621390	PEUGEOT 106 08/1991-03/2004	Suspension Stabilizer Bar Link - Front
SSP2139	301191621390	PEUGEOT 406 10/1995-10/2004	Suspension Stabilizer Bar Link - Front
SSP2140	301191621400	CITROEN AX 1992-1998	Suspension Stabilizer Bar Link - Front
SSP2140	301191621400	CITROEN SAXO 1996-2003	Suspension Stabilizer Bar Link - Front
SSP2140	301191621400	CITROEN XANTIA BREAK 1993-2003	Suspension Stabilizer Bar Link - Front
SSP2140	301191621400	PEUGEOT 106 08/1991-03/2004	Suspension Stabilizer Bar Link - Front
SSP2140	301191621400	PEUGEOT 406 10/1995-10/2004	Suspension Stabilizer Bar Link - Front
SSP2141	301191621410	CITROEN XM BREAK 1994-2000	Suspension Stabilizer Bar Link - Front
SSP2141	301191621410	PEUGEOT 605 1989-1999	Suspension Stabilizer Bar Link - Front
SSP2142	301191621420	CITROEN SAXO 1996-2003	Suspension Stabilizer Bar Link - Front
SSP2142	301191621420	PEUGEOT 106 08/1991-03/2004	Suspension Stabilizer Bar Link - Front
SSP2143	301191621430	CITROEN C4 CACTUS 09/2014-	Suspension Stabilizer Bar Link - Front
SSP2144	301191621440	CITROEN C3 II 11/2009-2016	Suspension Stabilizer Bar Link - Front





 SHORT LONG			DESCRIPTION
SSP2144	301191621440	CITROEN DS3 II 2009-2016	Suspension Stabilizer Bar Link - Front
SSP2144	301191621440	PEUGEOT 2008 2013-	Suspension Stabilizer Bar Link - Front
SSP2145	301191621450	CITROEN C3 II 11/2009-2016	Suspension Stabilizer Bar Link - Front
SSP2145	301191621450	CITROEN DS3 II 2009-2016	Suspension Stabilizer Bar Link - Front
SSP2146	301191621460	CHRYSLER 200 1st Gen 2011-2014	Suspension Stabilizer Bar Link - Front
SSP2146	301191621460	DODGE AVENGER 1st Gen 2011-2014	Suspension Stabilizer Bar Link - Front
SSP2147	301191621470	CHRYSLER PT CRUISER 06/2000-12/2010	Suspension Stabilizer Bar Link - Front
SSP2148	301191621480	CHRYSLER PT CRUISER 06/2000-12/2010	Suspension Stabilizer Bar Link - Rear
SSP2149	301191621490	CHRYSLER 300 2nd Gen 2011-2017	Suspension Stabilizer Bar Link - Front
SSP2149	301191621490	DODGE CHARGER 7th Gen 2011-	Suspension Stabilizer Bar Link - Front
SSP2150	301191621500	CHRYSLER SEBRING ST22/JR 2001-2006	Suspension Stabilizer Bar Link - Front Right
SSP2150	301191621500	MINIBUS MITSUBISHI GALANT VI 1996-2004	Suspension Stabilizer Bar Link - Front Right
SSP2151	301191621510	CHRYSLER SEBRING ST22/JR 2001-2006	Suspension Stabilizer Bar Link - Front Left
SSP2151	301191621510	MINIBUS MITSUBISHI GALANT VI 1996-2004	Suspension Stabilizer Bar Link - Front Left
SSP2152	301191621520	CHRYSLER 300M 1st Gen 1998-2004	Suspension Stabilizer Bar Link - Front
SSP2152	301191621520	CHRYSLER CONCORDE 2nd Gen 1998-2004	Suspension Stabilizer Bar Link - Front
SSP2153	301191621530	CHEVROLET AVEO T250 05/2005-02/2011	Suspension Stabilizer Bar Link - Front
SSP2153	301191621530	CHEVROLET REZZO U100 (VIVANT) 2004-2009	Suspension Stabilizer Bar Link - Front
SSP2153	301191621530	CHEVROLET TACUMA 2000-2008	Suspension Stabilizer Bar Link - Front
SSP2153	301191621530	DAEWOO KALOS (KLAS) 09/2002-03/2011	Suspension Stabilizer Bar Link - Front
SSP2153	301191621530	DAEWOO NUBIRA I 05/1997-06/2003	Suspension Stabilizer Bar Link - Front
SSP2153	301191621530	DAEWOO REZZO (KLAU) 09/2000-02/2011	Suspension Stabilizer Bar Link - Front
SSP2153	301191621530	PONTIAC G3 2007-2009	Suspension Stabilizer Bar Link - Front
SSP2154	301191621540	DACIA DUSTER 04/2010-	Suspension Stabilizer Bar Link - Front
SSP2155	301191621550	DODGE NITRO 2007-2012	Suspension Stabilizer Bar Link - Rear
SSP2155	301191621550	JEEP LIBERTY KK 2008-2014	Suspension Stabilizer Bar Link - Rear
SSP2156	301191621560	DODGE DURANGO 3rd Gen 2011-2017	Suspension Stabilizer Bar Link - Front Right
SSP2156	301191621560	JEEP GRAND CHEROKEE WK2 2011-	Suspension Stabilizer Bar Link - Front Right
SSP2157	301191621570	DODGE DURANGO 3rd Gen 2011-2017	Suspension Stabilizer Bar Link - Front Left
SSP2157	301191621570	JEEP GRAND CHEROKEE WK2 2011-	Suspension Stabilizer Bar Link - Front Left
SSP2158	301191621580	DODGE DURANGO 3rd Gen 2011-2017	Suspension Stabilizer Bar Link - Front Right
SSP2158	301191621580	JEEP GRAND CHEROKEE WK2 2011-	Suspension Stabilizer Bar Link - Front Right
SSP2159	301191621590	DODGE DURANGO 3rd Gen 2011-2017	Suspension Stabilizer Bar Link - Front Left
SSP2159	301191621590	JEEP GRAND CHEROKEE WK2 2011-	Suspension Stabilizer Bar Link - Front Left
SSP2160	301191621600	DODGE DURANGO 3rd Gen 2011-2017	Suspension Stabilizer Bar Link - Rear
SSP2160	301191621600	JEEP GRAND CHEROKEE WK2 2011-	Suspension Stabilizer Bar Link - Rear
SSP2161	301191621610	DODGE DURANGO 3rd Gen 2011-2017	Suspension Stabilizer Bar Link - Rear
SSP2161	301191621610	JEEP GRAND CHEROKEE WK2 2011-	Suspension Stabilizer Bar Link - Rear
SSP2162	301191621620	FIAT PANDA 169 09/2003-02/2012	Suspension Stabilizer Bar Link - Front
SSP2163	301191621630	FIAT 500X 01/2015-	Suspension Stabilizer Bar Link - Front





 SHORT LONG			DESCRIPTION
SSP2163	301191621630	FIAT EGEA 356, TIPO 10/2015-	Suspension Stabilizer Bar Link - Front
SSP2163	301191621630	FIAT TIPO 356 10/2015-	Suspension Stabilizer Bar Link - Front
SSP2163	301191621630	JEEP RENEGADE 07/2014-	Suspension Stabilizer Bar Link - Front
SSP2164	301191621640	FIAT 500X 01/2015-	Suspension Stabilizer Bar Link - Rear
SSP2164	301191621640	JEEP RENEGADE 07/2014-	Suspension Stabilizer Bar Link - Rear
SSP2165	301191621650	FIAT COUPE FA-175 11/1993-2000	Suspension Stabilizer Bar Link - Front
SSP2165	301191621650	FIAT MAREA 185 06/1996-12/2007	Suspension Stabilizer Bar Link - Front
SSP2165	301191621650	FIAT MULTIPLA 04/1999-12/2010	Suspension Stabilizer Bar Link - Front
SSP2165	301191621650	LANCIA DEDRA 835 1989-1999	Suspension Stabilizer Bar Link - Front
SSP2166	301191621660	ALFA ROMEO MITO 09/2008-	Suspension Stabilizer Bar Link - Front
SSP2166	301191621660	FIAT PUNTO EVO 07/2008-02/2012	Suspension Stabilizer Bar Link - Front
SSP2166	301191621660	FIAT PUNTO GRANDE 199 10/2005-	Suspension Stabilizer Bar Link - Front
SSP2166	301191621660	OPEL CORSA (D) 08/2006-08/2014	Suspension Stabilizer Bar Link - Front
SSP2167	301191621670	CITROEN NEMO 2008-	Suspension Stabilizer Bar Link - Front
SSP2167	301191621670	FIAT FIORINO 2008-	Suspension Stabilizer Bar Link - Front
SSP2167	301191621670	FIAT LINEA 323 06/2007-2016	Suspension Stabilizer Bar Link - Front
SSP2167	301191621670	PEUGEOT BIPPER 02/2008-	Suspension Stabilizer Bar Link - Front
SSP2168	301191621680	FIAT BRAVO II 198 04/2007-	Suspension Stabilizer Bar Link - Front
SSP2168	301191621680	FIAT STILO 192 10/2001-11/2010	Suspension Stabilizer Bar Link - Front
SSP2169	301191621690	CITROEN JUMPY III 01/2007-	Suspension Stabilizer Bar Link - Front
SSP2169	301191621690	FIAT SCUDO 272 01/2007-	Suspension Stabilizer Bar Link - Front
SSP2169	301191621690	PEUGEOT EXPERT 01/2007-	Suspension Stabilizer Bar Link - Front
SSP2170	301191621700	FORD CROWN VICTORIA 2nd Gen 1998-2011	Suspension Stabilizer Bar Link - Front
SSP2170	301191621700	LINCOLN TOWN CAR 3rd Gen 1998-2011	Suspension Stabilizer Bar Link - Front
SSP2171	301191621710	FORD FUSION 1st Gen USA made 2006-2012	Suspension Stabilizer Bar Link - Front
SSP2171	301191621710	LINCOLN MKZ 1st Gen 2006-2012	Suspension Stabilizer Bar Link - Front
SSP2171	301191621710	MERCURY MILAN 2006-2011	Suspension Stabilizer Bar Link - Front
SSP2172	301191621720	FORD EDGE U387 2006-2014	Suspension Stabilizer Bar Link - Front
SSP2173	301191621730	FORD EDGE U387 2006-2014	Suspension Stabilizer Bar Link - Rear
SSP2173	301191621730	LINCOLN MKX 1st Gen 2007-2014	Suspension Stabilizer Bar Link - Rear
SSP2174	301191621740	FORD FIESTA USA type 2011-	Suspension Stabilizer Bar Link -
SSP2174	301191621740	FORD FIESTA VI 10/2008-2016	Suspension Stabilizer Bar Link - Front
SSP2174	301191621740	MAZDA 2 DE 10/2007-2015	Suspension Stabilizer Bar Link - Front
SSP2175	301191621750	FORD FIESTA USA type 2011-	Suspension Stabilizer Bar Link - Front
SSP2175	301191621750	FORD FIESTA VI 10/2008-2016	Suspension Stabilizer Bar Link - Front
SSP2175	301191621750	MAZDA 2 DE 10/2007-2015	Suspension Stabilizer Bar Link - Front
SSP2176	301191621760	FORD FIESTA V 01/2002-09/2008	Suspension Stabilizer Bar Link - Front
SSP2176	301191621760	FORD FUSION 2003-2009	Suspension Stabilizer Bar Link - Front
SSP2176	301191621760	MAZDA 2 DY 04/2003-06/2007	Suspension Stabilizer Bar Link - Front
SSP2177	301191621770	FORD FIESTA V 01/2002-09/2008	Suspension Stabilizer Bar Link - Front





 SHORT LONG			DESCRIPTION
SSP2177	301191621770	FORD FUSION 2003-2009	Suspension Stabilizer Bar Link - Front
SSP2177	301191621770	MAZDA 2 DY 04/2003-06/2007	Suspension Stabilizer Bar Link - Front
SSP2178	301191621780	FORD ESCORT 1990-2000	Suspension Stabilizer Bar Link - Front
SSP2178	301191621780	FORD FIESTA III 1994-1996	Suspension Stabilizer Bar Link - Front
SSP2178	301191621780	FORD FIESTA IV Box JV 1996-1998	Suspension Stabilizer Bar Link - Front
SSP2178	301191621780	FORD KAR B 1996-2008	Suspension Stabilizer Bar Link - Front
SSP2178	301191621780	FORD PUMA 03/1997-06/2002	Suspension Stabilizer Bar Link - Front
SSP2178	301191621780	MAZDA 121 III 03/1996-04/2003	Suspension Stabilizer Bar Link - Front
SSP2179	301191621790	FORD EXPLORER U502 2010-2015	Suspension Stabilizer Bar Link - Rear Right
SSP2180	301191621800	FORD EXPLORER U502 2010-2015	Suspension Stabilizer Bar Link - Rear Left
SSP2181	301191621810	FORD EXPLORER U502 2010-2015	Suspension Stabilizer Bar Link - Front Right
SSP2181	301191621810	FORD POLICE INTERCEPTOR UTILITY 2013-2016	Suspension Stabilizer Bar Link - Front Right
SSP2182	301191621820	FORD EXPLORER U502 2010-2015	Suspension Stabilizer Bar Link - Front Left
SSP2182	301191621820	FORD POLICE INTERCEPTOR UTILITY 2013-2016	Suspension Stabilizer Bar Link - Front Left
SSP2183	301191621830	FORD FUSION 2nd Gen 2013-	Suspension Stabilizer Bar Link - Front
SSP2183	301191621830	FORD MONDEO V 09/2014-	Suspension Stabilizer Bar Link - Front
SSP2184	301191621840	FORD FUSION 2nd Gen 2013-	Suspension Stabilizer Bar Link - Rear
SSP2184	301191621840	FORD MONDEO V 09/2014-	Suspension Stabilizer Bar Link - Rear
SSP2185	301191621850	FORD FOCUS II USA made 2005-2010	Suspension Stabilizer Bar Link - Front
SSP2186	301191621860	FORD FOCUS I 10/1998-11/2004	Suspension Stabilizer Bar Link - Rear
SSP2187	301191621870	FORD FOCUS I 10/1998-11/2004	Suspension Stabilizer Bar Link - Rear
SSP2188	301191621880	FORD FOCUS I 10/1998-11/2004	Suspension Stabilizer Bar Link - Front
SSP2189	301191621890	FORD FOCUS I 10/1998-11/2004	Suspension Stabilizer Bar Link - Front
SSP2190	301191621900	FORD C-MAX I 02/2007-11/2010	Suspension Stabilizer Bar Link - Front
SSP2190	301191621900	FORD C-MAX II 12/2010-	Suspension Stabilizer Bar Link - Front
SSP2190	301191621900	FORD ESCAPE 3rd Gen 2013-	Suspension Stabilizer Bar Link - Front
SSP2190	301191621900	FORD FOCUS II 11/2004-03/2011	Suspension Stabilizer Bar Link - Front
SSP2190	301191621900	FORD FOCUS III 04/2011-	Suspension Stabilizer Bar Link - Front
SSP2190	301191621900	FORD KUGA I 02/2008-02/2013	Suspension Stabilizer Bar Link - Front
SSP2190	301191621900	FORD KUGA II 03/2013-	Suspension Stabilizer Bar Link - Front
SSP2190	301191621900	VOLVO C30 10/2006-12/2012	Suspension Stabilizer Bar Link - Front
SSP2190	301191621900	VOLVO S40 II (MS) 01/2004-11/2012	Suspension Stabilizer Bar Link - Front
SSP2190	301191621900	VOLVO V40 II 03/2012-	Suspension Stabilizer Bar Link - Front
SSP2190	301191621900	VOLVO V50 04/2004-11/2012	Suspension Stabilizer Bar Link - Front
SSP2191	301191621910	FORD C-MAX I 02/2007-11/2010	Suspension Stabilizer Bar Link - Front
SSP2191	301191621910	FORD C-MAX II 12/2010-	Suspension Stabilizer Bar Link - Front
SSP2191	301191621910	FORD FOCUS II 11/2004-03/2011	Suspension Stabilizer Bar Link - Front
SSP2191	301191621910	FORD FOCUS III 04/2011-	Suspension Stabilizer Bar Link - Front
SSP2191	301191621910	FORD KUGA I 02/2008-02/2013	Suspension Stabilizer Bar Link - Front





 SHORT LONG			DESCRIPTION
SSP2191	301191621910	VOLVO C30 10/2006-12/2012	Suspension Stabilizer Bar Link - Front
SSP2191	301191621910	VOLVO S40 II (MS) 01/2004-11/2012	Suspension Stabilizer Bar Link - Front
SSP2191	301191621910	VOLVO V50 04/2004-11/2012	Suspension Stabilizer Bar Link - Front
SSP2192	301191621920	FORD C-MAX I 02/2007-11/2010	Suspension Stabilizer Bar Link - Rear
SSP2192	301191621920	FORD FOCUS II 11/2004-03/2011	Suspension Stabilizer Bar Link - Rear
SSP2192	301191621920	MAZDA 3 BK 10/2003-06/2009	Suspension Stabilizer Bar Link - Rear
SSP2192	301191621920	MAZDA 3 BL 07/2009-11/2014	Suspension Stabilizer Bar Link - Rear
SSP2192	301191621920	MAZDA 5 CR19, 2nd Gen 03/2005-08/2010	Suspension Stabilizer Bar Link - Rear
SSP2192	301191621920	VOLVO C30 10/2006-12/2012	Suspension Stabilizer Bar Link - Rear
SSP2192	301191621920	VOLVO S40 II (MS) 01/2004-11/2012	Suspension Stabilizer Bar Link - Rear
SSP2192	301191621920	VOLVO V50 04/2004-11/2012	Suspension Stabilizer Bar Link - Rear
SSP2193	301191621930	FORD GALAXY 05/2006-	Suspension Stabilizer Bar Link - Front
SSP2193	301191621930	FORD MONDEO IV 04/2007-08/2014	Suspension Stabilizer Bar Link - Front
SSP2193	301191621930	FORD S-MAX WA6 05/2006-	Suspension Stabilizer Bar Link - Front
SSP2193	301191621930	VOLVO S60 II 04/2010-	Suspension Stabilizer Bar Link - Front
SSP2193	301191621930	VOLVO S80 II (AS) 03/2006-2016	Suspension Stabilizer Bar Link - Front
SSP2193	301191621930	VOLVO V70 III 08/2007-2016	Suspension Stabilizer Bar Link - Front
SSP2193	301191621930	VOLVO XC60 05/2008-2016	Suspension Stabilizer Bar Link - Front
SSP2194	301191621940	FORD GALAXY 05/2006-	Suspension Stabilizer Bar Link - Front
SSP2194	301191621940	FORD MONDEO IV 04/2007-08/2014	Suspension Stabilizer Bar Link - Front
SSP2194	301191621940	FORD S-MAX WA6 05/2006-	Suspension Stabilizer Bar Link - Front
SSP2194	301191621940	VOLVO S60 II 04/2010-	Suspension Stabilizer Bar Link - Front
SSP2194	301191621940	VOLVO S80 II (AS) 03/2006-2016	Suspension Stabilizer Bar Link - Front
SSP2194	301191621940	VOLVO V70 III 08/2007-2016	Suspension Stabilizer Bar Link - Front
SSP2194	301191621940	VOLVO XC60 05/2008-2016	Suspension Stabilizer Bar Link - Front
SSP2195	301191621950	FORD C-MAX II 12/2010-	Suspension Stabilizer Bar Link - Rear
SSP2195	301191621950	FORD FOCUS III 04/2011-	Suspension Stabilizer Bar Link - Rear
SSP2196	301191621960	FORD FOCUS II 11/2004-03/2011	Suspension Stabilizer Bar Link - Rear
SSP2196	301191621960	FORD FOCUS III 04/2011-	Suspension Stabilizer Bar Link - Rear
SSP2197	301191621970	FORD FOCUS III 04/2011-	Suspension Stabilizer Bar Link - Front
SSP2198	301191621980	FORD EXPEDITION 3rd Gen U324 2007-2015	Suspension Stabilizer Bar Link - Front
SSP2198	301191621980	FORD F-150 12th Gen 2009-2015	Suspension Stabilizer Bar Link - Front
SSP2198	301191621980	LINCOLN NAVIGATOR 3rd Gen, U326 2007-2017	Suspension Stabilizer Bar Link - Front
SSP2199	301191621990	FORD F-150 12th Gen 2009-2015	Suspension Stabilizer Bar Link - Front
SSP2200	301191622000	FORD F-150 12th Gen 2009-2015	Suspension Stabilizer Bar Link - Front
SSP2201	301191622010	FORD MUSTANG 5th Gen 2005-2010	Suspension Stabilizer Bar Link - Rear
SSP2202	301191622020	FORD MUSTANG 5th Gen 2005-2010	Suspension Stabilizer Bar Link - Rear
SSP2203	301191622030	FORD MUSTANG 5th Gen 2005-2010	Suspension Stabilizer Bar Link - Front
SSP2203	301191622030	FORD MUSTANG 5th Gen 2010-2015	Suspension Stabilizer Bar Link - Front
SSP2204	301191622040	FORD MUSTANG 5th Gen 2010-2015	Suspension Stabilizer Bar Link - Rear





			DESCRIPTION
SHORT	LONG		
SSP2205	301191622050	FORD MUSTANG 5th Gen 2010-2015	Suspension Stabilizer Bar Link - Rear
SSP2206	301191622060	FORD ESCAPE 3rd Gen 2013-	Suspension Stabilizer Bar Link - Rear
SSP2206	301191622060	FORD KUGA I 02/2008-02/2013	Suspension Stabilizer Bar Link - Rear
SSP2206	301191622060	FORD KUGA II 03/2013-	Suspension Stabilizer Bar Link - Rear
SSP2207	301191622070	FORD TRANSIT V184 2000-06/2006	Suspension Stabilizer Bar Link - Front
SSP2208	301191622080	FORD TRANSIT V184 2000-06/2006	Suspension Stabilizer Bar Link - Front
SSP2209	301191622090	FORD TRANSIT V184 2000-06/2006	Suspension Stabilizer Bar Link - Front
SSP2210	301191622100	FORD MUSTANG 6th Gen 2013-2016	Suspension Stabilizer Bar Link - Front
SSP2211	301191622110	FORD TRANSIT V184 2000-06/2006	Suspension Stabilizer Bar Link - Rear
SSP2211	301191622110	FORD TRANSIT V347-348 07/2006-04/2014	Suspension Stabilizer Bar Link - Rear
SSP2212	301191622120	FORD TRANSIT CONNECT 04/2002-09/2013	Suspension Stabilizer Bar Link - Rear
SSP2213	301191622130	FORD TRANSIT CONNECT 04/2002-09/2013	Suspension Stabilizer Bar Link - Front
SSP2214	301191622140	FORD TRANSIT CONNECT 04/2002-09/2013	Suspension Stabilizer Bar Link - Front
SSP2215	301191622150	FORD TRANSIT V347-348 07/2006-04/2014	Suspension Stabilizer Bar Link - Front
SSP2216	301191622160	FORD COURIER I 2014-	Suspension Stabilizer Bar Link - Front
SSP2216	301191622160	FORD TRANSIT CUSTOM 12/2012-	Suspension Stabilizer Bar Link - Front
SSP2216	301191622160	FORD TRANSIT V363 04/2014-	Suspension Stabilizer Bar Link - Front
SSP2217	301191622170	FORD MONDEO II 06/1996-10/2000	Suspension Stabilizer Bar Link - Front
SSP2217	301191622170	FORD TRANSIT CONNECT USA made 2010-2013	Suspension Stabilizer Bar Link - Front
SSP2217	301191622170	MERCURY COUGAR 08/1998-12/2001	Suspension Stabilizer Bar Link - Front
SSP2218	301191622180	FORD COUGAR 08/1998-12/2001	Suspension Stabilizer Bar Link - Front
SSP2218	301191622180	FORD MONDEO II 06/1996-10/2000	Suspension Stabilizer Bar Link - Front
SSP2219	301191622190	FORD MONDEO III 11/2000-03/2007	Suspension Stabilizer Bar Link - Rear
SSP2220	301191622200	FORD MONDEO III 11/2000-03/2007	Suspension Stabilizer Bar Link - Rear
SSP2221	301191622210	FORD MONDEO III 11/2000-03/2007	Suspension Stabilizer Bar Link - Rear
SSP2221	301191622210	JAGUAR X-TYPE 06/2001-11/2009	Suspension Stabilizer Bar Link - Rear
SSP2222	301191622220	FORD MONDEO III 11/2000-03/2007	Suspension Stabilizer Bar Link - Front
SSP2222	301191622220	JAGUAR X-TYPE 06/2001-11/2009	Suspension Stabilizer Bar Link - Front
SSP2223	301191622230	FORD MONDEO III 11/2000-03/2007	Suspension Stabilizer Bar Link - Front
SSP2223	301191622230	JAGUAR X-TYPE 06/2001-11/2009	Suspension Stabilizer Bar Link - Front
SSP2224	301191622240	FORD MONDEO III 11/2000-03/2007	Suspension Stabilizer Bar Link - Front
SSP2224	301191622240	JAGUAR X-TYPE 06/2001-11/2009	Suspension Stabilizer Bar Link - Front
SSP2225	301191622250	FORD MONDEO IV 04/2007-08/2014	Suspension Stabilizer Bar Link - Rear
SSP2225	301191622250	VOLVO S60 II 04/2010-	Suspension Stabilizer Bar Link - Rear
SSP2225	301191622250	VOLVO S80 II (AS) 03/2006-2016	Suspension Stabilizer Bar Link - Rear
SSP2225	301191622250	VOLVO V70 III 08/2007-2016	Suspension Stabilizer Bar Link - Rear
SSP2225	301191622250	VOLVO XC60 05/2008-2016	Suspension Stabilizer Bar Link - Rear
SSP2226	301191622260	HYUNDAI ix35 01/2010-2015	Suspension Stabilizer Bar Link - Front
SSP2226	301191622260	KIA SPORTAGE SL 07/2010-08/2015	Suspension Stabilizer Bar Link - Front
SSP2227	301191622270	HYUNDAI ix35 01/2010-2015	Suspension Stabilizer Bar Link - Rear



 SHORT LONG			DESCRIPTION
SSP2228	301191622280	HYUNDAI ACCENT II 02/2000-11/2005	Suspension Stabilizer Bar Link - Front Right
SSP2228	301191622280	HYUNDAI MATRIX 06/2001-08/2010	Suspension Stabilizer Bar Link - Front Right
SSP2229	301191622290	HYUNDAI ACCENT II 02/2000-11/2005	Suspension Stabilizer Bar Link - Front Left
SSP2229	301191622290	HYUNDAI MATRIX 06/2001-08/2010	Suspension Stabilizer Bar Link - Front Left
SSP2230	301191622300	HYUNDAI STAREX (H1) 01/1996-11/2007	Suspension Stabilizer Bar Link - Rear
SSP2230	301191622300	MINI COOPER S 05/1991-12/2004	Suspension Stabilizer Bar Link - Rear
SSP2231	301191622310	HYUNDAI H 1 I 02/2008-	Suspension Stabilizer Bar Link - Front Right
SSP2231	301191622310	HYUNDAI I800 800 10/2007-	Suspension Stabilizer Bar Link - Front Right
SSP2232	301191622320	HYUNDAI H 1 I 02/2008-	Suspension Stabilizer Bar Link - Front Left
SSP2232	301191622320	HYUNDAI I800 800 10/2007-	Suspension Stabilizer Bar Link - Front Left
SSP2233	301191622330	HYUNDAI H 1 I 02/2008-	Suspension Stabilizer Bar Link - Rear Right
SSP2233	301191622330	HYUNDAI I800 800 10/2007-	Suspension Stabilizer Bar Link - Rear Right
SSP2234	301191622340	HYUNDAI H 1 I 02/2008-	Suspension Stabilizer Bar Link - Rear Left
SSP2234	301191622340	HYUNDAI I800 800 10/2007-	Suspension Stabilizer Bar Link - Rear Left
SSP2235	301191622350	HYUNDAI ACCENT IV, RB 2011-	Suspension Stabilizer Bar Link - Front
SSP2235	301191622350	HYUNDAI ELANTRA 5th Gen, MD/UD 2012-2015	Suspension Stabilizer Bar Link - Front
SSP2235	301191622350	HYUNDAI Elantra GT 12/2011-	Suspension Stabilizer Bar Link - Front
SSP2235	301191622350	HYUNDAI I30 GD 12/2011-	Suspension Stabilizer Bar Link - Front
SSP2235	301191622350	KIA CEED II 05/2012-	Suspension Stabilizer Bar Link - Front
SSP2236	301191622360	HYUNDAI TUCSON JM 08/2004-03/2010	Suspension Stabilizer Bar Link - Rear
SSP2236	301191622360	KIA SPORTAGE JE 09/2004-06/2010	Suspension Stabilizer Bar Link - Rear
SSP2237	301191622370	HYUNDAI TUCSON JM 08/2004-03/2010	Suspension Stabilizer Bar Link - Front
SSP2237	301191622370	KIA SPORTAGE JE 09/2004-06/2010	Suspension Stabilizer Bar Link - Front
SSP2238	301191622380	HYUNDAI ACCENT III, MC 11/2005-11/2010	Suspension Stabilizer Bar Link - Front Right
SSP2238	301191622380	HYUNDAI COUPE 05/2002-08/2009	Suspension Stabilizer Bar Link - Front Right
SSP2238	301191622380	KIA RIO JB 03/2005-08/2011	Suspension Stabilizer Bar Link - Front Right
SSP2238	301191622380	KIA RIO5 JB 03/2005-08/2011	Suspension Stabilizer Bar Link - Front Right
SSP2239	301191622390	HYUNDAI ACCENT III, MC 11/2005-11/2010	Suspension Stabilizer Bar Link - Front Left
SSP2239	301191622390	HYUNDAI COUPE 05/2002-08/2009	Suspension Stabilizer Bar Link - Front Left
SSP2239	301191622390	KIA RIO JB 03/2005-08/2011	Suspension Stabilizer Bar Link - Front Left
SSP2239	301191622390	KIA RIO5 JB 03/2005-08/2011	Suspension Stabilizer Bar Link - Front Left
SSP2240	301191622400	HYUNDAI I20 (PB,PBT) 09/2008-08/2014	Suspension Stabilizer Bar Link - Front Right
SSP2240	301191622400	HYUNDAI ix20 (JC) 11/2010-	Suspension Stabilizer Bar Link - Front Right
SSP2240	301191622400	KIA PICANTO TA 05/2011-	Suspension Stabilizer Bar Link - Front Right
SSP2240	301191622400	KIA VENGA AM 02/2010-	Suspension Stabilizer Bar Link - Front Right
SSP2241	301191622410	HYUNDAI I20 (PB,PBT) 09/2008-08/2014	Suspension Stabilizer Bar Link - Front Left
SSP2241	301191622410	HYUNDAI ix20 (JC) 11/2010-	Suspension Stabilizer Bar Link - Front Left
SSP2241	301191622410	KIA PICANTO TA 05/2011-	Suspension Stabilizer Bar Link - Front Left
SSP2241	301191622410	KIA VENGA AM 02/2010-	Suspension Stabilizer Bar Link - Front Left





 SHORT LONG			DESCRIPTION
SSP2242	301191622420	HYUNDAI ELANTRA Touring, Wagon 10/2007-11/2011	Suspension Stabilizer Bar Link - Front
SSP2242	301191622420	HYUNDAI I30 FD 10/2007-11/2011	Suspension Stabilizer Bar Link - Front
SSP2242	301191622420	KIA CEED I 12/2006-04/2012	Suspension Stabilizer Bar Link - Front
SSP2242	301191622420	KIA Forte 1st Gen 2010-2013	Suspension Stabilizer Bar Link - Front
SSP2242	301191622420	KIA Forte Koup 1st Gen 2010-2013	Suspension Stabilizer Bar Link - Front
SSP2242	301191622420	KIA Forte5 1st Gen 2010-2013	Suspension Stabilizer Bar Link - Front
SSP2243	301191622430	HYUNDAI I30 FD 10/2007-11/2011	Suspension Stabilizer Bar Link - Front
SSP2243	301191622430	KIA CEED I 12/2006-04/2012	Suspension Stabilizer Bar Link - Front
SSP2244	301191622440	HYUNDAI ELANTRA Touring, Wagon 10/2007-11/2011	Suspension Stabilizer Bar Link - Rear
SSP2244	301191622440	HYUNDAI I30 FD 10/2007-11/2011	Suspension Stabilizer Bar Link - Rear
SSP2245	301191622450	HYUNDAI Elantra GT 12/2011-	Suspension Stabilizer Bar Link - Rear
SSP2245	301191622450	HYUNDAI I30 GD 12/2011-	Suspension Stabilizer Bar Link - Rear
SSP2245	301191622450	HYUNDAI I30 PD 2017-	Suspension Stabilizer Bar Link - Rear
SSP2245	301191622450	KIA CEED II 05/2012-	Suspension Stabilizer Bar Link - Rear
SSP2245	301191622450	KIA OPTIMA 3rd Gen 01/2010-	Suspension Stabilizer Bar Link - Rear
SSP2245	301191622450	KIA SPORTAGE SL 07/2010-08/2015	Suspension Stabilizer Bar Link - Rear
SSP2246	301191622460	HYUNDAI Grand i10 IA/BA 12/2013-	Suspension Stabilizer Bar Link - Front Right
SSP2246	301191622460	HYUNDAI I10 (PA) 02/2008-11/2013	Suspension Stabilizer Bar Link - Front Right
SSP2247	301191622470	HYUNDAI Grand i10 IA/BA 12/2013-	Suspension Stabilizer Bar Link - Front Left
SSP2247	301191622470	HYUNDAI I10 (PA) 02/2008-11/2013	Suspension Stabilizer Bar Link - Front Left
SSP2248	301191622480	HYUNDAI i40 (VF) 2011-	Suspension Stabilizer Bar Link - Rear
SSP2249	301191622490	HYUNDAI i40 (VF) 2011-	Suspension Stabilizer Bar Link - Front
SSP2250	301191622500	HYUNDAI I20 II 11/2014-	Suspension Stabilizer Bar Link - Front
SSP2251	301191622510	HYUNDAI Santa Fe I SM 02/2001-02/2006	Suspension Stabilizer Bar Link - Front Right
SSP2252	301191622520	HYUNDAI Santa Fe I SM 02/2001-02/2006	Suspension Stabilizer Bar Link - Front Left
SSP2253	301191622530	HYUNDAI Santa Fe I SM 02/2001-02/2006	Suspension Stabilizer Bar Link - Rear Right
SSP2254	301191622540	HYUNDAI Santa Fe I SM 02/2001-02/2006	Suspension Stabilizer Bar Link - Rear Left
SSP2255	301191622550	HYUNDAI ix55 09/2008-	Suspension Stabilizer Bar Link - Front Right
SSP2255	301191622550	HYUNDAI Santa Fe II CM 03/2006-08/2012	Suspension Stabilizer Bar Link - Front Right
SSP2255	301191622550	HYUNDAI VERACRUZ 2008-2015	Suspension Stabilizer Bar Link - Front Right
SSP2255	301191622550	KIA SORENTO XM 2009-2014	Suspension Stabilizer Bar Link - Front Right
SSP2256	301191622560	HYUNDAI ix55 09/2008-	Suspension Stabilizer Bar Link - Front Right
SSP2256	301191622560	HYUNDAI Santa Fe II CM 03/2006-08/2012	Suspension Stabilizer Bar Link - Front Right
SSP2256	301191622560	KIA SORENTO XM 2009-2014	Suspension Stabilizer Bar Link - Front Right
SSP2257	301191622570	HYUNDAI ix55 09/2008-	Suspension Stabilizer Bar Link - Front Left
SSP2257	301191622570	HYUNDAI Santa Fe II CM 03/2006-08/2012	Suspension Stabilizer Bar Link - Front Left
SSP2257	301191622570	HYUNDAI VERACRUZ 2008-2015	Suspension Stabilizer Bar Link - Front Left
SSP2257	301191622570	KIA SORENTO XM 2009-2014	Suspension Stabilizer Bar Link - Front Left
SSP2258	301191622580	HYUNDAI ix55 09/2008-	Suspension Stabilizer Bar Link - Front Left



			DESCRIPTION
SHORT	LONG		
SSP2258	301191622580	HYUNDAI Santa Fe II CM 03/2006-08/2012	Suspension Stabilizer Bar Link - Front Left
SSP2258	301191622580	KIA SORENTO XM 2009-2014	Suspension Stabilizer Bar Link - Front Left
SSP2259	301191622590	HYUNDAI Santa Fe II CM 03/2006-08/2012	Suspension Stabilizer Bar Link - Rear
SSP2259	301191622590	KIA SORENTO XM 2009-2014	Suspension Stabilizer Bar Link - Rear
SSP2260	301191622600	HYUNDAI Santa Fe III DM 09/2012-	Suspension Stabilizer Bar Link - Front
SSP2261	301191622610	HYUNDAI Santa Fe III DM 09/2012-	Suspension Stabilizer Bar Link - Rear Right
SSP2262	301191622620	HYUNDAI Santa Fe III DM 09/2012-	Suspension Stabilizer Bar Link - Rear Left
SSP2263	301191622630	JEEP GRAND CHEROKEE I ZJ 09/1991-05/1999	Suspension Stabilizer Bar Link - Front
SSP2264	301191622640	JEEP GRAND CHEROKEE II WJ, WG 06/1999-05/2005	Suspension Stabilizer Bar Link - Front
SSP2265	301191622650	JEEP GRAND CHEROKEE II WJ, WG 06/1999-05/2005	Suspension Stabilizer Bar Link - Rear
SSP2266	301191622660	JEEP WRANGLER TJ 08/1996-03/2007	Suspension Stabilizer Bar Link - Front
SSP2267	301191622670	JEEP WRANGLER JK 04/2007-	Suspension Stabilizer Bar Link - Front
SSP2268	301191622680	JEEP WRANGLER JK 04/2007-	Suspension Stabilizer Bar Link - Rear
SSP2269	301191622690	JEEP COMPASS MK49 06/2006-2015	Suspension Stabilizer Bar Link - Front
SSP2269	301191622690	JEEP PATRIOT 2007-2015	Suspension Stabilizer Bar Link - Front
SSP2270	301191622700	KIA SORENTO JC, BL 08/2002-10/2009	Suspension Stabilizer Bar Link - Front Right
SSP2271	301191622710	KIA SORENTO JC, BL 08/2002-10/2009	Suspension Stabilizer Bar Link - Front Left
SSP2272	301191622720	KIA SORENTO JC, BL 08/2002-10/2009	Suspension Stabilizer Bar Link - Rear Left
SSP2273	301191622730	KIA SORENTO JC, BL 08/2002-10/2009	Suspension Stabilizer Bar Link - Rear Right
SSP2274	301191622740	KIA SORENTO JC, BL 08/2002-10/2009	Suspension Stabilizer Bar Link - Front
SSP2275	301191622750	KIA SORENTO UM, III 2015-2017	Suspension Stabilizer Bar Link - Front
SSP2276	301191622760	KIA SORENTO UM, III 2015-2017	Suspension Stabilizer Bar Link - Rear
SSP2277	301191622770	KIA SPORTAGE NB7 1993-2004	Suspension Stabilizer Bar Link - Front
SSP2278	301191622780	KIA RIO DC 09/2000-02/2005	Suspension Stabilizer Bar Link - Front Right
SSP2279	301191622790	KIA RIO DC 09/2000-02/2005	Suspension Stabilizer Bar Link - Front Left
SSP2280	301191622800	KIA RIO DC 09/2000-02/2005	Suspension Stabilizer Bar Link - Front Right
SSP2281	301191622810	KIA RIO DC 09/2000-02/2005	Suspension Stabilizer Bar Link - Front Left
SSP2282	301191622820	KIA PICANTO BA 05/2004-04/2011	Suspension Stabilizer Bar Link - Front Right
SSP2283	301191622830	KIA PICANTO BA 05/2004-04/2011	Suspension Stabilizer Bar Link - Front Left
SSP2284	301191622840	KIA SPORTAGE SL 07/2010-08/2015	Suspension Stabilizer Bar Link - Front
SSP2285	301191622850	HYUNDAI I30 GD 12/2011-	Suspension Stabilizer Bar Link - Front
SSP2285	301191622850	HYUNDAI I30 PD 2017-	Suspension Stabilizer Bar Link - Front
SSP2285	301191622850	KIA CEED II 05/2012-	Suspension Stabilizer Bar Link - Front
SSP2285	301191622850	KIA RIO UB 09/2011-	Suspension Stabilizer Bar Link - Front
SSP2286	301191622860	KIA SOUL AM 02/2009-2014	Suspension Stabilizer Bar Link - Front Right
SSP2287	301191622870	KIA SOUL AM 02/2009-2014	Suspension Stabilizer Bar Link - Front Left
SSP2288	301191622880	FORD EXPEDITION 2nd Gen 2003-2006	Suspension Stabilizer Bar Link - Front
SSP2288	301191622880	LINCOLN NAVIGATOR UN173, U228 05/1997-12/2006	Suspension Stabilizer Bar Link - Front





 SHORT LONG			DESCRIPTION
SSP2289	301191622890	MERCEDES E280 (W210) 1995-2003	Suspension Stabilizer Bar Link - Front Right
SSP2289	301191622890	MERCEDES E300 (W210) 1995-2003	Suspension Stabilizer Bar Link - Front Right
SSP2289	301191622890	MERCEDES E320 (W210) 1995-2003	Suspension Stabilizer Bar Link - Front Right
SSP2289	301191622890	MERCEDES E420 (W210) 1995-2003	Suspension Stabilizer Bar Link - Front Right
SSP2289	301191622890	MERCEDES E430 (W210) 1995-2003	Suspension Stabilizer Bar Link - Front Right
SSP2289	301191622890	MERCEDES E500 (W210) 1995-2003	Suspension Stabilizer Bar Link - Front Right
SSP2289	301191622890	MERCEDES E55 AMG (W210) 1995-2003	Suspension Stabilizer Bar Link - Front Right
SSP2290	301191622900	MERCEDES E280 (W210) 1995-2003	Suspension Stabilizer Bar Link - Front Left
SSP2290	301191622900	MERCEDES E300 (W210) 1995-2003	Suspension Stabilizer Bar Link - Front Left
SSP2290	301191622900	MERCEDES E320 (W210) 1995-2003	Suspension Stabilizer Bar Link - Front Left
SSP2290	301191622900	MERCEDES E420 (W210) 1995-2003	Suspension Stabilizer Bar Link - Front Left
SSP2290	301191622900	MERCEDES E430 (W210) 1995-2003	Suspension Stabilizer Bar Link - Front Left
SSP2290	301191622900	MERCEDES E500 (W210) 1995-2003	Suspension Stabilizer Bar Link - Front Left
SSP2290	301191622900	MERCEDES E55 AMG (W210) 1995-2003	Suspension Stabilizer Bar Link - Front Left
SSP2291	301191622910	MERCEDES SLK200 (R171) 03/2004-02/2011	Suspension Stabilizer Bar Link - Front
SSP2291	301191622910	MERCEDES SLK280 (R171) 03/2004-02/2011	Suspension Stabilizer Bar Link - Front
SSP2291	301191622910	MERCEDES SLK300 (R171) 03/2004-02/2011	Suspension Stabilizer Bar Link - Front
SSP2291	301191622910	MERCEDES SLK350 (R171) 03/2004-02/2011	Suspension Stabilizer Bar Link - Front
SSP2291	301191622910	MERCEDES SLK55 AMG (R171) 03/2004-02/2011	Suspension Stabilizer Bar Link - Front
SSP2292	301191622920	MERCEDES E200 (W212) 01/2009-2016	Suspension Stabilizer Bar Link - Front Right
SSP2292	301191622920	MERCEDES E250 (W212) 01/2009-2016	Suspension Stabilizer Bar Link - Front Right
SSP2292	301191622920	MERCEDES E280 (W212) 01/2009-2016	Suspension Stabilizer Bar Link - Front Right
SSP2292	301191622920	MERCEDES E300 (W212) 01/2009-2016	Suspension Stabilizer Bar Link - Front Right
SSP2292	301191622920	MERCEDES E320 (W212) 01/2009-2016	Suspension Stabilizer Bar Link - Front Right
SSP2292	301191622920	MERCEDES E400 (W212) 01/2009-2016	Suspension Stabilizer Bar Link - Front Right
SSP2292	301191622920	MERCEDES E500 (W212) 01/2009-2016	Suspension Stabilizer Bar Link - Front Right
SSP2292	301191622920	MERCEDES E550 (W212) 01/2009-2016	Suspension Stabilizer Bar Link - Front Right
SSP2292	301191622920	MERCEDES E63 AMG (W212) 01/2009-2016	Suspension Stabilizer Bar Link - Front Right
SSP2293	301191622930	MERCEDES E200 (W212) 01/2009-2016	Suspension Stabilizer Bar Link - Front Left
SSP2293	301191622930	MERCEDES E250 (W212) 01/2009-2016	Suspension Stabilizer Bar Link - Front Left
SSP2293	301191622930	MERCEDES E280 (W212) 01/2009-2016	Suspension Stabilizer Bar Link - Front Left
SSP2293	301191622930	MERCEDES E300 (W212) 01/2009-2016	Suspension Stabilizer Bar Link - Front Left
SSP2293	301191622930	MERCEDES E320 (W212) 01/2009-2016	Suspension Stabilizer Bar Link - Front Left
SSP2293	301191622930	MERCEDES E400 (W212) 01/2009-2016	Suspension Stabilizer Bar Link - Front Left
SSP2293	301191622930	MERCEDES E500 (W212) 01/2009-2016	Suspension Stabilizer Bar Link - Front Left
SSP2293	301191622930	MERCEDES E550 (W212) 01/2009-2016	Suspension Stabilizer Bar Link - Front Left
SSP2293	301191622930	MERCEDES E63 AMG (W212) 01/2009-2016	Suspension Stabilizer Bar Link - Front Left
SSP2294	301191622940	MERCEDES CLS350 (C218) 2011-2017	Suspension Stabilizer Bar Link - Front Right
SSP2294	301191622940	MERCEDES CLS500 (C218) 2011-2017	Suspension Stabilizer Bar Link - Front Right
SSP2294	301191622940	MERCEDES E200 (W212) 2009-2016	Suspension Stabilizer Bar Link - Front Right



 SHORT LONG			DESCRIPTION
SSP2294	301191622940	MERCEDES E250 (W212) 01/2009-2016	Suspension Stabilizer Bar Link - Front Right
SSP2294	301191622940	MERCEDES E350 (W212) 2009-2016	Suspension Stabilizer Bar Link - Front Right
SSP2294	301191622940	MERCEDES E400 (W212) 01/2009-2016	Suspension Stabilizer Bar Link - Front Right
SSP2294	301191622940	MERCEDES E500 (W212) 01/2009-2016	Suspension Stabilizer Bar Link - Front Right
SSP2295	301191622950	MERCEDES CLS350 (C218) 2011-2017	Suspension Stabilizer Bar Link - Front Left
SSP2295	301191622950	MERCEDES CLS500 (C218) 2011-2017	Suspension Stabilizer Bar Link - Front Left
SSP2295	301191622950	MERCEDES E200 (W212) 2009-2016	Suspension Stabilizer Bar Link - Front Left
SSP2295	301191622950	MERCEDES E250 (W212) 01/2009-2016	Suspension Stabilizer Bar Link - Front Left
SSP2295	301191622950	MERCEDES E350 (W212) 2009-2016	Suspension Stabilizer Bar Link - Front Left
SSP2295	301191622950	MERCEDES E400 (W212) 01/2009-2016	Suspension Stabilizer Bar Link - Front Left
SSP2295	301191622950	MERCEDES E500 (W212) 01/2009-2016	Suspension Stabilizer Bar Link - Front Left
SSP2296	301191622960	MERCEDES GLK250 (X204) 06/2008-2016	Suspension Stabilizer Bar Link - Front Right
SSP2296	301191622960	MERCEDES GLK280 (X204) 06/2008-2016	Suspension Stabilizer Bar Link - Front Right
SSP2296	301191622960	MERCEDES GLK300 (X204) 06/2008-2016	Suspension Stabilizer Bar Link - Front Right
SSP2296	301191622960	MERCEDES GLK350 (X204) 06/2008-2016	Suspension Stabilizer Bar Link - Front Right
SSP2297	301191622970	MERCEDES GLK250 (X204) 06/2008-2016	Suspension Stabilizer Bar Link - Front Left
SSP2297	301191622970	MERCEDES GLK280 (X204) 06/2008-2016	Suspension Stabilizer Bar Link - Front Left
SSP2297	301191622970	MERCEDES GLK300 (X204) 06/2008-2016	Suspension Stabilizer Bar Link - Front Left
SSP2297	301191622970	MERCEDES GLK350 (X204) 06/2008-2016	Suspension Stabilizer Bar Link - Front Left
SSP2298	301191622980	MERCEDES GLA180 (X156) 12/2013-	Suspension Stabilizer Bar Link - Front
SSP2298	301191622980	MERCEDES GLA200 (X156) 12/2013-	Suspension Stabilizer Bar Link - Front
SSP2298	301191622980	MERCEDES GLA250 (X156) 12/2013-	Suspension Stabilizer Bar Link - Front
SSP2298	301191622980	MERCEDES GLA45 AMG (X156) 12/2013-	Suspension Stabilizer Bar Link - Front
SSP2299	301191622990	MERCEDES GLA180 (X156) 12/2013-	Suspension Stabilizer Bar Link - Rear
SSP2299	301191622990	MERCEDES GLA200 (X156) 12/2013-	Suspension Stabilizer Bar Link - Rear
SSP2299	301191622990	MERCEDES GLA250 (X156) 12/2013-	Suspension Stabilizer Bar Link - Rear
SSP2299	301191622990	MERCEDES GLA45 AMG (X156) 12/2013-	Suspension Stabilizer Bar Link - Rear
SSP2300	301191623000	MERCEDES SLK200 (R172) 2011-	Suspension Stabilizer Bar Link - Front Right
SSP2300	301191623000	MERCEDES SLK280 (R172) 2011-	Suspension Stabilizer Bar Link - Front Right
SSP2300	301191623000	MERCEDES SLK300 (R172) 2011-	Suspension Stabilizer Bar Link - Front Right
SSP2300	301191623000	MERCEDES SLK350 (R172) 2011-	Suspension Stabilizer Bar Link - Front Right
SSP2300	301191623000	MERCEDES SLK55 AMG (R172) 2011-	Suspension Stabilizer Bar Link - Front Right
SSP2301	301191623010	MERCEDES SLK200 (R172) 2011-	Suspension Stabilizer Bar Link - Front Left
SSP2301	301191623010	MERCEDES SLK280 (R172) 2011-	Suspension Stabilizer Bar Link - Front Left
SSP2301	301191623010	MERCEDES SLK300 (R172) 2011-	Suspension Stabilizer Bar Link - Front Left
SSP2301	301191623010	MERCEDES SLK350 (R172) 2011-	Suspension Stabilizer Bar Link - Front Left
SSP2301	301191623010	MERCEDES SLK55 AMG (R172) 2011-	Suspension Stabilizer Bar Link - Front Left
SSP2302	301191623020	MERCEDES SLK200 (R172) 2011-	Suspension Stabilizer Bar Link - Rear
SSP2302	301191623020	MERCEDES SLK280 (R172) 2011-	Suspension Stabilizer Bar Link - Rear
SSP2302	301191623020	MERCEDES SLK300 (R172) 2011-	Suspension Stabilizer Bar Link - Rear
SSP2302	301191623020	MERCEDES SLK350 (R172) 2011-	Suspension Stabilizer Bar Link - Rear



 SHORT LONG			DESCRIPTION
SSP2302	301191623020	MERCEDES SLK55 AMG (R172) 2011-	Suspension Stabilizer Bar Link - Rear
SSP2303	301191623030	MERCEDES E280 (W210) 1995-2003	Suspension Stabilizer Bar Link - Rear
SSP2303	301191623030	MERCEDES E300 (W124) 1985-1996	Suspension Stabilizer Bar Link - Rear
SSP2303	301191623030	MERCEDES E300 (W210) 1995-2003	Suspension Stabilizer Bar Link - Rear
SSP2303	301191623030	MERCEDES E320 (W124) 1985-1996	Suspension Stabilizer Bar Link - Rear
SSP2303	301191623030	MERCEDES E320 (W210) 1995-2003	Suspension Stabilizer Bar Link - Rear
SSP2303	301191623030	MERCEDES E420 (W124) 1985-1996	Suspension Stabilizer Bar Link - Rear
SSP2303	301191623030	MERCEDES E420 (W210) 1995-2003	Suspension Stabilizer Bar Link - Rear
SSP2303	301191623030	MERCEDES E430 (W124) 1985-1996	Suspension Stabilizer Bar Link - Rear
SSP2303	301191623030	MERCEDES E430 (W210) 1995-2003	Suspension Stabilizer Bar Link - Rear
SSP2303	301191623030	MERCEDES E500 (W124) 1985-1996	Suspension Stabilizer Bar Link - Rear
SSP2303	301191623030	MERCEDES E500 (W210) 1995-2003	Suspension Stabilizer Bar Link - Rear
SSP2303	301191623030	MERCEDES E55 AMG (W124) 1985-1996	Suspension Stabilizer Bar Link - Rear
SSP2303	301191623030	MERCEDES E55 AMG (W210) 1995-2003	Suspension Stabilizer Bar Link - Rear
SSP2304	301191623040	MERCEDES CL200 C215 03/1999-03/2006	Suspension Stabilizer Bar Link - Rear
SSP2304	301191623040	MERCEDES CL230 C215 03/1999-03/2006	Suspension Stabilizer Bar Link - Rear
SSP2304	301191623040	MERCEDES CL500 C215 03/1999-03/2006	Suspension Stabilizer Bar Link - Rear
SSP2304	301191623040	MERCEDES CL55 AMG C215 03/1999-03/2006	Suspension Stabilizer Bar Link - Rear
SSP2304	301191623040	MERCEDES CL600 C215 03/1999-03/2006	Suspension Stabilizer Bar Link - Rear
SSP2304	301191623040	MERCEDES CL65 AMG C215 03/1999-03/2006	Suspension Stabilizer Bar Link - Rear
SSP2304	301191623040	MERCEDES S320 (W140) 1991-1999	Suspension Stabilizer Bar Link - Rear
SSP2304	301191623040	MERCEDES S320 (W220) 1991-1999	Suspension Stabilizer Bar Link - Rear
SSP2304	301191623040	MERCEDES S320 (W220) 1999-2005	Suspension Stabilizer Bar Link - Rear
SSP2304	301191623040	MERCEDES S350 (W140) 1991-1999	Suspension Stabilizer Bar Link - Rear
SSP2304	301191623040	MERCEDES S350 (W220) 1999-2005	Suspension Stabilizer Bar Link - Rear
SSP2304	301191623040	MERCEDES S420 (W140) 1991-1999	Suspension Stabilizer Bar Link - Rear
SSP2304	301191623040	MERCEDES S420 (W220) 1999-2005	Suspension Stabilizer Bar Link - Rear
SSP2304	301191623040	MERCEDES S430 (W220) 1999-2005	Suspension Stabilizer Bar Link - Rear
SSP2304	301191623040	MERCEDES S500 (W140) 1991-1999	Suspension Stabilizer Bar Link - Rear
SSP2304	301191623040	MERCEDES S500 (W220) 1999-2005	Suspension Stabilizer Bar Link - Rear
SSP2304	301191623040	MERCEDES S55 AMG (W220) 1999-2005	Suspension Stabilizer Bar Link - Rear
SSP2304	301191623040	MERCEDES S600 (W140) 1991-1999	Suspension Stabilizer Bar Link - Rear
SSP2304	301191623040	MERCEDES S600 (W220) 1999-2005	Suspension Stabilizer Bar Link - Rear
SSP2304	301191623040	MERCEDES S65 AMG (W220) 1999-2005	Suspension Stabilizer Bar Link - Rear
SSP2304	301191623040	MERCEDES SL500 (R230) 10/2001-01/2012	Suspension Stabilizer Bar Link - Rear
SSP2304	301191623040	MERCEDES SL55 AMG (R230) 10/2001-01/2012	Suspension Stabilizer Bar Link - Rear
SSP2304	301191623040	MERCEDES SL550 (R230) 10/2001-01/2012	Suspension Stabilizer Bar Link - Rear
SSP2304	301191623040	MERCEDES SL600 (R230) 10/2001-01/2012	Suspension Stabilizer Bar Link - Rear





 SHORT LONG			DESCRIPTION
SSP2304	301191623040	MERCEDES SL63 AMG (R230) 10/2001-01/2012	Suspension Stabilizer Bar Link - Rear
SSP2304	301191623040	MERCEDES SL65 AMG (R230) 10/2001-01/2012	Suspension Stabilizer Bar Link - Rear
SSP2305	301191623050	MERCEDES A160 (W168) 1997-2004	Suspension Stabilizer Bar Link - Front
SSP2305	301191623050	MERCEDES A190 (W168) 1997-2004	Suspension Stabilizer Bar Link - Front
SSP2306	301191623060	MERCEDES A160 (W168) 1997-2004	Suspension Stabilizer Bar Link - Front
SSP2306	301191623060	MERCEDES A190 (W168) 1997-2004	Suspension Stabilizer Bar Link - Front
SSP2307	301191623070	MERCEDES A160 (W169) 09/2004-06/2012	Suspension Stabilizer Bar Link - Front
SSP2307	301191623070	MERCEDES A190 (W169) 09/2004-06/2012	Suspension Stabilizer Bar Link - Front
SSP2307	301191623070	MERCEDES B180 (W245) 03/2005-11/2011	Suspension Stabilizer Bar Link - Front
SSP2307	301191623070	MERCEDES B200 (W245) 03/2005-11/2011	Suspension Stabilizer Bar Link - Front
SSP2308	301191623080	MERCEDES B180 (W245) 03/2005-11/2011	Suspension Stabilizer Bar Link - Front
SSP2308	301191623080	MERCEDES B200 (W245) 03/2005-11/2011	Suspension Stabilizer Bar Link - Front
SSP2309	301191623090	MERCEDES A160 (W169) 09/2004-06/2012	Suspension Stabilizer Bar Link - Rear
SSP2309	301191623090	MERCEDES A190 (W169) 09/2004-06/2012	Suspension Stabilizer Bar Link - Rear
SSP2309	301191623090	MERCEDES B200 (W245) 03/2005-11/2011	Suspension Stabilizer Bar Link - Rear
SSP2310	301191623100	MERCEDES C180 (W204) 10/2007-11/2013	Suspension Stabilizer Bar Link - Front Right
SSP2310	301191623100	MERCEDES C200 (W204) 10/2007-11/2013	Suspension Stabilizer Bar Link - Front Right
SSP2310	301191623100	MERCEDES C230 (W204) 10/2007-11/2013	Suspension Stabilizer Bar Link - Front Right
SSP2310	301191623100	MERCEDES C250 (W204) 10/2007-11/2013	Suspension Stabilizer Bar Link - Front Right
SSP2310	301191623100	MERCEDES C280 (W204) 10/2007-11/2013	Suspension Stabilizer Bar Link - Front Right
SSP2310	301191623100	MERCEDES C300 (W204) 10/2007-11/2013	Suspension Stabilizer Bar Link - Front Right
SSP2310	301191623100	MERCEDES C350 (W204) 10/2007-11/2013	Suspension Stabilizer Bar Link - Front Right
SSP2310	301191623100	MERCEDES C63 AMG (W204) 10/2007-11/2013	Suspension Stabilizer Bar Link - Front Right
SSP2311	301191623110	MERCEDES C180 (W204) 10/2007-11/2013	Suspension Stabilizer Bar Link - Front Right
SSP2311	301191623110	MERCEDES C200 (W204) 10/2007-11/2013	Suspension Stabilizer Bar Link - Front Right
SSP2311	301191623110	MERCEDES C230 (W204) 10/2007-11/2013	Suspension Stabilizer Bar Link - Front Right
SSP2311	301191623110	MERCEDES C250 (W204) 10/2007-11/2013	Suspension Stabilizer Bar Link - Front Right
SSP2311	301191623110	MERCEDES C280 (W204) 10/2007-11/2013	Suspension Stabilizer Bar Link - Front Right
SSP2311	301191623110	MERCEDES C300 (W204) 10/2007-11/2013	Suspension Stabilizer Bar Link - Front Right
SSP2311	301191623110	MERCEDES C350 (W204) 10/2007-11/2013	Suspension Stabilizer Bar Link - Front Right
SSP2311	301191623110	MERCEDES C63 AMG (W204) 10/2007-11/2013	Suspension Stabilizer Bar Link - Front Right
SSP2312	301191623120	MERCEDES C180 (W204) 10/2007-11/2013	Suspension Stabilizer Bar Link - Front Left
SSP2312	301191623120	MERCEDES C200 (W204) 10/2007-11/2013	Suspension Stabilizer Bar Link - Front Left
SSP2312	301191623120	MERCEDES C230 (W204) 10/2007-11/2013	Suspension Stabilizer Bar Link - Front Left
SSP2312	301191623120	MERCEDES C250 (W204) 10/2007-11/2013	Suspension Stabilizer Bar Link - Front Left
SSP2312	301191623120	MERCEDES C280 (W204) 10/2007-11/2013	Suspension Stabilizer Bar Link - Front Left
SSP2312	301191623120	MERCEDES C300 (W204) 10/2007-11/2013	Suspension Stabilizer Bar Link - Front Left
SSP2312	301191623120	MERCEDES C350 (W204) 10/2007-11/2013	Suspension Stabilizer Bar Link - Front Left



			DESCRIPTION
SHORT	LONG		
SSP2316	301191623160	MERCEDES E400 (W212) 01/2009-2016	Suspension Stabilizer Bar Link - Rear Right
SSP2316	301191623160	MERCEDES E500 (W212) 01/2009-2016	Suspension Stabilizer Bar Link - Rear Right
SSP2316	301191623160	MERCEDES E550 (W212) 01/2009-2016	Suspension Stabilizer Bar Link - Rear Right
SSP2316	301191623160	MERCEDES E63 AMG (W212) 01/2009-2016	Suspension Stabilizer Bar Link - Rear Right
SSP2316	301191623160	MERCEDES GLK250 (X204) 06/2008-2016	Suspension Stabilizer Bar Link - Rear Right
SSP2316	301191623160	MERCEDES GLK280 (X204) 06/2008-2016	Suspension Stabilizer Bar Link - Rear Right
SSP2316	301191623160	MERCEDES GLK300 (X204) 06/2008-2016	Suspension Stabilizer Bar Link - Rear Right
SSP2316	301191623160	MERCEDES GLK350 (X204) 06/2008-2016	Suspension Stabilizer Bar Link - Rear Right
SSP2317	301191623170	MERCEDES C180 (W204) 10/2007-11/2013	Suspension Stabilizer Bar Link - Rear Left
SSP2317	301191623170	MERCEDES C200 (W204) 10/2007-11/2013	Suspension Stabilizer Bar Link - Rear Left
SSP2317	301191623170	MERCEDES C230 (W204) 10/2007-11/2013	Suspension Stabilizer Bar Link - Rear Left
SSP2317	301191623170	MERCEDES C250 (W204) 10/2007-11/2013	Suspension Stabilizer Bar Link - Rear Left
SSP2317	301191623170	MERCEDES C280 (W204) 10/2007-11/2013	Suspension Stabilizer Bar Link - Rear Left
SSP2317	301191623170	MERCEDES C300 (W204) 10/2007-11/2013	Suspension Stabilizer Bar Link - Rear Left
SSP2317	301191623170	MERCEDES C350 (W204) 10/2007-11/2013	Suspension Stabilizer Bar Link - Rear Left
SSP2317	301191623170	MERCEDES C63 AMG (W204) 10/2007-11/2013	Suspension Stabilizer Bar Link - Rear Left
SSP2317	301191623170	MERCEDES E200 (W212) 01/2009-2016	Suspension Stabilizer Bar Link - Rear Left
SSP2317	301191623170	MERCEDES E250 (W212) 01/2009-2016	Suspension Stabilizer Bar Link - Rear Left
SSP2317	301191623170	MERCEDES E280 (W212) 01/2009-2016	Suspension Stabilizer Bar Link - Rear Left
SSP2317	301191623170	MERCEDES E300 (W212) 01/2009-2016	Suspension Stabilizer Bar Link - Rear Left
SSP2317	301191623170	MERCEDES E320 (W212) 01/2009-2016	Suspension Stabilizer Bar Link - Rear Left
SSP2317	301191623170	MERCEDES E400 (W212) 01/2009-2016	Suspension Stabilizer Bar Link - Rear Left
SSP2317	301191623170	MERCEDES E500 (W212) 01/2009-2016	Suspension Stabilizer Bar Link - Rear Left
SSP2317	301191623170	MERCEDES E550 (W212) 01/2009-2016	Suspension Stabilizer Bar Link - Rear Left
SSP2317	301191623170	MERCEDES E63 AMG (W212) 01/2009-2016	Suspension Stabilizer Bar Link - Rear Left
SSP2317	301191623170	MERCEDES GLK250 (X204) 06/2008-2016	Suspension Stabilizer Bar Link - Rear Left
SSP2317	301191623170	MERCEDES GLK280 (X204) 06/2008-2016	Suspension Stabilizer Bar Link - Rear Left
SSP2317	301191623170	MERCEDES GLK300 (X204) 06/2008-2016	Suspension Stabilizer Bar Link - Rear Left
SSP2317	301191623170	MERCEDES GLK350 (X204) 06/2008-2016	Suspension Stabilizer Bar Link - Rear Left
SSP2318	301191623180	MERCEDES A180 (W176) 06/2012-	Suspension Stabilizer Bar Link - Rear
SSP2318	301191623180	MERCEDES A200 (W176) 06/2012-	Suspension Stabilizer Bar Link - Rear
SSP2318	301191623180	MERCEDES A250 (W176) 06/2012-	Suspension Stabilizer Bar Link - Rear
SSP2318	301191623180	MERCEDES B180 (W246) 11/2011-2016	Suspension Stabilizer Bar Link - Rear
SSP2318	301191623180	MERCEDES B250 (W246) 11/2011-2016	Suspension Stabilizer Bar Link - Rear
SSP2318	301191623180	MERCEDES CLA180 (W176) 06/2012-	Suspension Stabilizer Bar Link - Rear
SSP2318	301191623180	MERCEDES CLA200 (W176) 06/2012-	Suspension Stabilizer Bar Link - Rear
SSP2318	301191623180	MERCEDES CLA250 (W176) 06/2012-	Suspension Stabilizer Bar Link - Rear
SSP2319	301191623190	MERCEDES A180 (W176) 06/2012-	Suspension Stabilizer Bar Link - Front
SSP2319	301191623190	MERCEDES A200 (W176) 06/2012-	Suspension Stabilizer Bar Link - Front
SSP2319	301191623190	MERCEDES A250 (W176) 06/2012-	Suspension Stabilizer Bar Link - Front





 SHORT LONG			DESCRIPTION
SSP2319	301191623190	MERCEDES B180 (W246) 11/2011-2016	Suspension Stabilizer Bar Link - Front
SSP2319	301191623190	MERCEDES B250 (W246) 11/2011-2016	Suspension Stabilizer Bar Link - Front
SSP2319	301191623190	MERCEDES CLA180 (W176) 06/2012-	Suspension Stabilizer Bar Link - Front
SSP2319	301191623190	MERCEDES CLA200 (W176) 06/2012-	Suspension Stabilizer Bar Link - Front
SSP2319	301191623190	MERCEDES CLA250 (W176) 06/2012-	Suspension Stabilizer Bar Link - Front
SSP2320	301191623200	MERCEDES VIANO (W447) 2014-	Suspension Stabilizer Bar Link - Front
SSP2320	301191623200	MERCEDES VITO (W447) 2014-	Suspension Stabilizer Bar Link - Front
SSP2321	301191623210	MERCEDES VIANO (W447) 2014-	Suspension Stabilizer Bar Link - Front Right
SSP2321	301191623210	MERCEDES VITO (W447) 2014-	Suspension Stabilizer Bar Link - Front Right
SSP2322	301191623220	MERCEDES VIANO (W447) 2014-	Suspension Stabilizer Bar Link - Front Left
SSP2322	301191623220	MERCEDES VITO (W447) 2014-	Suspension Stabilizer Bar Link - Front Left
SSP2323	301191623230	MERCEDES VIANO (W447) 2014-	Suspension Stabilizer Bar Link - Front Right
SSP2323	301191623230	MERCEDES VITO (W447) 2014-	Suspension Stabilizer Bar Link - Front Right
SSP2324	301191623240	MERCEDES VIANO (W447) 2014-	Suspension Stabilizer Bar Link - Front Left
SSP2324	301191623240	MERCEDES VITO (W447) 2014-	Suspension Stabilizer Bar Link - Front Left
SSP2325	301191623250	MERCEDES ML250 (W166) 07/2011-	Suspension Stabilizer Bar Link - Front Right
SSP2325	301191623250	MERCEDES ML350 (W166) 07/2011-	Suspension Stabilizer Bar Link - Front Right
SSP2325	301191623250	MERCEDES ML400 (W166) 07/2011-	Suspension Stabilizer Bar Link - Front Right
SSP2325	301191623250	MERCEDES ML500 (W166) 07/2011-	Suspension Stabilizer Bar Link - Front Right
SSP2325	301191623250	MERCEDES ML550 (W166) 07/2011-	Suspension Stabilizer Bar Link - Front Right
SSP2325	301191623250	MERCEDES ML63 AMG (W166) 07/2011-	Suspension Stabilizer Bar Link - Front Right
SSP2326	301191623260	MERCEDES ML250 (W166) 07/2011-	Suspension Stabilizer Bar Link - Front Left
SSP2326	301191623260	MERCEDES ML350 (W166) 07/2011-	Suspension Stabilizer Bar Link - Front Left
SSP2326	301191623260	MERCEDES ML400 (W166) 07/2011-	Suspension Stabilizer Bar Link - Front Left
SSP2326	301191623260	MERCEDES ML500 (W166) 07/2011-	Suspension Stabilizer Bar Link - Front Left
SSP2326	301191623260	MERCEDES ML550 (W166) 07/2011-	Suspension Stabilizer Bar Link - Front Left
SSP2326	301191623260	MERCEDES ML63 AMG (W166) 07/2011-	Suspension Stabilizer Bar Link - Front Left
SSP2327	301191623270	MERCEDES VITO (W638) 03/1997-07/2003	Suspension Stabilizer Bar Link - Front Right
SSP2328	301191623280	MERCEDES VITO (W638) 03/1997-07/2003	Suspension Stabilizer Bar Link - Front Left
SSP2329	301191623290	MERCEDES VITO (W638) 03/1997-07/2003	Suspension Stabilizer Bar Link - Rear
SSP2330	301191623300	MERCEDES VITO (W638) 03/1997-07/2003	Suspension Stabilizer Bar Link - Rear
SSP2331	301191623310	MERCEDES VITO (W638) 03/1997-07/2003	Suspension Stabilizer Bar Link - Front Right
SSP2332	301191623320	MERCEDES VITO (W638) 03/1997-07/2003	Suspension Stabilizer Bar Link - Front Left
SSP2333	301191623330	MERCEDES VITO (W639) 03/2003-07/2014	Suspension Stabilizer Bar Link - Front Right
SSP2334	301191623340	MERCEDES VITO (W639) 03/2003-07/2014	Suspension Stabilizer Bar Link - Front Left
SSP2335	301191623350	MERCEDES VIANO (W639) 03/2003-07/2014	Suspension Stabilizer Bar Link - Rear
SSP2335	301191623350	MERCEDES VITO (W639) 03/2003-07/2014	Suspension Stabilizer Bar Link - Rear
SSP2336	301191623360	MERCEDES Vaneo (W414) 02/2002-07/2005	Suspension Stabilizer Bar Link - Front
SSP2337	301191623370	MERCEDES VIANO (W639) 03/2003-07/2014	Suspension Stabilizer Bar Link - Front Right
SSP2337	301191623370	MERCEDES VITO (W639) 03/2003-07/2014	Suspension Stabilizer Bar Link - Front Right
SSP2338	301191623380	MERCEDES VIANO (W639) 03/2003-07/2014	Suspension Stabilizer Bar Link - Front Left



 SHORT LONG			DESCRIPTION
SSP2338	301191623380	MERCEDES VITO (W639) 03/2003-07/2014	Suspension Stabilizer Bar Link - Front Left
SSP2339	301191623390	DODGE SPRINTER 2500 W901,W902,W903 01/1995-05/2006	Suspension Stabilizer Bar Link - Front Right
SSP2339	301191623390	DODGE SPRINTER 3500 W901,W902,W903 01/1995-05/2006	Suspension Stabilizer Bar Link - Front Right
SSP2339	301191623390	MERCEDES SPRINTER (W901,W902,W903) 01/1995-05/2006	Suspension Stabilizer Bar Link - Front Right
SSP2339	301191623390	VOLKSWAGEN LT 28-35-46, Typ 2D 04/1996- 07/2006	Suspension Stabilizer Bar Link - Front Right
SSP2340	301191623400	DODGE SPRINTER 2500 W901,W902,W903 01/1995-05/2006	Suspension Stabilizer Bar Link - Front Left
SSP2340	301191623400	DODGE SPRINTER 3500 W901,W902,W903 01/1995-05/2006	Suspension Stabilizer Bar Link - Front Left
SSP2340	301191623400	MERCEDES SPRINTER (W901,W902,W903) 01/1995-05/2006	Suspension Stabilizer Bar Link - Front Left
SSP2340	301191623400	VOLKSWAGEN LT 28-35-46, Typ 2D 04/1996- 07/2006	Suspension Stabilizer Bar Link - Front Left
SSP2341	301191623410	DODGE SPRINTER 2500 W901,W902,W903 01/1995-05/2006	Suspension Stabilizer Bar Link - Rear
SSP2341	301191623410	DODGE SPRINTER 3500 W901,W902,W903 01/1995-05/2006	Suspension Stabilizer Bar Link - Rear
SSP2341	301191623410	MERCEDES SPRINTER (W901,W902,W903) 01/1995-05/2006	Suspension Stabilizer Bar Link - Rear
SSP2341	301191623410	VOLKSWAGEN LT 28-35-46, Typ 2D 04/1996- 07/2006	Suspension Stabilizer Bar Link - Rear
SSP2342	301191623420	MERCEDES SPRINTER (W901,W902,W903) 01/1995-05/2006	Suspension Stabilizer Bar Link - Rear
SSP2343	301191623430	DODGE SPRINTER 2500 W901,W902,W903 01/1995-05/2006	Suspension Stabilizer Bar Link - Front Right
SSP2343	301191623430	DODGE SPRINTER 3500 W901,W902,W903 01/1995-05/2006	Suspension Stabilizer Bar Link - Front Right
SSP2343	301191623430	MERCEDES SPRINTER (W901,W902,W903) 01/1995-05/2006	Suspension Stabilizer Bar Link - Front Right
SSP2344	301191623440	DODGE SPRINTER 2500 W901,W902,W903 01/1995-05/2006	Suspension Stabilizer Bar Link - Front Left
SSP2344	301191623440	DODGE SPRINTER 3500 W901,W902,W903 01/1995-05/2006	Suspension Stabilizer Bar Link - Front Left
SSP2344	301191623440	MERCEDES SPRINTER (W901,W902,W903) 01/1995-05/2006	Suspension Stabilizer Bar Link - Front Left
SSP2345	301191623450	DODGE SPRINTER 2500 W901,W902,W903 01/1995-05/2006	Suspension Stabilizer Bar Link - Rear
SSP2345	301191623450	DODGE SPRINTER 3500 W901,W902,W903 01/1995-05/2006	Suspension Stabilizer Bar Link - Rear
SSP2345	301191623450	MERCEDES SPRINTER (W901,W902,W903) 01/1995-05/2006	Suspension Stabilizer Bar Link - Rear
SSP2346	301191623460	MERCEDES SPRINTER (W906) 06/2006-	Suspension Stabilizer Bar Link - Rear
SSP2346	301191623460	VOLKSWAGEN CRAFTER 04/2006-	Suspension Stabilizer Bar Link - Rear
SSP2347	301191623470	DODGE SPRINTER 2500 W906 06/2006-	Suspension Stabilizer Bar Link - Front Right
SSP2347	301191623470	DODGE SPRINTER 3500 W906 06/2006-	Suspension Stabilizer Bar Link - Front Right
SSP2347	301191623470	MERCEDES SPRINTER (W906) 06/2006-	Suspension Stabilizer Bar Link - Front Right





 SHORT LONG			DESCRIPTION
SSP2347	301191623470	MERCEDES SPRINTER 2500 (W906) 06/2006-	Suspension Stabilizer Bar Link - Front Right
SSP2347	301191623470	MERCEDES SPRINTER 3500 (W906) 06/2006-	Suspension Stabilizer Bar Link - Front Right
SSP2347	301191623470	VOLKSWAGEN CRAFTER 04/2006-	Suspension Stabilizer Bar Link - Front Right
SSP2348	301191623480	DODGE SPRINTER 2500 W906 06/2006-	Suspension Stabilizer Bar Link - Front Left
SSP2348	301191623480	DODGE SPRINTER 3500 W906 06/2006-	Suspension Stabilizer Bar Link - Front Left
SSP2348	301191623480	MERCEDES SPRINTER (W906) 06/2006-	Suspension Stabilizer Bar Link - Front Left
SSP2348	301191623480	MERCEDES SPRINTER 2500 (W906) 06/2006-	Suspension Stabilizer Bar Link - Front Left
SSP2348	301191623480	MERCEDES SPRINTER 3500 (W906) 06/2006-	Suspension Stabilizer Bar Link - Front Left
SSP2348	301191623480	VOLKSWAGEN CRAFTER 04/2006-	Suspension Stabilizer Bar Link - Front Left
SSP2349	301191623490	MERCEDES C200 (W203) 05/2000-02/2007	Suspension Stabilizer Bar Link - Front
SSP2349	301191623490	MERCEDES C230 (W203) 05/2000-02/2007	Suspension Stabilizer Bar Link - Front
SSP2349	301191623490	MERCEDES C240 (W203) 05/2000-02/2007	Suspension Stabilizer Bar Link - Front
SSP2349	301191623490	MERCEDES C280 (W203) 05/2000-02/2007	Suspension Stabilizer Bar Link - Front
SSP2349	301191623490	MERCEDES C32 AMG (W203) 05/2000- 02/2007	Suspension Stabilizer Bar Link - Front
SSP2349	301191623490	MERCEDES C320 (W203) 05/2000-02/2007	Suspension Stabilizer Bar Link - Front
SSP2349	301191623490	MERCEDES C350 (W203) 05/2000-02/2007	Suspension Stabilizer Bar Link - Front
SSP2349	301191623490	MERCEDES C55 AMG (W203) 05/2000- 02/2007	Suspension Stabilizer Bar Link - Front
SSP2349	301191623490	MERCEDES CLK280 (A209-C209) 06/2002- 05/2009	Suspension Stabilizer Bar Link - Front
SSP2349	301191623490	MERCEDES CLK320 (A209-C209) 06/2002- 05/2009	Suspension Stabilizer Bar Link - Front
SSP2349	301191623490	MERCEDES CLK350 (A209-C209) 06/2002- 05/2009	Suspension Stabilizer Bar Link - Front
SSP2349	301191623490	MERCEDES CLK430 (A209-C209) 06/2002- 05/2009	Suspension Stabilizer Bar Link - Front
SSP2349	301191623490	MERCEDES CLK500 (A209-C209) 06/2002- 05/2009	Suspension Stabilizer Bar Link - Front
SSP2349	301191623490	MERCEDES CLK55 AMG (A209-C209) 06/2002-05/2009	Suspension Stabilizer Bar Link - Front
SSP2349	301191623490	MERCEDES CLK550 (A209-C209) 06/2002- 05/2009	Suspension Stabilizer Bar Link - Front
SSP2349	301191623490	MERCEDES CLK63 AMG (A209-C209) 06/2002-05/2009	Suspension Stabilizer Bar Link - Front
SSP2349	301191623490	MERCEDES SLK200 (R171) 03/2004-02/2011	Suspension Stabilizer Bar Link - Front
SSP2349	301191623490	MERCEDES SLK280 (R171) 03/2004-02/2011	Suspension Stabilizer Bar Link - Front
SSP2349	301191623490	MERCEDES SLK300 (R171) 03/2004-02/2011	Suspension Stabilizer Bar Link - Front
SSP2349	301191623490	MERCEDES SLK350 (R171) 03/2004-02/2011	Suspension Stabilizer Bar Link - Front
SSP2349	301191623490	MERCEDES SLK55 AMG (R171) 03/2004- 02/2011	Suspension Stabilizer Bar Link - Front
SSP2350	301191623500	MERCEDES C200 (W203) 05/2000-02/2007	Suspension Stabilizer Bar Link - Front
SSP2350	301191623500	MERCEDES C230 (W203) 05/2000-02/2007	Suspension Stabilizer Bar Link - Front



			DESCRIPTION
SHORT	LONG		
SSP2350	301191623500	MERCEDES C240 (W203) 05/2000-02/2007	Suspension Stabilizer Bar Link - Front
SSP2350	301191623500	MERCEDES C280 (W203) 05/2000-02/2007	Suspension Stabilizer Bar Link - Front
SSP2350	301191623500	MERCEDES C32 AMG (W203) 05/2000-02/2007	Suspension Stabilizer Bar Link - Front
SSP2350	301191623500	MERCEDES C320 (W203) 05/2000-02/2007	Suspension Stabilizer Bar Link - Front
SSP2350	301191623500	MERCEDES C350 (W203) 05/2000-02/2007	Suspension Stabilizer Bar Link - Front
SSP2350	301191623500	MERCEDES C55 AMG (W203) 05/2000-02/2007	Suspension Stabilizer Bar Link - Front
SSP2351	301191623510	MERCEDES C200 (W203) 05/2000-02/2007	Suspension Stabilizer Bar Link - Rear Right
SSP2351	301191623510	MERCEDES C230 (W203) 05/2000-02/2007	Suspension Stabilizer Bar Link - Rear Right
SSP2351	301191623510	MERCEDES C240 (W203) 05/2000-02/2007	Suspension Stabilizer Bar Link - Rear Right
SSP2351	301191623510	MERCEDES C280 (W203) 05/2000-02/2007	Suspension Stabilizer Bar Link - Rear Right
SSP2351	301191623510	MERCEDES C32 AMG (W203) 05/2000-02/2007	Suspension Stabilizer Bar Link - Rear Right
SSP2351	301191623510	MERCEDES C320 (W203) 05/2000-02/2007	Suspension Stabilizer Bar Link - Rear Right
SSP2351	301191623510	MERCEDES C350 (W203) 05/2000-02/2007	Suspension Stabilizer Bar Link - Rear Right
SSP2351	301191623510	MERCEDES C55 AMG (W203) 05/2000-02/2007	Suspension Stabilizer Bar Link - Rear Right
SSP2351	301191623510	MERCEDES CLK280 (A209-C209) 06/2002-05/2009	Suspension Stabilizer Bar Link - Rear Right
SSP2351	301191623510	MERCEDES CLK320 (A209-C209) 06/2002-05/2009	Suspension Stabilizer Bar Link - Rear Right
SSP2351	301191623510	MERCEDES CLK350 (A209-C209) 06/2002-05/2009	Suspension Stabilizer Bar Link - Rear Right
SSP2351	301191623510	MERCEDES CLK430 (A209-C209) 06/2002-05/2009	Suspension Stabilizer Bar Link - Rear Right
SSP2351	301191623510	MERCEDES CLK500 (A209-C209) 06/2002-05/2009	Suspension Stabilizer Bar Link - Rear Right
SSP2351	301191623510	MERCEDES CLK55 AMG (A209-C209) 06/2002-05/2009	Suspension Stabilizer Bar Link - Rear Right
SSP2351	301191623510	MERCEDES CLK550 (A209-C209) 06/2002-05/2009	Suspension Stabilizer Bar Link - Rear Right
SSP2351	301191623510	MERCEDES CLK63 AMG (A209-C209) 06/2002-05/2009	Suspension Stabilizer Bar Link - Rear Right
SSP2352	301191623520	MERCEDES C200 (W203) 05/2000-02/2007	Suspension Stabilizer Bar Link - Rear Left
SSP2352	301191623520	MERCEDES C230 (W203) 05/2000-02/2007	Suspension Stabilizer Bar Link - Rear Left
SSP2352	301191623520	MERCEDES C240 (W203) 05/2000-02/2007	Suspension Stabilizer Bar Link - Rear Left
SSP2352	301191623520	MERCEDES C280 (W203) 05/2000-02/2007	Suspension Stabilizer Bar Link - Rear Left
SSP2352	301191623520	MERCEDES C32 AMG (W203) 05/2000-02/2007	Suspension Stabilizer Bar Link - Rear Left
SSP2352	301191623520	MERCEDES C320 (W203) 05/2000-02/2007	Suspension Stabilizer Bar Link - Rear Left
SSP2352	301191623520	MERCEDES C350 (W203) 05/2000-02/2007	Suspension Stabilizer Bar Link - Rear Left
SSP2352	301191623520	MERCEDES C55 AMG (W203) 05/2000-02/2007	Suspension Stabilizer Bar Link - Rear Left
SSP2352	301191623520	MERCEDES CLK280 (A209-C209) 06/2002-05/2009	Suspension Stabilizer Bar Link - Rear Left





			DESCRIPTION
SHORT	LONG		
SSP2352	301191623520	MERCEDES CLK320 (A209-C209) 06/2002-05/2009	Suspension Stabilizer Bar Link - Rear Left
SSP2352	301191623520	MERCEDES CLK350 (A209-C209) 06/2002-05/2009	Suspension Stabilizer Bar Link - Rear Left
SSP2352	301191623520	MERCEDES CLK430 (A209-C209) 06/2002-05/2009	Suspension Stabilizer Bar Link - Rear Left
SSP2352	301191623520	MERCEDES CLK500 (A209-C209) 06/2002-05/2009	Suspension Stabilizer Bar Link - Rear Left
SSP2352	301191623520	MERCEDES CLK55 AMG (A209-C209) 06/2002-05/2009	Suspension Stabilizer Bar Link - Rear Left
SSP2352	301191623520	MERCEDES CLK550 (A209-C209) 06/2002-05/2009	Suspension Stabilizer Bar Link - Rear Left
SSP2352	301191623520	MERCEDES CLK63 AMG (A209-C209) 06/2002-05/2009	Suspension Stabilizer Bar Link - Rear Left
SSP2353	301191623530	MERCEDES C200 (W203) 05/2000-02/2007	Suspension Stabilizer Bar Link - Front
SSP2353	301191623530	MERCEDES C230 (W203) 05/2000-02/2007	Suspension Stabilizer Bar Link - Front
SSP2353	301191623530	MERCEDES C240 (W203) 05/2000-02/2007	Suspension Stabilizer Bar Link - Front
SSP2353	301191623530	MERCEDES C280 (W203) 05/2000-02/2007	Suspension Stabilizer Bar Link - Front
SSP2353	301191623530	MERCEDES C32 AMG (W203) 05/2000-02/2007	Suspension Stabilizer Bar Link - Front
SSP2353	301191623530	MERCEDES C320 (W203) 05/2000-02/2007	Suspension Stabilizer Bar Link - Front
SSP2353	301191623530	MERCEDES C350 (W203) 05/2000-02/2007	Suspension Stabilizer Bar Link - Front
SSP2353	301191623530	MERCEDES C55 AMG (W203) 05/2000-02/2007	Suspension Stabilizer Bar Link - Front
SSP2354	301191623540	MERCEDES C200 (W203) 05/2000-02/2007	Suspension Stabilizer Bar Link - Front
SSP2355	301191623550	MERCEDES C300 (W205) AWD 12/2013-	Suspension Stabilizer Bar Link - Front Right
SSP2355	301191623550	MERCEDES C350 (W205) AWD 12/2013-	Suspension Stabilizer Bar Link - Front Right
SSP2355	301191623550	MERCEDES C400 (W205) AWD 12/2013-	Suspension Stabilizer Bar Link - Front Right
SSP2355	301191623550	MERCEDES C450 AMG (W205) AWD 12/2013-	Suspension Stabilizer Bar Link - Front Right
SSP2356	301191623560	MERCEDES C300 (W205) AWD 12/2013-	Suspension Stabilizer Bar Link - Front Left
SSP2356	301191623560	MERCEDES C350 (W205) AWD 12/2013-	Suspension Stabilizer Bar Link - Front Left
SSP2356	301191623560	MERCEDES C400 (W205) AWD 12/2013-	Suspension Stabilizer Bar Link - Front Left
SSP2356	301191623560	MERCEDES C450 AMG (W205) AWD 12/2013-	Suspension Stabilizer Bar Link - Front Left
SSP2357	301191623570	MERCEDES C180 (W205) RWD 12/2013-	Suspension Stabilizer Bar Link - Front Right
SSP2357	301191623570	MERCEDES C200 (W205) RWD 12/2013-	Suspension Stabilizer Bar Link - Front Right
SSP2357	301191623570	MERCEDES C250 (W205) RWD 12/2013-	Suspension Stabilizer Bar Link - Front Right
SSP2357	301191623570	MERCEDES C300 (W205) RWD 12/2013-	Suspension Stabilizer Bar Link - Front Right
SSP2357	301191623570	MERCEDES C350 (W205) RWD 12/2013-	Suspension Stabilizer Bar Link - Front Right
SSP2357	301191623570	MERCEDES C63 AMG (W205) RWD 12/2013-	Suspension Stabilizer Bar Link - Front Right
SSP2357	301191623570	MERCEDES C63 AMG S (W205) RWD 12/2013-	Suspension Stabilizer Bar Link - Front Right
SSP2358	301191623580	MERCEDES C180 (W205) RWD 12/2013-	Suspension Stabilizer Bar Link - Front Left
SSP2358	301191623580	MERCEDES C200 (W205) RWD 12/2013-	Suspension Stabilizer Bar Link - Front Left
SSP2358	301191623580	MERCEDES C250 (W205) RWD 12/2013-	Suspension Stabilizer Bar Link - Front Left



			DESCRIPTION
SHORT	LONG		
SSP2358	301191623580	MERCEDES C300 (W205) RWD 12/2013-	Suspension Stabilizer Bar Link - Front Left
SSP2358	301191623580	MERCEDES C350 (W205) RWD 12/2013-	Suspension Stabilizer Bar Link - Front Left
SSP2358	301191623580	MERCEDES C63 AMG (W205) RWD 12/2013-	Suspension Stabilizer Bar Link - Front Left
SSP2358	301191623580	MERCEDES C63 AMG S (W205) RWD 12/2013-	Suspension Stabilizer Bar Link - Front Left
SSP2359	301191623590	MERCEDES C180 (W205) RWD 12/2013-	Suspension Stabilizer Bar Link - Rear Right
SSP2359	301191623590	MERCEDES C200 (W205) RWD 12/2013-	Suspension Stabilizer Bar Link - Rear Right
SSP2359	301191623590	MERCEDES C250 (W205) RWD 12/2013-	Suspension Stabilizer Bar Link - Rear Right
SSP2359	301191623590	MERCEDES C300 (W205) AWD 12/2013-	Suspension Stabilizer Bar Link - Rear Right
SSP2359	301191623590	MERCEDES C300 (W205) RWD 12/2013-	Suspension Stabilizer Bar Link - Rear Right
SSP2359	301191623590	MERCEDES C350 (W205) AWD 12/2013-	Suspension Stabilizer Bar Link - Rear Right
SSP2359	301191623590	MERCEDES C350 (W205) RWD 12/2013-	Suspension Stabilizer Bar Link - Rear Right
SSP2359	301191623590	MERCEDES C400 (W205) AWD 12/2013-	Suspension Stabilizer Bar Link - Rear Right
SSP2359	301191623590	MERCEDES C450 AMG (W205) AWD 12/2013-	Suspension Stabilizer Bar Link - Rear Right
SSP2359	301191623590	MERCEDES C63 AMG (W205) RWD 12/2013-	Suspension Stabilizer Bar Link - Rear Right
SSP2359	301191623590	MERCEDES C63 AMG S (W205) RWD 12/2013-	Suspension Stabilizer Bar Link - Rear Right
SSP2360	301191623600	MERCEDES C180 (W205) RWD 12/2013-	Suspension Stabilizer Bar Link - Rear Left
SSP2360	301191623600	MERCEDES C200 (W205) RWD 12/2013-	Suspension Stabilizer Bar Link - Rear Left
SSP2360	301191623600	MERCEDES C250 (W205) RWD 12/2013-	Suspension Stabilizer Bar Link - Rear Left
SSP2360	301191623600	MERCEDES C300 (W205) AWD 12/2013-	Suspension Stabilizer Bar Link - Rear Left
SSP2360	301191623600	MERCEDES C300 (W205) RWD 12/2013-	Suspension Stabilizer Bar Link - Rear Left
SSP2360	301191623600	MERCEDES C350 (W205) AWD 12/2013-	Suspension Stabilizer Bar Link - Rear Left
SSP2360	301191623600	MERCEDES C350 (W205) RWD 12/2013-	Suspension Stabilizer Bar Link - Rear Left
SSP2360	301191623600	MERCEDES C400 (W205) AWD 12/2013-	Suspension Stabilizer Bar Link - Rear Left
SSP2360	301191623600	MERCEDES C450 AMG (W205) AWD 12/2013-	Suspension Stabilizer Bar Link - Rear Left
SSP2360	301191623600	MERCEDES C63 AMG (W205) RWD 12/2013-	Suspension Stabilizer Bar Link - Rear Left
SSP2360	301191623600	MERCEDES C63 AMG S (W205) RWD 12/2013-	Suspension Stabilizer Bar Link - Rear Left
SSP2361	301191623610	MERCEDES ML500 (W163) 1998-06/2005	Suspension Stabilizer Bar Link - Rear
SSP2362	301191623620	MERCEDES ML350 (W163) 1998-06/2005	Suspension Stabilizer Bar Link - Front Right
SSP2362	301191623620	MERCEDES ML500 (W163) 1998-06/2005	Suspension Stabilizer Bar Link - Front Right
SSP2363	301191623630	MERCEDES ML350 (W163) 1998-06/2005	Suspension Stabilizer Bar Link - Front Left
SSP2363	301191623630	MERCEDES ML500 (W163) 1998-06/2005	Suspension Stabilizer Bar Link - Front Left
SSP2364	301191623640	MERCEDES ML350 (W164) 07/2005-05/2011	Suspension Stabilizer Bar Link - Front
SSP2364	301191623640	MERCEDES ML500 (W164) 07/2005-05/2011	Suspension Stabilizer Bar Link - Front
SSP2364	301191623640	MERCEDES ML550 (W164) 07/2005-05/2011	Suspension Stabilizer Bar Link - Front
SSP2364	301191623640	MERCEDES ML63 AMG (W164) 07/2005-05/2011	Suspension Stabilizer Bar Link - Front
SSP2364	301191623640	MERCEDES R320 (W251) 09/2006-08/2013	Suspension Stabilizer Bar Link - Front
SSP2364	301191623640	MERCEDES R350 (W251) 09/2006-08/2013	Suspension Stabilizer Bar Link - Front





			DESCRIPTION
SHORT	LONG		
SSP2364	301191623640	MERCEDES R500 (W251) 09/2006-08/2013	Suspension Stabilizer Bar Link - Front
SSP2364	301191623640	MERCEDES R550 (W251) 09/2006-08/2013	Suspension Stabilizer Bar Link - Front
SSP2364	301191623640	MERCEDES R63 AMG (W251) 09/2006-08/2013	Suspension Stabilizer Bar Link - Front
SSP2365	301191623650	MERCEDES ML250 (W166) 07/2011-	Suspension Stabilizer Bar Link - Rear
SSP2365	301191623650	MERCEDES ML350 (W164) 07/2005-05/2011	Suspension Stabilizer Bar Link - Rear
SSP2365	301191623650	MERCEDES ML350 (W166) 07/2011-	Suspension Stabilizer Bar Link - Rear
SSP2365	301191623650	MERCEDES ML400 (W166) 07/2011-	Suspension Stabilizer Bar Link - Rear
SSP2365	301191623650	MERCEDES ML500 (W164) 07/2005-05/2011	Suspension Stabilizer Bar Link - Rear
SSP2365	301191623650	MERCEDES ML500 (W166) 07/2011-	Suspension Stabilizer Bar Link - Rear
SSP2365	301191623650	MERCEDES ML550 (W164) 07/2005-05/2011	Suspension Stabilizer Bar Link - Rear
SSP2365	301191623650	MERCEDES ML550 (W166) 07/2011-	Suspension Stabilizer Bar Link - Rear
SSP2365	301191623650	MERCEDES ML63 AMG (W164) 07/2005-05/2011	Suspension Stabilizer Bar Link - Rear
SSP2365	301191623650	MERCEDES ML63 AMG (W166) 07/2011-	Suspension Stabilizer Bar Link - Rear
SSP2365	301191623650	MERCEDES R320 (W251) 09/2006-08/2013	Suspension Stabilizer Bar Link - Rear
SSP2365	301191623650	MERCEDES R350 (W251) 09/2006-08/2013	Suspension Stabilizer Bar Link - Rear
SSP2365	301191623650	MERCEDES R500 (W251) 09/2006-08/2013	Suspension Stabilizer Bar Link - Rear
SSP2365	301191623650	MERCEDES R550 (W251) 09/2006-08/2013	Suspension Stabilizer Bar Link - Rear
SSP2365	301191623650	MERCEDES R63 AMG (W251) 09/2006-08/2013	Suspension Stabilizer Bar Link - Rear
SSP2366	301191623660	MERCEDES R320 (W251) 09/2006-08/2013	Suspension Stabilizer Bar Link - Front
SSP2366	301191623660	MERCEDES R350 (W251) 09/2006-08/2013	Suspension Stabilizer Bar Link - Front
SSP2366	301191623660	MERCEDES R500 (W251) 09/2006-08/2013	Suspension Stabilizer Bar Link - Front
SSP2366	301191623660	MERCEDES R550 (W251) 09/2006-08/2013	Suspension Stabilizer Bar Link - Front
SSP2366	301191623660	MERCEDES R63 AMG (W251) 09/2006-08/2013	Suspension Stabilizer Bar Link - Front
SSP2367	301191623670	MERCEDES S320 (W220) 1999-2005	Suspension Stabilizer Bar Link - Front Right
SSP2367	301191623670	MERCEDES S350 (W220) 1999-2005	Suspension Stabilizer Bar Link - Front Right
SSP2367	301191623670	MERCEDES S420 (W220) 1999-2005	Suspension Stabilizer Bar Link - Front Right
SSP2367	301191623670	MERCEDES S430 (W220) 1999-2005	Suspension Stabilizer Bar Link - Front Right
SSP2367	301191623670	MERCEDES S500 (W220) 1999-2005	Suspension Stabilizer Bar Link - Front Right
SSP2367	301191623670	MERCEDES S55 AMG (W220) 1999-2005	Suspension Stabilizer Bar Link - Front Right
SSP2367	301191623670	MERCEDES S600 (W220) 1999-2005	Suspension Stabilizer Bar Link - Front Right
SSP2367	301191623670	MERCEDES S65 AMG (W220) 1999-2005	Suspension Stabilizer Bar Link - Front Right
SSP2368	301191623680	MERCEDES S320 (W220) 1999-2005	Suspension Stabilizer Bar Link - Front Left
SSP2368	301191623680	MERCEDES S350 (W220) 1999-2005	Suspension Stabilizer Bar Link - Front Left
SSP2368	301191623680	MERCEDES S420 (W220) 1999-2005	Suspension Stabilizer Bar Link - Front Left
SSP2368	301191623680	MERCEDES S430 (W220) 1999-2005	Suspension Stabilizer Bar Link - Front Left
SSP2368	301191623680	MERCEDES S500 (W220) 1999-2005	Suspension Stabilizer Bar Link - Front Left
SSP2368	301191623680	MERCEDES S55 AMG (W220) 1999-2005	Suspension Stabilizer Bar Link - Front Left
SSP2368	301191623680	MERCEDES S600 (W220) 1999-2005	Suspension Stabilizer Bar Link - Front Left



			DESCRIPTION
SHORT	LONG		
SSP2368	301191623680	MERCEDES S65 AMG (W220) 1999-2005	Suspension Stabilizer Bar Link - Front Left
SSP2369	301191623690	MERCEDES CL200 C215 03/1999-03/2006	Suspension Stabilizer Bar Link - Rear
SSP2369	301191623690	MERCEDES CL230 C215 03/1999-03/2006	Suspension Stabilizer Bar Link - Rear
SSP2369	301191623690	MERCEDES CL500 C215 03/1999-03/2006	Suspension Stabilizer Bar Link - Rear
SSP2369	301191623690	MERCEDES CL55 AMG C215 03/1999-03/2006	Suspension Stabilizer Bar Link - Rear
SSP2369	301191623690	MERCEDES CL600 C215 03/1999-03/2006	Suspension Stabilizer Bar Link - Rear
SSP2369	301191623690	MERCEDES CL65 AMG C215 03/1999-03/2006	Suspension Stabilizer Bar Link - Rear
SSP2369	301191623690	MERCEDES S320 (W220) 1999-2005	Suspension Stabilizer Bar Link - Rear
SSP2369	301191623690	MERCEDES S350 (W220) 1999-2005	Suspension Stabilizer Bar Link - Rear
SSP2369	301191623690	MERCEDES S420 (W220) 1999-2005	Suspension Stabilizer Bar Link - Rear
SSP2369	301191623690	MERCEDES S430 (W220) 1999-2005	Suspension Stabilizer Bar Link - Rear
SSP2369	301191623690	MERCEDES S500 (W220) 1999-2005	Suspension Stabilizer Bar Link - Rear
SSP2369	301191623690	MERCEDES S55 AMG (W220) 1999-2005	Suspension Stabilizer Bar Link - Rear
SSP2369	301191623690	MERCEDES S600 (W220) 1999-2005	Suspension Stabilizer Bar Link - Rear
SSP2369	301191623690	MERCEDES S65 AMG (W220) 1999-2005	Suspension Stabilizer Bar Link - Rear
SSP2370	301191623700	MERCEDES CLS350 (C219) RWD 10/2004-12/2010	Suspension Stabilizer Bar Link - Rear
SSP2370	301191623700	MERCEDES CLS500 (C219) RWD 10/2004-12/2010	Suspension Stabilizer Bar Link - Rear
SSP2370	301191623700	MERCEDES CLS55 AMG (C219) RWD 10/2004-12/2010	Suspension Stabilizer Bar Link - Rear
SSP2370	301191623700	MERCEDES CLS550 (C219) RWD 10/2004-12/2010	Suspension Stabilizer Bar Link - Rear
SSP2370	301191623700	MERCEDES CLS63 AMG (C219) RWD 10/2004-12/2010	Suspension Stabilizer Bar Link - Rear
SSP2370	301191623700	MERCEDES E280 (W211) 03/2003-07/2009	Suspension Stabilizer Bar Link - Rear
SSP2370	301191623700	MERCEDES E300 (W211) 03/2003-07/2009	Suspension Stabilizer Bar Link - Rear
SSP2370	301191623700	MERCEDES E320 (W211) 03/2003-07/2009	Suspension Stabilizer Bar Link - Rear
SSP2370	301191623700	MERCEDES E350 (W211) 03/2003-07/2009	Suspension Stabilizer Bar Link - Rear
SSP2370	301191623700	MERCEDES E500 (W211) 03/2003-07/2009	Suspension Stabilizer Bar Link - Rear
SSP2370	301191623700	MERCEDES E55 AMG (W211) 03/2003-07/2009	Suspension Stabilizer Bar Link - Rear
SSP2370	301191623700	MERCEDES E550 (W211) 03/2003-07/2009	Suspension Stabilizer Bar Link - Rear
SSP2370	301191623700	MERCEDES E63 AMG (W211) 03/2003-07/2009	Suspension Stabilizer Bar Link - Rear
SSP2370	301191623700	MERCEDES SL500 (R230) 10/2001-01/2012	Suspension Stabilizer Bar Link - Rear
SSP2370	301191623700	MERCEDES SL55 AMG (R230) 10/2001-01/2012	Suspension Stabilizer Bar Link - Rear
SSP2370	301191623700	MERCEDES SL550 (R230) 10/2001-01/2012	Suspension Stabilizer Bar Link - Rear
SSP2370	301191623700	MERCEDES SL600 (R230) 10/2001-01/2012	Suspension Stabilizer Bar Link - Rear
SSP2370	301191623700	MERCEDES SL63 AMG (R230) 10/2001-01/2012	Suspension Stabilizer Bar Link - Rear
SSP2370	301191623700	MERCEDES SL65 AMG (R230) 10/2001-01/2012	Suspension Stabilizer Bar Link - Rear





 SHORT LONG			DESCRIPTION
SSP2371	301191623710	MERCEDES CL200 C215 03/1999-03/2006	Suspension Stabilizer Bar Link - Front Right
SSP2371	301191623710	MERCEDES CL230 C215 03/1999-03/2006	Suspension Stabilizer Bar Link - Front Right
SSP2371	301191623710	MERCEDES CL500 C215 03/1999-03/2006	Suspension Stabilizer Bar Link - Front Right
SSP2371	301191623710	MERCEDES CL55 AMG C215 03/1999-03/2006	Suspension Stabilizer Bar Link - Front Right
SSP2371	301191623710	MERCEDES CL600 C215 03/1999-03/2006	Suspension Stabilizer Bar Link - Front Right
SSP2371	301191623710	MERCEDES CL65 AMG C215 03/1999-03/2006	Suspension Stabilizer Bar Link - Front Right
SSP2371	301191623710	MERCEDES S320 (W220) 1999-2005	Suspension Stabilizer Bar Link - Front Right
SSP2371	301191623710	MERCEDES S350 (W220) 1999-2005	Suspension Stabilizer Bar Link - Front Right
SSP2371	301191623710	MERCEDES S420 (W220) 1999-2005	Suspension Stabilizer Bar Link - Front Right
SSP2371	301191623710	MERCEDES S430 (W220) 1999-2005	Suspension Stabilizer Bar Link - Front Right
SSP2371	301191623710	MERCEDES S500 (W220) 1999-2005	Suspension Stabilizer Bar Link - Front Right
SSP2371	301191623710	MERCEDES S55 AMG (W220) 1999-2005	Suspension Stabilizer Bar Link - Front Right
SSP2371	301191623710	MERCEDES S600 (W220) 1999-2005	Suspension Stabilizer Bar Link - Front Right
SSP2371	301191623710	MERCEDES S65 AMG (W220) 1999-2005	Suspension Stabilizer Bar Link - Front Right
SSP2372	301191623720	MERCEDES CL200 C215 03/1999-03/2006	Suspension Stabilizer Bar Link - Front Left
SSP2372	301191623720	MERCEDES CL230 C215 03/1999-03/2006	Suspension Stabilizer Bar Link - Front Left
SSP2372	301191623720	MERCEDES CL500 C215 03/1999-03/2006	Suspension Stabilizer Bar Link - Front Left
SSP2372	301191623720	MERCEDES CL55 AMG C215 03/1999-03/2006	Suspension Stabilizer Bar Link - Front Left
SSP2372	301191623720	MERCEDES CL600 C215 03/1999-03/2006	Suspension Stabilizer Bar Link - Front Left
SSP2372	301191623720	MERCEDES CL65 AMG C215 03/1999-03/2006	Suspension Stabilizer Bar Link - Front Left
SSP2372	301191623720	MERCEDES S320 (W220) 1999-2005	Suspension Stabilizer Bar Link - Front Left
SSP2372	301191623720	MERCEDES S350 (W220) 1999-2005	Suspension Stabilizer Bar Link - Front Left
SSP2372	301191623720	MERCEDES S420 (W220) 1999-2005	Suspension Stabilizer Bar Link - Front Left
SSP2372	301191623720	MERCEDES S430 (W220) 1999-2005	Suspension Stabilizer Bar Link - Front Left
SSP2372	301191623720	MERCEDES S500 (W220) 1999-2005	Suspension Stabilizer Bar Link - Front Left
SSP2372	301191623720	MERCEDES S55 AMG (W220) 1999-2005	Suspension Stabilizer Bar Link - Front Left
SSP2372	301191623720	MERCEDES S600 (W220) 1999-2005	Suspension Stabilizer Bar Link - Front Left
SSP2372	301191623720	MERCEDES S65 AMG (W220) 1999-2005	Suspension Stabilizer Bar Link - Front Left
SSP2373	301191623730	MERCEDES CLS350 (C219) RWD 10/2004-12/2010	Suspension Stabilizer Bar Link - Front Right
SSP2373	301191623730	MERCEDES CLS500 (C219) RWD 10/2004-12/2010	Suspension Stabilizer Bar Link - Front Right
SSP2373	301191623730	MERCEDES CLS55 AMG (C219) RWD 10/2004-12/2010	Suspension Stabilizer Bar Link - Front Right
SSP2373	301191623730	MERCEDES CLS550 (C219) RWD 10/2004-12/2010	Suspension Stabilizer Bar Link - Front Right
SSP2373	301191623730	MERCEDES CLS63 AMG (C219) RWD 10/2004-12/2010	Suspension Stabilizer Bar Link - Front Right
SSP2373	301191623730	MERCEDES E280 (W211) 03/2003-07/2009	Suspension Stabilizer Bar Link - Front Right
SSP2373	301191623730	MERCEDES E300 (W211) 03/2003-07/2009	Suspension Stabilizer Bar Link - Front Right



			DESCRIPTION
SHORT	LONG		
SSP2373	301191623730	MERCEDES E320 (W211) 03/2003-07/2009	Suspension Stabilizer Bar Link - Front Right
SSP2373	301191623730	MERCEDES E350 (W211) 03/2003-07/2009	Suspension Stabilizer Bar Link - Front Right
SSP2373	301191623730	MERCEDES E500 (W211) 03/2003-07/2009	Suspension Stabilizer Bar Link - Front Right
SSP2373	301191623730	MERCEDES E55 AMG (W211) 03/2003-07/2009	Suspension Stabilizer Bar Link - Front Right
SSP2373	301191623730	MERCEDES E550 (W211) 03/2003-07/2009	Suspension Stabilizer Bar Link - Front Right
SSP2373	301191623730	MERCEDES E63 AMG (W211) 03/2003-07/2009	Suspension Stabilizer Bar Link - Front Right
SSP2374	301191623740	MERCEDES CLS350 (C219) RWD 10/2004-12/2010	Suspension Stabilizer Bar Link - Front Left
SSP2374	301191623740	MERCEDES CLS500 (C219) RWD 10/2004-12/2010	Suspension Stabilizer Bar Link - Front Left
SSP2374	301191623740	MERCEDES CLS55 AMG (C219) RWD 10/2004-12/2010	Suspension Stabilizer Bar Link - Front Left
SSP2374	301191623740	MERCEDES CLS550 (C219) RWD 10/2004-12/2010	Suspension Stabilizer Bar Link - Front Left
SSP2374	301191623740	MERCEDES CLS63 AMG (C219) RWD 10/2004-12/2010	Suspension Stabilizer Bar Link - Front Left
SSP2374	301191623740	MERCEDES E280 (W211) 03/2003-07/2009	Suspension Stabilizer Bar Link - Front Left
SSP2374	301191623740	MERCEDES E300 (W211) 03/2003-07/2009	Suspension Stabilizer Bar Link - Front Left
SSP2374	301191623740	MERCEDES E320 (W211) 03/2003-07/2009	Suspension Stabilizer Bar Link - Front Left
SSP2374	301191623740	MERCEDES E350 (W211) 03/2003-07/2009	Suspension Stabilizer Bar Link - Front Left
SSP2374	301191623740	MERCEDES E500 (W211) 03/2003-07/2009	Suspension Stabilizer Bar Link - Front Left
SSP2374	301191623740	MERCEDES E55 AMG (W211) 03/2003-07/2009	Suspension Stabilizer Bar Link - Front Left
SSP2374	301191623740	MERCEDES E550 (W211) 03/2003-07/2009	Suspension Stabilizer Bar Link - Front Left
SSP2374	301191623740	MERCEDES E63 AMG (W211) 03/2003-07/2009	Suspension Stabilizer Bar Link - Front Left
SSP2375	301191623750	MERCEDES S350 (W221) 10/2005-04/2013	Suspension Stabilizer Bar Link - Front Right
SSP2375	301191623750	MERCEDES S400 (W221) 10/2005-04/2013	Suspension Stabilizer Bar Link - Front Right
SSP2375	301191623750	MERCEDES S430 (W221) 10/2005-04/2013	Suspension Stabilizer Bar Link - Front Right
SSP2375	301191623750	MERCEDES S450 (W221) 10/2005-04/2013	Suspension Stabilizer Bar Link - Front Right
SSP2375	301191623750	MERCEDES S500 (W221) 10/2005-04/2013	Suspension Stabilizer Bar Link - Front Right
SSP2375	301191623750	MERCEDES S550 (W221) 10/2005-04/2013	Suspension Stabilizer Bar Link - Front Right
SSP2375	301191623750	MERCEDES S600 (W221) 10/2005-04/2013	Suspension Stabilizer Bar Link - Front Right
SSP2375	301191623750	MERCEDES S63 AMG (W221) 10/2005-04/2013	Suspension Stabilizer Bar Link - Front Right
SSP2375	301191623750	MERCEDES S65 AMG (W221) 10/2005-04/2013	Suspension Stabilizer Bar Link - Front Right
SSP2376	301191623760	MERCEDES S350 (W221) 10/2005-04/2013	Suspension Stabilizer Bar Link - Front Left
SSP2376	301191623760	MERCEDES S400 (W221) 10/2005-04/2013	Suspension Stabilizer Bar Link - Front Left
SSP2376	301191623760	MERCEDES S430 (W221) 10/2005-04/2013	Suspension Stabilizer Bar Link - Front Left
SSP2376	301191623760	MERCEDES S450 (W221) 10/2005-04/2013	Suspension Stabilizer Bar Link - Front Left
SSP2376	301191623760	MERCEDES S500 (W221) 10/2005-04/2013	Suspension Stabilizer Bar Link - Front Left
SSP2376	301191623760	MERCEDES S550 (W221) 10/2005-04/2013	Suspension Stabilizer Bar Link - Front Left





 SHORT LONG			DESCRIPTION
SSP2376	301191623760	MERCEDES S600 (W221) 10/2005-04/2013	Suspension Stabilizer Bar Link - Front Left
SSP2376	301191623760	MERCEDES S63 AMG (W221) 10/2005-04/2013	Suspension Stabilizer Bar Link - Front Left
SSP2376	301191623760	MERCEDES S65 AMG (W221) 10/2005-04/2013	Suspension Stabilizer Bar Link - Front Left
SSP2377	301191623770	MERCEDES S350 (W221) 10/2005-04/2013	Suspension Stabilizer Bar Link - Rear Right
SSP2377	301191623770	MERCEDES S350 (W221) AWD 10/2005-04/2013	Suspension Stabilizer Bar Link - Rear Right
SSP2377	301191623770	MERCEDES S400 (W221) 10/2005-04/2013	Suspension Stabilizer Bar Link - Rear Right
SSP2377	301191623770	MERCEDES S430 (W221) 10/2005-04/2013	Suspension Stabilizer Bar Link - Rear Right
SSP2377	301191623770	MERCEDES S450 (W221) 10/2005-04/2013	Suspension Stabilizer Bar Link - Rear Right
SSP2377	301191623770	MERCEDES S450 (W221) AWD 10/2005-04/2013	Suspension Stabilizer Bar Link - Rear Right
SSP2377	301191623770	MERCEDES S500 (W221) 10/2005-04/2013	Suspension Stabilizer Bar Link - Rear Right
SSP2377	301191623770	MERCEDES S500 (W221) AWD 10/2005-04/2013	Suspension Stabilizer Bar Link - Rear Right
SSP2377	301191623770	MERCEDES S550 (W221) 10/2005-04/2013	Suspension Stabilizer Bar Link - Rear Right
SSP2377	301191623770	MERCEDES S550 (W221) AWD 10/2005-04/2013	Suspension Stabilizer Bar Link - Rear Right
SSP2377	301191623770	MERCEDES S600 (W221) 10/2005-04/2013	Suspension Stabilizer Bar Link - Rear Right
SSP2377	301191623770	MERCEDES S63 AMG (W221) 10/2005-04/2013	Suspension Stabilizer Bar Link - Rear Right
SSP2377	301191623770	MERCEDES S65 AMG (W221) 10/2005-04/2013	Suspension Stabilizer Bar Link - Rear Right
SSP2378	301191623780	MERCEDES S350 (W221) 10/2005-04/2013	Suspension Stabilizer Bar Link - Rear Left
SSP2378	301191623780	MERCEDES S350 (W221) AWD 10/2005-04/2013	Suspension Stabilizer Bar Link - Rear Left
SSP2378	301191623780	MERCEDES S400 (W221) 10/2005-04/2013	Suspension Stabilizer Bar Link - Rear Left
SSP2378	301191623780	MERCEDES S430 (W221) 10/2005-04/2013	Suspension Stabilizer Bar Link - Rear Left
SSP2378	301191623780	MERCEDES S450 (W221) 10/2005-04/2013	Suspension Stabilizer Bar Link - Rear Left
SSP2378	301191623780	MERCEDES S450 (W221) AWD 10/2005-04/2013	Suspension Stabilizer Bar Link - Rear Left
SSP2378	301191623780	MERCEDES S500 (W221) 10/2005-04/2013	Suspension Stabilizer Bar Link - Rear Left
SSP2378	301191623780	MERCEDES S500 (W221) AWD 10/2005-04/2013	Suspension Stabilizer Bar Link - Rear Left
SSP2378	301191623780	MERCEDES S550 (W221) 10/2005-04/2013	Suspension Stabilizer Bar Link - Rear Left
SSP2378	301191623780	MERCEDES S550 (W221) AWD 10/2005-04/2013	Suspension Stabilizer Bar Link - Rear Left
SSP2378	301191623780	MERCEDES S600 (W221) 10/2005-04/2013	Suspension Stabilizer Bar Link - Rear Left
SSP2378	301191623780	MERCEDES S63 AMG (W221) 10/2005-04/2013	Suspension Stabilizer Bar Link - Rear Left
SSP2378	301191623780	MERCEDES S65 AMG (W221) 10/2005-04/2013	Suspension Stabilizer Bar Link - Rear Left
SSP2379	301191623790	MERCEDES S350 (W221) AWD 10/2005-04/2013	Suspension Stabilizer Bar Link - Front Right
SSP2379	301191623790	MERCEDES S450 (W221) AWD 10/2005-04/2013	Suspension Stabilizer Bar Link - Front Right





			DESCRIPTION
SHORT	LONG		
SSP2379	301191623790	MERCEDES S500 (W221) AWD 10/2005-04/2013	Suspension Stabilizer Bar Link - Front Right
SSP2379	301191623790	MERCEDES S550 (W221) AWD 10/2005-04/2013	Suspension Stabilizer Bar Link - Front Right
SSP2380	301191623800	MERCEDES S350 (W221) AWD 10/2005-04/2013	Suspension Stabilizer Bar Link - Front Left
SSP2380	301191623800	MERCEDES S450 (W221) AWD 10/2005-04/2013	Suspension Stabilizer Bar Link - Front Left
SSP2380	301191623800	MERCEDES S500 (W221) AWD 10/2005-04/2013	Suspension Stabilizer Bar Link - Front Left
SSP2380	301191623800	MERCEDES S550 (W221) AWD 10/2005-04/2013	Suspension Stabilizer Bar Link - Front Left
SSP2381	301191623810	MERCEDES E280 (W211) 03/2003-07/2009	Suspension Stabilizer Bar Link - Front Right
SSP2381	301191623810	MERCEDES E300 (W211) 03/2003-07/2009	Suspension Stabilizer Bar Link - Front Right
SSP2381	301191623810	MERCEDES E320 (W211) 03/2003-07/2009	Suspension Stabilizer Bar Link - Front Right
SSP2381	301191623810	MERCEDES E350 (W211) 03/2003-07/2009	Suspension Stabilizer Bar Link - Front Right
SSP2381	301191623810	MERCEDES E500 (W211) 03/2003-07/2009	Suspension Stabilizer Bar Link - Front Right
SSP2381	301191623810	MERCEDES E55 AMG (W211) 03/2003-07/2009	Suspension Stabilizer Bar Link - Front Right
SSP2381	301191623810	MERCEDES E550 (W211) 03/2003-07/2009	Suspension Stabilizer Bar Link - Front Right
SSP2381	301191623810	MERCEDES E63 AMG (W211) 03/2003-07/2009	Suspension Stabilizer Bar Link - Front Right
SSP2382	301191623820	MERCEDES E280 (W211) 03/2003-07/2009	Suspension Stabilizer Bar Link - Front Left
SSP2382	301191623820	MERCEDES E300 (W211) 03/2003-07/2009	Suspension Stabilizer Bar Link - Front Left
SSP2382	301191623820	MERCEDES E320 (W211) 03/2003-07/2009	Suspension Stabilizer Bar Link - Front Left
SSP2382	301191623820	MERCEDES E350 (W211) 03/2003-07/2009	Suspension Stabilizer Bar Link - Front Left
SSP2382	301191623820	MERCEDES E500 (W211) 03/2003-07/2009	Suspension Stabilizer Bar Link - Front Left
SSP2382	301191623820	MERCEDES E55 AMG (W211) 03/2003-07/2009	Suspension Stabilizer Bar Link - Front Left
SSP2382	301191623820	MERCEDES E550 (W211) 03/2003-07/2009	Suspension Stabilizer Bar Link - Front Left
SSP2382	301191623820	MERCEDES E63 AMG (W211) 03/2003-07/2009	Suspension Stabilizer Bar Link - Front Left
SSP2383	301191623830	MERCEDES S400 (W222,V222,X222) 2014-	Suspension Stabilizer Bar Link - Front Right
SSP2383	301191623830	MERCEDES S400L (W222,V222,X222) 2014-	Suspension Stabilizer Bar Link - Front Right
SSP2383	301191623830	MERCEDES S500 (W222,V222,X222) 2014-	Suspension Stabilizer Bar Link - Front Right
SSP2383	301191623830	MERCEDES S550 (W222,V222,X222) 2014-	Suspension Stabilizer Bar Link - Front Right
SSP2383	301191623830	MERCEDES S550e (W222,V222,X222) 2014-	Suspension Stabilizer Bar Link - Front Right
SSP2383	301191623830	MERCEDES S600 (W222,V222,X222) 2014-	Suspension Stabilizer Bar Link - Front Right
SSP2383	301191623830	MERCEDES S600L (W222,V222,X222) 2014-	Suspension Stabilizer Bar Link - Front Right
SSP2383	301191623830	MERCEDES S63 AMG (W222,V222,X222) 2014-	Suspension Stabilizer Bar Link - Front Right
SSP2383	301191623830	MERCEDES S63L AMG (W222,V222,X222) 2014-	Suspension Stabilizer Bar Link - Front Right
SSP2383	301191623830	MERCEDES S65 AMG (W222,V222,X222) 2014-	Suspension Stabilizer Bar Link - Front Right





			DESCRIPTION
SHORT	LONG		
SSP2383	301191623830	MERCEDES S65L AMG (W222,V222,X222) 2014-	Suspension Stabilizer Bar Link - Front Right
SSP2384	301191623840	MERCEDES S400 (W222,V222,X222) 2014-	Suspension Stabilizer Bar Link - Front Left
SSP2384	301191623840	MERCEDES S400L (W222,V222,X222) 2014-	Suspension Stabilizer Bar Link - Front Left
SSP2384	301191623840	MERCEDES S500 (W222,V222,X222) 2014-	Suspension Stabilizer Bar Link - Front Left
SSP2384	301191623840	MERCEDES S550 (W222,V222,X222) 2014-	Suspension Stabilizer Bar Link - Front Left
SSP2384	301191623840	MERCEDES S550e (W222,V222,X222) 2014-	Suspension Stabilizer Bar Link - Front Left
SSP2384	301191623840	MERCEDES S600 (W222,V222,X222) 2014-	Suspension Stabilizer Bar Link - Front Left
SSP2384	301191623840	MERCEDES S600L (W222,V222,X222) 2014-	Suspension Stabilizer Bar Link - Front Left
SSP2384	301191623840	MERCEDES S63 AMG (W222,V222,X222) 2014-	Suspension Stabilizer Bar Link - Front Left
SSP2384	301191623840	MERCEDES S63L AMG (W222,V222,X222) 2014-	Suspension Stabilizer Bar Link - Front Left
SSP2384	301191623840	MERCEDES S65 AMG (W222,V222,X222) 2014-	Suspension Stabilizer Bar Link - Front Left
SSP2384	301191623840	MERCEDES S65L AMG (W222,V222,X222) 2014-	Suspension Stabilizer Bar Link - Front Left
SSP2385	301191623850	MERCEDES S500 (W222,V222,X222) AWD 2014-	Suspension Stabilizer Bar Link - Rear Right
SSP2385	301191623850	MERCEDES S550 (W222,V222,X222) AWD 2014-	Suspension Stabilizer Bar Link - Rear Right
SSP2385	301191623850	MERCEDES S63 AMG (W222,V222,X222) AWD 2014-	Suspension Stabilizer Bar Link - Rear Right
SSP2385	301191623850	MERCEDES S63L AMG (W222,V222,X222) AWD 2014-	Suspension Stabilizer Bar Link - Rear Right
SSP2386	301191623860	MERCEDES S500 (W222,V222,X222) AWD 2014-	Suspension Stabilizer Bar Link - Rear Left
SSP2386	301191623860	MERCEDES S550 (W222,V222,X222) AWD 2014-	Suspension Stabilizer Bar Link - Rear Left
SSP2386	301191623860	MERCEDES S63 AMG (W222,V222,X222) AWD 2014-	Suspension Stabilizer Bar Link - Rear Left
SSP2386	301191623860	MERCEDES S63L AMG (W222,V222,X222) AWD 2014-	Suspension Stabilizer Bar Link - Rear Left
SSP2387	301191623870	MERCEDES S400 (W222,V222,X222) 2014-	Suspension Stabilizer Bar Link - Front Right
SSP2388	301191623880	MERCEDES S400 (W222,V222,X222) 2014-	Suspension Stabilizer Bar Link - Front Left
SSP2389	301191623890	MAZDA MX-5 III (NC) 11/2005-	Suspension Stabilizer Bar Link - Rear
SSP2389	301191623890	MAZDA RX-8 2003-2011	Suspension Stabilizer Bar Link - Rear
SSP2390	301191623900	MAZDA CX-7 ER 2007-	Suspension Stabilizer Bar Link - Rear Left
SSP2390	301191623900	MAZDA RX-8 2003-2011	Suspension Stabilizer Bar Link - Front Right
SSP2391	301191623910	MAZDA CX-7 ER 2007-	Suspension Stabilizer Bar Link - Rear Right
SSP2391	301191623910	MAZDA RX-8 2003-2011	Suspension Stabilizer Bar Link - Front Left
SSP2392	301191623920	MAZDA 3 BK 10/2003-06/2009	Suspension Stabilizer Bar Link - Front
SSP2392	301191623920	MAZDA 5 CR19, 2nd Gen 03/2005-08/2010	Suspension Stabilizer Bar Link - Front
SSP2393	301191623930	MAZDA 3 BL 07/2009-11/2014	Suspension Stabilizer Bar Link - Front
SSP2394	301191623940	MAZDA 3 BM 12/2014-	Suspension Stabilizer Bar Link - Front Right
SSP2395	301191623950	MAZDA 3 BM 12/2014-	Suspension Stabilizer Bar Link - Front Left



 SHORT LONG			DESCRIPTION
SSP2396	301191623960	MAZDA 3 BM 12/2014-	Suspension Stabilizer Bar Link - Rear Right
SSP2396	301191623960	MAZDA 6 GJ 2013-	Suspension Stabilizer Bar Link - Rear Right
SSP2397	301191623970	MAZDA 3 BM 12/2014-	Suspension Stabilizer Bar Link - Rear Left
SSP2397	301191623970	MAZDA 6 GJ 2013-	Suspension Stabilizer Bar Link - Rear Left
SSP2398	301191623980	MAZDA CX-7 ER 2007-	Suspension Stabilizer Bar Link - Front Right
SSP2399	301191623990	MAZDA CX-7 ER 2007-	Suspension Stabilizer Bar Link - Front Left
SSP2400	301191624000	MAZDA 6 GG 06/2002-07/2007	Suspension Stabilizer Bar Link - Front Right
SSP2401	301191624010	MAZDA 6 GG 06/2002-07/2007	Suspension Stabilizer Bar Link - Front Left
SSP2402	301191624020	FORD FUSION 1st Gen USA made 2006-2012	Suspension Stabilizer Bar Link - Rear
SSP2402	301191624020	LINCOLN MKZ 1st Gen 2006-2012	Suspension Stabilizer Bar Link - Rear
SSP2402	301191624020	MAZDA 6 GG 06/2002-07/2007	Suspension Stabilizer Bar Link - Rear
SSP2402	301191624020	MERCURY MILAN 2006-2011	Suspension Stabilizer Bar Link - Rear
SSP2403	301191624030	MAZDA 6 GH 08/2007-12/2012	Suspension Stabilizer Bar Link - Rear
SSP2404	301191624040	MAZDA 6 GH 08/2007-12/2012	Suspension Stabilizer Bar Link - Front Right
SSP2405	301191624050	MAZDA 6 GH 08/2007-12/2012	Suspension Stabilizer Bar Link - Front Left
SSP2406	301191624060	MAZDA 6 GJ 2013-	Suspension Stabilizer Bar Link - Front
SSP2406	301191624060	MAZDA CX-5 KE 11/2011-	Suspension Stabilizer Bar Link - Front
SSP2407	301191624070	MAZDA CX-9 2007-	Suspension Stabilizer Bar Link - Rear
SSP2408	301191624080	MAZDA CX-9 2007-	Suspension Stabilizer Bar Link - Front Right
SSP2409	301191624090	MAZDA CX-9 2007-	Suspension Stabilizer Bar Link - Front Left
SSP2410	301191624100	MAZDA 2 DJ 2014-	Suspension Stabilizer Bar Link - Front
SSP2410	301191624100	MAZDA CX-3 1st Gen 2015-	Suspension Stabilizer Bar Link - Front
SSP2411	301191624110	MINI L200 (KB_T,KA_T) 11/2005-	Suspension Stabilizer Bar Link - Front Right
SSP2412	301191624120	MINI L200 (KB_T,KA_T) 11/2005-	Suspension Stabilizer Bar Link - Front Left
SSP2413	301191624130	MINI L300 1986-02/2006	Suspension Stabilizer Bar Link - Front
SSP2414	301191624140	MINI COLT III 04/1988-05/1992	Suspension Stabilizer Bar Link - Front
SSP2414	301191624140	MINI GALANT V 1992-1996	Suspension Stabilizer Bar Link - Front
SSP2414	301191624140	MINI LANCER III 1982-1987	Suspension Stabilizer Bar Link - Front
SSP2414	301191624140	MINI MIRAGE 3rd Gen 1988-1992	Suspension Stabilizer Bar Link - Front
SSP2414	301191624140	MINI PAJERO PININ 09/1999-06/2007	Suspension Stabilizer Bar Link - Front
SSP2415	301191624150	MINI Expo 05/1991-12/2004	Suspension Stabilizer Bar Link - Front Right
SSP2416	301191624160	MINI Expo 05/1991-12/2004	Suspension Stabilizer Bar Link - Front Left
SSP2417	301191624170	MINI Space Star 2012-	Suspension Stabilizer Bar Link - Front
SSP2418	301191624180	MINI LANCER (CS, A) 09/2003-07/2008	Suspension Stabilizer Bar Link - Front
SSP2419	301191624190	MINI LANCER (CS, A) 09/2003-07/2008	Suspension Stabilizer Bar Link - Rear
SSP2420	301191624200	CHRYSLER SEBRING JS 3rd Gen 07/2007-12/2010	Suspension Stabilizer Bar Link - Front
SSP2420	301191624200	DAEWOO LEGANZA 1997-2004	Suspension Stabilizer Bar Link - Front
SSP2420	301191624200	DODGE AVENGER 1st Gen 2011-2014	Suspension Stabilizer Bar Link - Front
SSP2420	301191624200	MAZDA Protege 2001-2003	Suspension Stabilizer Bar Link - Front





 SHORT LONG			DESCRIPTION
SSP2420	301191624200	mitsubishi asx (GA,W) 02/2010-	Suspension Stabilizer Bar Link - Front
SSP2420	301191624200	mitsubishi lancer (CY2A-CZ4A) 06/2008-	Suspension Stabilizer Bar Link - Front
SSP2420	301191624200	mitsubishi outlander II 11/2006-07/2012	Suspension Stabilizer Bar Link - Front
SSP2420	301191624200	mitsubishi outlander III 2012-	Suspension Stabilizer Bar Link - Front
SSP2420	301191624200	mitsubishi Outlander Sport (GA,W) 02/2010-	Suspension Stabilizer Bar Link - Front
SSP2420	301191624200	PEUGEOT 4007 02/2007-	Suspension Stabilizer Bar Link - Front
SSP2421	301191624210	mitsubishi asx (GA,W) 02/2010-	Suspension Stabilizer Bar Link - Rear Right
SSP2421	301191624210	mitsubishi outlander II 11/2006-07/2012	Suspension Stabilizer Bar Link - Rear Right
SSP2421	301191624210	mitsubishi outlander III 2012-	Suspension Stabilizer Bar Link - Rear Right
SSP2421	301191624210	mitsubishi Outlander Sport (GA,W) 02/2010-	Suspension Stabilizer Bar Link - Rear Right
SSP2421	301191624210	PEUGEOT 4007 02/2007-	Suspension Stabilizer Bar Link - Rear Right
SSP2422	301191624220	mitsubishi asx (GA,W) 02/2010-	Suspension Stabilizer Bar Link - Rear Left
SSP2422	301191624220	mitsubishi outlander II 11/2006-07/2012	Suspension Stabilizer Bar Link - Rear Left
SSP2422	301191624220	mitsubishi outlander III 2012-	Suspension Stabilizer Bar Link - Rear Left
SSP2422	301191624220	mitsubishi Outlander Sport (GA,W) 02/2010-	Suspension Stabilizer Bar Link - Rear Left
SSP2422	301191624220	PEUGEOT 4007 02/2007-	Suspension Stabilizer Bar Link - Rear Left
SSP2423	301191624230	mitsubishi montero III 04/2000-01/2007	Suspension Stabilizer Bar Link - Front Right
SSP2423	301191624230	mitsubishi pajero III 04/2000-01/2007	Suspension Stabilizer Bar Link - Front Right
SSP2424	301191624240	mitsubishi montero III 04/2000-01/2007	Suspension Stabilizer Bar Link - Front Left
SSP2424	301191624240	mitsubishi pajero III 04/2000-01/2007	Suspension Stabilizer Bar Link - Front Left
SSP2425	301191624250	mitsubishi montero III 04/2000-01/2007	Suspension Stabilizer Bar Link - Rear Right
SSP2425	301191624250	mitsubishi pajero III 04/2000-01/2007	Suspension Stabilizer Bar Link - Rear Right
SSP2426	301191624260	mitsubishi montero III 04/2000-01/2007	Suspension Stabilizer Bar Link - Rear Left
SSP2426	301191624260	mitsubishi pajero III 04/2000-01/2007	Suspension Stabilizer Bar Link - Rear Left
SSP2427	301191624270	mitsubishi montero IV 02/2007-	Suspension Stabilizer Bar Link - Front Right
SSP2427	301191624270	mitsubishi pajero IV 02/2007-	Suspension Stabilizer Bar Link - Front Right
SSP2428	301191624280	mitsubishi montero IV 02/2007-	Suspension Stabilizer Bar Link - Front Left
SSP2428	301191624280	mitsubishi pajero IV 02/2007-	Suspension Stabilizer Bar Link - Front Left
SSP2429	301191624290	mitsubishi montero IV 02/2007-	Suspension Stabilizer Bar Link - Rear Right
SSP2429	301191624290	mitsubishi pajero IV 02/2007-	Suspension Stabilizer Bar Link - Rear Right
SSP2430	301191624300	mitsubishi montero IV 02/2007-	Suspension Stabilizer Bar Link - Rear Left
SSP2430	301191624300	mitsubishi pajero IV 02/2007-	Suspension Stabilizer Bar Link - Rear Left
SSP2431	301191624310	mitsubishi carisma 09/2000-06/2006	Suspension Stabilizer Bar Link - Front
SSP2432	301191624320	MINI Cooper (R50, R53) 05/2001-09/2006	Suspension Stabilizer Bar Link - Rear
SSP2432	301191624320	MINI Cooper (R52) 07/2004-11/2007	Suspension Stabilizer Bar Link - Rear
SSP2433	301191624330	MINI Cooper (R50, R53) 05/2001-09/2006	Suspension Stabilizer Bar Link - Front
SSP2434	301191624340	MINI Cooper (R50, R53) 05/2001-09/2006	Suspension Stabilizer Bar Link - Front
SSP2434	301191624340	MINI Cooper (R52) 07/2004-11/2007	Suspension Stabilizer Bar Link - Front
SSP2435	301191624350	MINI Cooper (R50, R53) 05/2001-09/2006	Suspension Stabilizer Bar Link - Front
SSP2435	301191624350	MINI Cooper (R52) 07/2004-11/2007	Suspension Stabilizer Bar Link - Front
SSP2436	301191624360	MINI Cooper (R55, R56) 09/2006-05/2010	Suspension Stabilizer Bar Link - Rear



			DESCRIPTION
SHORT	LONG		
SSP2436	301191624360	MINI Cooper Countryman (R60) 06/2010-12/2014	Suspension Stabilizer Bar Link - Rear
SSP2437	301191624370	MINI Cooper (R55, R56) 09/2006-05/2010	Suspension Stabilizer Bar Link - Front
SSP2438	301191624380	MINI Cooper Countryman (R60) 06/2010-12/2014	Suspension Stabilizer Bar Link - Front Right
SSP2439	301191624390	MINI Cooper Countryman (R60) 06/2010-12/2014	Suspension Stabilizer Bar Link - Front Left
SSP2440	301191624400	MINI Cooper Countryman (R60) 06/2010-12/2014	Suspension Stabilizer Bar Link - Rear Right
SSP2441	301191624410	MINI Cooper Countryman (R60) 06/2010-12/2014	Suspension Stabilizer Bar Link - Rear Left
SSP2442	301191624420	MINI Cooper (F55,F56) 07/2014-	Suspension Stabilizer Bar Link - Front
SSP2443	301191624430	BMW 218i Active Tourer F45,F46 09/2014-	Suspension Stabilizer Bar Link - Rear
SSP2443	301191624430	BMW 220i Active Tourer F45,F46 09/2014-	Suspension Stabilizer Bar Link - Rear
SSP2443	301191624430	BMW X1 F48 2015-	Suspension Stabilizer Bar Link - Rear
SSP2443	301191624430	MINI Cooper (F55,F56) 07/2014-	Suspension Stabilizer Bar Link - Rear
SSP2444	301191624440	NISSAN ALMERA (N15) 07/1995-06/2000	Suspension Stabilizer Bar Link - Front
SSP2444	301191624440	NISSAN SENTRA (B12-N13) 1985-1990	Suspension Stabilizer Bar Link - Front
SSP2444	301191624440	NISSAN SUNNY (B12-N13) 1985-1990	Suspension Stabilizer Bar Link - Front
SSP2445	301191624450	NISSAN PRIMERA (P10-W10-W11) 06/1990-06/1996	Suspension Stabilizer Bar Link - Rear
SSP2445	301191624450	NISSAN PRIMERA (P11) 06/1996-12/2001	Suspension Stabilizer Bar Link - Rear
SSP2446	301191624460	INFINITI G20 1st Gen, P10 1990-1996	Suspension Stabilizer Bar Link - Front
SSP2446	301191624460	NISSAN PRIMERA (P10-W10-W11) 06/1990-06/1996	Suspension Stabilizer Bar Link - Front
SSP2446	301191624460	NISSAN PRIMERA (P11) 06/1996-12/2001	Suspension Stabilizer Bar Link - Front
SSP2447	301191624470	NISSAN PRIMERA (P12) 01/2002-05/2008	Suspension Stabilizer Bar Link - Front Right
SSP2448	301191624480	NISSAN PRIMERA (P12) 01/2002-05/2008	Suspension Stabilizer Bar Link - Front Left
SSP2449	301191624490	NISSAN MICRA (K10) 12/1982-07/1992	Suspension Stabilizer Bar Link - Rear
SSP2449	301191624490	NISSAN MICRA (K11) 08/1992-01/2003	Suspension Stabilizer Bar Link - Rear
SSP2450	301191624500	NISSAN NOTE (E11) 03/2006-05/2013	Suspension Stabilizer Bar Link - Front
SSP2450	301191624500	NISSAN TIIDA (C11) 07/2004-08/2012	Suspension Stabilizer Bar Link - Front
SSP2450	301191624500	NISSAN VERSA 2004-2012	Suspension Stabilizer Bar Link - Front
SSP2451	301191624510	NISSAN MICRA (K12) 02/2003-05/2010	Suspension Stabilizer Bar Link - Front
SSP2451	301191624510	RENAULT CAPTUR 03/2013-	Suspension Stabilizer Bar Link - Front
SSP2451	301191624510	RENAULT CLIO III-HB 06/2005-09/2012	Suspension Stabilizer Bar Link - Front
SSP2451	301191624510	RENAULT MODUS 12/2004-07/2014	Suspension Stabilizer Bar Link - Front
SSP2452	301191624520	NISSAN MARCH (K13) 06/2010-	Suspension Stabilizer Bar Link - Front
SSP2452	301191624520	NISSAN MICRA (K13) 06/2010-	Suspension Stabilizer Bar Link - Front
SSP2452	301191624520	NISSAN VERSA NOTE (E12) 06/2013-	Suspension Stabilizer Bar Link - Front
SSP2453	301191624530	NISSAN MURANO (Z50) 03/2003-10/2007	Suspension Stabilizer Bar Link - Front Right
SSP2454	301191624540	NISSAN MURANO (Z50) 03/2003-10/2007	Suspension Stabilizer Bar Link - Front Left
SSP2455	301191624550	NISSAN MURANO (Z50) 03/2003-10/2007	Suspension Stabilizer Bar Link - Rear Right





 SHORT LONG			DESCRIPTION
SSP2456	301191624560	NISSAN MURANO (Z50) 03/2003-10/2007	Suspension Stabilizer Bar Link - Rear Left
SSP2457	301191624570	NISSAN MURANO (Z51) 11/2007-	Suspension Stabilizer Bar Link - Rear Right
SSP2458	301191624580	NISSAN MURANO (Z51) 11/2007-	Suspension Stabilizer Bar Link - Rear Left
SSP2459	301191624590	INFINITI QX4 R50 1997-2004	Suspension Stabilizer Bar Link - Front
SSP2459	301191624590	NISSAN PATHFINDER (R50) 1997-2004	Suspension Stabilizer Bar Link - Front
SSP2460	301191624600	INFINITI QX4 R50 1997-2004	Suspension Stabilizer Bar Link - Rear
SSP2460	301191624600	NISSAN PATHFINDER (R50) 1997-2004	Suspension Stabilizer Bar Link - Rear
SSP2461	301191624610	NISSAN FRONTIER (D40) 07/2005-	Suspension Stabilizer Bar Link - Front Right
SSP2461	301191624610	NISSAN NAVARA (D40) 07/2005-	Suspension Stabilizer Bar Link - Front Right
SSP2461	301191624610	NISSAN PATHFINDER (R51) 03/2005-05/2014	Suspension Stabilizer Bar Link - Front Right
SSP2461	301191624610	NISSAN XTERRA 2nd Gen, (N50) 2005-2015	Suspension Stabilizer Bar Link - Front Right
SSP2461	301191624610	SUZUKI SPLASH 01/2008-	Suspension Stabilizer Bar Link - Front Right
SSP2462	301191624620	NISSAN FRONTIER (D40) 07/2005-	Suspension Stabilizer Bar Link - Front Left
SSP2462	301191624620	NISSAN NAVARA (D40) 07/2005-	Suspension Stabilizer Bar Link - Front Left
SSP2462	301191624620	NISSAN PATHFINDER (R51) 03/2005-05/2014	Suspension Stabilizer Bar Link - Front Left
SSP2462	301191624620	NISSAN XTERRA 2nd Gen, (N50) 2005-2015	Suspension Stabilizer Bar Link - Front Left
SSP2462	301191624620	SUZUKI SPLASH 01/2008-	Suspension Stabilizer Bar Link - Front Left
SSP2463	301191624630	NISSAN PRIMERA (P12) 01/2002-05/2008	Suspension Stabilizer Bar Link - Rear
SSP2464	301191624640	INFINITI QX56 1st Gen 2004-2010	Suspension Stabilizer Bar Link - Rear Right
SSP2464	301191624640	NISSAN ARMADA 2005-	Suspension Stabilizer Bar Link - Rear Right
SSP2464	301191624640	NISSAN PATHFINDER (R51) 03/2005-05/2014	Suspension Stabilizer Bar Link - Rear Right
SSP2465	301191624650	INFINITI QX56 1st Gen 2004-2010	Suspension Stabilizer Bar Link - Rear Left
SSP2465	301191624650	NISSAN ARMADA 2005-	Suspension Stabilizer Bar Link - Rear Left
SSP2465	301191624650	NISSAN PATHFINDER (R51) 03/2005-05/2014	Suspension Stabilizer Bar Link - Rear Left
SSP2466	301191624660	NISSAN ALMERA (N16) 07/2000-09/2006	Suspension Stabilizer Bar Link - Front
SSP2467	301191624670	NISSAN ALMERA (N16) 08/2000-07/2006	Suspension Stabilizer Bar Link - Front Left
SSP2468	301191624680	NISSAN ALMERA (N16) 08/2000-07/2006	Suspension Stabilizer Bar Link - Front Right
SSP2469	301191624690	NISSAN JUKE 06/2010-	Suspension Stabilizer Bar Link - Front
SSP2469	301191624690	NISSAN QASHQAI II (J11) 02/2014-	Suspension Stabilizer Bar Link - Front
SSP2469	301191624690	RENAULT KADJAR 2015-	Suspension Stabilizer Bar Link - Front
SSP2470	301191624700	NISSAN QASHQAI (J10, JJ10) 02/2007-01/2014	Suspension Stabilizer Bar Link - Rear Right
SSP2470	301191624700	NISSAN ROGUE 1st Gen 2008-2014	Suspension Stabilizer Bar Link - Rear Right
SSP2470	301191624700	NISSAN ROGUE 2nd Gen 2013-	Suspension Stabilizer Bar Link - Rear Right
SSP2470	301191624700	NISSAN X-TRAIL 2nd Gen (T31) 06/2007-09/2013	Suspension Stabilizer Bar Link - Rear Right
SSP2470	301191624700	NISSAN X-TRAIL 3rd Gen (T32) 2013-	Suspension Stabilizer Bar Link - Rear Right
SSP2471	301191624710	NISSAN QASHQAI (J10, JJ10) 02/2007-01/2014	Suspension Stabilizer Bar Link - Rear Left
SSP2471	301191624710	NISSAN ROGUE 1st Gen 2008-2014	Suspension Stabilizer Bar Link - Rear Left
SSP2471	301191624710	NISSAN ROGUE 2nd Gen 2013-	Suspension Stabilizer Bar Link - Rear Left





 SHORT LONG			DESCRIPTION
SSP2471	301191624710	NISSAN X-TRAIL 2nd Gen (T31) 06/2007-09/2013	Suspension Stabilizer Bar Link - Rear Left
SSP2471	301191624710	NISSAN X-TRAIL 3rd Gen (T32) 2013-	Suspension Stabilizer Bar Link - Rear Left
SSP2472	301191624720	NISSAN ALTIMA 4th Gen (L32A, D32) 2007-2012	Suspension Stabilizer Bar Link - Front Right
SSP2472	301191624720	NISSAN MURANO (Z51) 11/2007-	Suspension Stabilizer Bar Link - Front Right
SSP2472	301191624720	NISSAN QASHQAI (J10, JJ10) 02/2007-01/2014	Suspension Stabilizer Bar Link - Front Right
SSP2472	301191624720	NISSAN ROGUE 1st Gen 2008-2014	Suspension Stabilizer Bar Link - Front Right
SSP2472	301191624720	NISSAN TEANA (J32) 2009-2013	Suspension Stabilizer Bar Link - Front Right
SSP2472	301191624720	NISSAN X-TRAIL 2nd Gen (T31) 06/2007-09/2013	Suspension Stabilizer Bar Link - Front Right
SSP2472	301191624720	RENAULT KOLEOS 09/2008-	Suspension Stabilizer Bar Link - Front Right
SSP2473	301191624730	NISSAN ALTIMA 4th Gen (L32A, D32) 2007-2012	Suspension Stabilizer Bar Link - Front Left
SSP2473	301191624730	NISSAN MURANO (Z51) 11/2007-	Suspension Stabilizer Bar Link - Front Left
SSP2473	301191624730	NISSAN QASHQAI (J10, JJ10) 02/2007-01/2014	Suspension Stabilizer Bar Link - Front Left
SSP2473	301191624730	NISSAN ROGUE 1st Gen 2008-2014	Suspension Stabilizer Bar Link - Front Left
SSP2473	301191624730	NISSAN TEANA (J32) 2009-2013	Suspension Stabilizer Bar Link - Front Left
SSP2473	301191624730	NISSAN X-TRAIL 2nd Gen (T31) 06/2007-09/2013	Suspension Stabilizer Bar Link - Front Left
SSP2473	301191624730	RENAULT KOLEOS 09/2008-	Suspension Stabilizer Bar Link - Front Left
SSP2474	301191624740	INFINITI QX60 2014-	Suspension Stabilizer Bar Link - Front Right
SSP2474	301191624740	NISSAN ALTIMA 5th Gen. (L33) 2013-	Suspension Stabilizer Bar Link - Front Right
SSP2474	301191624740	NISSAN MAXIMA (A35) 2009-2014	Suspension Stabilizer Bar Link - Front Right
SSP2474	301191624740	NISSAN PATHFINDER (R52) 2014-	Suspension Stabilizer Bar Link - Front Right
SSP2475	301191624750	INFINITI QX60 2014-	Suspension Stabilizer Bar Link - Front Left
SSP2475	301191624750	NISSAN ALTIMA 5th Gen. (L33) 2013-	Suspension Stabilizer Bar Link - Front Left
SSP2475	301191624750	NISSAN MAXIMA (A35) 2009-2014	Suspension Stabilizer Bar Link - Front Left
SSP2475	301191624750	NISSAN PATHFINDER (R52) 2014-	Suspension Stabilizer Bar Link - Front Left
SSP2476	301191624760	OPEL ADAM 10/2012-	Suspension Stabilizer Bar Link - Front
SSP2476	301191624760	OPEL CORSA (E) 09/2014-	Suspension Stabilizer Bar Link - Front
SSP2477	301191624770	CHEVROLET Tornado 2003-2016	Suspension Stabilizer Bar Link - Front
SSP2477	301191624770	OPEL COMBO (B) 03/1993-08/2000	Suspension Stabilizer Bar Link - Front
SSP2477	301191624770	OPEL COMBO (C) 09/2000-07/2006	Suspension Stabilizer Bar Link - Front
SSP2477	301191624770	OPEL CORSA (B) 03/1993-08/2000	Suspension Stabilizer Bar Link - Front
SSP2477	301191624770	OPEL CORSA (C) 09/2000-07/2006	Suspension Stabilizer Bar Link - Front
SSP2477	301191624770	OPEL CORSA (Utility) 2003-2010	Suspension Stabilizer Bar Link - Front
SSP2477	301191624770	OPEL MERIVA (A) 05/2003-05/2010	Suspension Stabilizer Bar Link - Front
SSP2477	301191624770	OPEL MERIVA (B) 06/2010-	Suspension Stabilizer Bar Link - Front
SSP2477	301191624770	OPEL VECTRA (B) 1996-07/2002	Suspension Stabilizer Bar Link - Front
SSP2477	301191624770	SAAB 9_5 1st Gen YS3E 04/1997-06/2002	Suspension Stabilizer Bar Link - Front



			DESCRIPTION
SHORT	LONG		
SSP2478	301191624780	CHEVROLET MONTANA (Tornado) 2003-	Suspension Stabilizer Bar Link - Front
SSP2478	301191624780	OPEL CORSA (Utility) 2003-2010	Suspension Stabilizer Bar Link - Front
SSP2478	301191624780	OPEL CORSA-COMBO (B) 03/1993-08/2000	Suspension Stabilizer Bar Link - Front
SSP2478	301191624780	OPEL CORSA-COMBO (C) 09/2000-07/2006	Suspension Stabilizer Bar Link - Front
SSP2478	301191624780	OPEL MERIVA (A) 05/2003-05/2010	Suspension Stabilizer Bar Link - Front
SSP2478	301191624780	OPEL VECTRA (B) 1996-07/2002	Suspension Stabilizer Bar Link - Front
SSP2478	301191624780	SAAB 9_5 1st Gen YS3E 04/1997-06/2002	Suspension Stabilizer Bar Link - Front
SSP2479	301191624790	BUICK ENCORE 2012-2016	Suspension Stabilizer Bar Link - Front Right
SSP2479	301191624790	CHEVROLET EQUINOX 2nd Gen 2010-2016	Suspension Stabilizer Bar Link - Front Right
SSP2479	301191624790	OPEL MOKKA 06/2012-	Suspension Stabilizer Bar Link - Front Right
SSP2480	301191624800	BUICK ENCORE 2012-2016	Suspension Stabilizer Bar Link - Front Left
SSP2480	301191624800	CHEVROLET EQUINOX 2nd Gen 2010-2016	Suspension Stabilizer Bar Link - Front Left
SSP2480	301191624800	OPEL MOKKA 06/2012-	Suspension Stabilizer Bar Link - Front Left
SSP2481	301191624810	OPEL ASTRA (G) 1998-2004	Suspension Stabilizer Bar Link - Front
SSP2481	301191624810	OPEL ASTRA (H) 03/2004-11/2009	Suspension Stabilizer Bar Link - Front
SSP2481	301191624810	OPEL ZAFIRA (A) 1998-2004	Suspension Stabilizer Bar Link - Front
SSP2481	301191624810	OPEL ZAFIRA (B) (A05) 07/2005-09/2011	Suspension Stabilizer Bar Link - Front
SSP2481	301191624810	SATURN ASTRA (H) 2008-2009	Suspension Stabilizer Bar Link - Front
SSP2481	301191624810	VAUXHALL ASTRA 1998-	Suspension Stabilizer Bar Link - Front
SSP2481	301191624810	VAUXHALL ASTRA COUPE 1998-	Suspension Stabilizer Bar Link - Front
SSP2481	301191624810	VAUXHALL ZAFIRA 1999-	Suspension Stabilizer Bar Link - Front
SSP2482	301191624820	OPEL VECTRA (C) 08/2002-09/2008	Suspension Stabilizer Bar Link - Front
SSP2483	301191624830	OPEL ASTRA (H) 03/2004-11/2009	Suspension Stabilizer Bar Link - Front
SSP2483	301191624830	SATURN ASTRA (H) 2008-2009	Suspension Stabilizer Bar Link - Front
SSP2484	301191624840	FIAT CROMA 194 1.9DMULTIJET 06/2005-2011	Suspension Stabilizer Bar Link - Front
SSP2484	301191624840	OPEL SIGNUM 03/2003-08/2008	Suspension Stabilizer Bar Link - Front
SSP2484	301191624840	OPEL VECTRA (C) 08/2002-09/2008	Suspension Stabilizer Bar Link - Front
SSP2484	301191624840	SAAB 9_3 2nd Gen 10/2002-01/2009	Suspension Stabilizer Bar Link - Front
SSP2485	301191624850	CHEVROLET MALIBU 7th Gen 2004-2012	Suspension Stabilizer Bar Link - Rear
SSP2485	301191624850	OPEL VECTRA (C) 08/2002-09/2008	Suspension Stabilizer Bar Link - Rear
SSP2485	301191624850	PONTIAC G6 2005-2010	Suspension Stabilizer Bar Link - Rear
SSP2486	301191624860	BUICK LACROSSE 2nd Gen 2010-2016	Suspension Stabilizer Bar Link - Front
SSP2486	301191624860	OPEL INSIGNIA 1st Gen 07/2008-2017	Suspension Stabilizer Bar Link - Front
SSP2487	301191624870	CHEVROLET MALIBU 8th Gen 2013-2016	Suspension Stabilizer Bar Link - Rear
SSP2487	301191624870	OPEL INSIGNIA 1st Gen 07/2008-2017	Suspension Stabilizer Bar Link - Rear
SSP2488	301191624880	BUICK LACROSSE 2nd Gen 2010-2016	Suspension Stabilizer Bar Link - Rear
SSP2488	301191624880	CADILLAC XTS 2013-2017	Suspension Stabilizer Bar Link - Rear
SSP2488	301191624880	OPEL INSIGNIA 1st Gen 07/2008-2017	Suspension Stabilizer Bar Link - Rear
SSP2489	301191624890	BUICK REGAL 5th Gen 2011-2016	Suspension Stabilizer Bar Link - Front
SSP2489	301191624890	OPEL ASTRA (J) 12/2009-05/2015	Suspension Stabilizer Bar Link - Front





 SHORT LONG			DESCRIPTION
SSP2489	301191624890	OPEL INSIGNIA 1st Gen 07/2008-2017	Suspension Stabilizer Bar Link - Front
SSP2489	301191624890	OPEL ZAFIRA (C) (P12) 10/2011-	Suspension Stabilizer Bar Link - Front
SSP2490	301191624900	BUICK LACROSSE 2nd Gen 2010-2016	Suspension Stabilizer Bar Link - Front
SSP2490	301191624900	BUICK REGAL 5th Gen 2011-2016	Suspension Stabilizer Bar Link - Front
SSP2490	301191624900	BUICK VERANO 2012-2016	Suspension Stabilizer Bar Link - Front
SSP2490	301191624900	CHEVROLET CRUZE 05/2009-2016	Suspension Stabilizer Bar Link - Front
SSP2490	301191624900	CHEVROLET MALIBU 7th Gen 2004-2012	Suspension Stabilizer Bar Link - Front
SSP2490	301191624900	CHEVROLET VOLT 1st Gen 2010-2015	Suspension Stabilizer Bar Link - Front
SSP2490	301191624900	OPEL ASTRA (J) 12/2009-05/2015	Suspension Stabilizer Bar Link - Front
SSP2490	301191624900	OPEL INSIGNIA 1st Gen 07/2008-2017	Suspension Stabilizer Bar Link - Front
SSP2490	301191624900	OPEL ZAFIRA (C) (P12) 10/2011-	Suspension Stabilizer Bar Link - Front
SSP2491	301191624910	CHEVROLET CRUZE 2nd Gen 2016-	Suspension Stabilizer Bar Link - Front Right
SSP2491	301191624910	CHEVROLET VOLT 2nd Gen 2016-	Suspension Stabilizer Bar Link - Front Right
SSP2491	301191624910	OPEL ASTRA (K) 06/2015-	Suspension Stabilizer Bar Link - Front Right
SSP2492	301191624920	CHEVROLET CRUZE 2nd Gen 2016-	Suspension Stabilizer Bar Link - Front Left
SSP2492	301191624920	CHEVROLET VOLT 2nd Gen 2016-	Suspension Stabilizer Bar Link - Front Left
SSP2492	301191624920	OPEL ASTRA (K) 06/2015-	Suspension Stabilizer Bar Link - Front Left
SSP2493	301191624930	OPEL ASTRA GTC (J) 2011-	Suspension Stabilizer Bar Link - Front Right
SSP2494	301191624940	OPEL ASTRA GTC (J) 2011-	Suspension Stabilizer Bar Link - Front Left
SSP2495	301191624950	CITROEN C1 06/2005-03/2014	Suspension Stabilizer Bar Link - Front
SSP2495	301191624950	CITROEN C2 JM 09/2003-09/2009	Suspension Stabilizer Bar Link - Front
SSP2495	301191624950	CITROEN C3 FC 03/2003-10/2009	Suspension Stabilizer Bar Link - Front
SSP2495	301191624950	PEUGEOT 1007 (KM) 04/2005-2010	Suspension Stabilizer Bar Link - Front
SSP2495	301191624950	PEUGEOT 107 06/2005-	Suspension Stabilizer Bar Link - Front
SSP2495	301191624950	PEUGEOT 206 08/1998-12/2008	Suspension Stabilizer Bar Link - Front
SSP2495	301191624950	PEUGEOT 206+ 01/2009-12/2012	Suspension Stabilizer Bar Link - Front
SSP2495	301191624950	TOYOTA AYGO 07/2005-09/2014	Suspension Stabilizer Bar Link - Front
SSP2496	301191624960	CITROEN C1 06/2005-03/2014	Suspension Stabilizer Bar Link - Front
SSP2496	301191624960	CITROEN C2 JM 09/2003-09/2009	Suspension Stabilizer Bar Link - Front
SSP2496	301191624960	CITROEN C3 FC 03/2003-10/2009	Suspension Stabilizer Bar Link - Front
SSP2496	301191624960	PEUGEOT 1007 (KM) 04/2005-2010	Suspension Stabilizer Bar Link - Front
SSP2496	301191624960	PEUGEOT 107 06/2005-	Suspension Stabilizer Bar Link - Front
SSP2496	301191624960	PEUGEOT 206 08/1998-12/2008	Suspension Stabilizer Bar Link - Front
SSP2496	301191624960	PEUGEOT 206+ 01/2009-12/2012	Suspension Stabilizer Bar Link - Front
SSP2496	301191624960	TOYOTA AYGO 07/2005-09/2014	Suspension Stabilizer Bar Link - Front
SSP2497	301191624970	CITROEN C3 PICASSO 02/2009-	Suspension Stabilizer Bar Link - Front Right
SSP2497	301191624970	CITROEN C-ELYSEE 11/2012-	Suspension Stabilizer Bar Link - Front Right
SSP2497	301191624970	PEUGEOT 207 02/2006-11/2012	Suspension Stabilizer Bar Link - Front Right
SSP2497	301191624970	PEUGEOT 208 03/2012-	Suspension Stabilizer Bar Link - Front Right
SSP2497	301191624970	PEUGEOT 208 GTI 03/2012-	Suspension Stabilizer Bar Link - Front Right
SSP2497	301191624970	PEUGEOT 301 11/2012-	Suspension Stabilizer Bar Link - Front Right





			DESCRIPTION
SHORT	LONG		
SSP2498	301191624980	CITROEN C3 PICASSO 02/2009-	Suspension Stabilizer Bar Link - Front Left
SSP2498	301191624980	CITROEN C-ELYSEE 11/2012-	Suspension Stabilizer Bar Link - Front Left
SSP2498	301191624980	PEUGEOT 207 02/2006-11/2012	Suspension Stabilizer Bar Link - Front Left
SSP2498	301191624980	PEUGEOT 208 03/2012-	Suspension Stabilizer Bar Link - Front Left
SSP2498	301191624980	PEUGEOT 208 GTI 03/2012-	Suspension Stabilizer Bar Link - Front Left
SSP2498	301191624980	PEUGEOT 301 11/2012-	Suspension Stabilizer Bar Link - Front Left
SSP2499	301191624990	CITROEN C5 DC 03/2001-08/2004	Suspension Stabilizer Bar Link - Front
SSP2499	301191624990	CITROEN XANTIA BREAK 1993-2003	Suspension Stabilizer Bar Link - Front
SSP2499	301191624990	PEUGEOT 406 10/1995-10/2004	Suspension Stabilizer Bar Link - Front
SSP2499	301191624990	PEUGEOT 607 01/2000-11/2010	Suspension Stabilizer Bar Link - Front
SSP2500	301191625000	CITROEN BERLINGO M 04/2008-	Suspension Stabilizer Bar Link - Front
SSP2500	301191625000	CITROEN C4 GRAND PICASSO UA 02/2007-01/2013	Suspension Stabilizer Bar Link - Front
SSP2500	301191625000	PEUGEOT PARTNER II, Tepee 04/2008-	Suspension Stabilizer Bar Link - Front
SSP2501	301191625010	CITROEN BERLINGO M 04/2008-	Suspension Stabilizer Bar Link - Front
SSP2501	301191625010	CITROEN C4 GRAND PICASSO UA 02/2007-01/2013	Suspension Stabilizer Bar Link - Front
SSP2501	301191625010	PEUGEOT PARTNER II, Tepee 04/2008-	Suspension Stabilizer Bar Link - Front
SSP2502	301191625020	CITROEN BERLINGO M 04/2008-	Suspension Stabilizer Bar Link - Front
SSP2502	301191625020	CITROEN C4 GRAND PICASSO UA 02/2007-01/2013	Suspension Stabilizer Bar Link - Front
SSP2503	301191625030	CITROEN C5 RC 04/2004-01/2008	Suspension Stabilizer Bar Link - Rear
SSP2503	301191625030	CITROEN C5 RD 02/2008-	Suspension Stabilizer Bar Link - Rear
SSP2503	301191625030	CITROEN C6 TD 09/2005-09/2012	Suspension Stabilizer Bar Link - Rear
SSP2503	301191625030	PEUGEOT 407 05/2004-12/2011	Suspension Stabilizer Bar Link - Rear
SSP2503	301191625030	PEUGEOT 508 11/2010-	Suspension Stabilizer Bar Link - Rear
SSP2504	301191625040	CITROEN C5 RC 04/2004-01/2008	Suspension Stabilizer Bar Link - Front Right
SSP2504	301191625040	CITROEN C5 RD 02/2008-	Suspension Stabilizer Bar Link - Front Right
SSP2504	301191625040	CITROEN C6 TD 09/2005-09/2012	Suspension Stabilizer Bar Link - Front Right
SSP2504	301191625040	PEUGEOT 407 05/2004-12/2011	Suspension Stabilizer Bar Link - Front Right
SSP2505	301191625050	CITROEN C5 RC 04/2004-01/2008	Suspension Stabilizer Bar Link - Front Left
SSP2505	301191625050	CITROEN C5 RD 02/2008-	Suspension Stabilizer Bar Link - Front Left
SSP2505	301191625050	CITROEN C6 TD 09/2005-09/2012	Suspension Stabilizer Bar Link - Front Left
SSP2505	301191625050	PEUGEOT 407 05/2004-12/2011	Suspension Stabilizer Bar Link - Front Left
SSP2506	301191625060	CITROEN BERLINGO MF 07/1996-	Suspension Stabilizer Bar Link - Front
SSP2506	301191625060	CITROEN XSARA 1997-2005	Suspension Stabilizer Bar Link - Front
SSP2506	301191625060	CITROEN ZX 1991-1997	Suspension Stabilizer Bar Link - Front
SSP2506	301191625060	PEUGEOT 306 1993-2001	Suspension Stabilizer Bar Link - Front
SSP2506	301191625060	PEUGEOT PARTNER I 05/1996-	Suspension Stabilizer Bar Link - Front
SSP2507	301191625070	PEUGEOT 605 1989-1999	Suspension Stabilizer Bar Link - Rear Right
SSP2507	301191625070	PEUGEOT 607 01/2000-11/2010	Suspension Stabilizer Bar Link - Rear Right
SSP2508	301191625080	PEUGEOT 605 1989-1999	Suspension Stabilizer Bar Link - Rear Left



 SHORT LONG			DESCRIPTION
SSP2508	301191625080	PEUGEOT 607 01/2000-11/2010	Suspension Stabilizer Bar Link - Rear Left
SSP2509	301191625090	CITROEN C4 B7 11/2009-	Suspension Stabilizer Bar Link - Front
SSP2509	301191625090	CITROEN C4 LA 11/2004-10/2009	Suspension Stabilizer Bar Link - Front
SSP2509	301191625090	CITROEN C4 PICASSO II 2013-	Suspension Stabilizer Bar Link - Front
SSP2509	301191625090	PEUGEOT 3008 09/2009-2016	Suspension Stabilizer Bar Link - Front
SSP2509	301191625090	PEUGEOT 3008 II 2016-	Suspension Stabilizer Bar Link - Front
SSP2509	301191625090	PEUGEOT 307 08/2000-12/2008	Suspension Stabilizer Bar Link - Front
SSP2509	301191625090	PEUGEOT 308 09/2007-10/2013	Suspension Stabilizer Bar Link - Front
SSP2509	301191625090	PEUGEOT 5008 09/2009-	Suspension Stabilizer Bar Link - Front
SSP2510	301191625100	CITROEN DS5 11/2011-	Suspension Stabilizer Bar Link - Front
SSP2510	301191625100	PEUGEOT 308 II 09/2013-	Suspension Stabilizer Bar Link - Front
SSP2511	301191625110	CITROEN C4 B7 11/2009-	Suspension Stabilizer Bar Link - Front
SSP2511	301191625110	CITROEN C4 LA 11/2004-10/2009	Suspension Stabilizer Bar Link - Front
SSP2511	301191625110	PEUGEOT 3008 09/2009-2016	Suspension Stabilizer Bar Link - Front
SSP2511	301191625110	PEUGEOT 307 08/2000-12/2008	Suspension Stabilizer Bar Link - Front
SSP2511	301191625110	PEUGEOT 308 09/2007-10/2013	Suspension Stabilizer Bar Link - Front
SSP2511	301191625110	PEUGEOT 5008 09/2009-	Suspension Stabilizer Bar Link - Front
SSP2512	301191625120	PEUGEOT 508 11/2010-	Suspension Stabilizer Bar Link - Front
SSP2513	301191625130	NISSAN INTERSTAR (X70) 07/2002-08/2010	Suspension Stabilizer Bar Link - Front Right
SSP2513	301191625130	OPEL MOVANO (A) 07/1998-04/2010	Suspension Stabilizer Bar Link - Front Right
SSP2513	301191625130	RENAULT MASTER I 07/1998-09/2003	Suspension Stabilizer Bar Link - Front Right
SSP2513	301191625130	RENAULT MASTER II 10/2003-01/2010	Suspension Stabilizer Bar Link - Front Right
SSP2514	301191625140	NISSAN INTERSTAR (X70) 07/2002-08/2010	Suspension Stabilizer Bar Link - Front Left
SSP2514	301191625140	OPEL MOVANO (A) 07/1998-04/2010	Suspension Stabilizer Bar Link - Front Left
SSP2514	301191625140	RENAULT MASTER I 07/1998-09/2003	Suspension Stabilizer Bar Link - Front Left
SSP2514	301191625140	RENAULT MASTER II 10/2003-01/2010	Suspension Stabilizer Bar Link - Front Left
SSP2515	301191625150	OPEL MOVANO (B) 05/2010-	Suspension Stabilizer Bar Link - Front
SSP2515	301191625150	RENAULT MASTER III 02/2010-	Suspension Stabilizer Bar Link - Front
SSP2516	301191625160	RENAULT MASTER III 02/2010-	Suspension Stabilizer Bar Link - Front
SSP2517	301191625170	OPEL MOVANO (B) 05/2010-	Suspension Stabilizer Bar Link - Rear
SSP2517	301191625170	RENAULT MASTER III 02/2010-	Suspension Stabilizer Bar Link - Rear
SSP2518	301191625180	RENAULT MASTER III 02/2010-	Suspension Stabilizer Bar Link - Rear
SSP2519	301191625190	MERCEDES CITAN 415 11/2012-	Suspension Stabilizer Bar Link - Front
SSP2519	301191625190	RENAULT KANGOO II 02/2008-	Suspension Stabilizer Bar Link - Front
SSP2519	301191625190	RENAULT MEGANE II 09/2003-04/2009	Suspension Stabilizer Bar Link - Front
SSP2519	301191625190	RENAULT SCENIC II 06/2003-01/2009	Suspension Stabilizer Bar Link - Front
SSP2520	301191625200	RENAULT LAGUNA III 10/2007-	Suspension Stabilizer Bar Link - Front
SSP2521	301191625210	RENAULT MEGANE II 09/2003-04/2009	Suspension Stabilizer Bar Link - Front
SSP2522	301191625220	NISSAN PRIMASTAR (X83) 08/2002-06/2014	Suspension Stabilizer Bar Link - Front
SSP2522	301191625220	OPEL VIVARO II 10/2014-	Suspension Stabilizer Bar Link - Front
SSP2522	301191625220	RENAULT ESPACE IV 11/2002-09/2014	Suspension Stabilizer Bar Link - Front





 SHORT LONG			DESCRIPTION
SSP2522	301191625220	RENAULT LAGUNA II 04/2001-09/2007	Suspension Stabilizer Bar Link - Front
SSP2522	301191625220	RENAULT TRAFIC II 03/2001-09/2014	Suspension Stabilizer Bar Link - Front
SSP2522	301191625220	RENAULT VEL SATIS 06/2002-07/2009	Suspension Stabilizer Bar Link - Front
SSP2523	301191625230	NISSAN PRIMASTAR (X83) 08/2002-06/2014	Suspension Stabilizer Bar Link - Front
SSP2523	301191625230	OPEL VIVARO I 08/2001-06/2014	Suspension Stabilizer Bar Link - Front
SSP2523	301191625230	RENAULT ESPACE IV 11/2002-09/2014	Suspension Stabilizer Bar Link - Front
SSP2523	301191625230	RENAULT LAGUNA II 04/2001-09/2007	Suspension Stabilizer Bar Link - Front
SSP2523	301191625230	RENAULT TRAFIC II 03/2001-09/2014	Suspension Stabilizer Bar Link - Front
SSP2524	301191625240	RENAULT VEL SATIS 06/2002-07/2009	Suspension Stabilizer Bar Link - Rear
SSP2525	301191625250	RENAULT MEGANE III 05/2009-10/2015	Suspension Stabilizer Bar Link - Front
SSP2525	301191625250	RENAULT SCENIC III 02/2009-	Suspension Stabilizer Bar Link - Front
SSP2526	301191625260	RENAULT MEGANE III 05/2009-10/2015	Suspension Stabilizer Bar Link - Front
SSP2526	301191625260	RENAULT SCENIC III 02/2009-	Suspension Stabilizer Bar Link - Front
SSP2527	301191625270	RENAULT MEGANE III 05/2009-10/2015	Suspension Stabilizer Bar Link - Front
SSP2527	301191625270	RENAULT SCENIC III 02/2009-	Suspension Stabilizer Bar Link - Front
SSP2528	301191625280	RENAULT CLIO III-HB 06/2005-09/2012	Suspension Stabilizer Bar Link - Front
SSP2528	301191625280	RENAULT MEGANE III 05/2009-10/2015	Suspension Stabilizer Bar Link - Front
SSP2529	301191625290	RENAULT CLIO IV-HB 10/2012-	Suspension Stabilizer Bar Link - Front
SSP2530	301191625300	RENAULT TWINGO (C06) 03/1993-02/2007	Suspension Stabilizer Bar Link - Front Right
SSP2531	301191625310	RENAULT TWINGO (C06) 03/1993-02/2007	Suspension Stabilizer Bar Link - Front Left
SSP2532	301191625320	RENAULT MEGANE IV 2016-	Suspension Stabilizer Bar Link - Front
SSP2532	301191625320	RENAULT TALISMAN 1st Gen 2015-	Suspension Stabilizer Bar Link - Front
SSP2533	301191625330	RENAULT MEGANE IV 2016-	Suspension Stabilizer Bar Link - Front
SSP2533	301191625330	RENAULT TALISMAN 1st Gen 2015-	Suspension Stabilizer Bar Link - Front
SSP2534	301191625340	SEAT CORDOBA (6L2) 09/2002-11/2009	Suspension Stabilizer Bar Link - Front
SSP2534	301191625340	SEAT IBIZA V (6R) 03/2008-	Suspension Stabilizer Bar Link - Front
SSP2534	301191625340	SEAT Mii (KYF) 10/2011-	Suspension Stabilizer Bar Link - Front
SSP2534	301191625340	SKODA FABIA (5J) 12/2006-09/2014	Suspension Stabilizer Bar Link - Front
SSP2534	301191625340	SKODA FABIA (6Y2) 08/1999-11/2006	Suspension Stabilizer Bar Link - Front
SSP2534	301191625340	SKODA PRAKTIK 03/2007-	Suspension Stabilizer Bar Link - Front
SSP2534	301191625340	SKODA ROOMSTER (5J) 07/2006-	Suspension Stabilizer Bar Link - Front
SSP2534	301191625340	VOLKSWAGEN POLO (6R) 06/2009-	Suspension Stabilizer Bar Link - Front
SSP2534	301191625340	VOLKSWAGEN POLO (9N) 10/2001-05/2009	Suspension Stabilizer Bar Link - Front
SSP2534	301191625340	VOLKSWAGEN Up! 12/2011-2016	Suspension Stabilizer Bar Link - Front
SSP2535	301191625350	SEAT CORDOBA (6L2) 09/2002-11/2009	Suspension Stabilizer Bar Link - Front
SSP2535	301191625350	SEAT IBIZA V (6R) 03/2008-	Suspension Stabilizer Bar Link - Front
SSP2535	301191625350	SKODA FABIA (5J) 12/2006-09/2014	Suspension Stabilizer Bar Link - Front
SSP2535	301191625350	SKODA FABIA (6Y2) 08/1999-11/2006	Suspension Stabilizer Bar Link - Front
SSP2535	301191625350	VOLKSWAGEN POLO (6R) 06/2009-	Suspension Stabilizer Bar Link - Front
SSP2535	301191625350	VOLKSWAGEN POLO (9N) 10/2001-05/2009	Suspension Stabilizer Bar Link - Front
SSP2536	301191625360	SKODA RAPID 07/2012-	Suspension Stabilizer Bar Link - Front





 SHORT LONG			DESCRIPTION
SSP2537	301191625370	AUDI A3 8V1 09/2012-	Suspension Stabilizer Bar Link - Front
SSP2537	301191625370	SKODA OCTAVIA (5 E) 11/2012-	Suspension Stabilizer Bar Link - Front
SSP2538	301191625380	MITSUBISHI COLT VI 10/2002-06/2012	Suspension Stabilizer Bar Link - Front
SSP2538	301191625380	SMART FORFOUR 454 06/2004-10/2012	Suspension Stabilizer Bar Link - Front
SSP2539	301191625390	OPEL AGILA (B) 09/2007-12/2014	Suspension Stabilizer Bar Link - Front
SSP2539	301191625390	SUZUKI SPLASH 01/2008-	Suspension Stabilizer Bar Link - Front
SSP2539	301191625390	SUZUKI SWIFT III (SG) 02/2005-09/2010	Suspension Stabilizer Bar Link - Front
SSP2540	301191625400	LEXUS ES300 XV10, XV20 1991-2001	Suspension Stabilizer Bar Link - Front Left
SSP2540	301191625400	LEXUS RX300 1999-2003	Suspension Stabilizer Bar Link - Front Left
SSP2540	301191625400	TOYOTA AYGO 1995-2004	Suspension Stabilizer Bar Link - Front Left
SSP2540	301191625400	TOYOTA CAMRY XV10 06/1991-08/1996	Suspension Stabilizer Bar Link - Front Left
SSP2540	301191625400	TOYOTA CAMRY XV20 09/1996-10/2001	Suspension Stabilizer Bar Link - Front Left
SSP2540	301191625400	TOYOTA SOLARA XV20 1999-2003	Suspension Stabilizer Bar Link - Front Left
SSP2541	301191625410	LEXUS ES300 XV10, XV20 1991-2001	Suspension Stabilizer Bar Link - Rear
SSP2541	301191625410	LEXUS RX300 1999-2003	Suspension Stabilizer Bar Link - Rear
SSP2541	301191625410	LEXUS RX330 MHU3, GSU3, MCU3 02/2003-12/2008	Suspension Stabilizer Bar Link - Rear
SSP2541	301191625410	LEXUS RX350 MHU3, GSU3, MCU3 02/2003-12/2008	Suspension Stabilizer Bar Link - Rear
SSP2541	301191625410	LEXUS RX400h MHU3, GSU3, MCU3 02/2003-12/2008	Suspension Stabilizer Bar Link - Rear
SSP2541	301191625410	TOYOTA AYGO 1995-2004	Suspension Stabilizer Bar Link - Rear
SSP2541	301191625410	TOYOTA CAMRY XV30 11/2001-12/2006	Suspension Stabilizer Bar Link - Rear
SSP2541	301191625410	TOYOTA HIGHLANDER XU20 2001-2007	Suspension Stabilizer Bar Link - Rear
SSP2541	301191625410	TOYOTA SOLARA XV20 1999-2003	Suspension Stabilizer Bar Link - Rear
SSP2542	301191625420	LEXUS GX470 J120 2003-2010	Suspension Stabilizer Bar Link - Rear
SSP2542	301191625420	TOYOTA LAND CRUISER J120 01/2003-02/2010	Suspension Stabilizer Bar Link - Rear
SSP2543	301191625430	LEXUS GX470 J120 2003-2010	Suspension Stabilizer Bar Link - Front Right
SSP2543	301191625430	TOYOTA LAND CRUISER J120 01/2003-02/2010	Suspension Stabilizer Bar Link - Front Right
SSP2544	301191625440	LEXUS GX470 J120 2003-2010	Suspension Stabilizer Bar Link - Front Left
SSP2544	301191625440	TOYOTA LAND CRUISER J120 01/2003-02/2010	Suspension Stabilizer Bar Link - Front Left
SSP2545	301191625450	LEXUS LX470 J100 1998-2007	Suspension Stabilizer Bar Link - Front
SSP2545	301191625450	TOYOTA LAND CRUISER J100 01/1998-08/2007	Suspension Stabilizer Bar Link - Front
SSP2546	301191625460	TOYOTA HILUX III 4WD Pick-Up 08/2005-2015	Suspension Stabilizer Bar Link - Front Right
SSP2547	301191625470	TOYOTA HILUX III 4WD Pick-Up 08/2005-2015	Suspension Stabilizer Bar Link - Front Left
SSP2548	301191625480	TOYOTA ECHO XP10 1999-2005	Suspension Stabilizer Bar Link - Front
SSP2548	301191625480	TOYOTA YARIS (P1) 04/1999-10/2005	Suspension Stabilizer Bar Link - Front
SSP2549	301191625490	TOYOTA YARIS (P13) 10/2010-	Suspension Stabilizer Bar Link - Front





 SHORT LONG			DESCRIPTION
SSP2549	301191625490	TOYOTA YARIS (P9) 11/2005-09/2010	Suspension Stabilizer Bar Link - Front
SSP2550	301191625500	TOYOTA RAV4 XA10 1995-06/2000	Suspension Stabilizer Bar Link - Front
SSP2551	301191625510	TOYOTA RAV4 XA20 07/2000-11/2005	Suspension Stabilizer Bar Link - Rear Left
SSP2552	301191625520	TOYOTA RAV4 XA20 07/2000-11/2005	Suspension Stabilizer Bar Link - Front
SSP2553	301191625530	TOYOTA RAV4 XA20 07/2000-11/2005	Suspension Stabilizer Bar Link - Rear Right
SSP2554	301191625540	TOYOTA RAV4 XA30 12/2005-2012	Suspension Stabilizer Bar Link - Rear
SSP2554	301191625540	TOYOTA RAV4 XA40 2013-	Suspension Stabilizer Bar Link - Rear
SSP2555	301191625550	TOYOTA AVENSIS (T25) 04/2003-01/2009	Suspension Stabilizer Bar Link - Front
SSP2555	301191625550	TOYOTA COROLLA Verso 04/2004-04/2009	Suspension Stabilizer Bar Link - Front
SSP2556	301191625560	SCION TC 1st Gen ANT10 2005-2010	Suspension Stabilizer Bar Link - Rear Right
SSP2556	301191625560	TOYOTA AVENSIS (T25) 04/2003-01/2009	Suspension Stabilizer Bar Link - Rear Right
SSP2556	301191625560	TOYOTA COROLLA E120 02/2002-01/2007	Suspension Stabilizer Bar Link - Rear Right
SSP2557	301191625570	SCION TC 1st Gen ANT10 2005-2010	Suspension Stabilizer Bar Link - Rear Left
SSP2557	301191625570	TOYOTA AVENSIS (T25) 04/2003-01/2009	Suspension Stabilizer Bar Link - Rear Left
SSP2557	301191625570	TOYOTA COROLLA E120 02/2002-01/2007	Suspension Stabilizer Bar Link - Rear Left
SSP2558	301191625580	TOYOTA HILUX III 2WD Pick-Up 08/2005-2015	Suspension Stabilizer Bar Link - Front
SSP2558	301191625580	TOYOTA INNOVA AN40 2005-2015	Suspension Stabilizer Bar Link - Front
SSP2559	301191625590	PONTIAC VIBE 2003-2010	Suspension Stabilizer Bar Link - Front
SSP2559	301191625590	TOYOTA CELICA 08/1999-09/2005	Suspension Stabilizer Bar Link - Front
SSP2559	301191625590	TOYOTA COROLLA E120 02/2002-01/2007	Suspension Stabilizer Bar Link - Front
SSP2560	301191625600	TOYOTA IQ 01/2009-2016	Suspension Stabilizer Bar Link - Front
SSP2561	301191625610	TOYOTA AURIS I 02/2007-06/2013	Suspension Stabilizer Bar Link - Front
SSP2561	301191625610	TOYOTA AURIS II 07/2013-	Suspension Stabilizer Bar Link - Front
SSP2561	301191625610	TOYOTA AVENSIS (T27) 02/2009-	Suspension Stabilizer Bar Link - Front
SSP2561	301191625610	TOYOTA COROLLA E140 02/2007-06/2013	Suspension Stabilizer Bar Link - Front
SSP2561	301191625610	TOYOTA COROLLA E170 07/2013-	Suspension Stabilizer Bar Link - Front
SSP2561	301191625610	TOYOTA PRIUS XW30 01/2009-2015	Suspension Stabilizer Bar Link - Front
SSP2561	301191625610	TOYOTA RAV4 XA30 12/2005-2012	Suspension Stabilizer Bar Link - Front
SSP2561	301191625610	TOYOTA RAV4 XA40 2013-	Suspension Stabilizer Bar Link - Front
SSP2562	301191625620	TOYOTA LAND CRUISER J90 1996-2002	Suspension Stabilizer Bar Link - Front
SSP2563	301191625630	TOYOTA LAND CRUISER J200 01/2008-	Suspension Stabilizer Bar Link - Rear
SSP2564	301191625640	TOYOTA LAND CRUISER J200 01/2008-	Suspension Stabilizer Bar Link - Front Right
SSP2565	301191625650	TOYOTA LAND CRUISER J200 01/2008-	Suspension Stabilizer Bar Link - Front Left
SSP2566	301191625660	AUDI Q7 4L 03/2006-08/2010	Suspension Stabilizer Bar Link - Front
SSP2566	301191625660	PORSCHE CAYENNE 92A 2011-	Suspension Stabilizer Bar Link - Front
SSP2566	301191625660	PORSCHE CAYENNE 955 09/2002-08/2010	Suspension Stabilizer Bar Link - Front
SSP2566	301191625660	VOLKSWAGEN GOL 2002-2010	Suspension Stabilizer Bar Link - Front
SSP2566	301191625660	VOLKSWAGEN TOUAREG (7LA,7L6,7L7) 10/2002-05/2010	Suspension Stabilizer Bar Link - Front
SSP2567	301191625670	PORSCHE CAYENNE 955 09/2002-08/2010	Suspension Stabilizer Bar Link - Rear Right





 SHORT LONG			DESCRIPTION
SSP2567	301191625670	VOLKSWAGEN GOL 2002-2010	Suspension Stabilizer Bar Link - Rear Right
SSP2567	301191625670	VOLKSWAGEN TOUAREG (7LA,7L6,7L7) 10/2002-05/2010	Suspension Stabilizer Bar Link - Rear Right
SSP2568	301191625680	PORSCHE CAYENNE 955 09/2002-08/2010	Suspension Stabilizer Bar Link - Rear Left
SSP2568	301191625680	VOLKSWAGEN GOL 2002-2010	Suspension Stabilizer Bar Link - Rear Left
SSP2568	301191625680	VOLKSWAGEN TOUAREG (7LA,7L6,7L7) 10/2002-05/2010	Suspension Stabilizer Bar Link - Rear Left
SSP2569	301191625690	VOLKSWAGEN AMAROK 09/2010-	Suspension Stabilizer Bar Link - Front
SSP2570	301191625700	VOLKSWAGEN AMAROK 09/2010-	Suspension Stabilizer Bar Link - Front
SSP2571	301191625710	AUDI A3 8L1 09/1996-05/2003	Suspension Stabilizer Bar Link - Front
SSP2571	301191625710	SEAT LEON 1M1 03/1999-05/2006	Suspension Stabilizer Bar Link - Front
SSP2571	301191625710	SEAT TOLEDO II (1M2) 03/1999-05/2006	Suspension Stabilizer Bar Link - Front
SSP2571	301191625710	SKODA OCTAVIA (1U2), (1U5) 07/1996-05/2004	Suspension Stabilizer Bar Link - Front
SSP2571	301191625710	VOLKSWAGEN BEETLE 9C1, 1C1 1998-2010	Suspension Stabilizer Bar Link - Front
SSP2571	301191625710	VOLKSWAGEN GOLF MK4/A4 1998-09/2003	Suspension Stabilizer Bar Link - Front
SSP2571	301191625710	VOLKSWAGEN JETTA MK4/A4 1998-09/2003	Suspension Stabilizer Bar Link - Front
SSP2572	301191625720	AUDI A3 8L1 09/1996-05/2003	Suspension Stabilizer Bar Link - Front
SSP2572	301191625720	SKODA OCTAVIA (1U2), (1U5) 07/1996-05/2004	Suspension Stabilizer Bar Link - Front
SSP2572	301191625720	VOLKSWAGEN BEETLE 9C1, 1C1 1998-2010	Suspension Stabilizer Bar Link - Front
SSP2572	301191625720	VOLKSWAGEN GOLF MK4/A4 1998-09/2003	Suspension Stabilizer Bar Link - Front
SSP2572	301191625720	VOLKSWAGEN JETTA MK4/A4 1998-09/2003	Suspension Stabilizer Bar Link - Front
SSP2573	301191625730	VOLKSWAGEN BEETLE 9C1, 1C1 1998-2010	Suspension Stabilizer Bar Link - Front Right
SSP2573	301191625730	VOLKSWAGEN GOLF MK4/A4 1998-09/2003	Suspension Stabilizer Bar Link - Front Right
SSP2573	301191625730	VOLKSWAGEN JETTA MK4/A4 1998-09/2003	Suspension Stabilizer Bar Link - Front Right
SSP2574	301191625740	VOLKSWAGEN BEETLE 9C1, 1C1 1998-2010	Suspension Stabilizer Bar Link - Front Left
SSP2574	301191625740	VOLKSWAGEN GOLF MK4/A4 1998-09/2003	Suspension Stabilizer Bar Link - Front Left
SSP2574	301191625740	VOLKSWAGEN JETTA MK4/A4 1998-09/2003	Suspension Stabilizer Bar Link - Front Left
SSP2575	301191625750	VOLKSWAGEN BEETLE 9C1, 1C1 1998-2010	Suspension Stabilizer Bar Link - Front
SSP2575	301191625750	VOLKSWAGEN GOLF MK4/A4 1998-09/2003	Suspension Stabilizer Bar Link - Front
SSP2575	301191625750	VOLKSWAGEN JETTA MK4/A4 1998-09/2003	Suspension Stabilizer Bar Link - Front
SSP2576	301191625760	AUDI A3 8P1 06/2003-08/2012	Suspension Stabilizer Bar Link - Front
SSP2576	301191625760	AUDI TT 8J3 07/2006-06/2014	Suspension Stabilizer Bar Link - Front
SSP2576	301191625760	AUDI TT FV3 2014-	Suspension Stabilizer Bar Link - Front
SSP2576	301191625760	SEAT ALTEA V 03/2004-	Suspension Stabilizer Bar Link - Front
SSP2576	301191625760	SEAT LEON (5F1) 12/2012-	Suspension Stabilizer Bar Link - Front
SSP2576	301191625760	SEAT LEON 1P1 2006-2012	Suspension Stabilizer Bar Link - Front
SSP2576	301191625760	SEAT TOLEDO III (5P2) 07/2006-05/2009	Suspension Stabilizer Bar Link - Front
SSP2576	301191625760	SKODA KODIAQ (NS7) 2016-	Suspension Stabilizer Bar Link - Front
SSP2576	301191625760	SKODA OCTAVIA (1Z3), (1Z5) 06/2004-10/2012	Suspension Stabilizer Bar Link - Front
SSP2576	301191625760	SKODA SUPERB (3T4) 04/2008-	Suspension Stabilizer Bar Link - Front





 SHORT LONG			DESCRIPTION
SSP2576	301191625760	SKODA YETI (5L) 05/2009-	Suspension Stabilizer Bar Link - Front
SSP2576	301191625760	VOLKSWAGEN BEETLE A5 04/2011-	Suspension Stabilizer Bar Link - Front
SSP2576	301191625760	VOLKSWAGEN CADDY Typ 2K 03/2004-04/2015	Suspension Stabilizer Bar Link - Front
SSP2576	301191625760	VOLKSWAGEN EOS 2006-2016	Suspension Stabilizer Bar Link - Front
SSP2576	301191625760	VOLKSWAGEN GOLF MK5/A5 10/2003-06/2009	Suspension Stabilizer Bar Link - Front
SSP2576	301191625760	VOLKSWAGEN GOLF MK6/A6 2010-2013	Suspension Stabilizer Bar Link - Front
SSP2576	301191625760	VOLKSWAGEN GOLF MK7/MQB 11/2012-	Suspension Stabilizer Bar Link - Front
SSP2576	301191625760	VOLKSWAGEN GTI MK5/A5 2006-2009	Suspension Stabilizer Bar Link - Front
SSP2576	301191625760	VOLKSWAGEN JETTA IV (162) 11/2010-	Suspension Stabilizer Bar Link - Front
SSP2576	301191625760	VOLKSWAGEN JETTA MK5/A5 08/2005-10/2010	Suspension Stabilizer Bar Link - Front
SSP2576	301191625760	VOLKSWAGEN PASSAT 3G2 2014-	Suspension Stabilizer Bar Link - Front
SSP2576	301191625760	VOLKSWAGEN PASSAT B6 09/2005-07/2010	Suspension Stabilizer Bar Link - Front
SSP2576	301191625760	VOLKSWAGEN PASSAT B7 08/2010-04/2015	Suspension Stabilizer Bar Link - Front
SSP2576	301191625760	VOLKSWAGEN Rabbit MK5/A5 10/2003-06/2009	Suspension Stabilizer Bar Link - Front
SSP2576	301191625760	VOLKSWAGEN TOURAN (1T1,1T2) 02/2003-05/2010	Suspension Stabilizer Bar Link - Front
SSP2576	301191625760	VOLKSWAGEN TOURAN (1T3) 06/2010-	Suspension Stabilizer Bar Link - Front
SSP2577	301191625770	AUDI A3 8P1 06/2003-08/2012	Suspension Stabilizer Bar Link - Rear
SSP2577	301191625770	AUDI Q3 8U 06/2011-2016	Suspension Stabilizer Bar Link - Rear
SSP2577	301191625770	SEAT ALTEA V 03/2004-	Suspension Stabilizer Bar Link - Rear
SSP2577	301191625770	SEAT LEON (5F1) 12/2012-	Suspension Stabilizer Bar Link - Rear
SSP2577	301191625770	SEAT LEON 1P1 2006-2012	Suspension Stabilizer Bar Link - Rear
SSP2577	301191625770	SEAT TOLEDO III (5P2) 07/2006-05/2009	Suspension Stabilizer Bar Link - Rear
SSP2577	301191625770	SKODA OCTAVIA (1Z3), (1Z5) 06/2004-10/2012	Suspension Stabilizer Bar Link - Rear
SSP2577	301191625770	SKODA SUPERB (3T4) 04/2008-	Suspension Stabilizer Bar Link - Rear
SSP2577	301191625770	SKODA YETI (5L) 05/2009-	Suspension Stabilizer Bar Link - Rear
SSP2577	301191625770	VOLKSWAGEN BEETLE A5 04/2011-	Suspension Stabilizer Bar Link - Rear
SSP2577	301191625770	VOLKSWAGEN EOS 2006-2016	Suspension Stabilizer Bar Link - Rear
SSP2577	301191625770	VOLKSWAGEN GOLF MK5/A5 10/2003-06/2009	Suspension Stabilizer Bar Link - Rear
SSP2577	301191625770	VOLKSWAGEN GOLF MK6/A6 2010-2013	Suspension Stabilizer Bar Link - Rear
SSP2577	301191625770	VOLKSWAGEN GTI MK5/A5 2006-2009	Suspension Stabilizer Bar Link - Rear
SSP2577	301191625770	VOLKSWAGEN JETTA IV (162) 11/2010-	Suspension Stabilizer Bar Link - Rear
SSP2577	301191625770	VOLKSWAGEN JETTA MK5/A5 08/2005-10/2010	Suspension Stabilizer Bar Link - Rear
SSP2577	301191625770	VOLKSWAGEN PASSAT B5, B5.5 1997-08/2005	Suspension Stabilizer Bar Link - Rear
SSP2577	301191625770	VOLKSWAGEN PASSAT B6 09/2005-07/2010	Suspension Stabilizer Bar Link - Rear
SSP2577	301191625770	VOLKSWAGEN PASSAT B7 08/2010-04/2015	Suspension Stabilizer Bar Link - Rear



 SHORT LONG			DESCRIPTION
SSP2577	301191625770	VOLKSWAGEN Rabbit MK5/A5 10/2003-06/2009	Suspension Stabilizer Bar Link - Rear
SSP2577	301191625770	VOLKSWAGEN SHARAN (7N) 04/2010-	Suspension Stabilizer Bar Link - Rear
SSP2577	301191625770	VOLKSWAGEN TOURAN (1T1,1T2) 02/2003-05/2010	Suspension Stabilizer Bar Link - Rear
SSP2578	301191625780	VOLKSWAGEN CADDY Typ 2K 03/2004-04/2015	Suspension Stabilizer Bar Link - Rear
SSP2578	301191625780	VOLKSWAGEN GOLF MK5/A5 10/2003-06/2009	Suspension Stabilizer BarW Link - Rear
SSP2578	301191625780	VOLKSWAGEN GTI MK5/A5 2006-2009	Suspension Stabilizer Bar Link - Rear
SSP2578	301191625780	VOLKSWAGEN Rabbit MK5/A5 10/2003-06/2009	Suspension Stabilizer Bar Link - Rear
SSP2579	301191625790	AUDI A3 8V1 09/2012-	Suspension Stabilizer Bar Link - Rear
SSP2579	301191625790	AUDI TT FV3 2014-	Suspension Stabilizer Bar Link - Rear
SSP2579	301191625790	SEAT LEON (5F1) 12/2012-	Suspension Stabilizer Bar Link - Rear
SSP2579	301191625790	SKODA KODIAQ (NS7) 2016-	Suspension Stabilizer Bar Link - Rear
SSP2579	301191625790	VOLKSWAGEN GOLF MK7/MQB 11/2012-	Suspension Stabilizer Bar Link - Rear
SSP2579	301191625790	VOLKSWAGEN PASSAT 3G2 2014-	Suspension Stabilizer Bar Link - Rear
SSP2580	301191625800	VOLKSWAGEN TRANSPORTER T5 05/2003-04/2011	Suspension Stabilizer Bar Link - Front
SSP2580	301191625800	VOLKSWAGEN TRANSPORTER T5, facelift 05/2011-2016	Suspension Stabilizer Bar Link - Front
SSP2580	301191625800	VOLKSWAGEN TRANSPORTER T6 2016-	Suspension Stabilizer Bar Link - Front
SSP2581	301191625810	VOLKSWAGEN TRANSPORTER T5 05/2003-04/2011	Suspension Stabilizer Bar Link - Front
SSP2581	301191625810	VOLKSWAGEN TRANSPORTER T5, facelift 05/2011-2016	Suspension Stabilizer Bar Link - Front
SSP2581	301191625810	VOLKSWAGEN TRANSPORTER T6 2016-	Suspension Stabilizer Bar Link - Front
SSP2582	301191625820	FORD GALAXY 05/1995-04/2006	Suspension Stabilizer Bar Link - Front
SSP2582	301191625820	SEAT ALHAMBRA (7V8,7V9) 04/1996-03/2010	Suspension Stabilizer Bar Link - Front
SSP2582	301191625820	VOLKSWAGEN SHARAN (7M6,7M8,7M9) 05/1995-03/2010	Suspension Stabilizer Bar Link - Front
SSP2583	301191625830	FORD GALAXY 05/1995-04/2006	Suspension Stabilizer Bar Link - Front
SSP2583	301191625830	SEAT ALHAMBRA (7V8,7V9) 04/1996-03/2010	Suspension Stabilizer Bar Link - Front
SSP2583	301191625830	VOLKSWAGEN SHARAN (7M6,7M8,7M9) 05/1995-03/2010	Suspension Stabilizer Bar Link - Front
SSP2584	301191625840	SEAT AROSA 05/1997-06/2004	Suspension Stabilizer Bar Link - Front
SSP2584	301191625840	VOLKSWAGEN LUPO 09/1998-07/2005	Suspension Stabilizer Bar Link - Front
SSP2584	301191625840	VOLKSWAGEN POLO (6N1) 1994-09/2001	Suspension Stabilizer Bar Link - Front
SSP2585	301191625850	SEAT CORDOBA III 1993-1999	Suspension Stabilizer Bar Link - Front
SSP2585	301191625850	SEAT IBIZA II 01/1994-08/1999	Suspension Stabilizer Bar Link - Front
SSP2585	301191625850	SEAT IBIZA IV (6L1) 02/2002-11/2009	Suspension Stabilizer Bar Link - Front
SSP2585	301191625850	SEAT TOLEDO I (1L) - CORDOBA - IBIZA III 1993-1999	Suspension Stabilizer Bar Link - Front
SSP2585	301191625850	VOLKSWAGEN GOLF MK3/A3 1991-1998	Suspension Stabilizer Bar Link - Front
SSP2585	301191625850	VOLKSWAGEN JETTA MK3/A3 1991-1998	Suspension Stabilizer Bar Link - Front



 SHORT LONG			DESCRIPTION
SSP2585	301191625850	VOLKSWAGEN VENTO MK3/A3 1991-1998	Suspension Stabilizer Bar Link - Front
SSP2586	301191625860	VOLKSWAGEN POLO (9N) 10/2001-05/2009	Suspension Stabilizer Bar Link - Front
SSP2587	301191625870	SEAT AROSA 05/1997-06/2004	Suspension Stabilizer Bar Link - Front
SSP2587	301191625870	VOLKSWAGEN LUPO 09/1998-07/2005	Suspension Stabilizer Bar Link - Front
SSP2587	301191625870	VOLKSWAGEN POLO (6N1) 1994-09/2001	Suspension Stabilizer Bar Link - Front
SSP2587	301191625870	VOLKSWAGEN POLO CLASSIC - CADDY II 1995-2001	Suspension Stabilizer Bar Link - Front
SSP2588	301191625880	VOLKSWAGEN LUPO 09/1998-07/2005	Suspension Stabilizer Bar Link - Front
SSP2589	301191625890	MITSUBISHI CARISMA 09/2000-06/2006	Suspension Stabilizer Bar Link - Rear
SSP2589	301191625890	VOLVO S40 I (VS) 07/1995-12/2003	Suspension Stabilizer Bar Link - Rear
SSP2589	301191625890	VOLVO S40 II (MS) 01/2004-11/2012	Suspension Stabilizer Bar Link - Rear
SSP2589	301191625890	VOLVO V40 I (VW) 07/1995-06/2004	Suspension Stabilizer Bar Link - Rear
SSP2590	301191625900	MITSUBISHI CARISMA 07/1995-09/2000	Suspension Stabilizer Bar Link - Front
SSP2590	301191625900	VOLVO S40 I (VS) 07/1995-12/2003	Suspension Stabilizer Bar Link - Front
SSP2590	301191625900	VOLVO V40 I (VW) 07/1995-06/2004	Suspension Stabilizer Bar Link - Front
SSP2591	301191625910	VOLVO S40 I (VS) 07/1995-12/2003	Suspension Stabilizer Bar Link - Rear Center
SSP2591	301191625910	VOLVO V40 I (VW) 07/1995-06/2004	Suspension Stabilizer Bar Link - Rear Center
SSP2592	301191625920	VOLVO S40 I (VS) 07/1995-12/2003	Suspension Stabilizer Bar Link - Rear
SSP2592	301191625920	VOLVO V40 I (VW) 07/1995-06/2004	Suspension Stabilizer Bar Link - Rear
SSP2593	301191625930	VOLVO S60 I 07/2000-04/2010	Suspension Stabilizer Bar Link - Rear
SSP2593	301191625930	VOLVO V70 II (P80) 03/2000-08/2007	Suspension Stabilizer Bar Link - Rear
SSP2593	301191625930	VOLVO XC70 II Cross Country 03/2000-08/2007	Suspension Stabilizer Bar Link - Rear
SSP2593	301191625930	VOLVO XC90 I 10/2002-10/2014	Suspension Stabilizer Bar Link - Rear
SSP2594	301191625940	VOLVO S60 I 07/2000-04/2010	Suspension Stabilizer Bar Link - Front
SSP2594	301191625940	VOLVO S80 I (TS,XY) 05/1998-07/2006	Suspension Stabilizer Bar Link - Front
SSP2594	301191625940	VOLVO V70 II (P80) 03/2000-08/2007	Suspension Stabilizer Bar Link - Front
SSP2594	301191625940	VOLVO XC70 II Cross Country 03/2000-08/2007	Suspension Stabilizer Bar Link - Front
SSP2594	301191625940	VOLVO XC90 I 10/2002-10/2014	Suspension Stabilizer Bar Link - Front
SSP2595	301191625950	VOLVO S60 I 07/2000-04/2010	Suspension Stabilizer Bar Link - Front
SSP2595	301191625950	VOLVO S80 I (TS,XY) 05/1998-07/2006	Suspension Stabilizer Bar Link - Front
SSP2595	301191625950	VOLVO V70 II (P80) 03/2000-08/2007	Suspension Stabilizer Bar Link - Front
SSP2595	301191625950	VOLVO XC70 II Cross Country 03/2000-08/2007	Suspension Stabilizer Bar Link - Front
SSP2595	301191625950	VOLVO XC90 I 10/2002-10/2014	Suspension Stabilizer Bar Link - Front
SSP2596	301191625960	FORD FOCUS III 04/2011-	Suspension Stabilizer Bar Link - Rear
SSP2596	301191625960	VOLVO V40 II 03/2012-	Suspension Stabilizer Bar Link - Rear

Applicazione per marca e veicolo
Vehicle application guide
Zuordnung nach Marke und Fahrzeug
Affectations par marques et véhicules
Aplicación por marca y vehículo
Aplicação por marca e veículo
Εφαρμογή ανα μοντελο
Zastosowanie dla marki i pojazdu
Применение по марке и модели
Marka ve otomobile göre uygulama

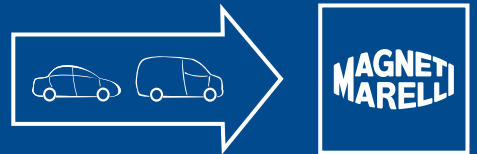

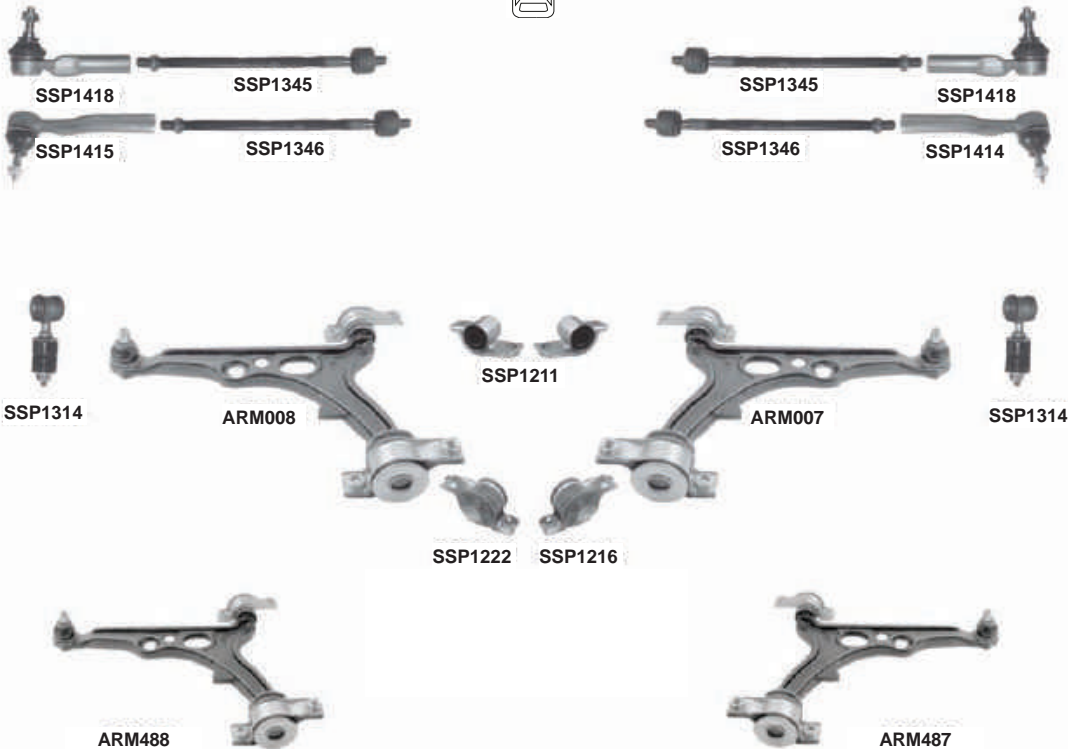

PART NO.	DESCRIPTION	NOTES	O.E.
ARM007 301181300700	Suspension Control Arm and Ball Joint Assembly - Front Right	D=Ø17mm	46456050; 60809814; 60586772
ARM008 301181300800	Suspension Control Arm and Ball Joint Assembly - Front Left Lower	D=Ø17mm	46456049; 60809813; 60586771
ARM487 301181348700	Suspension Control Arm and Ball Joint Assembly - Front Right Lower	Forging D=Ø17mm	60813014; 60813044
ARM488 301181348800	Suspension Control Arm and Ball Joint Assembly - Front Left	Forging D=Ø17mm	60813013; 60813043
SSP1211 301181312110	Bush / Silent block - Track control arm	ARM008 / ARM007 / ARM041 / ARM042 / ARM155 / ARM156 D=Ø20,9mm Center: 83mm	7601064
SSP1216 301181312160	Bush / Silent block - Track control arm - Rear Rh	ARM007 / ARM041 / ARM155	7601065
SSP1222 301181312220	Bush / Silent block - Track control arm - Rear Lh	ARM008 / ARM042 / ARM156	7601068
SSP1314 301181313140	Suspension Stabilizer Bar Link - Front	M10x1,25Rht - L=114mm	12574521; 7601643; 7601642; 60570627
SSP1345 301181313450	Steering Tie Rod - Front Inner	Only:2.0 lt H.D M12x1,5 - L=267mm	9947361
SSP1346 301181313460	Steering Tie Rod - Front Inner	Power Steering M12x1,5 Rht - L=285mm	9944452
SSP1414 301181314140	Steering Tie Rod End - Front Right	M12x1,5Rht	60806355; 9947438; 9947436
SSP1415 301181314150	Steering Tie Rod End - Front Left	M12x1,5Rht	60806356; 9947439; 9947438
SSP1418 301181314180	Steering Tie Rod End - Front	Only:Alfa 1,9JTD M14x1,5Rht	46527567; 9947926; 9947719



ALFA ROMEO 146 930



1994-2001

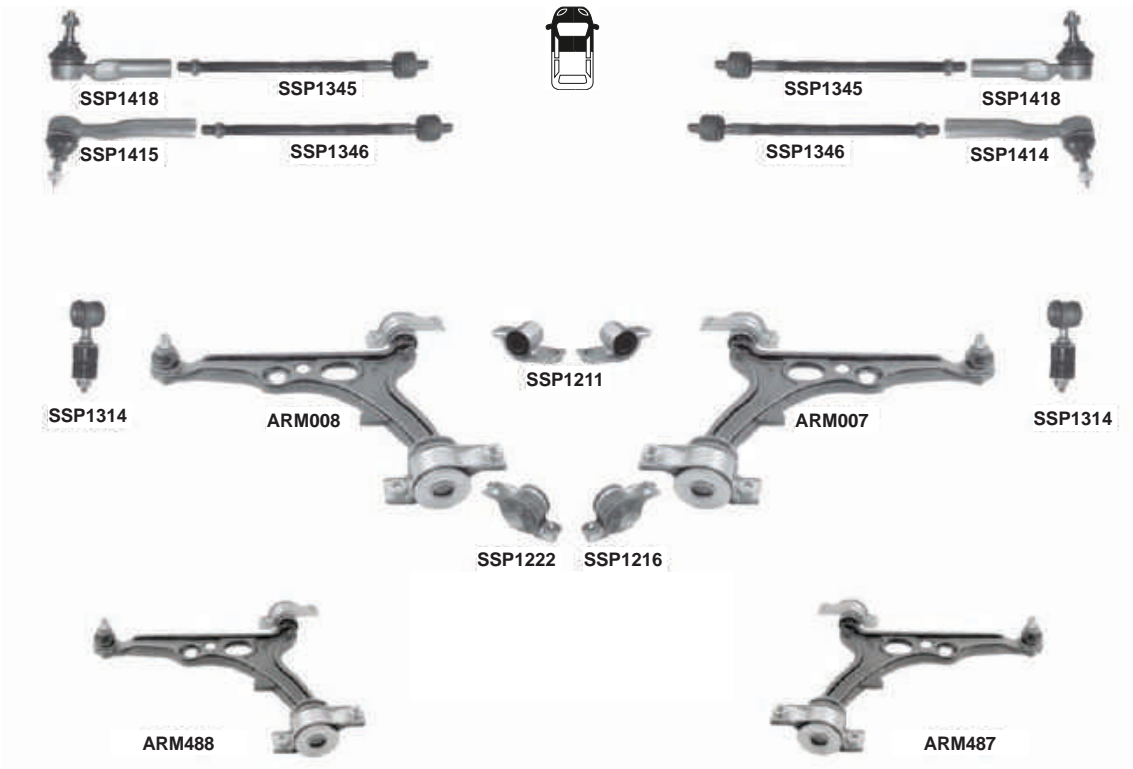

PART NO.	DESCRIPTION	NOTES	O.E.
ARM007 301181300700	Suspension Control Arm and Ball Joint Assembly - Front Right	D=Ø17mm	46456050; 60809814; 60586772
ARM008 301181300800	Suspension Control Arm and Ball Joint Assembly - Front Left Lower	D=Ø17mm	46456049; 60809813; 60586771
ARM487 301181348700	Suspension Control Arm and Ball Joint Assembly - Front Right Lower	Forging D=Ø17mm	60813014; 60813044
ARM488 301181348800	Suspension Control Arm and Ball Joint Assembly - Front Left	Forging D=Ø17mm	60813013; 60813043
SSP1211 301181312110	Bush / Silent block - Track control arm	ARM008 / ARM007 / ARM041 / ARM042 / ARM155 / ARM156 D=Ø20,9mm Center: 83mm	7601064
SSP1216 301181312160	Bush / Silent block - Track control arm - Rear Rh	ARM007 / ARM041 / ARM155	7601065
SSP1222 301181312220	Bush / Silent block - Track control arm - Rear Lh	ARM008 / ARM042 / ARM156	7601068
SSP1314 301181313140	Suspension Stabilizer Bar Link - Front	M10x1,25Rht - L=114mm	12574521; 7601643; 7601642; 60570627
SSP1345 301181313450	Steering Tie Rod - Front Inner	Only:2.0 lt H.D M12x1,5 - L=267mm	9947361
SSP1346 301181313460	Steering Tie Rod - Front Inner	Power Steering M12x1,5 Rht - L=285mm	9944452
SSP1414 301181314140	Steering Tie Rod End - Front Right	M12x1,5Rht	60806355; 9947438; 9947436
SSP1415 301181314150	Steering Tie Rod End - Front Left	M12x1,5Rht	60806356; 9947439; 9947438
SSP1418 301181314180	Steering Tie Rod End - Front	Only:Alfa 1,9JTD M14x1,5Rht	46527567; 9947926; 9947719



ALFA ROMEO 147 937



11/2000-03/2010

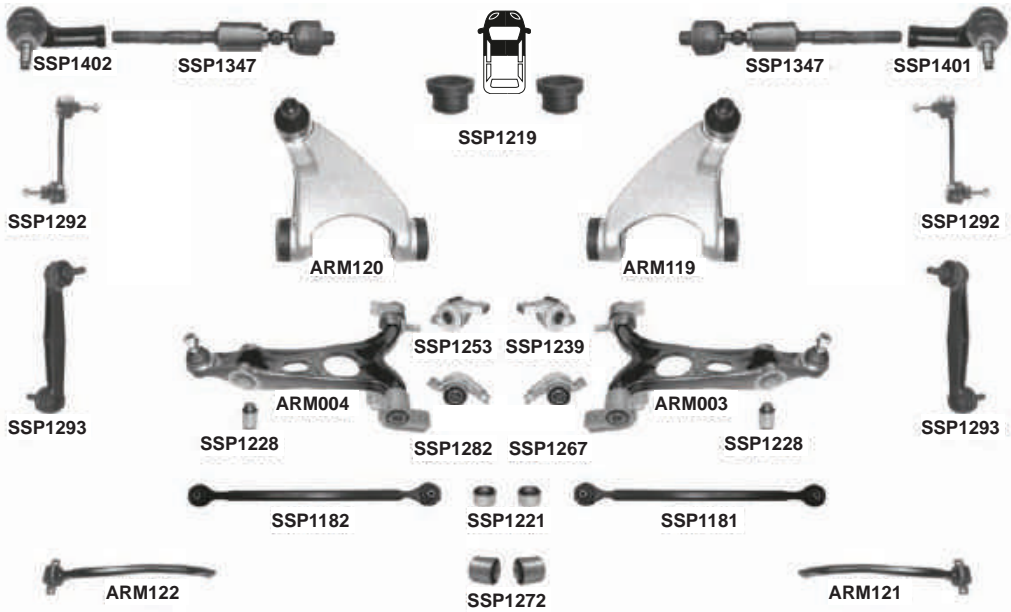

PART NO.	DESCRIPTION	NOTES	O.E.
ARM003 301181300300	Suspension Control Arm and Ball Joint Assembly - Front Right Lower		50509339; 60686892; 60652466; 60678135
ARM004 301181300400	Suspension Control Arm and Ball Joint Assembly - Front Left Lower		50509340; 60686891; 60652465; 60678134
ARM119 301181311900	Suspension Control Arm and Ball Joint Assembly - Front Right Upper		51834094; 60651940; 60657246
ARM120 301181312000	Suspension Control Arm and Ball Joint Assembly - Front Left Upper		51834093; 60651939; 60657245
ARM121 301181312100	Lateral Arm - Rear Right		60622624; 60651934
ARM122 301181312200	Lateral Arm - Rear Left		60622623; 60651935
SSP1181 301181311810	Lateral Arm - Rear Center	Rear Axle - Front L=560 mm	46802682; 60629903
SSP1182 301181311820	Lateral Arm - Rear Rearward	Rear Axle - Rear L=592 mm	46802680; 60652167
SSP1219 301181312190	Bush / Silent block - Track control arm - Upper	ARM119 / ARM120 / ARM127 / ARM128	
SSP1221 301181312210	Stabilizer link bush - Rear	SSP1181 / SSP1182	
SSP1228 301181312280	Bush / Silent block - Track control arm	ARM003 / ARM004	
SSP1239 301181312390	Bush / Silent block - Track control arm - Rh	ARM003 / ARM019 Outer	
SSP1253 301181312530	Bush / Silent block - Track control arm - Lh	ARM004 / ARM020 Outer	
SSP1267 301181312670	Bush / Silent block - Track control arm - Lower - Rh	ARM003 Inner	60620565
SSP1272 301181312720	Bush / Silent block - Track control arm rear		60682636, 82315794
SSP1282 301181312820	Bush / Silent block - Track control arm - Lower Lh	ARM004 Inner	60620566
SSP1292 301181312920	Suspension Stabilizer Bar Link - Front	Metal L=124mm	60625029
SSP1293 301181312930	Suspension Stabilizer Bar Link - Rear	Plastic(Clip-on patented design) L=180 mm	60613575
SSP1347 301181313470	Steering Tie Rod - Front	M14x1,5Rht - L=204mm	9947923
SSP1401 301181314010	Steering Tie Rod End - Front Right	M14x1,5Rht	9947920
SSP1402 301181314020	Steering Tie Rod End - Front Left	M14x1,5Rht	9947919
SSP2031 301191620310	Suspension Stabilizer Bar Link - Front	Metal (Clip-on patented design) L=124mm	46843389; 60625029



ALFA ROMEO 155 167



1992-1998



PART NO.	DESCRIPTION	NOTES	O.E.
ARM007 301181300700	Suspension Control Arm and Ball Joint Assembly - Front Right	D=Ø17mm	46456050; 60809814; 60586772
ARM008 301181300800	Suspension Control Arm and Ball Joint Assembly - Front Left Lower	D=Ø17mm	46456049; 60809813; 60586771
ARM487 301181348700	Suspension Control Arm and Ball Joint Assembly - Front Right Lower	Forging D=Ø17mm	60813014; 60813044
ARM488 301181348800	Suspension Control Arm and Ball Joint Assembly - Front Left	Forging D=Ø17mm	60813013; 60813043
SSP1314 301181313140	Suspension Stabilizer Bar Link - Front	M10x1,25Rht - L=114mm	12574521; 7601643; 7601642; 60570627
SSP1345 301181313450	Steering Tie Rod - Front Inner	Only:2.0 lt H.D M12x1,5 - L=267mm	9947361
SSP1346 301181313460	Steering Tie Rod - Front Inner	Power Steering M12x1,5 Rht - L=285mm	9944452
SSP1398 301181313980	Steering Tie Rod End - Front Right Outer	M12x1,5Rth	60565705; 7678717
SSP1399 301181313990	Steering Tie Rod End - Front Left Outer	M12x1,5Rth	60565706; 9947437; 7678718; 9947435



ALFA ROMEO 156 932



09/1997-05/2006

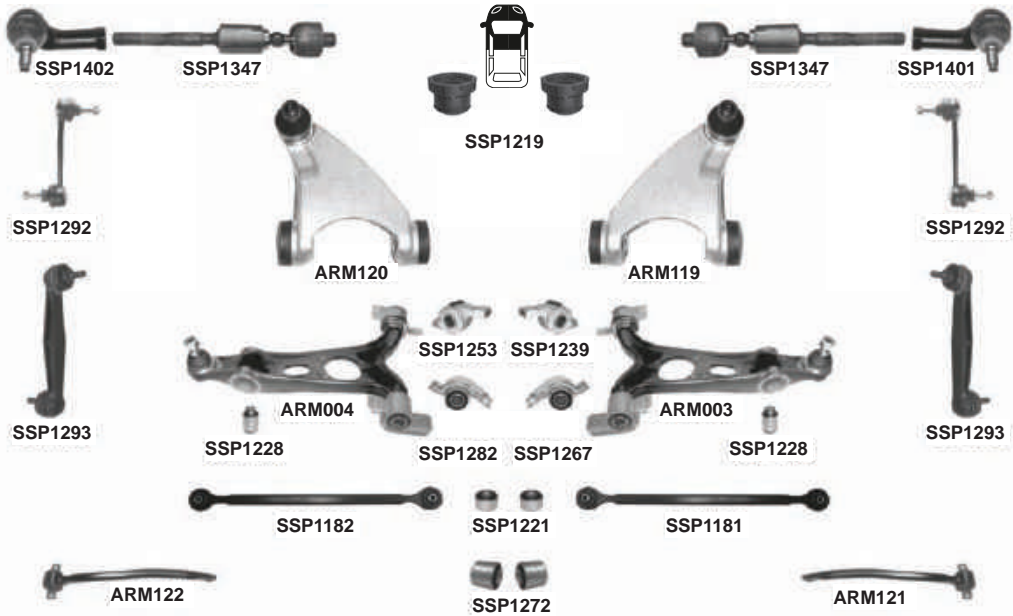

PART NO.	DESCRIPTION	NOTES	O.E.
ARM003 301181300300	Suspension Control Arm and Ball Joint Assembly - Front Right Lower		50509339; 60686892; 60652466; 60678135
ARM004 301181300400	Suspension Control Arm and Ball Joint Assembly - Front Left Lower		50509340; 60686891; 60652465; 60678134
ARM119 301181311900	Suspension Control Arm and Ball Joint Assembly - Front Right Upper		51834094; 60651940; 60657246
ARM120 301181312000	Suspension Control Arm and Ball Joint Assembly - Front Left Upper		51834093; 60651939; 60657245
ARM121 301181312100	Lateral Arm - Rear Right		60622624; 60651934
ARM122 301181312200	Lateral Arm - Rear Left		60622623; 60651935
SSP1181 301181311810	Lateral Arm - Rear Center	Rear Axle - Front L=560 mm	46802682; 60629903
SSP1182 301181311820	Lateral Arm - Rear Rearward	Rear Axle - Rear L=592 mm	46802680; 60652167
SSP1219 301181312190	Bush / Silent block - Track control arm - Upper	ARM119 / ARM120 / ARM127 / ARM128	
SSP1221 301181312210	Stabilizer link bush - Rear	SSP1181 / SSP1182	
SSP1228 301181312280	Bush / Silent block - Track control arm	ARM003 / ARM004	
SSP1239 301181312390	Bush / Silent block - Track control arm - Rh	ARM003 / ARM019 Outer	
SSP1253 301181312530	Bush / Silent block - Track control arm - Lh	ARM004 / ARM020 Outer	
SSP1267 301181312670	Bush / Silent block - Track control arm - Lower - Rh	ARM003 Inner	60620565
SSP1272 301181312720	Bush / Silent block - Track control arm rear		60682636; 82315794
SSP1282 301181312820	Bush / Silent block - Track control arm - Lower Lh	ARM004 Inner	60620566
SSP1292 301181312920	Suspension Stabilizer Bar Link - Front	Metal L=124mm	60625029
SSP1293 301181312930	Suspension Stabilizer Bar Link - Rear	Plastic(Clip-on patented design) L=180 mm	60613575
SSP1347 301181313470	Steering Tie Rod - Front	M14x1,5Rht - L=204mm	9947923
SSP1401 301181314010	Steering Tie Rod End - Front Right	M14x1,5Rht	9947920
SSP1402 301181314020	Steering Tie Rod End - Front Left	M14x1,5Rht	9947919
SSP2031 301191620310	Suspension Stabilizer Bar Link - Front	Metal (Clip-on patented design) L=124mm	46843389; 60625029



ALFA ROMEO 159 939



09/2005-11/2011

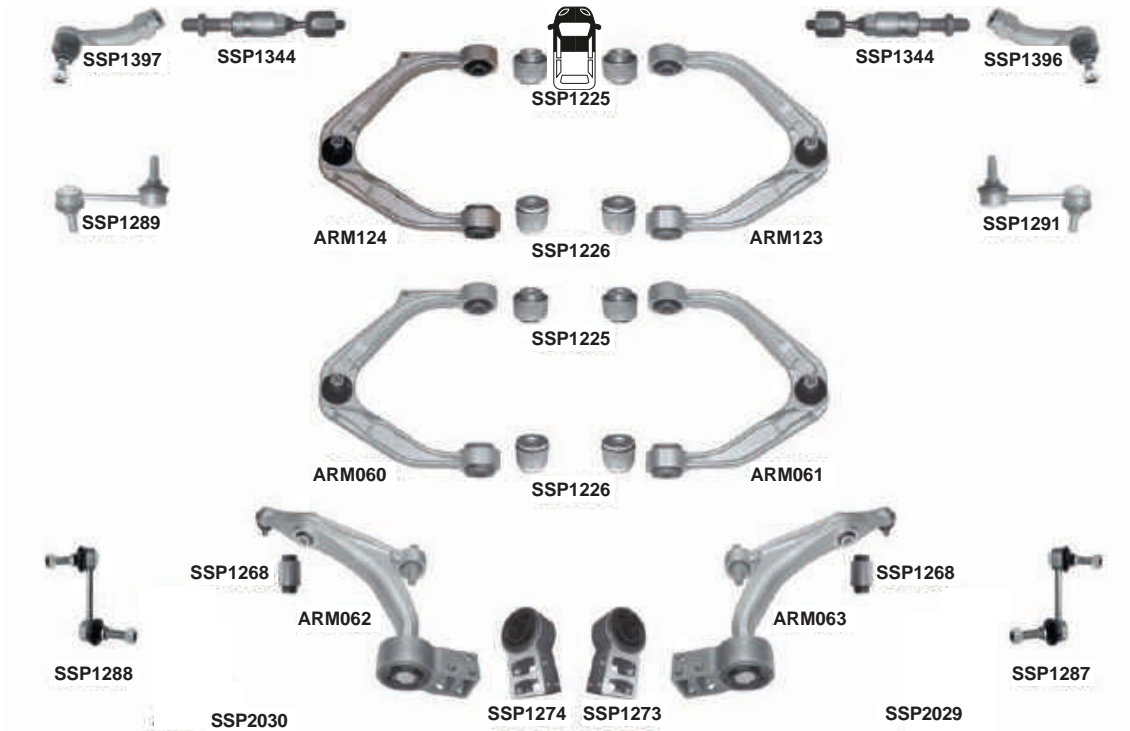

PART NO.	DESCRIPTION	NOTES	O.E.
ARM060	301181306000 Suspension Control Arm and Ball Joint Assembly - Front Left Upper	Ø11.2 mm	51828661; 51835397
ARM061	301181306100 Suspension Control Arm and Ball Joint Assembly - Front Right Upper	Ø11.2 mm	51828660; 51835398
ARM062	301181306200 Suspension Control Arm and Ball Joint Assembly - Front Left Lower		50704306; 51795447; 50706858; 50707316
ARM063	301181306300 Suspension Control Arm and Ball Joint Assembly - Front Right Lower		50704307; 51795446; 50706859; 50707317
ARM123	301181312300 Suspension Control Arm and Ball Joint Assembly - Front Right Upper	Ø12.7mm	50704480; 50704948; 51787336
ARM124	301181312400 Suspension Control Arm and Ball Joint Assembly - Front Left Upper	Ø12.7mm	50704947; 50707481; 51787337
SSP1225	301181312250 Bush / Silent block - Track control arm - Upper	ARM060 / ARM061 / ARM123 / ARM124	
SSP1226	301181312260 Bush / Silent block - Track control arm - Upper	ARM060 / ARM061 / ARM123 / ARM124	
SSP1268	301181312680 Bush / Silent block - Track control arm	ARM062 / ARM063	
SSP1273	301181312730 Bush / Silent block - Track control arm - Lower - Rh	ARM063	50706955, 5070872
SSP1274	301181312740 Bush / Silent block - Track control arm - Lower - Lh	ARM062	50706954, 5070871
SSP1287	301181312870 Suspension Stabilizer Bar Link - Rear Right	L=116mm	50705703; 50705712; 51706474
SSP1288	301181312880 Suspension Stabilizer Bar Link - Rear Left	L=116mm	50704702; 50705311; 51795705
SSP1289	301181312890 Suspension Stabilizer Bar Link - Front Left	L=102mm	50704361; 50706990; 51795454
SSP1291	301181312910 Suspension Stabilizer Bar Link - Front Right	L=102mm	50704362; 50706991; 51795455
SSP1344	301181313440 Steering Tie Rod - Front	M20x1,5 - L=230.5mm	77363706*; 77363707*
SSP1396	301181313960 Steering Tie Rod End - Front Right	M20x1,5	77363707
SSP1397	301181313970 Steering Tie Rod End - Front Left	M20x1,5	77363706
SSP2029	301191620290 Suspension Stabilizer Bar Link - Rear Right	(Clip-on patented design) L=116mm	50705703
SSP2030	301191620300 Suspension Stabilizer Bar Link - Rear Left	(Clip-on patented design) L=116mm	50705702



ALFA ROMEO 166 936

 09/1998-06/2007

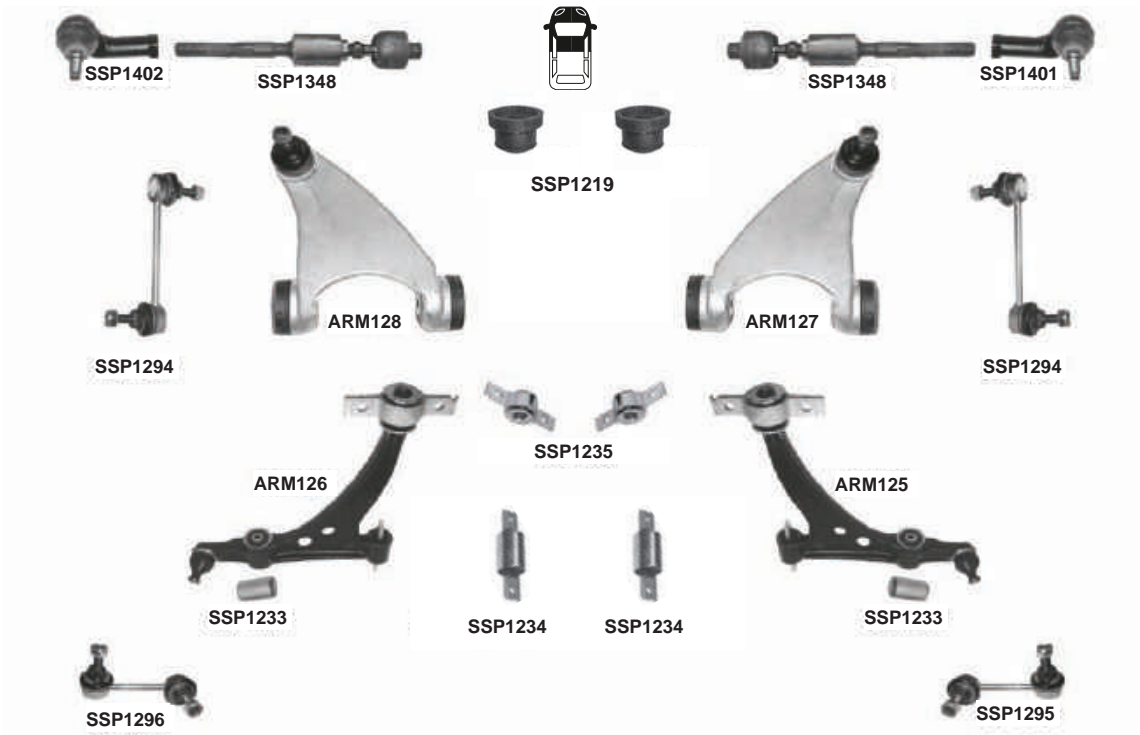

PART NO.	DESCRIPTION	NOTES	O.E.
ARM125 301181312500	Track control arm lower Rh	SSP1233 / SSP1234 / SSP1235	60627291, 60665805
ARM126 301181312600	Track control arm lower Lh	SSP1233 / SSP1234 / SSP1235	60627290, 60665804
ARM127 301181312700	Track control arm upper Rh		60666020
ARM128 301181312800	Track control arm upper Lh		60653551
SSP1219 301181312190	Bush / Silent block - Track control arm - Upper	ARM119/ARM120/ARM128/ARM127	
SSP1233 301181312330	Bush / Silent block - Track control arm - Lower	ARM125 / ARM126	
SSP1234 301181312340	Bush / Silent block - Track control arm	ARM125 / ARM126	
SSP1235 301181312350	Bush / Silent block - Track control arm - Lower	ARM125 / ARM126	
SSP1294 301181312940	Stabilizer link front	L=145mm	60630757
SSP1295 301181312950	Stabilizer link rear Rh	L=95mm	60628255
SSP1296 301181312960	Stabilizer link rear Lh	L=95mm	60628284
SSP1348 301181313480	Axial joint	M14x1,5Rht - L=218,5mm	9948297
SSP1401 301181314010	Tie rod end Rh	M14x1,5Rht	9947920
SSP1402 301181314020	Tie rod end Lh	M14x1,5Rht	9947919



ALFA ROMEO GIULIETTA 940



04/2010-

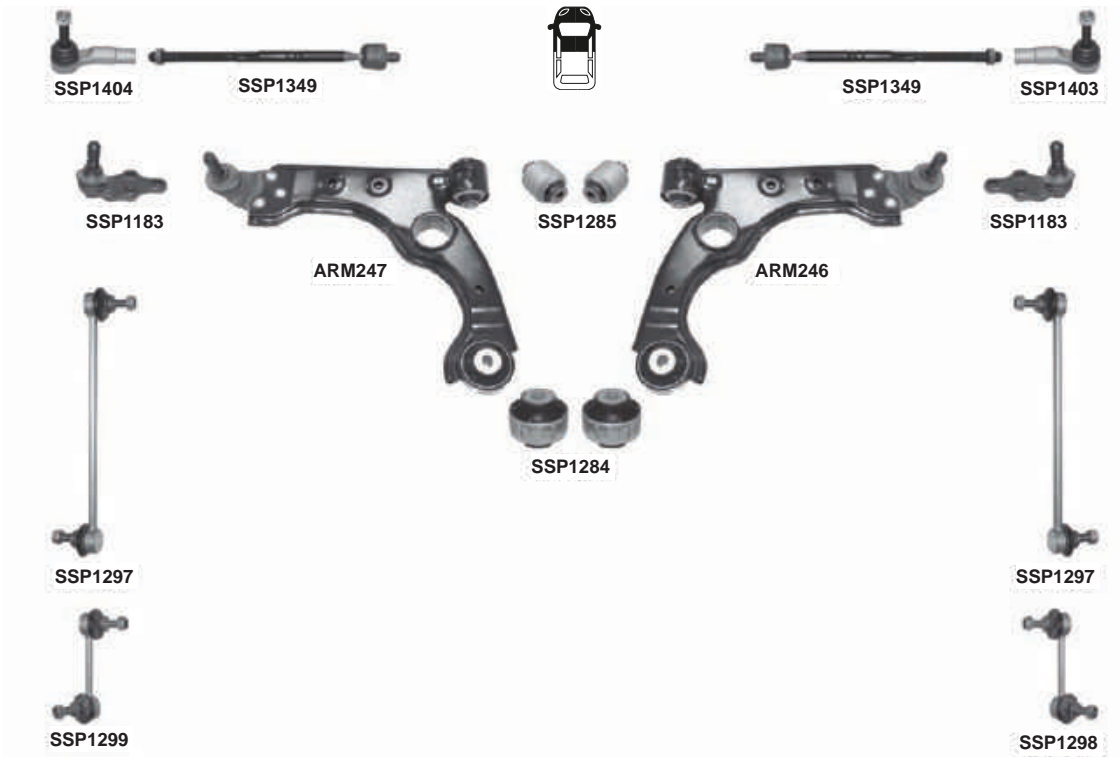

PART NO.	DESCRIPTION	NOTES	O.E.
ARM246 301181324600	Suspension Control Arm and Ball Joint Assembly - Front Right Lower	CH:-> 7034561	50513442
ARM247 301181324700	Suspension Control Arm and Ball Joint Assembly - Front Left Lower	CH:-> 7034561	50513444
SSP1183 301181311830	Suspension Ball Joint - Front Lower		-
SSP1284 301181312840	Bush / Silent block - Track control arm - Lower	ARM098 / ARM099	50521047, 51805863
SSP1285 301181312850	Bush / Silent block - Track control arm - Lower	ARM098 / ARM099	50521045, 51805862
SSP1297 301181312970	Suspension Stabilizer Bar Link - Front	L=298mm	50515276; 51805870
SSP1298 301181312980	Suspension Stabilizer Bar Link - Rear Right	L=113mm	50515275; 51806609; 51978679
SSP1299 301181312990	Suspension Stabilizer Bar Link - Rear Left	L=113mm	50515274; 51806608; 51978680
SSP1349 301181313490	Steering Tie Rod - Front	M16X1,5 - L=330mm	50521639; 50526421; 50521026; 50519427
SSP1403 301181314030	Steering Tie Rod End - Front Right	M16X1,5	50520353
SSP1404 301181314040	Steering Tie Rod End - Front Left	M16X1,5	50520352

ALFA ROMEO GT 937



11/2003-09/2010

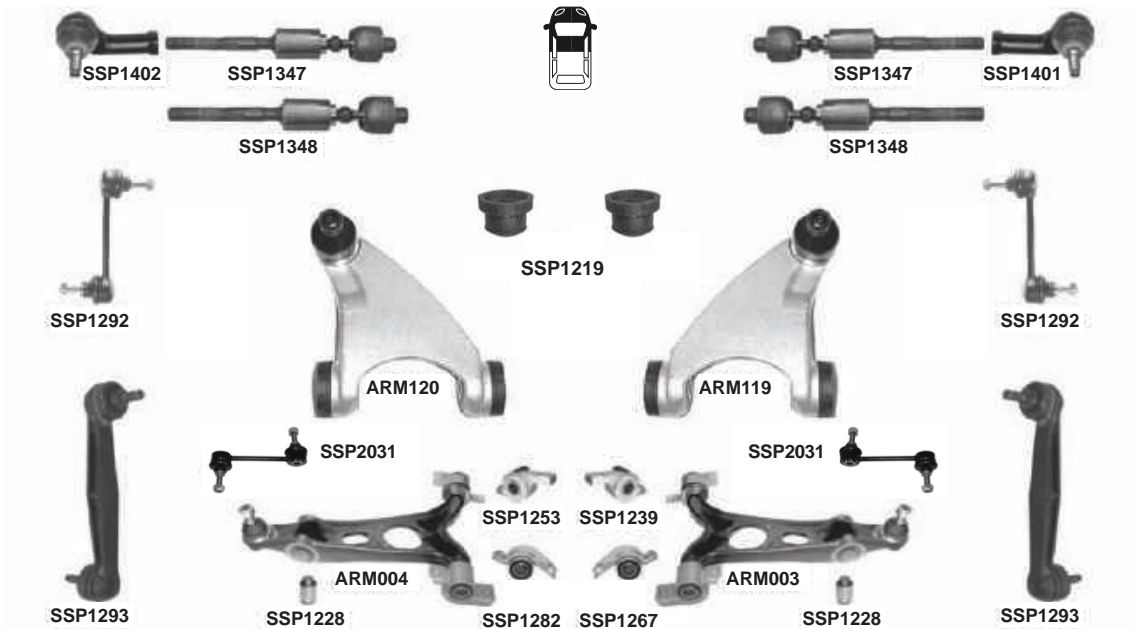

PART NO.	DESCRIPTION	NOTES	O.E.
ARM003 301181300300	Suspension Control Arm and Ball Joint Assembly - Front Right Lower		50509339; 60686892; 60652466; 60678135
ARM004 301181300400	Suspension Control Arm and Ball Joint Assembly - Front Left Lower		50509340; 60686891; 60652465; 60678134
ARM119 301181311900	Suspension Control Arm and Ball Joint Assembly - Front Right Upper		51834094; 60651940; 60657246
ARM120 301181312000	Suspension Control Arm and Ball Joint Assembly - Front Left Upper		51834093; 60651939; 60657245
SSP1219 301181312190	Bush / Silent block - Track control arm - Upper	ARM119/ARM120/ARM127/ARM128	
SSP1228 301181312280	Bush / Silent block - Track control arm	ARM003 / ARM004	
SSP1239 301181312390	Bush / Silent block - Track control arm - Rh	ARM003 / ARM019 Outer	
SSP1253 301181312530	Bush / Silent block - Track control arm - Lh	ARM004 / ARM020 Outer	
SSP1267 301181312670	Bush / Silent block - Track control arm - Lower - Rh	ARM003 Inner	60620565
SSP1282 301181312820	Bush / Silent block - Track control arm - Lower Lh	ARM004 Inner	60620566
SSP1292 301181312920	Suspension Stabilizer Bar Link - Front	Metal L=124mm	60625029
SSP1293 301181312930	Suspension Stabilizer Bar Link - Rear	Plastic L=180 mm	60613575
SSP1347 301181313470	Steering Tie Rod - Front	M14x1,5Rht - L=204mm	9947923
SSP1348 301181313480	Steering Tie Rod - Front Inner	M14x1,5Rht - L=218.5 mm	9948297
SSP1401 301181314010	Steering Tie Rod End - Front Right	M14x1,5Rht	9947920
SSP1402 301181314020	Steering Tie Rod End - Front Left	M14x1,5Rht	9947919
SSP2031 301191620310	Suspension Stabilizer Bar Link - Front	Metal(Clip-on patented design) L=124mm	46843389; 60625029



ALFA ROMEO GTV 916



1995-2005

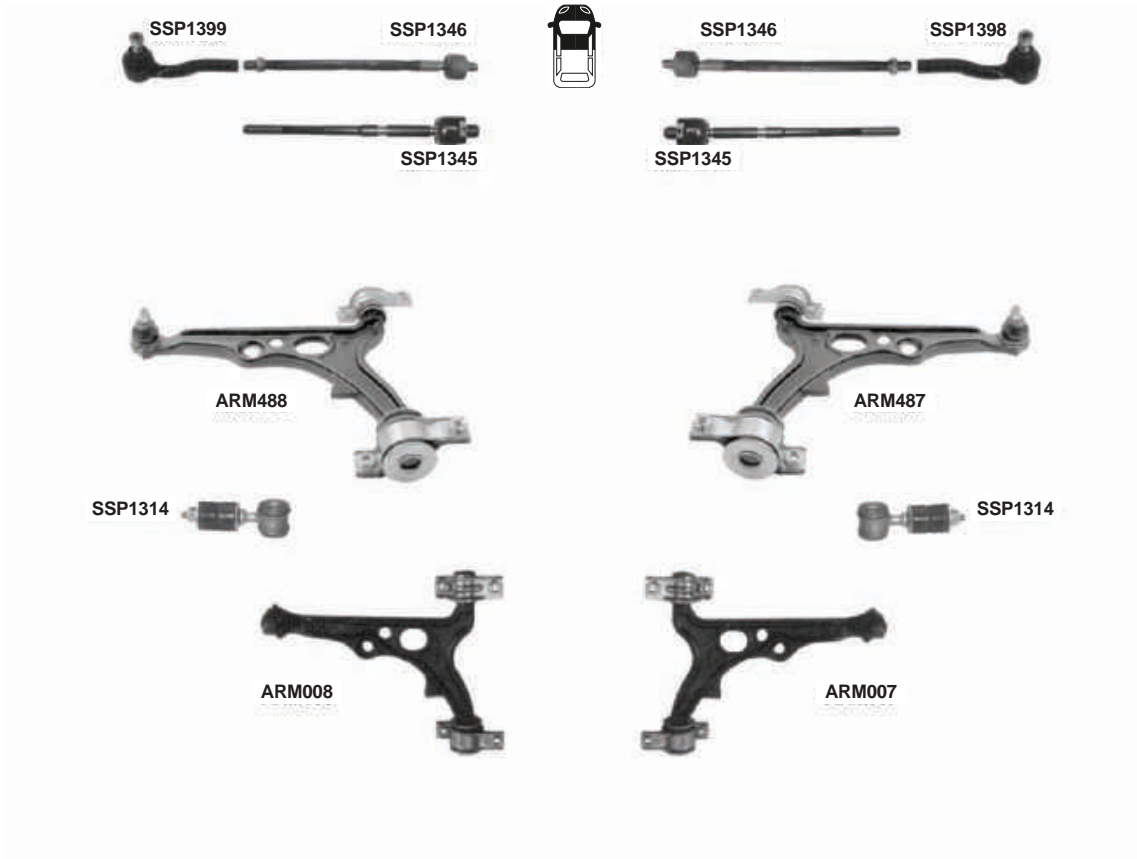

	PART NO.	DESCRIPTION	NOTES	O.E.
ARM007	301181300700	Suspension Control Arm and Ball Joint Assembly - Front Right	D=Ø17mm	46456050; 60809814; 60586772
ARM008	301181300800	Suspension Control Arm and Ball Joint Assembly - Front Left Lower	D=Ø17mm	46456049; 60809813; 60586771
ARM487	301181348700	Suspension Control Arm and Ball Joint Assembly - Front Right Lower	Forging D=Ø17mm	60813014; 60813044
ARM488	301181348800	Suspension Control Arm and Ball Joint Assembly - Front Left	Forging D=Ø17mm	60813013; 60813043
SSP1314	301181313140	Suspension Stabilizer Bar Link - Front	M10x1,25Rht - L=114mm	12574521; 7601643; 7601642; 60570627
SSP1345	301181313450	Steering Tie Rod - Front Inner	Only:2.0 lt H.D M12x1,5 - L=267mm	9947361
SSP1346	301181313460	Steering Tie Rod - Front Inner	Power Steering M12x1,5 Rht - L=285mm	9944452
SSP1398	301181313980	Steering Tie Rod End - Front Right Outer	M12x1,5Rth	60565705; 7678717
SSP1399	301181313990	Steering Tie Rod End - Front Left Outer	M12x1,5Rth	60565706; 9947437; 7678718; 9947435



ALFA ROMEO MITO



09/2008-

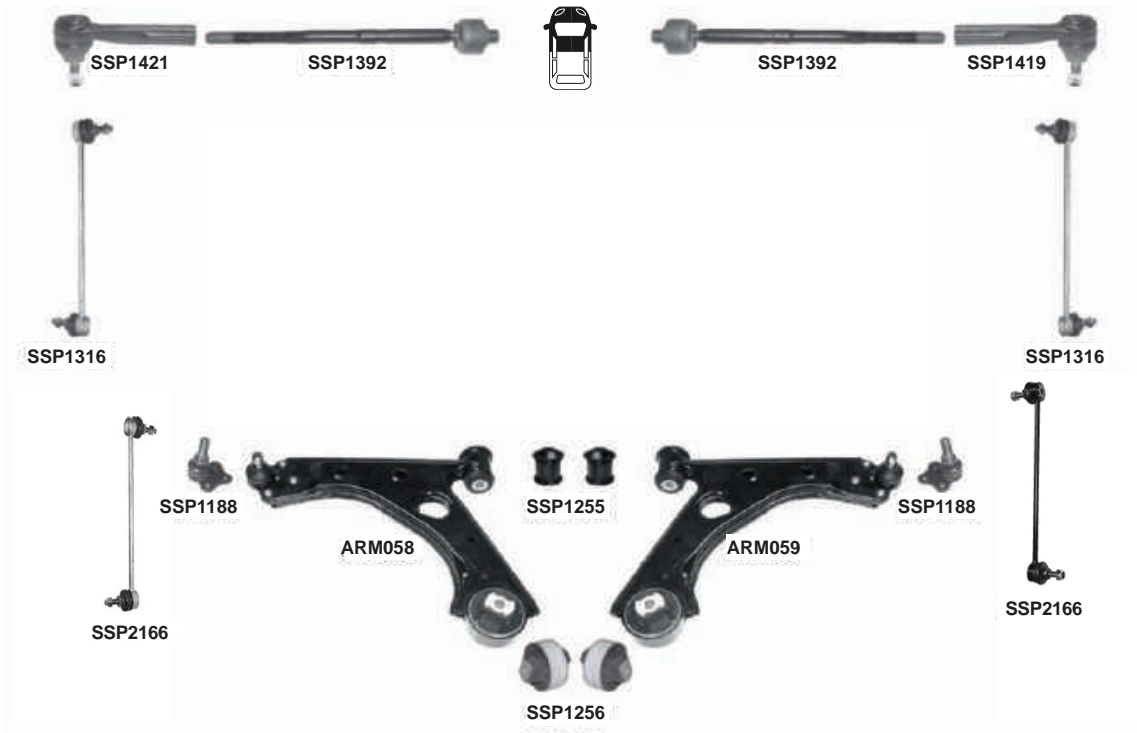

PART NO.	DESCRIPTION	NOTES	O.E.
ARM058 301181305800	Suspension Control Arm and Ball Joint Assembly - Front Left Lower		3520.W3; 55703629; 51895367; 51783057; 3520.Y4
ARM059 301181305900	Suspension Control Arm and Ball Joint Assembly - Front Right Lower		3521.S6; 55703627; 51895366; 51783056; 3521V5
SSP1188 301181311880	Suspension Ball Joint - Front		3520.87; 93190907; 51783057; 51783056; 3520.W3
SSP1255 301181312550	Bush / Silent block - Track control arm	ARM058 / ARM059 / ARM115 / ARM116	352380, 55703232
SSP1256 301181312560	Bush / Silent block - Track control arm - Rear	ARM058 / ARM059	55700751
SSP1316 301181313160	Suspension Stabilizer Bar Link - Front	L=300mm	350616; 55700753; 50515276
SSP1392 301181313920	Steering Tie Rod - Front	M14x1,5 - L=289mm	1603543; 93189022
SSP1419 301181314190	Steering Tie Rod End - Front Right	M14x1,5Rht	1603545; 77363830; 1609458
SSP1421 301181314210	Steering Tie Rod End - Front Left	M14x1,5Rht	1603544; 77363829; 1609457
SSP2166 301191621660	Suspension Stabilizer Bar Link - Front	(Clip-on patented design) L=300mm	55700753

**ALFA ROMEO SPIDER 916**

1994-2005



PART NO.	DESCRIPTION	NOTES	O.E.
ARM007 301181300700	Suspension Control Arm and Ball Joint Assembly - Front Right	D=Ø17mm	46456050; 60809814; 60586772
ARM008 301181300800	Suspension Control Arm and Ball Joint Assembly - Front Left Lower	D=Ø17mm	46456049; 60809813; 60586771
ARM487 301181348700	Suspension Control Arm and Ball Joint Assembly - Front Right Lower	Forging D=Ø17mm	60813014; 60813044
ARM488 301181348800	Suspension Control Arm and Ball Joint Assembly - Front Left	Forging D=Ø17mm	60813013; 60813043
SSP1314 301181313140	Suspension Stabilizer Bar Link - Front	M10x1,25Rht - L=114mm	12574521; 7601643; 7601642; 60570627
SSP1345 301181313450	Steering Tie Rod - Front Inner	Only:2.0 lt H.D M12x1,5 - L=267mm	9947361
SSP1346 301181313460	Steering Tie Rod - Front Inner	Power Steering M12x1,5 Rht - L=285mm	9944452
SSP1398 301181313980	Steering Tie Rod End - Front Right Outer	M12x1,5Rth	60565705; 7678717
SSP1399 301181313990	Steering Tie Rod End - Front Left Outer	M12x1,5Rth	60565706; 9947437; 7678718; 9947435



AUDI 80



1979-1986



SSP0282



SSP0282

PART NO.	DESCRIPTION	NOTES	O.E.
SSP0282 301191602820	Steering Tie Rod End - Front	M14x1,5Rht	811419812A; 811419812B



MAGNETI
MARELLI

AUDI 80



1987-1991



PART NO.	DESCRIPTION	NOTES	O.E.
SSP0282 301191602820	Steering Tie Rod End - Front	M14x1,5Rht	811419812A; 811419812B



AUDI 80



1992-1994

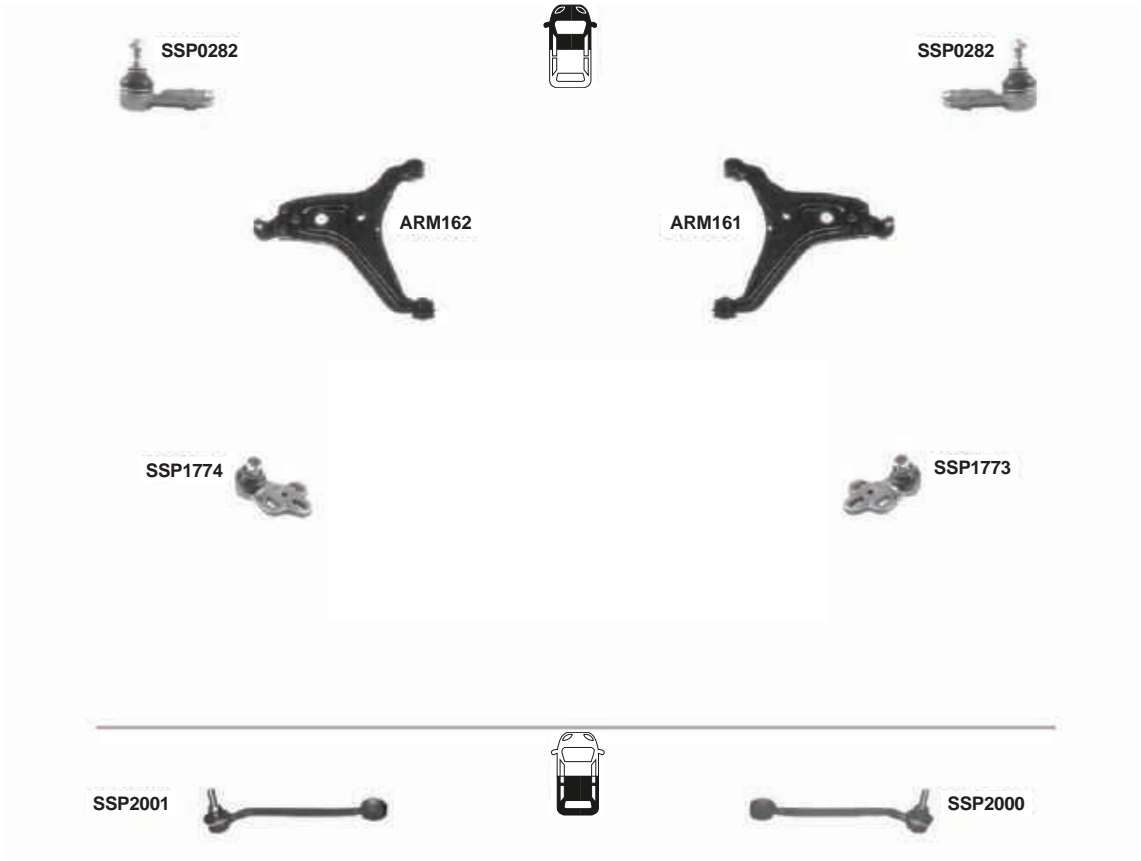

PART NO.	DESCRIPTION	NOTES	O.E.
ARM161 301181316100	Suspension Control Arm and Ball Joint Assembly - Front Right Lower		895407148A
ARM162 301181316200	Suspension Control Arm and Ball Joint Assembly - Front Left Lower		895407147A
SSP0282 301191602820	Steering Tie Rod End - Front	M14x1,5Rht	811419812A; 811419812B
SSP1773 301191617730	Suspension Ball Joint - Front Left Lower	D=Ø19mm	894407365E; 8A0407365
SSP1774 301191617740	Suspension Ball Joint - Front Right Lower	D=Ø19mm	894407366E; 8A0407366
SSP2000 301191620000	Suspension Stabilizer Bar Link - Rear Right	L=227,5mm	8A0505466C; 8D0505466
SSP2001 301191620010	Suspension Stabilizer Bar Link - Rear Left	L=227,5mm	8A0505465C; 8D0505465



AUDI 90



1980-1986



SSP0282



SSP0282

PART NO.	DESCRIPTION	NOTES	O.E.
SSP0282 301191602820	Steering Tie Rod End - Front	M14x1,5Rht	811419812A; 811419812B



AUDI 90



1987-1991



SSP0282



SSP0282

PART NO.	DESCRIPTION	NOTES	O.E.
SSP0282 301191602820	Steering Tie Rod End - Front	M14x1,5Rht	811419812A; 811419812B

**AUDI 90**

1992-1994

**SSP0282****SSP0282****ARM162****ARM161****SSP1774****SSP1773****SSP2001****SSP2000**

PART NO.	DESCRIPTION	NOTES	O.E.
ARM161 301181316100	Suspension Control Arm and Ball Joint Assembly - Front Right Lower		895407148A
ARM162 301181316200	Suspension Control Arm and Ball Joint Assembly - Front Left Lower		895407147A
SSP0282 301191602820	Steering Tie Rod End - Front	M14x1,5Rht	811419812A; 811419812B
SSP1773 301191617730	Suspension Ball Joint - Front Left Lower	D=Ø19mm	894407365E; 8A0407365
SSP1774 301191617740	Suspension Ball Joint - Front Right Lower	D=Ø19mm	894407366E; 8A0407366
SSP2000 301191620000	Suspension Stabilizer Bar Link - Rear Right	L=227,5mm	8A0505466C; 8D0505466
SSP2001 301191620010	Suspension Stabilizer Bar Link - Rear Left	L=227,5mm	8A0505465C; 8D0505465

AUDI A1 8X1

 04/2010-



PART NO.	DESCRIPTION	NOTES	O.E.
SSP0013 301191600130	Steering Tie Rod - Front	(8XA, 8XF, 8XK) L=312mm / M14x1.5	6C0423810A; 6C0423810B; 6C0423810C
SSP0276 301191602760	Steering Tie Rod - Front	M14x1,5 - L=313mm	6R0423810; 8Z0419810C
SSP0283 301191602830	Steering Tie Rod End - Front Right	M14x1,5 Rht	1J0422812B; 6R0423812A; 6Q0419812; 1J0422812R; 3A0422812B
SSP0284 301191602840	Steering Tie Rod End - Front Left	M14x1,5 Rht	1J0422811B; 6R0423811A; 6Q0419811; 1J0422811R; 3A0422811B
SSP1963 301191619630	Suspension Ball Joint - Front Right Lower		5U0407366A; 6R0407366
SSP1964 301191619640	Suspension Ball Joint - Front Left Lower		5U0407365A; 6R0407365
SSP2028 301191620280	Suspension Stabilizer Bar Link - Front	L=270mm	6Q0411315N

**AUDI A2**

02/2000-08/2005

**SSP0664****SSP0012****SSP0012****SSP0663****SSP0276****SSP0276****SSP2006****SSP2006**

PART NO.	DESCRIPTION	NOTES	O.E.
SSP0012 301191600120	Steering Tie Rod - Front	Power Steering	8Z0423803/804F Part of
SSP0276 301191602760	Steering Tie Rod - Front	M14x1,5 - L=313mm	6R0423810; 8Z0419810C
SSP0663 301191606630	Steering Tie Rod End - Front Right Outer	M14x1,5Rht	6Q0423812; 8Z0423812A; 6Q0423812D
SSP0664 301191606640	Steering Tie Rod End - Front Left Outer	M14x1,5Rht	6Q0423811; 8Z0423811A; 6Q0423811D
SSP2006 301191620060	Suspension Stabilizer Bar Link - Front	L=58mm	8Z0411315C; 8Z0411315D



AUDI A3 8L1



09/1996-05/2003



**AUDI A3 8L1**

09/1996-05/2003

PART NO.	DESCRIPTION	NOTES	O.E.
ARM169	301181316900 Lateral Arm - Rear		1J0505323L; 1J0505323E; 1J0505323H; 1J0505323M
ARM182	301181318200 Suspension Control Arm and Ball Joint Assembly - Front Right Lower		1J0407151B
ARM183	301181318300 Suspension Control Arm and Ball Joint Assembly - Front Left Lower		1J0407151A
ARM184	301181318400 Suspension Control Arm and Ball Joint Assembly - Front Upper		4D0407505A; 4D0407505D; 4D0407505F
ARM1039	301181310390 Lateral Arm - Rear Lower		1K0505311AA; 1K0505311S; 1K0505311AB
SSP0003	301191600030 Steering Tie Rod - Front Inner	Ch.8L-W-050-423 -> M14x1,5 - L=320mm	1J0422807; 1J0422807A
SSP0005	301191600050 Steering Tie Rod - Front	Ch.No:-> 8L-W-050-422 M14x1,5 Rht - L=338mm	1J0422821A
SSP0283	301191602830 Steering Tie Rod End - Front Right	Ch.8L-W-050-423 -> M14x1,5 Rht	1J0422812B; 6R0423812A; 6Q0419812; 1J0422812R; 3A0422812B
SSP0284	301191602840 Steering Tie Rod End - Front Left	Ch.8L-W-050-423 -> M14x1,5 Rht	1J0422811B; 6R0423811A; 6Q0419811; 1J0422811R; 3A0422811B
SSP0285	301191602850 Steering Tie Rod End - Front Right Outer	Rht Ch. >>8L-W-050-422 M14x1,5	1J0422812A; 1J0422812L
SSP0286	301191602860 Steering Tie Rod End - Front Left Outer	Rht Ch. >>8L-W-050-422 M14x1,5	1J0422811A; 1J0422811L
SSP1775	301191617750 Suspension Ball Joint - Front Lower	A3-S3 quattro	8N0407365A; 8N0407365B; 8N0407365C
SSP1776	301191617760 Suspension Ball Joint - Front Right Lower		1J0407366A; 1J0407366B; 1J0407366C
SSP1777	301191617770 Suspension Ball Joint - Front Right Lower	Kit	1J0407366A/B/C*
SSP1778	301191617780 Suspension Ball Joint - Front Left Lower		1J0407365A; 1J0407365D; 1J0407365B; 1J0407365C
SSP1779	301191617790 Suspension Ball Joint - Front Left Lower	Kit	1J0407366A/B/C*
SSP2002	301191620020 Suspension Stabilizer Bar Link - Front Left	4 Motion L=336mm	1J0411315D
SSP2003	301191620030 Suspension Stabilizer Bar Link - Front Left	4 Motion (Clip-on patented design) L=336mm	1J0411315D
SSP2004	301191620040 Suspension Stabilizer Bar Link - Front Right	4 Motion L=336mm	1J0411316D
SSP2023	301191620230 Suspension Stabilizer Bar Link - Rear	Audi 1.8 quattro L=175mm	1J0505466B
SSP2571	301191625710 Suspension Stabilizer Bar Link - Front	Plastic L=105,5mm	1J0411315C
SSP2572	301191625720 Suspension Stabilizer Bar Link - Front	Metal L=105mm	1J0411315H; 1J0422315G



AUDI A3 8P1

06/2003-08/2012

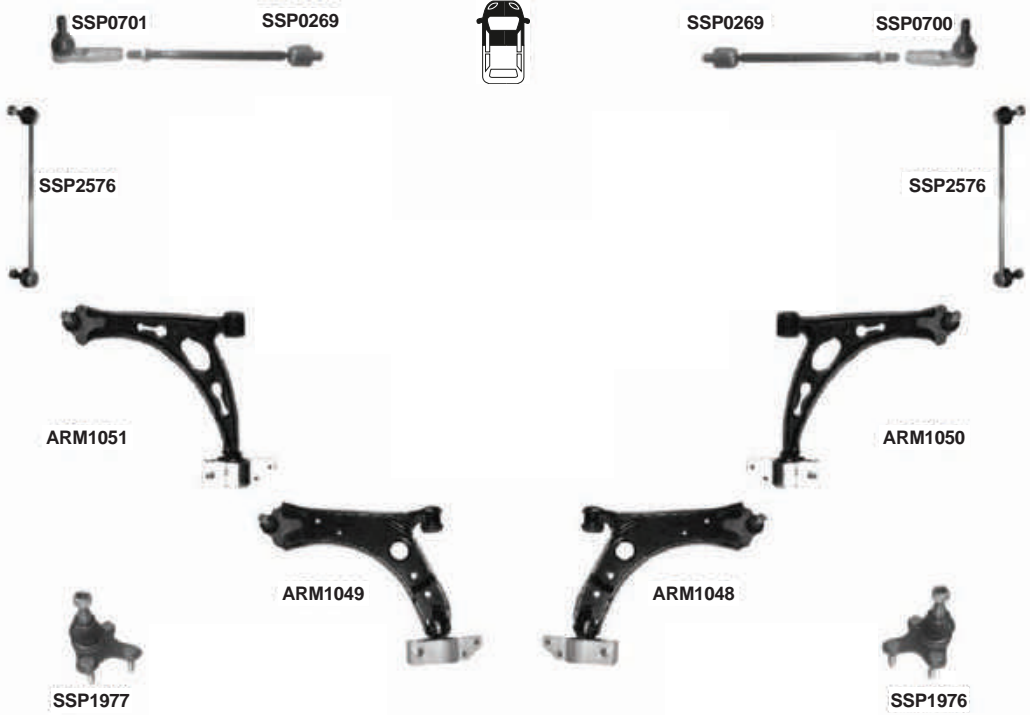



AUDI A3 8P1

 06/2003-08/2012



ARM189



ARM189



ARM1057



ARM1057



ARM983



ARM982



ARM1038



ARM1037



ARM1055



ARM1054



SSP2577



SSP2577



ARM988



ARM988





AUDI A3 8P1



06/2003-08/2012

PART NO.	DESCRIPTION	NOTES	O.E.
ARM189 301181318900	Lateral Arm - Rear Upper		1K0505323N
ARM982 301181398200	Lateral Arm - Rear Right Lower	L=298mm	1K0501530C
ARM983 301181398300	Lateral Arm - Rear Left Lower	L=298mm	1K0501529F
ARM988 301181398800	Lateral Arm - Rear Lower	L=298mm	1K0501529J
SSP0269 301191602690	Steering Tie Rod - Front Inner	M16x1,5 - L=310mm	1K0423810A
ARM1037 301181310370	Lateral Arm - Rear Right Forward		1T0505224F
ARM1038 301181310380	Lateral Arm - Rear Left Forward		1T0505223F
ARM1048 301181310480	Suspension Control Arm and Ball Joint Assembly - Front Right Lower	Only: Petrol	1K0407152P*; 1K0407152Q*
ARM1049 301181310490	Suspension Control Arm and Ball Joint Assembly - Front Left Lower	Only: Petrol	1K0407151P*; 1K0407151Q*
ARM1050 301181310500	Suspension Control Arm and Ball Joint Assembly - Front Right Lower	Only: Diesel	1K0407152AC
ARM1051 301181310510	Suspension Control Arm and Ball Joint Assembly - Front Left Lower	Only: Diesel	1K0407151AC
ARM1054 301181310540	Lateral Arm - Rear Right Forward		1K0505224K
ARM1055 301181310550	Lateral Arm - Rear Left Forward		1K0505223K
ARM1057 301181310570	Lateral Arm - Rear Upper		5Q0505323C; 5Q0505323D
SSP0700 301191607000	Steering Tie Rod End - Front Right	M16x1,5Rht	1K0423812A; 1K0423812J; 1K0423812K; 1K0423812G; 1K0423812E
SSP0701 301191607010	Steering Tie Rod End - Front Left	M16x1,5Rht	1K0423811A; 1K0423811J; 1K0423811K; 1K0423811G; 1K0423811E
SSP1976 301191619760	Suspension Ball Joint - Front Right Lower		1K0407366B; 5Q0407366A; 1K0407366E; 1K0407366C
SSP1977 301191619770	Suspension Ball Joint - Front Left Lower		1K0407365B; 5Q0407365A; 1K0407365E; 1K0407365C
SSP2576 301191625760	Suspension Stabilizer Bar Link - Front	L=335mm	1K0411315B; 1K0411315D; 1K0411315J
SSP2577 301191625770	Suspension Stabilizer Bar Link - Rear	L=95,5 mm	1K0505465C; 1K0505465J; 1K0505465K; 1K0505465H; 1K0505465D



AUDI A3 8V1



09/2012-



PART NO.	DESCRIPTION	NOTES	O.E.
ARM167 301181316700	Suspension Control Arm and Ball Joint Assembly - Front Right Lower		5Q0407152J
ARM168 301181316800	Suspension Control Arm and Ball Joint Assembly - Front Left Lower		5Q0407151J
ARM1057 301181310570	Lateral Arm - Rear Upper		5Q0505323C; 5Q0505323D
SSP0269 301191602690	Steering Tie Rod - Front Inner	M16x1,5 - L=310mm	1K0423810A
SSP0700 301191607000	Steering Tie Rod End - Front Right	M16x1,5Rht	1K0423812A; 1K0423812J; 1K0423812K; 1K0423812G; 1K0423812E
SSP0701 301191607010	Steering Tie Rod End - Front Left	M16x1,5Rht	1K0423811A; 1K0423811J; 1K0423811K; 1K0423811G; 1K0423811E
SSP1976 301191619760	Suspension Ball Joint - Front Right Lower		1K0407366B; 5Q0407366A; 1K0407366E; 1K0407366C
SSP1977 301191619770	Suspension Ball Joint - Front Left Lower		1K0407365B; 5Q0407365A; 1K0407365E; 1K0407365C
SSP2537 301191625370	Suspension Stabilizer Bar Link - Front	L=335mm	500411315B
SSP2579 301191625790	Suspension Stabilizer Bar Link - Rear	L=70mm	5Q0505465C; 5Q0505465A



AUDI A4 8D2, 8E5, B5



11/1994-10/2001

PART NO.	DESCRIPTION	NOTES	O.E.
ARM170	301181317000 Suspension Control Arm and Ball Joint Assembly - Front Right Upper Rearward		4D0407510D; 4D0407510J
ARM172	301181317200 Suspension Control Arm and Ball Joint Assembly - Front Left Upper Rearward		4D0407509D; 4D0407509J
ARM174	301181317400 Suspension Control Arm and Ball Joint Assembly - Front Right Upper Forward		8D0407506B; 8D0407506H
ARM176	301181317600 Suspension Control Arm and Ball Joint Assembly - Front Left Upper Forward		8D0407505B; 8D0407505H
ARM178	301181317800 Suspension Control Arm and Ball Joint Assembly - Front Right Lower Rearward		4D0407694M; 8E0407694; 4D0407694N; 8E0407693K
ARM178	301181317800 Suspension Control Arm and Ball Joint Assembly - Front Right Lower Rearward		4D0407694M; 8E0407694; 4D0407694N; 8E0407693K
ARM179	301181317900 Suspension Control Arm and Ball Joint Assembly - Front Left Lower		4D0407693M; 8E0407693K; 4D0407693N; 8E0407693
ARM180	301181318000 Suspension Control Arm and Ball Joint Assembly - Front Lower Forward	D=∅ 20,6mm	4D0407151G; 8E0407151N; 4D0407151H; 4D0407151J
ARM185	301181318500 Lateral Arm - Rear		8D0501530
SSP0004	301191600040 Steering Tie Rod - Front	M 14x1.5 Rht - L=119,5mm	4B0422821; 4D0422821
SSP0287	301191602870 Steering Tie Rod End - Front	Ch.-> 8D-W-260192 -> 8D-W-152089 M14x1,5Rht	4B0419811E; 4D0419811A; 4D0419811B; 8E0419811B
SSP2000	301191620000 Suspension Stabilizer Bar Link - Rear Right	L=227,5mm	8A0505466C; 8D0505466
SSP2001	301191620010 Suspension Stabilizer Bar Link - Rear Left	L=227,5mm	8A0505465C; 8D0505465
SSP2005	301191620050 Suspension Stabilizer Bar Link - Front	L=86mm	4D0411317G; 4D0411317J; 4D0411317K
SSP2007	301191620070 Suspension Stabilizer Bar Link - Front Right	With Bolts And Nuts L=90mm	8D0407318D; 8D0411318D
SSP2008	301191620080 Suspension Stabilizer Bar Link - Front Left	With Bolts And Nuts L=90mm	8D0407317D; 8D0411317D
SSP2009	301191620090 Suspension Stabilizer Bar Link - Front	With Bolts And Nuts L=90mm	4D0411317K



AUDI A4 8E2, 8E5, B6

 12/2001-12/2004

SSP0004



SSP0004



SSP2015



ARM173



ARM177



ARM179



ARM181



ARM171



ARM175



ARM178



ARM181



SSP2014



SSP2016



ARM215



SSP2017



ARM214



SSP2016



SSP2017





AUDI A4 8E2, 8E5, B6



12/2001-12/2004

PART NO.	DESCRIPTION	NOTES	O.E.
ARM171	301181317100 Suspension Control Arm and Ball Joint Assembly - Front Right Upper Rearward	Ch. 8D-W-006471 >Ch. 8D-X-200001 >	4D0407510F; 4D0407510G
ARM173	301181317300 Suspension Control Arm and Ball Joint Assembly - Front Left Upper Rearward	Ch. 8D-W-006471 > Ch. 8D-X-200001 >	4D0407509F; 4D0407509G
ARM175	301181317500 Suspension Control Arm and Ball Joint Assembly - Front Right Upper Forward	Ch. 8D-W-006471 > 8D-X-200001 >	8D0407506A; 8E0407506A; 8D0407506B; 8D0407506F
ARM177	301181317700 Suspension Control Arm and Ball Joint Assembly - Front Left Upper Forward	Ch. 8D-W-006471 > 8D-X-200001 >	8D0407505A; 8E0407505A
ARM178	301181317800 Suspension Control Arm and Ball Joint Assembly - Front Right Lower Rearward		4D0407694M; 8E0407694; 4D0407694N; 8E0407693K
ARM179	301181317900 Suspension Control Arm and Ball Joint Assembly - Front Left Lower		4D0407693M; 8E0407693K; 4D0407693N; 8E0407693
ARM181	301181318100 Suspension Control Arm and Ball Joint Assembly - Front Lower Forward	D=16,30mm 1/6	8E0407151M
ARM214	301181321400 Lateral Arm - Rear Right Upper Rearward		8E0505324M; 3R0505324
ARM215	301181321500 Lateral Arm - Rear Left Upper Rearward		8E0505323M; 3R0505323
SSP0004	301191600040 Steering Tie Rod - Front	M 14x1,5 Rht - L=119,5mm	4B0422821; 4D0422821
SSP2014	301191620140 Suspension Stabilizer Bar Link - Front Right		8E0411318
SSP2015	301191620150 Suspension Stabilizer Bar Link - Front Left		8E0411317
SSP2016	301191620160 Suspension Stabilizer Bar Link - Rear	L=90mm	8E0505465A; 8E0505465T; 8E0505465F; 8E0505465K
SSP2017	301191620170 Suspension Stabilizer Bar Link - Rear	(Clip-on patented design) L=90mm	8E0505465AFK



AUDI A4 8EC, 8ED

 11/2004-06/2008

SSP0292



SSP0004



SSP0004



SSP0292



ARM173



ARM171



SSP2015



SSP2014



ARM180



ARM180



ARM215



ARM214



ARM186



ARM186





AUDI A4 8EC, 8ED



11/2004-06/2008

PART NO.	DESCRIPTION	NOTES	O.E.
ARM171	301181317100 Suspension Control Arm and Ball Joint Assembly - Front Right Upper Rearward	Ch. 8D-W-006471 >Ch. 8D-X-200001 >	4D0407510F; 4D0407510G
ARM173	301181317300 Suspension Control Arm and Ball Joint Assembly - Front Left Upper Rearward	Ch. 8D-W-006471 > Ch. 8D-X-200001 >	4D0407509F; 4D0407509G
ARM180	301181318000 Suspension Control Arm and Ball Joint Assembly - Front Lower Forward	D=Ø 20,6mm	4D0407151G; 8E0407151N; 4D0407151H; 4D0407151J
ARM186	301181318600 Lateral Arm - Rear	L=337mm	8E0501529F; 8E0501529P; 8E0501529G; 8E0501529K
ARM214	301181321400 Lateral Arm - Rear Right Upper Rearward		8E0505324M; 3R0505324
ARM215	301181321500 Lateral Arm - Rear Left Upper Rearward		8E0505323M; 3R0505323
ARM216	301181321600 Suspension Control Arm and Ball Joint Assembly - Front Right Lower Rearward	(Chassis from 8H7000001>)	8E0407694AL; 8E0407694T
ARM217	301181321700 Suspension Control Arm and Ball Joint Assembly - Front Left Lower Rearward	(Chassis from 8H7000001>)	8E0407693AL; 8E0407693T
SSP0004	301191600040 Steering Tie Rod - Front	M 14x1.5 Rht - L=119,5mm	4B0422821; 4D0422821
SSP0292	301191602920 Steering Tie Rod End - Front	M14x1,5 Rht	4F0419811C; 8E0419811; 4F0419811D; 4F0419811G
SSP2014	301191620140 Suspension Stabilizer Bar Link - Front Right		8E0411318
SSP2015	301191620150 Suspension Stabilizer Bar Link - Front Left		8E0411317



AUDI A4 8K2, 8K5



11/2007-06/2015





AUDI A4 8K2, 8K5



11/2007-06/2015

PART NO.	DESCRIPTION	NOTES	O.E.
ARM186	301181318600 Lateral Arm - Rear	L=337mm	8E0501529F; 8E0501529P; 8E0501529G; 8E0501529K
ARM190	301181319000 Lateral Arm - Rear Right	L=282,5mm	8K0501530N
ARM191	301181319100 Lateral Arm - Rear Left	L=282,5mm	8K0501529N
ARM192	301181319200 Suspension Control Arm - Front Right Lower Forward		8K0407152B
ARM193	301181319300 Suspension Control Arm - Front Left Lower Forward		8K0407151B
ARM194	301181319400 Suspension Control Arm and Ball Joint Assembly - Front Right Lower Rearward		8K0407694F; 8K0407694N
ARM195	301181319500 Suspension Control Arm and Ball Joint Assembly - Front Left Lower Rearward		8K0407693F; 8K0407693N
ARM196	301181319600 Suspension Control Arm and Ball Joint Assembly - Front Right Upper Forward		8K0407506A
ARM197	301181319700 Suspension Control Arm and Ball Joint Assembly - Front Left Upper Forward		8K0407505A
ARM198	301181319800 Suspension Control Arm and Ball Joint Assembly - Front Right Upper Rearward		8K0407510A
ARM199	301181319900 Suspension Control Arm and Ball Joint Assembly - Front Left Upper Rearward		8K0407509A
ARM200	301181320000 Lateral Arm - Rear Lower Forward		8K0501529L
ARM203	301181320300 Suspension Control Arm and Ball Joint Assembly - Front Right Lower Rearward	Ch:8K,8T	8K0407694T; 8K0407694S
ARM204	301181320400 Suspension Control Arm and Ball Joint Assembly - Front Left Lower Rearward	Ch:8K,8T	8K0407693T; 8K0407693S
ARM205	301181320500 Suspension Control Arm - Front Right Lower		8K0407152F; 8K0407152G
ARM206	301181320600 Suspension Control Arm - Front Left Lower		8K0407151F; 8K0407151G
SSP0006	301191600060 Steering Tie Rod - Front	M16X1,5 - L=225mm	8J0423810
SSP0288	301191602880 Steering Tie Rod End - Front Right Outer	M16X1,5	8K0422818A; 8K0422818B
SSP0289	301191602890 Steering Tie Rod End - Front Left Outer	M16X1,5	8K0422817A; 8K0422817B
SSP1780	301191617800 Suspension Ball Joint - Front Lower		8K0407689E; 8K0407689F
SSP1783	301191617830 Suspension Ball Joint - Front Lower		4G0407689C
SSP2022	301191620220 Suspension Stabilizer Bar Link - Front	L=170mm	8K0411317C; 8K0411317E
SSP2024	301191620240 Suspension Stabilizer Bar Link - Front		8K0411317B
SSP2027	301191620270 Suspension Stabilizer Bar Link - Front	L=170mm	4G0411317A; 4G0411317C



AUDI A5 8T3



2007-2015





AUDI A5 8T3



2007-2015

PART NO.	DESCRIPTION	NOTES	O.E.
ARM190	301181319000 Lateral Arm - Rear Right	L=282,5mm	8K0501530N
ARM191	301181319100 Lateral Arm - Rear Left	L=282,5mm	8K0501529N
ARM192	301181319200 Suspension Control Arm - Front Right Lower Forward		8K0407152B
ARM193	301181319300 Suspension Control Arm - Front Left Lower Forward		8K0407151B
ARM194	301181319400 Suspension Control Arm and Ball Joint Assembly - Front Right Lower Rearward		8K0407694F; 8K0407694N
ARM195	301181319500 Suspension Control Arm and Ball Joint Assembly - Front Left Lower Rearward		8K0407693F; 8K0407693N
ARM196	301181319600 Suspension Control Arm and Ball Joint Assembly - Front Right Upper Forward		8K0407506A
ARM197	301181319700 Suspension Control Arm and Ball Joint Assembly - Front Left Upper Forward		8K0407505A
ARM198	301181319800 Suspension Control Arm and Ball Joint Assembly - Front Right Upper Rearward		8K0407510A
ARM199	301181319900 Suspension Control Arm and Ball Joint Assembly - Front Left Upper Rearward		8K0407509A
ARM200	301181320000 Lateral Arm - Rear Lower Forward		8K0501529L
ARM203	301181320300 Suspension Control Arm and Ball Joint Assembly - Front Right Lower Rearward	Ch:8K,8T	8K0407694T; 8K0407694S
ARM204	301181320400 Suspension Control Arm and Ball Joint Assembly - Front Left Lower Rearward	Ch:8K,8T	8K0407693T; 8K0407693S
ARM205	301181320500 Suspension Control Arm - Front Right Lower		8K0407152F; 8K0407152G
ARM206	301181320600 Suspension Control Arm - Front Left Lower		8K0407151F; 8K0407151G
SSP0006	301191600060 Steering Tie Rod - Front	M16X1,5 - L=225mm	8J0423810
SSP0288	301191602880 Steering Tie Rod End - Front Right Outer	M16X1,5	8K0422818A; 8K0422818B
SSP0289	301191602890 Steering Tie Rod End - Front Left Outer	M16X1,5	8K0422817A; 8K0422817B
SSP1780	301191617800 Suspension Ball Joint - Front Lower		8K0407689E; 8K0407689F
SSP1783	301191617830 Suspension Ball Joint - Front Lower		4G0407689C
SSP2022	301191620220 Suspension Stabilizer Bar Link - Front	L=170mm	8K0411317C; 8K0411317E
SSP2024	301191620240 Suspension Stabilizer Bar Link - Front		8K0411317B
SSP2027	301191620270 Suspension Stabilizer Bar Link - Front	L=170mm	4G0411317A; 4G0411317C



AUDI A6 4A, 4C



1994-1997



PART NO.	DESCRIPTION	NOTES	O.E.
SSP2011 301191620110	Suspension Stabilizer Bar Link - Rear		4D0505465D



AUDI A6 4B, C5

01/1997-01/2005

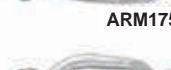



AUDI A6 4B, C5



01/1997-01/2005

PART NO.	DESCRIPTION	NOTES	O. E.
ARM170	301181317000 Suspension Control Arm and Ball Joint Assembly - Front Right Upper Rearward		4D0407510D; 4D0407510J
ARM171	301181317100 Suspension Control Arm and Ball Joint Assembly - Front Right Upper Rearward	Ch. 8D-W-006471 > Ch. 8D-X-200001 >	4D0407510F; 4D0407510G
ARM172	301181317200 Suspension Control Arm and Ball Joint Assembly - Front Left Upper Rearward		4D0407509D; 4D0407509J
ARM173	301181317300 Suspension Control Arm and Ball Joint Assembly - Front Left Upper Rearward	Ch. 8D-W-006471 > Ch. 8D-X-200001 >	4D0407509F; 4D0407509G
ARM174	301181317400 Suspension Control Arm and Ball Joint Assembly - Front Right Upper Forward		8D0407506B; 8D0407506H
ARM175	301181317500 Suspension Control Arm and Ball Joint Assembly - Front Right Upper Forward	Ch. 8D-W-006471 > 8D-X-200001 >	8D0407506A; 8E0407506A; 8D0407506B; 8D0407506F
ARM176	301181317600 Suspension Control Arm and Ball Joint Assembly - Front Left Upper Forward		8D0407505B; 8D0407505H
ARM177	301181317700 Suspension Control Arm and Ball Joint Assembly - Front Left Upper Forward	Ch. 8D-W-006471 > 8D-X-200001 >	8D0407505A; 8E0407505A
ARM178	301181317800 Suspension Control Arm and Ball Joint Assembly - Front Right Lower Rearward		4D0407694M; 8E0407694; 4D0407694N; 8E0407693K
ARM179	301181317900 Suspension Control Arm and Ball Joint Assembly - Front Left Lower		4D0407693M; 8E0407693K; 4D0407693N; 8E0407693
ARM180	301181318000 Suspension Control Arm and Ball Joint Assembly - Front Lower Forward	D=Ø 20,6mm	4D0407151G; 8E0407151N; 4D0407151H; 4D0407151J
ARM181	301181318100 Suspension Control Arm and Ball Joint Assembly - Front Lower Forward	D=16,30mm 1/6	8E0407151M
ARM200	301181320000 Lateral Arm - Rear Lower Forward		8K0501529L
SSP0004	301191600040 Steering Tie Rod - Front	M 14x1.5 Rht - L=119,5mm	4B0422821; 4D0422821
SSP0287	301191602870 Steering Tie Rod End - Front	Ch.-> 8D-W-260192 -> 8D-W-152089 M14x1,5Rht	4B0419811E; 4D0419811A; 4D0419811B; 8E0419811B
SSP2005	301191620050 Suspension Stabilizer Bar Link - Front	L=86mm	4D0411317G; 4D0411317J; 4D0411317K
SSP2007	301191620070 Suspension Stabilizer Bar Link - Front Right	With Bolts And Nuts L=90mm	8D0407318D; 8D0411318D
SSP2008	301191620080 Suspension Stabilizer Bar Link - Front Left	With Bolts And Nuts L=90mm	8D0407317D; 8D0411317D
SSP2009	301191620090 Suspension Stabilizer Bar Link - Front	With Bolts And Nuts L=90mm	4D0411317K



AUDI A6 4F2, C6



02/2005-03/2011



SSP0292 SSP0008



SSP0008 SSP0292



SSP2020



SSP2020

ARM208



ARM209



ARM210



ARM207



ARM213



ARM213



ARM212



ARM211



ARM218



ARM218



SSP2021



SSP2019



SSP2019



SSP2021



AUDI A6 4F2, C6



02/2005-03/2011

PART NO.	DESCRIPTION	NOTES	O.E.
ARM207	301181320700 Suspension Control Arm and Ball Joint Assembly - Front Right Upper Rearward		4E0407510B
ARM208	301181320800 Suspension Control Arm and Ball Joint Assembly - Front Left Upper Rearward		4E0407509B
ARM209	301181320900 Suspension Control Arm and Ball Joint Assembly - Front Right Upper Forward		4E0407506B
ARM210	301181321000 Suspension Control Arm and Ball Joint Assembly - Front Left Upper Forward		4E0407505B
ARM211	301181321100 Suspension Control Arm and Ball Joint Assembly - Front Right Lower		4F0407694; 4F0407694B; 4F0407694C
ARM212	301181321200 Suspension Control Arm and Ball Joint Assembly - Front Left Lower		4F0407693; 4F0407693B; 4F0407693C
ARM213	301181321300 Suspension Control Arm and Ball Joint Assembly - Front Lower		4F0407151; 4F0407151A
ARM218	301181321800 Lateral Arm - Rear		4F0501529C; 4F0501529E
SSP0008	301191600080 Steering Tie Rod - Front	M14x1,5 Rht - L=139.5 mm	4F0422821
SSP0292	301191602920 Steering Tie Rod End - Front	M14x1,5 Rht	4F0419811C; 8E0419811; 4F0419811D; 4F0419811G
SSP2019	301191620190 Suspension Stabilizer Bar Link - Rear	L=100 mm	4F0505465N
SSP2020	301191620200 Suspension Stabilizer Bar Link - Front	L=110mm	4E0411317C; 4E0411317D; 4E0411317E
SSP2021	301191620210 Suspension Stabilizer Bar Link - Rear	L=100 mm	4F0505465P



AUDI A6 4G2, C5



04/2011-



ARM230



ARM229



ARM232



ARM231



SSP2027



SSP2027



SSP2025



SSP2025



ARM228



ARM227



SSP1783

ARM234



SSP1783

ARM233



ARM236



ARM235



ARM191



ARM190



ARM200



ARM200



AUDI A6 4G2, C5



04/2011-

	PART NO.	DESCRIPTION	NOTES	O.E.
ARM190	301181319000	Lateral Arm - Rear Right	L=282,5mm	8K0501530N
ARM191	301181319100	Lateral Arm - Rear Left	L=282,5mm	8K0501529N
ARM200	301181320000	Lateral Arm - Rear Lower Forward		8K0501529L
ARM227	301181322700	Suspension Control Arm and Ball Joint Assembly - Front Right Lower		4G0407694D; 4G0407694J; 4G0407694F; 4G0407694H
ARM228	301181322800	Suspension Control Arm and Ball Joint Assembly - Front Left Lower		4G0407693D; 4G0407693J; 4G0407693F; 4G0407693H
ARM229	301181322900	Suspension Control Arm and Ball Joint Assembly - Front Right Upper Forward		8K0407506M
ARM230	301181323000	Suspension Control Arm and Ball Joint Assembly - Front Left Upper Forward		8K0407505M
ARM231	301181323100	Suspension Control Arm and Ball Joint Assembly - Front Right Upper Rearward		8K0407510M
ARM232	301181323200	Suspension Control Arm and Ball Joint Assembly - Front Left Upper Rearward		8K0407509M
ARM233	301181323300	Suspension Control Arm - Front Right Lower		8K0407152D
ARM234	301181323400	Suspension Control Arm - Front Left Lower		8K0407151D
ARM235	301181323500	Lateral Arm - Rear Right Upper		8K0505324H
ARM236	301181323600	Lateral Arm - Rear Left Upper		8K0505323H
SSP0010	301191600100	Steering Tie Rod - Front	M16x1.5 / L=236	4G0423810A
SSP0293	301191602930	Steering Tie Rod End - Front Right	M16X1,5	4G0423812A
SSP0294	301191602940	Steering Tie Rod End - Front Left	M16X1,5	4G0423811A
SSP1783	301191617830	Suspension Ball Joint - Front Lower		4G0407689C
SSP2025	301191620250	Suspension Stabilizer Bar Link - Front	L=170mm	8K0411317D; 8K0411317E
SSP2027	301191620270	Suspension Stabilizer Bar Link - Front	L=170mm	4G0411317A; 4G0411317C

**AUDI A6 ALLROAD QUATTRO (4BH,C5)** 

2000-2005

**ARM165****ARM165****ARM166****ARM166****ARM164****ARM163**

	PART NO.	DESCRIPTION	NOTES	O.E.
ARM163	301181316300	Suspension Control Arm and Ball Joint Assembly - Front Right Lower Rearward	Aluminium	4Z7407694D
ARM164	301181316400	Suspension Control Arm and Ball Joint Assembly - Front Left Lower Rearward	Aluminium	4Z7407693D
ARM165	301181316500	Suspension Control Arm and Ball Joint Assembly - Front Lower Forward	Aluminium, Chassis no. to: 4B-4-091000	4Z7407151C
ARM166	301181316600	Suspension Control Arm and Ball Joint Assembly - Front Lower Forward	Aluminium, Chassis no. from: 4B-4-091001	4Z7407151G



AUDI A7 4 GA Sportback



10/2010-

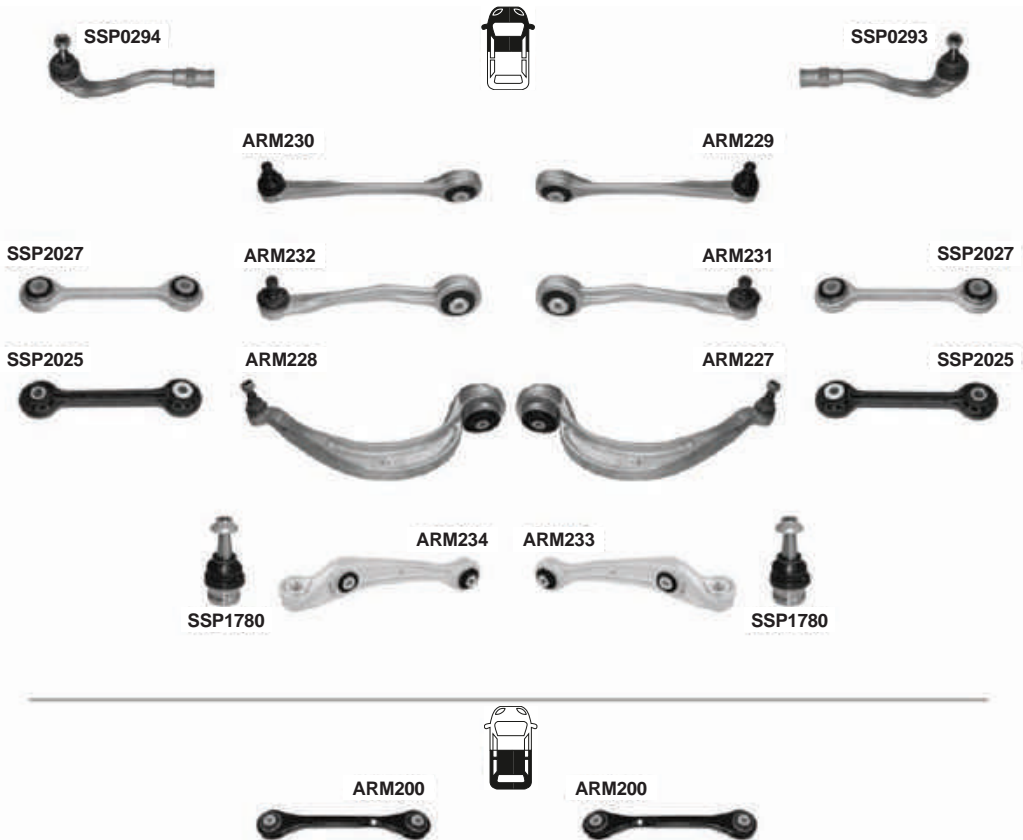

PART NO.	DESCRIPTION	NOTES	O.E.
ARM200 301181320000	Lateral Arm - Rear Lower Forward		8K0501529L
ARM227 301181322700	Suspension Control Arm and Ball Joint Assembly - Front Right Lower		4G0407694D; 4G0407694J; 4G0407694F; 4G0407694H
ARM228 301181322800	Suspension Control Arm and Ball Joint Assembly - Front Left Lower		4G0407693D; 4G0407693J; 4G0407693F; 4G0407693H
ARM229 301181322900	Suspension Control Arm and Ball Joint Assembly - Front Right Upper Forward		8K0407506M
ARM230 301181323000	Suspension Control Arm and Ball Joint Assembly - Front Left Upper Forward		8K0407505M
ARM231 301181323100	Suspension Control Arm and Ball Joint Assembly - Front Right Upper Rearward		8K0407510M
ARM232 301181323200	Suspension Control Arm and Ball Joint Assembly - Front Left Upper Rearward		8K0407509M
ARM233 301181323300	Suspension Control Arm - Front Right Lower		8K0407152D
ARM234 301181323400	Suspension Control Arm - Front Left Lower		8K0407151D
SSP0293 301191602930	Steering Tie Rod End - Front Right	M16X1,5	4G0423812A
SSP0294 301191602940	Steering Tie Rod End - Front Left	M16X1,5	4G0423811A
SSP1780 301191617800	Suspension Ball Joint - Front Lower		8K0407689E; 8K0407689F
SSP2025 301191620250	Suspension Stabilizer Bar Link - Front	L=170mm	8K0411317D; 8K0411317E
SSP2027 301191620270	Suspension Stabilizer Bar Link - Front	L=170mm	4G0411317A; 4G0411317C



AUDI A8 4D2, 4D8

03/1994-09/2002



SSP2005



SSP2005



SSP2013



SSP2011



SSP2010



SSP2011



SSP2012



SSP2010



AUDI A8 4D2, 4D8



03/1994-09/2002

PART NO.	DESCRIPTION	NOTES	O.E.
ARM170	301181317000 Suspension Control Arm and Ball Joint Assembly - Front Right Upper Rearward		4D0407510D; 4D0407510J
ARM171	301181317100 Suspension Control Arm and Ball Joint Assembly - Front Right Upper Rearward	Ch. 8D-W-006471 > Ch. 8D-X-200001 >	4D0407510F; 4D0407510G
ARM172	301181317200 Suspension Control Arm and Ball Joint Assembly - Front Left Upper Rearward		4D0407509D; 4D0407509J
ARM173	301181317300 Suspension Control Arm and Ball Joint Assembly - Front Left Upper Rearward	Ch. 8D-W-006471 > Ch. 8D-X-200001 >	4D0407509F; 4D0407509G
ARM174	301181317400 Suspension Control Arm and Ball Joint Assembly - Front Right Upper Forward		8D0407506B; 8D0407506H
ARM175	301181317500 Suspension Control Arm and Ball Joint Assembly - Front Right Upper Forward	Ch. 8D-W-006471 > 8D-X-200001 >	8D0407506A; 8E0407506A; 8D0407506B; 8D0407506F
ARM176	301181317600 Suspension Control Arm and Ball Joint Assembly - Front Left Upper Forward		8D0407505B; 8D0407505H
ARM177	301181317700 Suspension Control Arm and Ball Joint Assembly - Front Left Upper Forward	Ch. 8D-W-006471 > 8D-X-200001 >	8D0407505A; 8E0407505A
ARM178	301181317800 Suspension Control Arm and Ball Joint Assembly - Front Right Lower Rearward		4D0407694M; 8E0407694; 4D0407694N; 8E0407693K
ARM179	301181317900 Suspension Control Arm and Ball Joint Assembly - Front Left Lower		4D0407693M; 8E0407693K; 4D0407693N; 8E0407693
ARM180	301181318000 Suspension Control Arm and Ball Joint Assembly - Front Lower Forward	D=Ø 20,6mm	4D0407151G; 8E0407151N; 4D0407151H; 4D0407151J
ARM181	301181318100 Suspension Control Arm and Ball Joint Assembly - Front Lower Forward	D=16,30mm 1/6	8E0407151M
ARM184	301181318400 Suspension Control Arm and Ball Joint Assembly - Front Upper		4D0407505A; 4D0407505D; 4D0407505F
SSP0004	301191600040 Steering Tie Rod - Front	M 14x1.5 Rht - L=119,5mm	4B0422821; 4D0422821
SSP0287	301191602870 Steering Tie Rod End - Front	Ch.-> 8D-W-260192 -> 8D-W-152089 M14x1,5Rht	4B0419811E; 4D0419811A; 4D0419811B; 8E0419811B
SSP2005	301191620050 Suspension Stabilizer Bar Link - Front	L=86mm	4D0411317G; 4D0411317J; 4D0411317K
SSP2010	301191620100 Suspension Stabilizer Bar Link - Rear	M10x1,5 Rht - L=120mm	4D0505465D
SSP2011	301191620110 Suspension Stabilizer Bar Link - Rear	(Clip-on patented design) M10x1,5 Rht - L=120mm	4D0505465D
SSP2012	301191620120 Suspension Stabilizer Bar Link - Rear Right	L=61,5mm	4D0505548C; 4E0505548L
SSP2013	301191620130 Suspension Stabilizer Bar Link - Rear Left	L=61,5mm	4D0505547C; 4E0505547L



AUDI A8 4E



10/2002-07/2010

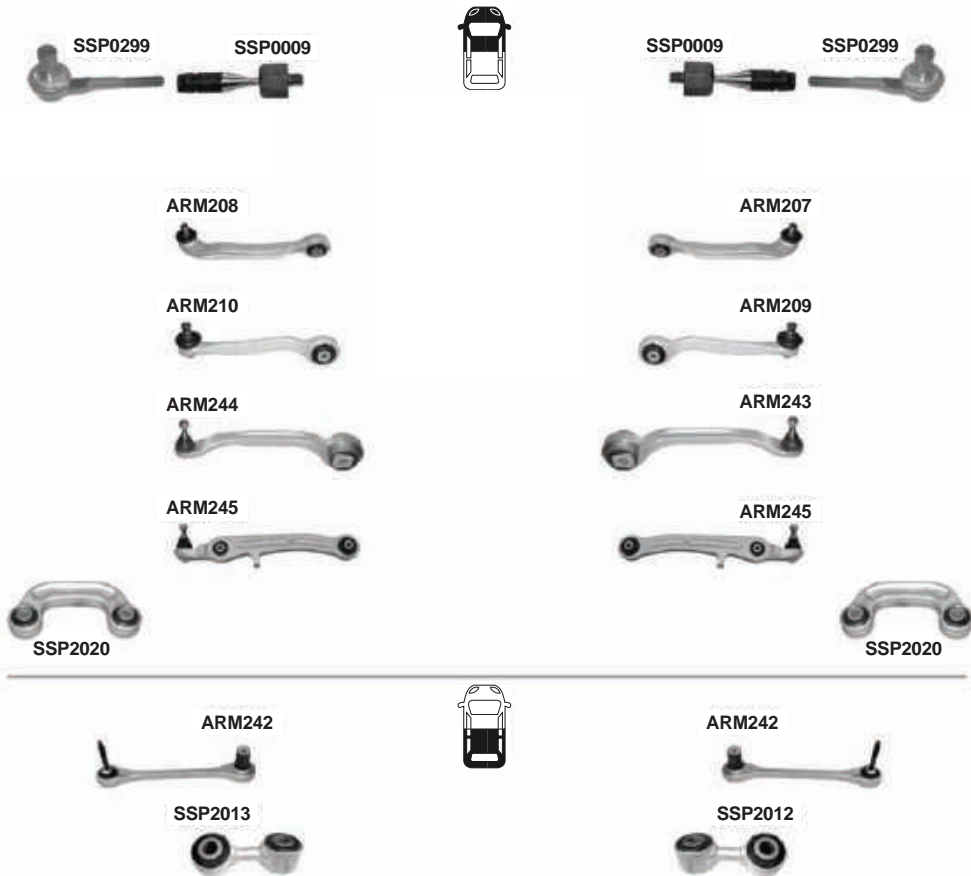

PART NO.	DESCRIPTION	NOTES	O. E.
ARM207 301181320700	Suspension Control Arm and Ball Joint Assembly - Front Right Upper Rearward		4E0407510B
ARM208 301181320800	Suspension Control Arm and Ball Joint Assembly - Front Left Upper Rearward		4E0407509B
ARM209 301181320900	Suspension Control Arm and Ball Joint Assembly - Front Right Upper Forward		4E0407506B
ARM210 301181321000	Suspension Control Arm and Ball Joint Assembly - Front Left Upper Forward		4E0407505B
ARM242 301181324200	Lateral Arm - Rear Lower	Aluminium	4E0501529D; 4E0501529G
ARM243 301181324300	Suspension Control Arm and Ball Joint Assembly - Front Right Lower		4E0407694C; 4E0407694F
ARM244 301181324400	Suspension Control Arm and Ball Joint Assembly - Front Left Lower		4E0407693C; 4E0407693F
ARM245 301181324500	Suspension Control Arm and Ball Joint Assembly - Front Lower		4E0407151G; 4E0407151L
SSP0009 301191600090	Steering Tie Rod - Front	M16x1,5Rht - L=127mm	4E0419821
SSP0299 301191602990	Steering Tie Rod End - Front	M16x1,5Rht	4E0419811B; 4E0419811E; 4E0419811C; 4E0419811D
SSP2012 301191620120	Suspension Stabilizer Bar Link - Rear Right	L=61,5mm	4D0505548C; 4E0505548L
SSP2013 301191620130	Suspension Stabilizer Bar Link - Rear Left	L=61,5mm	4D0505547C; 4E0505547L
SSP2020 301191620200	Suspension Stabilizer Bar Link - Front	L=110mm	4E0411317C; 4E0411317D; 4E0411317E



AUDI A8 4H



08/2010-

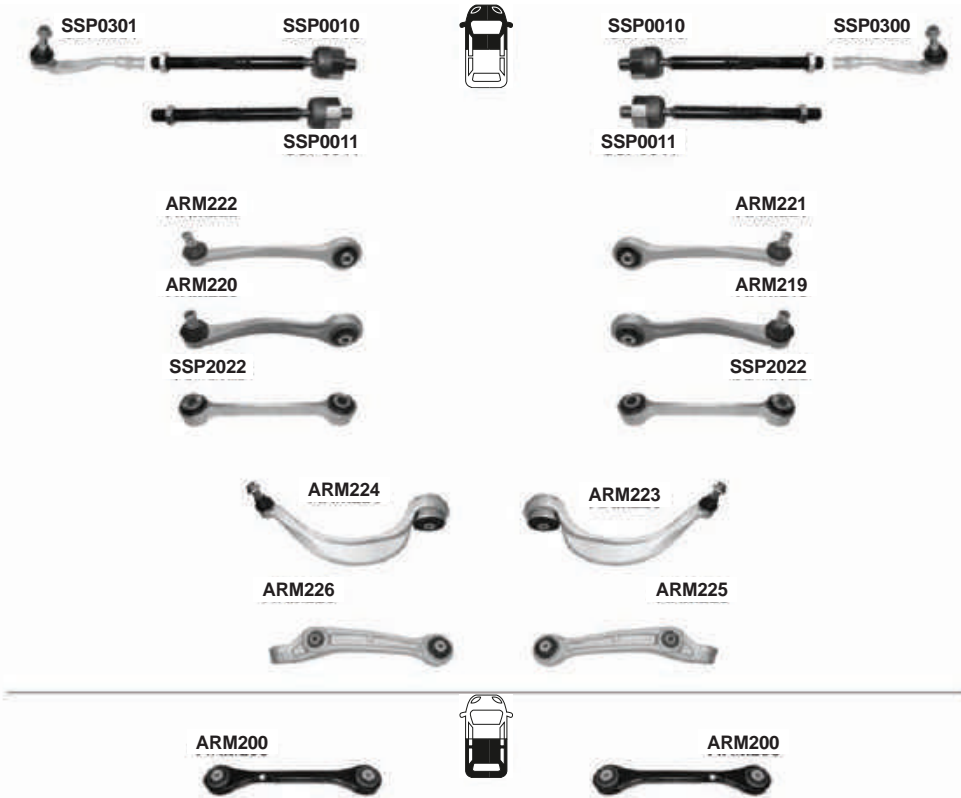

PART NO.	DESCRIPTION	NOTES	O.E.
ARM200 301181320000	Lateral Arm - Rear Lower Forward		8K0501529L
ARM219 301181321900	Suspension Control Arm and Ball Joint Assembly - Front Right Upper Forward		4H0407506E
ARM220 301181322000	Suspension Control Arm and Ball Joint Assembly - Front Left Upper Forward		4H0407505E
ARM221 301181322100	Suspension Control Arm and Ball Joint Assembly - Front Right Upper Rearward		4H0407510E
ARM222 301181322200	Suspension Control Arm and Ball Joint Assembly - Front Left Upper Rearward		4H0407509E
ARM223 301181322300	Suspension Control Arm and Ball Joint Assembly - Front Right Lower		4H0407694E
ARM224 301181322400	Suspension Control Arm and Ball Joint Assembly - Front Left Lower		4H0407693E
ARM225 301181322500	Suspension Control Arm - Front Right Lower		4H0407152B
ARM226 301181322600	Suspension Control Arm - Front Left Lower		4H0407151B
SSP0010 301191600100	Steering Tie Rod - Front	Only : EPS Steering M16x1.5 / L=236	4G0423810A
SSP0011 301191600110	Steering Tie Rod - Front Inner	M16x1.5 / L=226	4H0422810; 4H0422810A
SSP0300 301191603000	Steering Tie Rod End - Front Right	M16X1,5	4H0422818A
SSP0301 301191603010	Steering Tie Rod End - Front Left	M16X1,5	4H0422817A
SSP1784 301191617840	Suspension Ball Joint - Front Lower		4H0407689
SSP2022 301191620220	Suspension Stabilizer Bar Link - Front	L=170mm	8K0411317C; 8K0411317E

**AUDI CABRIOLET**

1991-2000



	PART NO.	DESCRIPTION	NOTES	O.E.
ARM161	301181316100	Suspension Control Arm and Ball Joint Assembly - Front Right Lower		895407148A
ARM162	301181316200	Suspension Control Arm and Ball Joint Assembly - Front Left Lower		895407147A
SSP0282	301191602820	Steering Tie Rod End - Front	M14x1,5Rht	811419812A; 811419812B
SSP1773	301191617730	Suspension Ball Joint - Front Left Lower	D=Ø19mm	894407365E; 8A0407365
SSP1774	301191617740	Suspension Ball Joint - Front Right Lower	D=Ø19mm	894407366E; 8A0407366



AUDI COUPE



1982-1988



SSP0282



SSP0282



SSP1773

ARM162



ARM161

SSP1774

	PART NO.	DESCRIPTION	NOTES	O.E.
ARM161	301181316100	Suspension Control Arm and Ball Joint Assembly - Front Right Lower		895407148A
ARM162	301181316200	Suspension Control Arm and Ball Joint Assembly - Front Left Lower		895407147A
SSP0282	301191602820	Steering Tie Rod End - Front	M14x1,5Rht	811419812A; 811419812B
SSP1773	301191617730	Suspension Ball Joint - Front Left Lower	D=Ø19mm	894407365E; 8A0407365
SSP1774	301191617740	Suspension Ball Joint - Front Right Lower	D=Ø19mm	894407366E; 8A0407366

**AUDI COUPE**

1988-1996

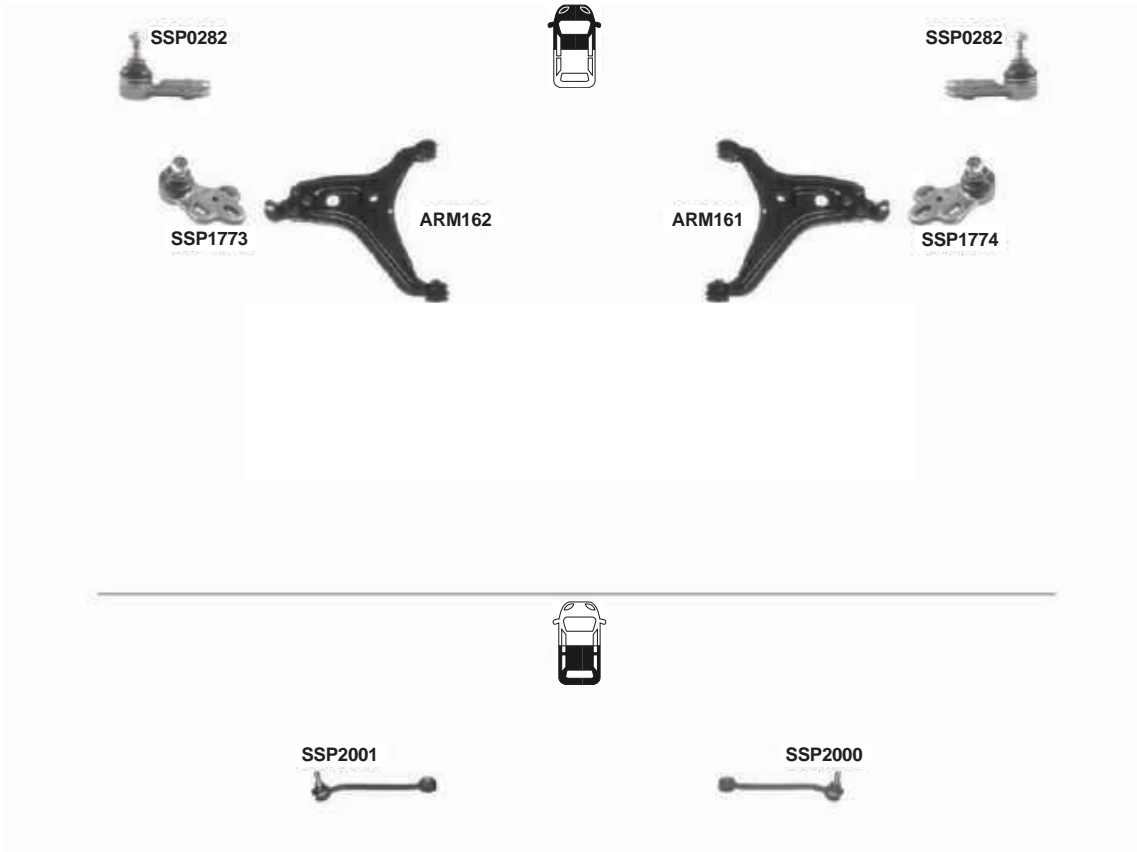

	PART NO.	DESCRIPTION	NOTES	O.E.
ARM161	301181316100	Suspension Control Arm and Ball Joint Assembly - Front Right Lower		895407148A
ARM162	301181316200	Suspension Control Arm and Ball Joint Assembly - Front Left Lower		895407147A
SSP0282	301191602820	Steering Tie Rod End - Front	M14x1,5Rht	811419812A; 811419812B
SSP1773	301191617730	Suspension Ball Joint - Front Left Lower	D=Ø19mm	894407365E; 8A0407365
SSP1774	301191617740	Suspension Ball Joint - Front Right Lower	A-425 D=Ø19mm	894407366E; 8A0407366
SSP2000	301191620000	Suspension Stabilizer Bar Link - Rear Right	L=227,5mm	8A0505466C; 8D0505466
SSP2001	301191620010	Suspension Stabilizer Bar Link - Rear Left	L=227,5mm	8A0505465C; 8D0505465



AUDI COUPE QUATTRO



1984-1987



SSP2001



SSP2000



PART NO.	DESCRIPTION	NOTES	O.E.
SSP2000 301191620000	Suspension Stabilizer Bar Link - Rear Right	L=227,5mm	8A0505466C; 8D0505466
SSP2001 301191620010	Suspension Stabilizer Bar Link - Rear Left	L=227,5mm	8A0505465C; 8D0505465

**AUDI COUPE QUATTRO**

1988-1995

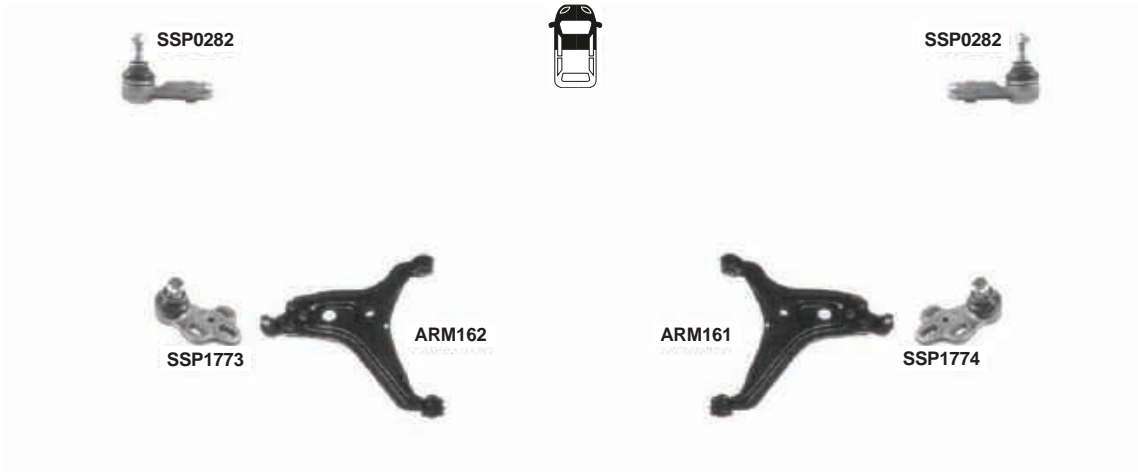

	PART NO.	DESCRIPTION	NOTES	O.E.
ARM161	301181316100	Suspension Control Arm and Ball Joint Assembly - Front Right Lower		895407148A
ARM162	301181316200	Suspension Control Arm and Ball Joint Assembly - Front Left Lower		895407147A
SSP0282	301191602820	Steering Tie Rod End - Front	M14x1,5Rht	811419812A; 811419812B
SSP1773	301191617730	Suspension Ball Joint - Front Left Lower	D=Ø19mm	894407365E; 8A0407365
SSP1774	301191617740	Suspension Ball Joint - Front Right Lower	D=Ø19mm	894407366E; 8A0407366



AUDI Q3 8U



06/2011-2016



SSP0701



SSP0700



SSP1977

ARM1047



SSP1976

ARM1046

ARM1039



ARM1039



ARM188



ARM187



SSP2577



ARM1057



ARM1057



SSP2577

**AUDI Q3 8U**

06/2011-2016

PART NO.	DESCRIPTION	NOTES	O.E.
ARM187 301181318700	Lateral Arm - Rear Right Lower		3C0505224D
ARM188 301181318800	Lateral Arm - Rear Left Lower		3C0505223D
ARM1039 301181310390	Lateral Arm - Rear Lower		1K0505311AA; 1K0505311S; 1K0505311AB
ARM1046 301181310460	Suspension Control Arm and Ball Joint Assembly - Front Right		3C0407151G*
ARM1047 301181310470	Suspension Control Arm and Ball Joint Assembly - Front Left		3C0407151H*
ARM1057 301181310570	Lateral Arm - Rear Upper		5Q0505323C; 5Q0505323D
SSP0700 301191607000	Steering Tie Rod End - Front Right	M16x1,5Rht	1K0423812A; 1K0423812J; 1K0423812K; 1K0423812G; 1K0423812E
SSP0701 301191607010	Steering Tie Rod End - Front Left	M16x1,5Rht	1K0423811A; 1K0423811J; 1K0423811K; 1K0423811G; 1K0423811E
SSP1976 301191619760	Suspension Ball Joint - Front Right Lower		1K0407366B; 5Q0407366A; 1K0407366E; 1K0407366C
SSP1977 301191619770	Suspension Ball Joint - Front Left Lower		1K0407365B; 5Q0407365A; 1K0407365E; 1K0407365C
SSP2577 301191625770	Suspension Stabilizer Bar Link - Rear	L=95,5 mm	1K0505465C; 1K0505465J; 1K0505465K; 1K0505465H; 1K0505465D



AUDI Q5 8R



11/2008-2016



SSP1780 SSP1783

SSP1780 SSP1783

ARM206

ARM205

SSP2024



SSP2024



SSP2025



SSP2025



SSP2027



SSP2027



ARM200



ARM200



**AUDI Q5 8R**

11/2008-2016

PART NO.	DESCRIPTION	NOTES	O.E.
ARM192 301181319200	Suspension Control Arm - Front Right Lower Forward		8K0407152B
ARM193 301181319300	Suspension Control Arm - Front Left Lower Forward		8K0407151B
ARM196 301181319600	Suspension Control Arm and Ball Joint Assembly - Front Right Upper Forward	:09/2011 ->	8K0407506A
ARM197 301181319700	Suspension Control Arm and Ball Joint Assembly - Front Left Upper Forward	:09/2011 ->	8K0407505A
ARM198 301181319800	Suspension Control Arm and Ball Joint Assembly - Front Right Upper Rearward	:09/2011 ->	8K0407510A
ARM199 301181319900	Suspension Control Arm and Ball Joint Assembly - Front Left Upper Rearward	:09/2011 ->	8K0407509A
ARM200 301181320000	Lateral Arm - Rear Lower Forward		8K0501529L
ARM203 301181320300	Suspension Control Arm and Ball Joint Assembly - Front Right Lower Rearward	Ch:8K,8T	8K0407694T; 8K0407694S
ARM204 301181320400	Suspension Control Arm and Ball Joint Assembly - Front Left Lower Rearward	Ch:8K,8T	8K0407693T; 8K0407693S
ARM205 301181320500	Suspension Control Arm - Front Right Lower		8K0407152F; 8K0407152G
ARM206 301181320600	Suspension Control Arm - Front Left Lower		8K0407151F; 8K0407151G
SSP0006 301191600060	Steering Tie Rod - Front	M16X1,5 - L=225mm	8J0423810
SSP0288 301191602880	Steering Tie Rod End - Front Right Outer	M16X1,5	8K0422818A; 8K0422818B
SSP0289 301191602890	Steering Tie Rod End - Front Left Outer	M16X1,5	8K0422817A; 8K0422817B
SSP0293 301191602930	Steering Tie Rod End - Front Right	M16X1,5	4G0423812A
SSP0294 301191602940	Steering Tie Rod End - Front Left	M16X1,5	4G0423811A
SSP1780 301191617800	Suspension Ball Joint - Front Lower		8K0407689E; 8K0407689F
SSP1783 301191617830	Suspension Ball Joint - Front Lower		4G0407689C
SSP2024 301191620240	Suspension Stabilizer Bar Link - Front		8K0411317B
SSP2025 301191620250	Suspension Stabilizer Bar Link - Front	L=170mm	8K0411317D; 8K0411317E
SSP2027 301191620270	Suspension Stabilizer Bar Link - Front	L=170mm	4G0411317A; 4G0411317C



AUDI Q7 4L



03/2006-08/2010

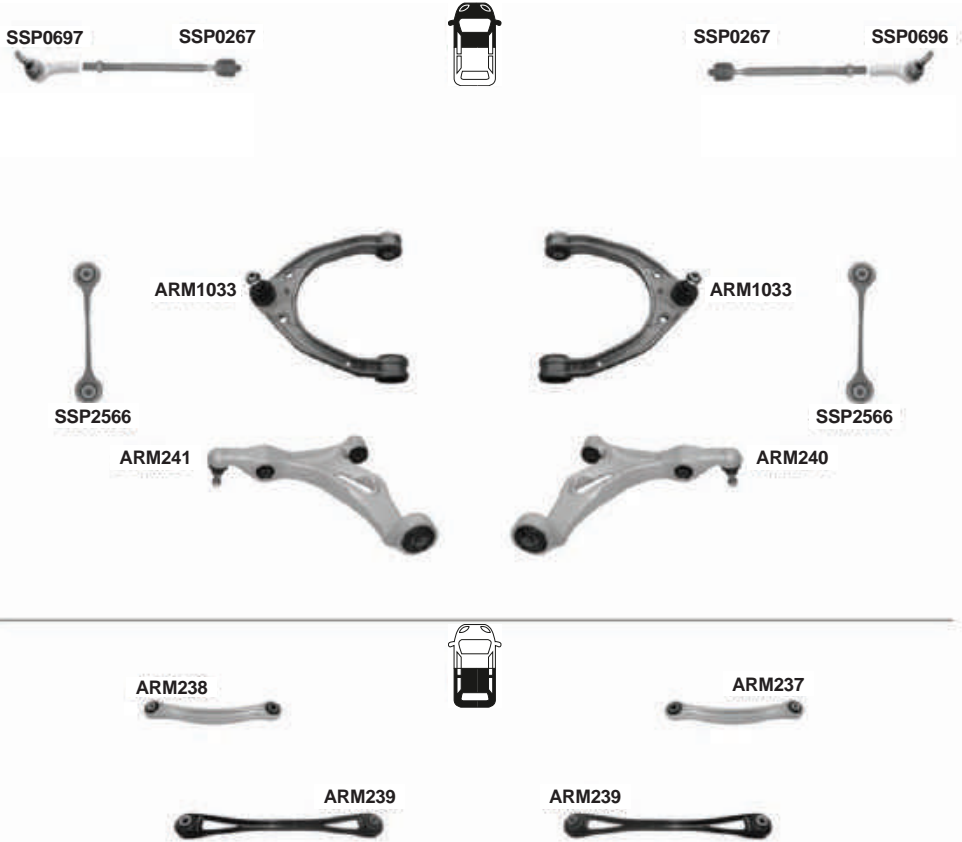

PART NO.	DESCRIPTION	NOTES	O.E.
ARM237 301181323700	Lateral Arm - Rear Right	(ALM)	7L0505398
ARM238 301181323800	Lateral Arm - Rear Left	(ALM)	7L0505397
ARM239 301181323900	Lateral Arm - Rear Lower		7L8501529A
ARM240 301181324000	Suspension Control Arm and Ball Joint Assembly - Front Right Lower		7L8407152E
ARM241 301181324100	Suspension Control Arm and Ball Joint Assembly - Front Left Lower		7L8407151E
ARM1033 301181310330	Suspension Control Arm and Ball Joint Assembly - Front Upper	Alum.	7L0407021A; 95534102702; 95534102701; 7L0407021B
SSP0267 301191602670	Steering Tie Rod - Front	M16x1,5Rht - L=287,5mm	1160310016; 7L0422821
SSP0696 301191606960	Steering Tie Rod End - Front Right	M16x1,5Rht	7L0422818B; 95534713220; 7L0422818D; 7L0422818C
SSP0697 301191606970	Steering Tie Rod End - Front Left	M16x1,5Rht	7L0422817B; 95534713221; 7L0422817D; 7L0422817C
SSP2566 301191625660	Suspension Stabilizer Bar Link - Front	L=197mm	7L0411317



AUDI Q7 4M



2017-



PART NO.	DESCRIPTION	NOTES	O.E.
SSP2027 301191620270	Suspension Stabilizer Bar Link - Front	L=170mm only standart suspension	4G0411317A; 4G0411317C



AUDI TT 8N3, ROADSTER, 8N



02/1999-06/2006

SSP0291



SSP0007



SSP0007



SSP0290



ARM189



ARM189



ARM169



ARM169



SSP2023



SSP2023



ARM983



ARM982

**AUDI TT 8N3, ROADSTER, 8N**

02/1999-06/2006

PART NO.	DESCRIPTION	NOTES	O.E.
ARM169	301181316900 Lateral Arm - Rear		1J0505323L; 1J0505323E; 1J0505323H; 1J0505323M
ARM189	301181318900 Lateral Arm - Rear Upper		1K0505323N
ARM201	301181320100 Suspension Control Arm and Ball Joint Assembly - Front Right Lower		8N0407152A*; 8N0407152D*
ARM202	301181320200 Suspension Control Arm and Ball Joint Assembly - Front Left Lower		8N0407151A*; 8N0407151D*
ARM982	301181398200 Lateral Arm - Rear Right Lower	L=298mm	1K0501530C
ARM983	301181398300 Lateral Arm - Rear Left Lower	L=298mm	1K0501529F
SSP0007	301191600070 Steering Tie Rod - Front	M-16x1.5 - L=330mm	8N0422807A
SSP0290	301191602900 Steering Tie Rod End - Front Right	M-16x1.5	8N0422812A
SSP0291	301191602910 Steering Tie Rod End - Front Left	M-16x1.5	8N0422811A
SSP1775	301191617750 Suspension Ball Joint - Front Lower		8N0407365A; 8N0407365B; 8N0407365C
SSP2002	301191620020 Suspension Stabilizer Bar Link - Front Left	4 Motion L=336mm	1J0411315D
SSP2003	301191620030 Suspension Stabilizer Bar Link - Front Left	4 Motion (Clip-on patented design) L=336mm	1J0411315D
SSP2004	301191620040 Suspension Stabilizer Bar Link - Front Right	4 Motion L=336mm	1J0411316D
SSP2023	301191620230 Suspension Stabilizer Bar Link - Rear	L=175mm	1J0505466B



AUDI TT 8J



07/2006-06/2014

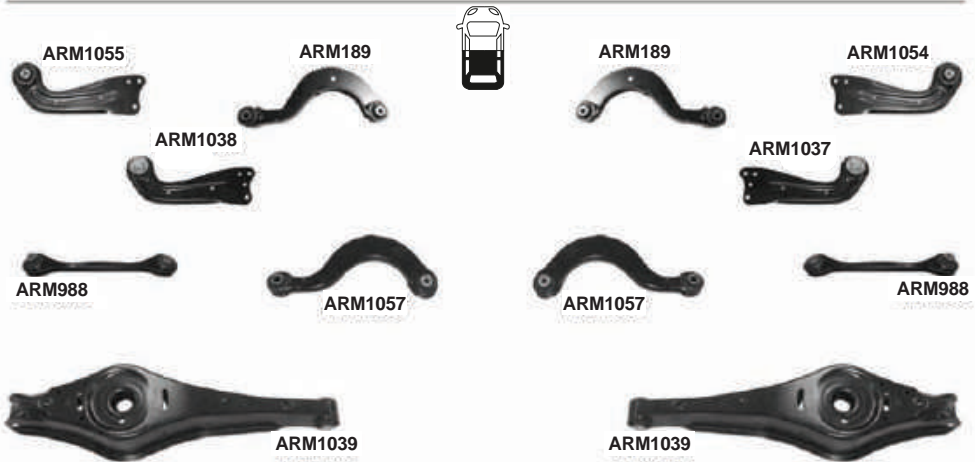

PART NO.	DESCRIPTION	NOTES	O.E.
ARM189 301181318900	Lateral Arm - Rear Upper		1K0505323N
ARM988 301181398800	Lateral Arm - Rear Lower	L=298mm	1K0501529J
ARM1037 301181310370	Lateral Arm - Rear Right Forward		1T0505224F
ARM1038 301181310380	Lateral Arm - Rear Left Forward		1T0505223F
ARM1039 301181310390	Lateral Arm - Rear Lower		1K0505311AA; 1K0505311S; 1K0505311AB
ARM1054 301181310540	Lateral Arm - Rear Right Forward		1K0505224K
ARM1055 301181310550	Lateral Arm - Rear Left Forward		1K0505223K
ARM1057 301181310570	Lateral Arm - Rear Upper		5Q0505323C; 5Q0505323D
SSP0011 301191600110	Steering Tie Rod - Front Inner	M16x1.5 / L=226	4H0422810; 4H0422810A
SSP0295 301191602950	Steering Tie Rod End - Front Right	M16x1.5	8J0423812
SSP0296 301191602960	Steering Tie Rod End - Front Left	M16x1.5	8J0423811
SSP1781 301191617810	Suspension Ball Joint - Front Right Lower		8J0407366
SSP1782 301191617820	Suspension Ball Joint - Front Left Lower		8J0407365
SSP1993 301191619930	Suspension Ball Joint Kit - Front Right Lower	Ball joint with kit	8J0407366
SSP1994 301191619940	Suspension Ball Joint Kit - Front Left Lower	Ball joint with kit	8J0407365
SSP2576 301191625760	Suspension Stabilizer Bar Link - Front	L=335mm	1K0411315B; 1K0411315D; 1K0411315J

**AUDI TT FV**

2014-



PART NO.	DESCRIPTION	NOTES	O.E.
SSP0297 301191602970	Steering Tie Rod End - Front Right		8S0423812A
SSP0298 301191602980	Steering Tie Rod End - Front Left		8S0423811A
SSP1781 301191617810	Suspension Ball Joint - Front Right Lower		8J0407366
SSP1782 301191617820	Suspension Ball Joint - Front Left Lower		8J0407365
SSP2576 301191625760	Suspension Stabilizer Bar Link - Front	L=335mm	1K0411315B; 1K0411315D; 1K0411315J
SSP2579 301191625790	Suspension Stabilizer Bar Link - Rear	L=70mm	5Q0505465C; 5Q0505465A



BENTLEY CONTINENTAL (3D)



2005-



PART NO.	DESCRIPTION	NOTES	O.E.
ARM242 301181324200	Lateral Arm - Rear Lower	Aluminium	4E0501529D; 4E0501529G



BMW 1 SERIES E81, E82, E87, E88 09/2004-09/2012





BMW 1 SERIES E81, E82, E87, E88 09/2004-09/2012

PART NO.	DESCRIPTION	NOTES	O.E.
ARM249	301181324900 Suspension Control Arm and Ball Joint Assembly - Front Right Lower Rearward		31126763700; 31126769794; 31126770850
ARM250	301181325000 Suspension Control Arm and Ball Joint Assembly - Front Left Lower Rearward		31126763699; 31126769793; 31126770849
ARM251	301181325100 Suspension Control Arm and Ball Joint Assembly - Front Right Lower Forward		31124036270; 31126769798; 31126763704; 31126763708
ARM252	301181325200 Suspension Control Arm and Ball Joint Assembly - Front Left Lower Forward		31124036269; 31126769797; 31126763703; 31126763707
ARM253	301181325300 Lateral Arm - Rear Upper Forward		33326765425; 33326765534; 33326782237
ARM254	301181325400 Lateral Arm - Rear Upper Rearward		33326763473; 33326777980
ARM255	301181325500 Lateral Arm - Rear Lower Rearward		33326763471
SSP0015	301191600150 Steering Tie Rod - Front	M14X1,5	32216762243*; 32216762244*
SSP0016	301191600160 Steering Tie Rod - Front Inner	(ZF-RHD) M14X1,5	Part of : 32106765235/236
SSP0304	301191603040 Steering Tie Rod End - Front Right	TRW St. M14X1,5	32106767782; 32106765090
SSP0305	301191603050 Steering Tie Rod End - Front Left	ZF St. M14X1,5	32106767781; 32106765089
SSP2033	301191620330 Suspension Stabilizer Bar Link - Front Right	L=290mm	31356765934
SSP2034	301191620340 Suspension Stabilizer Bar Link - Front Left	L=290mm	31356765933
SSP2035	301191620350 Suspension Stabilizer Bar Link - Rear	L=160mm	33556764428



BMW 1 SERIES F



10/2011-





BMW 1 SERIES F



10/2011-

PART NO.	DESCRIPTION	NOTES	O.E.
ARM258	301181325800 Suspension Control Arm and Ball Joint Assembly - Front Right Lower Rearward		31126852992
ARM259	301181325900 Suspension Control Arm and Ball Joint Assembly - Front Left Lower Rearward		31126852991
ARM260	301181326000 Suspension Control Arm and Ball Joint Assembly - Front Right Lower Forward		31126855742
ARM261	301181326100 Suspension Control Arm and Ball Joint Assembly - Front Left Lower Forward		31126855741
ARM262	301181326200 Lateral Arm - Rear Right Upper Forward	L=245mm	33326792540
ARM263	301181326300 Lateral Arm - Rear Left Upper Forward	L=245mm	33326792539
ARM264	301181326400 Lateral Arm - Rear Lower		33326792525
ARM265	301181326500 Lateral Arm - Rear Upper		33326792533
ARM266	301181326600 Lateral Arm - Rear Right Upper Rearward	L=289mm	33326792544
ARM267	301181326700 Lateral Arm - Rear Left Upper Rearward	L=289mm	33326792543
ARM345	301181334500 Lateral Arm - Rear		33326792541
SSP0018	301191600180 Steering Tie Rod - Front	M14X1,5 L=253mm	32106799965 Part of
SSP0308	301191603080 Steering Tie Rod End - Front Right	M14X1,5	32106799967
SSP0309	301191603090 Steering Tie Rod End - Front Left	M14X1,5	32106799966
SSP2038	301191620380 Suspension Stabilizer Bar Link - Front Right	(sport suspension) L=310mm	31306792212
SSP2039	301191620390 Suspension Stabilizer Bar Link - Front	L=310mm	31306792211
SSP2040	301191620400 Suspension Stabilizer Bar Link - Rear Right	L=136mm	33506785608
SSP2041	301191620410 Suspension Stabilizer Bar Link - Rear Left	L=136mm	33506785607

**BMW 2 SERIES F**

2014-

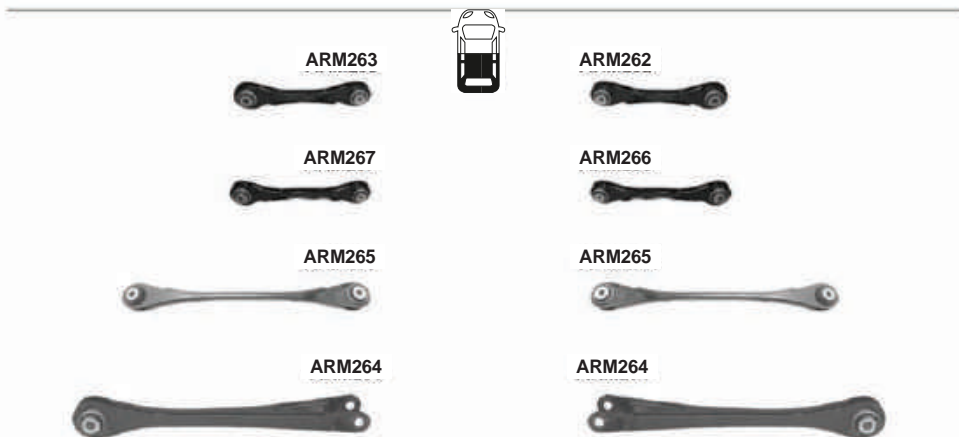

PART NO.	DESCRIPTION	NOTES	O.E.
ARM262 301181326200	Lateral Arm - Rear Right Upper Forward	L=245mm	33326792540
ARM263 301181326300	Lateral Arm - Rear Left Upper Forward	L=245mm	33326792539
ARM264 301181326400	Lateral Arm - Rear Lower		33326792525
ARM265 301181326500	Lateral Arm - Rear Upper		33326792533
ARM266 301181326600	Lateral Arm - Rear Right Upper Rearward	L=289mm	33326792544
ARM267 301181326700	Lateral Arm - Rear Left Upper Rearward	L=289mm	33326792543
SSP0014 301191600140	Steering Tie Rod - Front		Part of 32106867404; Part of 32106867405
SSP0302 301191603020	Steering Tie Rod End - Front Right		32106867405; 32106854734
SSP0303 301191603030	Steering Tie Rod End - Front Left		32106867404; 32106854737



BMW 2 SERIES Active Tourer F45,F46 09/2014-

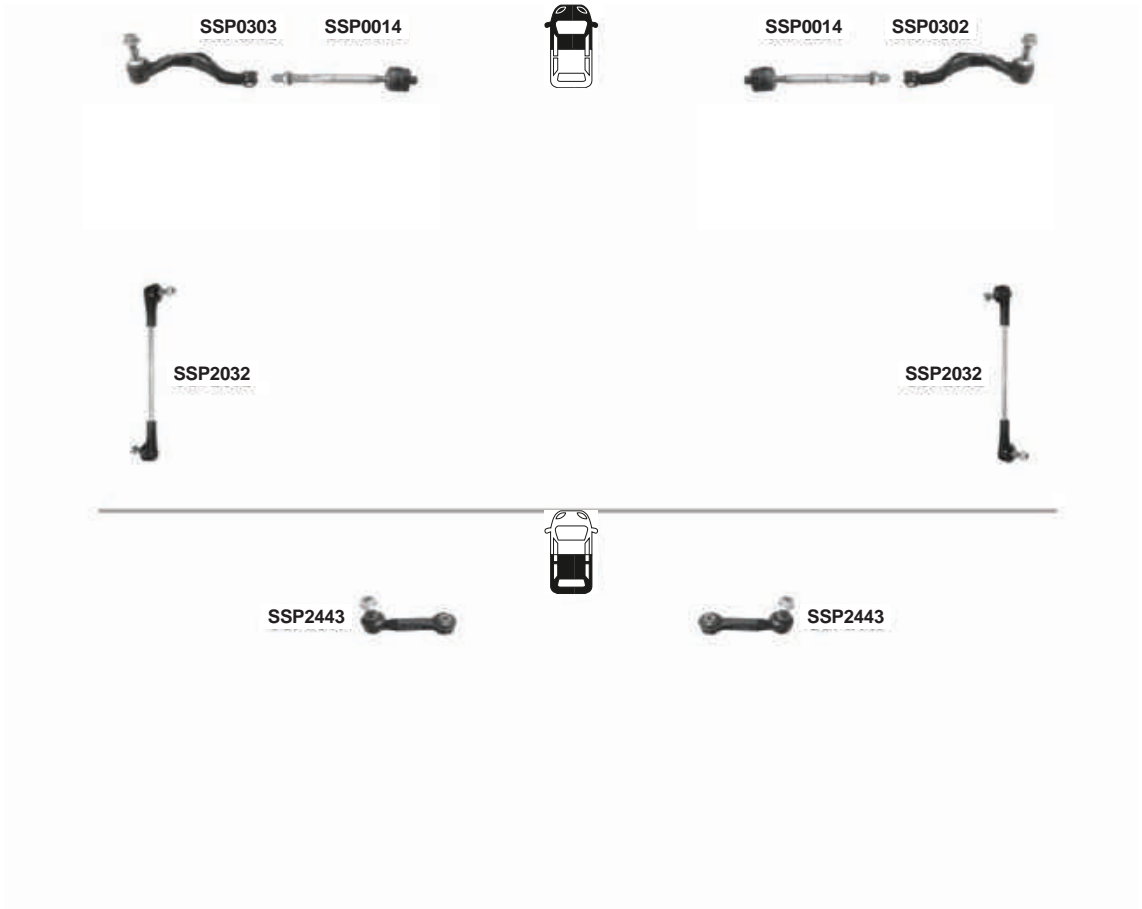

PART NO.	DESCRIPTION	NOTES	O.E.
ARM248 301181324800	Lateral Arm - Rear Upper		33326870773; 33326851563
SSP0014 301191600140	Steering Tie Rod - Front		Part of 32106867404; Part of 32106867405
SSP0302 301191603020	Steering Tie Rod End - Front Right		32106867405; 32106854734
SSP0303 301191603030	Steering Tie Rod End - Front Left		32106867404; 32106854737
SSP2032 301191620320	Suspension Stabilizer Bar Link - Front		31306862864
SSP2443 301191624430	Suspension Stabilizer Bar Link - Rear		33506862865



BMW 3 SERIES E36



1990-1998



PART NO.	DESCRIPTION	NOTES	O.E.
ARM322 301181332200	Lateral Arm - Rear Lower		33303411651; 33326770813; 33326760675



BMW 3 SERIES E46



02/1998-04/2005





BMW 3 SERIES E46



02/1998-04/2005

PART NO.	DESCRIPTION	NOTES	O.E.
ARM274	301181327400 Suspension Control Arm and Ball Joint Assembly - Front Right Lower	Alm.	31121094466; 31126758520; 31126752318; 31126752718; 31126751318
ARM275	301181327500 Suspension Control Arm Kit - Front Right Lower	Alm.Complete Kit	31121094466
ARM276	301181327600 Suspension Control Arm Kit - Front Right Lower	Alm.With Mounted Bush	31121094466
ARM277	301181327700 Suspension Control Arm and Ball Joint Assembly - Front Left Lower	Alm.	31121094465; 31126752717; 31126758519; 31126751317
ARM278	301181327800 Suspension Control Arm Kit - Front Left Lower	Alm.Complete Kit	31121094465
ARM279	301181327900 Suspension Control Arm Kit - Front Left Lower	Alm.With Mounted Bush	31121094465
ARM280	301181328000 Suspension Control Arm and Ball Joint Assembly - Front Right		31122282122
ARM281	301181328100 Suspension Control Arm and Ball Joint Assembly - Front Right	Kit version with bushing	31122282122
ARM282	301181328200 Suspension Control Arm and Ball Joint Assembly - Front Left		31122282121
ARM283	301181328300 Suspension Control Arm and Ball Joint Assembly - Front Left	Kit version with bushing	31122282121
ARM322	301181332200 Lateral Arm - Rear Lower		33303411651; 33326770813; 33326760675
SSP0020	301191600200 Steering Tie Rod - Front	M14x1,5 - L=205mm	32211095950
SSP0314	301191603140 Steering Tie Rod End - Front Right	M14x1,5Rht	32211095958
SSP0315	301191603150 Steering Tie Rod End - Front Left	M14x1,5Rht	32211095957
SSP2050	301191620500 Suspension Stabilizer Bar Link - Rear	L=95 mm	33551094619
SSP2051	301191620510 Suspension Stabilizer Bar Link - Front	L=270 mm	31351095694
SSP2052	301191620520 Suspension Stabilizer Bar Link - Front	(Clip-on patented design) L=270 mm	3135095694*
SSP2053	301191620530 Suspension Stabilizer Bar Link - Front Right	Only:325x1,330x1,330xd L=308mm	31356751080
SSP2054	301191620540 Suspension Stabilizer Bar Link - Front Left	Only:325x1,330x1,330xd L=308mm	31356751079

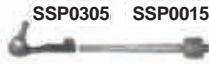

PART NO.	DESCRIPTION	NOTES	O.E.
ARM249	Suspension Control Arm and Ball Joint Assembly - Front Right Lower Rearward		31126763700; 31126769794; 31126770850
ARM250	Suspension Control Arm and Ball Joint Assembly - Front Left Lower Rearward		31126763699; 31126769793; 31126770849
ARM251	Suspension Control Arm and Ball Joint Assembly - Front Right Lower Forward		31124036270; 31126769798; 31126763704; 31126763708
ARM252	Suspension Control Arm and Ball Joint Assembly - Front Left Lower Forward		31124036269; 31126769797; 31126763703; 31126763707
ARM253	Lateral Arm - Rear Upper Forward		33326765425; 33326765534; 33326782237
ARM254	Lateral Arm - Rear Upper Rearward		33326763473; 33326777980
ARM255	Lateral Arm - Rear Lower Rearward		33326763471
SSP0015	Steering Tie Rod - Front	M14X1,5	32216762243*; 32216762244*
SSP0016	Steering Tie Rod - Front Inner	(ZF-RHD) M14X1,5	Part of : 32106765235/236
SSP0304	Steering Tie Rod End - Front Right	ZF St. M14X1,5	32106767782; 32106765090
SSP0305	Steering Tie Rod End - Front Left	TRW St. M14X1,5	32106767781; 32106765089
SSP2033	Suspension Stabilizer Bar Link - Front Right	L=290mm	31356765934
SSP2034	Suspension Stabilizer Bar Link - Front Left	L=290mm	31356765933
SSP2035	Suspension Stabilizer Bar Link - Rear	L=160mm	33556764428



BMW 3 SERIES E90/E91/E92/E93 (xDrive) 4x4

**01/2005-12/2011**

	PART NO.	DESCRIPTION	NOTES	O.E.
ARM256	301181325600	Suspension Control Arm - Front Right Lower Rearward	xdrive	31126768984
ARM257	301181325700	Suspension Control Arm - Front Left Lower Rearward	xdrive	31126768983
ARM360	301181336000	Suspension Control Arm and Ball Joint Assembly - Front	xdrive	31122405863; 31126768989
SSP0017	301191600170	Steering Tie Rod - Front	C = (xDrive) 4x4 M18X1.5	32106793621/622 Part of
SSP0306	301191603060	Steering Tie Rod End - Front Right	xdrive M14X1,5	32106769074; 32106793624
SSP0307	301191603070	Steering Tie Rod End - Front Left	xdrive M14X1,5	32106769073; 32106793623
SSP1785	301191617850	Suspension Ball Joint - Front Lower		31126768988
SSP2036	301191620360	Suspension Stabilizer Bar Link - Front Right	Metal Type (xDrive) 4x4 A = 340 MM	31356768772
SSP2037	301191620370	Suspension Stabilizer Bar Link - Front Left	Metal Type (xDrive) 4x4 A = 340 MM	31356768771



BMW 3 SERIES F



10/2011-



**BMW 3 SERIES F**

10/2011-

	PART NO.	DESCRIPTION	NOTES	O.E.
ARM258	301181325800	Suspension Control Arm and Ball Joint Assembly - Front Right Lower Rearward		31126852992
ARM259	301181325900	Suspension Control Arm and Ball Joint Assembly - Front Left Lower Rearward		31126852991
ARM260	301181326000	Suspension Control Arm and Ball Joint Assembly - Front Right Lower Forward		31126855742
ARM261	301181326100	Suspension Control Arm and Ball Joint Assembly - Front Left Lower Forward		31126855741
ARM262	301181326200	Lateral Arm - Rear Right Upper Forward	L=245mm	33326792540
ARM263	301181326300	Lateral Arm - Rear Left Upper Forward	L=245mm	33326792539
ARM264	301181326400	Lateral Arm - Rear Lower		33326792525
ARM265	301181326500	Lateral Arm - Rear Upper		33326792533
ARM266	301181326600	Lateral Arm - Rear Right Upper Rearward	L=289mm	33326792544
ARM267	301181326700	Lateral Arm - Rear Left Upper Rearward	L=289mm	33326792543
ARM345	301181334500	Lateral Arm - Rear		33326792541
SSP0018	301191600180	Steering Tie Rod - Front	M14X1,5 L=253mm	32106799965 Part of
SSP0308	301191603080	Steering Tie Rod End - Front Right	M14X1,5	32106799967
SSP0309	301191603090	Steering Tie Rod End - Front Left	M14X1,5	32106799966
SSP2038	301191620380	Suspension Stabilizer Bar Link - Front Right	(sport suspension) L=310mm	31306792212
SSP2039	301191620390	Suspension Stabilizer Bar Link - Front	L=310mm	31306792211
SSP2040	301191620400	Suspension Stabilizer Bar Link - Rear Right	L=136mm	33506785608
SSP2041	301191620410	Suspension Stabilizer Bar Link - Rear Left	L=136mm	33506785607



BMW 3 SERIES F xDrive



10/2011 -



SSP2038



SSP2038

PART NO.	DESCRIPTION	NOTES	O.E.
SSP2038 301191620380	Suspension Stabilizer Bar Link - Front Right	(sport suspension) L=310mm	31306792212



BMW 4 SERIES F



05/2014-



PART NO.	DESCRIPTION	NOTES	O.E.
ARM258	Suspension Control Arm and Ball Joint Assembly - Front Right Lower Rearward		31126852992
ARM259	Suspension Control Arm and Ball Joint Assembly - Front Left Lower Rearward		31126852991
ARM260	Suspension Control Arm and Ball Joint Assembly - Front Right Lower Forward		31126855742
ARM261	Suspension Control Arm and Ball Joint Assembly - Front Left Lower Forward		31126855741
ARM262	Lateral Arm - Rear Right Upper Forward	L=245mm	33326792540
ARM263	Lateral Arm - Rear Left Upper Forward	L=245mm	33326792539
ARM264	Lateral Arm - Rear Lower		33326792525
ARM265	Lateral Arm - Rear Upper		33326792533
ARM266	Lateral Arm - Rear Right Upper Rearward	L=289mm	33326792544
ARM267	Lateral Arm - Rear Left Upper Rearward	L=289mm	33326792543
ARM345	Lateral Arm - Rear		33326792541
SSP0018	Steering Tie Rod - Front	M14X1,5 L=253mm	32106799965 Part of
SSP0308	Steering Tie Rod End - Front Right	M14X1,5	32106799967
SSP0309	Steering Tie Rod End - Front Left	M14X1,5	32106799966
SSP2038	Suspension Stabilizer Bar Link - Front Right	(sport suspension) L=310mm	31306792212
SSP2039	Suspension Stabilizer Bar Link - Front	L=310mm	31306792211
SSP2040	Suspension Stabilizer Bar Link - Rear Right	L=136mm	33506785608
SSP2041	Suspension Stabilizer Bar Link - Rear Left	L=136mm	33506785607



BMW 5 SERIES E39



11/1995-06/2003

SSP0312



SSP0311



SSP0019



SSP0019



SSP0313



SSP0310



SSP2043



SSP2042

SSP2044

ARM269



ARM268



ARM309



ARM308



SSP2045



SSP2046

SSP2042

ARM271



ARM270



ARM307



ARM306



ARM273



ARM272



ARM292



ARM292



SSP2047



SSP2047



SSP2048



SSP2048



SSP2049



SSP2049



ARM301



ARM301



ARM314



ARM314



**BMW 5 SERIES E39**

11/1995-06/2003

PART NO.	DESCRIPTION	NOTES	O.E.
ARM268	301181326800	Suspension Control Arm and Ball Joint Assembly - Front Right Lower Forward	31121092024; 31121141718
ARM269	301181326900	Suspension Control Arm and Ball Joint Assembly - Front Left Lower Forward	31121092023; 31121141717
ARM270	301181327000	Suspension Control Arm and Ball Joint Assembly - Front Right Lower Rearward	31121093450; 31121094234
ARM271	301181327100	Suspension Control Arm and Ball Joint Assembly - Front Left Lower Rearward	31121093449; 31121094233
ARM272	301181327200	Lateral Arm - Rear Right	33321094210; 33326767832
ARM273	301181327300	Lateral Arm - Rear Left	33321094209; 33326767831
ARM292	301181329200	Lateral Arm - Rear Upper Forward	33321096797; 33326774795; 33326777424; 33322282065
ARM301	301181330100	Lateral Arm - Rear Upper Forward	33321090745; 33321097264
ARM306	301181330600	Suspension Control Arm and Ball Joint Assembly - Front Right Lower	31121141962
ARM307	301181330700	Suspension Control Arm and Ball Joint Assembly - Front Left Lower	31121141961
ARM308	301181330800	Suspension Control Arm and Ball Joint Assembly - Front Right Lower Rearward	(only 535i, 540i, M5) 31121092610
ARM309	301181330900	Suspension Control Arm and Ball Joint Assembly - Front Left Lower Rearward	(only 535i, 540i, M5) 31121092609
ARM314	301181331400	Lateral Arm - Rear	33321090030; 33326770749; 33321091620
SSP0019	301191600190	Steering Tie Rod - Front	M16X1 L=175mm 32111093669/770 Part of
SSP0310	301191603100	Steering Tie Rod End - Front Right Outer	M16X1Rht 32111091770
SSP0311	301191603110	Steering Tie Rod End - Front Left Outer	M16X1Rht 32111091769
SSP0312	301191603120	Steering Tie Rod End - Front Right	M16X1,5 32211091724
SSP0313	301191603130	Steering Tie Rod End - Front Left	M16X1,5 32111093771; 32211091723
SSP2042	301191620420	Suspension Stabilizer Bar Link - Front	L=285mm 31351092304; 31351095664
SSP2043	301191620430	Suspension Stabilizer Bar Link - Front Left	L=240mm 31351091855; 31351095661
SSP2044	301191620440	Suspension Stabilizer Bar Link - Front Left	(Clip-on patented design) L=240mm 31351091855; 31351095661
SSP2045	301191620450	Suspension Stabilizer Bar Link - Front Right	L=240mm 31351091856; 31351095662
SSP2046	301191620460	Suspension Stabilizer Bar Link - Front Right	(Clip-on patented design) L=240mm 31351091856; 31351095662
SSP2047	301191620470	Suspension Stabilizer Bar Link - Rear	Metal L=66mm 33551092292
SSP2048	301191620480	Suspension Stabilizer Bar Link - Rear	Metal (Clip-on patented design) L=66mm 33551092292; 33551095532
SSP2049	301191620490	Suspension Stabilizer Bar Link - Rear	Aluminium L=66mm 33551095532



BMW 5 SERIES E60 - E61



07/2003-03/2010



**BMW 5 SERIES E60 - E61**

07/2003-03/2010

PART NO.	DESCRIPTION	NOTES	O.E.
ARM290	301181329000 Lateral Arm - Rear Right Upper Rearward		33306772242; 33326774794; 33326767760; 33326770776; 33326758142
ARM291	301181329100 Lateral Arm - Rear Left Upper Rearward		33306772241; 33326770775; 33326774793; 33326767759; 33326769971; 33326758141
ARM292	301181329200 Lateral Arm - Rear Upper Forward		33321096797; 33326774795; 33326777424; 33322282065
ARM293	301181329300 Lateral Arm - Rear Right Upper Rearward		33306773942; 33326774842; 33326768790; 33326770840; 33326767968; 33326767754; 33326759158
ARM294	301181329400 Lateral Arm - Rear Left Upper Rearward	Upper	33306773941; 33326774841; 33326768789; 33326770839; 33326767967; 33326767753; 33326759157
ARM295	301181329500 Suspension Control Arm and Ball Joint Assembly - Front Right Lower Forward		31104026720; 31126774826; 31126765996
ARM296	301181329600 Suspension Control Arm and Ball Joint Assembly - Front Left Lower Forward		31104026719; 31126774825; 31126765995
ARM297	301181329700 Suspension Control Arm and Ball Joint Assembly - Front Right Lower Rearward		31126760182
ARM298	301181329800 Suspension Control Arm and Ball Joint Assembly - Front Left Lower		31126760181
ARM314	301181331400 Lateral Arm - Rear		33321090030; 33326770749; 33321091620
SSP0022	301191600220 Steering Tie Rod - Front	M16X1,5Rht	32216762403*
SSP0316	301191603160 Steering Tie Rod End - Front	(XD) M16X1,5Rht	32106774361; 32216756369; 32106776946
SSP0327	301191603270 Steering Tie Rod End - Front		32216767860
SSP1791	301191617910 Suspension Ball Joint - Front		31126779840
SSP2056	301191620560 Suspension Stabilizer Bar Link - Front Right	L=300mm	31306781548; 31356760986; 31356769500; 31354014532
SSP2057	301191620570 Suspension Stabilizer Bar Link - Front Left	L=300mm	31306781547; 31356760985; 31356769499; 31354014531
SSP2058	301191620580 Suspension Stabilizer Bar Link - Rear	L=135.3mm	33506781540; 33556761000

BMW 5 SERIES E60 - E61, xDrive AWD  07/2003-03/2010

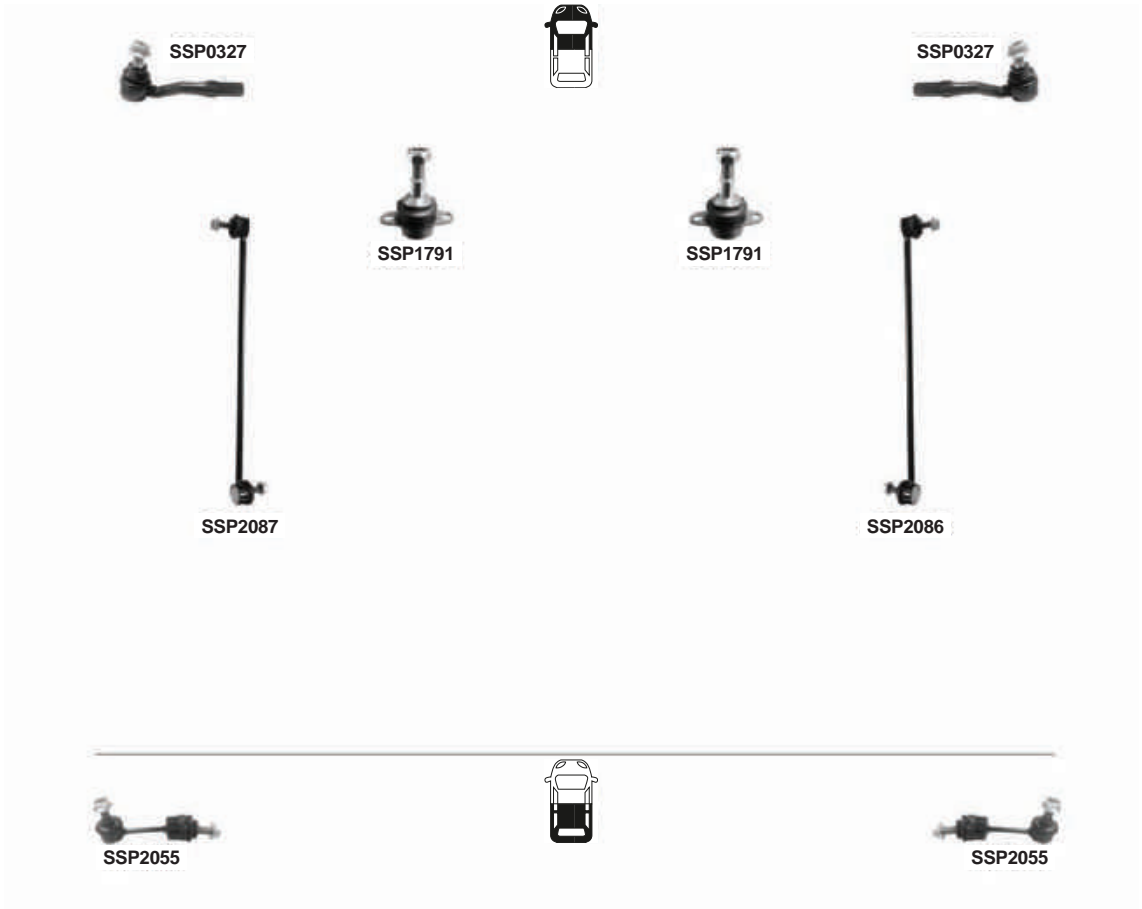

PART NO.	DESCRIPTION	NOTES	O.E.
ARM361	301181336100 Suspension Control Arm and Ball Joint Assembly - Front Right Rearward	xdrive Aluminium	31122347982; 31106770690; 31126774828
ARM362	301181336200 Suspension Control Arm and Ball Joint Assembly - Front Left Rearward	xdrive Aluminium	31122347981; 31126774827; 31106770689
SSP0327	301191603270 Steering Tie Rod End - Front		32216767860
SSP1791	301191617910 Suspension Ball Joint - Front		31126779840
SSP2055	301191620550 Suspension Stabilizer Bar Link - Rear	A = (For vehicles with active stabilizer) 103.4 MM	33506768492; 33506781537; 33506768493
SSP2086	301191620860 Suspension Stabilizer Bar Link - Front Right	(xdrive) 4X4 A = L-420mm	31306781550
SSP2087	301191620870 Suspension Stabilizer Bar Link - Front Left	(xdrive) 4X4 A = L-420mm	31306781549



BMW 5 SERIES F



2010-2016



PART NO.	DESCRIPTION	NOTES	O.E.
ARM346	Suspension Control Arm and Ball Joint Assembly - Front Right Lower Rearward		31126794204; 31126850782
ARM347	Suspension Control Arm and Ball Joint Assembly - Front Left Lower Rearward		31126794203; 31126850781
ARM350	Suspension Control Arm and Ball Joint Assembly - Front Upper		31126775967
ARM351	Suspension Control Arm and Ball Joint Assembly - Front Right Lower Forward		31126775972
ARM352	Suspension Control Arm and Ball Joint Assembly - Front Left Lower Forward		31126775971
ARM353	Lateral Arm - Rear		33326775902
SSP0026	Steering Tie Rod - Front	M14X1,5 - L=245mm	32106784716
SSP0325	Steering Tie Rod End - Front Right	M14X1,5	32106784796
SSP0326	Steering Tie Rod End - Front Left	M14X1,5	32106784790
SSP2082	Suspension Stabilizer Bar Link - Rear Forward	(i xDrive) L=110mm / M12x1.5	37106775189
SSP2083	Suspension Stabilizer Bar Link - Front	L=300mm	31356777319
SSP2084	Suspension Stabilizer Bar Link - Rear	L=110mm	33556777635
SSP2085	Suspension Stabilizer Bar Link - Rear Forward	L=107,5mm	33326775683



BMW 6 SERIES E63, E64



01/2004-11/2010

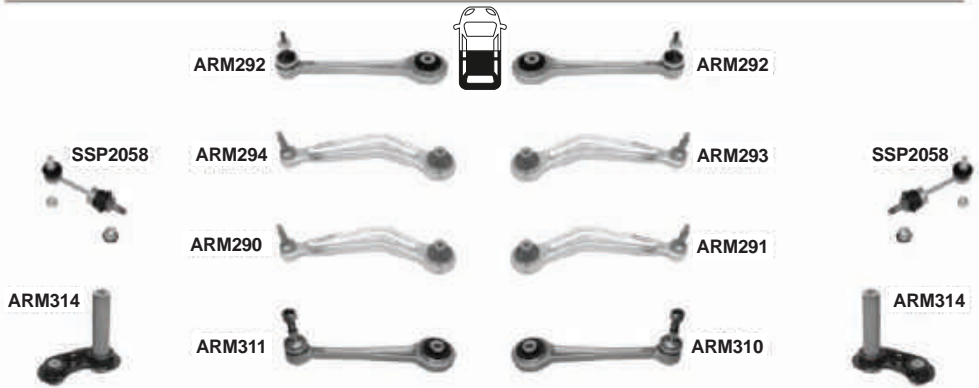
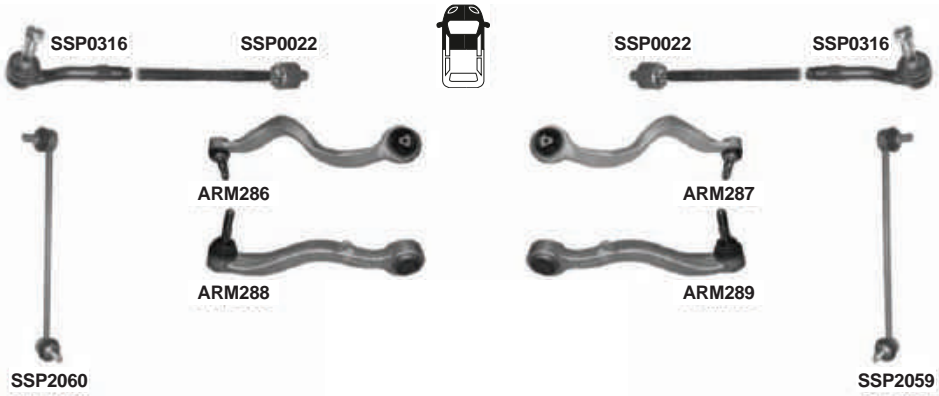

**BMW 6 SERIES E63, E64**

01/2004-11/2010

	PART NO.	DESCRIPTION	NOTES	O.E.
ARM286	301181328600	Suspension Control Arm and Ball Joint Assembly - Front Left Lower Rearward		31124026453; 31126774831; 31126756101
ARM287	301181328700	Suspension Control Arm and Ball Joint Assembly - Front Right Lower Forward		31126756102; 31126774832; 31126765994
ARM288	301181328800	Suspension Control Arm and Ball Joint Assembly - Front Left Lower Forward		31126755835; 31126777937; 31126777939; 31126770121
ARM289	301181328900	Suspension Control Arm and Ball Joint Assembly - Front Right Lower Forward		31126755836; 31126777938; 31126777940; 31126770122
ARM290	301181329000	Lateral Arm - Rear Right Upper Rearward		33306772242; 33326774794; 33326767760; 33326770776; 33326758142
ARM291	301181329100	Lateral Arm - Rear Left Upper Rearward		33306772241; 33326770775; 33326774793; 33326767759; 33326769971; 33326758141
ARM292	301181329200	Lateral Arm - Rear Upper Forward		33321096797; 33326774795; 33326774424; 33322282065
ARM293	301181329300	Lateral Arm - Rear Right Upper Rearward		33306773942; 33326774842; 33326768790; 33326770840; 33326767968; 33326767754; 33326759158
ARM294	301181329400	Lateral Arm - Rear Left Upper Rearward	Upper	33306773941; 33326774841; 33326768789; 33326770839; 33326767967; 33326767753; 33326759157
ARM310	301181331000	Lateral Arm - Rear Right Forward	Type: E-60/E63/E65 L=212mm	33326775084
ARM311	301181331100	Lateral Arm - Rear Left Forward	Type: E-60/E63/E65 L=212mm	33326775083
ARM314	301181331400	Lateral Arm - Rear		33321090030; 33326770749; 33321091620
SSP0022	301191600220	Steering Tie Rod - Front	M16X1,5Rht	32216762403*
SSP0316	301191603160	Steering Tie Rod End - Front	(XD) M16X1,5Rht	32106774361; 32216756369; 32106776946
SSP2058	301191620580	Suspension Stabilizer Bar Link - Rear	L=135.3mm	33506781540; 33556761000
SSP2059	301191620590	Suspension Stabilizer Bar Link - Front Right	L=332mm	31356769664
SSP2060	301191620600	Suspension Stabilizer Bar Link - Front Left	L=332mm	31356769663



BMW 6 SERIES F



2011-2016

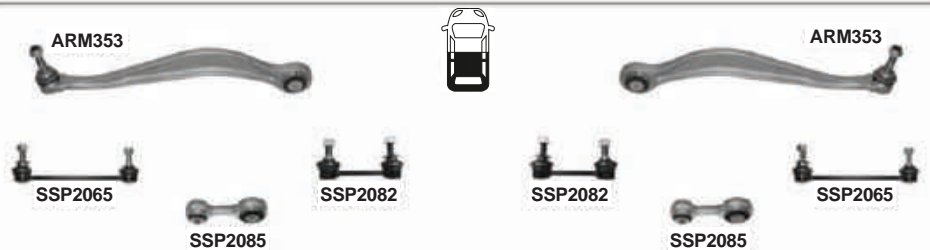

PART NO.	DESCRIPTION	NOTES	O.E.
ARM346 301181334600	Suspension Control Arm and Ball Joint Assembly - Front Right Lower Rearward		31126794204; 31126850782
ARM347 301181334700	Suspension Control Arm and Ball Joint Assembly - Front Left Lower Rearward		31126794203; 31126850781
ARM350 301181335000	Suspension Control Arm and Ball Joint Assembly - Front Upper		31126775967
ARM351 301181335100	Suspension Control Arm and Ball Joint Assembly - Front Right Lower Forward		31126775972
ARM352 301181335200	Suspension Control Arm and Ball Joint Assembly - Front Left Lower Forward		31126775971
ARM353 301181335300	Lateral Arm - Rear		33326775902
SSP0026 301191600260	Steering Tie Rod - Front	M14X1,5 - L=245mm	32106784716
SSP0325 301191603250	Steering Tie Rod End - Front Right	M14X1,5	32106784796
SSP0326 301191603260	Steering Tie Rod End - Front Left	M14X1,5	32106784790
SSP2065 301191620650	Suspension Stabilizer Bar Link - Rear	L=200 mm	33556786429
SSP2082 301191620820	Suspension Stabilizer Bar Link - Rear Forward	(i xDrive) L=110mm / M12x1.5	37106775189
SSP2083 301191620830	Suspension Stabilizer Bar Link - Front	L=300mm	31356777319
SSP2085 301191620850	Suspension Stabilizer Bar Link - Rear Forward	L=107,5mm	33326775683



BMW 7 SERIES E38



1994-2002



SSP0318

SSP0317



SSP0001



ARM300



ARM299



ARM302



ARM303



SSP2066



SSP2066



ARM301



ARM301



ARM304



ARM305



ARM314



SSP2067



SSP2067



ARM314

PART NO.	DESCRIPTION	NOTES	O.E.
ARM299	301181329900 Suspension Control Arm and Ball Joint Assembly - Front Right Lower Rearward		31121141722; 31121141724
ARM300	301181330000 Suspension Control Arm and Ball Joint Assembly - Front Left Lower Rearward		31121141721; 31121141723
ARM301	301181330100 Lateral Arm - Rear Upper Forward		33321090745; 33321097264
ARM302	301181330200 Suspension Control Arm and Ball Joint Assembly - Front Right Lower Forward		31121142088
ARM303	301181330300 Suspension Control Arm and Ball Joint Assembly - Front Left Lower Forward		31121142087
ARM304	301181330400 Lateral Arm - Rear Right		33321090906
ARM305	301181330500 Lateral Arm - Rear Left		33321090905
ARM314	301181331400 Lateral Arm - Rear		33321090030; 33326770749; 33321091620
SSP0001	301191600010 Steering Center Link - N/A	L=900mm	32211091913; 32211096057; 32211093433
SSP0317	301191603170 Steering Tie Rod End - Front Right	M16X1,5	32211141346
SSP0318	301191603180 Steering Tie Rod End - Front Left	M16X1,5	32211141345
SSP2066	301191620660 Suspension Stabilizer Bar Link - Front	L=308mm	31351091496; 31351095695
SSP2067	301191620670 Suspension Stabilizer Bar Link - Rear	L=75mm	33551091497; 33551095696



BMW 7 SERIES E65, E66, E67



01/2001-09/2008

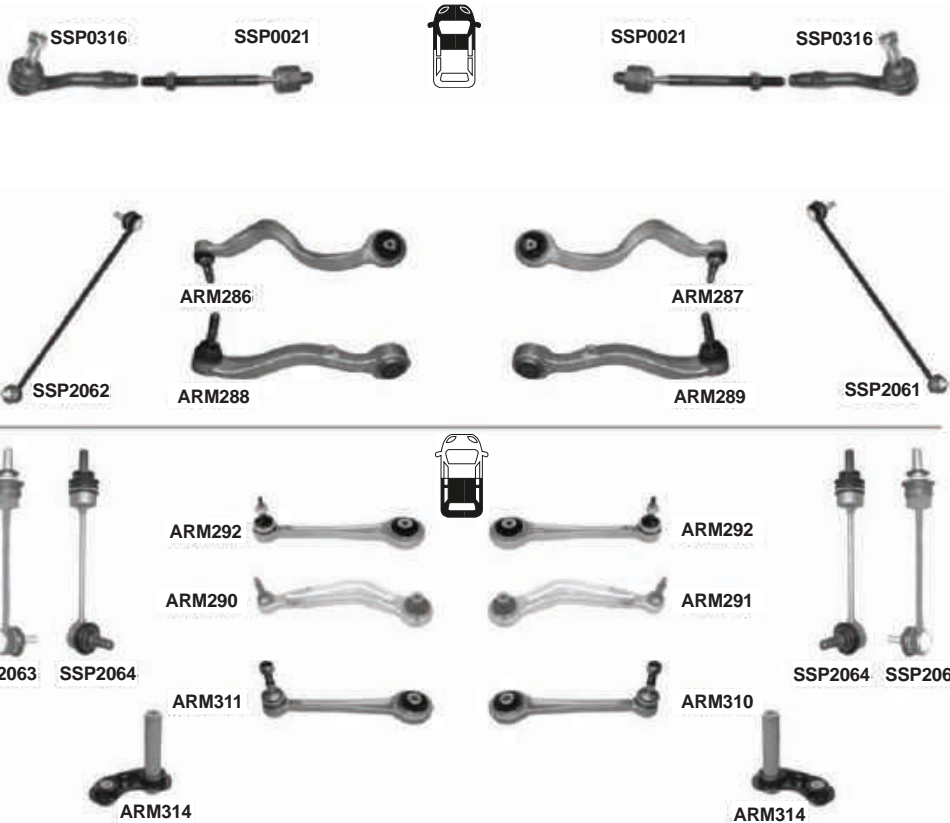

PART NO.	DESCRIPTION	NOTES	O.E.
ARM286	Suspension Control Arm and Ball Joint Assembly - Front Left Lower Rearward		31124026453; 31126774831; 31126756101
ARM287	Suspension Control Arm and Ball Joint Assembly - Front Right Lower Forward		31126756102; 31126774832; 31126765994
ARM288	Suspension Control Arm and Ball Joint Assembly - Front Left Lower Forward		31126755835; 31126777937; 31126777939; 31126770121
ARM289	Suspension Control Arm and Ball Joint Assembly - Front Right Lower Forward		31126755836; 31126777938; 31126777940; 31126770122
ARM290	Lateral Arm - Rear Right Upper Rearward		33306772242; 33326774794; 33326767760; 33326770776; 33326758142
ARM291	Lateral Arm - Rear Left Upper Rearward		33306772241; 33326770775; 33326774793; 33326767759; 33326769971; 33326758141
ARM292	Lateral Arm - Rear Upper Forward		33321096797; 33326774795; 33326777424; 3332282065
ARM310	Lateral Arm - Rear Right Forward	Type: E-60/E63/E65 L=212mm	33326775084
ARM311	Lateral Arm - Rear Left Forward	Type: E-60/E63/E65 L=212mm	33326775083
ARM314	Lateral Arm - Rear		33321090030; 33326770749; 33321091620
SSP0021	Steering Tie Rod - Front	M16x1,5 - L=229mm	32216756368 Part of
SSP0316	Steering Tie Rod End - Front	(XD) M16X1,5Rht	32106774361; 32216756369; 32106776946
SSP2061	Suspension Stabilizer Bar Link - Front Right	L=425mm	31306781546; 31356753768
SSP2062	Suspension Stabilizer Bar Link - Front Left	L=425mm	31306781545; 31356753767
SSP2063	Suspension Stabilizer Bar Link - Rear	L=227mm	33506781538; 33556757460
SSP2064	Suspension Stabilizer Bar Link - Rear	L=216mm	33506781539; 33556753770



BMW 7 SERIES F01, F02, F03, F04



06/2008-2016

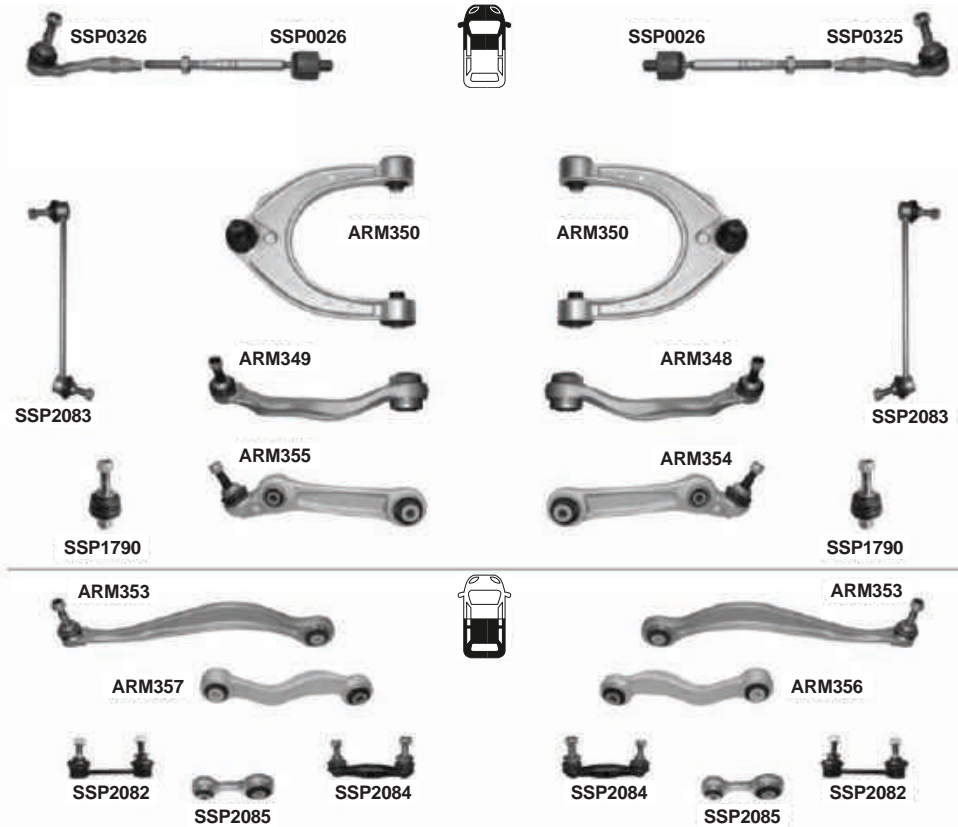

	PART NO.	DESCRIPTION	NOTES	O.E.
ARM348	301181334800	Suspension Control Arm and Ball Joint Assembly - Front Right Lower Forward		31126775960
ARM349	301181334900	Suspension Control Arm and Ball Joint Assembly - Front Left Lower Forward		31126775959
ARM350	301181335000	Suspension Control Arm and Ball Joint Assembly - Front Upper		31126775967
ARM353	301181335300	Lateral Arm - Rear		33326775902
ARM354	301181335400	Suspension Control Arm and Ball Joint Assembly - Front Right Lower Rearward		31126775964; 31126850782; 31126798108
ARM355	301181335500	Suspension Control Arm and Ball Joint Assembly - Front Left Lower Rearward		31126775963; 31126850781; 31126798107
ARM356	301181335600	Lateral Arm - Rear Right		33326782132
ARM357	301181335700	Lateral Arm - Rear Left		33326782131
SSP0026	301191600260	Steering Tie Rod - Front	M14X1,5 - L=245mm	32106784716
SSP0325	301191603250	Steering Tie Rod End - Front Right	M14X1,5	32106784796
SSP0326	301191603260	Steering Tie Rod End - Front Left	M14X1,5	32106784790
SSP1790	301191617900	Suspension Ball Joint - Front Lower	Only : xDrive	31126777753
SSP2082	301191620820	Suspension Stabilizer Bar Link - Rear Forward	(i xDrive) L=110mm / M12x1.5	37106775189
SSP2083	301191620830	Suspension Stabilizer Bar Link - Front	L=300mm	31356777319
SSP2084	301191620840	Suspension Stabilizer Bar Link - Rear	L=110mm	33556777635
SSP2085	301191620850	Suspension Stabilizer Bar Link - Rear Forward	L=107,5mm	33326775683



	PART NO.	DESCRIPTION	NOTES	O.E.
ARM350	301181335000	Suspension Control Arm and Ball Joint Assembly - Front Upper		31126775967
SSP2040	301191620400	Suspension Stabilizer Bar Link - Rear Right	L=136mm	33506785608



BMW M3 E46



2001-2006



	PART NO.	DESCRIPTION	NOTES	O.E.
ARM284	301181328400	Suspension Control Arm and Ball Joint Assembly - Front Right		31122229454
ARM285	301181328500	Suspension Control Arm and Ball Joint Assembly - Front Left		31122229453

BMW M5 E39



11/1995-06/2003



	PART NO.	DESCRIPTION	NOTES	O.E.
ARM308	301181330800	Suspension Control Arm and Ball Joint Assembly - Front Right Lower Rearward	(only 535i, 540i, M5)	31121092610
ARM309	301181330900	Suspension Control Arm and Ball Joint Assembly - Front Left Lower Rearward	(only 535i, 540i, M5)	31121092609



BMW X1 E84 (xDrive) 4x4



10/2009-2016

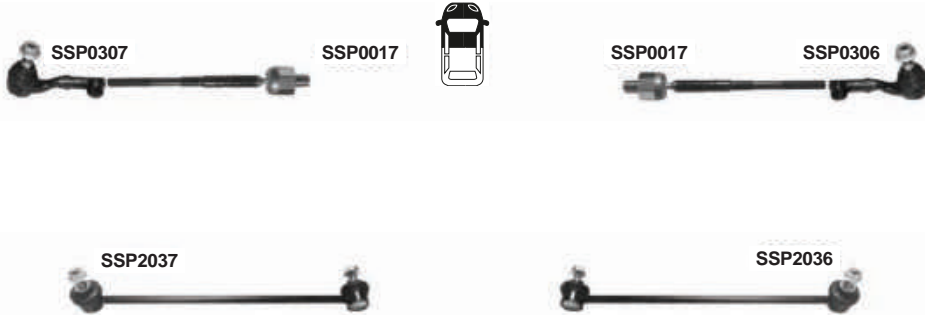

PART NO.	DESCRIPTION	NOTES	O.E.
SSP0017 301191600170	Steering Tie Rod - Front	C = (xDrive) 4x4 M18X1.5	32106793621/622 Part of
SSP0306 301191603060	Steering Tie Rod End - Front Right	(xDrive) 4x4 M14X1,5	32106769074; 32106793624
SSP0307 301191603070	Steering Tie Rod End - Front Left	xdrive M14X1,5	32106769073; 32106793623
SSP2036 301191620360	Suspension Stabilizer Bar Link - Front Right	Metal Type (xDrive) 4x4 A = 340 MM	31356768772
SSP2037 301191620370	Suspension Stabilizer Bar Link - Front Left	Metal Type (xDrive) 4x4 A = 340 MM	31356768771

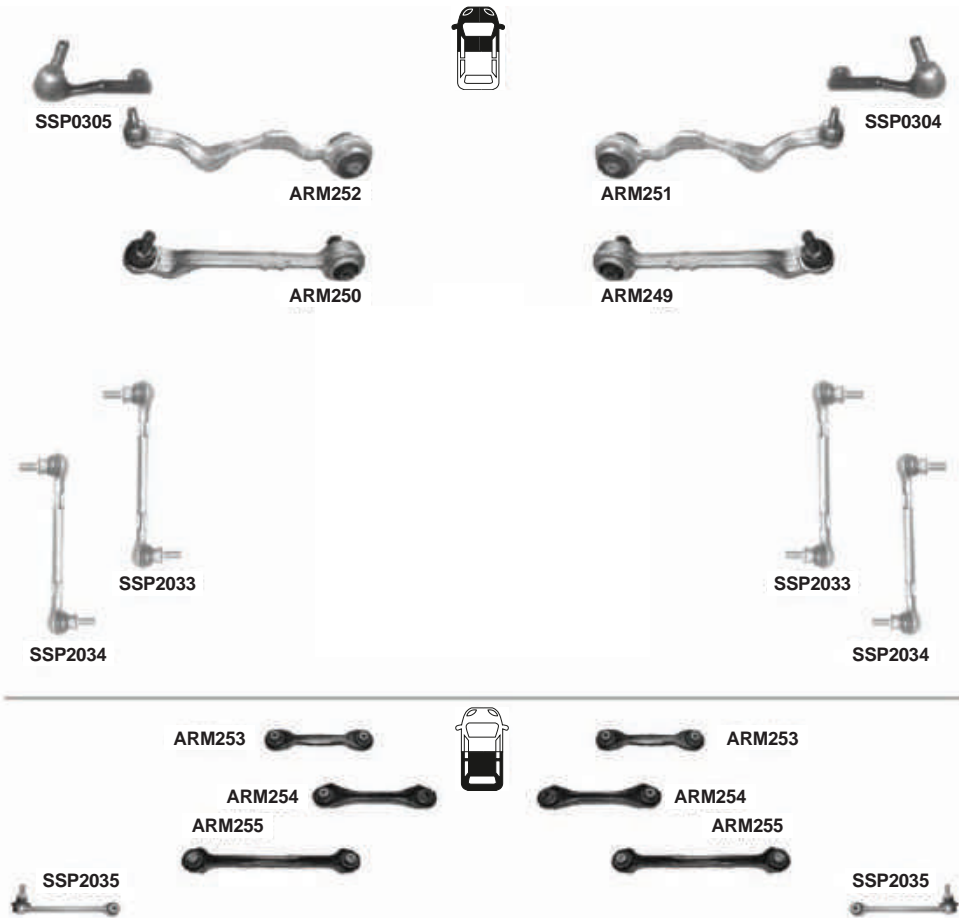

PART NO.	DESCRIPTION	NOTES	O.E.
ARM249	Suspension Control Arm and Ball Joint Assembly - Front Right Lower Rearward		31126763700; 31126769794; 31126770850
ARM250	Suspension Control Arm and Ball Joint Assembly - Front Left Lower Rearward		31126763699; 31126769793; 31126770849
ARM251	Suspension Control Arm and Ball Joint Assembly - Front Right Lower Forward		31124036270; 31126769798; 31126763704; 31126763708
ARM252	Suspension Control Arm and Ball Joint Assembly - Front Left Lower Forward		31124036269; 31126769797; 31126763703; 31126763707
ARM253	Lateral Arm - Rear Upper Forward		33326765425; 33326765534; 33326782237
ARM254	Lateral Arm - Rear Upper Rearward		33326763473; 33326777980
ARM255	Lateral Arm - Rear Lower Rearward		33326763471
ARM360	Suspension Control Arm and Ball Joint Assembly - Front	xdrive	31122405863; 31126768989
SSP0304	Steering Tie Rod End - Front Right	M14X1,5	32106767782; 32106765090
SSP0305	Steering Tie Rod End - Front Left	M14X1,5	32106767781; 32106765089
SSP2033	Suspension Stabilizer Bar Link - Front Right	L=290mm	31356765934
SSP2034	Suspension Stabilizer Bar Link - Front Left	L=290mm	31356765933
SSP2035	Suspension Stabilizer Bar Link - Rear	L=160mm	33556764428



BMW X1 F48



2015-



PART NO.	DESCRIPTION	NOTES	O.E.
ARM248 301181324800	Lateral Arm - Rear Upper		33326870773; 33326851563
SSP0014 301191600140	Steering Tie Rod - Front		Part of 32106867404; Part of 32106867405
SSP0302 301191603020	Steering Tie Rod End - Front Right		32106867405; 32106854734
SSP0303 301191603030	Steering Tie Rod End - Front Left		32106867404; 32106854737
SSP2443 301191624430	Suspension Stabilizer Bar Link - Rear		33506862865



BMW X3 E83



01/2004-08/2010

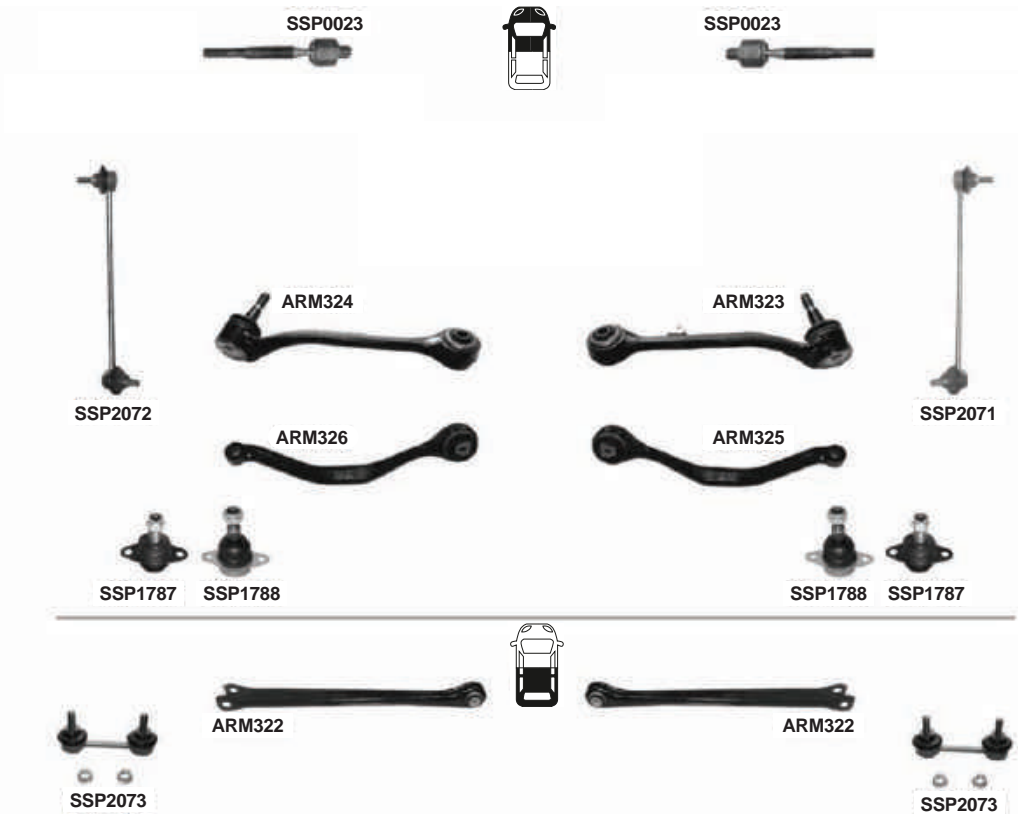

PART NO.	DESCRIPTION	NOTES	O.E.
ARM322 301181332200	Lateral Arm - Rear Lower		33303411651; 33326770813; 33326760675
ARM323 301181332300	Suspension Control Arm and Ball Joint Assembly - Front Right Lower Rearward	Front Lower Rear	31103415028; 31103426434
ARM324 301181332400	Suspension Control Arm and Ball Joint Assembly - Front Left Lower Rearward	Front Lower Rear	31103415027; 31103451881; 31103426433
ARM325 301181332500	Suspension Control Arm - Front Right Lower Forward	Lower Front	31103412138; 31103443128
ARM326 301181332600	Suspension Control Arm - Front Left Lower Forward	Lower Front	31103412137; 31103443127
SSP0023 301191600230	Steering Tie Rod - Front	M14x1,5Rht - L=219mm	32106793496*; 32303418204*
SSP1787 301191617870	Suspension Ball Joint - Front Lower		31103412726; 31103418341
SSP1788 301191617880	Suspension Ball Joint - Front Lower Forward	Only: X-Drive 4x4	31100363476; 31103438623
SSP2071 301191620710	Suspension Stabilizer Bar Link - Front Right	L=300 mm	31303413202; 31303413300
SSP2072 301191620720	Suspension Stabilizer Bar Link - Front Left	L=300 mm	31303413201; 31303413299
SSP2073 301191620730	Suspension Stabilizer Bar Link - Rear	L=95mm	33503413197; 33503414297



BMW X3 F25



09/2010-2016

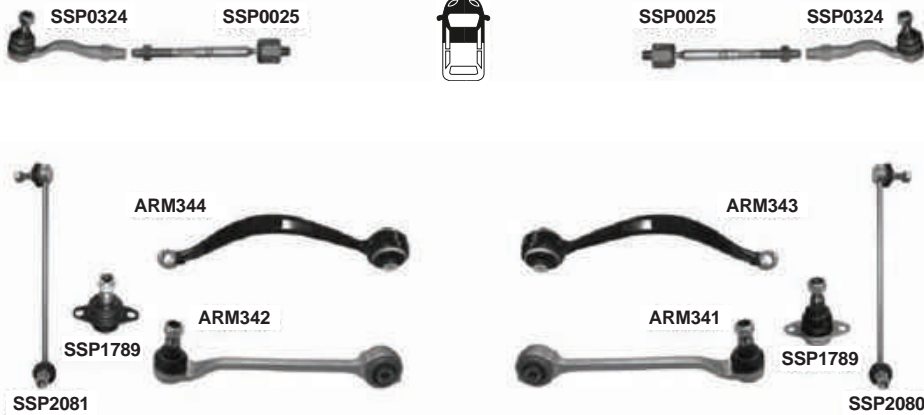

PART NO.	DESCRIPTION	NOTES	O.E.
ARM337	301181333700 Lateral Arm - Rear Upper		33326786981
ARM338	301181333800 Lateral Arm - Rear Lower		33326786978
ARM339	301181333900 Lateral Arm - Rear Right		33326788550
ARM340	301181334000 Lateral Arm - Rear Left		33326788549
ARM341	301181334100 Suspension Control Arm and Ball Joint Assembly - Front Right Lower Rearward	With ball joint	31126787670
ARM342	301181334200 Suspension Control Arm and Ball Joint Assembly - Front Left Lower Rearward	With ball joint	31126787669
ARM343	301181334300 Suspension Control Arm - Front Right Lower Forward		31106787674
ARM344	301181334400 Suspension Control Arm - Front Left Lower Forward		31106787673
ARM358	301181335800 Lateral Arm - Rear		33306786991
SSP0025	301191600250 Steering Tie Rod - Front	M16X1,5	Part of: 32106787472
SSP0324	301191603240 Steering Tie Rod End - Front	M16X1,5	32106792674
SSP1789	301191617890 Suspension Ball Joint - Front Lower		31106787665
SSP2079	301191620790 Suspension Stabilizer Bar Link - Rear	L=134mm	33556790324
SSP2080	301191620800 Suspension Stabilizer Bar Link - Front Right	L=340mm	31306787164
SSP2081	301191620810 Suspension Stabilizer Bar Link - Front Left	L=340mm	31306787163



BMW X4 F26



04/2014-



PART NO.	DESCRIPTION	NOTES	O.E.
ARM341	301181334100 Suspension Control Arm and Ball Joint Assembly - Front Right Lower Rearward	With ball joint	31126787670
ARM342	301181334200 Suspension Control Arm and Ball Joint Assembly - Front Left Lower Rearward	With ball joint	31126787669
ARM343	301181334300 Suspension Control Arm - Front Right Lower Forward		31106787674
ARM344	301181334400 Suspension Control Arm - Front Left Lower Forward		31106787673
ARM358	301181335800 Lateral Arm - Rear		33306786991
SSP0025	301191600250 Steering Tie Rod - Front	M16X1,5	Part of: 32106787472
SSP0324	301191603240 Steering Tie Rod End - Front	M16X1,5	32106792674
SSP1789	301191617890 Suspension Ball Joint - Front Lower		31106787665
SSP2079	301191620790 Suspension Stabilizer Bar Link - Rear	L=134mm	33556790324
SSP2080	301191620800 Suspension Stabilizer Bar Link - Front Right	L=340mm	31306787164
SSP2081	301191620810 Suspension Stabilizer Bar Link - Front Left	L=340mm	31306787163



BMW X5 E53



05/2000-01/2007





BMW X5 E53



05/2000-01/2007

	PART NO.	DESCRIPTION	NOTES	O.E.
ARM314	301181331400	Lateral Arm - Rear		33321090030; 33326770749; 33321091620
ARM315	301181331500	Suspension Control Arm - Front Right Lower Forward		31121096170; 31126769718
ARM316	301181331600	Suspension Control Arm - Front Left Lower Forward		31121096169; 31126769717
ARM317	301181331700	Suspension Control Arm and Ball Joint Assembly - Front Right Lower Rearward	M14x1,5Rht	31121096316; 31126760276
ARM318	301181331800	Suspension Control Arm and Ball Joint Assembly - Front Left Lower Rearward	M14x1,5Rht	31121096315; 31126760275
ARM319	301181331900	Lateral Arm - Rear Right		33321095412; 33326770860; 33326770748; 33326768274
ARM320	301181332000	Lateral Arm - Rear Left		33321095411; 33326770859; 33326770747; 33326768274
ARM321	301181332100	Lateral Arm - Rear Upper		33321095414; 33326788269; 33326774796
SSP0023	301191600230	Steering Tie Rod - Front	M14x1,5Rht - L=219mm	32106793496*; 32303418204*
SSP0321	301191603210	Steering Tie Rod End - Front Outer	M14x1,5Rht	32211096327
SSP0322	301191603220	Steering Tie Rod End - Front Outer	M14x1,5Rht	32106774335; 32216760354
SSP1786	301191617860	Suspension Ball Joint - Front Lower		31121096425; 31126756491
SSP2068	301191620680	Suspension Stabilizer Bar Link - Front Right	L=359mm	31356750704
SSP2069	301191620690	Suspension Stabilizer Bar Link - Front Left	L=359mm	31356750703
SSP2070	301191620700	Suspension Stabilizer Bar Link - Rear	L=65mm	33551096735



BMW X5 E70



02/2007-12/2012





BMW X5 E70



02/2007-12/2012

PART NO.	DESCRIPTION	NOTES	O.E.
ARM327	301181332700 Lateral Arm - Rear Right Upper Forward		33324046918; 33326795048; 33326779388; 33326770964
ARM328	301181332800 Lateral Arm - Rear Left Upper		33324046917; 33326795047; 33326779387; 33326770963
ARM329	301181332900 Lateral Arm - Rear Right Upper Rearward		33326770970
ARM330	301181333000 Lateral Arm - Rear Left		33326770969
ARM331	301181333100 Suspension Control Arm and Ball Joint Assembly - Front Right Lower		31126773950
ARM332	301181333200 Suspension Control Arm and Ball Joint Assembly - Front Left Lower		31126773949
ARM333	301181333300 Suspension Control Arm and Ball Joint Assembly - Front Right Lower Rearward		31126771894
ARM334	301181333400 Suspension Control Arm and Ball Joint Assembly - Front Left Lower Rearward		31126771893
ARM335	301181333500 Suspension Control Arm and Ball Joint Assembly - Front Right Upper		31126776418
ARM336	301181333600 Suspension Control Arm and Ball Joint Assembly - Front Left Upper		31126776417
ARM359	301181335900 Lateral Arm - Rear		33326774476
SSP0023	301191600230 Steering Tie Rod - Front	M14x1,5Rht - L=219mm	32106793496*; 32303418204*
SSP0323	301191603230 Steering Tie Rod End - Front	M14X1,5 Rht	32106780984; 32216773739; 32106793497
SSP2074	301191620740 Suspension Stabilizer Bar Link - Rear	L=131,5mm	33556771937
SSP2075	301191620750 Suspension Stabilizer Bar Link - Front Right	L=248mm	31356773024
SSP2076	301191620760 Suspension Stabilizer Bar Link - Front Left	L=248mm	31356773023
SSP2077	301191620770 Suspension Stabilizer Bar Link - Front Right	With Dynamic control L= 247mm	37116771930
SSP2078	301191620780 Suspension Stabilizer Bar Link - Front Left	With Dynamic control L= 247mm	37116771929



BMW X5 F15,F85



11/2012-



SSP0024



SSP0024

SSP0319



ARM336



ARM335



SSP2090



ARM313



ARM312



SSP2089



ARM359



SSP2088



SSP2088



ARM359

PART NO.	DESCRIPTION	NOTES	O.E.
ARM312	Suspension Control Arm and Ball Joint Assembly - Front Right Lower Rearward		31126864822
ARM313	Suspension Control Arm and Ball Joint Assembly - Front Left Lower Rearward		31126864821
ARM335	Suspension Control Arm and Ball Joint Assembly - Front Right Upper		31126776418
ARM336	Suspension Control Arm and Ball Joint Assembly - Front Left Upper		31126776417
ARM359	Lateral Arm - Rear		33326774476
SSP0024	Steering Tie Rod - Front		32106858735/737 Part of.
SSP0319	Steering Tie Rod End - Front Right		32 10 6 863 860; 32106858738
SSP0320	Steering Tie Rod End - Front Left		32 10 6 863 858; 32106858736
SSP2088	Suspension Stabilizer Bar Link - Rear	L=131.5mm	33556857626
SSP2089	Suspension Stabilizer Bar Link - Front Right		31356859652
SSP2090	Suspension Stabilizer Bar Link - Front Left		31356859651



BMW X6 E71, E72



04/2008-07/2014

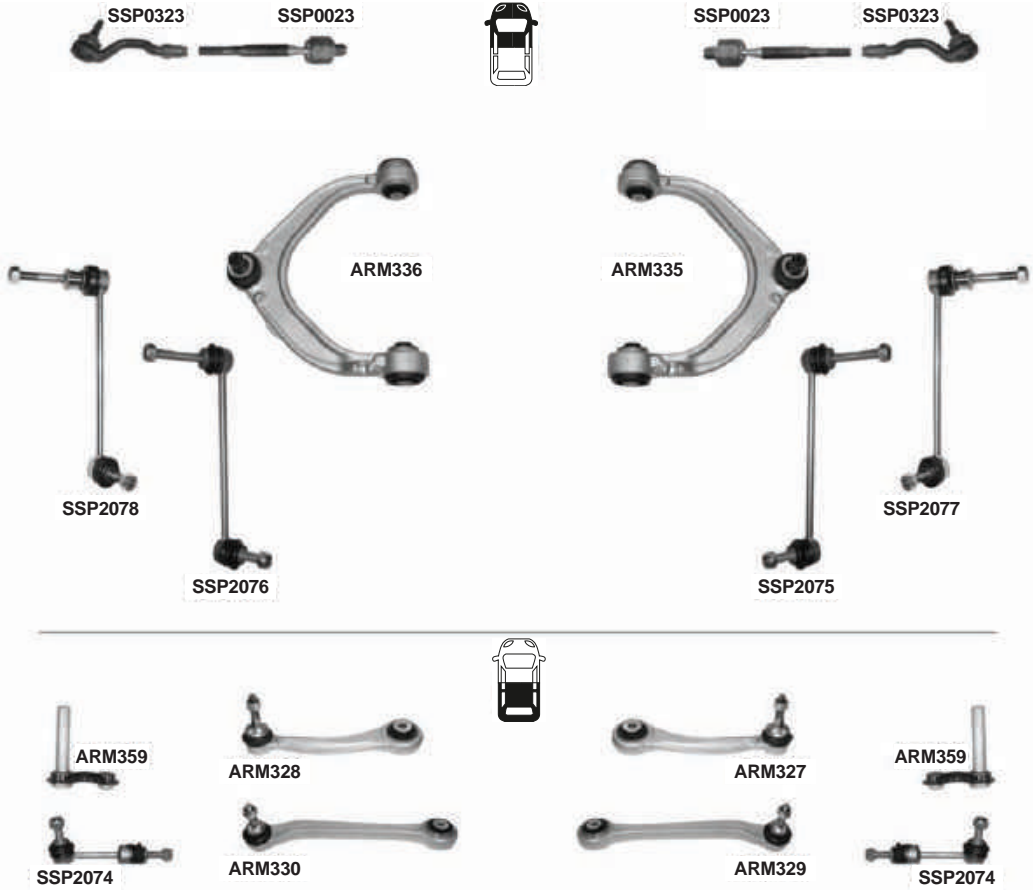

PART NO.	DESCRIPTION	NOTES	O.E.
ARM327	301181332700 Lateral Arm - Rear Right Upper Forward		33324046918; 33326795048; 33326779388; 33326770964
ARM328	301181332800 Lateral Arm - Rear Left Upper		33324046917; 33326795047; 33326779387; 33326770963
ARM329	301181332900 Lateral Arm - Rear Right Upper Rearward		33326770970
ARM330	301181333000 Lateral Arm - Rear Left		33326770969
ARM335	301181333500 Suspension Control Arm and Ball Joint Assembly - Front Right Upper		31126776418
ARM336	301181333600 Suspension Control Arm and Ball Joint Assembly - Front Left Upper		31126776417
ARM359	301181335900 Lateral Arm - Rear		33326774476
SSP0023	301191600230 Steering Tie Rod - Front	M14x1,5Rht - L=219mm	32106793496*; 32303418204*
SSP0323	301191603230 Steering Tie Rod End - Front	M14X1,5 Rht	32106780984; 32216773739; 32106793497
SSP2074	301191620740 Suspension Stabilizer Bar Link - Rear	L=131,5mm	33556771937
SSP2075	301191620750 Suspension Stabilizer Bar Link - Front Right	L=248mm	31356773024
SSP2076	301191620760 Suspension Stabilizer Bar Link - Front Left	L=248mm	31356773023
SSP2077	301191620770 Suspension Stabilizer Bar Link - Front Right	With Dynamic control L= 247mm	37116771930
SSP2078	301191620780 Suspension Stabilizer Bar Link - Front Left	With Dynamic control L= 247mm	37116771929



BMW X6 F16, F85



2014-



	PART NO.	DESCRIPTION	NOTES	O.E.
ARM312	301181331200	Suspension Control Arm and Ball Joint Assembly - Front Right Lower Rearward		31126864822
ARM313	301181331300	Suspension Control Arm and Ball Joint Assembly - Front Left Lower Rearward		31126864821

BMW Z4 E85



02/2003-02/2009

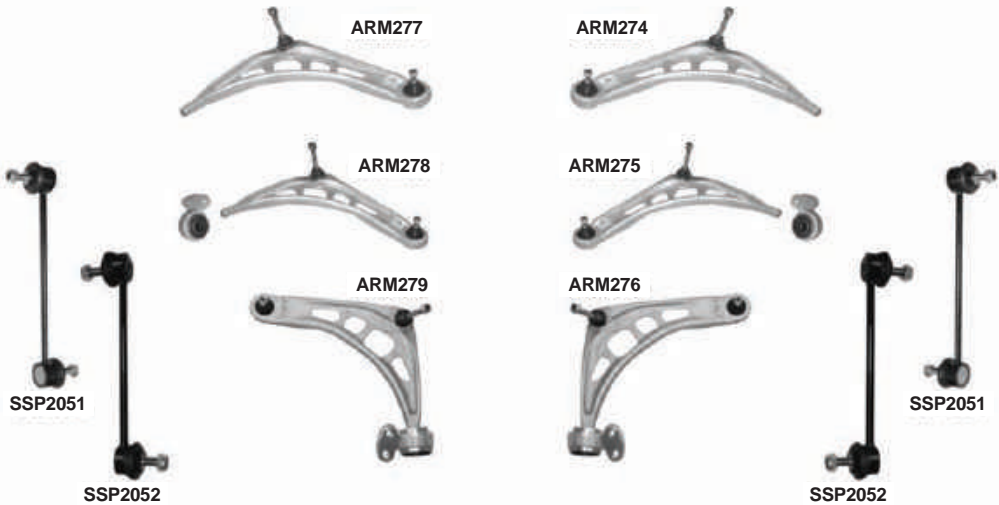

PART NO.	DESCRIPTION	NOTES	O.E.
ARM274 301181327400	Suspension Control Arm and Ball Joint Assembly - Front Right Lower	Alm.	31121094466; 31126758520; 31126752318; 31126752718; 31126751318
ARM275 301181327500	Suspension Control Arm Kit - Front Right Lower	Alm.Complete Kit	31121094466
ARM276 301181327600	Suspension Control Arm Kit - Front Right Lower	Alm.With Mounted Bush	31121094466
ARM277 301181327700	Suspension Control Arm and Ball Joint Assembly - Front Left Lower	Alm.	31121094465; 31126752717; 31126758519; 31126751317
ARM278 301181327800	Suspension Control Arm Kit - Front Left Lower	Alm.Complete Kit	31121094465
ARM279 301181327900	Suspension Control Arm Kit - Front Left Lower	Alm.With Mounted Bush	31121094465
ARM322 301181332200	Lateral Arm - Rear Lower		33303411651; 33326770813; 33326760675
SSP0020 301191600200	Steering Tie Rod - Front	M14x1,5 - L=205mm	32211095950
SSP0314 301191603140	Steering Tie Rod End - Front Right	M14x1,5Rht	32211095958
SSP0315 301191603150	Steering Tie Rod End - Front Left	M14x1,5Rht	32211095957
SSP2050 301191620500	Suspension Stabilizer Bar Link - Rear	L=95 mm	33551094619
SSP2051 301191620510	Suspension Stabilizer Bar Link - Front	L=270 mm	31351095694
SSP2052 301191620520	Suspension Stabilizer Bar Link - Front	(Clip-on patented design) L=270 mm	3135095694*



BUICK ENCLAVE 1st Gen



2008-2015

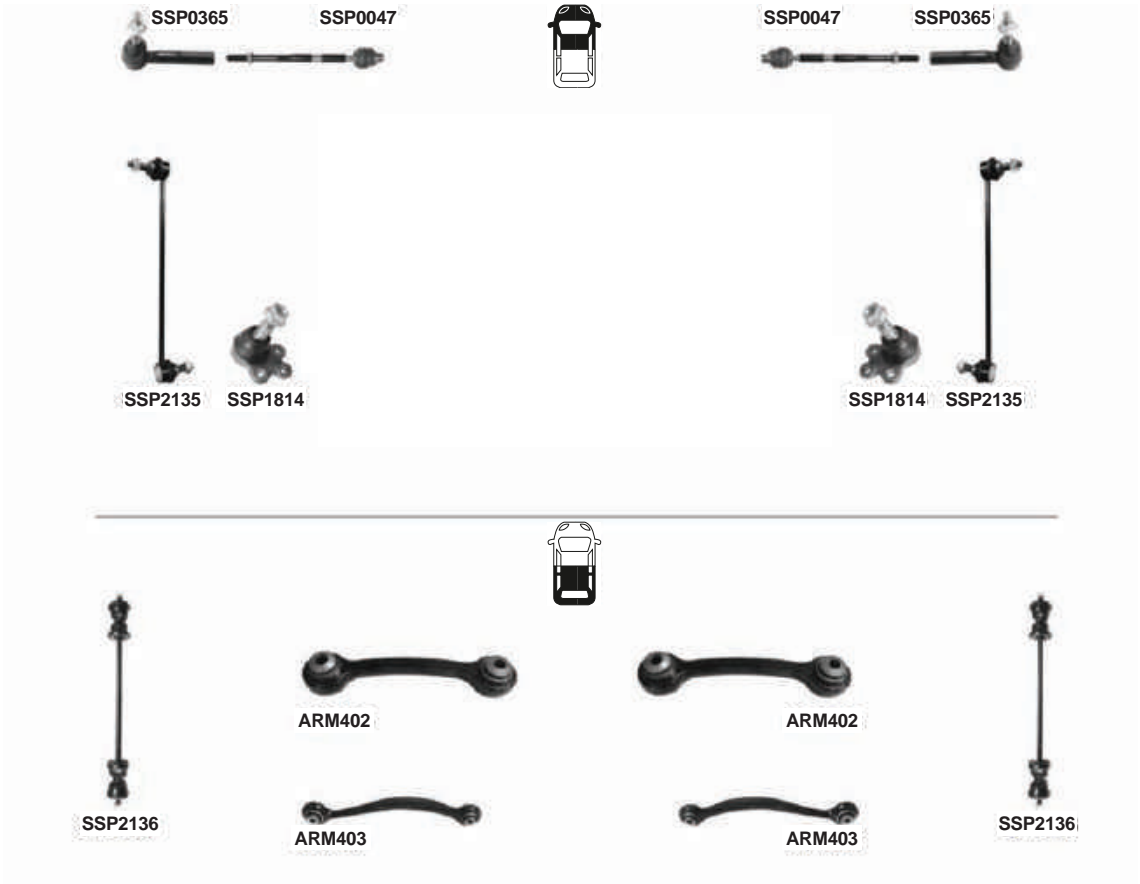

PART NO.	DESCRIPTION	NOTES	O.E.
ARM402	301181340200 Lateral Arm - Rear Upper		15148024
ARM403	301181340300 Lateral Arm - Rear Lower		23461856
SSP0047	301191600470 Steering Tie Rod - Front		20817752
SSP0365	301191603650 Steering Tie Rod End - Front		15869897
SSP1814	301191618140 Suspension Ball Joint - Front		19207521
SSP2135	301191621350 Suspension Stabilizer Bar Link - Front		20905104
SSP2136	301191621360 Suspension Stabilizer Bar Link - Rear		15129234



BUICK ENCORE



2012-2016



PART NO.	DESCRIPTION	NOTES	O.E.
SSP0033 301191600330	Steering Tie Rod - Front	with eps	1609213; 95952929
SSP0598 301191605980	Steering Tie Rod End - Front	Elektrical Type M14X1,5	1609203; 95914910; 95932779
SSP0599 301191605990	Steering Tie Rod End - Front	Hidrolik Type. M14x1.5	1609206
SSP1800 301191618000	Suspension Ball Joint - Front Lower		352532; 95916024
SSP2479 301191624790	Suspension Stabilizer Bar Link - Front Right		15779960; 95942520; 350232*
SSP2480 301191624800	Suspension Stabilizer Bar Link - Front Left		15779961; 350231*



BUICK LACROSSE 2nd Gen



2010-2016



PART NO.	DESCRIPTION	NOTES	O.E.
ARM384	301181338400 Suspension Control Arm and Ball Joint Assembly - Front Right Lower		22854826
ARM385	301181338500 Suspension Control Arm and Ball Joint Assembly - Front Left Lower		22854825
SSP0035	301191600350 Steering Tie Rod - Front		13332651; 1609181
SSP0332	301191603320 Steering Tie Rod End - Front	without performance pkg	22776539
SSP0609	301191606090 Steering Tie Rod End - Front Right	with performance pkg	13272002
SSP0610	301191606100 Steering Tie Rod End - Front Left	with performance pkg	13272001
SSP1792	301191617920 Suspension Ball Joint - Front Upper		13258056
SSP2486	301191624860 Suspension Stabilizer Bar Link - Front		13282833
SSP2488	301191624880 Suspension Stabilizer Bar Link - Rear		444087
SSP2490	301191624900 Suspension Stabilizer Bar Link - Front		13219141; 350617; C13219141



PART NO.	DESCRIPTION	NOTES	O.E.
SSP1808 301191618080	Suspension Ball Joint - Front Lower		C96852964; 96852964; 13258056



BUICK RAINIER 1st Gen



2003-2007

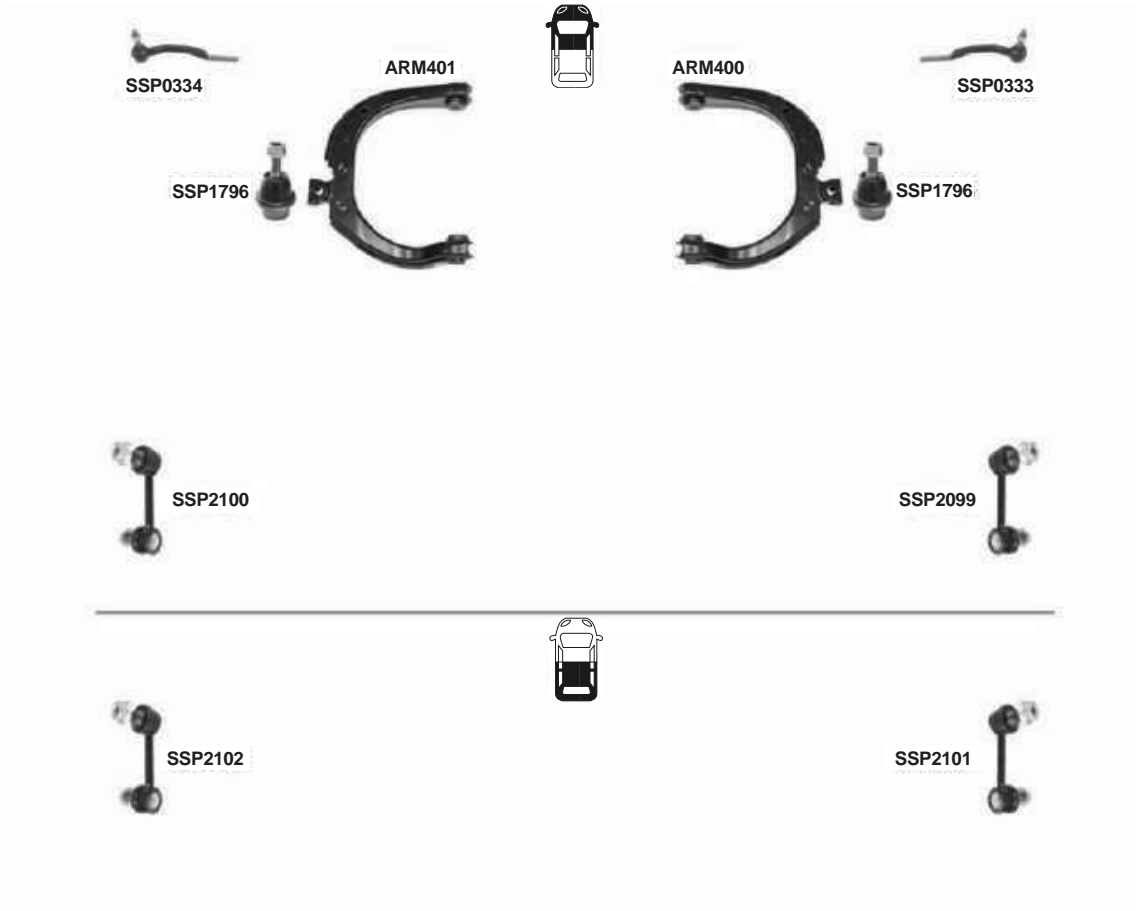

PART NO.	DESCRIPTION	NOTES	O.E.
ARM400 301181340000	Suspension Control Arm - Front Right		25786775
ARM401 301181340100	Suspension Control Arm - Front Left		25786774
SSP0333 301191603330	Steering Tie Rod End - Front Right Outer		26100287; 4011887
SSP0334 301191603340	Steering Tie Rod End - Front Left Outer		26100286; 4011886
SSP1796 301191617960	Suspension Ball Joint - Front Lower	4X4	19133670; 8191336700
SSP2099 301191620990	Suspension Stabilizer Bar Link - Front Right	steel type	15918822
SSP2100 301191621000	Suspension Stabilizer Bar Link - Front Left	steel type	15918823
SSP2101 301191621010	Suspension Stabilizer Bar Link - Rear Left	steel type	88982342; 88965470
SSP2102 301191621020	Suspension Stabilizer Bar Link - Rear Right	steel type	88982343; 88965471



PART NO.	DESCRIPTION	NOTES	O.E.
SSP1808 301191618080	Suspension Ball Joint - Front Lower		C96852964; 96852964; 13258056

**BUICK REGAL 5th Gen**

2011-2016

**SSP0332****SSP0332****SSP2092****SSP2092****SSP2489****SSP2490****ARM385****ARM384****SSP2489****SSP2490**

	PART NO.	DESCRIPTION	NOTES	O.E.
ARM384	301181338400	Suspension Control Arm and Ball Joint Assembly - Front Right Lower		22854826
ARM385	301181338500	Suspension Control Arm and Ball Joint Assembly - Front Left Lower		22854825
SSP0332	301191603320	Steering Tie Rod End - Front		22776539
SSP1792	301191617920	Suspension Ball Joint - Front Upper		13258056
SSP2092	301191620920	Suspension Stabilizer Bar Link - Rear		22810912
SSP2489	301191624890	Suspension Stabilizer Bar Link - Front		13258052; 350618
SSP2490	301191624900	Suspension Stabilizer Bar Link - Front		13219141; 350617; C13219141



BUICK VERANO



2012-2016

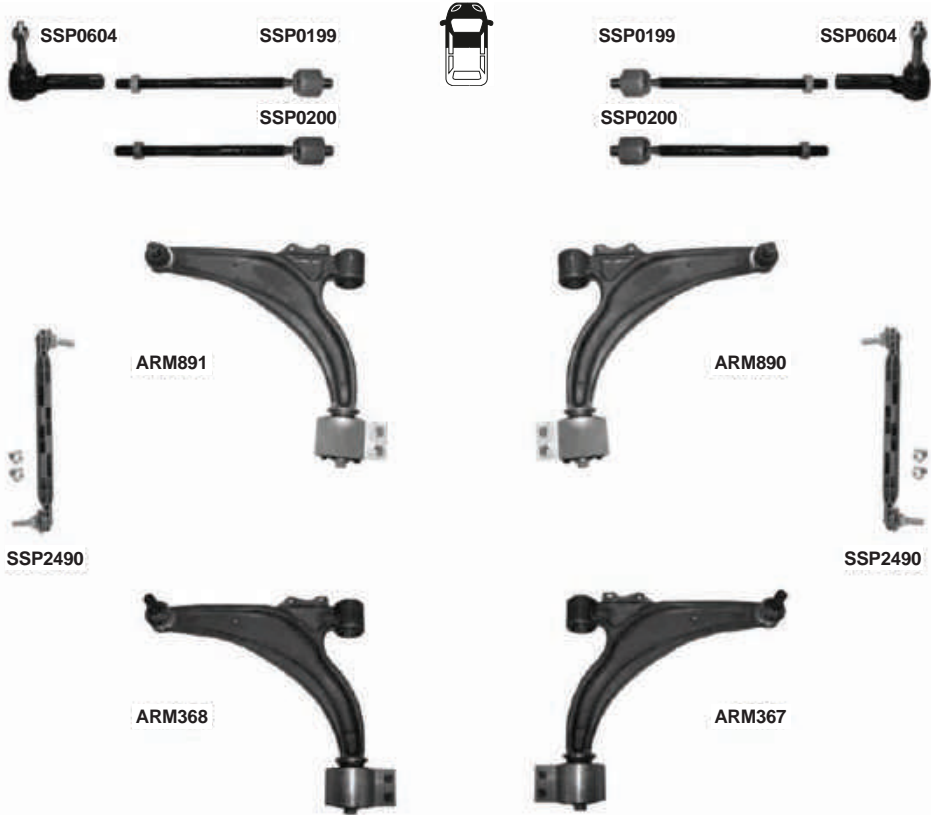

PART NO.	DESCRIPTION	NOTES	O.E.
ARM367	301181336700 Suspension Control Arm and Ball Joint Assembly - Front Right Lower		13334023; C13272606
ARM368	301181336800 Suspension Control Arm and Ball Joint Assembly - Front Left Lower		13334022; C13272605
ARM890	301181389000 Suspension Control Arm and Ball Joint Assembly - Front Right Lower		13272606; 352115; 352493; 13334023; 13321339
ARM891	301181389100 Suspension Control Arm and Ball Joint Assembly - Front Left Lower		13272605; 352110; 352492; 352106; 13321338
SSP0199	301191601990 Steering Tie Rod - Front	Type : POC NJ1 M16X1,5 - L=291mm	13286687; 1609027
SSP0200	301191602000 Steering Tie Rod - Front	Type : POC NJ0 M16X1,5 - L=288mm	13314465; 1609029
SSP0604	301191606040 Steering Tie Rod End - Front		13272000; 1609026; 6606031; 13286686; 13278359
SSP2490	301191624900 Suspension Stabilizer Bar Link - Front		13219141; 350617; C13219141



CADILLAC DEVILLE



2000-2005



PART NO.	DESCRIPTION	NOTES	O.E.
SSP1808 301191618080	Suspension Ball Joint - Front Lower		C96852964; 96852964; 13258056



CADILLAC ESCALADE 1st Gen



1992-2000



PART NO.	DESCRIPTION	NOTES	O.E.
SSP1811 301191618110	Suspension Ball Joint - Front Lower	AWD	12383410; 12380415



CADILLAC ESCALADE 2nd Gen (GMT 800)



2001-2006



SSP1793



SSP1793

PART NO.	DESCRIPTION	NOTES	O.E.
SSP1793 301191617930	Suspension Ball Joint - Front Upper		12475485; 12475486; K6540
SSP1813 301191618130	Suspension Ball Joint - Front Lower		19209396
SSP2091 301191620910	Suspension Stabilizer Bar Link - Front		12542993



CADILLAC ESCALADE 3rd Gen



2007-2014

SSP0364



SSP0364



PART NO.	DESCRIPTION	NOTES	O.E.
SSP0364 301191603640	Steering Tie Rod End - Front Outer		15254061



CADILLAC XTS



2013-2017



PART NO.	DESCRIPTION	NOTES	O.E.
SSP2488 301191624880	Suspension Stabilizer Bar Link - Rear		444087



PART NO.	DESCRIPTION	NOTES	O.E.
SSP2091 301191620910	Suspension Stabilizer Bar Link - Front		12542993

**CHEVROLET AVEO T250**

05/2005-02/2011

SSP0336



SSP0029



SSP0029



SSP0335



SSP2153



SSP2153



SSP1798



SSP1798



ARM372



ARM371

PART NO.	DESCRIPTION	NOTES	O.E.
ARM371	301181337100 Suspension Control Arm and Ball Joint Assembly - Front Right Lower		96535082; 96870466
ARM372	301181337200 Suspension Control Arm and Ball Joint Assembly - Front Left Lower		96535081; 96870465
SSP0029	301191600290 Steering Tie Rod - Front	M12x1,5Rht -L=201mm	96535300
SSP0335	301191603350 Steering Tie Rod End - Front Right	M12x1,5Rht	93740723
SSP0336	301191603360 Steering Tie Rod End - Front Left	M12x1,5Rht	93740722
SSP1798	301191617980 Suspension Ball Joint - Front Lower		96535089
SSP2153	301191621530 Suspension Stabilizer Bar Link - Front	L=262mm	96391875



CHEVROLET AVEO T300



03/2011-2016

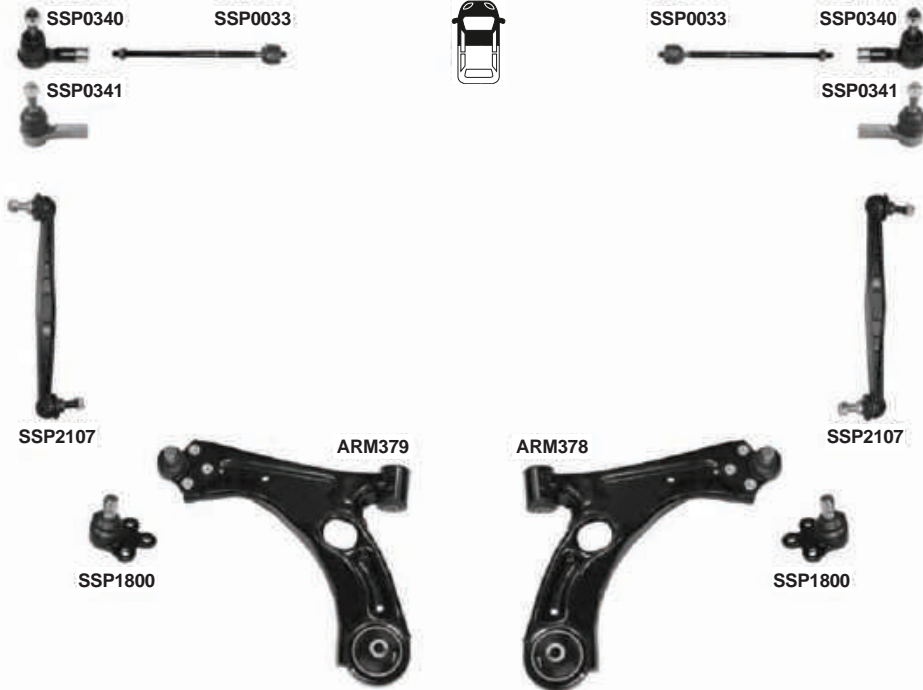

PART NO.	DESCRIPTION	NOTES	O.E.
ARM378	Suspension Control Arm and Ball Joint Assembly - Front Right Lower		95017036
ARM379	Suspension Control Arm and Ball Joint Assembly - Front Left Lower		95017035
SSP0033	Steering Tie Rod - Front	M14X1,5 - L=333mm	1609213; 95952929
SSP0340	Steering Tie Rod End - Front	M14X1,5	95952930
SSP0341	Steering Tie Rod End - Front	(Only: HYDRO. PS) M14X1,5	95218373
SSP1800	Suspension Ball Joint - Front Lower		352532; 95916024
SSP2107	Suspension Stabilizer Bar Link - Front	L=295mm	95465758

**CHEVROLET BLAZER 2nd Gen**

1995-2005

**SSP1806****SSP1806**

PART NO.		DESCRIPTION	NOTES	O.E.
SSP1806	301191618060	Suspension Ball Joint - Front Lower	RWD	19122185; 22113159; 22145460; 22156500
SSP1807	301191618070	Suspension Ball Joint - Front Upper	4WD	19133669
SSP2121	301191621210	Suspension Stabilizer Bar Link - Rear		15697702
SSP2122	301191621220	Suspension Stabilizer Bar Link - Front		15991383



CHEVROLET CAMARO 4th Gen



1993-2002



PART NO.	DESCRIPTION	NOTES	O.E.
SSP0357 301191603570	Steering Tie Rod End - Front Outer		21011027



CHEVROLET CAMARO 5th Gen



2010-2015

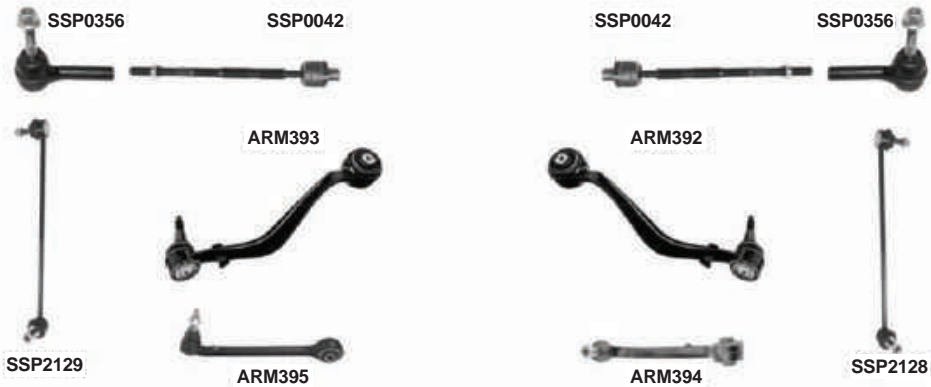

PART NO.	DESCRIPTION	NOTES	O.E.
ARM392 301181339200	Suspension Control Arm and Ball Joint Assembly - Front Right Lower Forward		92236898
ARM393 301181339300	Suspension Control Arm and Ball Joint Assembly - Front Left Lower Forward		92236899
ARM394 301181339400	Suspension Control Arm and Ball Joint Assembly - Front Right		20951301
ARM395 301181339500	Suspension Control Arm and Ball Joint Assembly - Front Left		20951300
SSP0042 301191600420	Steering Tie Rod - Front		92227430
SSP0356 301191603560	Steering Tie Rod End - Front		92241266
SSP2127 301191621270	Suspension Stabilizer Bar Link - Rear		22900200
SSP2128 301191621280	Suspension Stabilizer Bar Link - Front Right		92243928
SSP2129 301191621290	Suspension Stabilizer Bar Link - Front Left		92243929



CHEVROLET CAPTIVA



06/2006-05/2010



PART NO.	DESCRIPTION	NOTES	O.E.
ARM390	Suspension Control Arm and Ball Joint Assembly - Front Right Lower		C96819162
ARM391	Suspension Control Arm and Ball Joint Assembly - Front Left Lower		C96819161
SSP0041	Steering Tie Rod - Front	M14X1,5	96626521; 4808603; 4808602; 96626525
SSP0354	Steering Tie Rod End - Front	M14x1,5	4803429; C96626667; 96626667
SSP1808	Suspension Ball Joint - Front Lower		C96852964; 96852964; 13258056
SSP2123	Suspension Stabilizer Bar Link - Rear	L=167mm	4804642; 96996460; 96626150; 4817539
SSP2124	Suspension Stabilizer Bar Link - Rear	(Clip-on patented design) L=167mm	96626150; 96996460
SSP2125	Suspension Stabilizer Bar Link - Front Right	L=286mm	C96626248
SSP2126	Suspension Stabilizer Bar Link - Front Left	L=286mm	C96626247



CHEVROLET CAPTIVA SPORT 1st Gen



2012-



PART NO.	DESCRIPTION	NOTES	O.E.
SSP0355 301191603550	Steering Tie Rod End - Front	4WD	19208276



CHEVROLET CAPTIVA SPORT



2012-2015

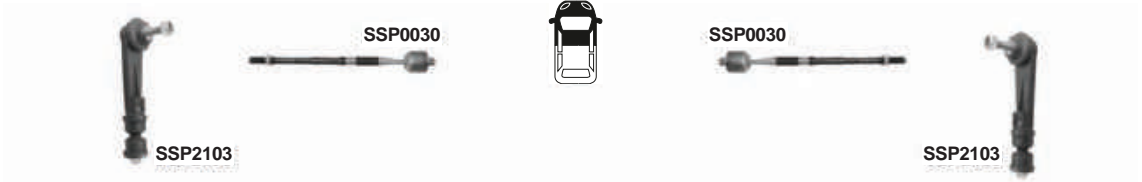

PART NO.	DESCRIPTION	NOTES	O.E.
SSP0030 301191600300	Steering Tie Rod - Front	POWER/ELECTRIC	19149839
SSP2103 301191621030	Suspension Stabilizer Bar Link - Rear		15146379



CHEVROLET CAVALIER 3rd Gen

1995-2005



SSP1812



SSP1812



PART NO.	DESCRIPTION	NOTES	O.E.
SSP0363 301191603630	Steering Tie Rod End - Front		26057931
SSP1812 301191618120	Suspension Ball Joint - Front Lower		88967431
SSP2131 301191621310	Suspension Stabilizer Bar Link - Front		22710259



CHEVROLET Chevy Monza /MONZA(MEXICO)



1994-2001

ARM870



ARM869



SSP1927



SSP1927



	PART NO.	DESCRIPTION	NOTES	O.E.
ARM869	301181386900	Suspension Control Arm and Ball Joint Assembly - Front Right Lower		352002
ARM870	301181387000	Suspension Control Arm and Ball Joint Assembly - Front Left Lower		352003
SSP1927	301191619270	Suspension Ball Joint - Front	D=Ø15mm	1603128; 90166394; 1603187; 1603161



CHEVROLET Chevy Pickup /MONZA/PICK-UP IMPORT



1999-2001

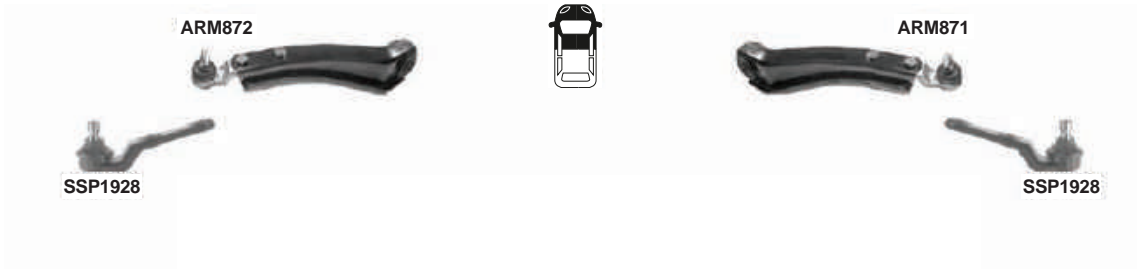

	PART NO.	DESCRIPTION	NOTES	O.E.
ARM871	301181387100	Suspension Control Arm and Ball Joint Assembly - Front Right Lower		5352012
ARM872	301181387200	Suspension Control Arm and Ball Joint Assembly - Front Left Lower		5352011
SSP1928	301191619280	Suspension Ball Joint - Front	D=Ø15mm	1603202; 90539896



CHEVROLET Chevy Pickup /MONZA/PICK-UP IMPORT



2001-2005



ARM874



ARM873



SSP1929



SSP1929

PART NO.	DESCRIPTION	NOTES	O.E.
ARM873 301181387300	Suspension Control Arm and Ball Joint Assembly - Front Right Lower		352063; 352042; 24428978
ARM874 301181387400	Suspension Control Arm and Ball Joint Assembly - Front Left Lower		352061; 352041; 24428977
SSP1929 301191619290	Suspension Ball Joint - Front	D=Ø16mm	352803; 9196394



CHEVROLET COBALT



2005-2010



SSP0337



SSP0337

PART NO.	DESCRIPTION	NOTES	O.E.
SSP0337 301191603370	Steering Tie Rod End - Front		19149840



CHEVROLET COLORADO 1st Gen 

2003-2012

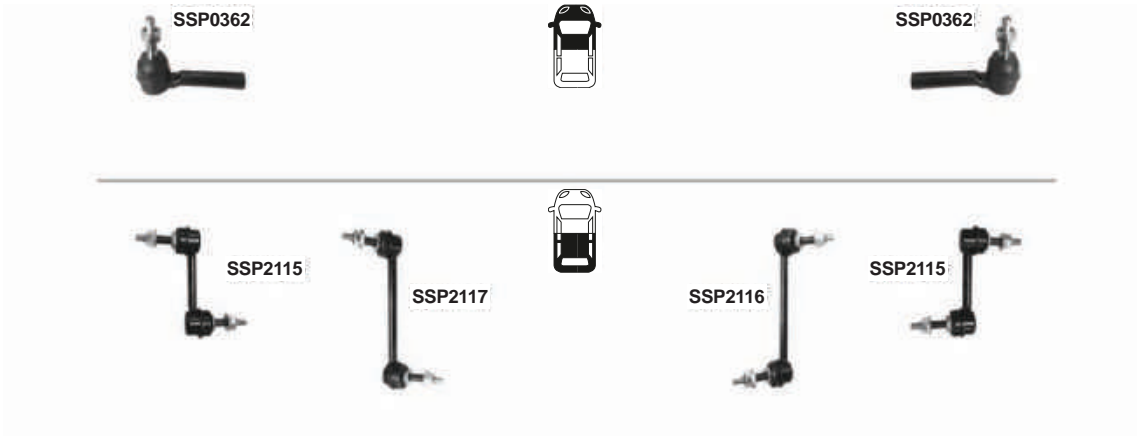

PART NO.	DESCRIPTION	NOTES	O.E.
SSP0362 301191603620	Steering Tie Rod End - Front Outer		26095458
SSP1803 301191618030	Suspension Ball Joint - Front Upper		89040241
SSP2115 301191621150	Suspension Stabilizer Bar Link - Rear		15196858
SSP2116 301191621160	Suspension Stabilizer Bar Link - Front Right	with z71-off road pkg	15167957
SSP2117 301191621170	Suspension Stabilizer Bar Link - Front Left	with z71-off road pkg	15167956



CHEVROLET CORVETTE C5



01/1997-09/2004



PART NO.	DESCRIPTION	NOTES	O.E.
SSP0039 301191600390	Steering Tie Rod - Rear		88955489
SSP0351 301191603510	Steering Tie Rod End - Front	without sport suspension	88955488
SSP2120 301191621200	Suspension Stabilizer Bar Link - Rear	Base & 427. Z06, zr1 & grand sport	20822934



CHEVROLET CORVETTE C6



2005-2011

SSP0351



SSP0351



SSP2120



SSP2120



PART NO.	DESCRIPTION	NOTES	O.E.
SSP0351 301191603510	Steering Tie Rod End - Front	without sport suspension	88955488
SSP2120 301191621200	Suspension Stabilizer Bar Link - Rear	Base & 427. Z06, zr1 & grand sport	20822934



CHEVROLET CORVETTE C7



2014-



PART NO.	DESCRIPTION	NOTES	O.E.
SSP0040 301191600400	Steering Tie Rod - Front		22913277
SSP0352 301191603520	Steering Tie Rod End - Front Right		22913275
SSP0353 301191603530	Steering Tie Rod End - Front Left		22913276



CHEVROLET CRUZE

 05/2009-2016

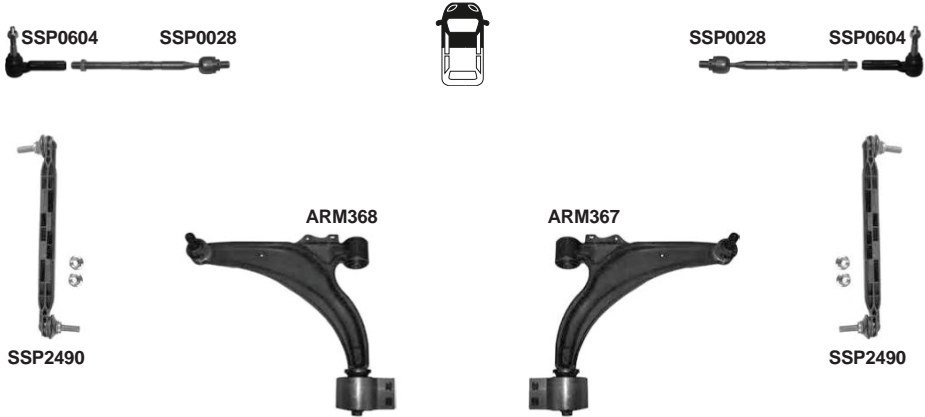

	PART NO.	DESCRIPTION	NOTES	O.E.
ARM367	301181336700	Suspension Control Arm and Ball Joint Assembly - Front Right Lower		13334023; C13272606
ARM368	301181336800	Suspension Control Arm and Ball Joint Assembly - Front Left Lower		13334022; C13272605
SSP0028	301191600280	Steering Tie Rod - Front	M16x1,5 - L=295mm	13278358*
SSP0604	301191606040	Steering Tie Rod End - Front	M16x1,5	13272000; 1609026; 6606031; 13286686; 13278359
SSP2490	301191624900	Suspension Stabilizer Bar Link - Front	Plastic L=304mm	13219141; 350617; C13219141

**CHEVROLET CRUZE 2nd Gen**

2016-

**SSP0606****SSP0605****SSP2492****SSP2491**

PART NO.	DESCRIPTION	NOTES	O.E.
SSP0203 301191602030	Steering Tie Rod - Front		13464344
SSP0605 301191606050	Steering Tie Rod End - Front Right		39008083
SSP0606 301191606060	Steering Tie Rod End - Front Left		39008084
SSP2491 301191624910	Suspension Stabilizer Bar Link - Front Right	A = 307 MM	39001004
SSP2492 301191624920	Suspension Stabilizer Bar Link - Front Left	A = 307 MM	39001003



CHEVROLET EPICA V250



01/2005-03/2011

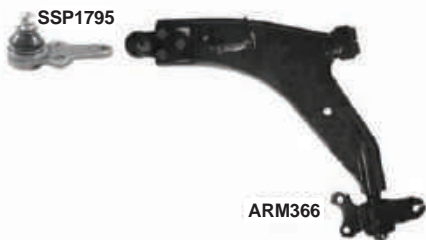

PART NO.	DESCRIPTION	NOTES	O.E.
ARM365	Suspension Control Arm and Ball Joint Assembly - Front Right Lower		96970076
ARM366	Suspension Control Arm and Ball Joint Assembly - Front Left Lower		96970077
SSP0027	Steering Tie Rod - Front	M14X1,5 - L=356 mm	93740701
SSP0329	Steering Tie Rod End - Front	M14X1,5	93740710
SSP1795	Suspension Ball Joint - Front		96328437; 96445783
SSP2093	Suspension Stabilizer Bar Link - Front Right	L=80mm	96225859
SSP2094	Suspension Stabilizer Bar Link - Front Left	L=80mm	96225858
SSP2095	Suspension Stabilizer Bar Link - Rear	L=197mm	96639910
SSP2096	Suspension Stabilizer Bar Link - Rear	(Clip-on patented design) L=197mm	96639910

**CHEVROLET EQUINOX**

2005-2009



PART NO.	DESCRIPTION	NOTES	O.E.
SSP0355 301191603550	Steering Tie Rod End - Front	4WD	19208276
ARM373 301181337300	Suspension Control Arm and Ball Joint Assembly - Front Right		25878028
ARM374 301181337400	Suspension Control Arm and Ball Joint Assembly - Front Left		25878029
ARM375 301181337500	Lateral Arm - Rear		22678193
SSP0030 301191600300	Steering Tie Rod - Front	POWER/ELECTRIC	19149839
SSP0337 301191603370	Steering Tie Rod End - Front		19149840
SSP1808 301191618080	Suspension Ball Joint - Front Lower		C96852964; 96852964; 13258056
SSP2103 301191621030	Suspension Stabilizer Bar Link - Rear		15146379
SSP2104 301191621040	Suspension Stabilizer Bar Link - Front Right		15218267
SSP2105 301191621050	Suspension Stabilizer Bar Link - Front Left		15218268



CHEVROLET EQUINOX 2nd Gen



2010-2016



SSP0032



SSP0032



SSP0338



SSP0339



SSP0339



SSP1799



ARM377



ARM376



SSP1799



SSP2480



SSP2479

SSP2106



ARM375



ARM375



SSP2106



PART NO.	DESCRIPTION	NOTES	O.E.
ARM375 301181337500	Lateral Arm - Rear		22678193
ARM376 301181337600	Suspension Control Arm and Ball Joint Assembly - Front Right Lower		20945780
ARM377 301181337700	Suspension Control Arm and Ball Joint Assembly - Front Left Lower		20945779
SSP0031 301191600310	Steering Tie Rod - Front Inner	electric type	19207056
SSP0032 301191600320	Steering Tie Rod - Front	POWER/HYDRAULIC	19210063
SSP0338 301191603380	Steering Tie Rod End - Front	Power/Hydraulic Steering	19210064
SSP0339 301191603390	Steering Tie Rod End - Front	Power Electric	19207057
SSP1799 301191617990	Suspension Ball Joint - Front Lower		19258791; 20945779/20945780**
SSP2106 301191621060	Suspension Stabilizer Bar Link - Rear		15926031
SSP2479 301191624790	Suspension Stabilizer Bar Link - Front Right		15779960; 95942520; 350232*
SSP2480 301191624800	Suspension Stabilizer Bar Link - Front Left		15779961; 350231*

**CHEVROLET EVANDA V200**

03/2003-09/2006



	PART NO.	DESCRIPTION	NOTES	O.E.
ARM363	301181336300	Suspension Control Arm and Ball Joint Assembly - Front Right Lower		96389492
ARM364	301181336400	Suspension Control Arm and Ball Joint Assembly - Front Left Lower		96389491
SSP0328	301191603280	Steering Tie Rod End - Front	M14X1,5Rht	93740710
SSP1794	301191617940	Suspension Ball Joint - Front	D=Ø18mm	92119830; C96639918; 96328437
SSP2093	301191620930	Suspension Stabilizer Bar Link - Front Right	L=80mm	96225859
SSP2094	301191620940	Suspension Stabilizer Bar Link - Front Left	L=80mm	96225858



CHEVROLET EXPRESS 1500 1st Gen



2003-2014



PART NO.	DESCRIPTION	NOTES	O.E.
SSP0350 301191603500	Steering Tie Rod End - Front		26095475; ES80311
SSP2118 301191621180	Suspension Stabilizer Bar Link - Front		6W1Z5664AA; 4656260AA; 25747956; 15963924

**CHEVROLET EXPRESS 2500**

2003-



	PART NO.	DESCRIPTION	NOTES	O.E.
SSP0350	301191603500	Steering Tie Rod End - Front		26095475; ES80311
SSP1805	301191618050	Suspension Ball Joint - Front Lower	2WD	19210782
SSP2118	301191621180	Suspension Stabilizer Bar Link - Front		6W1Z5664AA; 4656260AA; 25747956; 15963924



CHEVROLET HHR



2006-2011



SSP0337



SSP0361



SSP0337



SSP0361

	PART NO.	DESCRIPTION	NOTES	O.E.
SSP0337	301191603370	Steering Tie Rod End - Front		19149840
SSP0361	301191603610	Steering Tie Rod End - Front		25956921



CHEVROLET IMPALA 8th, 9th Gen

2000-2013

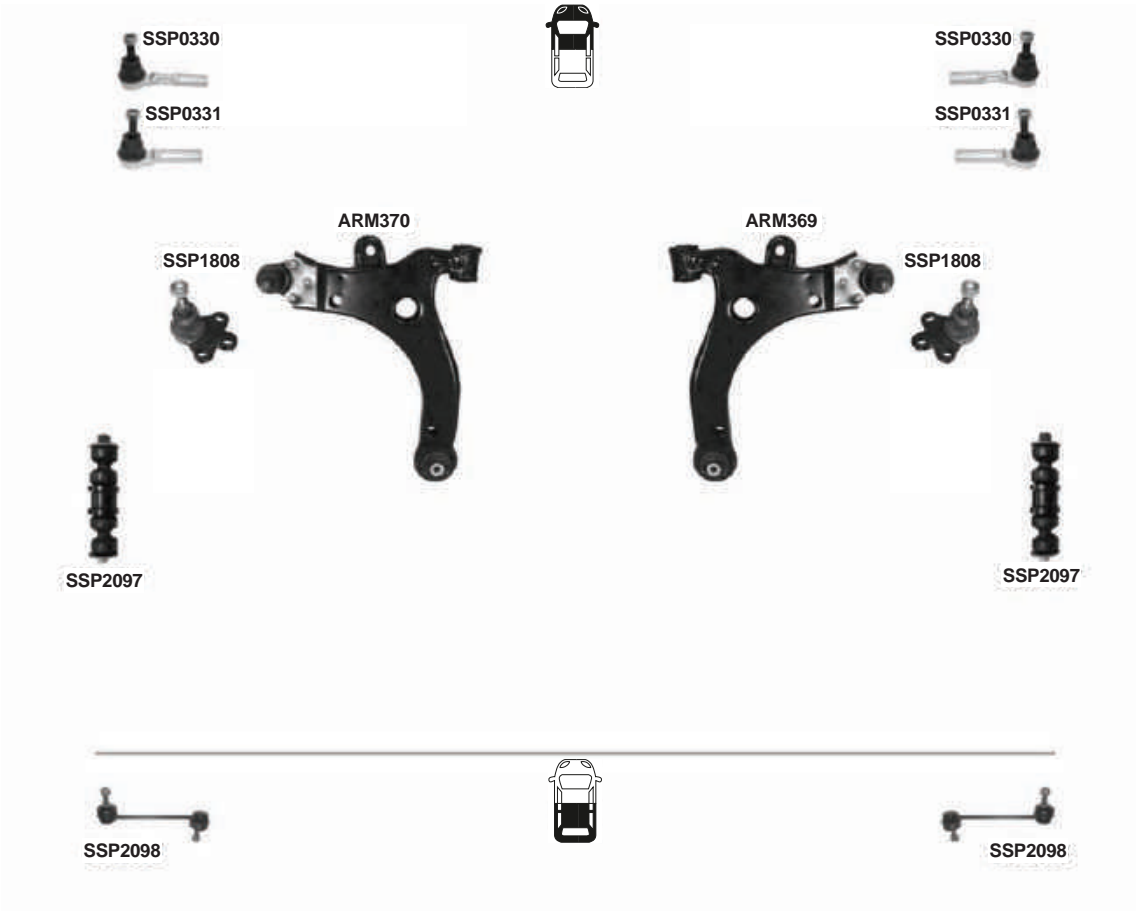

PART NO.	DESCRIPTION	NOTES	O.E.
ARM369	301181336900	Suspension Control Arm and Ball Joint Assembly - Front Right	15293664; 22947663
ARM370	301181337000	Suspension Control Arm and Ball Joint Assembly - Front Left	15293665; 22947664
SSP0330	301191603300	Steering Tie Rod End - Front Outer	W/SPECIAL SUSPENSION 26086579
SSP0331	301191603310	Steering Tie Rod End - Front	W/O SPECIAL SUSPENSION 26086580
SSP1808	301191618080	Suspension Ball Joint - Front Lower	C96852964; 96852964; 13258056
SSP2097	301191620970	Suspension Stabilizer Bar Link - Front	10403402
SSP2098	301191620980	Suspension Stabilizer Bar Link - Rear	20985982



CHEVROLET IMPALA 10th Gen



2014-

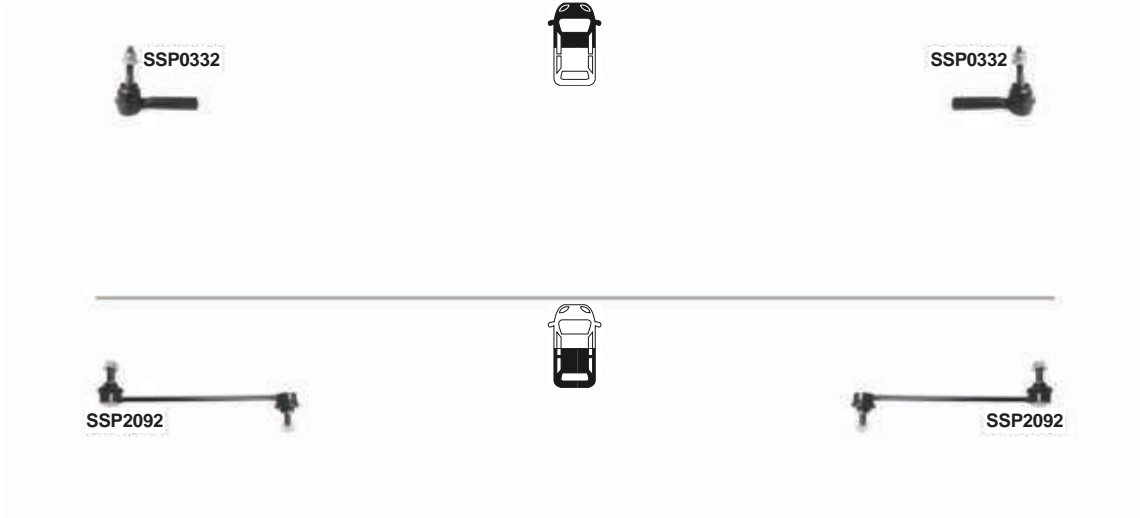

PART NO.	DESCRIPTION	NOTES	O.E.
SSP0332 301191603320	Steering Tie Rod End - Front		22776539
SSP2092 301191620920	Suspension Stabilizer Bar Link - Rear		22810912

**CHEVROLET LACETTI J200 (OPTRA)**  03/2003-04/2012

	PART NO.	DESCRIPTION	NOTES	O.E.
ARM380	301181338000	Suspension Control Arm and Ball Joint Assembly - Front Right Lower		96391851; 96415064
ARM381	301181338100	Suspension Control Arm and Ball Joint Assembly - Front Left Lower		96391850; 96415063
ARM382	301181338200	Suspension Control Arm and Ball Joint Assembly - Front Right	Automatic Transmission	96436598
ARM383	301181338300	Suspension Control Arm and Ball Joint Assembly - Front Left	Automatic Transmission	96436597
SSP0034	301191600340	Steering Tie Rod - Front	M14X1,5Rht - L=285.5mm	96061907
SSP0342	301191603420	Steering Tie Rod End - Front Right	M14X1,5Rht	93740623; 96407486
SSP0343	301191603430	Steering Tie Rod End - Front Left	M14X1,5Rht	96407485
SSP1801	301191618010	Suspension Ball Joint - Front	D=Ø 18mm	96490218
SSP1802	301191618020	Suspension Ball Joint - Front Lower	(Automatic Transmission)	Part of 96436597; Part of 96436598
SSP2108	301191621080	Suspension Stabilizer Bar Link - Front Right	L=272mm	96403100
SSP2109	301191621090	Suspension Stabilizer Bar Link - Front Left	L=272mm	96403099
SSP2110	301191621100	Suspension Stabilizer Bar Link - Rear	Plastic L=217mm	96391876; 96561754



CHEVROLET MALIBU 6th Gen



1997-2005



PART NO.	DESCRIPTION	NOTES	O.E.
SSP0347 301191603470	Steering Tie Rod End - Front Outer		89047756



CHEVROLET MALIBU 7th Gen



2004-2012

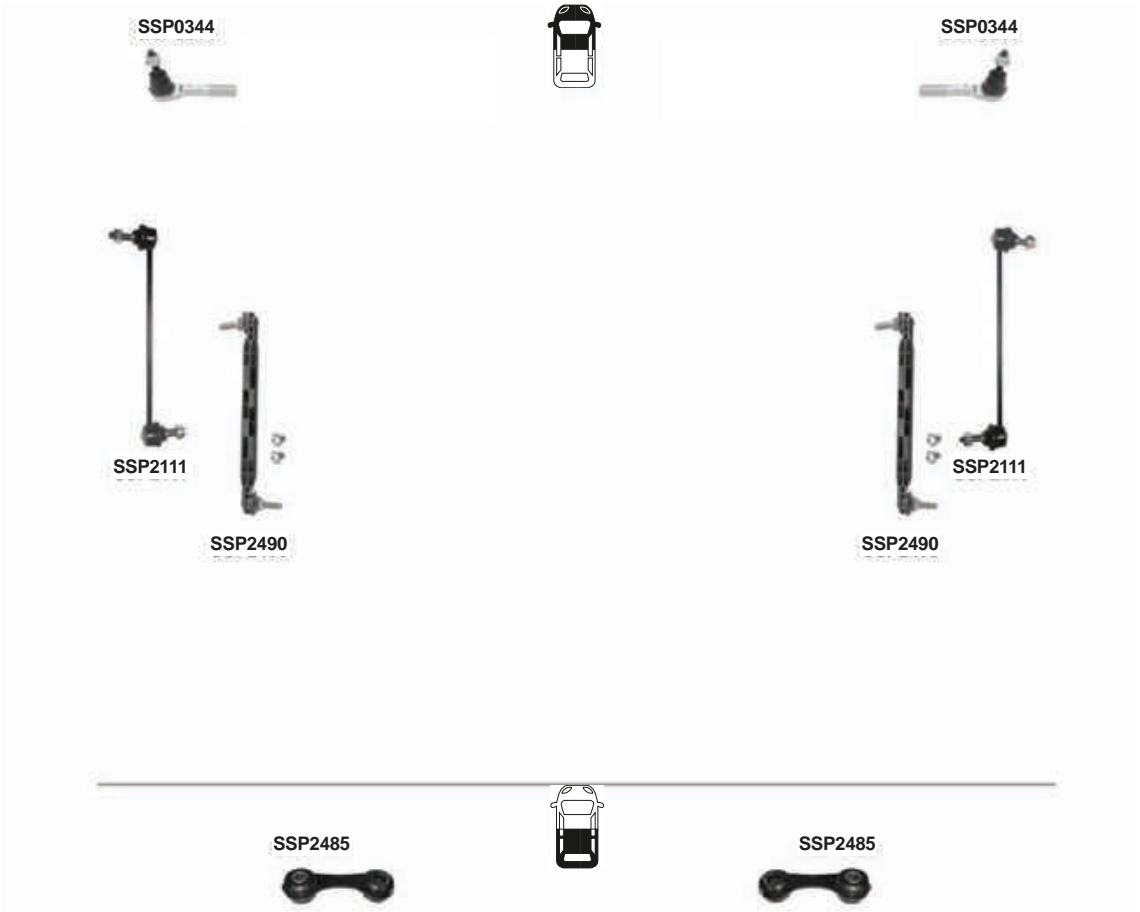

PART NO.	DESCRIPTION	NOTES	O.E.
ARM386	301181338600 Suspension Control Arm and Ball Joint Assembly - Front Right Lower		22730776; 15292910
ARM387	301181338700 Suspension Control Arm and Ball Joint Assembly - Front Left Lower		22730775; 15292911
SSP0344	301191603440 Steering Tie Rod End - Front		15944090
SSP2111	301191621110 Suspension Stabilizer Bar Link - Front		22670300
SSP2485	301191624850 Suspension Stabilizer Bar Link - Rear		25816039; 444275
SSP2490	301191624900 Suspension Stabilizer Bar Link - Front	Plastic L=304mm	13219141; 350617; C13219141



CHEVROLET MALIBU 8th Gen



2013-2016

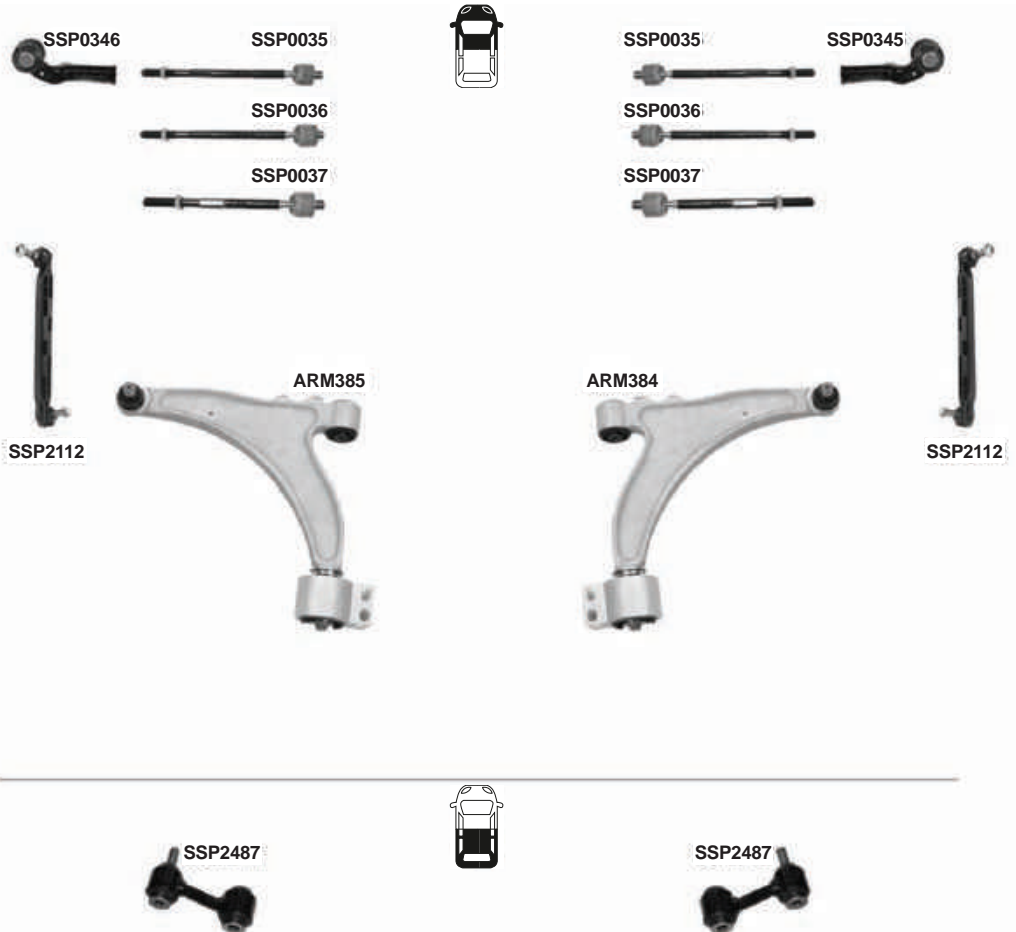

PART NO.	DESCRIPTION	NOTES	O.E.
ARM384	301181338400 Suspension Control Arm and Ball Joint Assembly - Front Right Lower		22854826
ARM385	301181338500 Suspension Control Arm and Ball Joint Assembly - Front Left Lower		22854825
SSP0035	301191600350 Steering Tie Rod - Front	Without 19 wheels. Without ride & handling pkg.	13332651; 1609181
SSP0036	301191600360 Steering Tie Rod - Front	2.4 & 2.5L. With 19 wheels.	13332653; 1609183
SSP0037	301191600370 Steering Tie Rod - Front	Without 19 wheels. With ride & handling pkg.	13354600
SSP0345	301191603450 Steering Tie Rod End - Front Right		13354598
SSP0346	301191603460 Steering Tie Rod End - Front Left		13354596
SSP2112	301191621120 Suspension Stabilizer Bar Link - Front		20961222
SSP2487	301191624870 Suspension Stabilizer Bar Link - Rear		13281792; 444081



CHEVROLET MALIBU 9th Gen



2016-



	PART NO.	DESCRIPTION	NOTES	O.E.
ARM384	301181338400	Suspension Control Arm and Ball Joint Assembly - Front Right Lower		22854826
ARM385	301181338500	Suspension Control Arm and Ball Joint Assembly - Front Left Lower		22854825



CHEVROLET MALIBU LIMITED 9th Gen  **2016-**

SSP0346



SSP0345



PART NO.	DESCRIPTION	NOTES	O.E.
SSP0345 301191603450	Steering Tie Rod End - Front Right		13354598
SSP0346 301191603460	Steering Tie Rod End - Front Left		13354596



CHEVROLET METRO



1998-2001



SSP1965

SSP1965

	PART NO.	DESCRIPTION	NOTES	O.E.
ARM991	301181399100	Suspension Control Arm and Ball Joint Assembly - Front Right		4520150G10; 4520170C00; 4520160B01
ARM992	301181399200	Suspension Control Arm and Ball Joint Assembly - Front Left		4520250G10; 4520270C00; 4520260B01
SSP1965	301191619650	Suspension Ball Joint - Front Lower		4520170C00 / 45202 Part of

CHEVROLET MONTANA (Tornado)  2003-

PART NO.	DESCRIPTION	NOTES	O.E.
SSP2478 301191624780	Suspension Stabilizer Bar Link - Front	Only: Mexico Type (Clip-on patented design) L=243mm	350610*; 5236823*; 4886606*



CHEVROLET N300 (Argentina)



06/2006-



PART NO.	DESCRIPTION	NOTES	O.E.
SSP0044 301191600440	Steering Tie Rod - Front		23868906
SSP0358 301191603580	Steering Tie Rod End - Front Right		24510351
SSP0359 301191603590	Steering Tie Rod End - Front Left		24510351



CHEVROLET OPTRA J200



03/2003-04/2012

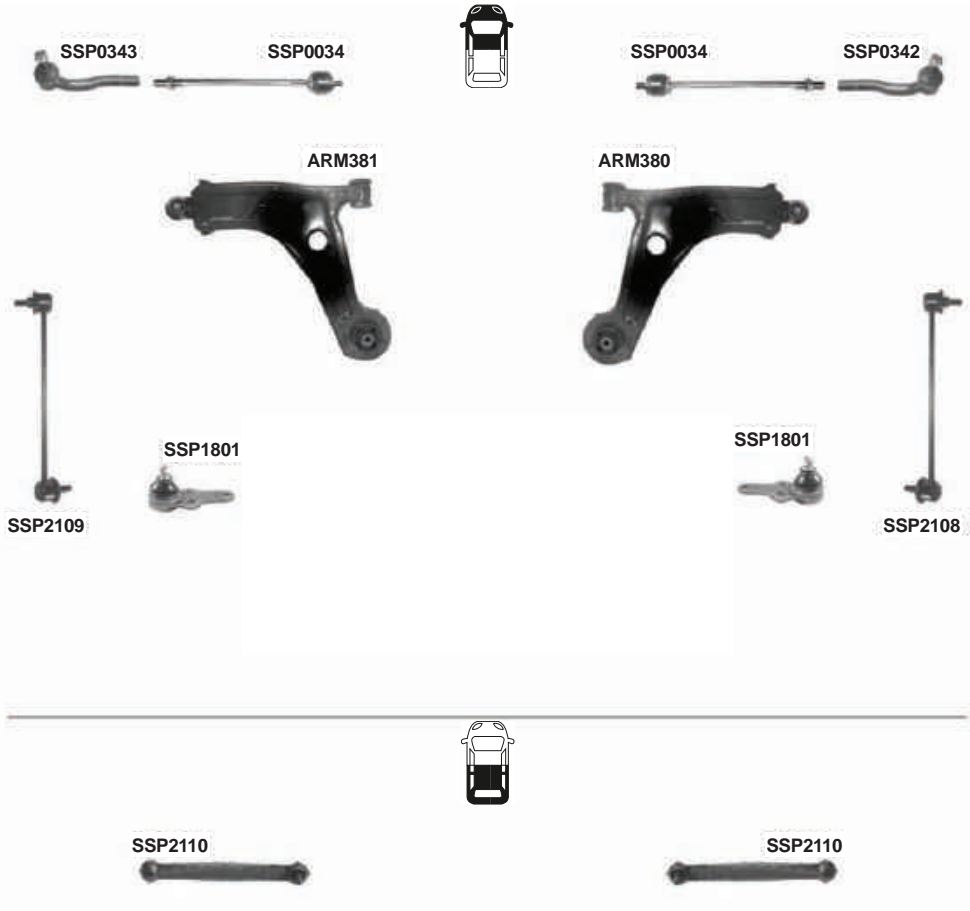

PART NO.	DESCRIPTION	NOTES	O.E.
ARM380 301181338000	Suspension Control Arm and Ball Joint Assembly - Front Right Lower		96391851; 96415064
ARM381 301181338100	Suspension Control Arm and Ball Joint Assembly - Front Left Lower		96391850; 96415063
SSP0034 301191600340	Steering Tie Rod - Front	M14X1,5Rht - L=285.5mm	96061907
SSP0342 301191603420	Steering Tie Rod End - Front Right	M14X1,5Rht	93740623; 96407486
SSP0343 301191603430	Steering Tie Rod End - Front Left	M14X1,5Rht	96407485
SSP1801 301191618010	Suspension Ball Joint - Front	D=Ø 18mm	96490218
SSP2108 301191621080	Suspension Stabilizer Bar Link - Front Right	L=272mm	96403100
SSP2109 301191621090	Suspension Stabilizer Bar Link - Front Left	L=272mm	96403099
SSP2110 301191621100	Suspension Stabilizer Bar Link - Rear	Plastic L=217mm	96391876; 96561754

**CHEVROLET REZZO U100 (VIVANT)**

2004-2009

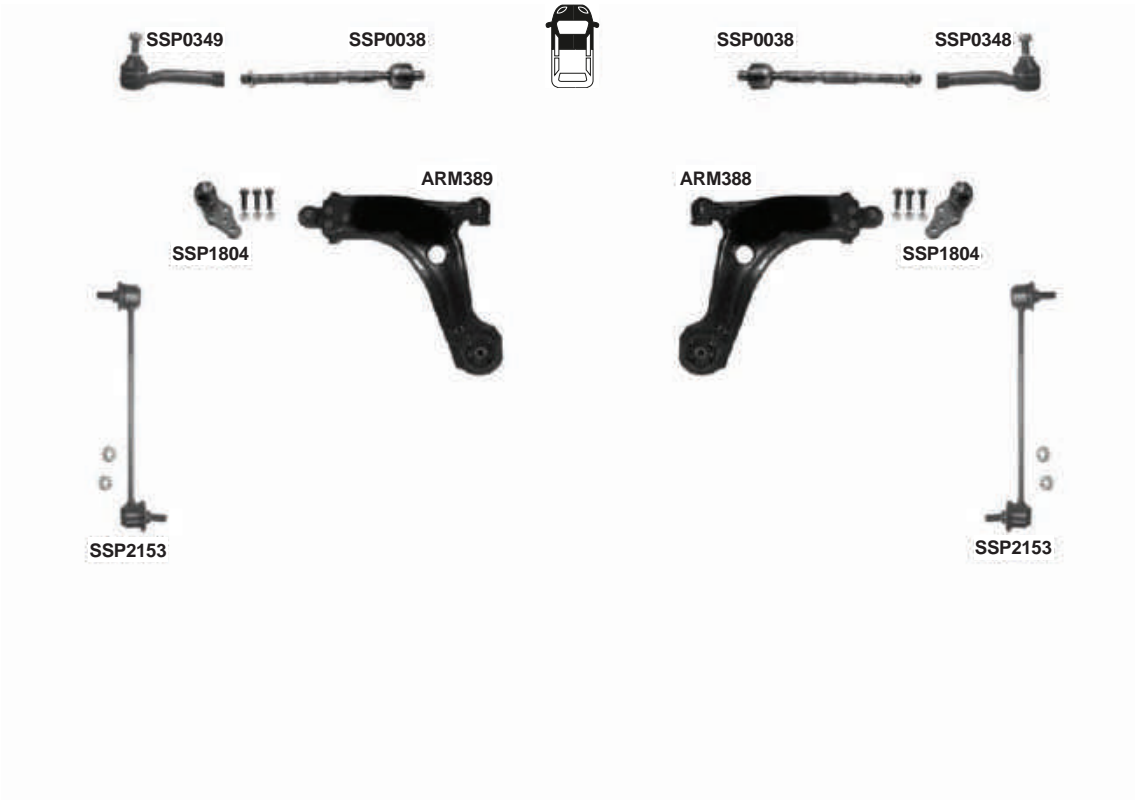

PART NO.	DESCRIPTION	NOTES	O.E.
ARM388	301181338800 Suspension Control Arm and Ball Joint Assembly - Front Right Lower		96423324
ARM389	301181338900 Suspension Control Arm and Ball Joint Assembly - Front Left Lower		96422220
SSP0038	301191600380 Steering Tie Rod - Front	M14x1,5 - L=238,7mm	93740621; C521564
SSP0348	301191603480 Steering Tie Rod End - Front Right	M14X1,5Rht	96261379
SSP0349	301191603490 Steering Tie Rod End - Front Left	M14X1,5Rht	96261378
SSP1804	301191618040 Suspension Ball Joint - Front	D=Ø 16mm	96261108
SSP2153	301191621530 Suspension Stabilizer Bar Link - Front	L=262mm	96391875



PART NO.	DESCRIPTION	NOTES	O.E.
SSP2122 301191621220	Suspension Stabilizer Bar Link - Front		15991383



CHEVROLET SILVERADO 1500 1st Gen, GMT800



1999-2006



PART NO.	DESCRIPTION	NOTES	O.E.
SSP1793 301191617930	Suspension Ball Joint - Front Upper		12475485; 12475486; K6540
SSP2091 301191620910	Suspension Stabilizer Bar Link - Front		12542993



CHEVROLET SILVERADO 1500 2nd Gen, GMT900



2009-2013



PART NO.	DESCRIPTION	NOTES	O.E.
ARM398 301181339800	Suspension Control Arm and Ball Joint Assembly - Front Right Lower	w/Police Package	25997510
ARM399 301181339900	Suspension Control Arm and Ball Joint Assembly - Front Left Lower	w/Police Package	25997509
SSP1810 301191618100	Suspension Ball Joint - Front Lower	with Police Package	Part of 25997509; Part of 25997510



CHEVROLET SILVERADO 3500



2001-2010



PART NO.	DESCRIPTION	NOTES	O.E.
SSP2119 301191621190	Suspension Stabilizer Bar Link - Rear		15089907



CHEVROLET SPARK M300



03/2010-2016

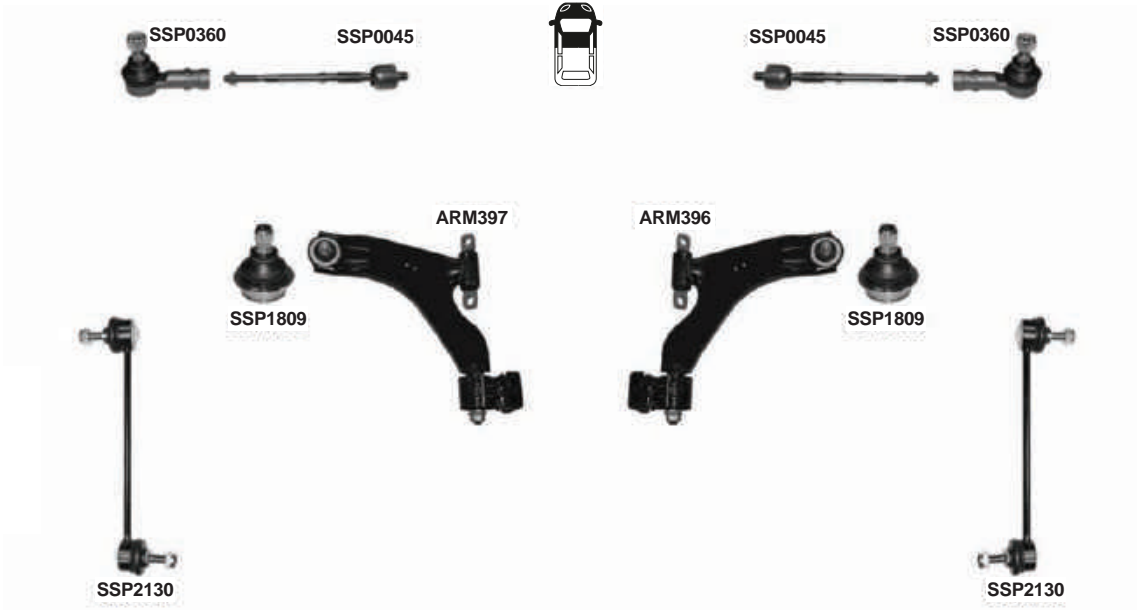

PART NO.	DESCRIPTION	NOTES	O.E.
ARM396	Suspension Control Arm and Ball Joint Assembly - Front Right Lower		95319216; 95952783
ARM397	Suspension Control Arm and Ball Joint Assembly - Front Left Lower		95319215; 95952782
SSP0045	Steering Tie Rod - Front	M12X1,25 - L=244mm	95967294
SSP0360	Steering Tie Rod End - Front	M12X1,25	95967285
SSP1809	Suspension Ball Joint - Front Lower		95952782/83
SSP2130	Suspension Stabilizer Bar Link - Front	L=235mm	95947829



CHEVROLET SSR



2003-2005

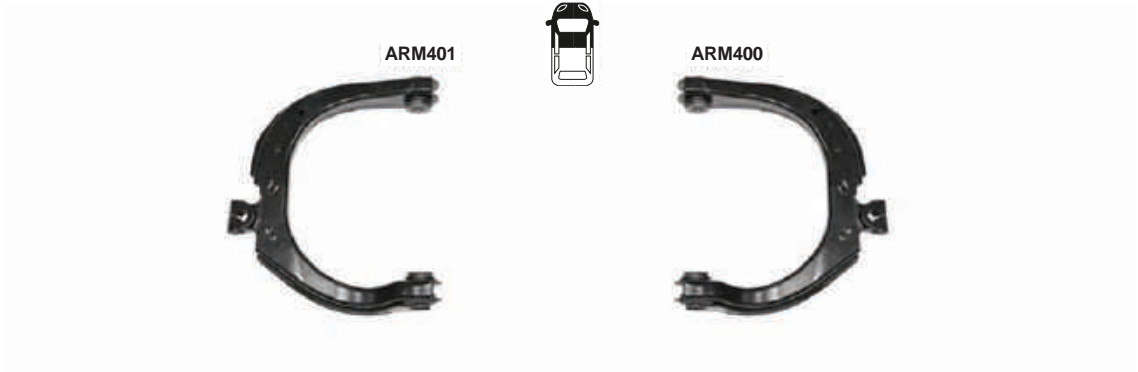

	PART NO.	DESCRIPTION	NOTES	O.E.
ARM400	301181340000	Suspension Control Arm - Front Right		25786775
ARM401	301181340100	Suspension Control Arm - Front Left		25786774



CHEVROLET SUBURBAN 8th Gen



1992-2000



PART NO.	DESCRIPTION	NOTES	O.E.
SSP2132	301191621320 Suspension Stabilizer Bar Link - Rear		15961007



CHEVROLET TACOMA



2000-2008



PART NO.	DESCRIPTION	NOTES	O.E.
ARM388	301181338800 Suspension Control Arm and Ball Joint Assembly - Front Right Lower		96423324
ARM389	301181338900 Suspension Control Arm and Ball Joint Assembly - Front Left Lower		96422220
SSP0038	301191600380 Steering Tie Rod - Front	M14x1,5 - L=238,7mm	93740621; C521564
SSP0348	301191603480 Steering Tie Rod End - Front Right	M14X1,5Rht	96261379
SSP0349	301191603490 Steering Tie Rod End - Front Left	M14X1,5Rht	96261378
SSP1804	301191618040 Suspension Ball Joint - Front	D=Ø 16mm	96261108
SSP2153	301191621530 Suspension Stabilizer Bar Link - Front	L=262mm	96391875



CHEVROLET TAHOE 1st Gen



1992-2000



PART NO.	DESCRIPTION	NOTES	O.E.
SSP1811 301191618110	Suspension Ball Joint - Front Lower	AWD	12383410; 12380415
SSP2132 301191621320	Suspension Stabilizer Bar Link - Rear		15961007



CHEVROLET TAHOE 2nd Gen, GMT800 2000-2006



SSP1793



SSP1793

PART NO.	DESCRIPTION	NOTES	O.E.
SSP1793 301191617930	Suspension Ball Joint - Front Upper		12475485; 12475486; K6540
SSP1813 301191618130	Suspension Ball Joint - Front Lower		19209396



CHEVROLET TAHOE 3rd Gen, GMT900 2007-2014

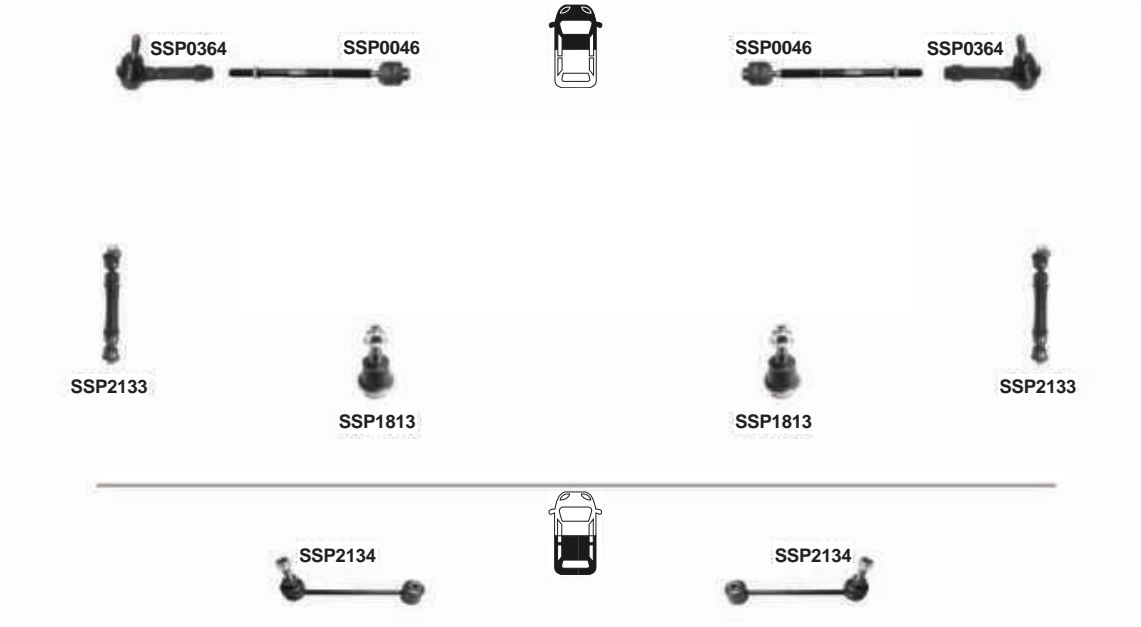

PART NO.	DESCRIPTION	NOTES	O.E.
ARM398 301181339800	Suspension Control Arm and Ball Joint Assembly - Front Right Lower	w/Police Package	25997510
ARM399 301181339900	Suspension Control Arm and Ball Joint Assembly - Front Left Lower	w/Police Package	25997509
SSP0046 301191600460	Steering Tie Rod - Front		19178561
SSP0364 301191603640	Steering Tie Rod End - Front Outer		15254061
SSP1810 301191618100	Suspension Ball Joint - Front Lower	with Police Package	Part of 25997509; Part of 25997510
SSP1813 301191618130	Suspension Ball Joint - Front Lower		19209396
SSP2133 301191621330	Suspension Stabilizer Bar Link - Front		25918049
SSP2134 301191621340	Suspension Stabilizer Bar Link - Rear		15257472

**CHEVROLET Tornado**

2003-2016

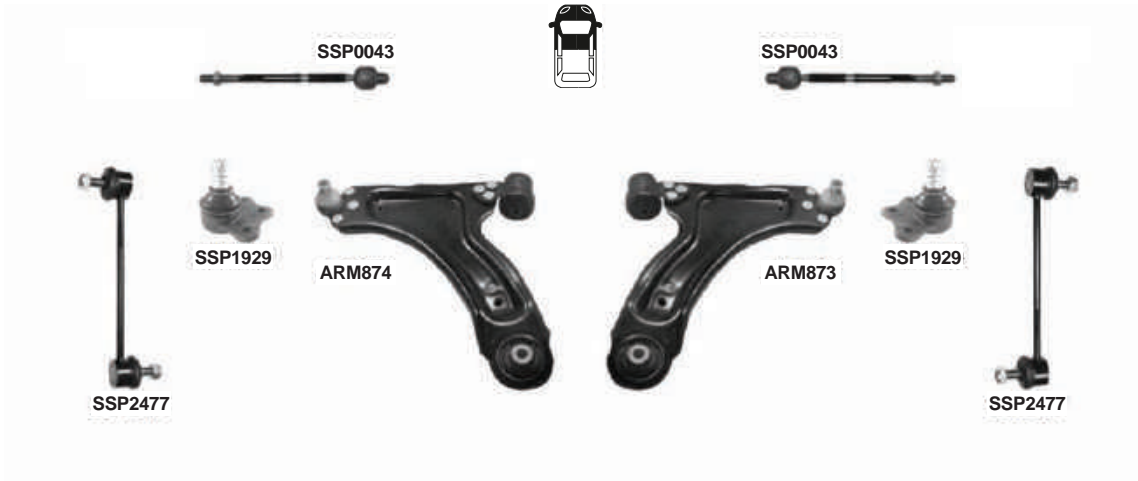

	PART NO.	DESCRIPTION	NOTES	O.E.
ARM873	301181387300	Suspension Control Arm and Ball Joint Assembly - Front Right Lower		352063; 352042; 24428978
ARM874	301181387400	Suspension Control Arm and Ball Joint Assembly - Front Left Lower		352061; 352041; 24428977
SSP0043	301191600430	Steering Tie Rod - Front	M14X1,5 - L=275mm	93388624
SSP1929	301191619290	Suspension Ball Joint - Front	D=Ø16mm	352803; 9196394
SSP2477	301191624770	Suspension Stabilizer Bar Link - Front	Only: Mexico Type L=243mm	350610; 90496116; 5236823; 4886606



CHEVROLET TRACKER 2nd Gen



1998-2005



PART NO.	DESCRIPTION	NOTES	O.E.
SSP0048 301191600480	Steering Tie Rod - Front		91175548
SSP0366 301191603660	Steering Tie Rod End - Front Right		91174753
SSP0367 301191603670	Steering Tie Rod End - Front Left		91174754

**CHEVROLET TRAILBLAZER 1st Gen**  **2002-2009**

PART NO.	DESCRIPTION	NOTES	O.E.
ARM400 301181340000	Suspension Control Arm - Front Right		25786775
ARM401 301181340100	Suspension Control Arm - Front Left		25786774
SSP0333 301191603330	Steering Tie Rod End - Front Right Outer		26100287; 4011887
SSP0334 301191603340	Steering Tie Rod End - Front Left Outer		26100286; 4011886
SSP1796 301191617960	Suspension Ball Joint - Front Lower	4X4	19133670; 8191336700
SSP1797 301191617970	Suspension Ball Joint - Front Upper		19133638; 22157320; 8191336380
SSP2099 301191620990	Suspension Stabilizer Bar Link - Front Right	steel type	15918822
SSP2100 301191621000	Suspension Stabilizer Bar Link - Front Left	steel type	15918823
SSP2101 301191621010	Suspension Stabilizer Bar Link - Rear Left	steel type	88982342; 88965470
SSP2102 301191621020	Suspension Stabilizer Bar Link - Rear Right	steel type	88982343; 88965471



CHEVROLET TRAVERSE 1st Gen



2009-2015

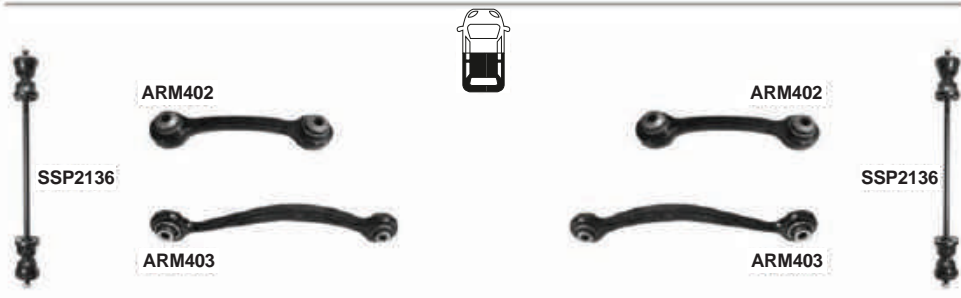
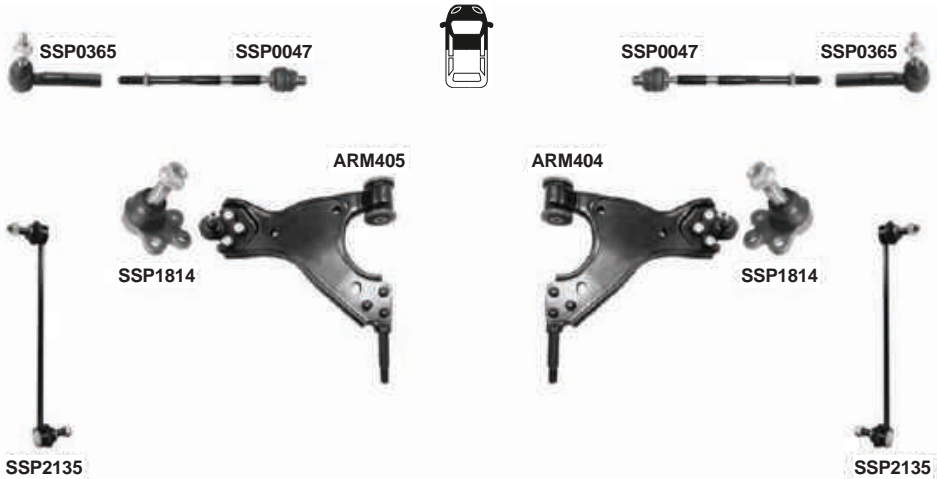

PART NO.	DESCRIPTION	NOTES	O.E.
ARM402 301181340200	Lateral Arm - Rear Upper		15148024
ARM403 301181340300	Lateral Arm - Rear Lower		23461856
ARM404 301181340400	Suspension Control Arm and Ball Joint Assembly - Front Right Lower		20774419
ARM405 301181340500	Suspension Control Arm and Ball Joint Assembly - Front Left Lower		25995438
SSP0047 301191600470	Steering Tie Rod - Front		20817752
SSP0365 301191603650	Steering Tie Rod End - Front		15869897
SSP1814 301191618140	Suspension Ball Joint - Front		19207521
SSP2135 301191621350	Suspension Stabilizer Bar Link - Front		20905104
SSP2136 301191621360	Suspension Stabilizer Bar Link - Rear		15129234



CHEVROLET TRAX



2014 -



SSP0598

SSP0194



SSP0194

SSP0598

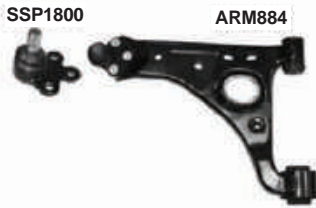

SSP1800

ARM884



ARM883

SSP1800



ARM882

SSP1800

	PART NO.	DESCRIPTION	NOTES	O.E.
ARM882	301181388200	Suspension Control Arm and Ball Joint Assembly - Front Right		352522; 95025704
ARM883	301181388300	Suspension Control Arm and Ball Joint Assembly - Front Right Lower		352523; 95025705
ARM884	301181388400	Suspension Control Arm and Ball Joint Assembly - Front Left Lower		352524; 95025706
SSP0194	301191601940	Steering Tie Rod - Front	without eps	1609205; 95932789
SSP0598	301191605980	Steering Tie Rod End - Front	Elektrical Type M14X1,5	1609203; 95914910; 95932779
SSP1800	301191618000	Suspension Ball Joint - Front Lower		352532; 95916024



CHEVROLET UPLANDER



2005-2008



SSP2113

SSP2114



SSP2114

SSP2113

PART NO.	DESCRIPTION	NOTES	O.E.
SSP2113 301191621130	Suspension Stabilizer Bar Link - Rear	2WD	15851956
SSP2114 301191621140	Suspension Stabilizer Bar Link - Rear	4WD	15232855

**CHEVROLET VOLT 1st Gen**

2010-2015

**SSP2490****ARM368****ARM367****SSP2490**

	PART NO.	DESCRIPTION	NOTES	O.E.
ARM367	301181336700	Suspension Control Arm and Ball Joint Assembly - Front Right Lower		13334023; C13272606
ARM368	301181336800	Suspension Control Arm and Ball Joint Assembly - Front Left Lower		13334022; C13272605
SSP0028	301191600280	Steering Tie Rod - Front	M16x1,5 - L=295mm	13278358*
SSP0604	301191606040	Steering Tie Rod End - Front	M16x1,5	13272000; 1609026; 6606031; 13286686; 13278359
SSP2490	301191624900	Suspension Stabilizer Bar Link - Front	Plastic L=304mm	13219141; 350617; C13219141



CHEVROLET VOLT 2nd Gen



2016-

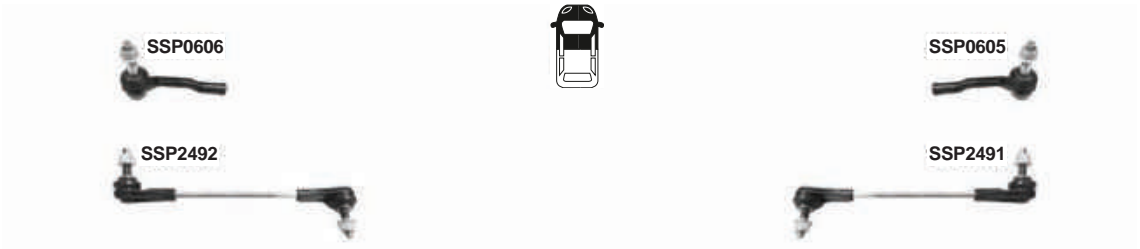

PART NO.	DESCRIPTION	NOTES	O.E.
SSP0203 301191602030	Steering Tie Rod - Front		13464344
SSP0605 301191606050	Steering Tie Rod End - Front Right		39008083
SSP0606 301191606060	Steering Tie Rod End - Front Left		39008084
SSP2491 301191624910	Suspension Stabilizer Bar Link - Front Right	A = 307 MM	39001004
SSP2492 301191624920	Suspension Stabilizer Bar Link - Front Left	A = 307 MM	39001003



CHRYSLER 200 1st Gen



2011-2014

**SSP2146****SSP2146**

	PART NO.	DESCRIPTION	NOTES	O.E.
ARM440	301181344000	Suspension Control Arm - Front Right Lower		5085408AK
ARM441	301181344100	Suspension Control Arm - Front Left Lower		5085407AK
SSP0063	301191600630	Steering Tie Rod - Front		68040223AE
SSP1186	301181311860	Suspension Ball Joint - Front Lower		K05090033AB; 5090033AB
SSP2146	301191621460	Suspension Stabilizer Bar Link - Front		68186554AB; 68186554AA



PART NO.	DESCRIPTION	NOTES	O.E.
SSP0069 301191600690	Steering Tie Rod - Front		68164072AB
SSP0397 301191603970	Steering Tie Rod End - Front Right		68185502AB
SSP0398 301191603980	Steering Tie Rod End - Front Left		68185503AB



CHRYSLER 300 1st Gen



2005-2010

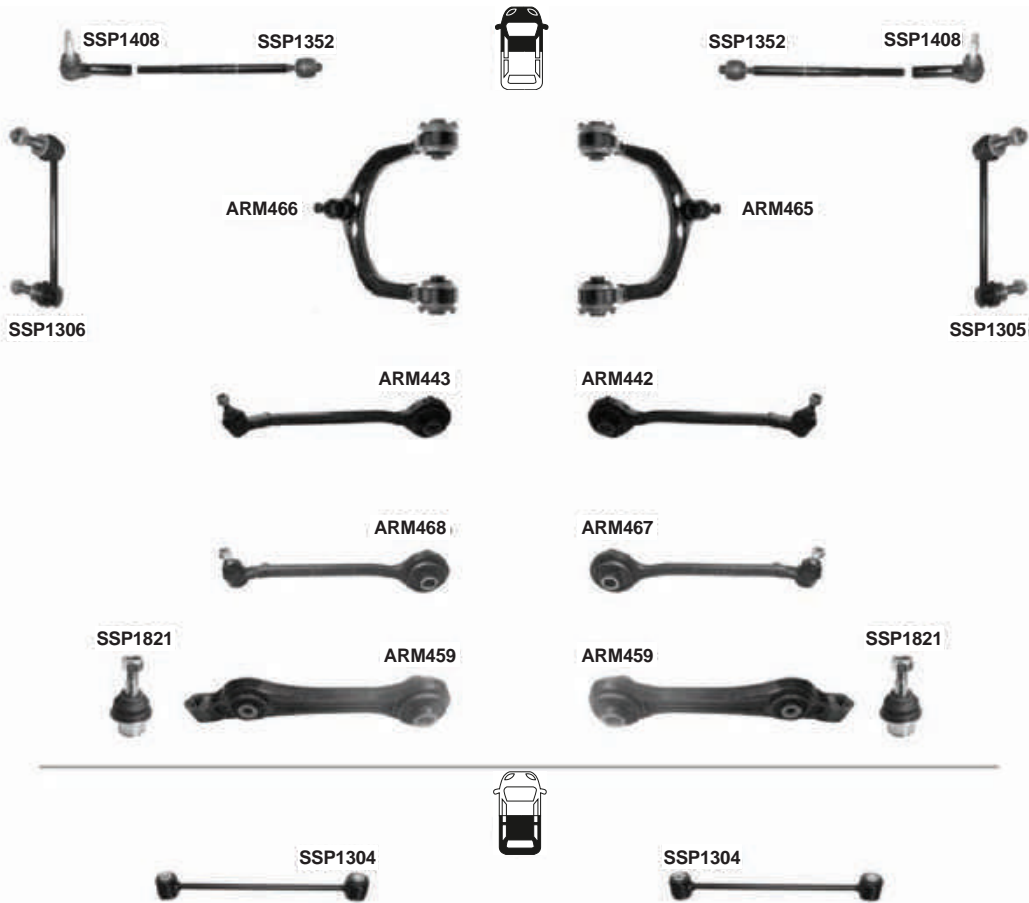

PART NO.	DESCRIPTION	NOTES	O.E.
ARM442 301181344200	Suspension Control Arm and Ball Joint Assembly - Front Right	RWD	05180606AA; DA782612AC; 782612AC; 05180606AB
ARM443 301181344300	Suspension Control Arm and Ball Joint Assembly - Front Left	RWD	05180607AA; DA782613AC; 782613AC
ARM459 301181345900	Suspension Control Arm - Rear Lower Forward	RWD	04782561AA; 04782561AE; 04782561AF; 04782561AD; 04782561AC; 04782561AB
ARM465 301181346500	Suspension Control Arm and Ball Joint Assembly - Front Right Upper	RWD	68045130AE; 04782666AE
ARM466 301181346600	Suspension Control Arm and Ball Joint Assembly - Front Left Upper	RWD	68045131AE; 04782665AE
ARM467 301181346700	Suspension Control Arm and Ball Joint Assembly - Front Right Lower	HEAVY DUTY SUSP.	05290828AB
ARM468 301181346800	Suspension Control Arm and Ball Joint Assembly - Front Left Lower	HEAVY DUTY SUSP.	05290829AB
SSP1304 301181313040	Suspension Stabilizer Bar Link - Rear	L=261mm	4766866AA
SSP1305 301181313050	Suspension Stabilizer Bar Link - Front Right	L=214mm	4895482AA; 4895482AC; K04895483AB
SSP1306 301181313060	Suspension Stabilizer Bar Link - Front Left	L=214mm	4895483AA; K0489548AB
SSP1342 301181313420	Rubber to Metal		04782684AB
SSP1352 301181313520	Steering Tie Rod - Front	M15x1.5 - L=323.5mm	68028831AC; 680288331AR
SSP1408 301181314080	Steering Tie Rod End - Front Outer		52013468AB; 68141049AA; 52013468AC
SSP1821 301191618210	Suspension Ball Joint - Front Lower	RWD	68159271AA; 4782741AB; 4782740AB; 4782740AA



CHRYSLER 300M 1st Gen



1998-2004



SSP0385



SSP0385



SSP2152



SSP2152

PART NO.	DESCRIPTION	NOTES	O.E.
SSP0385 301191603850	Steering Tie Rod End - Front		5086282AA; 5003930AA
SSP2152 301191621520	Suspension Stabilizer Bar Link - Front		04782254AB



CHRYSLER 300 2nd Gen



2011-2017

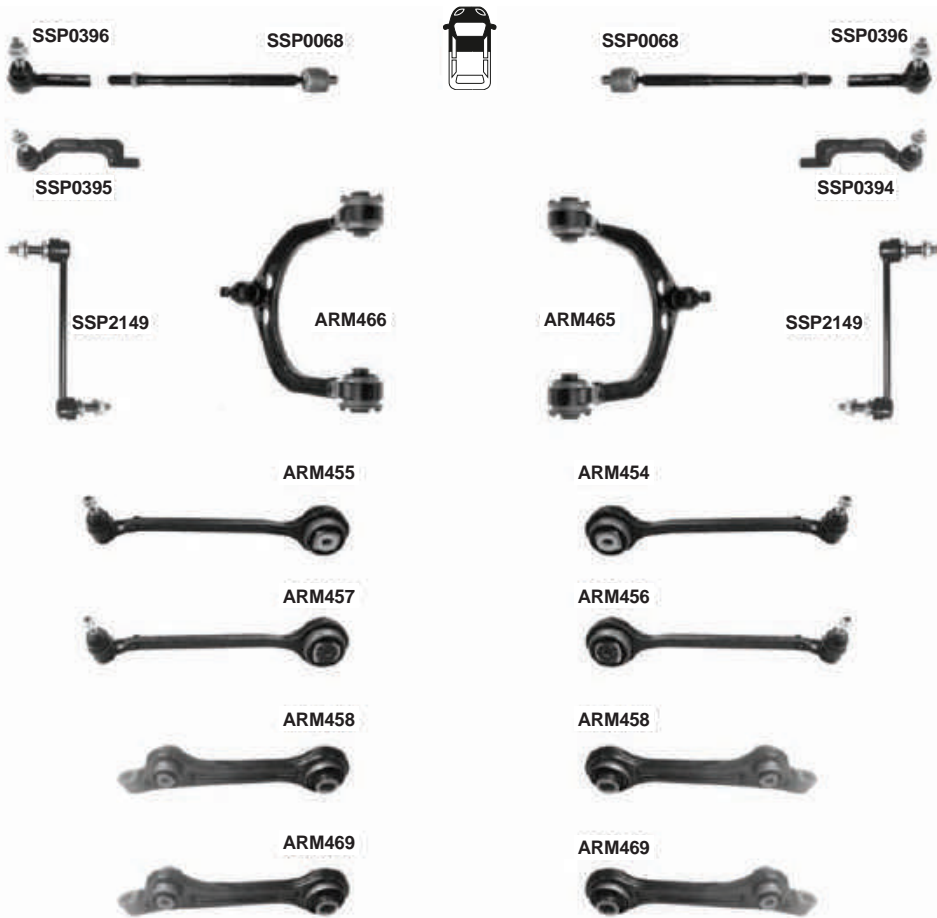

PART NO.	DESCRIPTION	NOTES	O.E.
ARM454	301181345400 Suspension Control Arm and Ball Joint Assembly - Front Right Lower	HEAVY DUTY SUSP. RWD	04670508AD
ARM455	301181345500 Suspension Control Arm and Ball Joint Assembly - Front Left Lower	HEAVY DUTY SUSP. RWD	04670509AD
ARM456	301181345600 Suspension Control Arm and Ball Joint Assembly - Front Right Lower	RWD	05168652AC
ARM457	301181345700 Suspension Control Arm and Ball Joint Assembly - Front Left Lower	RWD	05168653AC
ARM458	301181345800 Suspension Control Arm - Front Lower	RWD	05168389AB; 05168389AA
ARM465	301181346500 Suspension Control Arm and Ball Joint Assembly - Front Right Upper	RWD	68045130AE; 04782666AE
ARM466	301181346600 Suspension Control Arm and Ball Joint Assembly - Front Left Upper	RWD	68045131AE; 04782665AE
ARM469	301181346900 Suspension Control Arm - Front Lower	RWD, HEAVY DUTY, HIGH PERF.	68079723AB
SSP0064	301191600640 Steering Tie Rod - Front	4x4	68158379AA
SSP0068	301191600680 Steering Tie Rod - Front		68158377AA
SSP0394	301191603940 Steering Tie Rod End - Front Right	4WD	68156906AA
SSP0395	301191603950 Steering Tie Rod End - Front Left	4WD	68156905AA
SSP0396	301191603960 Steering Tie Rod End - Front	RWD	68156902AA
SSP2149	301191621490 Suspension Stabilizer Bar Link - Front	4x4	4782952AD



CHRYSLER CONCORDE 2nd Gen



1998-2004



SSP0385



SSP0385



SSP2152



SSP2152

PART NO.	DESCRIPTION	NOTES	O.E.
SSP0385 301191603850	Steering Tie Rod End - Front		5086282AA; 5003930AA
SSP2152 301191621520	Suspension Stabilizer Bar Link - Front		04782254AB



CHRYSLER GRAND VOYAGER III 01/1995-03/2001

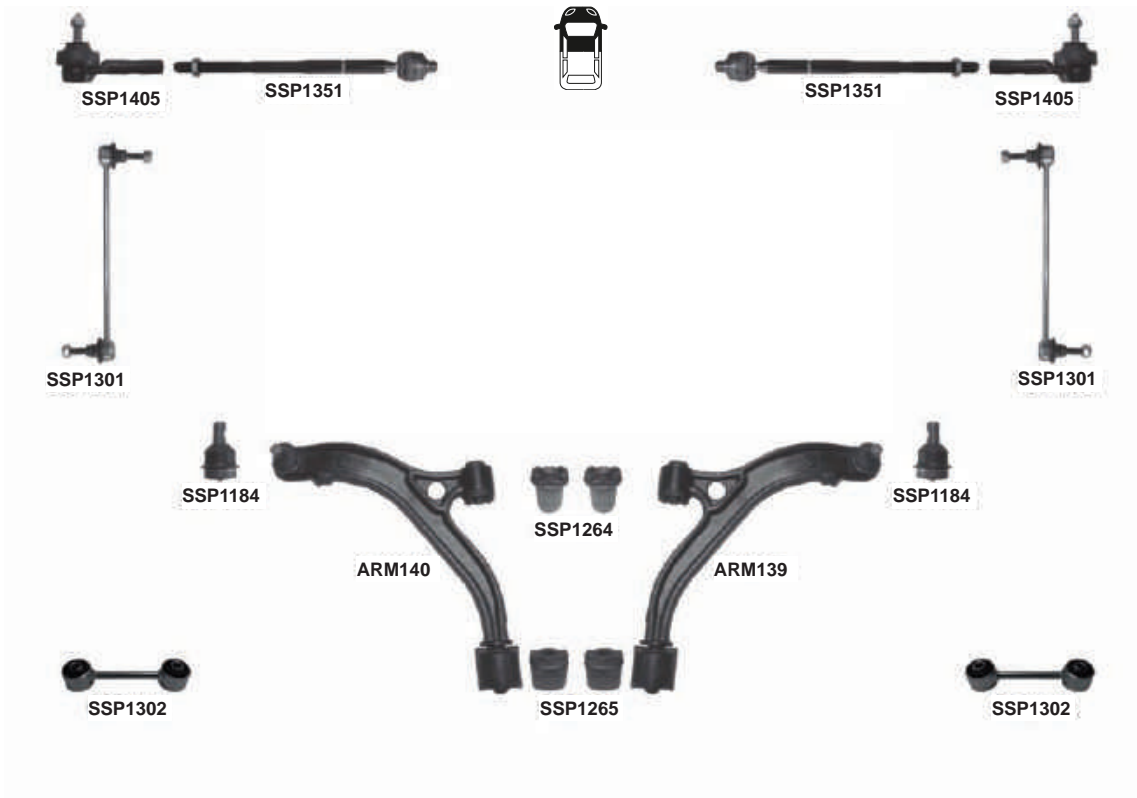

	PART NO.	DESCRIPTION	NOTES	O.E.
ARM139	301181313900	Suspension Control Arm and Ball Joint Assembly - Front Right		4694760
ARM140	301181314000	Suspension Control Arm and Ball Joint Assembly - Front Left		4694761
SSP1184	301181311840	Suspension Ball Joint - Front Lower	D=Ø19.9mm	4443405; 4449553
SSP1264	301181312640	Bush / Silent block - Track control arm	ARM139 / ARM140 / ARM141 / ARM142	
SSP1265	301181312650	Bush / Silent block - Track control arm	ARM139 / ARM140	
SSP1301	301181313010	Suspension Stabilizer Bar Link - Front	L=310mm	4743021AA; K04694855; 4743669AB; 4743669AC; 4743454AC; 4743454AB; 4743454AA
SSP1302	301181313020	Suspension Stabilizer Bar Link - Rear	L=119mm	5272190
SSP1351	301181313510	Steering Tie Rod - Front	M14x1,5	4743935AD
SSP1405	301181314050	Steering Tie Rod End - Front	M14x1,5	4797706; K04797706



CHRYSLER GRAND VOYAGER IV



2000-2008

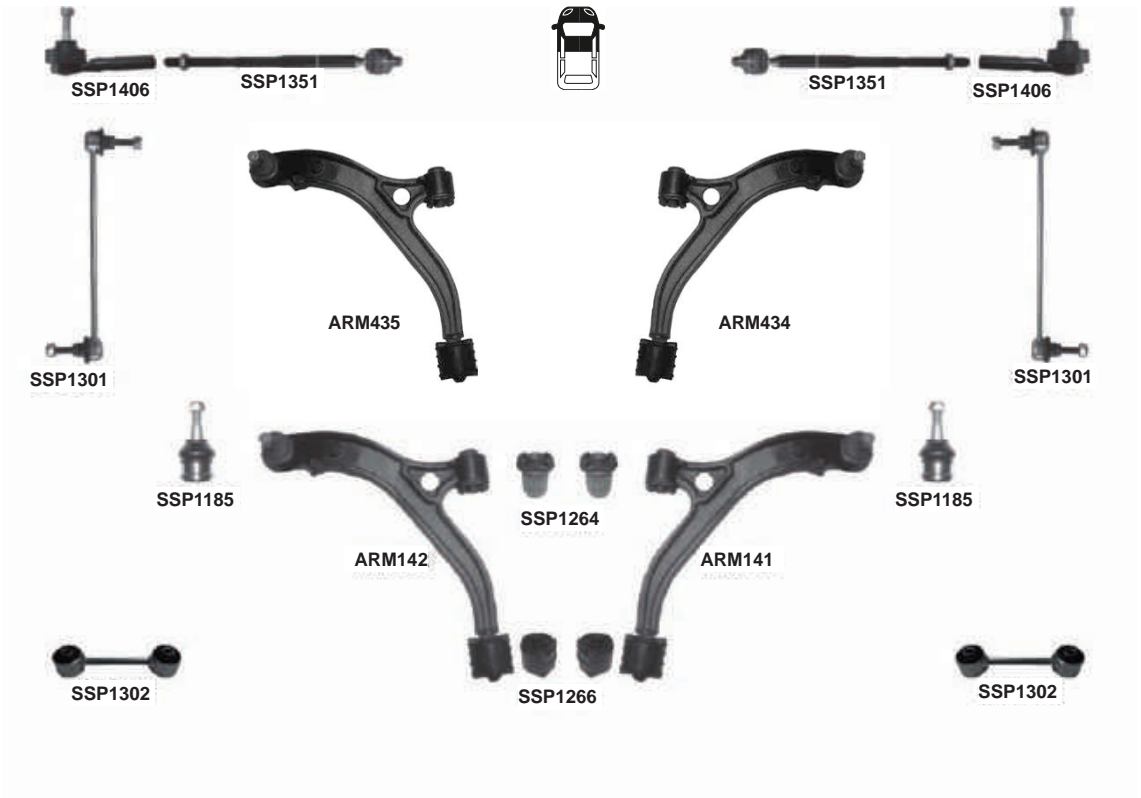

PART NO.	DESCRIPTION	NOTES	O.E.
ARM141	301181314100 Suspension Control Arm and Ball Joint Assembly - Front Right Lower		4766542AA
ARM142	301181314200 Suspension Control Arm and Ball Joint Assembly - Front Left Lower		4766543AA
ARM434	301181343400 Suspension Control Arm - Front Right Lower		4766542
ARM435	301181343500 Suspension Control Arm - Front Left Lower		4766543
SSP1185	301181311850 Suspension Ball Joint - Front Lower		5051316
SSP1264	301181312640 Bush / Silent block - Track control arm	ARM139 / ARM140 / ARM141 / ARM142	
SSP1266	301181312660 Bush / Silent block - Track control arm	ARM141 / ARM142	
SSP1301	301181313010 Suspension Stabilizer Bar Link - Front	L=310mm	4743021AA; K04694855; 4743669AB; 4743669AC; 4743454AC; 4743454AB; 4743454AA
SSP1302	301181313020 Suspension Stabilizer Bar Link - Rear	L=119mm	5272190
SSP1351	301181313510 Steering Tie Rod - Front	M14x1,5	4743935AD
SSP1406	301181314060 Steering Tie Rod End - Front	M14x1,5	05066373AB; K05183761AA; ES3008RL; 5183761AA; 05183761AD



CHRYSLER GRAND VOYAGER IV



2001-2003



	PART NO.	DESCRIPTION	NOTES	O.E.
ARM436	301181343600	Suspension Control Arm and Ball Joint Assembly - Front Right Lower		4743834AB
ARM437	301181343700	Suspension Control Arm and Ball Joint Assembly - Front Left Lower		4743835AB



CHRYSLER PT CRUISER



06/2000-12/2010



PART NO.	DESCRIPTION	NOTES	O.E.
ARM151	301181315100 Suspension Control Arm and Ball Joint Assembly - Front Right Lower		04656730AH
ARM152	301181315200 Suspension Control Arm and Ball Joint Assembly - Front Left Lower		04656731AH
SSP1262	301181312620 Bush / Silent block - Track control arm	ARM151 / ARM152	4656012AC
SSP1263	301181312630 Bush / Silent block - Track control arm	ARM151 / ARM152	
SSP1407	301181314070 Steering Tie Rod End - Front	M14X1,5	4762861; 4762861AA
SSP2147	301191621470 Suspension Stabilizer Bar Link - Front	L=115mm / M8x1.25	K05272324AC
SSP2148	301191621480 Suspension Stabilizer Bar Link - Rear	L=185mm	04656934AA; K0465693AAB; K04656934AA; 04656934AB

**CHRYSLER SEBRING FJ/JX**

1995-2000

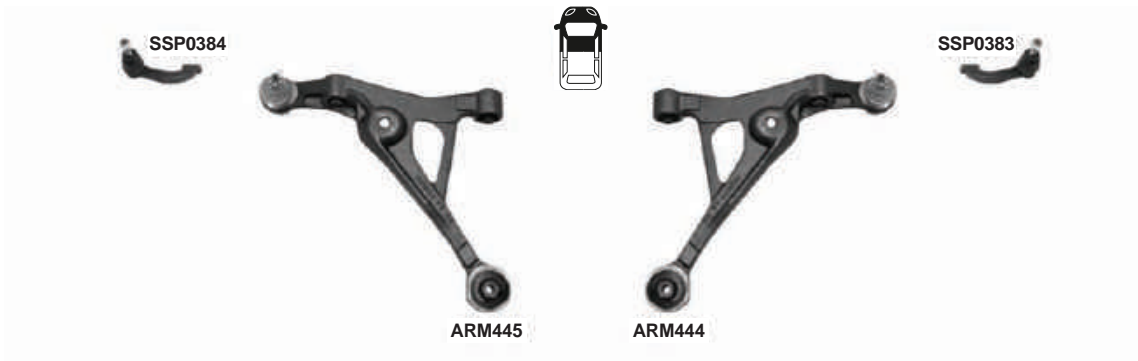

	PART NO.	DESCRIPTION	NOTES	O.E.
ARM444	301181344400	Suspension Control Arm and Ball Joint Assembly - Front Right	for JX,JXi els	10946; K7427; 4764501AC; 4616922
ARM445	301181344500	Suspension Control Arm and Ball Joint Assembly - Front Left	for JX,JXi els	10945; K7425; 4764500AC; 4616923
SSP0383	301191603830	Steering Tie Rod End - Front Right Outer		5094006AA
SSP0384	301191603840	Steering Tie Rod End - Front Left Outer		5093857AA



CHRYSLER SEBRING ST22/JR



2001-2006

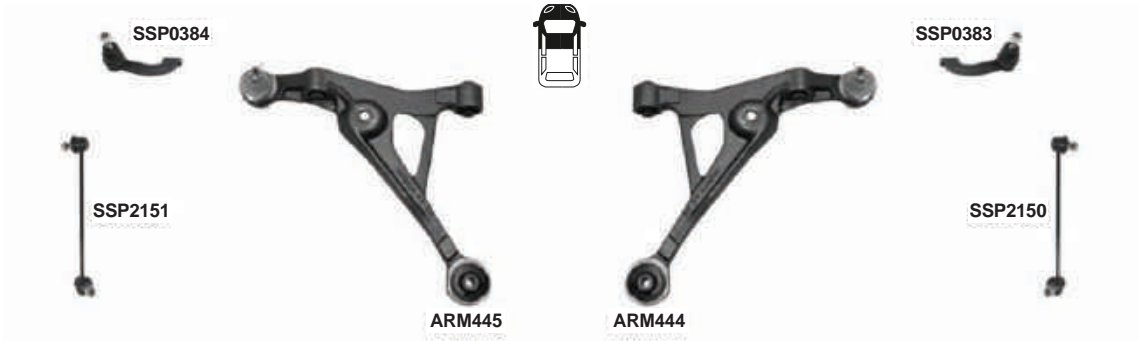

PART NO.	DESCRIPTION	NOTES	O.E.
ARM444 301181344400	Suspension Control Arm and Ball Joint Assembly - Front Right	for JX,JXi els	10946; K7427; 4764501AC; 4616922
ARM445 301181344500	Suspension Control Arm and Ball Joint Assembly - Front Left	for JX,JXi els	10945; K7425; 4764500AC; 4616923
SSP0383 301191603830	Steering Tie Rod End - Front Right Outer		5094006AA
SSP0384 301191603840	Steering Tie Rod End - Front Left Outer		5093857AA
SSP2150 301191621500	Suspension Stabilizer Bar Link - Front Right		MR333763
SSP2151 301191621510	Suspension Stabilizer Bar Link - Front Left		MR297333

**CHRYSLER SEBRING JS 3rd Gen**

07/2007-12/2010

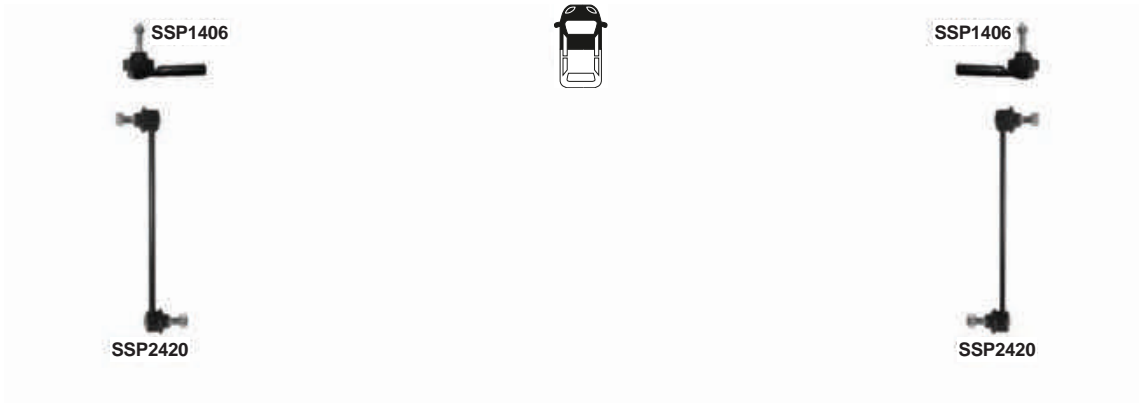

	PART NO.	DESCRIPTION	NOTES	O.E.
ARM440	301181344000	Suspension Control Arm - Front Right Lower		5085408AK
ARM441	301181344100	Suspension Control Arm - Front Left Lower		5085407AK
SSP1406	301181314060	Steering Tie Rod End - Front	M14x1,5	05066373AB; K05183761AA; ES3008RL; 5183761AA; 05183761AD
SSP2420	301191624200	Suspension Stabilizer Bar Link - Front	L=265mm	5087.58; MN101368



CHRYSLER TOWN & COUNTRY II 

1991-1995

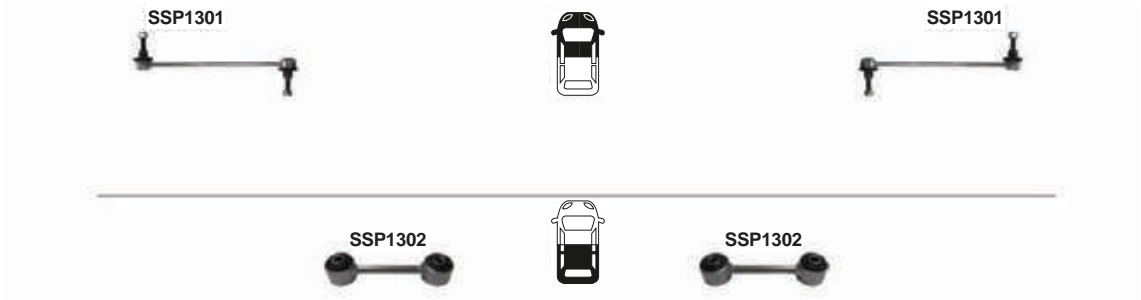

PART NO.		DESCRIPTION	NOTES	O.E.
SSP1301	301181313010	Suspension Stabilizer Bar Link - Front	L=310mm	4743021AA; K04694855; 4743669AB; 4743669AC; 4743454AC; 4743454AB; 4743454AA
SSP1302	301181313020	Suspension Stabilizer Bar Link - Rear	L=119mm	5272190



CHRYSLER TOWN & COUNTRY III

1995-2001



PART NO.	DESCRIPTION	NOTES	O.E.
ARM139 301181313900	Suspension Control Arm and Ball Joint Assembly - Front Right		4694760
ARM140 301181314000	Suspension Control Arm and Ball Joint Assembly - Front Left		4694761
SSP1301 301181313010	Suspension Stabilizer Bar Link - Front	L=310mm	4743021AA; K04694855; 4743669AB; 4743669AC; 4743454AC; 4743454AB; 4743454AA
SSP1302 301181313020	Suspension Stabilizer Bar Link - Rear	L=119mm	5272190
SSP1405 301181314050	Steering Tie Rod End - Front	M14x1,5	4797706; K04797706



CHRYSLER TOWN & COUNTRY IV 

2001-2007



SSP1185



SSP1185



SSP1301



SSP1301

SSP1302



SSP1302



PART NO.	DESCRIPTION	NOTES	O.E.
ARM436 301181343600	Suspension Control Arm and Ball Joint Assembly - Front Right Lower		4743834AB
ARM437 301181343700	Suspension Control Arm and Ball Joint Assembly - Front Left Lower		4743835AB
SSP1185 301181311850	Suspension Ball Joint - Front Lower		5051316
SSP1301 301181313010	Suspension Stabilizer Bar Link - Front	L=310mm	4743021AA; K04694855; 4743669AB; 4743669AC; 4743454AC; 4743454AB; 4743454AA
SSP1302 301181313020	Suspension Stabilizer Bar Link - Rear	L=119mm	5272190



CHRYSLER TOWN & COUNTRY V



2008-2016

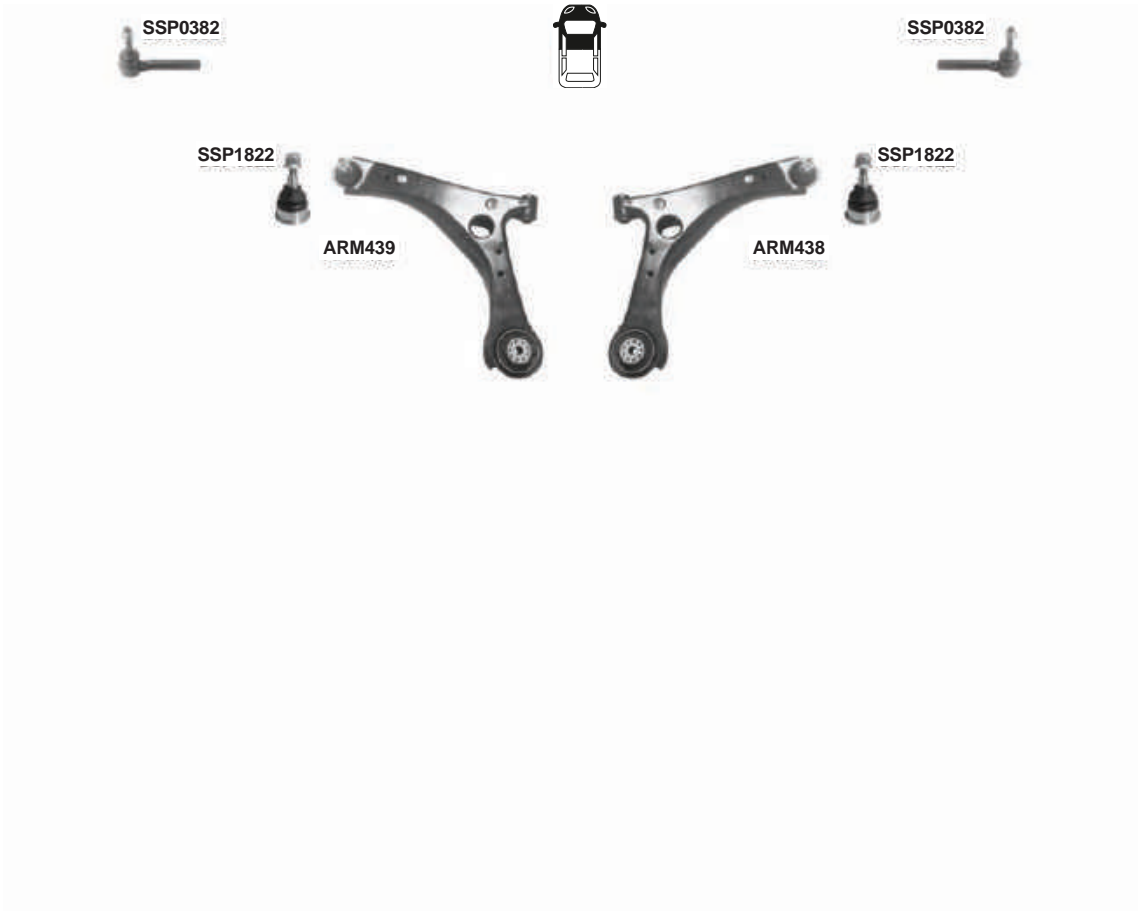

PART NO.	DESCRIPTION	NOTES	O.E.
ARM438	301181343800 Suspension Control Arm and Ball Joint Assembly - Front Right Lower		04766910AL
ARM439	301181343900 Suspension Control Arm and Ball Joint Assembly - Front Left Lower		04766911AL
SSP0061	301191600610 Steering Tie Rod - Front		68157856AA
SSP0062	301191600620 Steering Tie Rod - Front		68040225AA
SSP0381	301191603810 Steering Tie Rod End -		68156146AA
SSP0382	301191603820 Steering Tie Rod End - Front	4x4	68033171AB
SSP1822	301191618220 Suspension Ball Joint - Front Lower		Part of 04766911AL



CITROEN AX



1986-1991



PART NO.	DESCRIPTION	NOTES	O.E.
SSP0051 301191600510	Steering Tie Rod - Front	M14x1,5Rht / Lht - L=380mm	3812.A0; 95069129
SSP0369 301191603690	Steering Tie Rod End - Front Left	M14x1,5Rht	3817.14; 9471000565; 9471007465; 9458084180; 3817.41; 3817.30



CITROEN AX



1992-1998

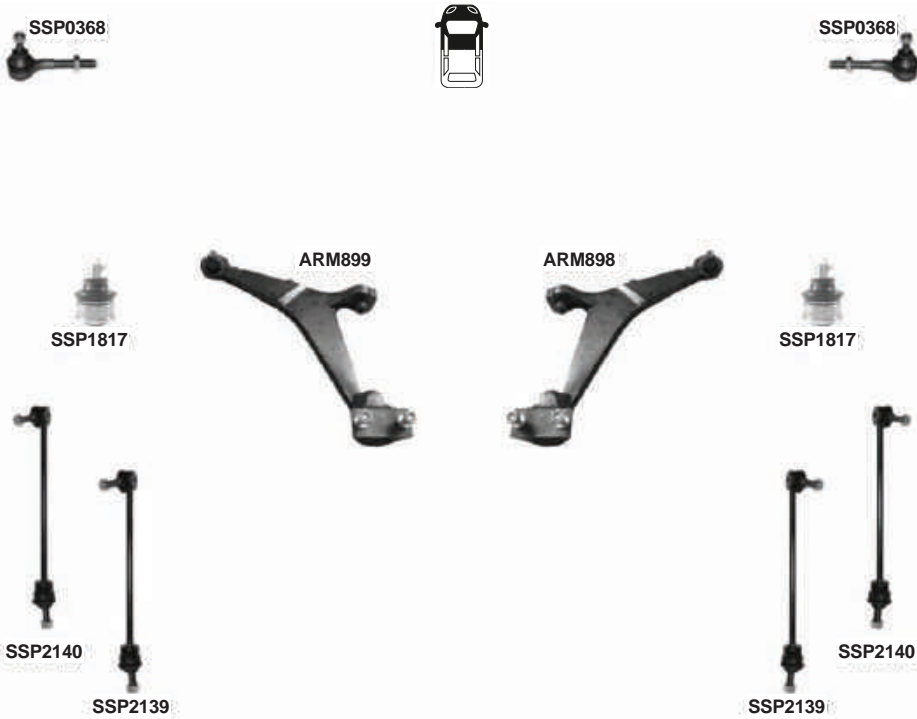

	PART NO.	DESCRIPTION	NOTES	O.E.
ARM898	301181389800	Suspension Control Arm and Ball Joint Assembly - Front Right Lower	Ball Joint D=Ø16mm	3520.79; 95658979
ARM899	301181389900	Suspension Control Arm and Ball Joint Assembly - Front Left Lower	Ball Joint D=Ø16mm	3520.78; 95658978
SSP0368	301191603680	Steering Tie Rod End - Front Right	M14x1,5Rht	3817.16; 9471007565; 9471000665; 3817.42; 3817.31
SSP1817	301191618170	Suspension Ball Joint - Front Lower	D=Ø16mm	3640.36; 96093233
SSP2139	301191621390	Suspension Stabilizer Bar Link - Front	L=322,5mm M12 Thread	5087.40; 96177836; 93802209
SSP2140	301191621400	Suspension Stabilizer Bar Link - Front	(Clip-on patented design) L=322,5mm M12 Thread	500310933; 96145457; 5087.40



CITROEN BERLINGO MF

07/1996-





CITROEN BERLINGO MF



07/1996-

	PART NO.	DESCRIPTION	NOTES	O.E.
ARM410	301181341000	Suspension Control Arm and Ball Joint Assembly - Front Right Lower	Manual steering Ch.->7972 Ball Joint D=Ø 16mm	3521.A6; 95658884
ARM411	301181341100	Suspension Control Arm and Ball Joint Assembly - Front Left Lower	Manual steering Ch.->7972 Ball Joint D=Ø 16mm	3520.A3; 95658885
ARM412	301181341200	Suspension Control Arm and Ball Joint Assembly - Front Right Lower	Ch.->7972 Ball Joint Power D=Ø16mm	3521.C4; 95668511; 95658883
ARM413	301181341300	Suspension Control Arm and Ball Joint Assembly - Front Left Lower	Ch.->7972 Ball Joint Power D=Ø16mm	3520.A2; 95658882; 3520.F5
ARM414	301181341400	Suspension Control Arm and Ball Joint Assembly - Front Right Lower		3521.F3; 3521.R4; 3521.L4
ARM415	301181341500	Suspension Control Arm and Ball Joint Assembly - Front Left		3520.Q4; 3520.Q3; 3520.J3
ARM924	301181392400	Suspension Control Arm and Ball Joint Assembly - Front Right Lower	Power steering Ch.No:7973-> Ball Joint D=Ø18mm	3521.69; 3521.E5
ARM925	301181392500	Suspension Control Arm and Ball Joint Assembly - Front Left Lower	Power steering Ch.No:7973-> Ball Joint D=Ø18mm	3520.H3; 3520.H5
SSP0050	301191600500	Steering Tie Rod - Front	M14x1,5Rht - L=335.5mm	3812.C0; 96048214; 3812.E4
SSP0612	301191606120	Steering Tie Rod End - Front	M14x1,5Rht	3817.10; 95493208; 9471000965; 9471003465; 3817.18; 3817.50
SSP1815	301191618150	Suspension Ball Joint - Front Lower	Ch.No:-> 7972 Manual Steering D=Ø 16mm	3640.38; 9613696; 96035445; 3640.42
SSP1816	301191618160	Suspension Ball Joint - Front Lower	Ch.No:-> 7972 Power Steering D=Ø 16mm	3640.39; 96025445; 3640.43
SSP1938	301191619380	Suspension Ball Joint - Front	Ch.No:7973-> Power Steering D=Ø18mm	3640.50; 96087507; 3640.51
SSP2137	301191621370	Suspension Stabilizer Bar Link - Front	Metal L=300mm	5087.34; 5087.61; 5087.46; 5087.39
SSP2506	301191625060	Suspension Stabilizer Bar Link - Front	Plastic Type L=300mm	5087.42; 96152213

CITROEN BERLINGO M

 04/2008-

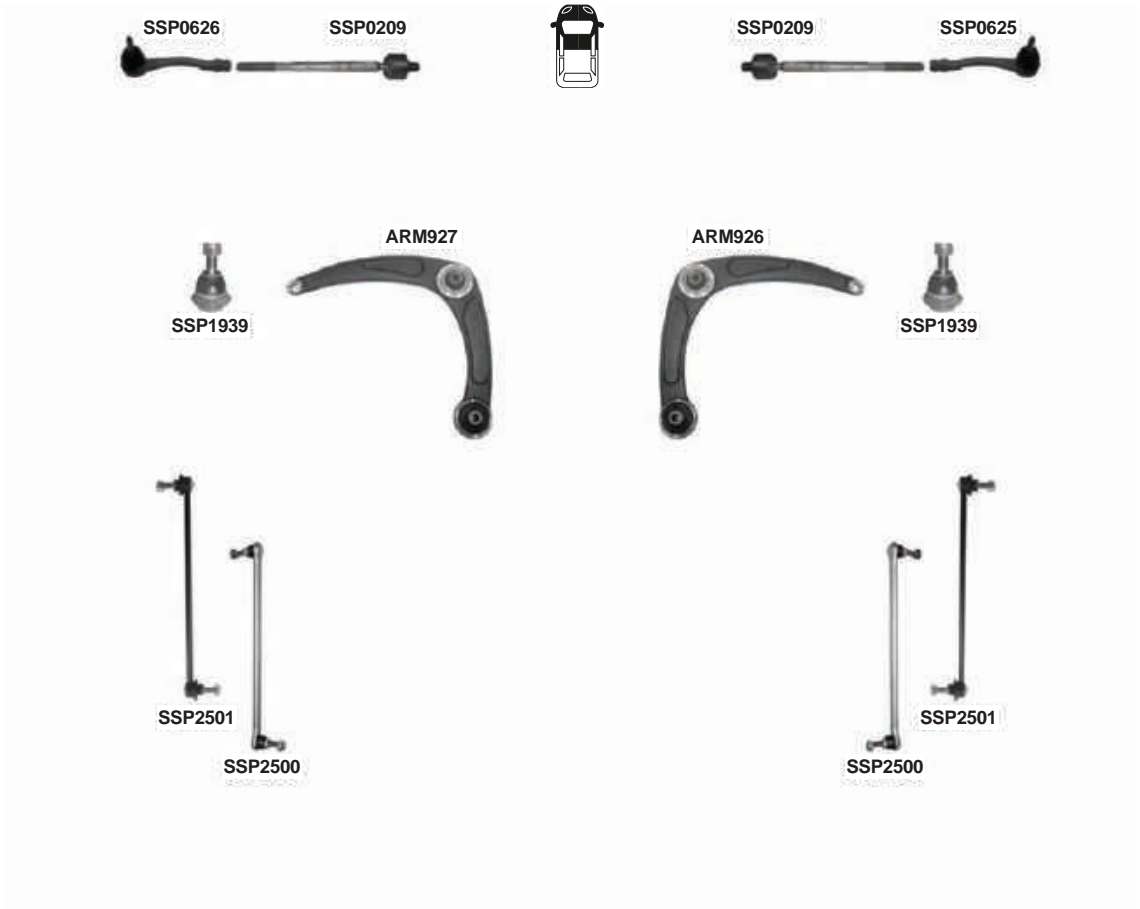

PART NO.	DESCRIPTION	NOTES	O.E.
ARM926	301181392600 Suspension Control Arm - Front Right Lower		3521.G8; 3521.P3; 3521.K3
ARM927	301181392700 Suspension Control Arm - Front Left		3520.K8; 3520.S2; 3520.P3
SSP0209	301191602090 Steering Tie Rod - Front	M14x1,5 - L=254.7mm	3812.F4
SSP0625	301191606250 Steering Tie Rod End - Front Right	M14x1,5	3817.75; 3817.88
SSP0626	301191606260 Steering Tie Rod End - Front Left	M14x1,5	3817.76; 3817.89
SSP1939	301191619390 Suspension Ball Joint - Front Lower		3640.53; 3640.68; 3640.60
SSP2500	301191625000 Suspension Stabilizer Bar Link - Front	Alm.Design L=334mm	5087.57
SSP2501	301191625010 Suspension Stabilizer Bar Link - Front	Metal Design L=334mm	5087.57
SSP2502	301191625020 Suspension Stabilizer Bar Link - Front		5087.57



CITROEN C1



06/2005-03/2014



SSP0614



SSP0205

SSP0205



SSP0613



SSP2496



ARM903

SSP1971



ARM902

SSP1971



SSP2496



SSP2495



SSP2495

	PART NO.	DESCRIPTION	NOTES	O.E.
ARM902	301181390200	Suspension Control Arm and Ball Joint Assembly - Front Right Lower		3521.L3; 480680H010; 3521.N7
ARM903	301181390300	Suspension Control Arm and Ball Joint Assembly - Front Left Lower		3520.Q2; 480690H010; 3520.R6
SSP0205	301191602050	Steering Tie Rod - Front	M12X1,25 - L=224mm	4001.33; 455000H010
SSP0613	301191606130	Steering Tie Rod End - Front Right Outer	M12x1,25	3817.64
SSP0614	301191606140	Steering Tie Rod End - Front Left Outer	M12x1,25	3817.63
SSP1971	301191619710	Suspension Ball Joint - Front Lower		4330859035; 4330859095
SSP2495	301191624950	Suspension Stabilizer Bar Link - Front	L=335mm	5087.45; 96288787
SSP2496	301191624960	Suspension Stabilizer Bar Link - Front	(Clip-on patented design) L=335mm	5087.45; 96288787



CITROEN C2 JM



09/2003-09/2009

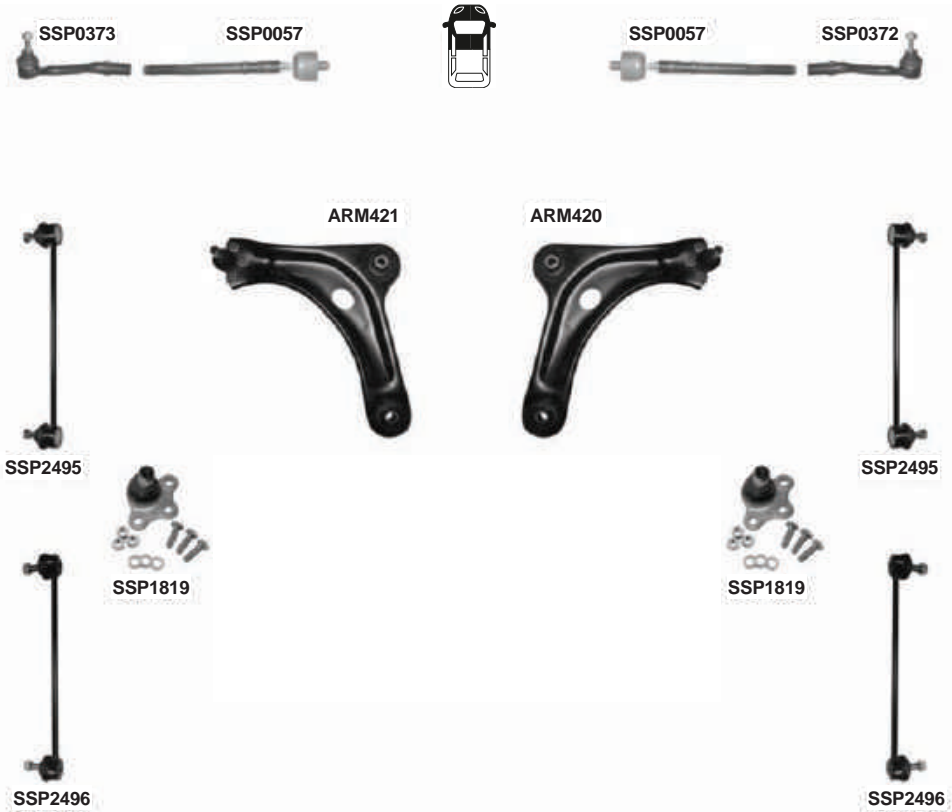

PART NO.	DESCRIPTION	NOTES	O.E.
ARM420	301181342000 Suspension Control Arm and Ball Joint Assembly - Front Right Lower		3521.H6; 3521.N2; 3521.N1; 3521.L1
ARM421	301181342100 Suspension Control Arm and Ball Joint Assembly - Front Left Lower		3520.L4; 3520.V1; 3520.R6; 3520.P1; 3520.N1
SSP0057	301191600570 Steering Tie Rod - Front	M14x1,5 - L=235mm	3812.E1
SSP0372	301191603720 Steering Tie Rod End - Front Right	M-14x1,5Rht	3817.56
SSP0373	301191603730 Steering Tie Rod End - Front Left	M-14x1,5Rht	3817.55
SSP1819	301191618190 Suspension Ball Joint - Front Lower	D=Ø 18mm	3640.56; 3640.66; 3640.65; 3640.62; 3640.61
SSP2495	301191624950 Suspension Stabilizer Bar Link - Front	L=335mm	5087.45; 96288787
SSP2496	301191624960 Suspension Stabilizer Bar Link - Front	(Clip-on patented design) L=335mm	5087.45; 96288787



CITROEN C3 FC



03/2003-10/2009

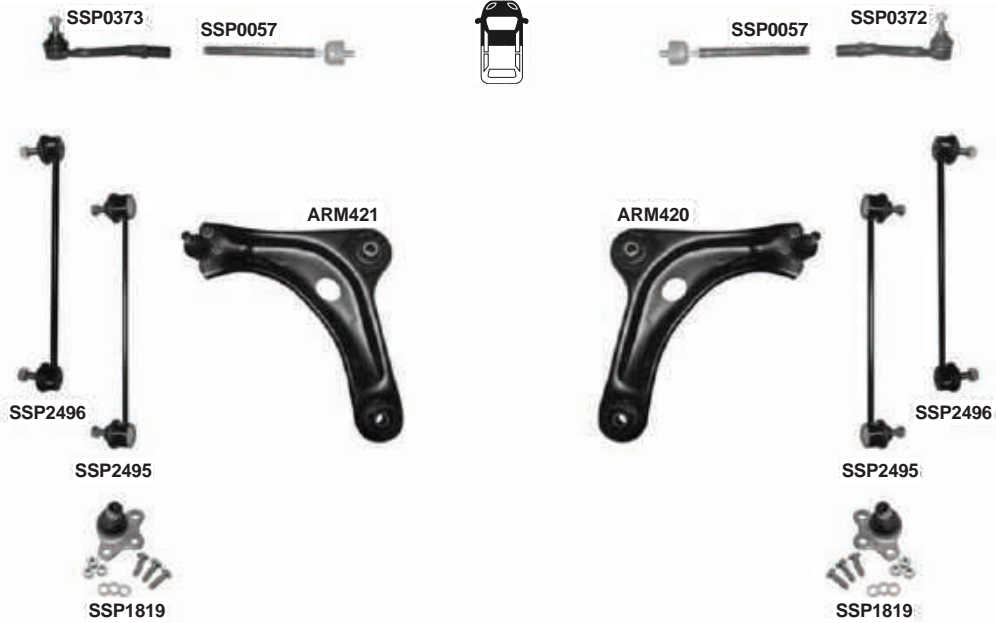

PART NO.	DESCRIPTION	NOTES	O.E.
ARM420	301181342000	Suspension Control Arm and Ball Joint Assembly - Front Right Lower	3521.H6; 3521.N2; 3521.N1; 3521.L1
ARM421	301181342100	Suspension Control Arm and Ball Joint Assembly - Front Left Lower	3520.L4; 3520.V1; 3520.R6; 3520.P1; 3520.N1
SSP0057	301191600570	Steering Tie Rod - Front	M14x1,5 - L=235mm 3812.E1
SSP0372	301191603720	Steering Tie Rod End - Front Right	M-14x1,5Rht 3817.56
SSP0373	301191603730	Steering Tie Rod End - Front Left	M-14x1,5Rht 3817.55
SSP1819	301191618190	Suspension Ball Joint - Front Lower	D=Ø 18mm 3640.56; 3640.66; 3640.65; 3640.62; 3640.61
SSP2495	301191624950	Suspension Stabilizer Bar Link - Front	L=335mm 5087.45; 96288787
SSP2496	301191624960	Suspension Stabilizer Bar Link - Front	(Clip-on patented design) L=335mm 5087.45; 96288787



PART NO.	DESCRIPTION	NOTES	O.E.
ARM422 301181342200	Suspension Control Arm and Ball Joint Assembly - Front Right Lower		3521.S9
ARM423 301181342300	Suspension Control Arm and Ball Joint Assembly - Front Left Lower		3520.W7
SSP0058 301191600580	Steering Tie Rod - Front	M14x1,5 - L=245mm	3812.F6
SSP0374 301191603740	Steering Tie Rod End - Front Right	M14x1,5	3817.91
SSP0375 301191603750	Steering Tie Rod End - Front Left	M14x1,5	3817.92
SSP1820 301191618200	Suspension Ball Joint - Front Lower		3640.77
SSP2144 301191621440	Suspension Stabilizer Bar Link - Front	Alm.Desingng L=335mm	5087.71; 5087.74
SSP2145 301191621450	Suspension Stabilizer Bar Link - Front	Metal Desing L=335mm	5087.71*; 96288787*



CITROEN C3 PICASSO



02/2009-



SSP0618



SSP0208



SSP0208



SSP0617



SSP1819



SSP1819



SSP2498



SSP2497

PART NO.	DESCRIPTION	NOTES	O.E.
SSP0208 301191602080	Steering Tie Rod - Front	M16x1,5 - L=213mm	3812.E8
SSP0617 301191606170	Steering Tie Rod End - Front Right	M16X1,5	1608652380; 3817.68
SSP0618 301191606180	Steering Tie Rod End - Front Left	M16X1,5	1608652280; 3817.67
SSP1819 301191618190	Suspension Ball Joint - Front Lower	D=Ø 18mm	3640.56; 3640.66; 3640.65; 3640.62; 3640.61
SSP2497 301191624970	Suspension Stabilizer Bar Link - Front Right	L=330mm	5087.55; 5087.68
SSP2498 301191624980	Suspension Stabilizer Bar Link - Front Left	L=330mm	5087.54; 5087.69



CITROEN C4 LA



11/2004-10/2009



PART NO.	DESCRIPTION	NOTES	O.E.
ARM926	301181392600 Suspension Control Arm - Front Right Lower		3521.G8; 3521.P3; 3521.K3
ARM927	301181392700 Suspension Control Arm - Front Left		3520.K8; 3520.S2; 3520.P3
SSP0212	301191602120 Steering Tie Rod - Front	Ch.No:->10310 M14x1,5 - L=322mm	3812.E0
SSP0213	301191602130 Steering Tie Rod - Front	Ch.No:10311-> M14x1,5 - L=340mm	3812.E5
SSP0368	301191603680 Steering Tie Rod End - Front Right	M14x1,5Rht	3817.16; 9471007565; 9471000665; 3817.42; 3817.31
SSP0369	301191603690 Steering Tie Rod End - Front Left	M14x1,5Rht	3817.14; 9471000565; 9471007465; 9458084180; 3817.41; 3817.30
SSP1939	301191619390 Suspension Ball Joint - Front Lower		3640.53; 3640.68; 3640.60
SSP2509	301191625090 Suspension Stabilizer Bar Link - Front	L=335mm	5087.50; 96347856; 9804947480; 5087.64; 5087.62
SSP2511	301191625110 Suspension Stabilizer Bar Link - Front	(Clip-on patented design) L=335mm	5087.50*



CITROEN C4 B7



11/2009-

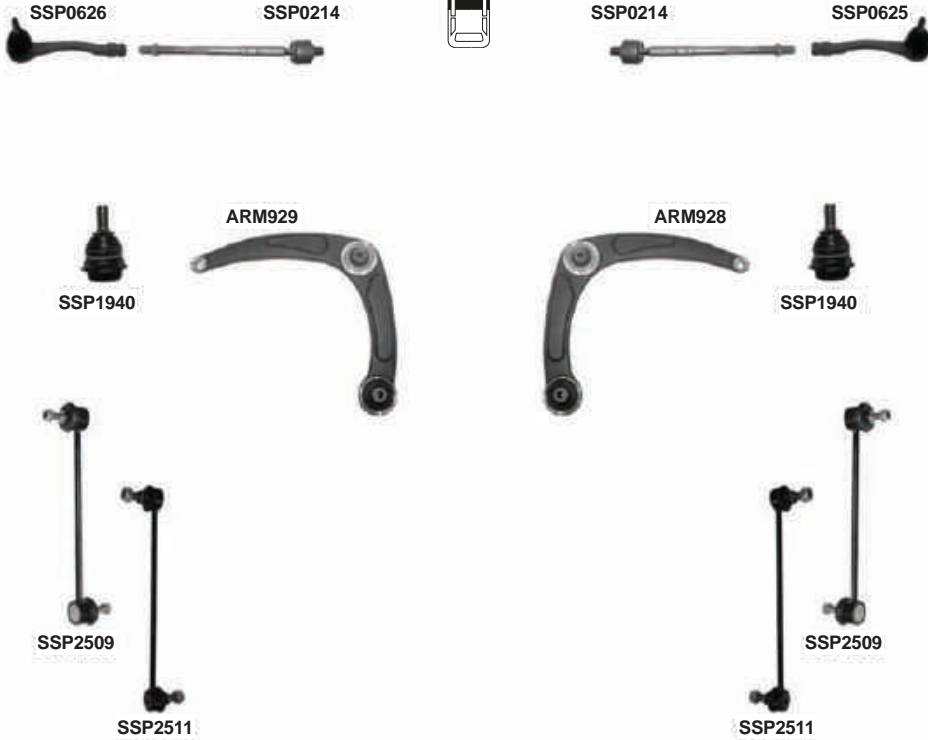

PART NO.	DESCRIPTION	NOTES	O.E.
ARM418	301181341800 Suspension Control Arm - Front Right Lower		9805607380
ARM419	301181341900 Suspension Control Arm - Front Left Lower		9805607380
ARM928	301181392800 Suspension Control Arm - Front Right Lower		3521.R3
ARM929	301181392900 Suspension Control Arm - Front Left		3520.V2
SSP0214	301191602140 Steering Tie Rod - Front	M14x1,5 - L=272mm	3812.F2
SSP0625	301191606250 Steering Tie Rod End - Front Right	M14x1,5	3817.75; 3817.88
SSP0626	301191606260 Steering Tie Rod End - Front Left	M14x1,5	3817.76; 3817.89
SSP1940	301191619400 Suspension Ball Joint - Front		3640.73
SSP2509	301191625090 Suspension Stabilizer Bar Link - Front	L=335mm	5087.50; 96347856; 9804947480; 5087.64; 5087.62
SSP2511	301191625110 Suspension Stabilizer Bar Link - Front	(Clip-on patented design) L=335mm	5087.50*



CITROEN C4 CACTUS

 09/2014-

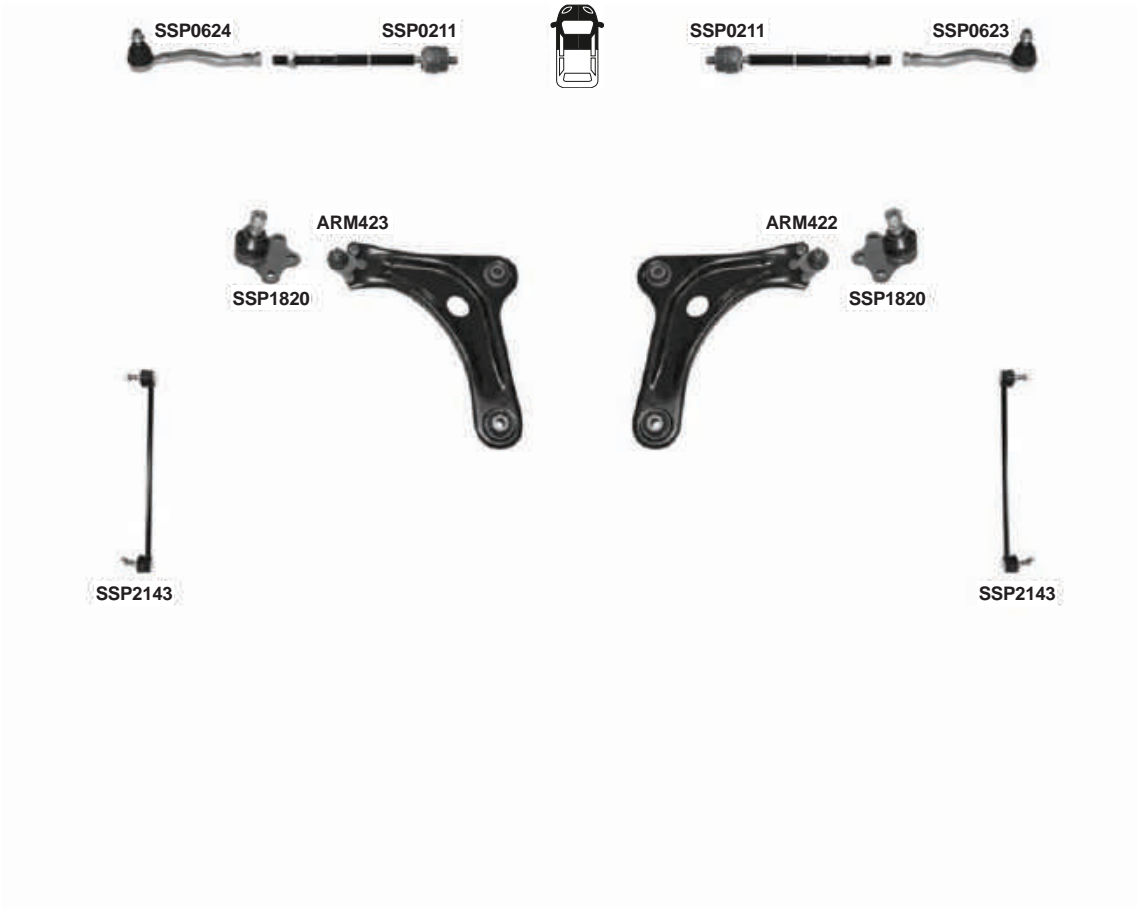

PART NO.	DESCRIPTION	NOTES	O.E.
ARM422 301181342200	Suspension Control Arm and Ball Joint Assembly - Front Right Lower		3521.S9
ARM423 301181342300	Suspension Control Arm and Ball Joint Assembly - Front Left Lower		3520.W7
SSP0211 301191602110	Steering Tie Rod - Front	M14x1.5 - L=225mm	1608025380
SSP0623 301191606230	Steering Tie Rod End - Front Right	M14x1.5 - L=200mm	1608025280
SSP0624 301191606240	Steering Tie Rod End - Front Left	M14x1.5 - L=200mm	1608025180
SSP1820 301191618200	Suspension Ball Joint - Front Lower		3640.77
SSP2143 301191621430	Suspension Stabilizer Bar Link - Front	L=335 mm	9808868280

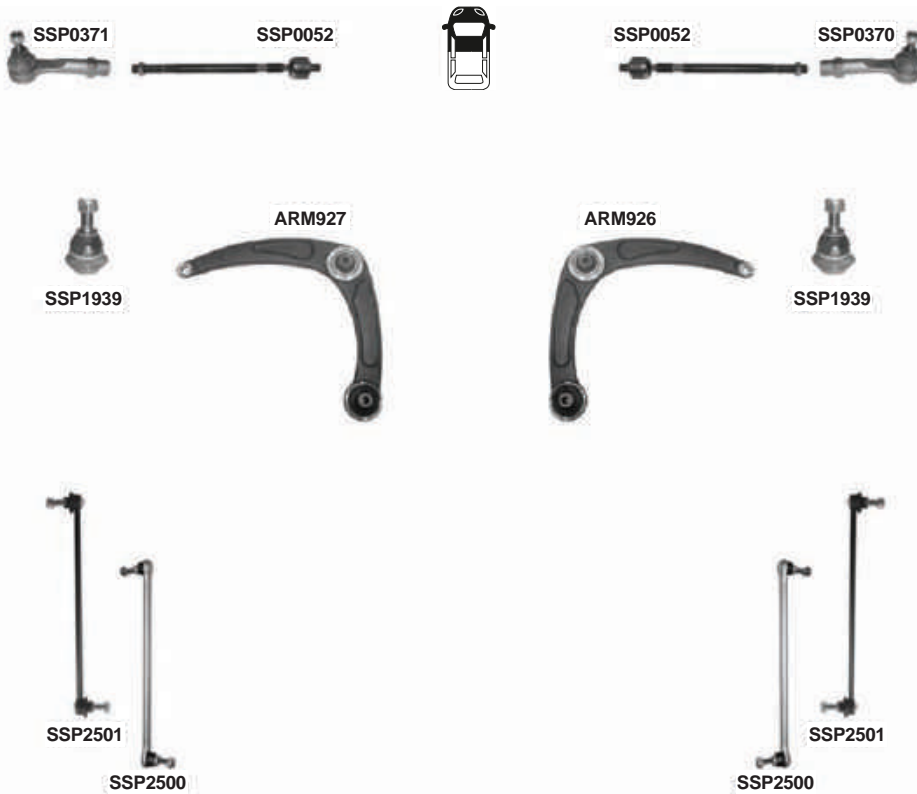
**CITROEN C4 GRAND PICASSO UA**  02/2007-01/2013

	PART NO.	DESCRIPTION	NOTES	O.E.
ARM926	301181392600	Suspension Control Arm - Front Right Lower		3521.G8; 3521.P3; 3521.K3
ARM927	301181392700	Suspension Control Arm - Front Left		3520.K8; 3520.S2; 3520.P3
SSP0052	301191600520	Steering Tie Rod - Front	M16x1,5 - L=308.5mm	3812.E9
SSP0370	301191603700	Steering Tie Rod End - Front Right	M16x1,5	3817.72
SSP0371	301191603710	Steering Tie Rod End - Front Left	M16x1,5	3817.71
SSP1939	301191619390	Suspension Ball Joint - Front Lower		3640.53; 3640.68; 3640.60
SSP2500	301191625000	Suspension Stabilizer Bar Link - Front	Alm.Design L=334mm	5087.57
SSP2501	301191625010	Suspension Stabilizer Bar Link - Front	Metal Design L=334mm	5087.57
SSP2502	301191625020	Suspension Stabilizer Bar Link - Front		5087.57

CITROEN C4 GRAND PICASSO II 

2014-



PART NO.	DESCRIPTION	NOTES	O.E.
SSP0053 301191600530	Steering Tie Rod - Front		1610817680

**CITROEN C4 PICASSO II**

2013-

**SSP1818****SSP1818**

	PART NO.	DESCRIPTION	NOTES	O.E.
ARM932	301181393200	Suspension Control Arm and Ball Joint Assembly - Front Right	Aluminium	9800596580
ARM933	301181393300	Suspension Control Arm and Ball Joint Assembly - Front Left	Aluminium	9800596680
SSP0053	301191600530	Steering Tie Rod - Front		1610817680
SSP0627	301191606270	Steering Tie Rod End - Front Right	M14X1,5	1610817880
SSP0628	301191606280	Steering Tie Rod End - Front Left	M14X1,5	1610817780
SSP1818	301191618180	Suspension Ball Joint - Front Lower	fit aluminium control arm	9803434080
SSP2509	301191625090	Suspension Stabilizer Bar Link - Front	L=335mm	5087.50; 96347856; 9804947480; 5087.64; 5087.62



CITROEN C5 DC



03/2001-08/2004

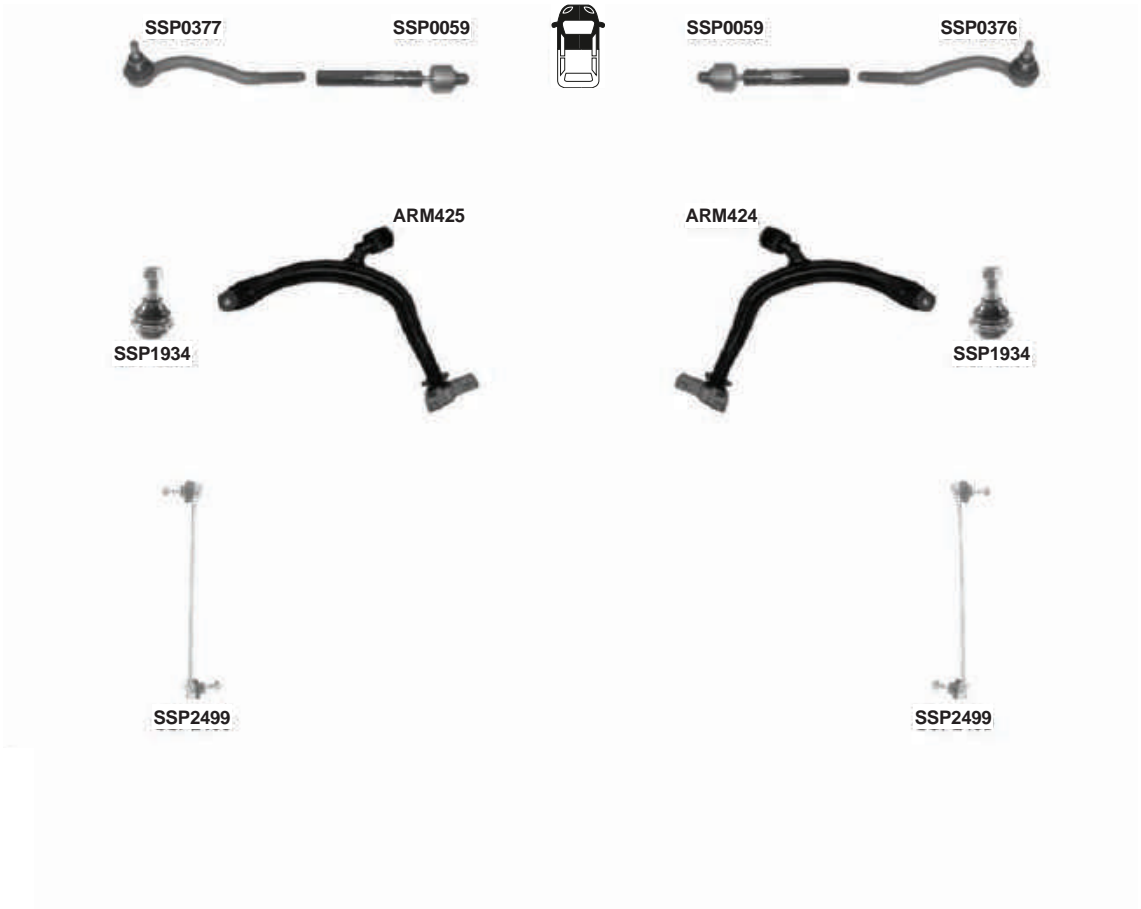

PART NO.	DESCRIPTION	NOTES	O.E.
ARM424	Suspension Control Arm - Front Right Lower		3521.G3; 3521.K0
ARM425	Suspension Control Arm - Front Left Lower		3520.K3; 3520.P0
SSP0059	Steering Tie Rod - Front	M16x1,5 - L=177mm	3812.C8
SSP0376	Steering Tie Rod End - Front Right	M16x1,5Rht	3817.54
SSP0377	Steering Tie Rod End - Front Left	M16x1,5Rht	3817.53
SSP1934	Suspension Ball Joint - Front Lower		3640.28; 95028039; 96233739; 3640.71; 3640.34
SSP2499	Suspension Stabilizer Bar Link - Front	L=320mm	5087.43; 96177836; 96324274; 5087.60; 5087.48



CITROEN C5 RC



04/2004-01/2008

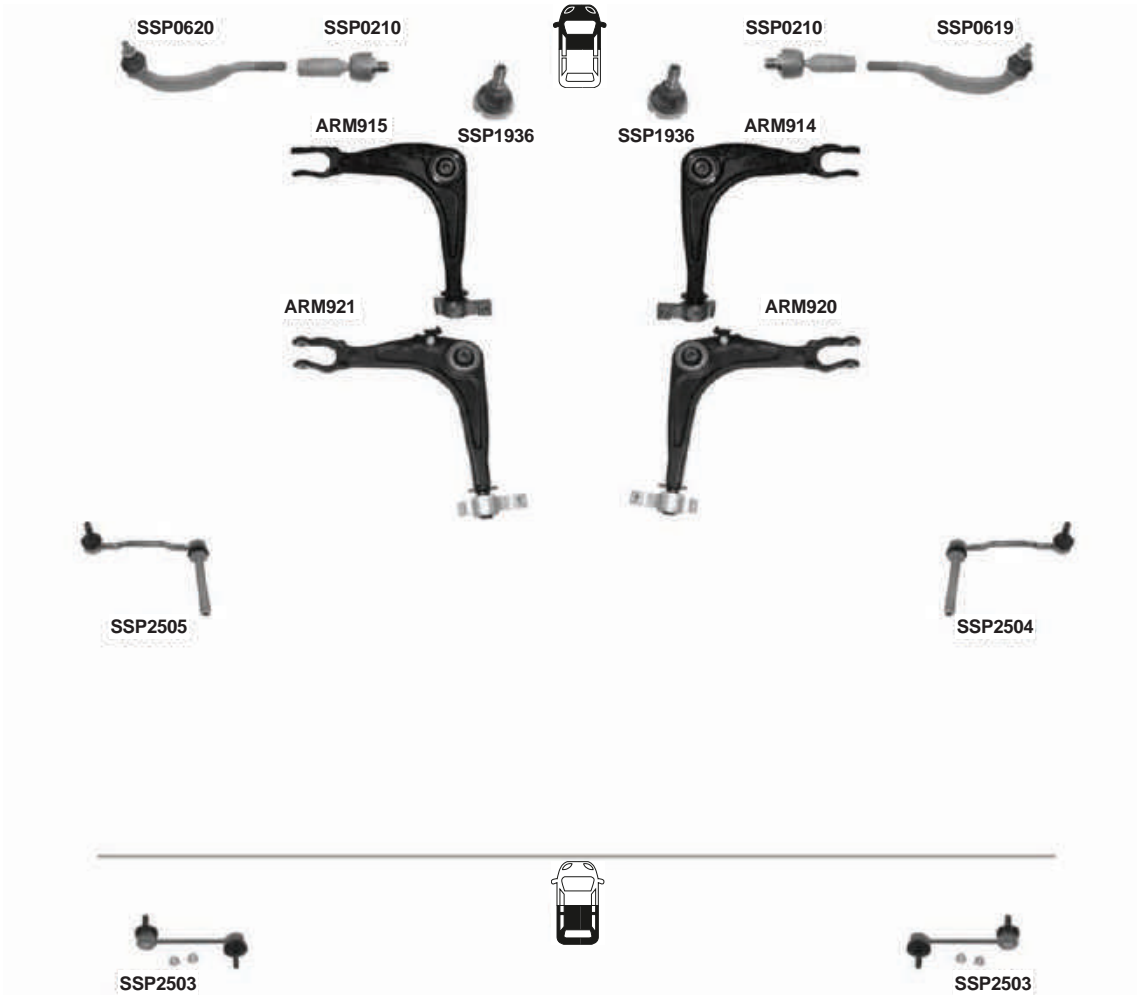

PART NO.	DESCRIPTION	NOTES	O.E.
ARM914	301181391400 Suspension Control Arm - Front Right Lower		3521.J6; 3521.L2
ARM915	301181391500 Suspension Control Arm - Front Left Lower		3520.N6; 3520.Q1
ARM920	301181392000 Suspension Control Arm - Front Right Lower	(With bracket) Variable Suspension	3521.J7
ARM921	301181392100 Suspension Control Arm - Front Left Lower	(With bracket) Variable Suspension	3520.N7
SSP0210	301191602100 Steering Tie Rod - Front	M14x1,5 - L=103mm	3817.B3; 3817.E3
SSP0619	301191606190 Steering Tie Rod End - Front Right Outer	M14x1,5Rht D=Ø10mm	3817.57
SSP0620	301191606200 Steering Tie Rod End - Front Left Outer	M14x1,5Rht D=Ø10mm	3817.58
SSP1936	301191619360 Suspension Ball Joint - Front Upper		3640.57; 3640.74
SSP2503	301191625030 Suspension Stabilizer Bar Link - Rear	L=141 mm	5178.46; 9651565180; 5178.52
SSP2504	301191625040 Suspension Stabilizer Bar Link - Front Right	L=200mm	5087.53
SSP2505	301191625050 Suspension Stabilizer Bar Link - Front Left	L=200mm	5087.52



CITROEN C5 RD



02/2008-

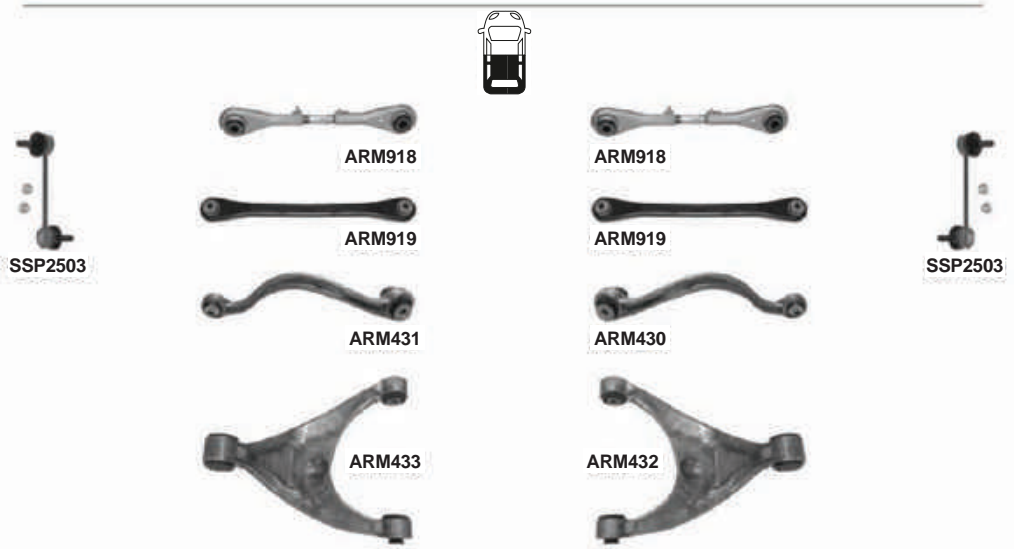
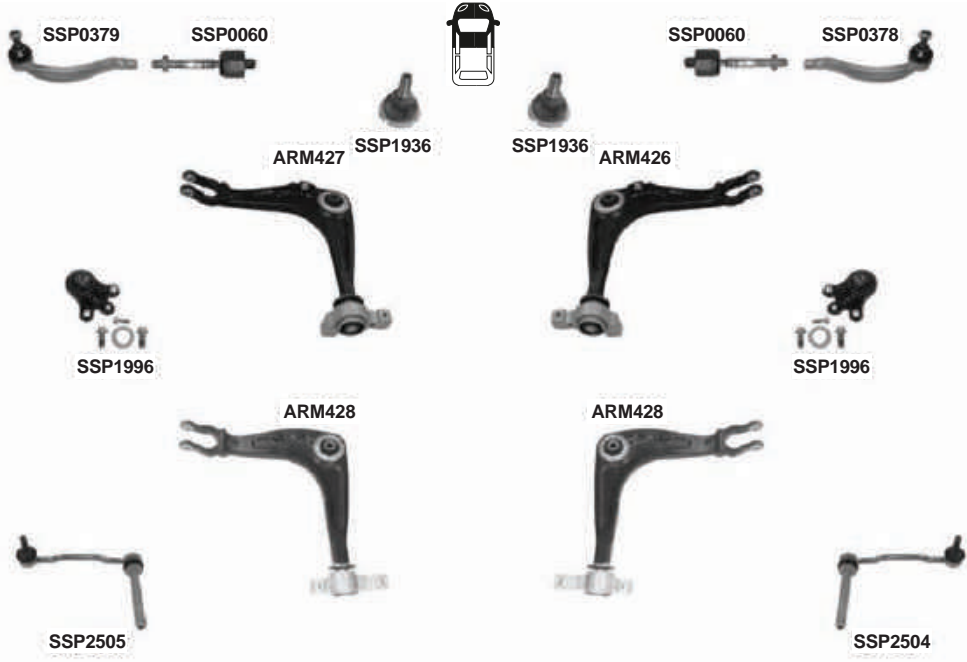

**CITROEN C5 RD**

2008-2015

	PART NO.	DESCRIPTION	NOTES	O.E.
ARM426	301181342600	Suspension Control Arm - Front Right Lower	Ch:11984->	3521.S5
ARM427	301181342700	Suspension Control Arm - Front Left Lower	Ch:11984->	3520.W2
ARM428	301181342800	Suspension Control Arm and Ball Joint Assembly - Front Right		3521.T7
ARM429	301181342900	Suspension Control Arm - Front Left		3520.X6
ARM430	301181343000	Lateral Arm - Rear Right Lower	Aluminium	5175.CE
ARM431	301181343100	Lateral Arm - Rear Left		5175.CC
ARM432	301181343200	Lateral Arm - Rear Right Upper	Federal	5175CP; 5175CH
ARM433	301181343300	Lateral Arm - Rear Left Upper	Federal	5175CN; 5175CG
ARM918	301181391800	Lateral Arm - Rear Forward		5178.47
ARM919	301181391900	Lateral Arm - Rear Upper Rearward		5175.CF
SSP0060	301191600600	Steering Tie Rod - Front	M14X1,5 - L=129mm	3812.F3
SSP0378	301191603780	Steering Tie Rod End - Front Right	M14x1,5	3817.81
SSP0379	301191603790	Steering Tie Rod End - Front Left	M14x1,5	3817.80
SSP1936	301191619360	Suspension Ball Joint - Front Upper		3640.57; 3640.74
SSP1996	301191619960	Suspension Ball Joint Kit - Front Lower		3640.58; 3640.72
SSP2503	301191625030	Suspension Stabilizer Bar Link - Rear	L=141 mm	5178.46; 9651565180; 5178.52
SSP2504	301191625040	Suspension Stabilizer Bar Link - Front Right	L=200mm	5087.53
SSP2505	301191625050	Suspension Stabilizer Bar Link - Front Left	L=200mm	5087.52



CITROEN C6 TD

09/2005-09/2012

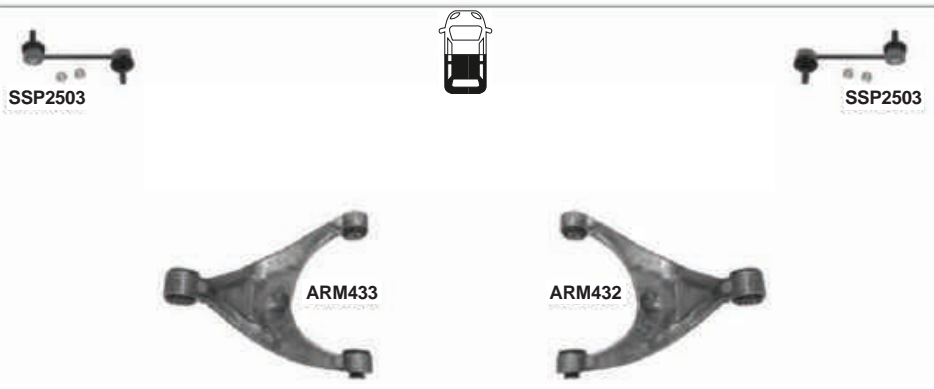
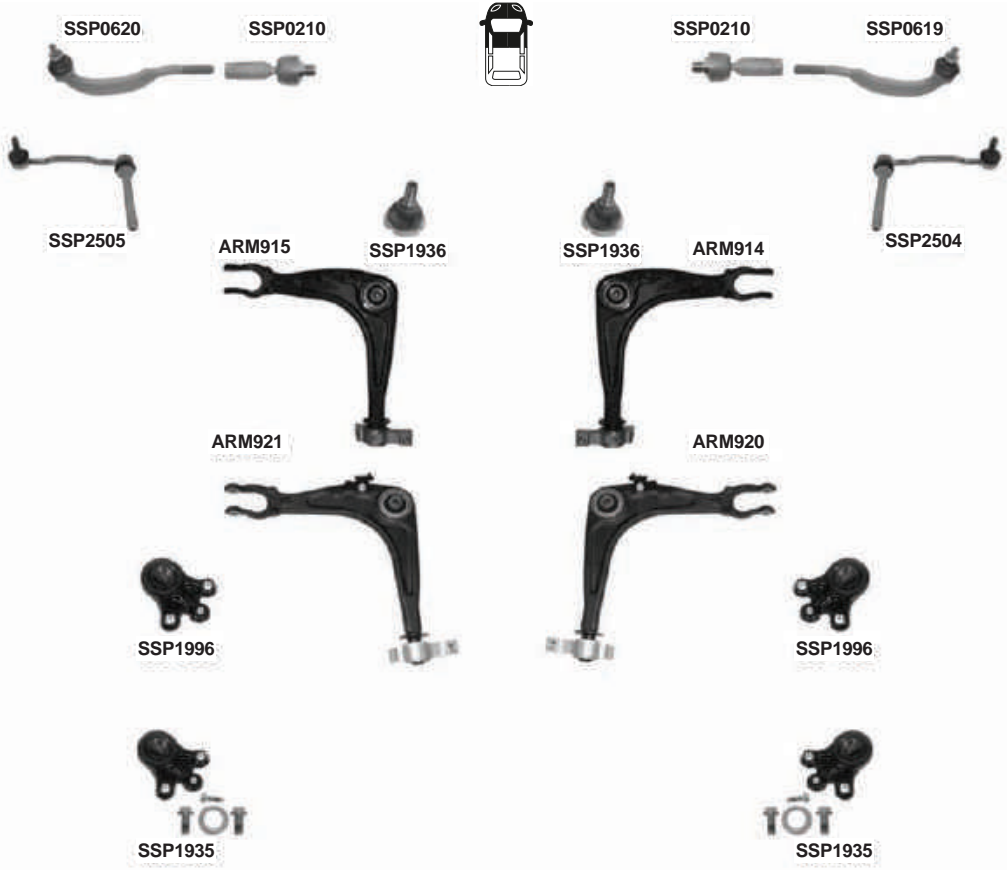

**CITROEN C6 TD**

09/2005-09/2012

	PART NO.	DESCRIPTION	NOTES	O.E.
ARM432	301181343200	Lateral Arm - Rear Right Upper	Federal	5175CP; 5175CH
ARM433	301181343300	Lateral Arm - Rear Left Upper	Federal	5175CN; 5175CG
ARM914	301181391400	Suspension Control Arm - Front Right Lower		3521.J6; 3521.L2
ARM915	301181391500	Suspension Control Arm - Front Left Lower		3520.N6; 3520.Q1
ARM920	301181392000	Suspension Control Arm - Front Right Lower	(With bracket) Variable Suspension	3521.J7
ARM921	301181392100	Suspension Control Arm - Front Left Lower	(With bracket) Variable Suspension	3520.N7
SSP0210	301191602100	Steering Tie Rod - Front	M14x1,5 - L=103mm	3817.B3; 3817.E3
SSP0619	301191606190	Steering Tie Rod End - Front Right Outer	M14x1,5Rht D=Ø10mm	3817.57
SSP0620	301191606200	Steering Tie Rod End - Front Left Outer	M14x1,5Rht D=Ø10mm	3817.58
SSP1935	301191619350	Suspension Ball Joint - Front Lower		3640.58; 3640.72
SSP1936	301191619360	Suspension Ball Joint - Front Upper		3640.57; 3640.74
SSP1996	301191619960	Suspension Ball Joint Kit - Front Lower		3640.58; 3640.72
SSP2503	301191625030	Suspension Stabilizer Bar Link - Rear	L=141 mm	5178.46; 9651565180; 5178.52
SSP2504	301191625040	Suspension Stabilizer Bar Link - Front Right	L=200mm	5087.53
SSP2505	301191625050	Suspension Stabilizer Bar Link - Front Left	L=200mm	5087.52



CITROEN C8



07/2002-07/2014

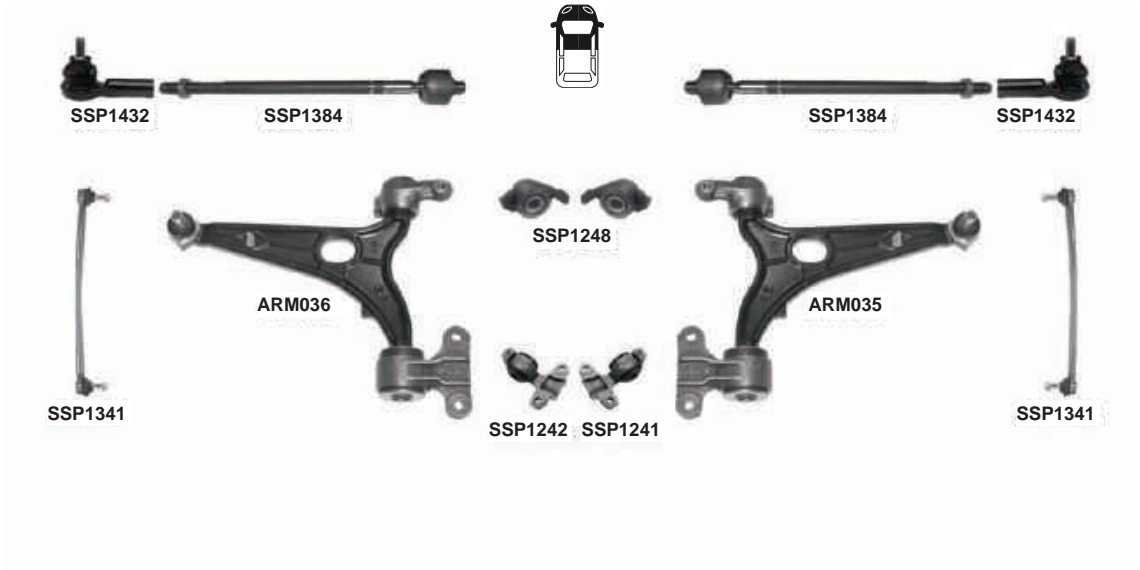

PART NO.	DESCRIPTION	NOTES	O.E.
ARM035	301181303500 Suspension Control Arm and Ball Joint Assembly - Front Right Lower		1346385080; 93501488; 3521.H1
ARM036	301181303600 Suspension Control Arm and Ball Joint Assembly - Front Left		1346384080; 93501487; 3521.H0
SSP1241	301181312410 Bush / Silent block - Track control arm - Rh	ARM035 / ARM073	
SSP1242	301181312420 Bush / Silent block - Track control arm - Lh	ARM036 / ARM074	
SSP1248	301181312480 Bush / Silent block - Track control arm	ARM023 / ARM024 / ARM035 / ARM036	1312317080
SSP1341	301181313410 Suspension Stabilizer Bar Link - Front	L=262,5mm	1331209080; 5087.51
SSP1384	301181313840 Steering Tie Rod - Front	M14x1,5 - L=308mm	3812.E2; 77362280
SSP1432	301181314320 Steering Tie Rod End - Front Outer	M14x1,5Rht - D=Ø15,45mm	4059.12; 77362279



CITROEN C-ELYSEE



11/2012-



	PART NO.	DESCRIPTION	NOTES	O.E.
ARM408	301181340800	Suspension Control Arm and Ball Joint Assembly - Front Right		9675028880
ARM409	301181340900	Suspension Control Arm and Ball Joint Assembly - Front Left		9675031880
SSP0054	301191600540	Steering Tie Rod - Front	M16X1,5 - L=230mm	1608652180
SSP0617	301191606170	Steering Tie Rod End - Front Right	M16X1,5	1608652380; 3817.68
SSP0618	301191606180	Steering Tie Rod End - Front Left	M16X1,5	1608652280; 3817.67
SSP1820	301191618200	Suspension Ball Joint - Front Lower		3640.77
SSP2497	301191624970	Suspension Stabilizer Bar Link - Front Right	L=330mm	5087.55; 5087.68
SSP2498	301191624980	Suspension Stabilizer Bar Link - Front Left	L=330mm	5087.54; 5087.69



PART NO.	DESCRIPTION	NOTES	O.E.
ARM422 301181342200	Suspension Control Arm and Ball Joint Assembly - Front Right Lower		3521.S9
ARM423 301181342300	Suspension Control Arm and Ball Joint Assembly - Front Left Lower		3520.W7
SSP0058 301191600580	Steering Tie Rod - Front	M14x1,5 - L=245mm	3812.F6
SSP0374 301191603740	Steering Tie Rod End - Front Right	M14x1,5	3817.91
SSP0375 301191603750	Steering Tie Rod End - Front Left	M14x1,5	3817.92
SSP1820 301191618200	Suspension Ball Joint - Front Lower	CI-566 / CI-567	3640.77
SSP2144 301191621440	Suspension Stabilizer Bar Link - Front	Alm.Desing	5087.71; 5087.74
SSP2145 301191621450	Suspension Stabilizer Bar Link - Front	L=335mm Metal Desing	5087.71*; 96288787*



CITROEN DS5



11/2011-

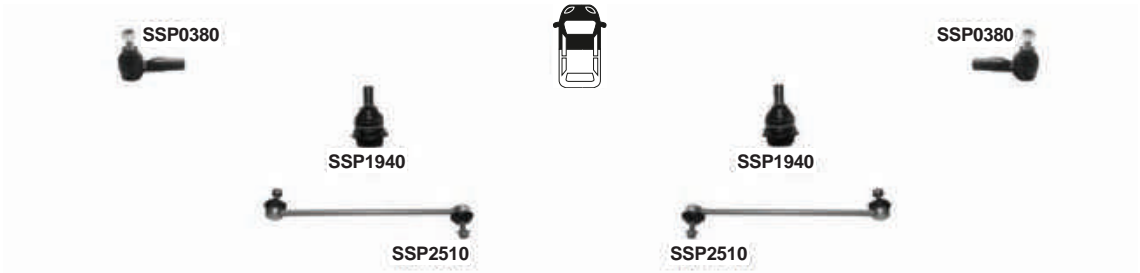

PART NO.	DESCRIPTION	NOTES	O.E.
SSP0380 301191603800	Steering Tie Rod End - Front	M14X1.5	3817.97
SSP1940 301191619400	Suspension Ball Joint - Front		3640.73
SSP2510 301191625100	Suspension Stabilizer Bar Link - Front	L=335mm	9804947480; 9809045780



	PART NO.	DESCRIPTION	NOTES	O.E.
ARM406	301181340600	Suspension Control Arm and Ball Joint Assembly - Front Right	REINFORCED TYPE BASED ON OE PART REVISION IN 2014, 27Ø	3521P4
ARM407	301181340700	Suspension Control Arm and Ball Joint Assembly - Front Right	REINFORCED TYPE BASED ON OE PART REVISION IN 2014, 27Ø	3520P4



CITROEN JUMPER I



03/1994-04/2002

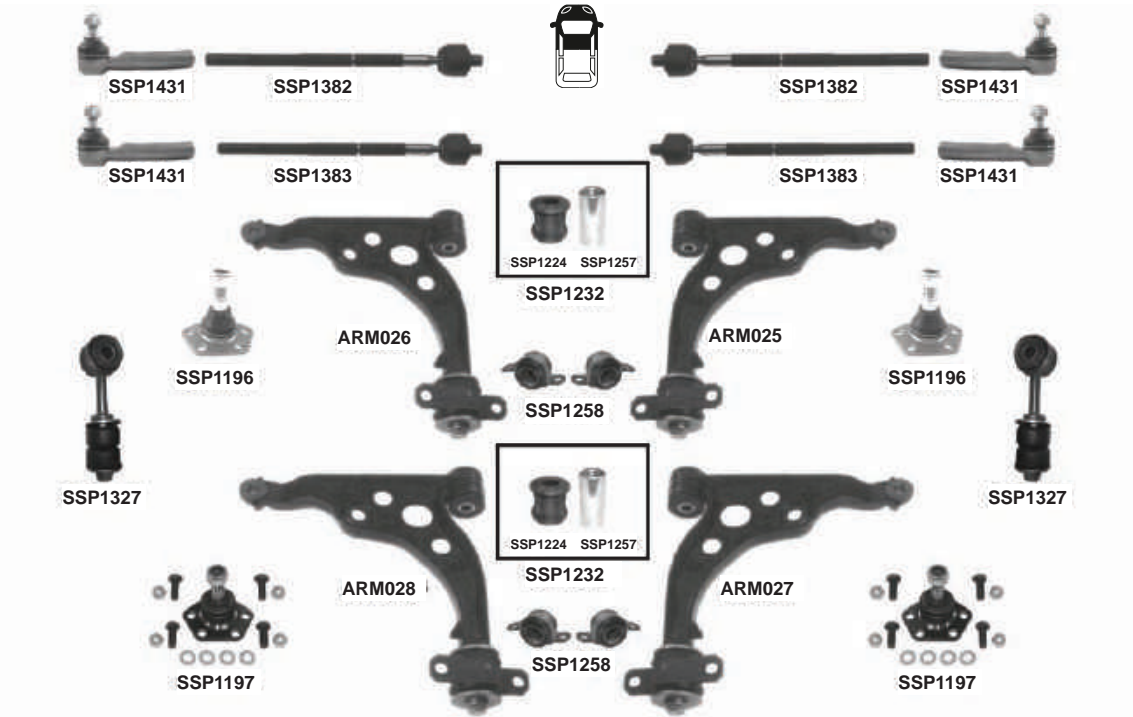

PART NO.	DESCRIPTION	NOTES	O.E.
ARM025	301181302500 Suspension Control Arm - Front Right Lower	Only:1,4Q	1308601080; 3521.65; 1317241080
ARM026	301181302600 Suspension Control Arm - Front Left Lower	Only:1,4Q	1308600080; 3520.95; 1317240080
ARM027	301181302700 Suspension Control Arm - Front Right Lower	Only:1,8Q	1308760080; 3521.66; 1317239080
ARM028	301181302800 Suspension Control Arm - Front Left Lower	Only:1,8Q	1308759080; 3520.96; 1317238080
SSP1196	301181311960 Suspension Ball Joint - Front Lower	Only : 1.4Q	1302368080; 3640.32
SSP1197	301181311970 Suspension Ball Joint - Front Lower	Only : 1,8Q	1300473080; 542410095; 3640.33
SSP1224	301181312240 Bush / Silent block - Track control arm	ARM025 / ARM026 / ARM027 / ARM028	
SSP1232	301181312320 Bush / Silent block kit - Track control arm	ARM025 / ARM026 / ARM027 / ARM028	
SSP1257	301181312570 Bush / Silent block - Track control arm	ARM025 / ARM026 / ARM027 / ARM028	1300507080
SSP1258	301181312580 Bush / Silent block - Track control arm	ARM025 / ARM026 / ARM027 / ARM028	"1308694080, 1338373080, 3523.94"
SSP1327	301181313270 Suspension Stabilizer Bar Link - Front	L=134mm	1300716080; 5087.37
SSP1382	301181313820 Steering Tie Rod - Front	Manual Steering M16x1,5Rht - L=318mm	1471654080; 9945836; 9945385; 4018.A4
SSP1383	301181313830 Steering Tie Rod - Front	Power Steering M16x1,5Rht - L=318mm	4006.24; 9945836
SSP1431	301181314310 Steering Tie Rod End - Front	M16x1,5Rht	1306716080; 4018.A3; 1471655080



CITROEN JUMPER II



05/2002-05/2006

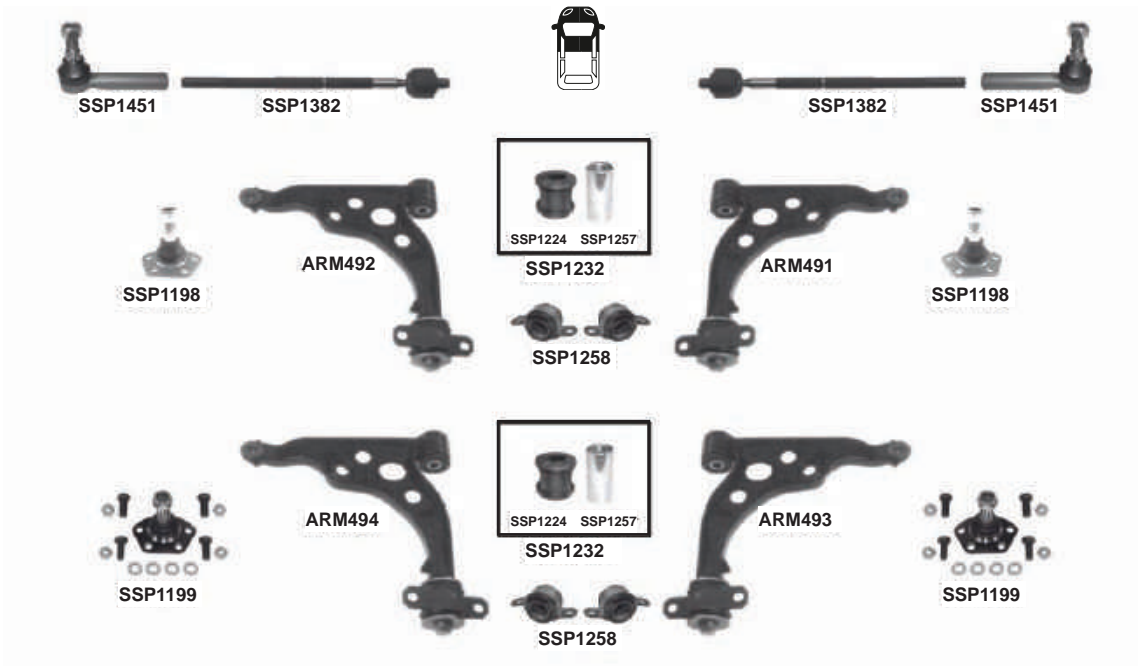

PART NO.	DESCRIPTION	NOTES	O.E.
ARM491	301181349100 Suspension Control Arm - Front Right Lower	Only:1,4Q	1331940080; 3521.J3; 3521.H2
ARM492	301181349200 Suspension Control Arm - Front Left Lower	Only:1,4Q	1331938080; 3520.N3; 3520.L0
ARM493	301181349300 Suspension Control Arm - Front Right Lower	Only:1,8Q	1339460080; 3521.J4; 3521.H3
ARM494	301181349400 Suspension Control Arm - Front Left Lower	Only:1,8Q	1331937080; 3520.N4; 3520.L1
SSP1198	301181311980 Suspension Ball Joint - Front Lower	Only : 1.4Q	1302368080; 3640.55; 1331640080
SSP1199	301181311990 Suspension Ball Joint - Front Lower	Only : 1,8Q	1300473080; 3640.54; 1331641080
SSP1224	301181312240 Bush / Silent block - Track control arm	ARM025 / ARM026 / ARM027 / ARM028	
SSP1232	301181312320 Bush / Silent block kit - Track control arm	ARM025 / ARM026 / ARM027 / ARM028	
SSP1257	301181312570 Bush / Silent block - Track control arm	ARM025 / ARM026 / ARM027 / ARM028	1300507080
SSP1258	301181312580 Bush / Silent block - Track control arm	ARM025 / ARM026 / ARM027 / ARM028	"1308694080, 1338373080, 3523.94"
SSP1382	301181313820 Steering Tie Rod - Front	Manual Steering M16x1,5Rht - L=318mm	1471654080; 9945836; 9945385; 4018.A4
SSP1451	301181314510 Steering Tie Rod End - Front	M16x1,5Rht	4018.E0; 77362278



CITROEN JUMPER III



06/2006-

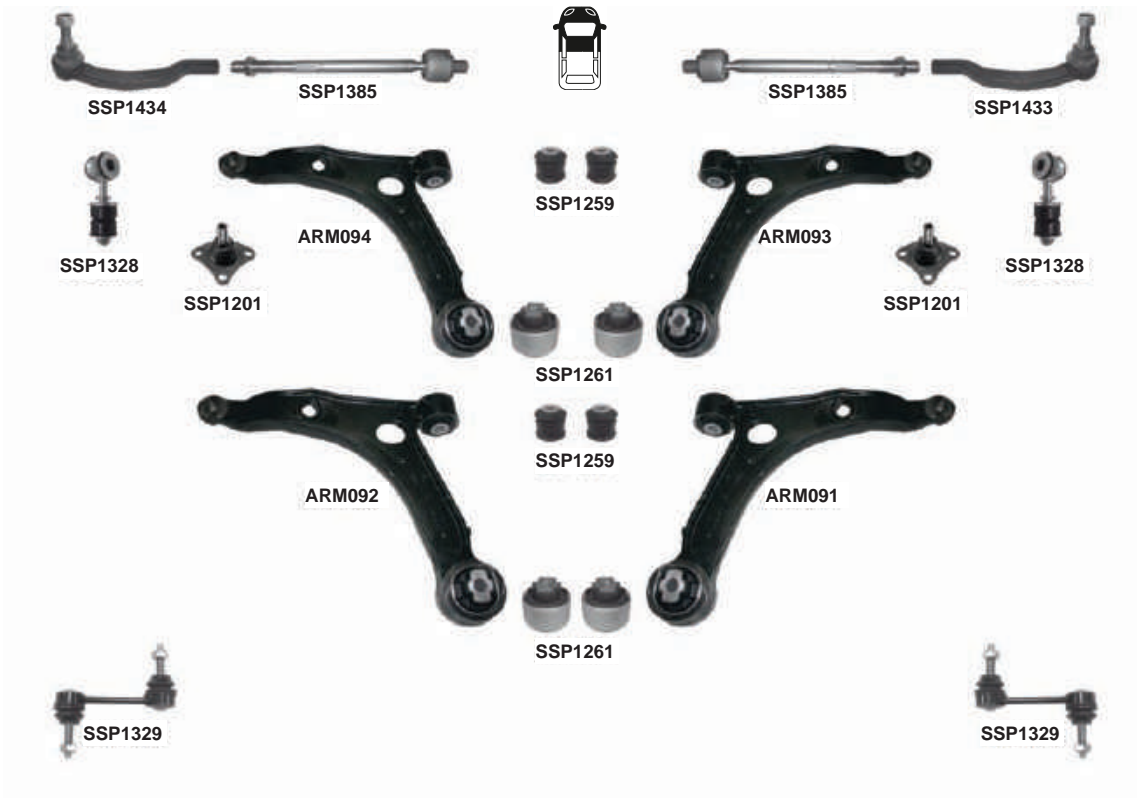

PART NO.	DESCRIPTION	NOTES	O.E.
ARM091	301181309100 Suspension Control Arm - Front Right Lower	Only :1.1Q-1.5Q-1.7Q	1352225080; 3521.P1
ARM092	301181309200 Suspension Control Arm - Front Left	Only :1.1Q-1.5Q-1.7Q	1352227080; 3520.S0
ARM093	301181309300 Suspension Control Arm - Front Right Lower	Only :1.7H - 2.0Q	1352226080; 3521.P2
ARM094	301181309400 Suspension Control Arm - Front Left	Only :1.7H - 2.0Q	1352228080; 3520.S1
SSP1201	301181312010 Suspension Ball Joint - Front Lower		3640.67; 9351837; 50705629; 3640.76
SSP1259	301181312590 Bush / Silent block - Track control arm	ARM091 / ARM092 / ARM093 / ARM094	
SSP1261	301181312610 Bush / Silent block - Track control arm	ARM091 / ARM092 / ARM093 / ARM094	
SSP1328	301181313280 Suspension Stabilizer Bar Link - Front	L=112mm	1357572080*
SSP1329	301181313290 Suspension Stabilizer Bar Link - Rear	L=100mm	1355440080; 5170.F5; 1355449080
SSP1385	301181313850 Steering Tie Rod - Front	M16x1,5 - L=260 mm	1341 021 080; 4001.E4; 4001.E5; 16 077 445 80; 1359 226 080; 1345 854 080
SSP1433	301181314330 Steering Tie Rod End - Front Right	M16x1,5	3817.70; 77364009
SSP1434	301181314340 Steering Tie Rod End - Front Left	M16x1,5	3817.77; 77364253



CITROEN JUMPY EVANSION



1995-2003



PART NO.	DESCRIPTION	NOTES	O.E.
ARM023 301181302300	Suspension Control Arm and Ball Joint Assembly - Front Right Lower		1313084080; 3521.K4; 3521.83; 3521.C9; 1322664080; 1317390080; 1316736080
ARM024 301181302400	Suspension Control Arm and Ball Joint Assembly - Front Left		1313083080; 3520.G9; 3520.94; 3520.C3; 1322663080; 1317389080; 1316735080
SSP1248 301181312480	Bush / Silent block - Track control arm	ARM023 / ARM024 / ARM035 / ARM036	1312317080
SSP1249 301181312490	Bush / Silent block - Track control arm - Lh	ARM024	1305551080
SSP1254 301181312540	Bush / Silent block - Track control arm - Rh	ARM023	1305552080
SSP1326 301181313260	Suspension Stabilizer Bar Link - Front	L=122mm	1308664080; 5087.35; 1317425080
SSP1381 301181313810	Steering Tie Rod - Front Inner	M14x1,5 - L=309mm	3812.A4; 9566950880
SSP1429 301181314290	Steering Tie Rod End - Front Outer	M14x1,5Rht - D=Ø14,4mm	1306003080; 9404059580; 4059.09



CITROEN JUMPY II



04/2004-12/2006

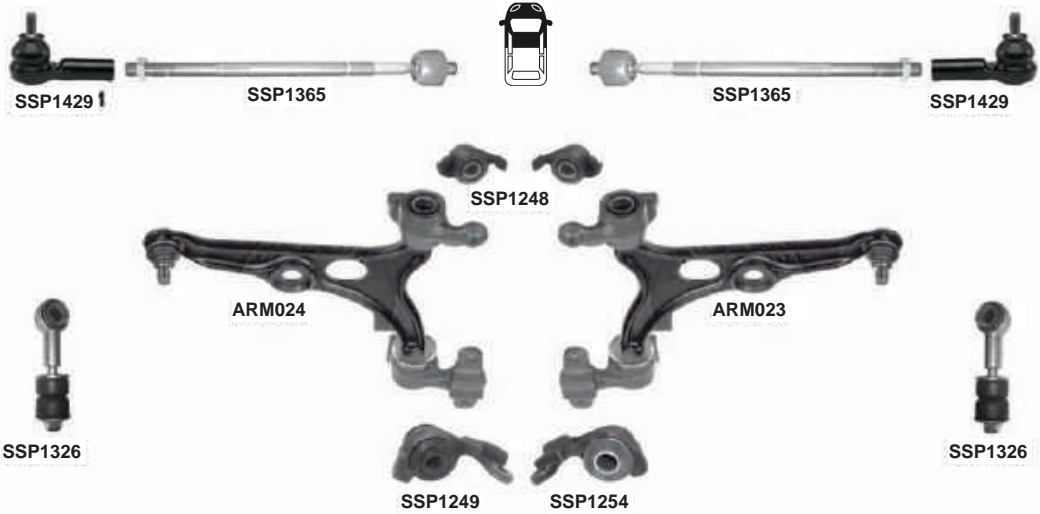

PART NO.	DESCRIPTION	NOTES	O.E.
ARM023 301181302300	Suspension Control Arm and Ball Joint Assembly - Front Right Lower		1313084080; 3521.K4; 3521.83; 3521.C9; 1322664080; 1317390080; 1316736080
ARM024 301181302400	Suspension Control Arm and Ball Joint Assembly - Front Left		1313083080; 3520.G9; 3520.94; 3520.C3; 1322663080; 1317389080; 1316735080
SSP1248 301181312480	Bush / Silent block - Track control arm	ARM023 / ARM024 / ARM035 / ARM036	1312317080
SSP1249 301181312490	Bush / Silent block - Track control arm - Lh	ARM024	1305551080
SSP1254 301181312540	Bush / Silent block - Track control arm - Rh	ARM023	1305552080
SSP1326 301181313260	Suspension Stabilizer Bar Link - Front	L=122mm	1308664080; 5087.35; 1317425080
SSP1365 301181313650	Steering Tie Rod - Front Inner	M14x1,5Rht - L=309.3mm	9947713
SSP1429 301181314290	Steering Tie Rod End - Front Outer	M14x1,5Rht - D=Ø14,4mm	1306003080; 9404059580; 4059.09



CITROEN JUMPY III



01/2007-

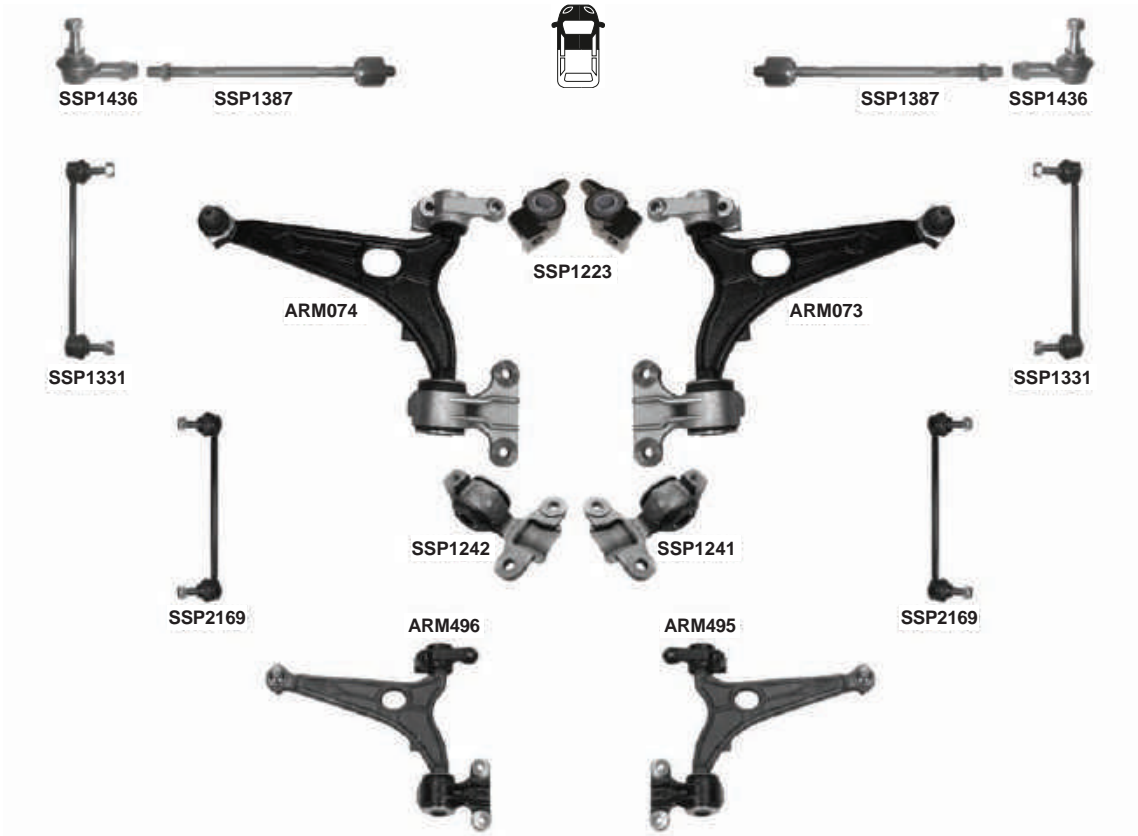

PART NO.	DESCRIPTION	NOTES	O.E.
ARM073	301181307300 Suspension Control Arm and Ball Joint Assembly - Front Right		1497407080; 50711395; 3521.N9
ARM074	301181307400 Suspension Control Arm and Ball Joint Assembly - Front Left		1497408080; 50711394; 3520.R8
ARM495	301181349500 Suspension Control Arm and Ball Joint Assembly - Front Right		1497407080*
ARM496	301181349600 Suspension Control Arm and Ball Joint Assembly - Front Left		1497408080*
SSP1223	301181312230 Bush / Silent block - Track control arm	ARM073 / ARM074	
SSP1241	301181312410 Bush / Silent block - Track control arm - Rh	ARM035 / ARM073	
SSP1242	301181312420 Bush / Silent block - Track control arm - Lh	ARM036 / ARM074	
SSP1331	301181313310 Suspension Stabilizer Bar Link - Front	L=263mm	1400099680; 5087.56
SSP1387	301181313870 Steering Tie Rod - Front	M14x1,5 - L=304.7mm	1401381380; 3812.F0; 1497550080
SSP1436	301181314360 Steering Tie Rod End - Front	M14x1,5	3817.73; 9403817738
SSP2169	301191621690 Suspension Stabilizer Bar Link - Front	(Clip-on patented design) L=263mm	1400099680*



CITROEN NEMO



2008-

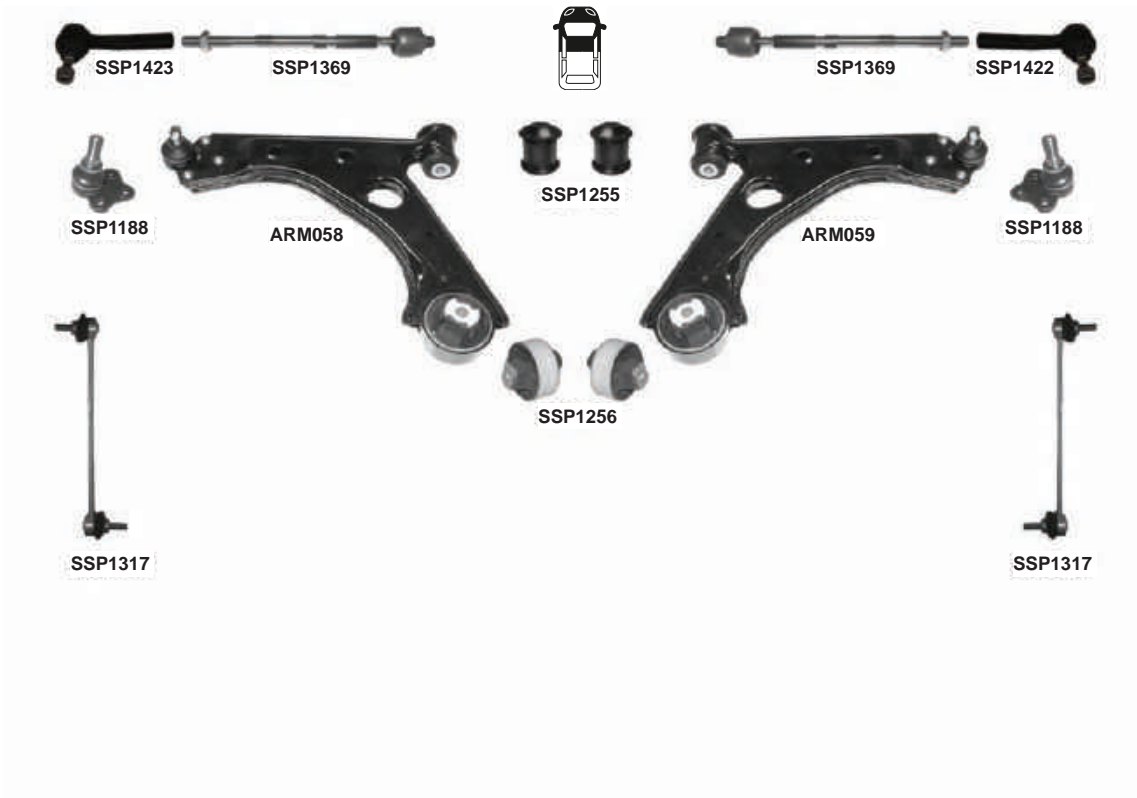

	PART NO.	DESCRIPTION	NOTES	O.E.
ARM058	301181305800	Suspension Control Arm and Ball Joint Assembly - Front Left Lower		3520.W3; 55703629; 51895367; 51783057; 3520.Y4
ARM059	301181305900	Suspension Control Arm and Ball Joint Assembly - Front Right Lower		3521.S6; 55703627; 51895366; 51783056; 3521V5
SSP1188	301181311880	Suspension Ball Joint - Front		3520.87; 93190907; 51783057; 51783056; 3520.W3
SSP1255	301181312550	Bush / Silent block - Track control arm	ARM058 / ARM059 / ARM115 / ARM116	352380, 55703232
SSP1256	301181312560	Bush / Silent block - Track control arm - Rear	ARM058 / ARM059	55700751
SSP1317	301181313170	Suspension Stabilizer Bar Link - Front	L=290mm	5080.70; 51815479; 5087.65
SSP1369	301181313690	Steering Tie Rod - Front	M14X1,5 - L=274mm	55172401
SSP1422	301181314220	Steering Tie Rod End - Front Right	M14x1,5	3817.87; 77364569
SSP1423	301181314230	Steering Tie Rod End - Front Left	M14x1,5	3817.86; 77364568
SSP2167	301191621670	Suspension Stabilizer Bar Link - Front	(Clip-on patented design) L=290mm	5087.65; 51815479; 5087.70

CITROEN SAXO



1996-2003

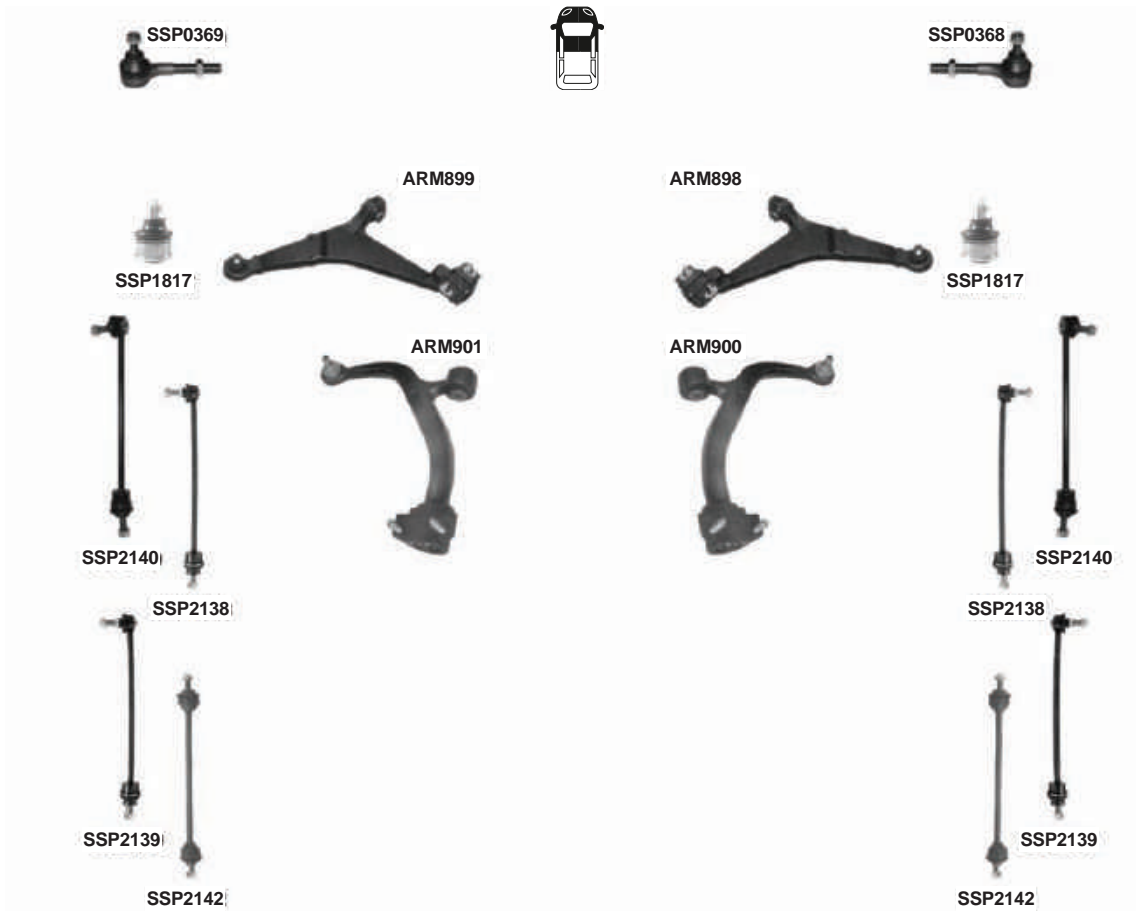

PART NO.	DESCRIPTION	NOTES	O.E.
ARM898	301181389800 Suspension Control Arm and Ball Joint Assembly - Front Right Lower	Ball Joint D=Ø16mm	3520.79; 95658979
ARM899	301181389900 Suspension Control Arm and Ball Joint Assembly - Front Left Lower	Ball Joint D=Ø16mm	3520.78; 95658978
ARM900	301181390000 Suspension Control Arm and Ball Joint Assembly - Front Right Lower	Only: VTS	3520.81; 3520.93
ARM901	301181390100 Suspension Control Arm and Ball Joint Assembly - Front Left	Only: VTS	3520.80; 3520.92
SSP0368	301191603680 Steering Tie Rod End - Front Right	M14x1,5Rht	3817.16; 9471007565; 9471000665; 3817.42; 3817.31
SSP0369	301191603690 Steering Tie Rod End - Front Left	M14x1,5Rht	3817.14; 9471000565; 9471007465; 9458084180; 3817.41; 3817.30
SSP1817	301191618170 Suspension Ball Joint - Front Lower	D=Ø16mm	3640.36; 96093233
SSP2138	301191621380 Suspension Stabilizer Bar Link - Front	L=322,5mm M10 Thread	96145457
SSP2139	301191621390 Suspension Stabilizer Bar Link - Front	L=322,5mm M12 Thread	5087.40; 96177836; 93802209
SSP2140	301191621400 Suspension Stabilizer Bar Link - Front	(Clip-on patented design) L=322,5mm M12 Thread	500310933; 96145457; 5087.40
SSP2142	301191621420 Suspension Stabilizer Bar Link - Front	Only : VTS L=300mm	5087.33; 96147514

**CITROEN VISA C15**

1982-1997



PART NO.	DESCRIPTION	NOTES	O.E.
SSP0206 301191602060	Steering Tie Rod - Front Inner	M14x1,5 - L=314mm	3812.25; 96136394; 3812.95
SSP0612 301191606120	Steering Tie Rod End - Front	M14x1,5Rht	3817.10; 95493208; 9471000965; 9471003465; 3817.18; 3817.50

CITROEN XANTIA BREAK



1993-2003

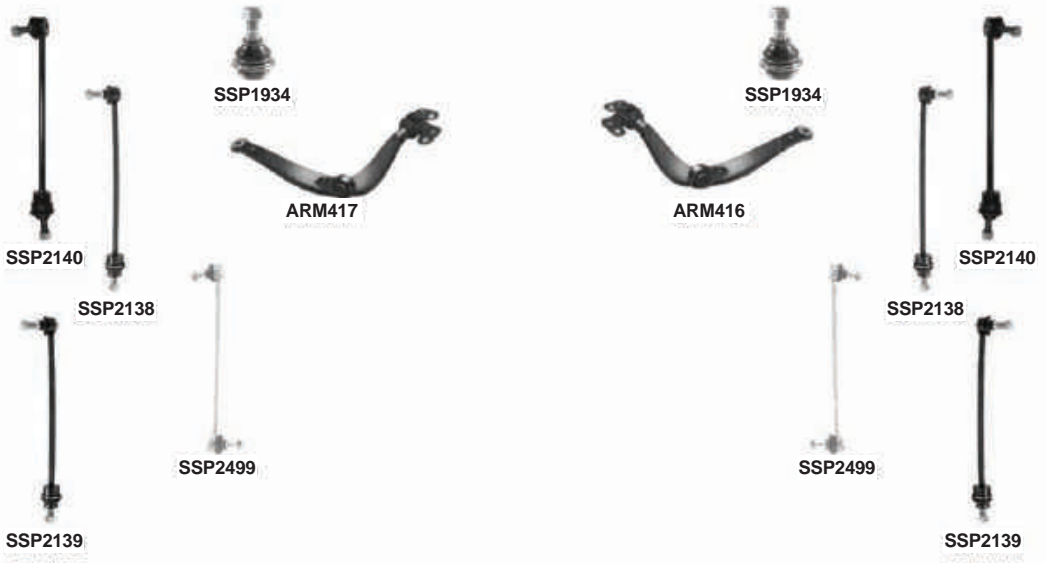

PART NO.	DESCRIPTION	NOTES	O.E.
ARM416	301181341600 Suspension Control Arm - Front Right Lower		3521.81
ARM417	301181341700 Suspension Control Arm - Front Left		3520.C1
SSP0049	301191600490 Steering Tie Rod - Front	M14x1,5 - L=312 mm	3812.95*
SSP0206	301191602060 Steering Tie Rod - Front Inner	M14x1,5 - L=314mm	3812.25; 96136394; 3812.95
SSP0368	301191603680 Steering Tie Rod End - Front Right	M14x1,5Rht	3817.16; 9471007565; 9471000665; 3817.42; 3817.31
SSP0369	301191603690 Steering Tie Rod End - Front Left	M14x1,5Rht	3817.14; 9471000565; 9471007465; 9458084180; 3817.41; 3817.30
SSP1934	301191619340 Suspension Ball Joint - Front Lower		3640.28; 95028039; 96233739; 3640.71; 3640.34
SSP2138	301191621380 Suspension Stabilizer Bar Link - Front	L=322,5mm M10 Thread	96145457
SSP2139	301191621390 Suspension Stabilizer Bar Link - Front	L=322,5mm M12 Thread	5087.40; 96177836; 93802209
SSP2140	301191621400 Suspension Stabilizer Bar Link - Front	(Clip-on patented design) L=322,5mm M12 Thread	500310933; 96145457; 5087.40
SSP2499	301191624990 Suspension Stabilizer Bar Link - Front	Only: Xantia L=320mm	5087.43; 96177836; 96324274; 5087.60; 5087.48



CITROEN XM BREAK



1994-2000

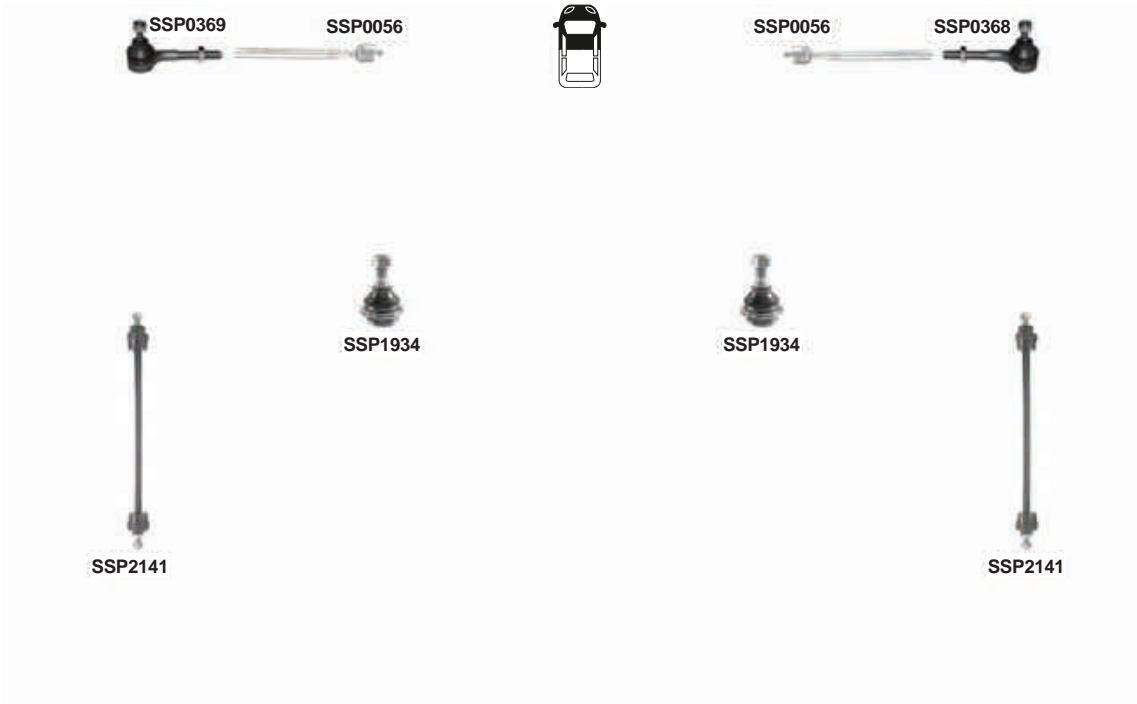

PART NO.	DESCRIPTION	NOTES	O.E.
SSP0056 301191600560	Steering Tie Rod - Front	M14x1,5Rht - L=295mm	3812.99; 96032460
SSP0368 301191603680	Steering Tie Rod End - Front Right	M14x1,5Rht	3817.16; 9471007565; 9471000665; 3817.42; 3817.31
SSP0369 301191603690	Steering Tie Rod End - Front Left	M14x1,5Rht	3817.14; 9471000565; 9471007465; 9458084180; 3817.41; 3817.30
SSP1934 301191619340	Suspension Ball Joint - Front Lower		3640.28; 95028039; 96233739; 3640.71; 3640.34
SSP2141 301191621410	Suspension Stabilizer Bar Link - Front	L=346mm	5087.30; 96080894; 5087.41



	PART NO.	DESCRIPTION	NOTES	O.E.
ARM410	301181341000	Suspension Control Arm and Ball Joint Assembly - Front Right Lower	Manual steering Ch.->7972 Ball Joint D=Ø 16mm	3521.A6; 95658884
ARM411	301181341100	Suspension Control Arm and Ball Joint Assembly - Front Left Lower	Manual steering Ch.->7972 Ball Joint D=Ø 16mm	3520.A3; 95658885
ARM412	301181341200	Suspension Control Arm and Ball Joint Assembly - Front Right Lower	Ch.->7972 Ball Joint Power D=Ø16mm	3521.C4; 95668511; 95658883
ARM413	301181341300	Suspension Control Arm and Ball Joint Assembly - Front Left Lower	Ch.->7972 Ball Joint Power D=Ø16mm	3520.A2; 95658882; 3520.F5
ARM924	301181392400	Suspension Control Arm and Ball Joint Assembly - Front Right Lower	Power steering Ch.No:7973-> Ball Joint D=Ø18mm	3521.69; 3521.E5
ARM925	301181392500	Suspension Control Arm and Ball Joint Assembly - Front Left Lower	Power steering Ch.No:7973-> Ball Joint D=Ø18mm	3520.H3; 3520.H5
SSP0050	301191600500	Steering Tie Rod - Front	M14x1,5Rht - L=335.5mm	3812.C0; 96048214; 3812.E4
SSP0612	301191606120	Steering Tie Rod End - Front	M14x1,5Rht	3817.10; 95493208; 9471000965; 9471003465; 3817.18; 3817.50
SSP1815	301191618150	Suspension Ball Joint - Front Lower	Ch.No-> 7972 Manual Steering D=Ø 16mm	3640.38; 9613696; 96035445; 3640.42
SSP1816	301191618160	Suspension Ball Joint - Front Lower	Ch.No-> 7972 Power Steering D=Ø 16mm	3640.39; 96025445; 3640.43
SSP1938	301191619380	Suspension Ball Joint - Front	Ch.No:7973-> Power Steering D=Ø18mm	3640.50; 96087507; 3640.51
SSP2137	301191621370	Suspension Stabilizer Bar Link - Front	Metal L=300mm	5087.34; 5087.61; 5087.46; 5087.39
SSP2506	301191625060	Suspension Stabilizer Bar Link - Front	Plastic Type L=300mm	5087.42; 96152213

**CITROEN XSARA PICASSO**

12/1999-2012

**ARM415****ARM414**

	PART NO.	DESCRIPTION	NOTES	O.E.
ARM414	301181341400	Suspension Control Arm and Ball Joint Assembly - Front Right Lower		3521.F3; 3521.R4; 3521.L4
ARM415	301181341500	Suspension Control Arm and Ball Joint Assembly - Front Left		3520.Q4; 3520.Q3; 3520.J3
SSP0055	301191600550	Steering Tie Rod - Front	M14X1,5	3812.C6; 3812.E4
SSP0612	301191606120	Steering Tie Rod End - Front	M14x1,5Rht	3817.10; 95493208; 9471000965; 9471003465; 3817.18; 3817.50
SSP2137	301191621370	Suspension Stabilizer Bar Link - Front	Metal L=300mm	5087.34; 5087.61; 5087.46; 5087.39



CITROEN zx



1991-1997



SSP0050



SSP0050

SSP0612



SSP1815



ARM411



ARM410



SSP1815



SSP1816



ARM413



ARM412



SSP1816



SSP1938



ARM925



ARM924



SSP1938



SSP2506



SSP2137



SSP2506



SSP2137



CITROEN ZX



1991-1997

	PART NO.	DESCRIPTION	NOTES	O.E.
ARM410	301181341000	Suspension Control Arm and Ball Joint Assembly - Front Right Lower	Manual steering Ch.->7972 Ball Joint D=Ø 16mm	3521.A6; 95658884
ARM411	301181341100	Suspension Control Arm and Ball Joint Assembly - Front Left Lower	Manual steering Ch.->7972 Ball Joint D=Ø 16mm	3520.A3; 95658885
ARM412	301181341200	Suspension Control Arm and Ball Joint Assembly - Front Right Lower	Ch.->7972 Ball Joint Power D=Ø16mm	3521.C4; 95668511; 95658883
ARM413	301181341300	Suspension Control Arm and Ball Joint Assembly - Front Left Lower	Ch.->7972 Ball Joint Power D=Ø16mm	3520.A2; 95658882; 3520.F5
ARM924	301181392400	Suspension Control Arm and Ball Joint Assembly - Front Right Lower	Power steering Ch.No:7973-> Ball Joint D=Ø18mm	3521.69; 3521.E5
ARM925	301181392500	Suspension Control Arm and Ball Joint Assembly - Front Left Lower	Power steering Ch.No:7973-> Ball Joint D=Ø18mm	3520.H3; 3520.H5
SSP0050	301191600500	Steering Tie Rod - Front	M14x1,5Rht - L=335.5mm	3812.C0; 96048214; 3812.E4
SSP0612	301191606120	Steering Tie Rod End - Front	M14x1,5Rht	3817.10; 95493208; 9471000965; 9471003465; 3817.18; 3817.50
SSP1815	301191618150	Suspension Ball Joint - Front Lower	Ch.No:-> 7972 Manual Steering D=Ø 16mm	3640.38; 9613696; 96035445; 3640.42
SSP1816	301191618160	Suspension Ball Joint - Front Lower	Ch.No:-> 7972 Power Steering D=Ø 16mm	3640.39; 96025445; 3640.43
SSP1938	301191619380	Suspension Ball Joint - Front	Ch.No:7973-> Power Steering D=Ø18mm	3640.50; 96087507; 3640.51
SSP2137	301191621370	Suspension Stabilizer Bar Link - Front	Metal L=300mm	5087.34; 5087.61; 5087.46; 5087.39
SSP2506	301191625060	Suspension Stabilizer Bar Link - Front	Plastic Type L=300mm	5087.42; 96152213



DACIA DOKKER



11/2012-

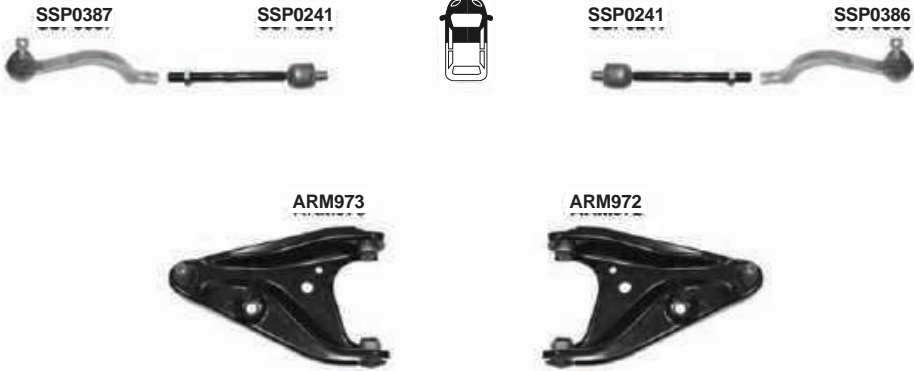

PART NO.	DESCRIPTION	NOTES	O.E.
ARM972 301181397200	Suspension Control Arm and Ball Joint Assembly - Front Right Lower		545004529R; 545007106R
ARM973 301181397300	Suspension Control Arm and Ball Joint Assembly - Front Left Lower		545010294R; 545011727R
SSP0241 301191602410	Steering Tie Rod - Front	M14X1,5 - L=193mm	485213172R
SSP0386 301191603860	Steering Tie Rod End - Front Right	M14X1,5Rht	485200410R; 6001550443; 6001547611
SSP0387 301191603870	Steering Tie Rod End - Front Left	M14X1,5Rht	485202867R; 6001550442; 6001547610



DACIA DUSTER



04/2010-

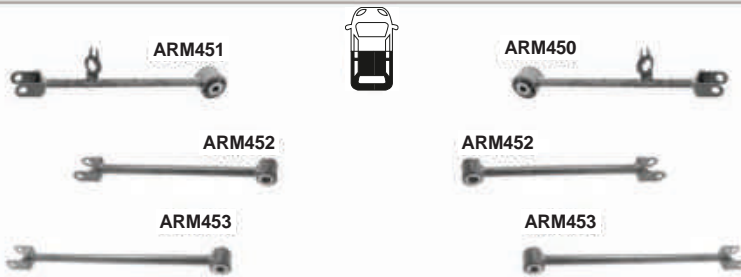
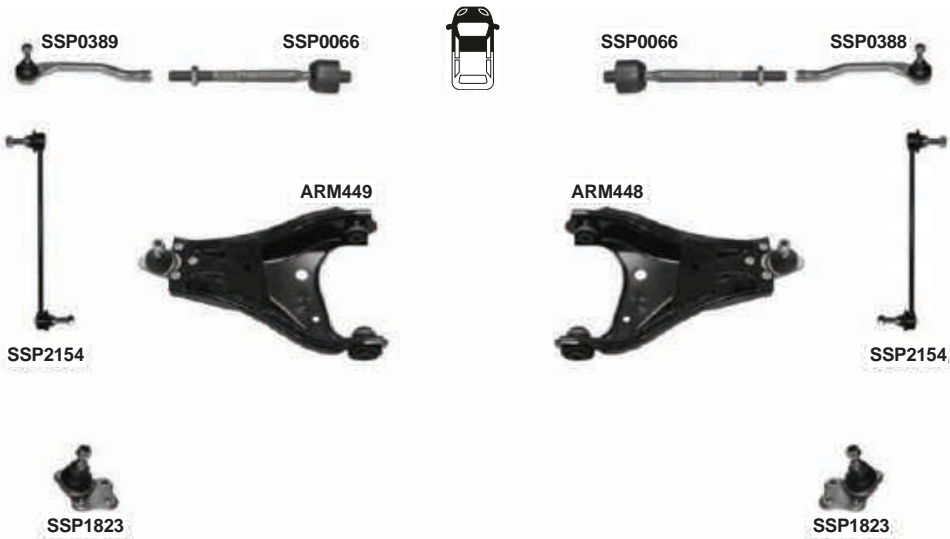

	PART NO.	DESCRIPTION	NOTES	O.E.
ARM448	301181344800	Suspension Control Arm and Ball Joint Assembly - Front Right Lower		545001535R; 545006542R
ARM449	301181344900	Suspension Control Arm and Ball Joint Assembly - Front Left Lower		545016746R; 545019969R
ARM450	301181345000	Lateral Arm - Rear Right	4X4	551119305R; 8200841004
ARM451	301181345100	Lateral Arm - Rear Left	4X4	551107894R; 8200839107
ARM452	301181345200	Lateral Arm - Rear Center	4X4	8200839124
ARM453	301181345300	Lateral Arm - Rear Lower	4X4	8200839119
SSP0066	301191600660	Steering Tie Rod - Front	M14x1,5	8201108350
SSP0388	301191603880	Steering Tie Rod End - Front Right	M14X1,5	8201108332
SSP0389	301191603890	Steering Tie Rod End - Front Left	M14X1,5	8201108339
SSP1823	301191618230	Suspension Ball Joint - Front Lower		401602308R
SSP2154	301191621540	Suspension Stabilizer Bar Link - Front	L=294mm	8200814411



DACIA LODGY



03/2012-

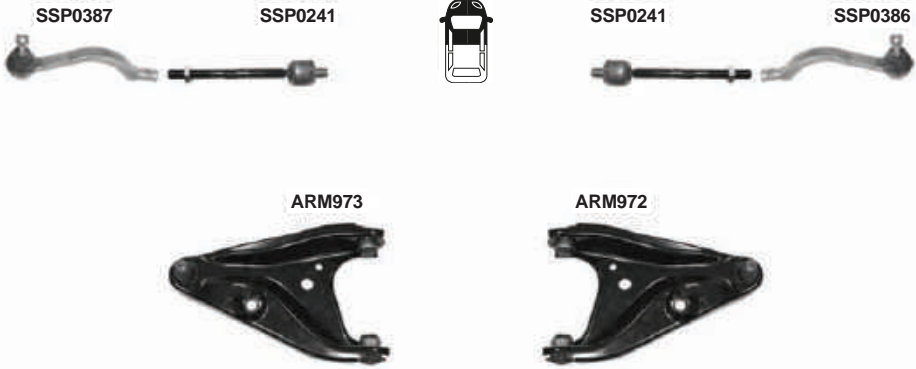

	PART NO.	DESCRIPTION	NOTES	O.E.
ARM972	301181397200	Suspension Control Arm and Ball Joint Assembly - Front Right Lower		545004529R; 545007106R
ARM973	301181397300	Suspension Control Arm and Ball Joint Assembly - Front Left Lower		545010294R; 545011727R
SSP0241	301191602410	Steering Tie Rod - Front	M14X1,5 - L=193mm	485213172R
SSP0386	301191603860	Steering Tie Rod End - Front Right	M14X1,5Rht	485200410R; 6001550443; 6001547611
SSP0387	301191603870	Steering Tie Rod End - Front Left	M14X1,5Rht	485202867R; 6001550442; 6001547610



DACIA LOGAN (LS)



09/2004-11/2012

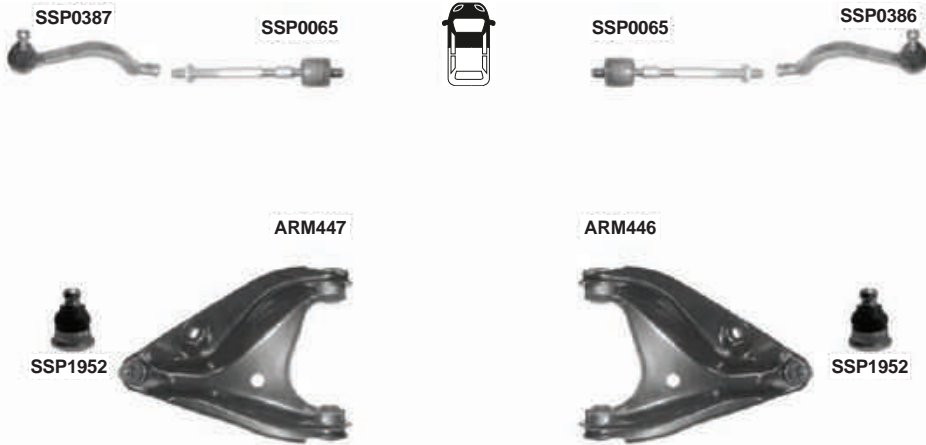

	PART NO.	DESCRIPTION	NOTES	O.E.
ARM446	301181344600	Suspension Control Arm and Ball Joint Assembly - Front Right Lower		545004269R; 8200216376; 6001547519
ARM447	301181344700	Suspension Control Arm and Ball Joint Assembly - Front Left Lower		545011362R; 8200216376; 6001547520
SSP0065	301191600650	Steering Tie Rod - Front	M14x1,5 - L=193mm	6001547606
SSP0386	301191603860	Steering Tie Rod End - Front Right	M14X1,5Rht	485200410R; 6001550443; 6001547611
SSP0387	301191603870	Steering Tie Rod End - Front Left	M14X1,5Rht	485202867R; 6001550442; 6001547610
SSP1952	301191619520	Suspension Ball Joint - Front	D=Ø18mm	8200298455/S



DACIA LOGAN II



12/2012-

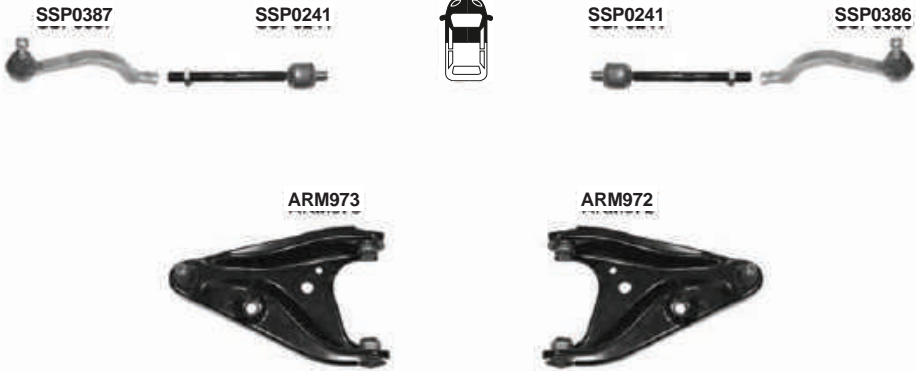

	PART NO.	DESCRIPTION	NOTES	O.E.
ARM972	301181397200	Suspension Control Arm and Ball Joint Assembly - Front Right Lower		545004529R; 545007106R
ARM973	301181397300	Suspension Control Arm and Ball Joint Assembly - Front Left Lower		545010294R; 545011727R
SSP0241	301191602410	Steering Tie Rod - Front	M14X1,5 - L=193mm	485213172R
SSP0386	301191603860	Steering Tie Rod End - Front Right	M14X1,5Rht	485200410R; 6001550443; 6001547611
SSP0387	301191603870	Steering Tie Rod End - Front Left	M14X1,5Rht	485202867R; 6001550442; 6001547610



DACIA LOGAN MCV (KS)



02/2007-01/2013

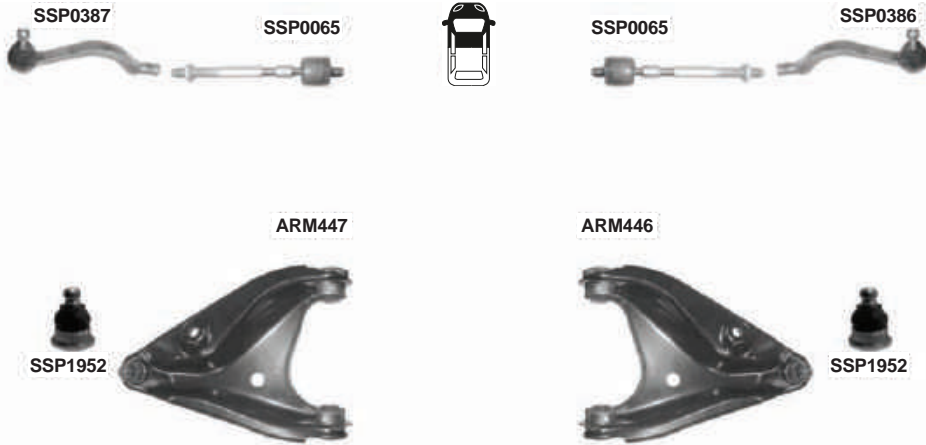

	PART NO.	DESCRIPTION	NOTES	O.E.
ARM446	301181344600	Suspension Control Arm and Ball Joint Assembly - Front Right Lower		545004269R; 8200216376; 6001547519
ARM447	301181344700	Suspension Control Arm and Ball Joint Assembly - Front Left Lower		545011362R; 8200216376; 6001547520
SSP0065	301191600650	Steering Tie Rod - Front	M14x1,5 - L=193mm	6001547606
SSP0386	301191603860	Steering Tie Rod End - Front Right	M14X1,5Rht	485200410R; 6001550443; 6001547611
SSP0387	301191603870	Steering Tie Rod End - Front Left	M14X1,5Rht	485202867R; 6001550442; 6001547610
SSP1952	301191619520	Suspension Ball Joint - Front	D=Ø18mm	8200298455/S



DACIA SANDERO I



06/2008-12/2012

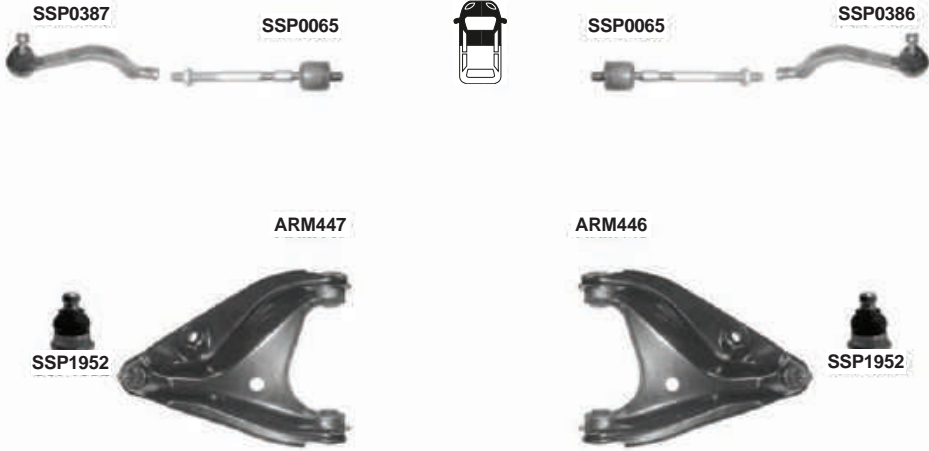

PART NO.	DESCRIPTION	NOTES	O.E.
ARM446	301181344600 Suspension Control Arm and Ball Joint Assembly - Front Right Lower		545004269R; 8200216376; 6001547519
ARM447	301181344700 Suspension Control Arm and Ball Joint Assembly - Front Left Lower		545011362R; 8200216376; 6001547520
SSP0065	301191600650 Steering Tie Rod - Front	M14x1,5 - L=193mm	6001547606
SSP0386	301191603860 Steering Tie Rod End - Front Right	M14X1,5Rht	485200410R; 6001550443; 6001547611
SSP0387	301191603870 Steering Tie Rod End - Front Left	M14X1,5Rht	485202867R; 6001550442; 6001547610
SSP1952	301191619520 Suspension Ball Joint - Front	D=Ø18mm	8200298455/S



DACIA SANDERO II



01/2013-

SSP0387



SSP0241



SSP0241



SSP0386



ARM973



ARM972



	PART NO.	DESCRIPTION	NOTES	O.E.
ARM972	301181397200	Suspension Control Arm and Ball Joint Assembly - Front Right Lower		545004529R; 545007106R
ARM973	301181397300	Suspension Control Arm and Ball Joint Assembly - Front Left Lower		545010294R; 545011727R
SSP0241	301191602410	Steering Tie Rod - Front	M14X1,5 - L=193mm	485213172R
SSP0386	301191603860	Steering Tie Rod End - Front Right	M14X1,5Rht	485200410R; 6001550443; 6001547611
SSP0387	301191603870	Steering Tie Rod End - Front Left	M14X1,5Rht	485202867R; 6001550442; 6001547610



DACIA SOLENZA (S.NOVA)



2003-2007



SSP1944



SSP1944

PART NO.	DESCRIPTION	NOTES	O.E.
SSP1944 301191619440	Suspension Ball Joint - Front Lower	D=Ø16mm - Hole: Ø10,5mm - Ø12,6mm	6001538603; 7701468883; 7701462182

**DAEWOO KALOS (KLAS)**

09/2002-03/2011

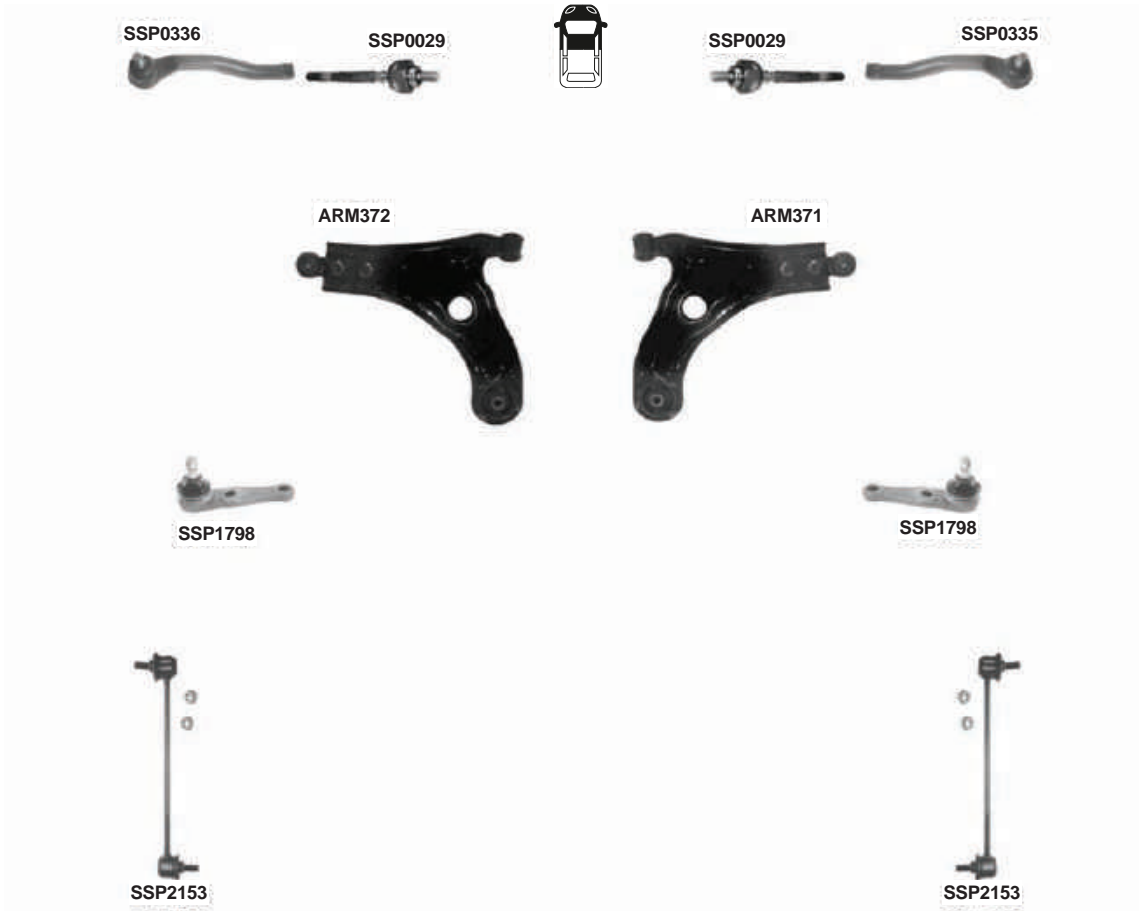

	PART NO.	DESCRIPTION	NOTES	O.E.
ARM371	301181337100	Suspension Control Arm and Ball Joint Assembly - Front Right Lower		96535082; 96870466
ARM372	301181337200	Suspension Control Arm and Ball Joint Assembly - Front Left Lower		96535081; 96870465
SSP0029	301191600290	Steering Tie Rod - Front	M12x1,5Rht -L=201mm	96535300
SSP0335	301191603350	Steering Tie Rod End - Front Right	M12x1,5Rht	93740723
SSP0336	301191603360	Steering Tie Rod End - Front Left	M12x1,5Rht	93740722
SSP1798	301191617980	Suspension Ball Joint - Front Lower		96535089
SSP2153	301191621530	Suspension Stabilizer Bar Link - Front	L=262mm	96391875



DAEWOO LEGANZA



1997-2004



SSP2094



SSP2093



SSP2420



SSP2420

PART NO.	DESCRIPTION	NOTES	O.E.
SSP2093 301191620930	Suspension Stabilizer Bar Link - Front Right	L=80mm	96225859
SSP2094 301191620940	Suspension Stabilizer Bar Link - Front Left	L=80mm	96225858
SSP2420 301191624200	Suspension Stabilizer Bar Link - Front	L=265mm	5087.58; MN101368



DAEWOO NUBIRA I



05/1997-06/2003



SSP2153



SSP2153

PART NO.	DESCRIPTION	NOTES	O.E.
SSP2153 301191621530	Suspension Stabilizer Bar Link - Front	L=262mm	96391875



DAEWOO NUBIRA II (1.6i, 1.8i)



07/2003-2009

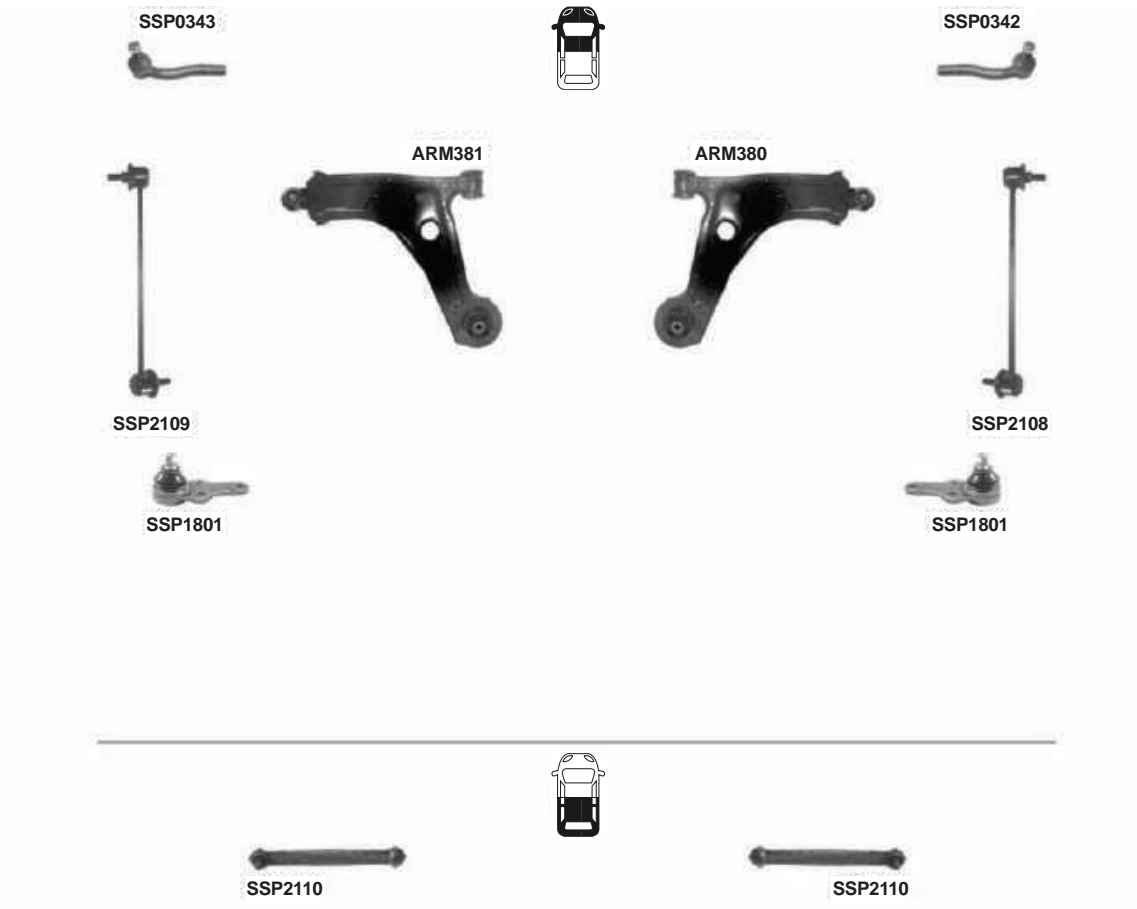

PART NO.	DESCRIPTION	NOTES	O.E.
ARM380 301181338000	Suspension Control Arm and Ball Joint Assembly - Front Right Lower		96391851; 96415064
ARM381 301181338100	Suspension Control Arm and Ball Joint Assembly - Front Left Lower		96391850; 96415063
SSP0342 301191603420	Steering Tie Rod End - Front Right	M14X1,5Rht	93740623; 96407486
SSP0343 301191603430	Steering Tie Rod End - Front Left	M14X1,5Rht	96407485
SSP1801 301191618010	Suspension Ball Joint - Front	D=Ø 18mm	96490218
SSP2108 301191621080	Suspension Stabilizer Bar Link - Front Right	L=272mm	96403100
SSP2109 301191621090	Suspension Stabilizer Bar Link - Front Left	L=272mm	96403099
SSP2110 301191621100	Suspension Stabilizer Bar Link - Rear	Plastic L=217mm	96391876; 96561754

**DAEWOO REZZO (KLAU)**

09/2000-02/2011

SSP0349



SSP0038



SSP0038



SSP0348



SSP1804

ARM389



ARM388



SSP1804



SSP2153



SSP2153

PART NO.	DESCRIPTION	NOTES	O.E.
ARM388	301181338800	Suspension Control Arm and Ball Joint Assembly - Front Right Lower	96423324
ARM389	301181338900	Suspension Control Arm and Ball Joint Assembly - Front Left Lower	96422220
SSP0038	301191600380	Steering Tie Rod - Front	M14x1,5 - L=238,7mm 93740621; C521564
SSP0348	301191603480	Steering Tie Rod End - Front Right	M14X1,5Rht 96261379
SSP0349	301191603490	Steering Tie Rod End - Front Left	M14X1,5Rht 96261378
SSP1804	301191618040	Suspension Ball Joint - Front	D=Ø 16mm 96261108
SSP2153	301191621530	Suspension Stabilizer Bar Link - Front	L=262mm 96391875



DODGE AVENGER



1995-2000



PART NO.	DESCRIPTION	NOTES	O.E.
SSP0551 301191605510	Steering Tie Rod End - Front		5682036000; MB912519; MB192430; MB616286

**DODGE AVENGER 1st Gen**

2011-2014



	PART NO.	DESCRIPTION	NOTES	O.E.
ARM440	301181344000	Suspension Control Arm - Front Right Lower		5085408AK
ARM441	301181344100	Suspension Control Arm - Front Left Lower		5085407AK
SSP2146	301191621460	Suspension Stabilizer Bar Link - Front		68186554AB; 68186554AA
SSP2420	301191624200	Suspension Stabilizer Bar Link - Front	L=265mm	5087.58; MN101368



DODGE CALIBER



2007-2015



	PART NO.	DESCRIPTION	NOTES	O.E.
ARM629	301181362900	Suspension Control Arm and Ball Joint Assembly - Front Right		5105040AH; 5105040AD
ARM630	301181363000	Suspension Control Arm and Ball Joint Assembly - Front Left		5105041AH; 5105041AC
SSP1865	301191618650	Suspension Ball Joint - Front Lower		5105041AC / 5105041AH Part of; 5105040AC / 5105040AH Part of

**DODGE CARAVAN/G. CARAVAN**

1995-2001

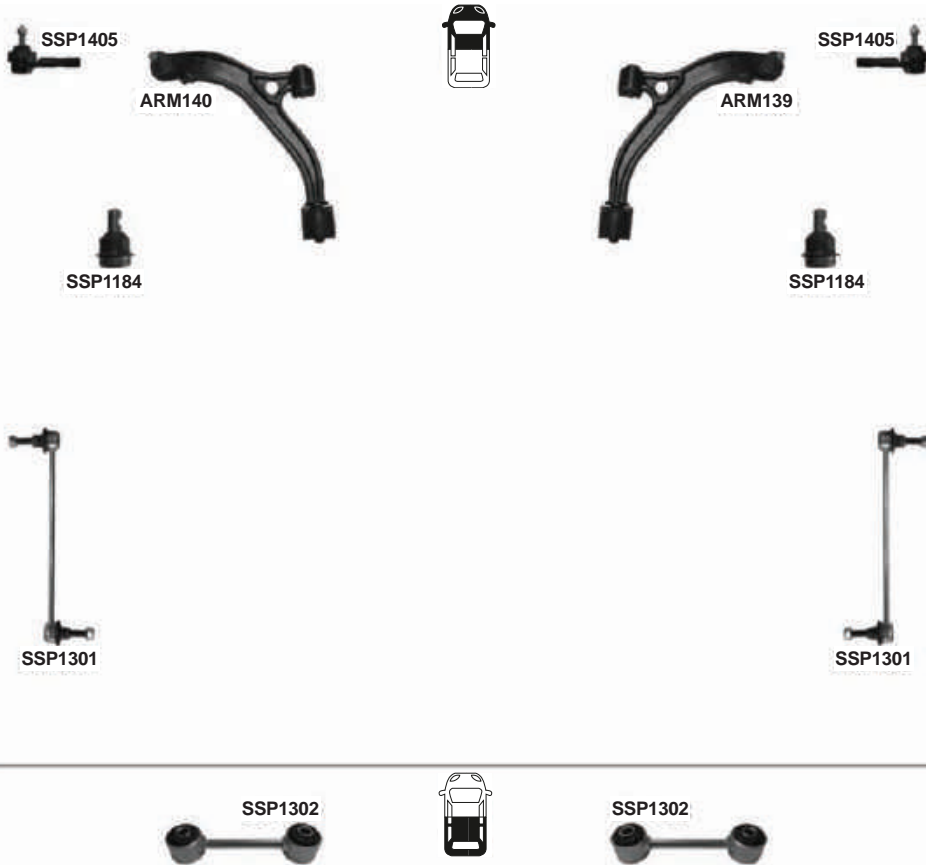

	PART NO.	DESCRIPTION	NOTES	O.E.
ARM139	301181313900	Suspension Control Arm and Ball Joint Assembly - Front Right		4694760
ARM140	301181314000	Suspension Control Arm and Ball Joint Assembly - Front Left		4694761
SSP1184	301181311840	Suspension Ball Joint - Front Lower	D=Ø19.9mm	4443405; 4449553
SSP1185	301181311850	Suspension Ball Joint - Front Lower		5051316
SSP1301	301181313010	Suspension Stabilizer Bar Link - Front	L=310mm	4743021AA; K04694855; 4743669AB; 4743669AC; 4743454AC; 4743454AB; 4743454AA
SSP1302	301181313020	Suspension Stabilizer Bar Link - Rear	L=119mm	5272190
SSP1405	301181314050	Steering Tie Rod End - Front	M14x1,5	4797706; K04797706



PART NO.	DESCRIPTION	NOTES	O.E.
ARM436 301181343600	Suspension Control Arm and Ball Joint Assembly - Front Right Lower		4743834AB
ARM437 301181343700	Suspension Control Arm and Ball Joint Assembly - Front Left Lower		4743835AB



DODGE CHALLENGER 4th Gen



2008-



SSP0396

SSP0068

SSP1408



SSP0068

SSP0396

SSP1408



ARM466



ARM465



SSP1821

ARM459



ARM458

SSP1821



ARM443



ARM442



ARM455



ARM454



ARM457



ARM456



ARM468



ARM467



ARM469



ARM469



SSP1306



SSP1305



SSP1304



SSP1304



DODGE CHALLENGER 4th Gen



2008-

PART NO.	DESCRIPTION	NOTES	O.E.
ARM442	301181344200 Suspension Control Arm and Ball Joint Assembly - Front Right	RWD	05180606AA; DA782612AC; 782612AC; 05180606AB
ARM443	301181344300 Suspension Control Arm and Ball Joint Assembly - Front Left	RWD	05180607AA; DA782613AC; 782613AC
ARM454	301181345400 Suspension Control Arm and Ball Joint Assembly - Front Right Lower	HEAVY DUTY SUSP. from 2010	04670508AD
ARM455	301181345500 Suspension Control Arm and Ball Joint Assembly - Front Left Lower	HEAVY DUTY SUSP. from 2010	04670509AD
ARM456	301181345600 Suspension Control Arm and Ball Joint Assembly - Front Right Lower		05168652AC
ARM457	301181345700 Suspension Control Arm and Ball Joint Assembly - Front Left Lower		05168653AC
ARM458	301181345800 Suspension Control Arm - Front Lower		05168389AB; 05168389AA
ARM459	301181345900 Suspension Control Arm - Rear Lower Forward		04782561AA; 04782561AE; 04782561AF; 04782561AD; 04782561AC; 04782561AB
ARM465	301181346500 Suspension Control Arm and Ball Joint Assembly - Front Right Upper		68045130AE; 04782666AE
ARM466	301181346600 Suspension Control Arm and Ball Joint Assembly - Front Left Upper		68045131AE; 04782665AE
ARM467	301181346700 Suspension Control Arm and Ball Joint Assembly - Front Right Lower	HEAVY DUTY SUSP.	05290828AB
ARM468	301181346800 Suspension Control Arm and Ball Joint Assembly - Front Left Lower	HEAVY DUTY SUSP.	05290829AB
ARM469	301181346900 Suspension Control Arm - Front Lower	RWD, HEAVY DUTY, HIGH PERF.	68079723AB
SSP0068	301191600680 Steering Tie Rod - Front		68158377AA
SSP0396	301191603960 Steering Tie Rod End - Front		68156902AA
SSP1304	301181313040 Suspension Stabilizer Bar Link - Rear	from 2010 L=261mm	4766866AA
SSP1305	301181313050 Suspension Stabilizer Bar Link - Front Right	L=214mm	4895482AA; 4895482AC; K04895483AB
SSP1306	301181313060 Suspension Stabilizer Bar Link - Front Left	L=214mm	4895483AA; K0489548AB
SSP1408	301181314080 Steering Tie Rod End - Front Outer	only 2008-2010	52013468AB; 68141049AA; 52013468AC
SSP1821	301191618210 Suspension Ball Joint - Front Lower		68159271AA; 4782741AB; 4782740AB; 4782740AA



DODGE CHARGER 6th Gen



2005-2010

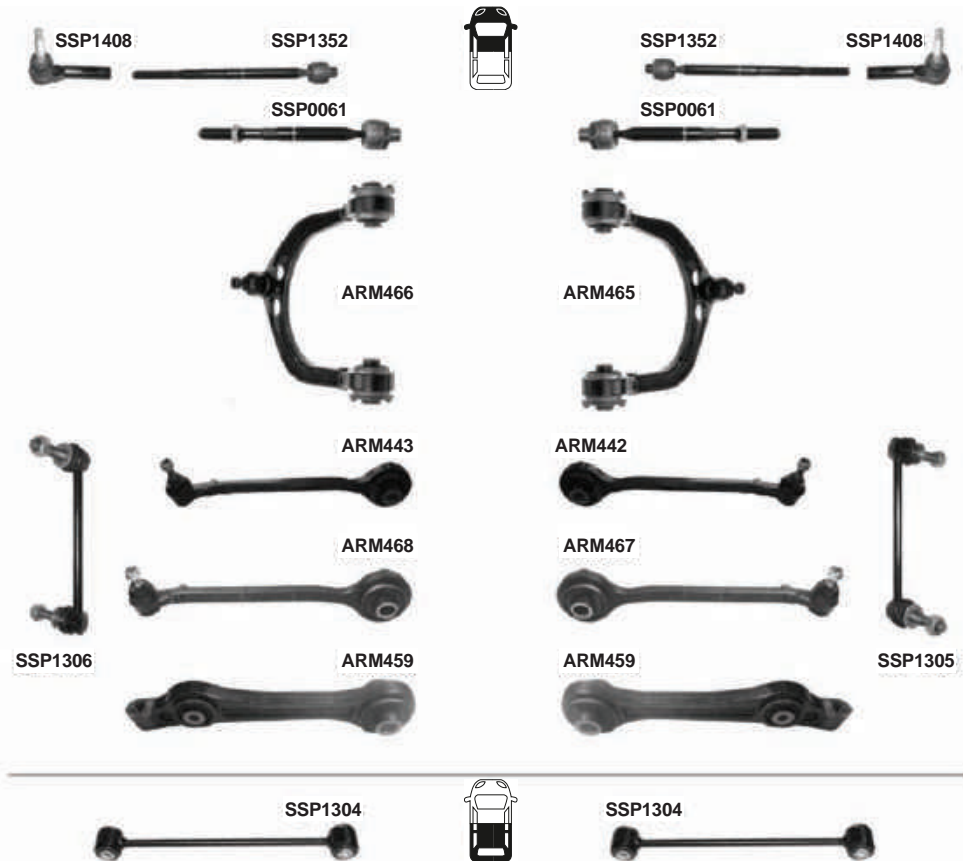

PART NO.	DESCRIPTION	NOTES	O.E.
ARM442 301181344200	Suspension Control Arm and Ball Joint Assembly - Front Right	RWD	05180606AA; DA782612AC; 782612AC; 05180606AB
ARM443 301181344300	Suspension Control Arm and Ball Joint Assembly - Front Left	RWD	05180607AA; DA782613AC; 782613AC
ARM459 301181345900	Suspension Control Arm - Rear Lower Forward	RWD	04782561AA; 04782561AE; 04782561AF; 04782561AD; 04782561AC; 04782561AB
ARM465 301181346500	Suspension Control Arm and Ball Joint Assembly - Front Right Upper		68045130AE; 04782666AE
ARM466 301181346600	Suspension Control Arm and Ball Joint Assembly - Front Left Upper		68045131AE; 04782666AE
ARM467 301181346700	Suspension Control Arm and Ball Joint Assembly - Front Right Lower	HEAVY DUTY SUSP. RWD	05290828AB
ARM468 301181346800	Suspension Control Arm and Ball Joint Assembly - Front Left Lower	HEAVY DUTY SUSP. RWD	05290829AB
SSP0061 301191600610	Steering Tie Rod - Front	RWD	68157856AA
SSP1304 301181313040	Suspension Stabilizer Bar Link - Rear	L=261mm	4766866AA
SSP1305 301181313050	Suspension Stabilizer Bar Link - Front Right	L=214mm	4895482AA; 4895482AC; K04895483AB
SSP1306 301181313060	Suspension Stabilizer Bar Link - Front Left	L=214mm	4895483AA; K0489548AB
SSP1352 301181313520	Steering Tie Rod - Front	RWD M15x1.5 - L=323.5mm	68028831AC; 680288331AR
SSP1408 301181314080	Steering Tie Rod End - Front Outer	RWD	52013468AB; 68141049AA; 52013468AC



DODGE CHARGER 7th Gen



2011-

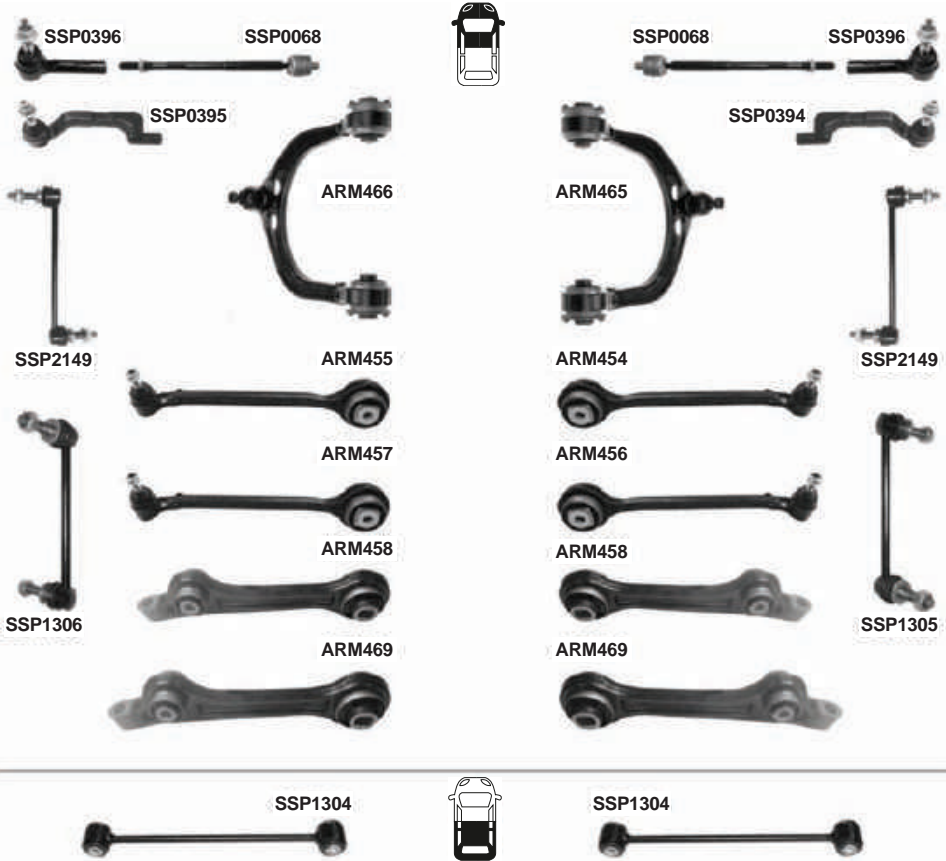

**DODGE CHARGER 7th Gen****2011-**

	PART NO.	DESCRIPTION	NOTES	O.E.
ARM454	301181345400	Suspension Control Arm and Ball Joint Assembly - Front Right Lower	HEAVY DUTY SUSP. RWD	04670508AD
ARM455	301181345500	Suspension Control Arm and Ball Joint Assembly - Front Left Lower	HEAVY DUTY SUSP. RWD	04670509AD
ARM456	301181345600	Suspension Control Arm and Ball Joint Assembly - Front Right Lower	RWD	05168652AC
ARM457	301181345700	Suspension Control Arm and Ball Joint Assembly - Front Left Lower	RWD	05168653AC
ARM458	301181345800	Suspension Control Arm - Front Lower	RWD	05168389AB; 05168389AA
ARM465	301181346500	Suspension Control Arm and Ball Joint Assembly - Front Right Upper		68045130AE; 04782666AE
ARM466	301181346600	Suspension Control Arm and Ball Joint Assembly - Front Left Upper		68045131AE; 04782665AE
ARM469	301181346900	Suspension Control Arm - Front Lower	RWD, HEAVY DUTY, HIGH PERF.	68079723AB
SSP0068	301191600680	Steering Tie Rod - Front	RWD	68158377AA
SSP0394	301191603940	Steering Tie Rod End - Front Right	4WD	68156906AA
SSP0395	301191603950	Steering Tie Rod End - Front Left	4WD	68156905AA
SSP0396	301191603960	Steering Tie Rod End - Front	RWD	68156902AA
SSP1304	301181313040	Suspension Stabilizer Bar Link - Rear	L=261mm	4766866AA
SSP1305	301181313050	Suspension Stabilizer Bar Link - Front Right	L=214mm	4895482AA; 4895482AC; K04895483AB
SSP1306	301181313060	Suspension Stabilizer Bar Link - Front Left	L=214mm	4895483AA; K0489548AB
SSP2149	301191621490	Suspension Stabilizer Bar Link - Front	4x4	4782952AD



PART NO.	DESCRIPTION	NOTES	O.E.
SSP0064 301191600640	Steering Tie Rod - Front		68158379AA



DODGE DAKOTA 2rd Gen



2000-2004



PART NO.	DESCRIPTION	NOTES	O.E.
SSP1408 301181314080	Steering Tie Rod End - Front Outer		52013468AB; 68141049AA; 52013468AC



DODGE DART (PF)



2013-



PART NO.	DESCRIPTION	NOTES	O.E.
SSP0069 301191600690	Steering Tie Rod - Front		68164072AB
SSP0397 301191603970	Steering Tie Rod End - Front Right		68185502AB
SSP0398 301191603980	Steering Tie Rod End - Front Left		68185503AB



DODGE DURANGO 3rd Gen



2011-2017

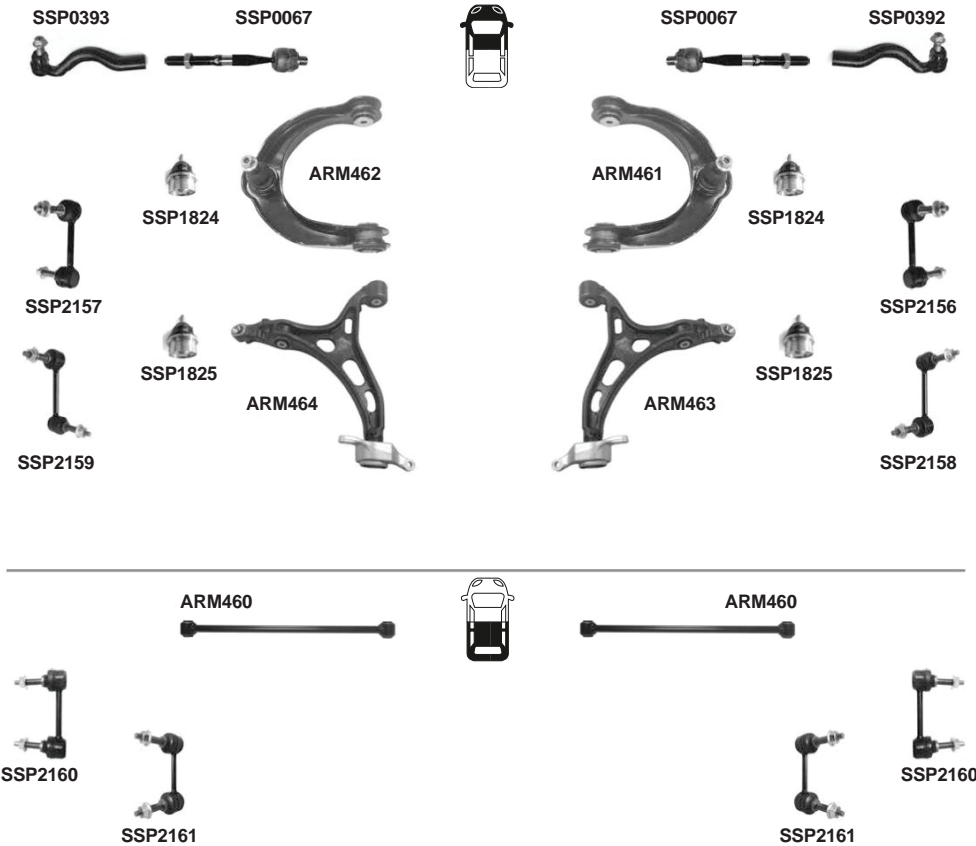

PART NO.	DESCRIPTION	NOTES	O.E.
ARM460	301181346000 Lateral Arm - Rear		52124840AB
ARM461	301181346100 Suspension Control Arm and Ball Joint Assembly - Front Right Upper		68217808AA
ARM462	301181346200 Suspension Control Arm and Ball Joint Assembly - Front Left Upper		68217809AA
ARM463	301181346300 Suspension Control Arm - Front Right Lower		5168158AA; 68022600AD; 5168158AB
ARM464	301181346400 Suspension Control Arm - Front Left Lower		5168159AA; 68022601AD; 5168159AB
SSP0067	301191600670 Steering Tie Rod - Front		68105872AA; 68105872AB
SSP0392	301191603920 Steering Tie Rod End - Front Right		68069646AB
SSP0393	301191603930 Steering Tie Rod End - Front Left		68069647AB
SSP1824	301191618240 Suspension Ball Joint - Front Upper		68217808AA; 68217809AA
SSP1825	301191618250 Suspension Ball Joint - Front Lower		68069648AB
SSP2156	301191621560 Suspension Stabilizer Bar Link - Front Right	sport suspension	68091836AA
SSP2157	301191621570 Suspension Stabilizer Bar Link - Front Left		68091837AA
SSP2158	301191621580 Suspension Stabilizer Bar Link - Front Right	standart type	68069654AB
SSP2159	301191621590 Suspension Stabilizer Bar Link - Front Left	standart type	68069655AB
SSP2160	301191621600 Suspension Stabilizer Bar Link - Rear	standart type	68069682AA
SSP2161	301191621610 Suspension Stabilizer Bar Link - Rear	Performance Package	68091853AA



DODGE GRAND CARAVAN V



2008-2016

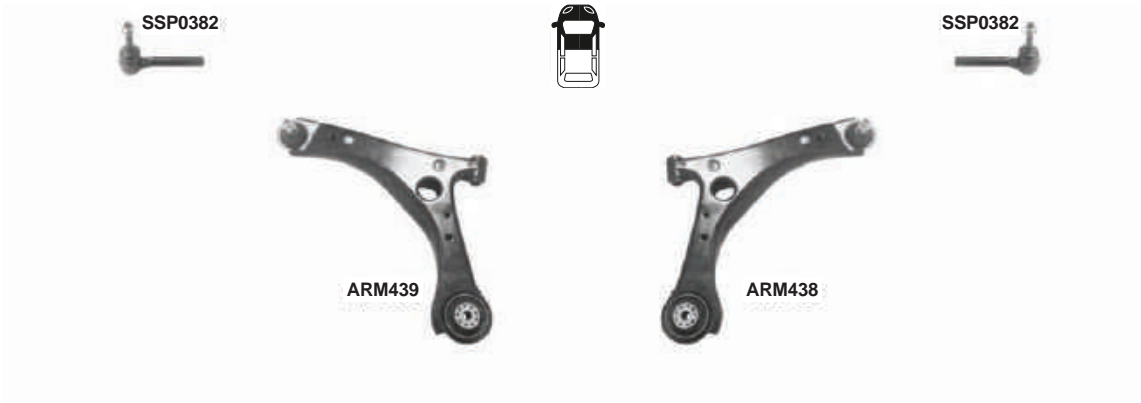

	PART NO.	DESCRIPTION	NOTES	O.E.
ARM438	301181343800	Suspension Control Arm and Ball Joint Assembly - Front Right Lower		04766910AL
ARM439	301181343900	Suspension Control Arm and Ball Joint Assembly - Front Left Lower		04766911AL
SSP0061	301191600610	Steering Tie Rod - Front		68157856AA
SSP0062	301191600620	Steering Tie Rod - Front		68040225AA
SSP0381	301191603810	Steering Tie Rod End -		68156146AA
SSP0382	301191603820	Steering Tie Rod End - Front	4x4	68033171AB



DODGE GRAND VOYAGER III



1995-2001



PART NO.	DESCRIPTION	NOTES	O.E.
SSP1184 301181311840	Suspension Ball Joint - Front Lower	D=Ø19.9mm	4443405; 4449553



DODGE JOURNEY



01/2009-



PART NO.	DESCRIPTION	NOTES	O.E.
ARM137 301181313700	Suspension Control Arm - Front Right		K04766424AA; K04766424AE; K04766424AD; K04766424AC; K04766424AB
ARM138 301181313800	Suspension Control Arm - Front Left		K04766423AA; K04766423AE; K04766423AD; K04766423AC; K04766423AB
SSP1186 301181311860	Suspension Ball Joint - Front Lower		K05090033AB; 5090033AB
SSP1307 301181313070	Suspension Stabilizer Bar Link - Front	L=265mm	K04766962AA
SSP1308 301181313080	Suspension Stabilizer Bar Link - Rear	L=80mm	K04766435AA; K68052655AA
SSP1406 301181314060	Steering Tie Rod End - Front	M14x1,5	05066373AB; K05183761AA; ES3008RL; 5183761AA; 05183761AD



DODGE NEON



2003-2005



	PART NO.	DESCRIPTION	NOTES	O.E.
ARM151	301181315100	Suspension Control Arm and Ball Joint Assembly - Front Right Lower		04656730AH
ARM152	301181315200	Suspension Control Arm and Ball Joint Assembly - Front Left Lower		04656731AH
SSP1407	301181314070	Steering Tie Rod End - Front	M14X1,5	4762861; 4762861AA



DODGE NITRO



2007-2012

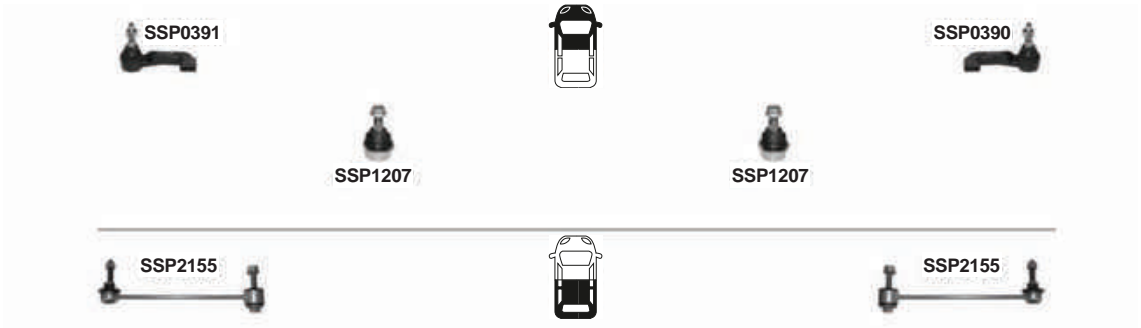

PART NO.	DESCRIPTION	NOTES	O.E.
SSP0390 301191603900	Steering Tie Rod End - Front Right	M16X1,5	52125366AA
SSP0391 301191603910	Steering Tie Rod End - Front Left	M16X1,5	52125367AA
SSP1207 301181312070	Suspension Ball Joint - Front Lower		5135651AE
SSP2155 301191621550	Suspension Stabilizer Bar Link - Rear	L=180mm	68029024AA



DODGE SPRINTER 2500 W901,W902,W903

01/1995-05/2006



	PART NO.	DESCRIPTION	NOTES	O.E.
ARM701	301181370100	Suspension Control Arm and Ball Joint Assembly - Front Right Lower		2D0407022; 9013301907; 9013302507
ARM702	301181370200	Suspension Control Arm and Ball Joint Assembly - Front Left Lower		2D0407021; 9013301807; 9013302407
SSP0138	301191601380	Steering Tie Rod - Front	M16x1,5Rht - L=388mm	9014600155; 9014600455
SSP0515	301191605150	Steering Tie Rod End - Front	M16x1,5Rht	2D0422811; 9014600148
SSP1884	301191618840	Suspension Ball Joint - Front Lower		2D0407361A; 9013331127; 2D0407361B; 9013330727
SSP1885	301191618850	Suspension Ball Joint - Front	4Matic (4x4)	9013331327; 9013331127; 2D0407361B; 9013330727
SSP2339	301191623390	Suspension Stabilizer Bar Link - Front Right	EXC. 616 CDI L=115mm	2D0411052; 9013200389
SSP2340	301191623400	Suspension Stabilizer Bar Link - Front Left	EXC. 616 CDI L=115mm	2D0411051; 9013200289
SSP2341	301191623410	Suspension Stabilizer Bar Link - Rear	L=93mm	2D0511329; 9013200089
SSP2343	301191623430	Suspension Stabilizer Bar Link - Front Right	616 CDI	9053200589
SSP2344	301191623440	Suspension Stabilizer Bar Link - Front Left	616 CDI	9053200489
SSP2345	301191623450	Suspension Stabilizer Bar Link - Rear	L=185mm	2E0511051F; 9063201389



DODGE SPRINTER 2500 W906



06/2006-

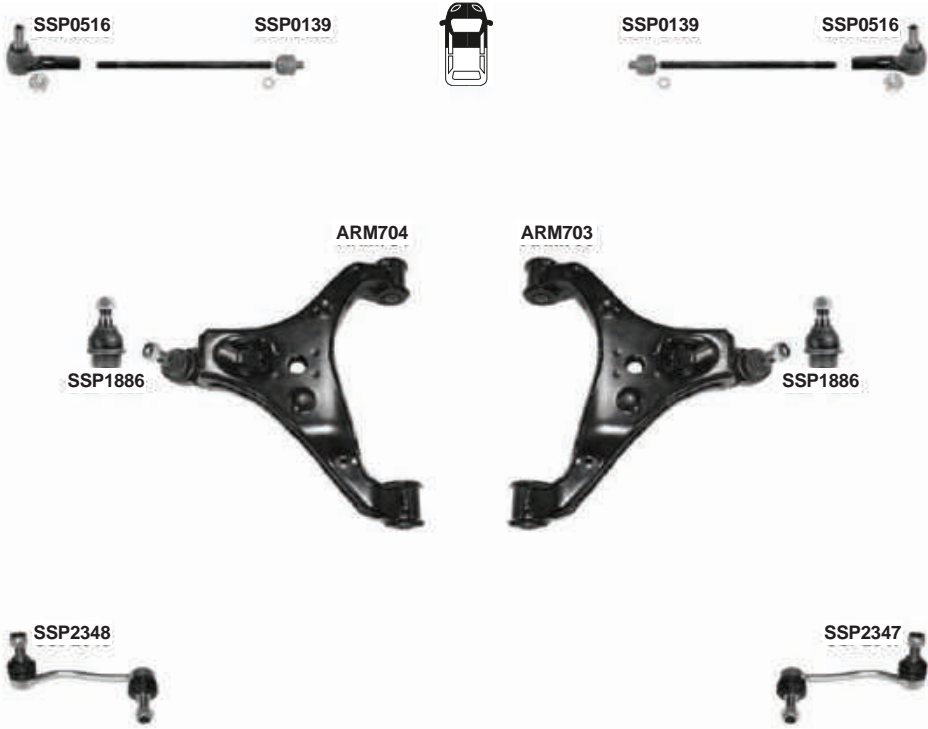

PART NO.	DESCRIPTION	NOTES	O.E.
ARM703 301181370300	Suspension Control Arm and Ball Joint Assembly - Front Right Lower		2E0407152M; 9063304107
ARM704 301181370400	Suspension Control Arm and Ball Joint Assembly - Front Left Lower		2E0407151M; 9063304007
SSP0139 301191601390	Steering Tie Rod - Front		2E0713491; 9064600055
SSP0516 301191605160	Steering Tie Rod End - Front		2E0713501; 9064600048
SSP1886 301191618860	Suspension Ball Joint - Front Lower		9063304007
SSP2347 301191623470	Suspension Stabilizer Bar Link - Front Right		2E0411318C; 9063201889
SSP2348 301191623480	Suspension Stabilizer Bar Link - Front Left		2E0411317C; 9063201789

**DODGE SPRINTER 3500 W901,W902,W903**

01/1995-05/2006



	PART NO.	DESCRIPTION	NOTES	O.E.
ARM701	301181370100	Suspension Control Arm and Ball Joint Assembly - Front Right Lower		2D0407022; 9013301907; 9013302507
ARM702	301181370200	Suspension Control Arm and Ball Joint Assembly - Front Left Lower		2D0407021; 9013301807; 9013302407
SSP0138	301191601380	Steering Tie Rod - Front	M16x1,5Rht - L=388mm	9014600155; 9014600455
SSP0515	301191605150	Steering Tie Rod End - Front	M16x1,5Rht	2D0422811; 9014600148
SSP1884	301191618840	Suspension Ball Joint - Front Lower		2D0407361A; 9013331127; 2D0407361B; 9013330727
SSP1885	301191618850	Suspension Ball Joint - Front	4Matic (4x4)	9013331327; 9013331127; 2D0407361B; 9013330727
SSP2339	301191623390	Suspension Stabilizer Bar Link - Front Right	EXC. 616 CDI L=115mm	2D0411052; 9013200389
SSP2340	301191623400	Suspension Stabilizer Bar Link - Front Left	EXC. 616 CDI L=115mm	2D0411051; 9013200289
SSP2341	301191623410	Suspension Stabilizer Bar Link - Rear	L=93mm	2D0511329; 9013200089
SSP2343	301191623430	Suspension Stabilizer Bar Link - Front Right	616 CDI	9053200589
SSP2344	301191623440	Suspension Stabilizer Bar Link - Front Left	616 CDI	9053200489
SSP2345	301191623450	Suspension Stabilizer Bar Link - Rear	L=185mm	2E0511051F; 9063201389



DODGE SPRINTER 3500 W906



06/2006-



PART NO.	DESCRIPTION	NOTES	O.E.
ARM703	301181370300 Suspension Control Arm and Ball Joint Assembly - Front Right Lower		2E0407152M; 9063304107
ARM704	301181370400 Suspension Control Arm and Ball Joint Assembly - Front Left Lower		2E0407151M; 9063304007
SSP0139	301191601390 Steering Tie Rod - Front		2E0713491; 9064600055
SSP0516	301191605160 Steering Tie Rod End - Front		2E0713501; 9064600048
SSP1886	301191618860 Suspension Ball Joint - Front Lower		9063304007
SSP2347	301191623470 Suspension Stabilizer Bar Link - Front Right		2E0411318C; 9063201889
SSP2348	301191623480 Suspension Stabilizer Bar Link - Front Left		2E0411317C; 9063201789

**DODGE STRATUS 2nd Gen**

1995-2006



	PART NO.	DESCRIPTION	NOTES	O.E.
ARM444	301181344400	Suspension Control Arm and Ball Joint Assembly - Front Right	for JX,JXi els	10946; K7427; 4764501AC; 4616922
ARM445	301181344500	Suspension Control Arm and Ball Joint Assembly - Front Left	for JX,JXi els	10945; K7425; 4764500AC; 4616923
SSP0383	301191603830	Steering Tie Rod End - Front Right Outer		5094006AA
SSP0384	301191603840	Steering Tie Rod End - Front Left Outer		5093857AA
SSP0551	301191605510	Steering Tie Rod End - Front		5682036000; MB912519; MB192430; MB616286



PART NO.	DESCRIPTION	NOTES	O.E.
SSP0071 301191600710	Steering Tie Rod - Front	M12x1,5 - L=192mm	5960321; SE141162449A
SSP1379 301181313790	Steering Tie Rod - Front	M14x1 - L=142mm	4318655
SSP1409 301181314090	Steering Tie Rod End - Front	M12x1,5Rht - L=127mm	5958246; 5983406; 5983404



FIAT 128 FAMILIARE



1969-1982



PART NO.	DESCRIPTION	NOTES	O.E.
SSP1379 301181313790	Steering Tie Rod - Front	M14x1 - L=142mm	4318655



FIAT 128 PANORAMA



1969-1982



PART NO.	DESCRIPTION	NOTES	O.E.
SSP1379 301181313790	Steering Tie Rod - Front	M14x1 - L=142mm	4318655



MAGNETI
MARELLI

FIAT 128 PANORAMA



1983-1989

SSP0071



SSP0071



PART NO.	DESCRIPTION	NOTES	O.E.
SSP0071 301191600710	Steering Tie Rod - Front	M12x1,5 - L=192mm	5960321; SE141162449A



FIAT 131



1974-2001



SSP1353



SSP1353



PART NO.	DESCRIPTION	NOTES	O.E.
SSP1353 301181313530	Steering Tie Rod - Front	Power Steering M12x1,5Rht L=285mm	59588244



FIAT 500



10/2007-2016

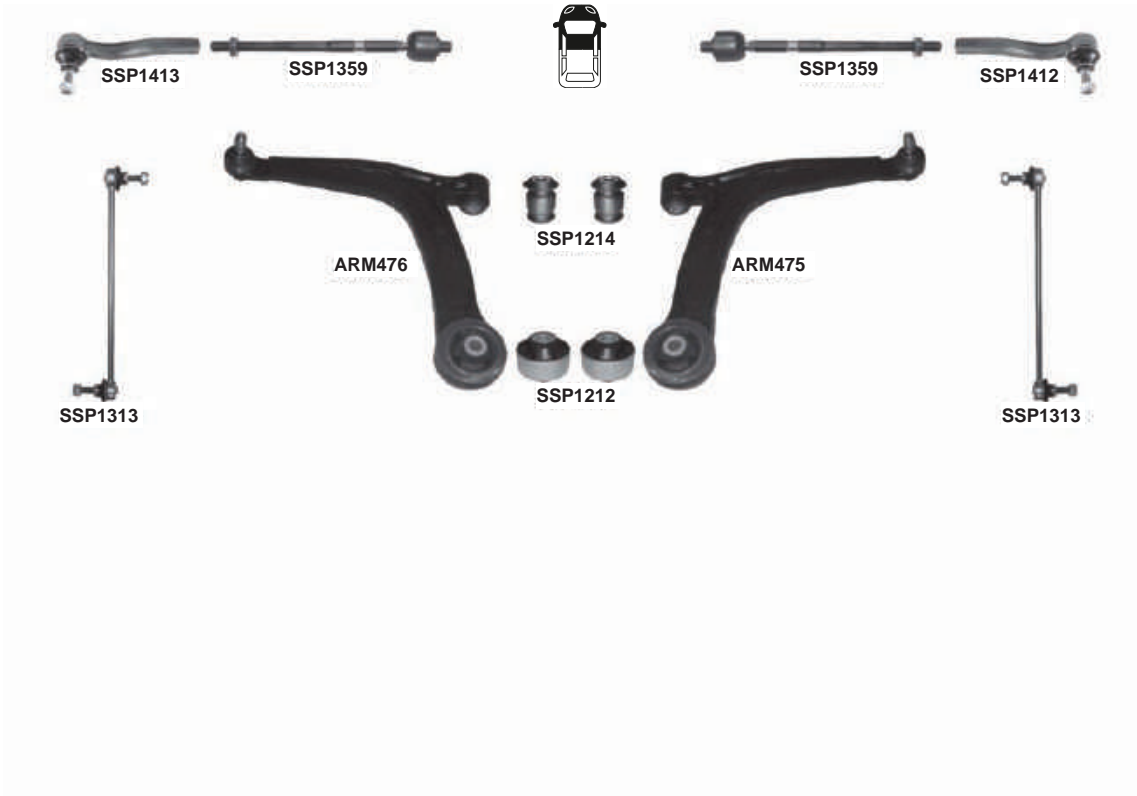

	PART NO.	DESCRIPTION	NOTES	O.E.
ARM475	301181347500	Suspension Control Arm and Ball Joint Assembly - Front Right Lower		1540724; 9S513078BC; 50710621; 50709580
ARM476	301181347600	Suspension Control Arm and Ball Joint Assembly - Front Left		1540725; 9S513078AC; 50710620; 50709579
SSP1212	301181312120	Bush / Silent block - Track control arm	ARM071 / ARM072	
SSP1214	301181312140	Bush / Silent block - Track control arm	ARM071 / ARM072/ ARM095 / ARM096	16545660
SSP1313	301181313130	Suspension Stabilizer Bar Link - Front	L=287mm	1580517; 9S515K484AB; 51801136
SSP1359	301181313590	Steering Tie Rod - Front	M14X1,25 - L=296mm	51875886SK Part Of .; 51965673 Part Of.
SSP1412	301181314120	Steering Tie Rod End - Front Right	M12x1,5Rht	1546260; 9S513270BA; 77362508
SSP1413	301181314130	Steering Tie Rod End - Front Left	M12x1,5Rht	1546259; 9S513270AA; 77362507



FIAT 500L



09/2012-

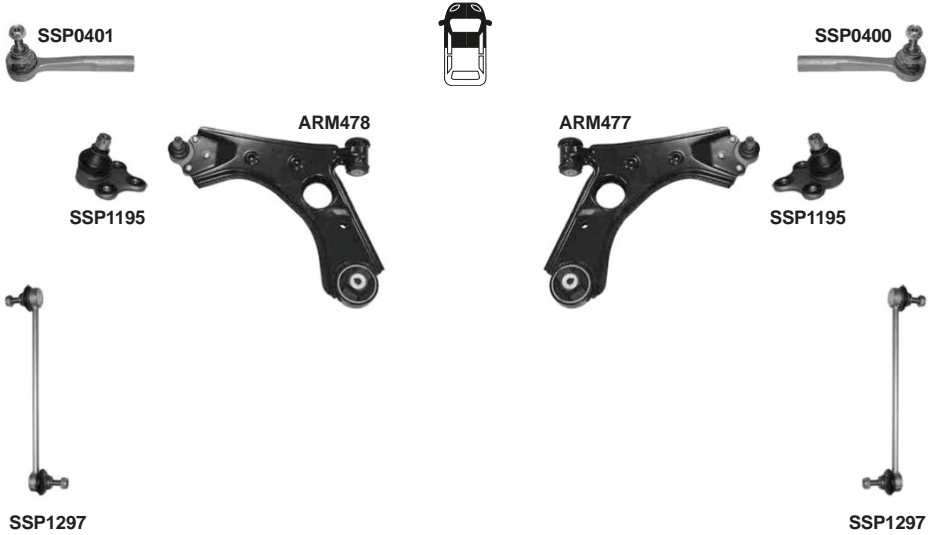

	PART NO.	DESCRIPTION	NOTES	O.E.
ARM477	301181347700	Suspension Control Arm and Ball Joint Assembly - Front Right Lower		51885660
ARM478	301181347800	Suspension Control Arm and Ball Joint Assembly - Front Left Lower		51885737
SSP0400	301191604000	Steering Tie Rod End - Front Right	M10X1,5	77366166
SSP0401	301191604010	Steering Tie Rod End - Front Left	M10X1,5	77366165
SSP1195	301181311950	Suspension Ball Joint - Front Lower	Ø18mm	Part of:51810664/665
SSP1297	301181312970	Suspension Stabilizer Bar Link - Front	L=298mm	50515276; 51805870



FIAT 500X



01/2015-



SSP2163

SSP2163

	PART NO.	DESCRIPTION	NOTES	O.E.
ARM479	301181347900	Suspension Control Arm and Ball Joint Assembly - Front Right	4X4	51939751
ARM480	301181348000	Suspension Control Arm and Ball Joint Assembly - Front Left	4X4	51939755
ARM483	301181348300	Suspension Control Arm and Ball Joint Assembly - Front Right Lower		51959820
ARM484	301181348400	Suspension Control Arm and Ball Joint Assembly - Front Left Lower		51961341
SSP0402	301191604020	Steering Tie Rod End - Front Right		77366699
SSP0403	301191604030	Steering Tie Rod End - Front Left		77366698
SSP1826	301191618260	Suspension Ball Joint - Front Lower		Part of:51961341/59820*; 51945321
SSP2163	301191621630	Suspension Stabilizer Bar Link - Front		51939949
SSP2164	301191621640	Suspension Stabilizer Bar Link - Rear	plastic type	53403319; 51942168

FIAT ALBEA 178



09/1996-05/2013

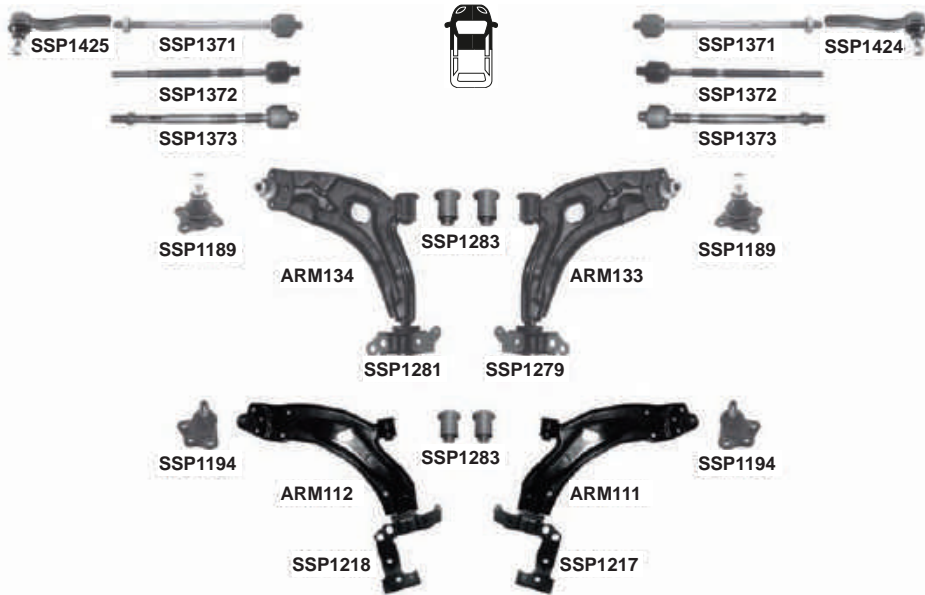

PART NO.	DESCRIPTION	NOTES	O.E.
ARM111	301181311100	Suspension Control Arm and Ball Joint Assembly - Front Right Lower	46777741; 51866700; 51769073; 51712407; 46794065
ARM112	301181311200	Suspension Control Arm and Ball Joint Assembly - Front Left Lower	46777742; 51769074; 51712408; 46794066
ARM133	301181313300	Suspension Control Arm and Ball Joint Assembly - Front Right Lower	Manual Steering 46454596
ARM134	301181313400	Suspension Control Arm and Ball Joint Assembly - Front Left Lower	Manual Steering 46454595
SSP1189	301181311890	Suspension Ball Joint - Front Lower	D=Ø 13mm 46437951
SSP1194	301181311940	Suspension Ball Joint - Front	46779293; 7082812; 46842581
SSP1217	301181312170	Bush / Silent block - Track control arm - Rear Rh	ARM111 / ARM135 46748579
SSP1218	301181312180	Bush / Silent block - Track control arm - Rear Lh	ARM112 / ARM136 46748578
SSP1279	301181312790	Bush / Silent block - Track control arm - Rear Rh	ARM133 Manual Steering 46454061
SSP1281	301181312810	Bush / Silent block - Track control arm - Rear Lh	ARM134 Manual Steering 46454062
SSP1283	301181312830	Bush / Silent block - Track control arm	ARM015 / ARM016 / ARM111 / ARM112 / ARM113 / ARM114 / ARM133 / ARM134 / ARM135 / ARM136 / ARM147 / ARM148 46421552
SSP1371	301181313710	Steering Tie Rod - Front	Power steering M14x1,5 - L=282mm 7079382
SSP1372	301181313720	Steering Tie Rod - Front	Manual Steering M14x1,5 - L=282mm 7079383
SSP1373	301181313730	Steering Tie Rod - Front	Power St M14x1,5 Rht - L=264mm 7081851
SSP1424	301181314240	Steering Tie Rod End - Front Right	M14x1,5Rht 46456660; 98845031
SSP1425	301181314250	Steering Tie Rod End - Front Left	M14x1,5Rht 46456189; 98845032



FIAT BARCHETTA



1995-2005

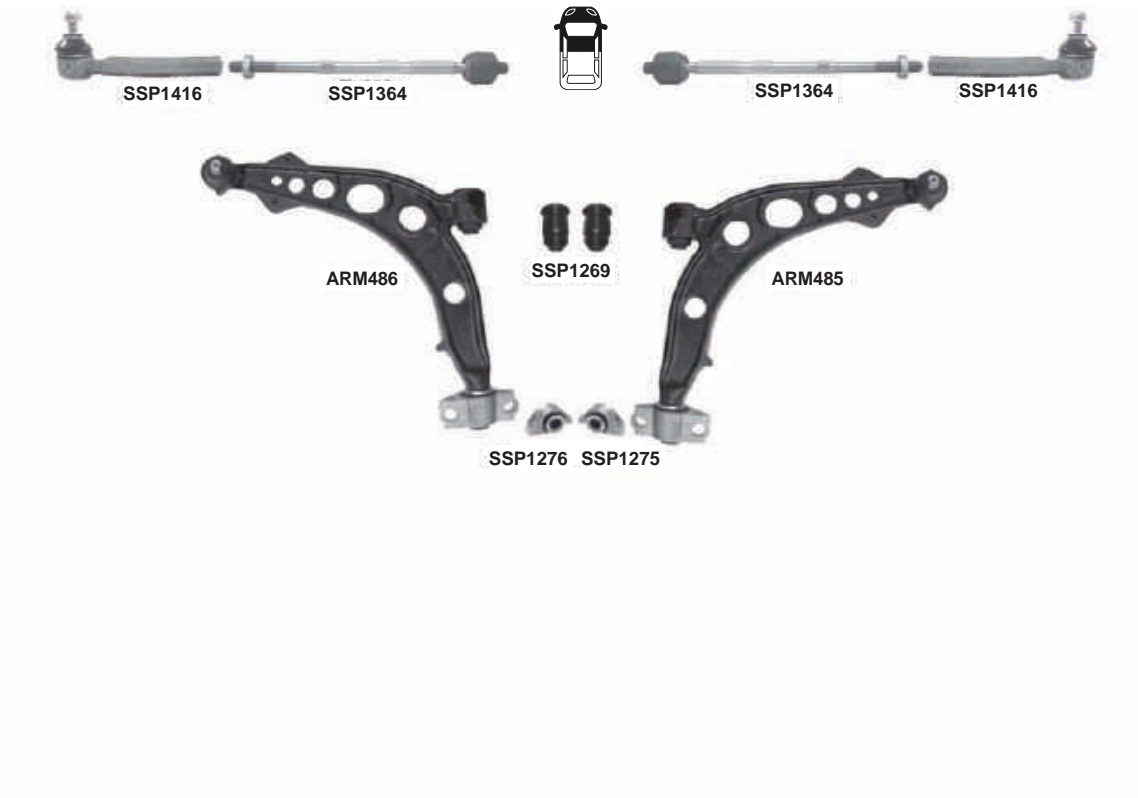

	PART NO.	DESCRIPTION	NOTES	O.E.
ARM485	301181348500	Suspension Control Arm and Ball Joint Assembly - Front Right Lower		46402682; 7750978; 46430003
ARM486	301181348600	Suspension Control Arm and Ball Joint Assembly - Front Left		46402681; 7750977; 46430002
SSP1269	301181312690	Bush / Silent block - Track control arm	ARM001 / ARM002 / ARM009 / ARM010 / ARM029 / ARM030	7673581
SSP1275	301181312750	Bush / Silent block - Track control arm - Rh	ARM029	7775344
SSP1276	301181312760	Bush / Silent block - Track control arm - Lh	ARM030	7775343
SSP1364	301181313640	Steering Tie Rod - Front	M12x1,5Rht - L=271.3mm	9945562
SSP1416	301181314160	Steering Tie Rod End - Front	M12x1,5Rht	7752285; 9946949



FIAT BRAVO & BRAVA 182



1995-2002

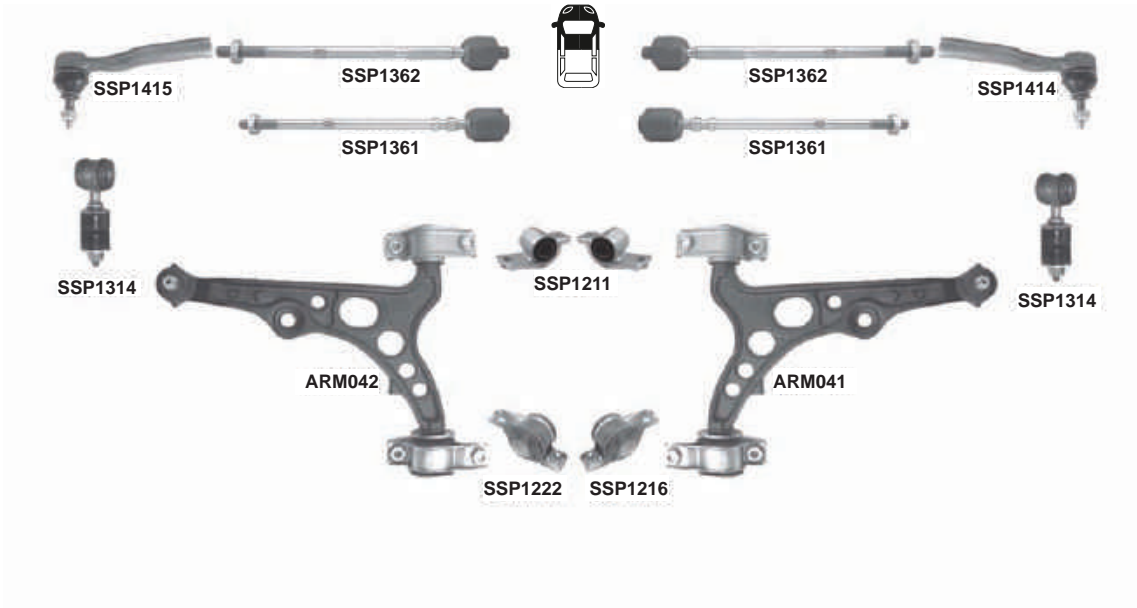

PART NO.	DESCRIPTION	NOTES	O.E.
ARM041	Suspension Control Arm and Ball Joint Assembly - Front Right Lower	D= Ø17mm	46423823; 82461082
ARM042	Suspension Control Arm and Ball Joint Assembly - Front Left	D= Ø17mm	46423822; 82461081
SSP1211	Bush / Silent block - Track control arm	ARM008 / ARM007 / ARM041 / ARM042 / ARM155 / ARM156 D=Ø20,9mm Center: 83mm	7601064
SSP1216	Bush / Silent block - Track control arm - Rear Rh	ARM007 / ARM041 / ARM155	7601065
SSP1222	Bush / Silent block - Track control arm - Rear Lh	ARM008 / ARM042 / ARM156	7601068
SSP1314	Suspension Stabilizer Bar Link - Front	M10x1,25Rht - L=114mm	12574521; 7601643; 7601642; 60570627
SSP1361	Steering Tie Rod - Front Inner	Manual Steering M12x1,5 - L=276.8mm	5958244; SE022162449S; 7633721
SSP1362	Steering Tie Rod - Front Inner	Power Steering M12x1,5 L=277mm	9941625
SSP1414	Steering Tie Rod End - Front Right	M12x1,5Rht	60806355; 9947438; 9947436
SSP1415	Steering Tie Rod End - Front Left	M12x1,5Rht	60806356; 9947439; 9947438



FIAT BRAVO II 198



04/2007-

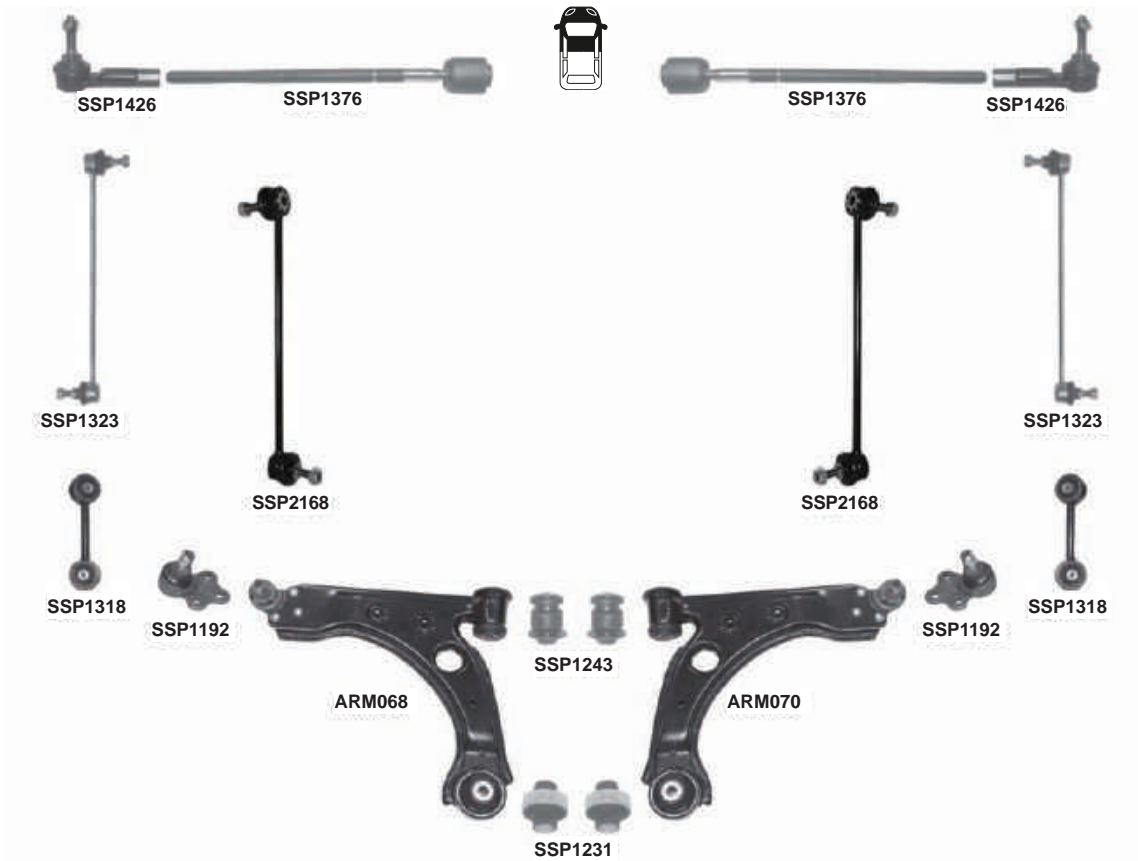

PART NO.	DESCRIPTION	NOTES	O.E.
ARM068	301181306800	Suspension Control Arm and Ball Joint Assembly - Front Left Lower	50705464; 51827736
ARM070	301181307000	Suspension Control Arm and Ball Joint Assembly - Front Right Lower	50705465; 51827737
SSP1192	301181311920	Suspension Ball Joint - Front Lower	50706463
SSP1231	301181312310	Bush / Silent block - Track control arm	ARM017 / ARM018 / ARM070 / ARM068 / ARM153 / ARM154 50700778
SSP1243	301181312430	Bush / Silent block - Track control arm	ARM070 / ARM068 / ARM153 / ARM154
SSP1318	301181313180	Suspension Stabilizer Bar Link - Front	Only : 1.9 JTD 46549529; 46739116
SSP1323	301181313230	Suspension Stabilizer Bar Link - Front	L=290mm 50700464; 51801136
SSP1376	301181313760	Steering Tie Rod - Front	M14x1,5 - L=317mm 9949217
SSP1426	301181314260	Steering Tie Rod End - Front	M14x1,5 9949218
SSP2168	301191621680	Suspension Stabilizer Bar Link - Front	(Clip-on patented design) L=290mm 50700464; 51801136; 51795269



FIAT CINQUECENTO



1992-1998

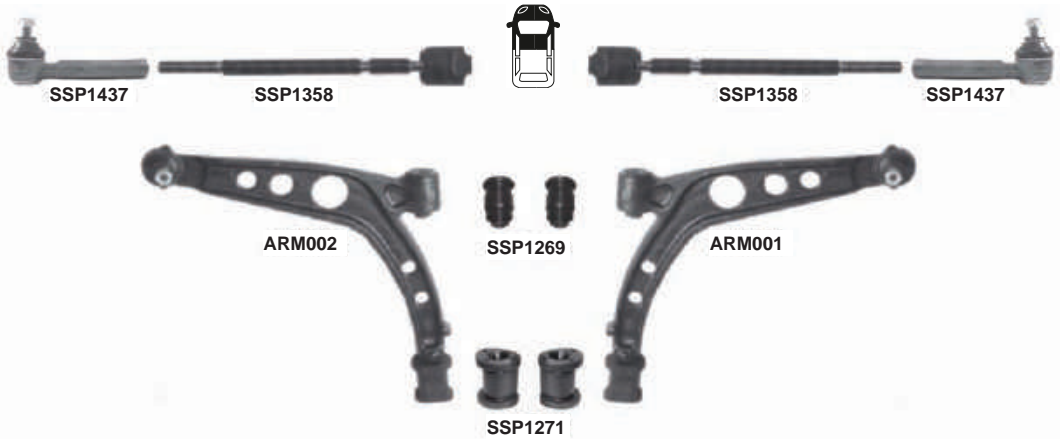

PART NO.	DESCRIPTION	NOTES	O.E.
ARM001	301181300100 Suspension Control Arm and Ball Joint Assembly - Front Right Lower	Lower	7636996
ARM002	301181300200 Suspension Control Arm and Ball Joint Assembly - Front Left	Lower	7636995
SSP1269	301181312690 Bush / Silent block - Track control arm	ARM001 / ARM002 / ARM009 / ARM010 / ARM029 / ARM030	7673581
SSP1271	301181312710 Bush / Silent block - Track control arm	ARM001 / ARM002 / ARM009 / ARM010	5927293, 7673582
SSP1358	301181313580 Steering Tie Rod - Front	M12x1,5 - L=285mm	7658273
SSP1437	301181314370 Steering Tie Rod End - Front	M12x1,5Rht	5960036; SE022162406A; 7669756; 5960056; 5960037



FIAT COUPE FA-175



11/1993-2000

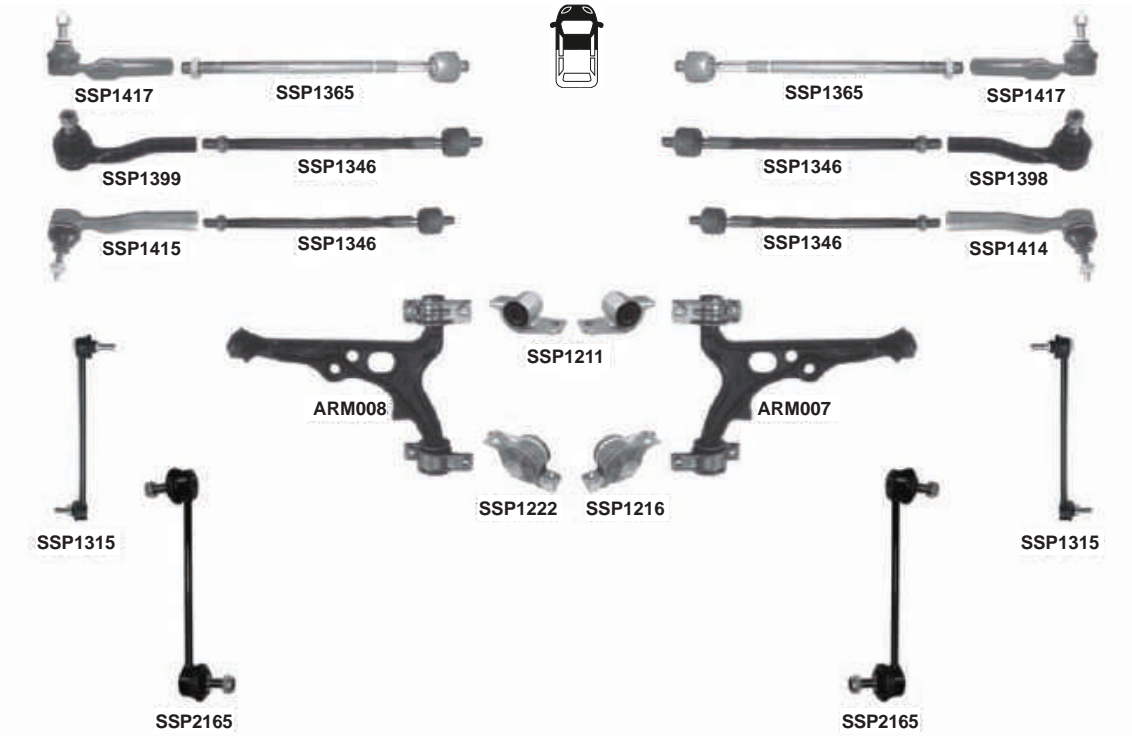

PART NO.	DESCRIPTION	NOTES	O.E.
ARM007	301181300700 Suspension Control Arm and Ball Joint Assembly - Front Right	D=Ø17mm	46456050; 60809814; 60586772
ARM008	301181300800 Suspension Control Arm and Ball Joint Assembly - Front Left Lower	D=Ø17mm	46456049; 60809813; 60586771
SSP1211	301181312110 Bush / Silent block - Track control arm	ARM008 / ARM007 / ARM041 / ARM042 / ARM155 / ARM156- D=Ø20,9mm Center: 83mm	7601064
SSP1216	301181312160 Bush / Silent block - Track control arm - Rear Rh	ARM007 / ARM041 / ARM155	7601065
SSP1222	301181312220 Bush / Silent block - Track control arm - Rear Lh	ARM008 / ARM042 / ARM156	7601068
SSP1315	301181313150 Suspension Stabilizer Bar Link - Front	L=274,5mm	46413122; 51701045
SSP1346	301181313460 Steering Tie Rod - Front Inner	Power Steering Only: 1.7,2.0 M12x1,5 Rht - L=285mm	9944452
SSP1365	301181313650 Steering Tie Rod - Front Inner	M14x1,5Rht - L=309.3mm	9947713
SSP1398	301181313980 Steering Tie Rod End - Front Right Outer	Coupe 2.0 Year M12x1,5Rth	60565705; 7678717
SSP1399	301181313990 Steering Tie Rod End - Front Left Outer	M12x1,5Rth	60565706; 9947437; 7678718; 9947435
SSP1414	301181314140 Steering Tie Rod End - Front Right	Only: 1.7,2.0 M12x1,5Rht	60806355; 9947438; 9947436
SSP1415	301181314150 Steering Tie Rod End - Front Left	Only: 1.7,2.0 M12x1,5Rht	60806356; 9947439; 9947438
SSP1417	301181314170 Steering Tie Rod End - Front	Only: Coupe 1.7,2.0cc M14x1,5Rht	46527567; 9947719; 9947714; 98845030
SSP2165	301191621650 Suspension Stabilizer Bar Link - Front	(Clip-on patented design) L=274,5mm	46413122*



FIAT CROMA 154



12/1985-12/1996



PART NO.	DESCRIPTION	NOTES	O.E.
SSP1362 301181313620	Steering Tie Rod - Front Inner	Power Steering Only:Croma M12x1,5 L=277mm	9941625



FIAT CROMA 194 1.9DMULTIJET



06/2005-2011

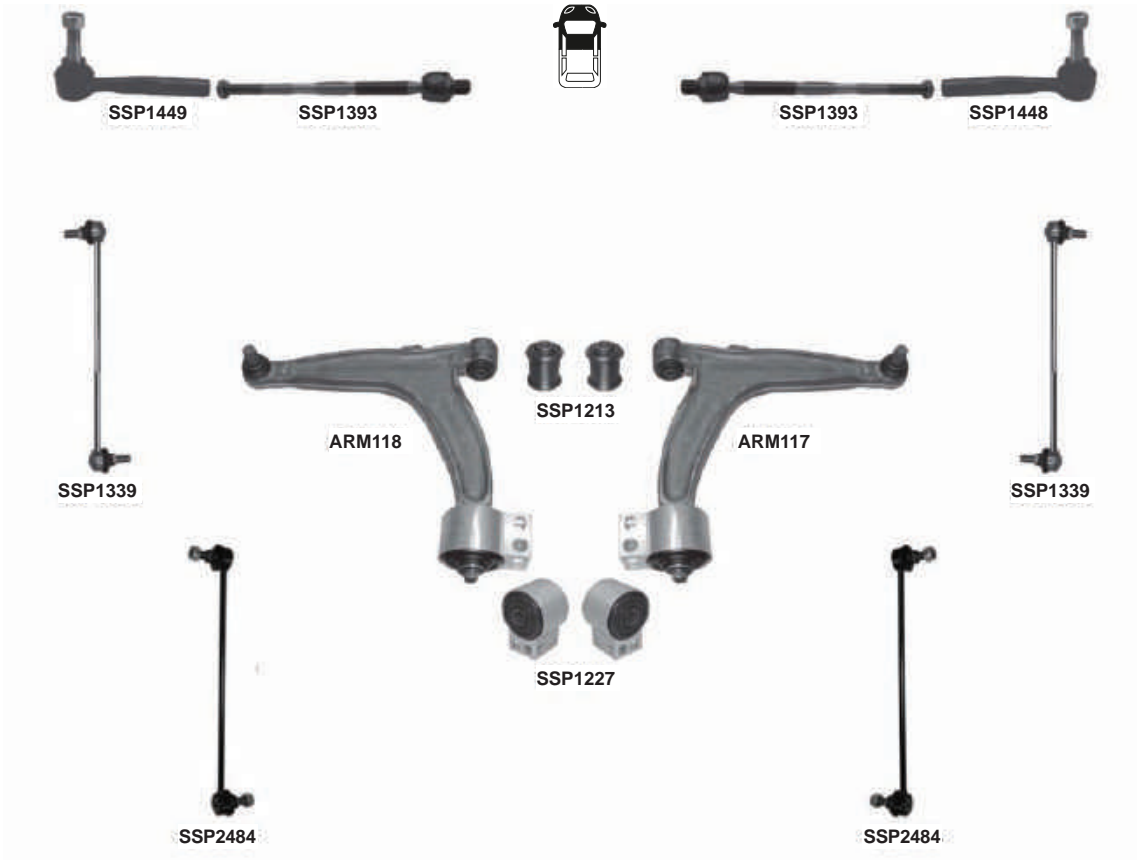

PART NO.	DESCRIPTION	NOTES	O.E.
ARM117	301181311700 Suspension Control Arm and Ball Joint Assembly - Front Right Lower		352052; 51748652; 12799200; 12796014
ARM118	301181311800 Suspension Control Arm and Ball Joint Assembly - Front Left Lower		352051; 51748653; 12799200; 12796013
SSP1213	301181312130 Bush / Silent block - Track control arm	ARM117 / ARM 118	"352357, 352364, 4566899, 6140350007, 90468636"
SSP1227	301181312270 Bush / Silent block - Track control arm	ARM117 / ARM 118	352319, 93171448
SSP1339	301181313390 Suspension Stabilizer Bar Link - Front	L=352,5mm	24417251; 51741130; 350603
SSP1393	301181313930 Steering Tie Rod - Front Inner	M14x1,5 - L=284mm	1603229; 93172256
SSP1448	301181314480 Steering Tie Rod End - Front Right	M14x1,5Rht	1603228; 5239322; 5235668
SSP1449	301181314490 Steering Tie Rod End - Front Left	M14x1,5Rht	1603227; 5239314; 5235650
SSP2484	301191624840 Suspension Stabilizer Bar Link - Front	(Clip-on patented design) L=352,5mm	350603; 24417251; 350615



FIAT DOBLO 119

 03/2001-01/2010





FIAT DOBLO 119



03/2001-01/2010

PART NO.	DESCRIPTION	NOTES	O.E.
ARM111	301181311100 Suspension Control Arm and Ball Joint Assembly - Front Right Lower	Doblo	46777741; 51866700; 51769073; 51712407; 46794065
ARM112	301181311200 Suspension Control Arm and Ball Joint Assembly - Front Left Lower	Doblo	46777742; 51769074; 51712408; 46794066
ARM113	301181311300 Suspension Control Arm and Ball Joint Assembly - Front Right Lower	Only : 1,9JTD	51727863; 98810139
ARM114	301181311400 Suspension Control Arm and Ball Joint Assembly - Front Left Lower	Only : 1,9JTD	51769076; 98810140
ARM135	301181313500 Suspension Control Arm and Ball Joint Assembly - Front Right Lower		51772988
ARM136	301181313600 Suspension Control Arm and Ball Joint Assembly - Front Left Lower		51772992
SSP1193	301181311930 Suspension Ball Joint - Front Lower		46543045; 7081835
SSP1194	301181311940 Suspension Ball Joint - Front	Doblo	46779293; 7082812; 46842581
SSP1217	301181312170 "Bush / Silent block - Track control arm - Rear Rh"	ARM111 / ARM135 only: Doblo -> 07/2006	46748579
SSP1218	301181312180 "Bush / Silent block - Track control arm - Rear Lh"	ARM112 / ARM136 only: Doblo -> 07/2006	46748578
SSP1251	301181312510 Bush / Silent block - Track control arm - Rh	ARM113	
SSP1252	301181312520 Bush / Silent block - Track control arm - Lh	ARM114	
SSP1283	301181312830 Bush / Silent block - Track control arm	ARM015 / ARM016 / ARM111 / ARM112 / ARM113 / ARM114 / ARM133 / ARM134 / ARM135 / ARM136 / ARM147 / ARM148	46421552
SSP1321	301181313210 Suspension Stabilizer Bar Link - Rear	L=118mm	46767267; 51717000
SSP1322	301181313220 Suspension Stabilizer Bar Link - Rear	L=132mm	46799278; 51717001
SSP1374	301181313740 Steering Tie Rod - Front	M14x1,5 - L=332mm	98845024
SSP1375	301181313750 Steering Tie Rod - Front	Only: 1.9 JTD M14x1,5 - L=293mm	98845026
SSP1417	301181314170 Steering Tie Rod End - Front	M14x1,5Rht	46527567; 9947719; 9947714; 98845030
SSP1424	301181314240 Steering Tie Rod End - Front Right	Only:Doblo 1.9 JTD M14x1,5Rht	46456660; 98845031
SSP1425	301181314250 Steering Tie Rod End - Front Left	Only:Doblo 1.9 JTD M14x1,5Rht	46456189; 98845032



FIAT DOBLO II 152



02/2010-

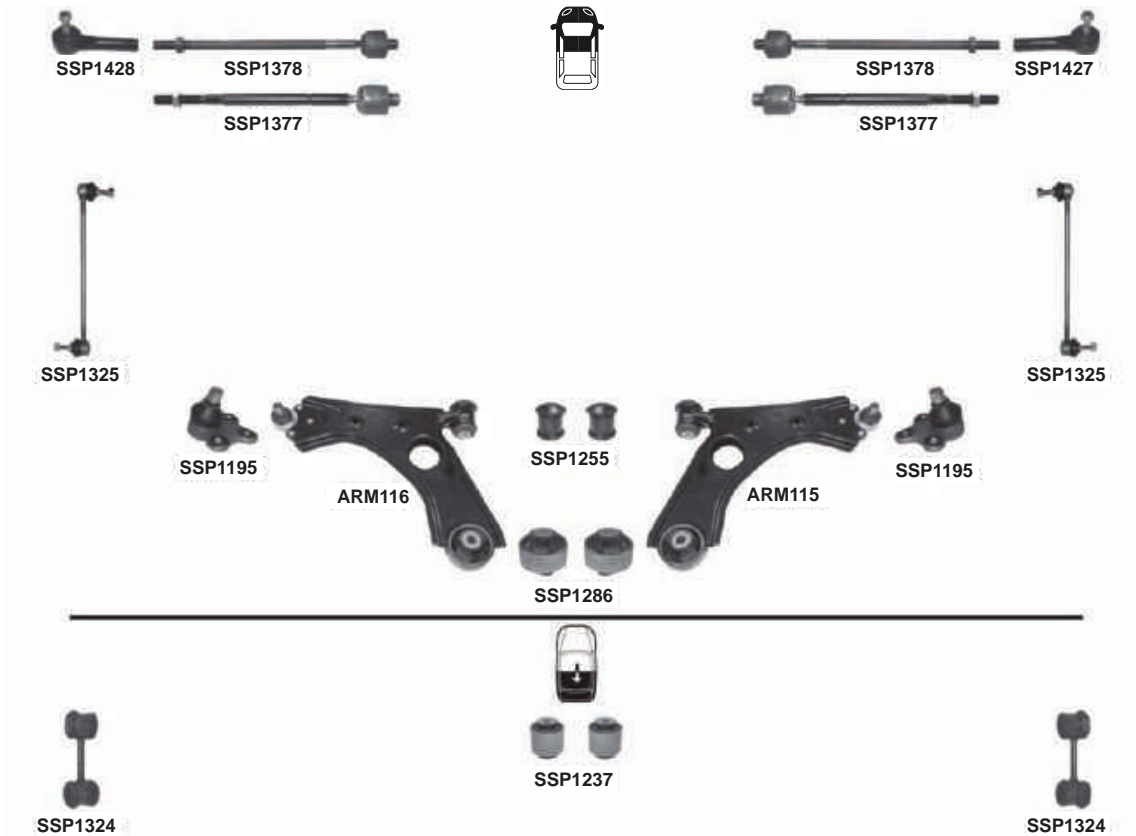

PART NO.	DESCRIPTION	NOTES	O.E.
ARM115	Suspension Control Arm and Ball Joint Assembly - Front Right Lower		51810664
ARM116	Suspension Control Arm and Ball Joint Assembly - Front Left Lower		51810665
SSP1195	Suspension Ball Joint - Front Lower	Ø18mm	Part Of:51810664/665
SSP1237	Stabilizer link bush - Rear		
SSP1255	Bush / Silent block - Track control arm	ARM115 / ARM116 / ARM058 / ARM059	0352380, 55703232
SSP1286	Bush / Silent block - Track control arm	ARM115 / ARM116	
SSP1324	Suspension Stabilizer Bar Link - Rear	L=86mm	51810124*
SSP1325	Suspension Stabilizer Bar Link - Front	L=297mm	350198; 95511247; 51898527; 51848645
SSP1377	Steering Tie Rod - Front	M14x1,5 - L=300mm (18x1,5 mm)	26144989
SSP1378	Steering Tie Rod - Front	M14x1,5 - L=302mm (16x1,5 mm)	98845878
SSP1427	Steering Tie Rod End - Front Right	M14x1,5	77365224
SSP1428	Steering Tie Rod End - Front Left	M14x1,5	77365223



FIAT DUCATO 10Q-14Q-1.8Q



1994-04/2002

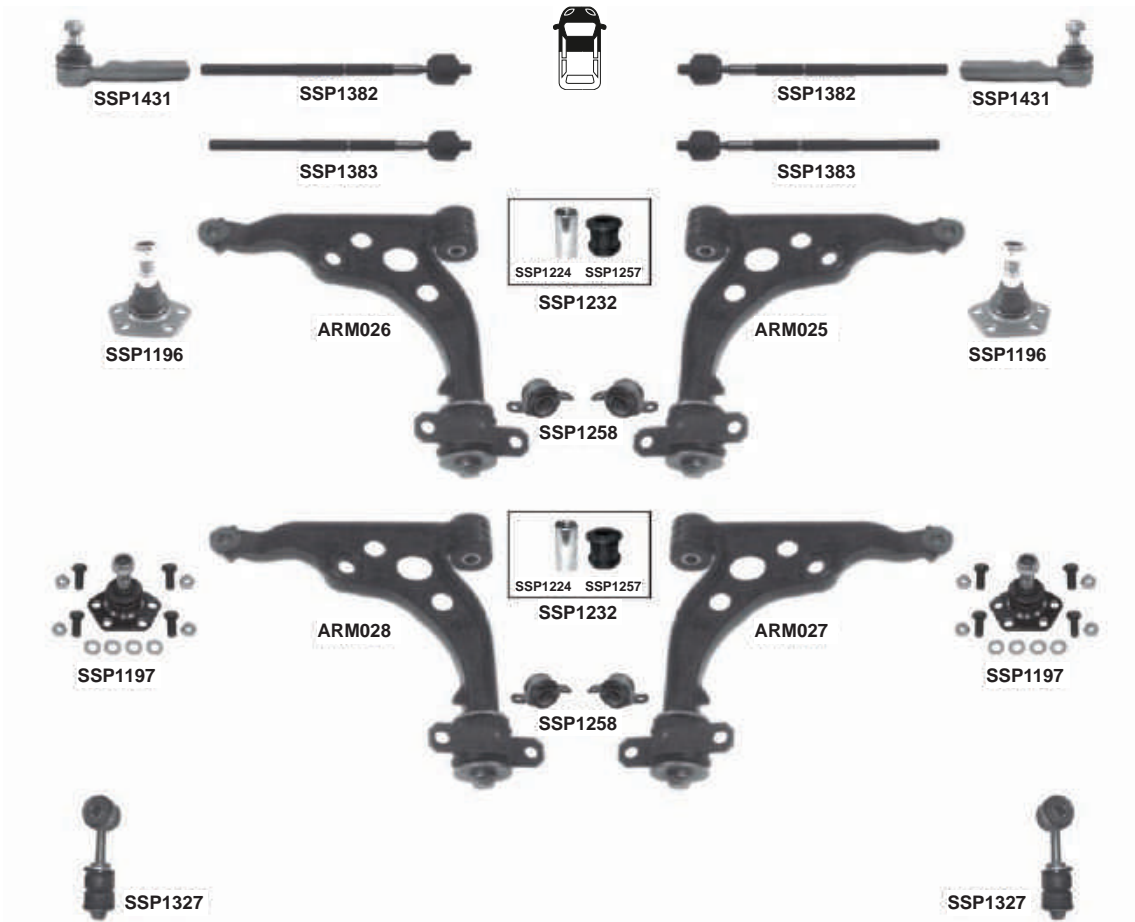

PART NO.	DESCRIPTION	NOTES	O.E.
ARM025	Suspension Control Arm - Front Right Lower	Only: 1,4Q	1308601080; 3521.65; 1317241080
ARM026	Suspension Control Arm - Front Left Lower	Only: 1,4Q	1308600080; 3520.95; 1317240080
ARM027	Suspension Control Arm - Front Right Lower	Only: 1,8Q	1308760080; 3521.66; 1317239080
ARM028	Suspension Control Arm - Front Left Lower	Only: 1,8Q	1308759080; 3520.96; 1317238080
SSP1196	Suspension Ball Joint - Front Lower	Only : 1,4Q	1302368080; 3640.32
SSP1197	Suspension Ball Joint - Front Lower	Only : 1,8Q	1300473080; 542410095; 3640.33
SSP1224	Bush / Silent block - Track control arm	ARM025 / ARM026 / ARM027 / ARM028	
SSP1232	Bush / Silent block kit - Track control arm	ARM025 / ARM026 / ARM027 / ARM028	
SSP1257	Bush / Silent block - Track control arm	ARM025 / ARM026 / ARM027 / ARM028	1300507080
SSP1258	Bush / Silent block - Track control arm	ARM025 / ARM026 / ARM027 / ARM028	1308694080, 1338373080, 3523.94
SSP1327	Suspension Stabilizer Bar Link - Front	L=134mm	1300716080; 5087.37
SSP1382	Steering Tie Rod - Front	Manual Steering M16x1,5Rht - L=318mm	1471654080; 9945836; 9945385; 4018.A4
SSP1383	Steering Tie Rod - Front	Power Steering M16x1,5Rht - L=318mm	4006.24; 9945836
SSP1431	Steering Tie Rod End - Front	M16x1,5Rht	1306716080; 4018.A3; 1471655080



FIAT DUCATO 14Q-1.8Q



05/2002-05/2006

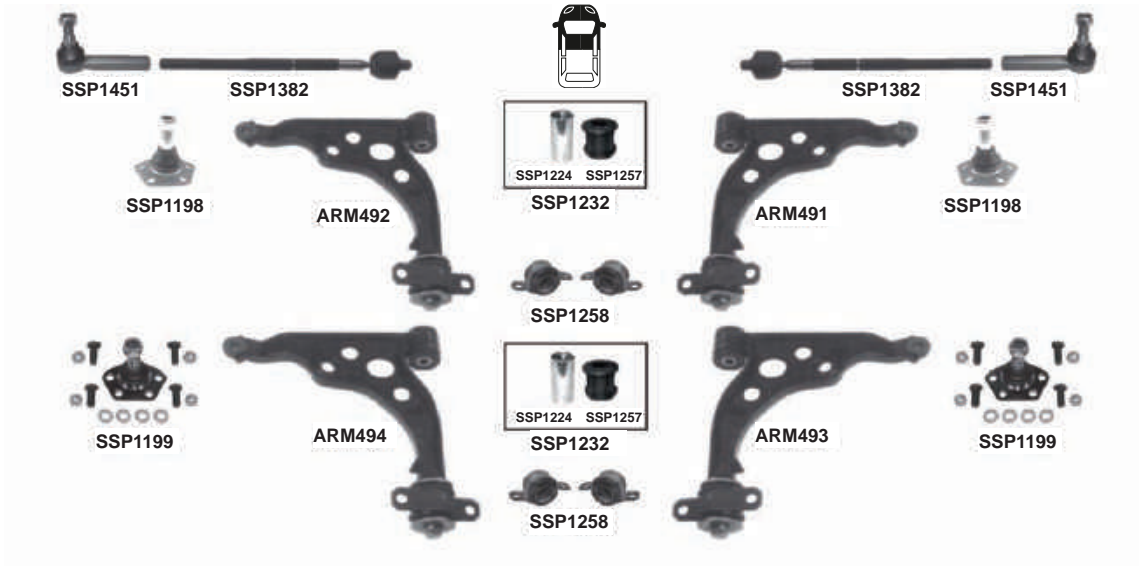

PART NO.	DESCRIPTION	NOTES	O.E.
ARM491	Suspension Control Arm - Front Right Lower	Only:1,4Q	1331940080; 3521.J3; 3521.H2
ARM492	Suspension Control Arm - Front Left Lower	Only:1,4Q	1331938080; 3520.N3; 3520.L0
ARM493	Suspension Control Arm - Front Right Lower	Only:1,8Q	1339460080; 3521.J4; 3521.H3
ARM494	Suspension Control Arm - Front Left Lower	Only:1,8Q	1331937080; 3520.N4; 3520.L1
SSP1198	Suspension Ball Joint - Front Lower	Only : 1.4Q	1302368080; 3640.55; 1331640080
SSP1199	Suspension Ball Joint - Front Lower	Only : 1,8Q	1300473080; 3640.54; 1331641080
SSP1224	Bush / Silent block - Track control arm	ARM025 / ARM026 / ARM027 / ARM028	
SSP1232	Bush / Silent block kit - Track control arm	ARM025 / ARM026 / ARM027 / ARM028	
SSP1257	Bush / Silent block - Track control arm	ARM025 / ARM026 / ARM027 / ARM028	1300507080
SSP1258	Bush / Silent block - Track control arm	ARM025 / ARM026 / ARM027 / ARM028	1308694080, 1338373080, 3523.94
SSP1382	Steering Tie Rod - Front	Manual Steering M16x1,5Rht - L=318mm	1471654080; 9945836; 9945385; 4018.A4
SSP1451	Steering Tie Rod End - Front	M16x1,5Rht	4018.E0; 77362278



FIAT DUCATO



06/2006-2016

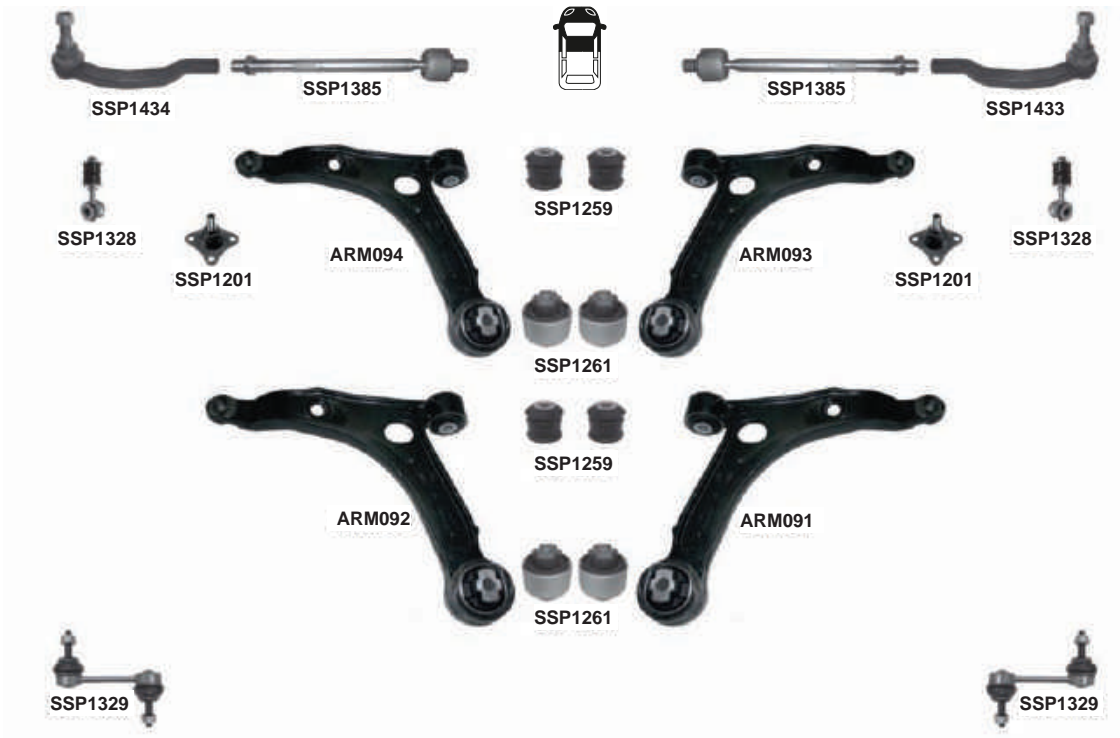

	PART NO.	DESCRIPTION	NOTES	O.E.
ARM091	301181309100	Suspension Control Arm - Front Right Lower	Only :1.1Q-1.5Q-1.7Q	1352225080; 3521.P1
ARM092	301181309200	Suspension Control Arm - Front Left	Only :1.1Q-1.5Q-1.7Q	1352227080; 3520.S0
ARM093	301181309300	Suspension Control Arm - Front Right Lower	Only :1.7H - 2.0Q	1352226080; 3521.P2
ARM094	301181309400	Suspension Control Arm - Front Left	Only :1.7H - 2.0Q	1352228080; 3520.S1
SSP1201	301181312010	Suspension Ball Joint - Front Lower		3640.67; 9351837; 50705629; 3640.76
SSP1259	301181312590	Bush / Silent block - Track control arm	ARM091 / ARM092 / ARM093 / ARM094	
SSP1261	301181312610	Bush / Silent block - Track control arm	ARM091 / ARM092 / ARM093 / ARM094	
SSP1328	301181313280	Suspension Stabilizer Bar Link - Front	L=112mm	1357572080*
SSP1329	301181313290	Suspension Stabilizer Bar Link - Rear	L=100mm	1355440080; 5170.F5; 1355449080
SSP1385	301181313850	Steering Tie Rod - Front	M16x1,5 - L=260 mm	1341 021 080; 4001.E4; 4001.E5; 16 077 445 80; 1359 226 080; 1345 854 080
SSP1433	301181314330	Steering Tie Rod End - Front Right	M16x1,5	3817.70; 77364009
SSP1434	301181314340	Steering Tie Rod End - Front Left	M16x1,5	3817.77; 77364253



FIAT DUNA



1987-1991



ARM472



ARM472

PART NO.	DESCRIPTION	NOTES	O.E.
ARM472 301181347200	Suspension Control Arm and Ball Joint Assembly - Front	With Silent Block (10mm)	7543760; 7674825; 7591277



FIAT EGEA 356, TIPO



10/2015-

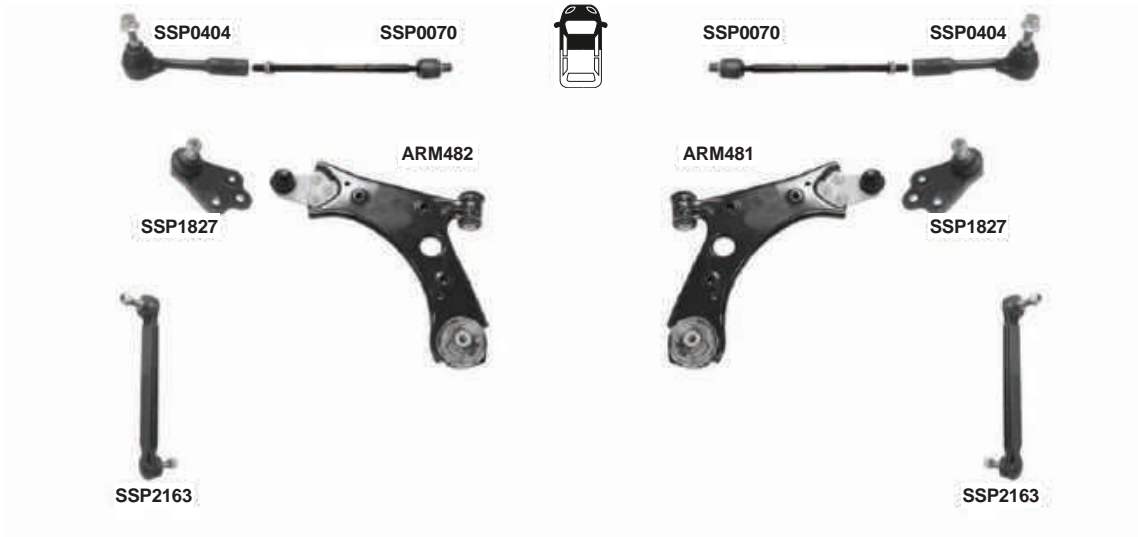

	PART NO.	DESCRIPTION	NOTES	O.E.
ARM481	301181348100	Suspension Control Arm and Ball Joint Assembly - Front Right		52011612
ARM482	301181348200	Suspension Control Arm and Ball Joint Assembly - Front Left		52011614
SSP0070	301191600700	Steering Tie Rod - Front	B= M14x1.5	Part of 52014014
SSP0404	301191604040	Steering Tie Rod End - Front	M14X1.5	77367379
SSP1827	301191618270	Suspension Ball Joint - Front Lower		52026562
SSP2163	301191621630	Suspension Stabilizer Bar Link - Front		51939949



FIAT FIORINO



1988-1993



ARM472



ARM472

PART NO.	DESCRIPTION	NOTES	O.E.
ARM472 301181347200	Suspension Control Arm and Ball Joint Assembly - Front	With Silent Block (10mm)	7543760; 7674825; 7591277

**FIAT FIORINO NUOVA**

1988-1998

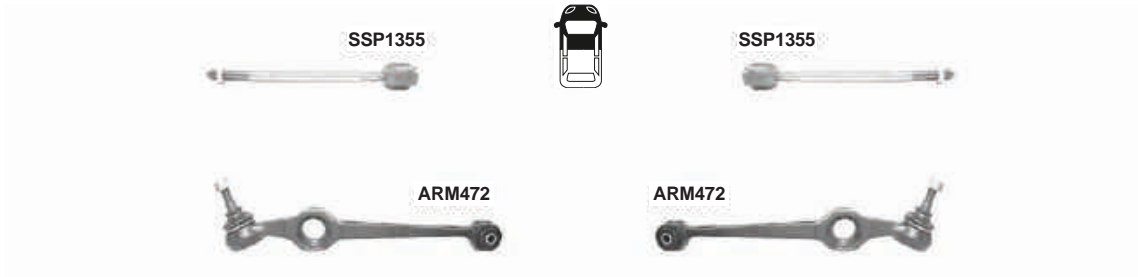

	PART NO.	DESCRIPTION	NOTES	O.E.
ARM472	301181347200	Suspension Control Arm and Ball Joint Assembly - Front	With Silent Block (10mm)	7543760; 7674825; 7591277
SSP1355	301181313550	Steering Tie Rod - Front	M14x1,5 - L=217mm	7076231



FIAT FIORINO



2008-

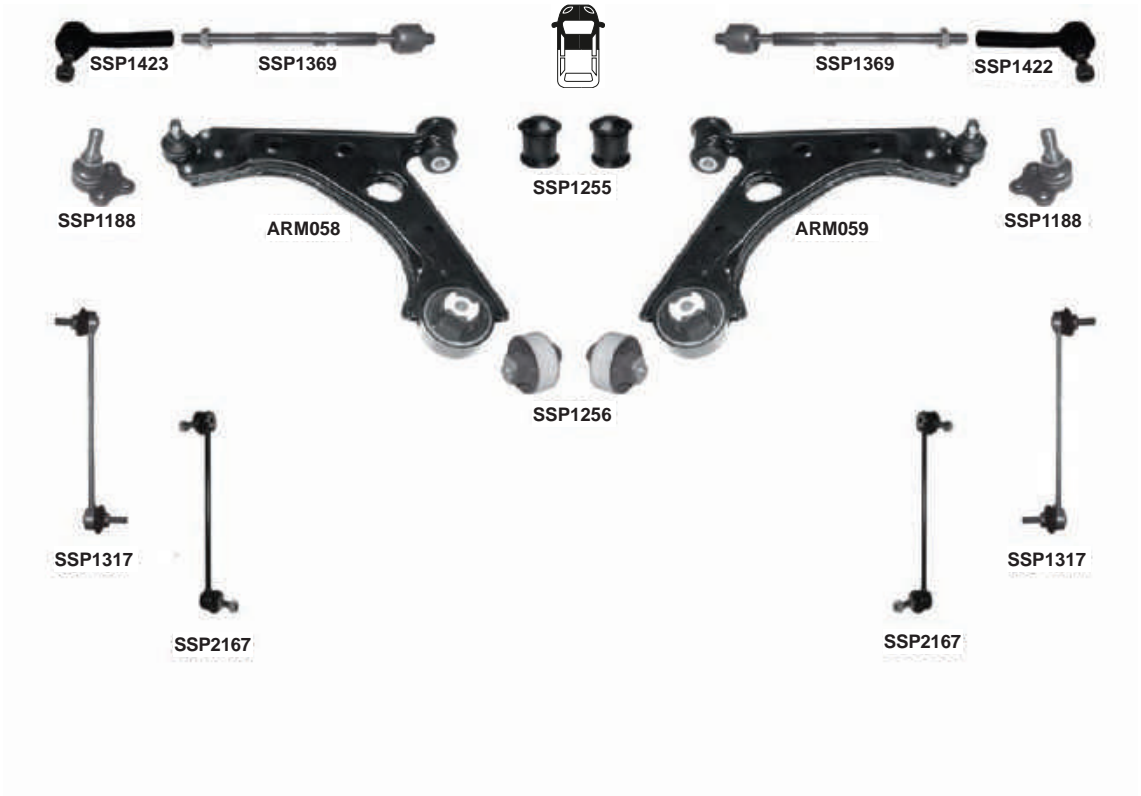

PART NO.	DESCRIPTION	NOTES	O.E.
ARM058	301181305800	Suspension Control Arm and Ball Joint Assembly - Front Left Lower	3520.W3; 55703629; 51895367; 51783057; 3520.Y4
ARM059	301181305900	Suspension Control Arm and Ball Joint Assembly - Front Right Lower	3521.S6; 55703627; 51895366; 51783056; 3521V5
SSP1188	301181311880	Suspension Ball Joint - Front	3520.87; 93190907; 51783057; 51783056; 3520.W3
SSP1255	301181312550	Bush / Silent block - Track control arm	ARM058 / ARM059 / ARM115 / ARM116 0352380, 55703232
SSP1256	301181312560	Bush / Silent block - Track control arm - Rear	ARM058 / ARM059 55700751
SSP1317	301181313170	Suspension Stabilizer Bar Link - Front	L=290mm 5080.70; 51815479; 5087.65
SSP1369	301181313690	Steering Tie Rod - Front	M14X1,5 - L=274mm 55172401
SSP1422	301181314220	Steering Tie Rod End - Front Right	M14x1,5 3817.87; 77364569
SSP1423	301181314230	Steering Tie Rod End - Front Left	M14x1,5 3817.86; 77364568
SSP2167	301191621670	Suspension Stabilizer Bar Link - Front	(Clip-on patented design) L=290mm 5087.65; 51815479; 5087.70



FIAT FREEMONT (JC)



08/2011-

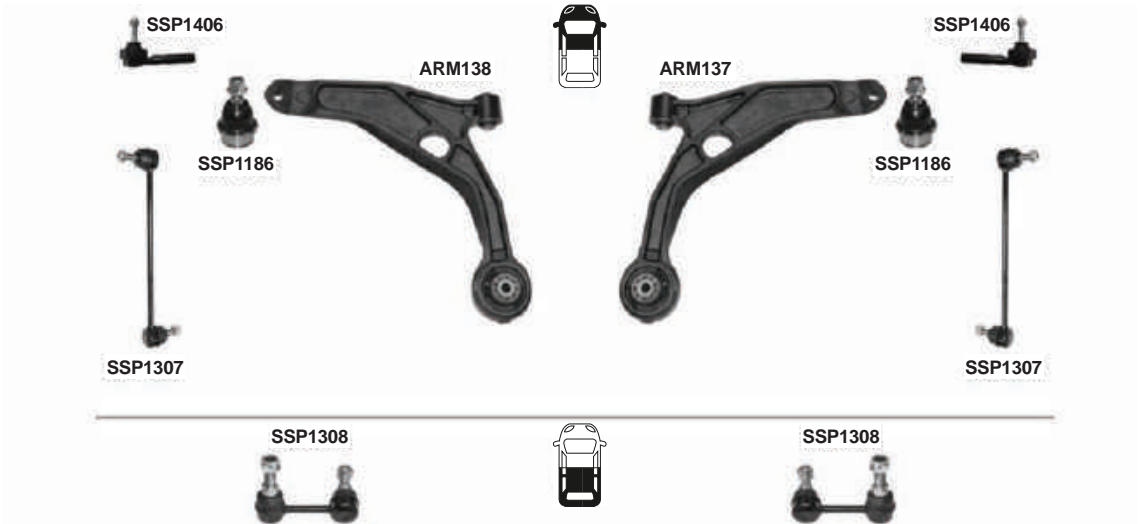

PART NO.	DESCRIPTION	NOTES	O.E.
ARM137 301181313700	Suspension Control Arm - Front Right		K04766424AA; K04766424AE; K04766424AD; K04766424AC; K04766424AB
ARM138 301181313800	Suspension Control Arm - Front Left		K04766423AA; K04766423AE; K04766423AD; K04766423AC; K04766423AB
SSP1186 301181311860	Suspension Ball Joint - Front Lower		K05090033AB; 5090033AB
SSP1307 301181313070	Suspension Stabilizer Bar Link - Front	L=265mm	K04766962AA
SSP1308 301181313080	Suspension Stabilizer Bar Link - Rear	L=80mm	K04766435AA; K68052655AA
SSP1406 301181314060	Steering Tie Rod End - Front	M14x1,5	05066373AB; K05183761AA; ES3008RL; 5183761AA; 05183761AD

FIAT GRANDE PUNTO 199



10/2005-2012

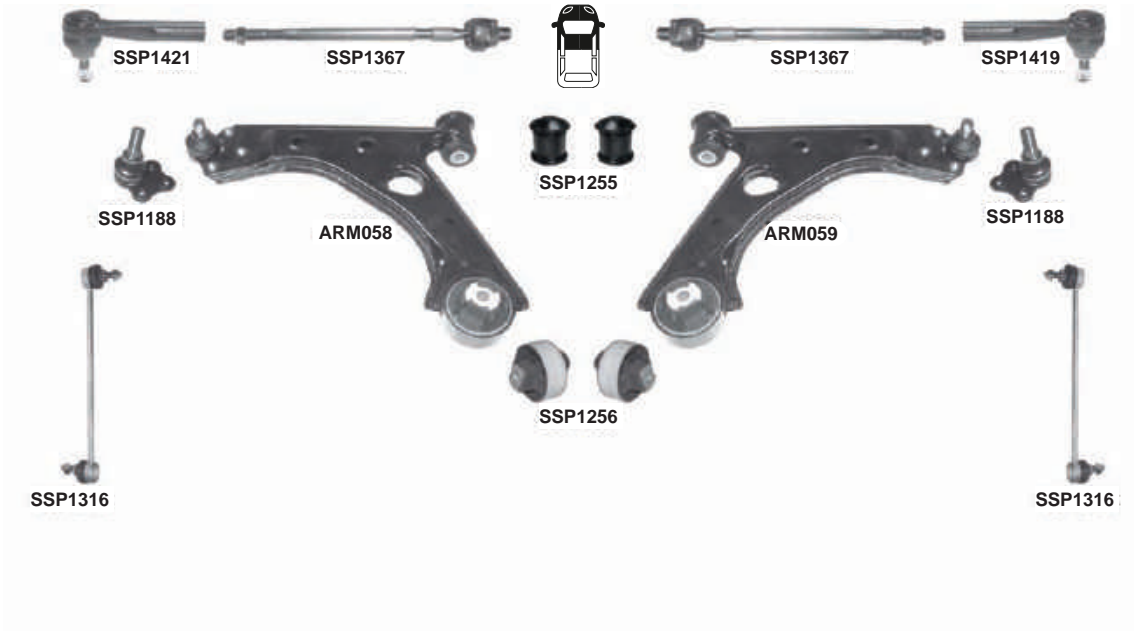

PART NO.	DESCRIPTION	NOTES	O.E.
ARM058	301181305800 Suspension Control Arm and Ball Joint Assembly - Front Left Lower		3520.W3; 55703629; 51895367; 51783057; 3520.Y4
ARM059	301181305900 Suspension Control Arm and Ball Joint Assembly - Front Right Lower		3521.S6; 55703627; 51895366; 51783056; 3521V5
SSP1188	301181311880 Suspension Ball Joint - Front		3520.87; 93190907; 51783057; 51783056; 3520.W3
SSP1255	301181312550 Bush / Silent block - Track control arm	ARM058 / ARM059 / ARM115 / ARM116	0352380, 55703232
SSP1256	301181312560 Bush / Silent block - Track control arm - Rear	ARM058 / ARM059	55700751
SSP1316	301181313160 Suspension Stabilizer Bar Link - Front	L=300mm	350616; 55700753; 50515276
SSP1367	301181313670 Steering Tie Rod - Front	M14x1,5Rht - L=295mm	1609211; 9950452; 9944452; 93196540
SSP1419	301181314190 Steering Tie Rod End - Front Right	M14x1,5Rht	1603545; 77363830; 1609458
SSP1421	301181314210 Steering Tie Rod End - Front Left	M14x1,5Rht	1603544; 77363829; 1609457
SSP2166	301191621660 Suspension Stabilizer Bar Link - Front	(Clip-on patented design) L=300mm	55700753

**FIAT IDEA**

2003-2012

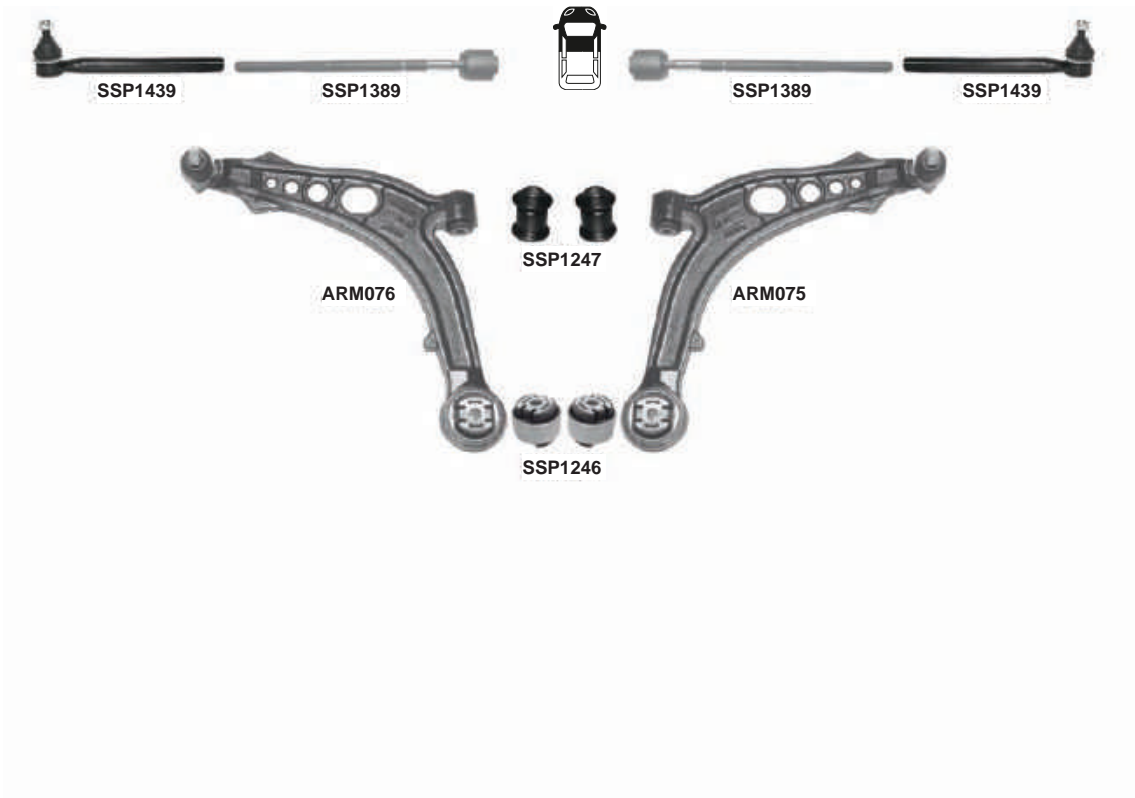

	PART NO.	DESCRIPTION	NOTES	O.E.
ARM075	301181307500	Suspension Control Arm and Ball Joint Assembly - Front Right Lower		50703231
ARM076	301181307600	Suspension Control Arm and Ball Joint Assembly - Front Left		50703232
SSP1246	301181312460	Bush / Silent block - Track control arm - Lower	ARM075 / ARM076 / ARM081 / ARM082	
SSP1247	301181312470	Bush / Silent block - Track control arm	ARM075 / ARM076	
SSP1389	301181313890	Steering Tie Rod - Front	M14x1,5 - L=258mm	77362502
SSP1439	301181314390	Steering Tie Rod End - Front	M14x1,5Rht	7362503; 77362503

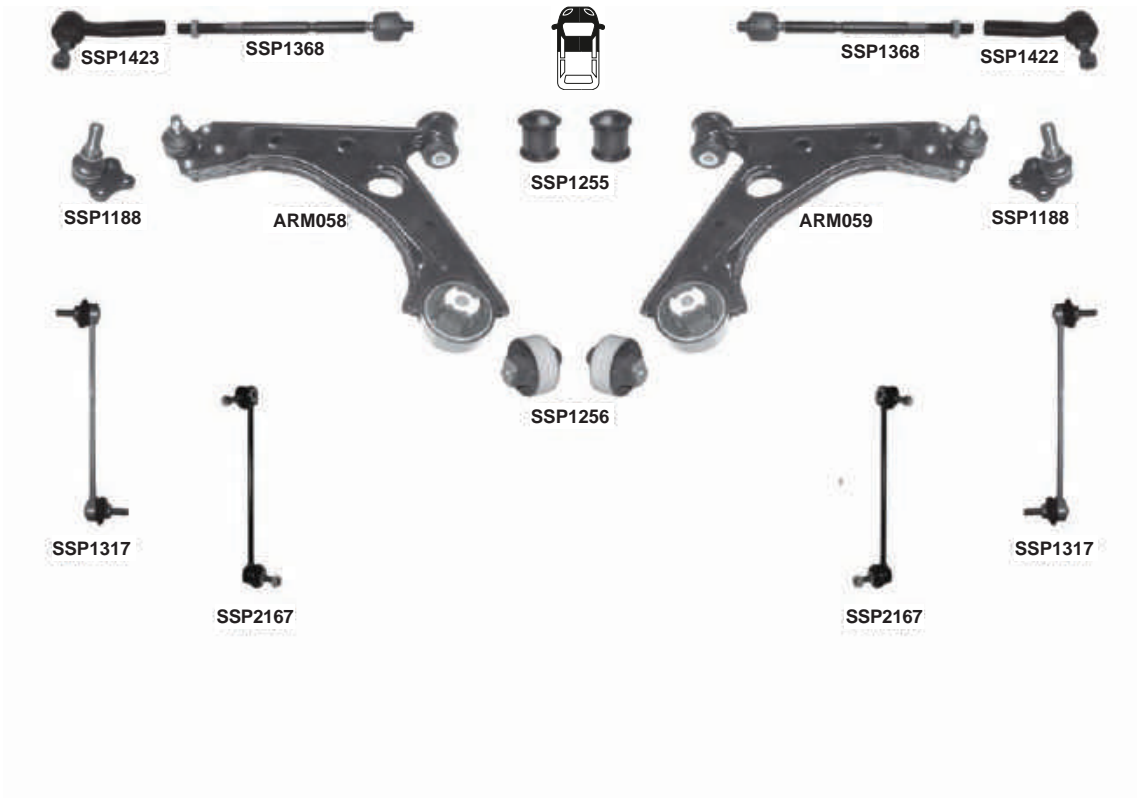

PART NO.	DESCRIPTION	NOTES	O.E.
ARM058	301181305800 Suspension Control Arm and Ball Joint Assembly - Front Left Lower		3520.W3; 55703629; 51895367; 51783057; 3520.Y4
ARM059	301181305900 Suspension Control Arm and Ball Joint Assembly - Front Right Lower		3521.S6; 55703627; 51895366; 51783056; 3521V5
SSP1188	301181311880 Suspension Ball Joint - Front		3520.87; 93190907; 51783057; 51783056; 3520.W3
SSP1255	301181312550 Bush / Silent block - Track control arm	ARM058 / ARM059 / ARM115 / ARM116	0352380, 55703232
SSP1256	301181312560 Bush / Silent block - Track control arm - Rear	ARM058 / ARM059	55700751
SSP1317	301181313170 Suspension Stabilizer Bar Link - Front	L=290mm	5080.70; 51815479; 5087.65
SSP1368	301181313680 Steering Tie Rod - Front	M14x1,5 - L=268,9mm	-
SSP1422	301181314220 Steering Tie Rod End - Front Right	M14x1,5	3817.87; 77364569
SSP1423	301181314230 Steering Tie Rod End - Front Left	M14x1,5	3817.86; 77364568
SSP2167	301191621670 Suspension Stabilizer Bar Link - Front	(Clip-on patented design) L=290mm	5087.65; 51815479; 5087.70



FIAT MAREA 185



06/1996-12/2007

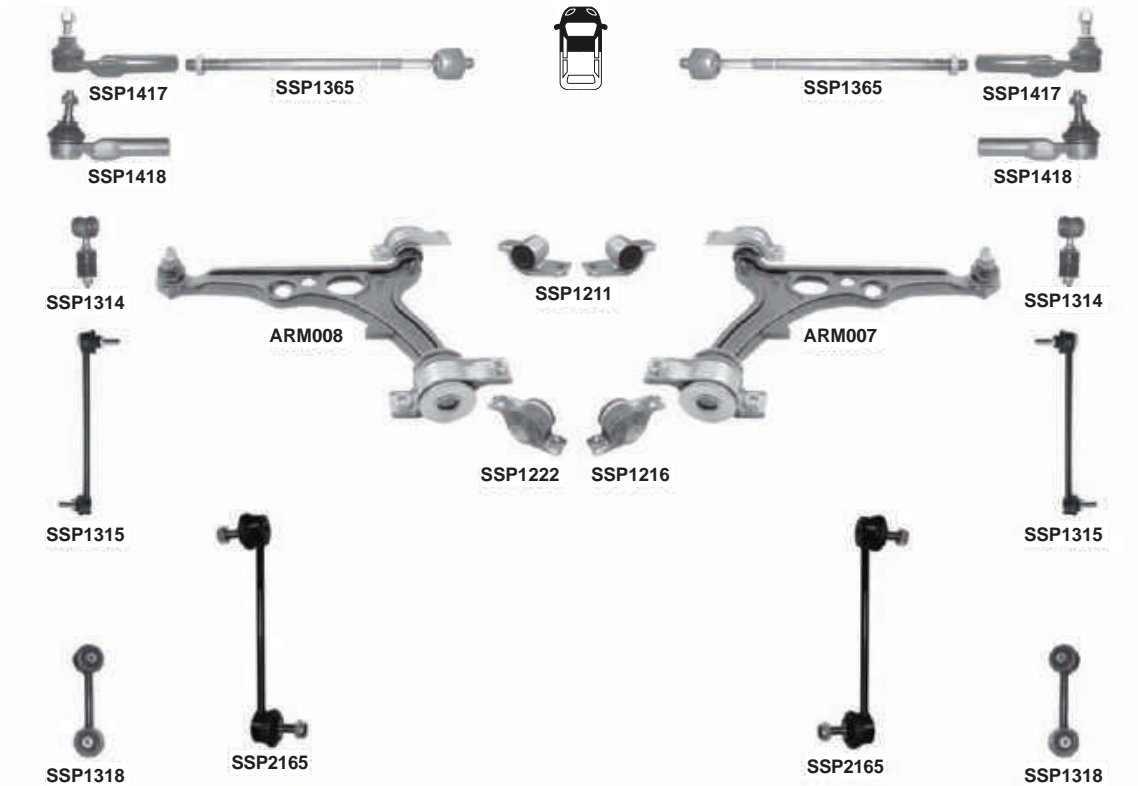

PART NO.	DESCRIPTION	NOTES	O.E.
ARM007 301181300700	Suspension Control Arm and Ball Joint Assembly - Front Right	D=Ø17mm	46456050; 60809814; 60586772
ARM008 301181300800	Suspension Control Arm and Ball Joint Assembly - Front Left Lower	D=Ø17mm	46456049; 60809813; 60586771
SSP1211 301181312110	Bush / Silent block - Track control arm	"ARM008 / ARM007 / ARM041 / ARM042 / ARM155 / ARM156 D=Ø20,9mm Center: 83mm"	7601064
SSP1216 301181312160	Bush / Silent block - Track control arm - Rear Rh	ARM007 / ARM041 / ARM155	7601065
SSP1222 301181312220	Bush / Silent block - Track control arm - Rear Lh	ARM008 / ARM042 / ARM156	7601068
SSP1314 301181313140	Suspension Stabilizer Bar Link - Front	M10x1,25Rht - L=114mm	12574521; 7601643; 7601642; 60570627
SSP1315 301181313150	Suspension Stabilizer Bar Link - Front	L=274,5mm	46413122; 51701045
SSP1318 301181313180	Suspension Stabilizer Bar Link - Front	Only : 1.9 JTD	46549529; 46739116
SSP1365 301181313650	Steering Tie Rod - Front Inner	M14x1,5Rht - L=309.3mm	9947713
SSP1417 301181314170	Steering Tie Rod End - Front	M14x1,5Rht	46527567; 9947719; 9947714; 98845030
SSP1418 301181314180	Steering Tie Rod End - Front	Only: 2.0 lt. M14x1,5Rht	46527567; 9947926; 9947719
SSP2165 301191621650	Suspension Stabilizer Bar Link - Front	(Clip-on patented design) L=274,5mm	46413122*



FIAT MULTIPLA

 04/1999-12/2010

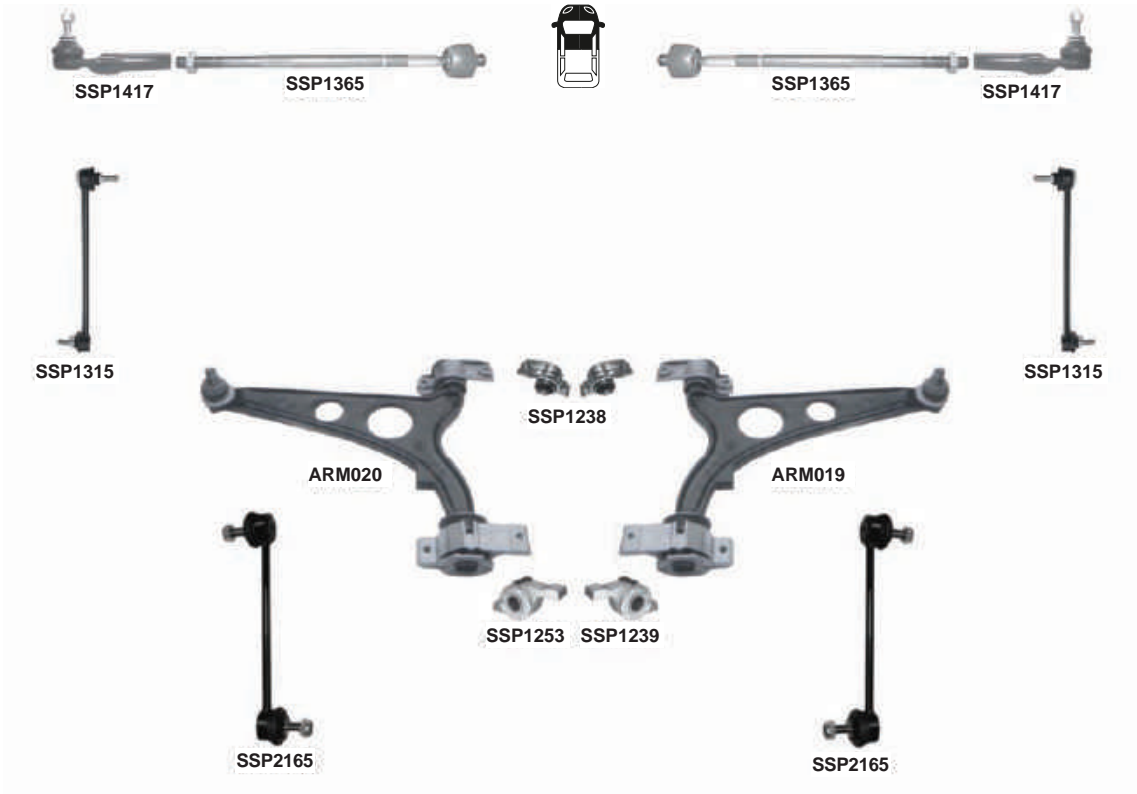

PART NO.	DESCRIPTION	NOTES	O.E.
ARM019	301181301900 Suspension Control Arm and Ball Joint Assembly - Front Right Lower		46522147; 46764747
ARM020	301181302000 Suspension Control Arm and Ball Joint Assembly - Front Left		46525407; 46764746
SSP1238	301181312380 Bush / Silent block - Track control arm	ARM019 / ARM020	46525407; 46764746
SSP1239	301181312390 Bush / Silent block - Track control arm - Rh	ARM003 / ARM019 Outer	
SSP1253	301181312530 Bush / Silent block - Track control arm - Lh	ARM004 / ARM020 Outer	
SSP1315	301181313150 Suspension Stabilizer Bar Link - Front	L=274,5mm	46413122; 51701045
SSP1365	301181313650 Steering Tie Rod - Front Inner	M14x1,5Rht - L=309.3mm	9947713
SSP1417	301181314170 Steering Tie Rod End - Front	M14x1,5Rht	46527567; 9947719; 9947714; 98845030
SSP2165	301191621650 Suspension Stabilizer Bar Link - Front	(Clip-on patented design) L=274,5mm	46413122*



FIAT PALIO - SIENA



04/1996-05/2013

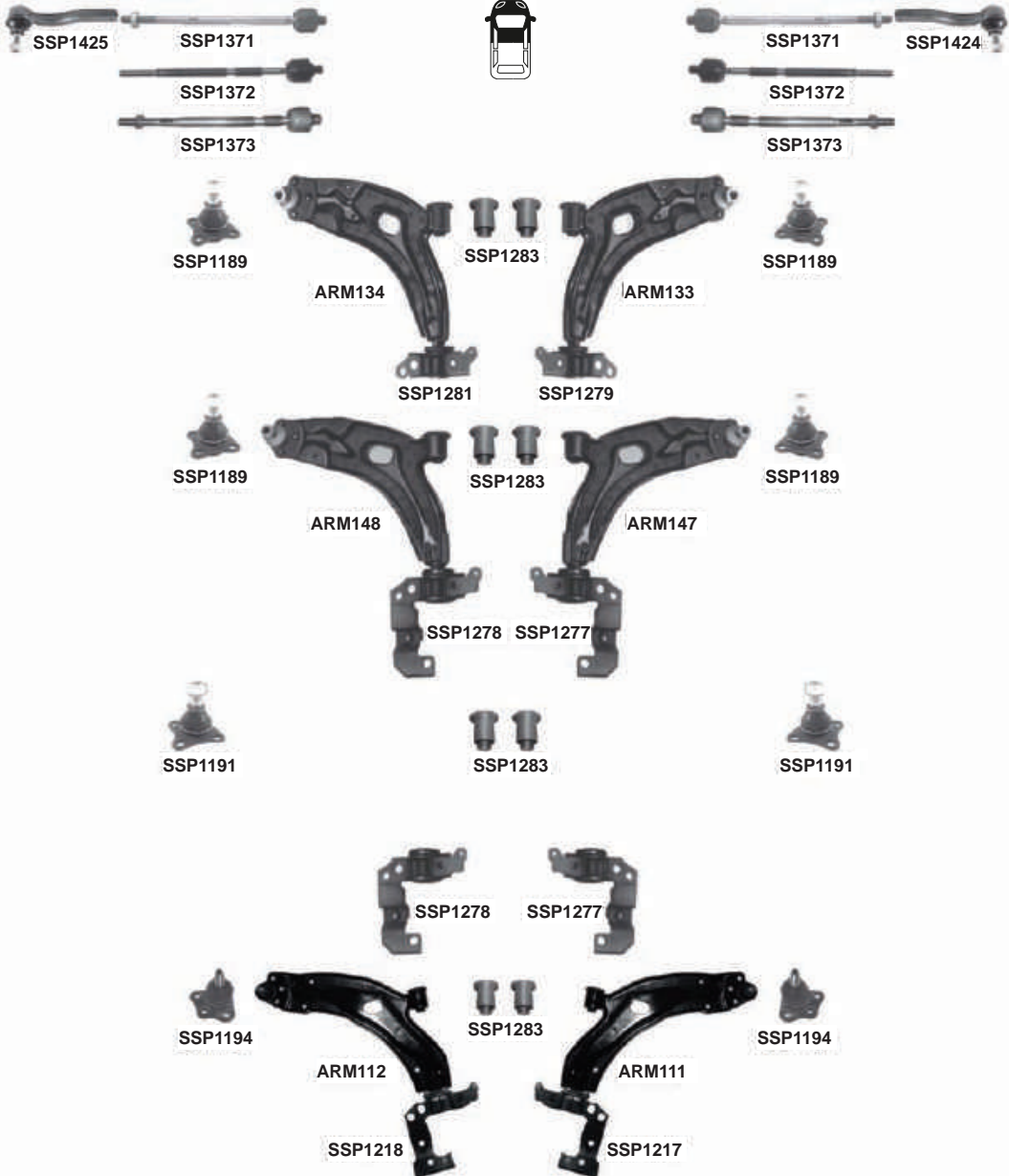



FIAT PALIO - SIENA



04/1996-05/2013

PART NO.	DESCRIPTION	NOTES	O.E.
ARM111	301181311100 Suspension Control Arm and Ball Joint Assembly - Front Right Lower		46777741; 51866700; 51769073; 51712407; 46794065
ARM112	301181311200 Suspension Control Arm and Ball Joint Assembly - Front Left Lower		46777742; 51769074; 51712408; 46794066
ARM133	301181313300 Suspension Control Arm and Ball Joint Assembly - Front Right Lower	Manual Steering	46454596
ARM134	301181313400 Suspension Control Arm and Ball Joint Assembly - Front Left Lower	Manual Steering	46454595
ARM147	301181314700 Suspension Control Arm and Ball Joint Assembly - Front Right Lower	Power St.	46454598
ARM148	301181314800 Suspension Control Arm and Ball Joint Assembly - Front Left Lower	Power St.	46454597
ARM489	301181348900 Suspension Control Arm and Ball Joint Assembly - Front Right Lower	Palio Weekend 1.2,16V	46539279; 46546777
ARM490	301181349000 Suspension Control Arm and Ball Joint Assembly - Front Left Lower	Palio Weekend 1.2,16V	46546278; 46546776
SSP1189	301181311890 Suspension Ball Joint - Front Lower	D=Ø 13mm	46437951
SSP1191	301181311910 Suspension Ball Joint - Front Lower	D=Ø 15mm	46437959; 46454599
SSP1194	301181311940 Suspension Ball Joint - Front		46779293; 7082812; 46842581
SSP1217	301181312170 Bush / Silent block - Track control arm - Rear Rh	ARM111 / ARM135	46748579
SSP1218	301181312180 Bush / Silent block - Track control arm - Rear Lh	ARM112 / ARM136	46748578
SSP1277	301181312770 Bush / Silent block - Track control arm - Rear Rh	ARM147 / ARM015 Power Steering	46551376
SSP1278	301181312780 Bush / Silent block - Track control arm - Rear Lh	ARM148 / ARM016 Power Steering	46551377
SSP1279	301181312790 Bush / Silent block - Track control arm - Rear Rh	ARM133 Manual Steering	46454061
SSP1281	301181312810 Bush / Silent block - Track control arm - Rear Lh	ARM134 Manual Steering	46454062
SSP1283	301181312830 Bush / Silent block - Track control arm	ARM015 / ARM016 / ARM111 / ARM112 / ARM113 / ARM114 / ARM133 / ARM134 / ARM135 / ARM136 / ARM147 / ARM148	46421552
SSP1371	301181313710 Steering Tie Rod - Front	Power steering M14x1,5 - L=282mm	7079382
SSP1372	301181313720 Steering Tie Rod - Front	Manual Steering M14x1,5 - L=282mm	7079383
SSP1373	301181313730 Steering Tie Rod - Front	Power St M14x1,5 Rht - L=264mm	7081851
SSP1424	301181314240 Steering Tie Rod End - Front Right	M14x1,5Rht	46456660; 98845031
SSP1425	301181314250 Steering Tie Rod End - Front Left	M14x1,5Rht	46456189; 98845032



FIAT PANDA 141A



1980-08/2003

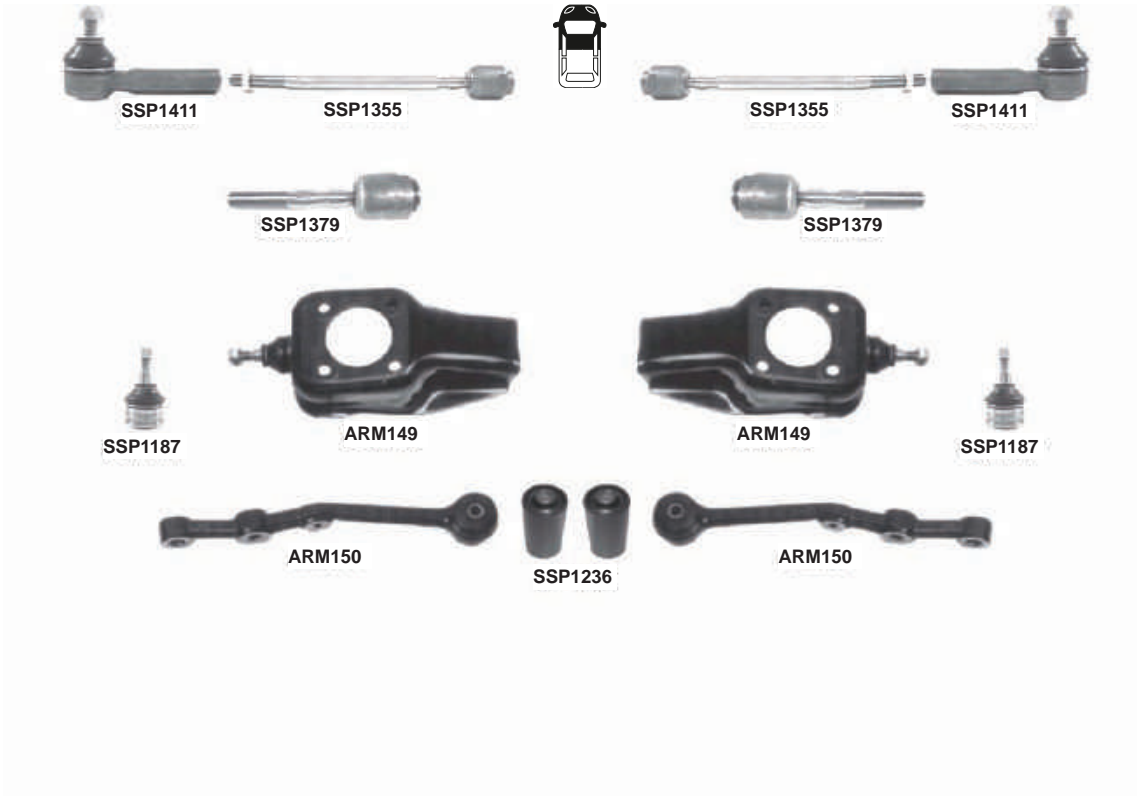

	PART NO.	DESCRIPTION	NOTES	O.E.
ARM149	301181314900	Suspension Control Arm and Ball Joint Assembly - Front Upper		4408138; SE028140104A*; 5995503
ARM150	301181315000	Suspension Control Arm - Front Lower		4402672; SE141156110A; 7601261
SSP1187	301181311870	Suspension Ball Joint - Front Upper		4402644; SE141140104A; 4402649
SSP1236	301181312360	Bush / Silent block - Track control arm	ARM150	4157013
SSP1355	301181313550	Steering Tie Rod - Front	M14x1,5 - L=217mm	7076231
SSP1379	301181313790	Steering Tie Rod - Front	M14x1 - L=142mm	4318655
SSP1411	301181314110	Steering Tie Rod End - Front	M12x1,5Rht	5960835; SE141162410A

FIAT PANDA 169



09/2003-02/2012

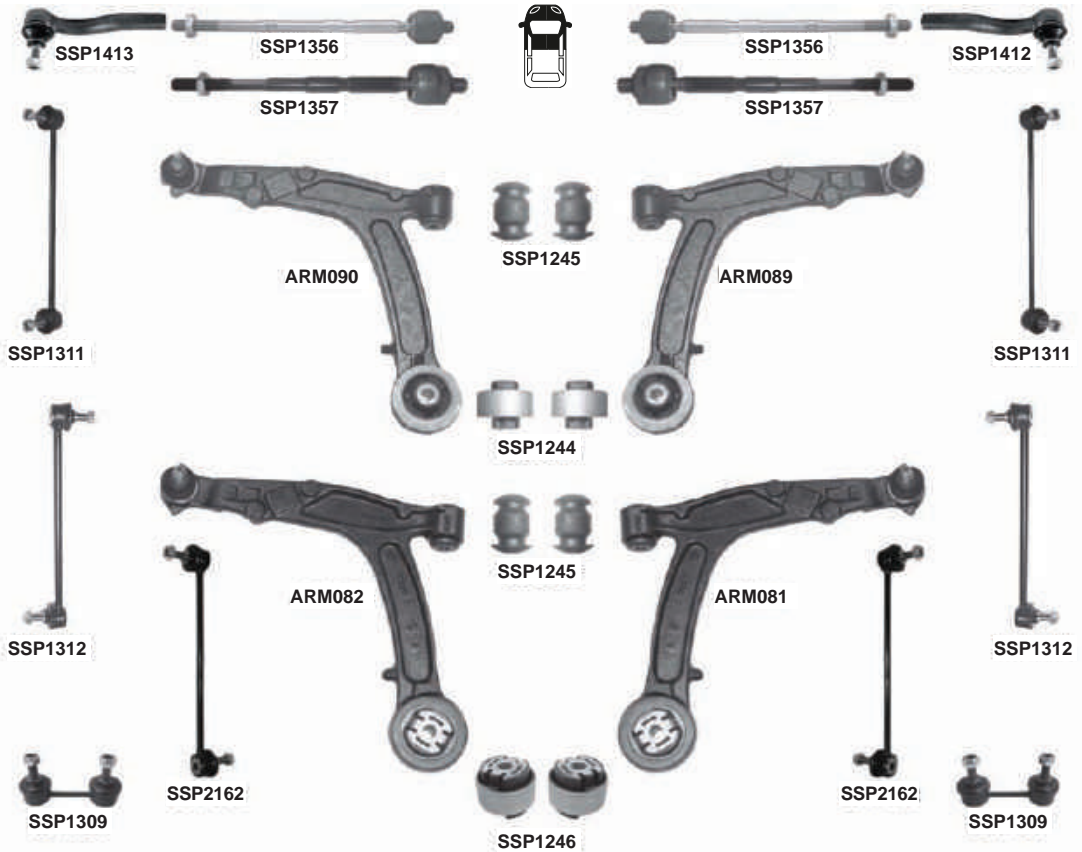

PART NO.	DESCRIPTION	NOTES	O.E.
ARM081	301181308100 Suspension Control Arm and Ball Joint Assembly - Front Right	(Only: 1.4) Ø 15 mm	50701379
ARM082	301181308200 Suspension Control Arm and Ball Joint Assembly - Front Left	(Only: 1.4) Ø 15 mm	50701380
ARM089	301181308900 Suspension Control Arm and Ball Joint Assembly - Front Right Lower	Ø 15 mm	50703129; 51857134
ARM090	301181309000 Suspension Control Arm and Ball Joint Assembly - Front Left Lower	Ø 15 mm	50703128; 51857133
SSP1244	301181312440 Bush / Silent block - Track control arm	ARM089 / ARM090	
SSP1245	301181312450 Bush / Silent block - Track control arm	ARM081 / ARM082 / ARM089 / ARM090	
SSP1246	301181312460 Bush / Silent block - Track control arm - Lower	"ARM075 / ARM076 / ARM081 / ARM082 - only: 1.4"	
SSP1309	301181313090 Suspension Stabilizer Bar Link - Rear	Only:4X4 L=81mm	50704671
SSP1311	301181313110 Suspension Stabilizer Bar Link - Front	(1,4cc) L=311mm	50706957; 51856873
SSP1312	301181313120 Suspension Stabilizer Bar Link - Front	L=315mm	50703296; 51856872
SSP1356	301181313560 Steering Tie Rod - Front Inner	M12x1,5Rht - L=227mm	77362506
SSP1357	301181313570 Steering Tie Rod - Front	Only:4x4 M12x1,5Rht - L=237,5mm	-
SSP1412	301181314120 Steering Tie Rod End - Front Right	M12x1,5Rht	1546260; 9S513270BA; 77362508
SSP1413	301181314130 Steering Tie Rod End - Front Left	M12x1,5Rht	1546259; 9S513270AA; 77362507
SSP2162	301191621620 Suspension Stabilizer Bar Link - Front	(Clip-on patented design) L=315mm	50703296; 51856872



FIAT PANDA 312



02/2012-



	PART NO.	DESCRIPTION	NOTES	O.E.
ARM473	301181347300	Suspension Control Arm and Ball Joint Assembly - Front Right Lower		51849600; 51957400; 51928537
ARM474	301181347400	Suspension Control Arm and Ball Joint Assembly - Front Left Lower		51849602; 51957401; 51928536
SSP0399	301191603990	Steering Tie Rod End - Front	M12X1,5	77365815
SSP1313	301181313130	Suspension Stabilizer Bar Link - Front	L=287mm	1580517; 9S515K484AB; 51801136



FIAT PREMIO



03/1985-12/1996



ARM472



ARM472

PART NO.	DESCRIPTION	NOTES	O.E.
ARM472 301181347200	Suspension Control Arm and Ball Joint Assembly - Front	With Silent Block (10mm)	7543760; 7674825; 7591277



FIAT PUNTO 176



04/1994-09/1999

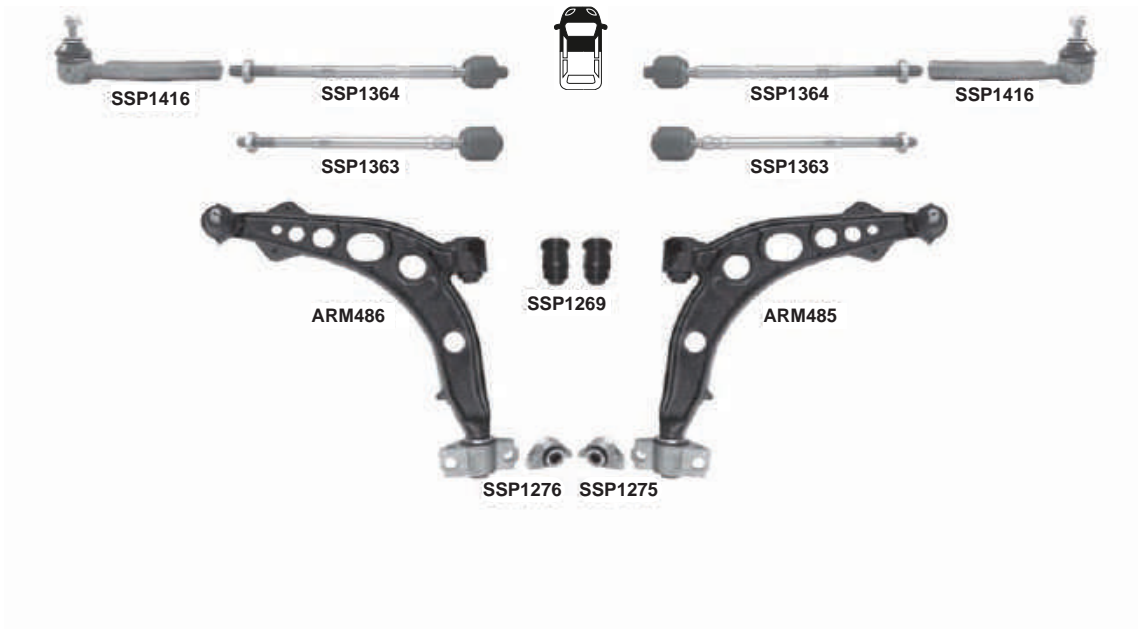

	PART NO.	DESCRIPTION	NOTES	O.E.
ARM485	301181348500	Suspension Control Arm and Ball Joint Assembly - Front Right Lower		46402682; 7750978; 46430003
ARM486	301181348600	Suspension Control Arm and Ball Joint Assembly - Front Left		46402681; 7750977; 46430002
SSP1269	301181312690	Bush / Silent block - Track control arm	ARM001 / ARM002 / ARM009 / ARM0010 / ARM029 / ARM030	7673581
SSP1275	301181312750	Bush / Silent block - Track control arm - Rh	Manual & Power Steering	7775344
SSP1276	301181312760	Bush / Silent block - Track control arm - Lh	Manual & Power Steering	7775343
SSP1363	301181313630	Steering Tie Rod - Front	Manual & Power steering	7701491; 9946948
SSP1364	301181313640	Steering Tie Rod - Front	Power steering M12x1.5Rht - L=271.3mm	9945562
SSP1416	301181314160	Steering Tie Rod End - Front	Manual & Power steering M12x1.5Rht	7752285; 9946949



FIAT PUNTO 188



10/1999-10/2009



PART NO.	DESCRIPTION	NOTES	O.E.
ARM095 301181309500	Suspension Control Arm and Ball Joint Assembly - Front Right Lower	Lower	46545661; 46551790
ARM096 301181309600	Suspension Control Arm and Ball Joint Assembly - Front Left	Lower	46545660; 46551732
SSP1214 301181312140	Bush / Silent block - Track control arm	ARM071 / ARM072 / ARM095 / ARM096	16545660
SSP1215 301181312150	Bush / Silent block - Track control arm - Rear	ARM095 / ARM096	
SSP1366 301181313660	Steering Tie Rod - Front	12x1.5Rht - L=276mm	9948343
SSP1416 301181314160	Steering Tie Rod End - Front	Manual & Power steering M12x1,5Rht	7752285; 9946949



FIAT PUNTO EVO



07/2008-02/2012

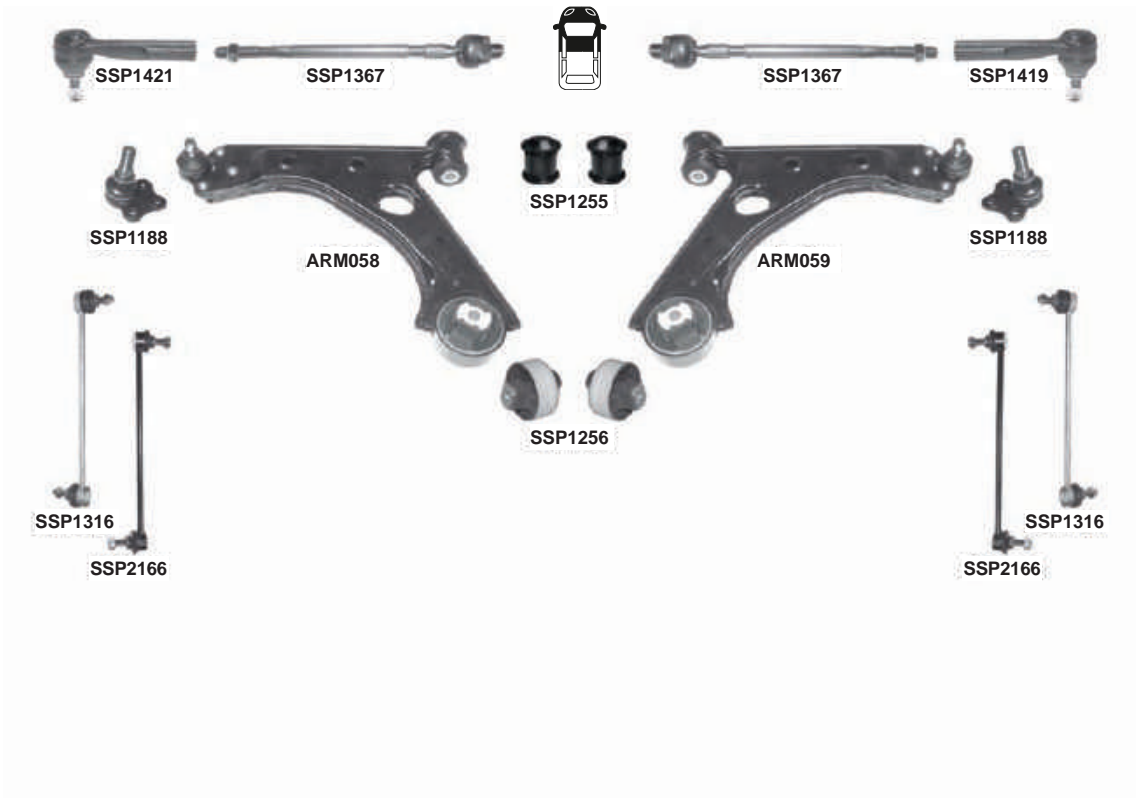

PART NO.	DESCRIPTION	NOTES	O.E.
ARM058	301181305800	Suspension Control Arm and Ball Joint Assembly - Front Left Lower	3520.W3; 55703629; 51895367; 51783057; 3520.Y4
ARM059	301181305900	Suspension Control Arm and Ball Joint Assembly - Front Right Lower	3521.S6; 55703627; 51895366; 51783056; 3521V5
SSP1188	301181311880	Suspension Ball Joint - Front	3520.87; 93190907; 51783057; 51783056; 3520.W3
SSP1255	301181312550	Bush / Silent block - Track control arm	ARM058 / ARM059 / ARM115 / ARM116 352380, 55703232
SSP1256	301181312560	Bush / Silent block - Track control arm - Rear	ARM058 / ARM059 55700751
SSP1316	301181313160	Suspension Stabilizer Bar Link - Front	L=300mm 350616; 55700753; 50515276
SSP1367	301181313670	Steering Tie Rod - Front	M14x1,5Rht - L=295mm 1609211; 9950452; 9944452; 93196540
SSP1419	301181314190	Steering Tie Rod End - Front Right	M14x1,5Rht 1603545; 77363830; 1609458
SSP1421	301181314210	Steering Tie Rod End - Front Left	M14x1,5Rht 1603544; 77363829; 1609457
SSP2166	301191621660	Suspension Stabilizer Bar Link - Front	(Clip-on patented design) L=300mm 55700753



FIAT REGATA



1983-1991



	PART NO.	DESCRIPTION	NOTES	O.E.
SSP1361	301181313610	Steering Tie Rod - Front Inner	Manual Steering M12x1,5 - L=276.8mm	5958244; SE022162449S; 7633721
SSP1437	301181314370	Steering Tie Rod End - Front	M12x1,5Rht	5960036; SE022162406A; 7669756; 5960056; 5960037



FIAT RITMO



1984-1988



	PART NO.	DESCRIPTION	NOTES	O.E.
SSP1361	301181313610	Steering Tie Rod - Front Inner	Manual Steering M12x1,5 - L=276.8mm	5958244; SE022162449S; 7633721
SSP1437	301181314370	Steering Tie Rod End - Front	M12x1,5Rht	5960036; SE022162406A; 7669756; 5960056; 5960037

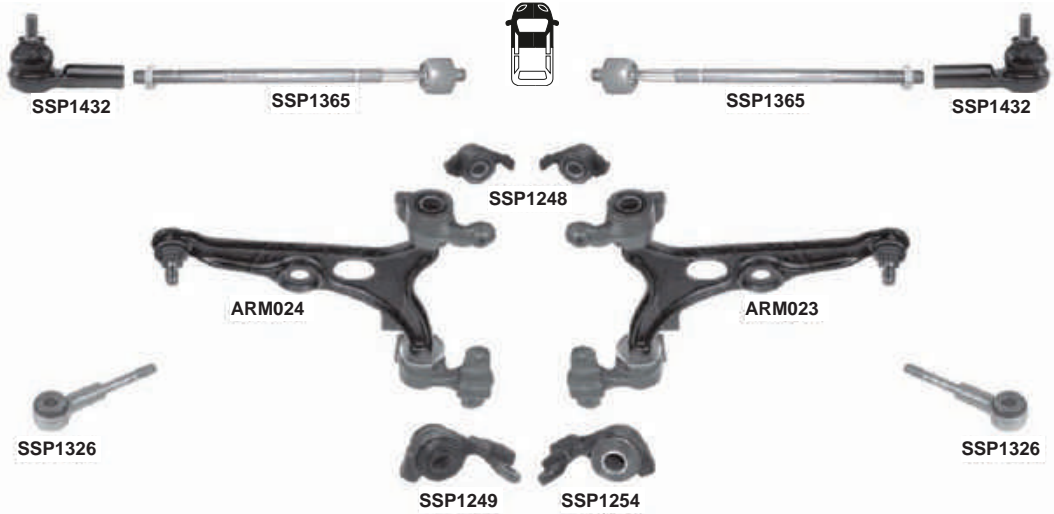

PART NO.	DESCRIPTION	NOTES	O.E.
ARM023 301181302300	Suspension Control Arm and Ball Joint Assembly - Front Right Lower		1313084080; 3521.K4; 3521.83; 3521.C9; 1322664080; 1317390080; 1316736080
ARM024 301181302400	Suspension Control Arm and Ball Joint Assembly - Front Left		1313083080; 3520.G9; 3520.94; 3520.C3; 1322663080; 1317389080; 1316735080
ARM406 301181340600	Suspension Control Arm and Ball Joint Assembly - Front Right	REINFORCED TYPE BASED ON OE PART REVISION IN 2014, 27Ø	3521P4
ARM407 301181340700	Suspension Control Arm and Ball Joint Assembly - Front Left	REINFORCED TYPE BASED ON OE PART REVISION IN 2014, 27Ø	3520P4
SSP1248 301181312480	Bush / Silent block - Track control arm	ARM023 / ARM024 / ARM035 / ARM036	1312317080
SSP1249 301181312490	Bush / Silent block - Track control arm - Lh	ARM024	1305551080
SSP1254 301181312540	Bush / Silent block - Track control arm - Rh	ARM023	1305552080
SSP1326 301181313260	Suspension Stabilizer Bar Link - Front	L=122mm	1308664080; 5087.35; 1317425080
SSP1365 301181313650	Steering Tie Rod - Front Inner	M14x1,5Rht - L=309.3mm	9947713
SSP1432 301181314320	Steering Tie Rod End - Front Outer	M14x1,5Rht - D=Ø15,45mm	4059.12; 77362279



FIAT SCUDO 272



01/2007-

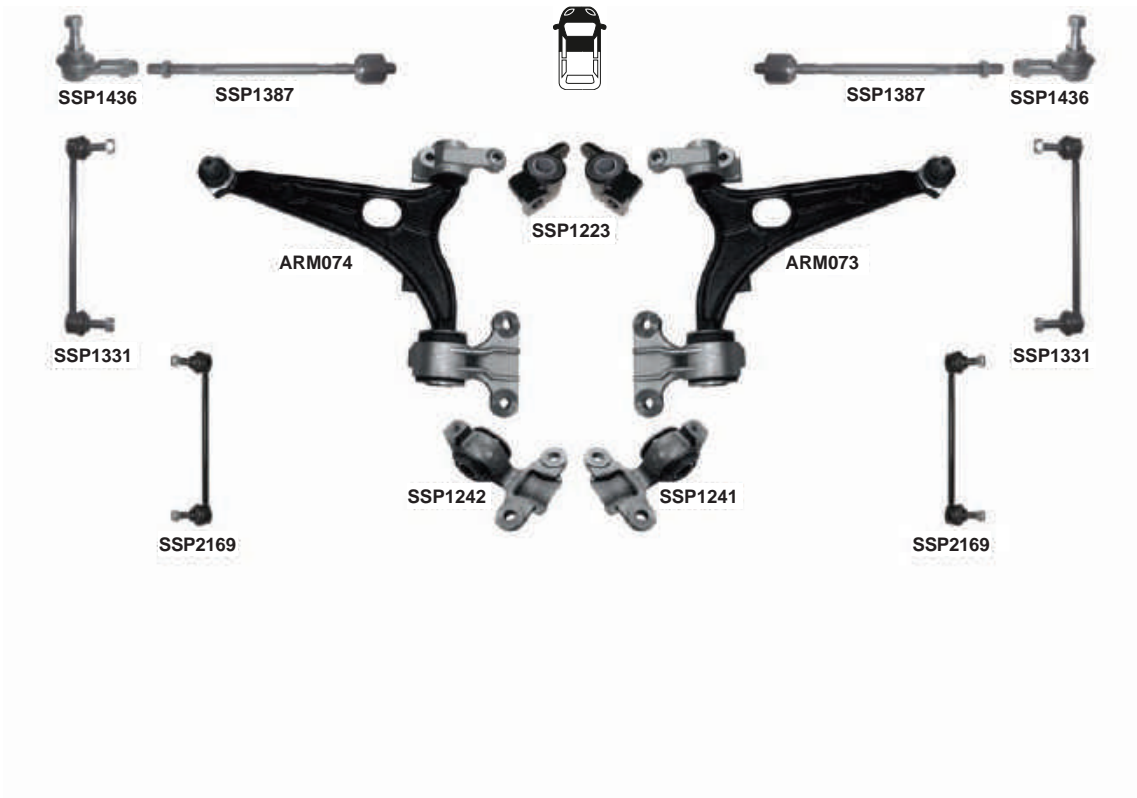

PART NO.	DESCRIPTION	NOTES	O.E.
ARM073	301181307300 Suspension Control Arm and Ball Joint Assembly - Front Right		1497407080; 50711395; 3521.N9
ARM074	301181307400 Suspension Control Arm and Ball Joint Assembly - Front Left		1497408080; 50711394; 3520.R8
ARM495	301181349500 Suspension Control Arm and Ball Joint Assembly - Front Right		1497407080*
ARM496	301181349600 Suspension Control Arm and Ball Joint Assembly - Front Left		1497408080*
SSP1223	301181312230 Bush / Silent block - Track control arm	ARM073 / ARM074	
SSP1241	301181312410 Bush / Silent block - Track control arm - Rh	ARM035 / ARM073	
SSP1242	301181312420 Bush / Silent block - Track control arm - Lh	ARM036 / ARM074	
SSP1331	301181313310 Suspension Stabilizer Bar Link - Front	L=263mm	1400099680; 5087.56
SSP1387	301181313870 Steering Tie Rod - Front	M14x1,5 - L=304.7mm	1401381380; 3812.F0; 1497550080
SSP1436	301181314360 Steering Tie Rod End - Front	M14x1,5	3817.73; 9403817738
SSP2169	301191621690 Suspension Stabilizer Bar Link - Front	(Clip-on patented design) L=263mm	1400099680*



FIAT SEDICI



06/2006-10/2014

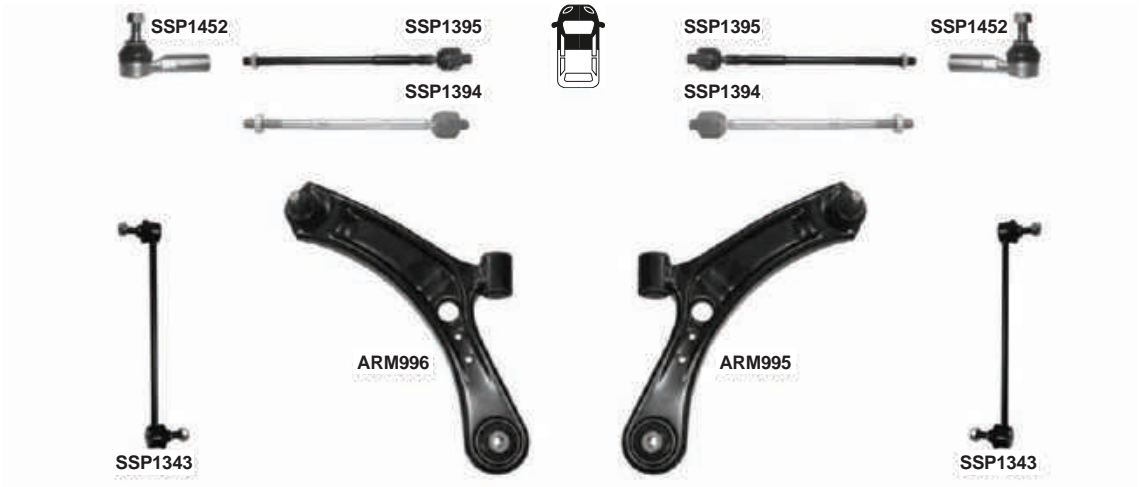

PART NO.	DESCRIPTION	NOTES	O.E.
ARM995 301181399500	Suspension Control Arm and Ball Joint Assembly - Front Right Lower		4520179J00; 71768151; 71742731
ARM996 301181399600	Suspension Control Arm and Ball Joint Assembly - Front Left Lower		4520279J00; 71768151; 71742732
SSP1343 301181313430	Suspension Stabilizer Bar Link - Front	l=271mm	4252080J00; 71742688; 60614514
SSP1394 301181313940	Steering Tie Rod - Right	M14x1,5 - L=333mm	4883079J00
SSP1395 301181313950	Steering Tie Rod - Left	M14x1,5 - L=333mm	4883079J10
SSP1452 301181314520	Steering Tie Rod End - Front	M14x1,5	4881079J01; 71742770

**FIAT SEICENTO**

1998-2007

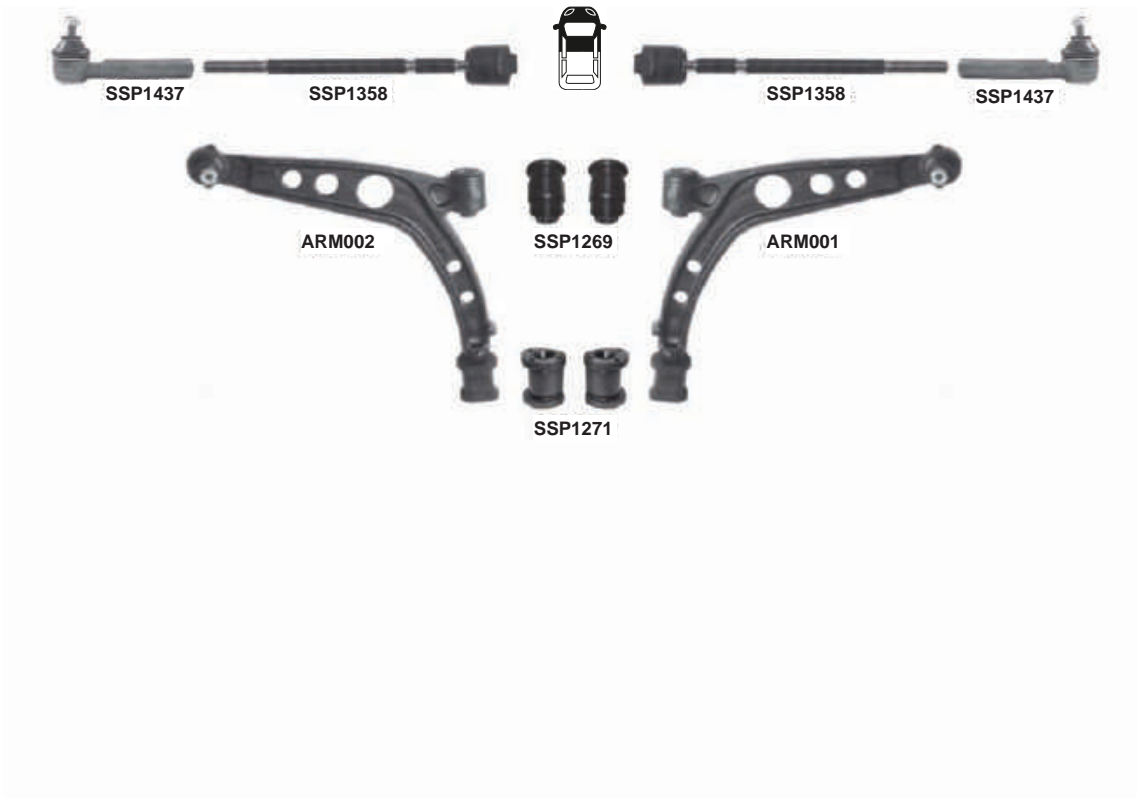

	PART NO.	DESCRIPTION	NOTES	O.E.
ARM001	301181300100	Suspension Control Arm and Ball Joint Assembly - Front Right Lower	Lower	7636996
ARM002	301181300200	Suspension Control Arm and Ball Joint Assembly - Front Left	Lower	7636995
SSP1269	301181312690	Bush / Silent block - Track control arm	ARM001 / ARM002 / ARM009 / ARM010 / ARM029 / ARM030	7673581
SSP1271	301181312710	Bush / Silent block - Track control arm	ARM001 / ARM002/ ARM009 / ARM010	5927293, 7673582
SSP1358	301181313580	Steering Tie Rod - Front	M12x1,5 - L=285mm	7658273
SSP1437	301181314370	Steering Tie Rod End - Front	M12x1,5Rht	5960036; SE022162406A; 7669756; 5960056; 5960037



FIAT STILO 192



10/2001-11/2010

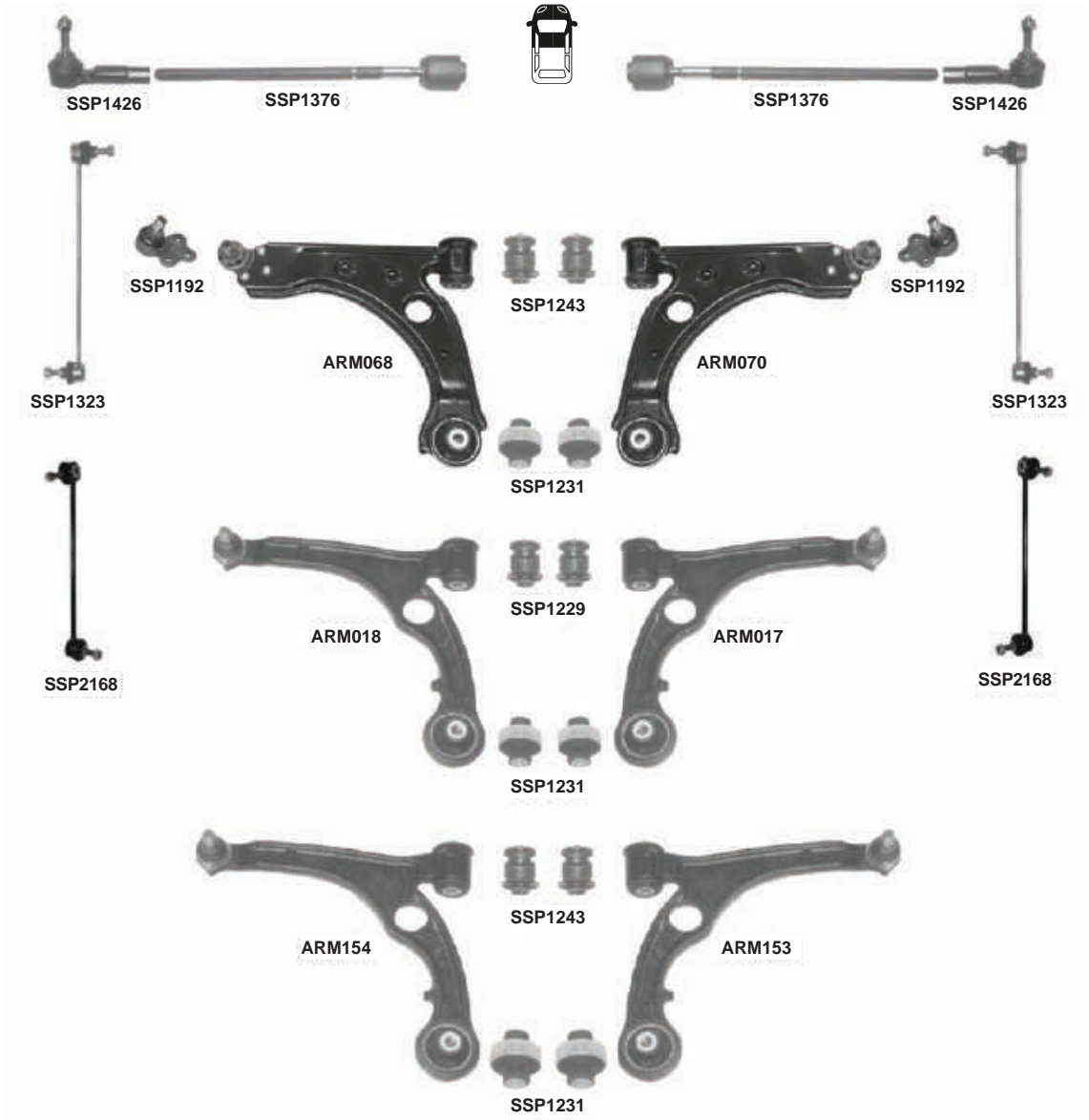

**FIAT STILO 192**

10/2001-11/2010

	PART NO.	DESCRIPTION	NOTES	O.E.
ARM017	301181301700	Suspension Control Arm and Ball Joint Assembly - Front Right	D=Ø12,5mm	50700779; 93501486
ARM018	301181301800	Suspension Control Arm and Ball Joint Assembly - Front Left	D=Ø12,5mm	50700797; 93501485
ARM068	301181306800	Suspension Control Arm and Ball Joint Assembly - Front Left Lower		50705464; 51827736
ARM070	301181307000	Suspension Control Arm and Ball Joint Assembly - Front Right Lower		50705465; 51827737
ARM153	301181315300	Suspension Control Arm and Ball Joint Assembly - Front Right	Ch: 495306 / 495452 D=Ø 14mm	50705084
ARM154	301181315400	Suspension Control Arm and Ball Joint Assembly - Front Left	Ch: 495306 / 495452 D=Ø 14mm	50705083
SSP1192	301181311920	Suspension Ball Joint - Front Lower		50706463
SSP1229	301181312290	Bush / Silent block - Track control arm	ARM017 / ARM018	50700443
SSP1231	301181312310	Bush / Silent block - Track control arm	ARM017 / ARM018 / ARM068 / ARM070 / ARM153 / ARM154	50700778
SSP1243	301181312430	Bush / Silent block - Track control arm	ARM068 / ARM070 / ARM153 / ARM154	
SSP1323	301181313230	Suspension Stabilizer Bar Link - Front	L=290mm	50700464; 51801136
SSP1376	301181313760	Steering Tie Rod - Front	M14x1,5 - L=317mm	9949217
SSP1426	301181314260	Steering Tie Rod End - Front	M14x1,5	9949218
SSP2168	301191621680	Suspension Stabilizer Bar Link - Front	(Clip-on patented design) L=290mm	50700464; 51801136; 51795269



FIAT STRADA 178E



1999-2012

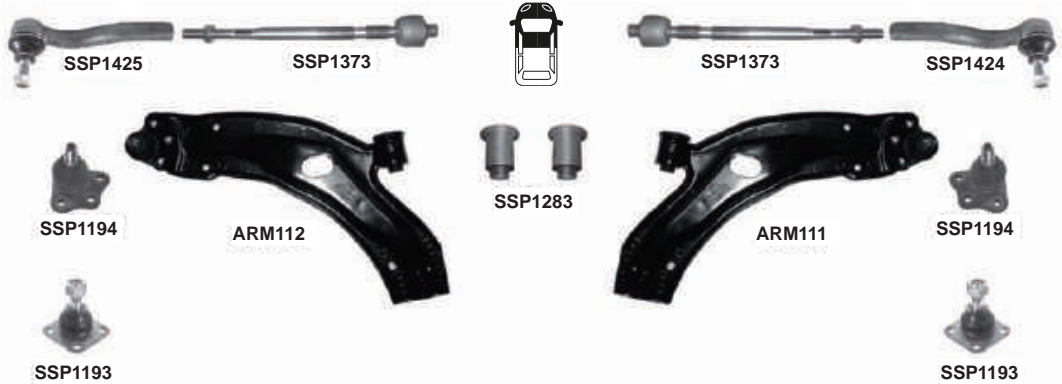

PART NO.	DESCRIPTION	NOTES	O.E.
ARM111	301181311100	Suspension Control Arm and Ball Joint Assembly - Front Right Lower	46777741; 51866700; 51769073; 51712407; 46794065
ARM112	301181311200	Suspension Control Arm and Ball Joint Assembly - Front Left Lower	46777742; 51769074; 51712408; 46794066
SSP1193	301181311930	Suspension Ball Joint - Front Lower	Only: Strada 46543045; 7081835
SSP1194	301181311940	Suspension Ball Joint - Front	46779293; 7082812; 46842581
SSP1283	301181312830	Bush / Silent block - Track control arm	ARM015 / ARM016 / ARM111 / ARM112 / ARM113 / ARM114 / ARM133 / ARM134 / ARM135 / ARM136 / ARM147 / ARM148 46421552
SSP1373	301181313730	Steering Tie Rod - Front	M14x1,5 Rht - L=264mm 7081851
SSP1424	301181314240	Steering Tie Rod End - Front Right	M14x1,5Rht 46456660; 98845031
SSP1425	301181314250	Steering Tie Rod End - Front Left	M14x1,5Rht 46456189; 98845032



FIAT TEMPRA



1988-1997

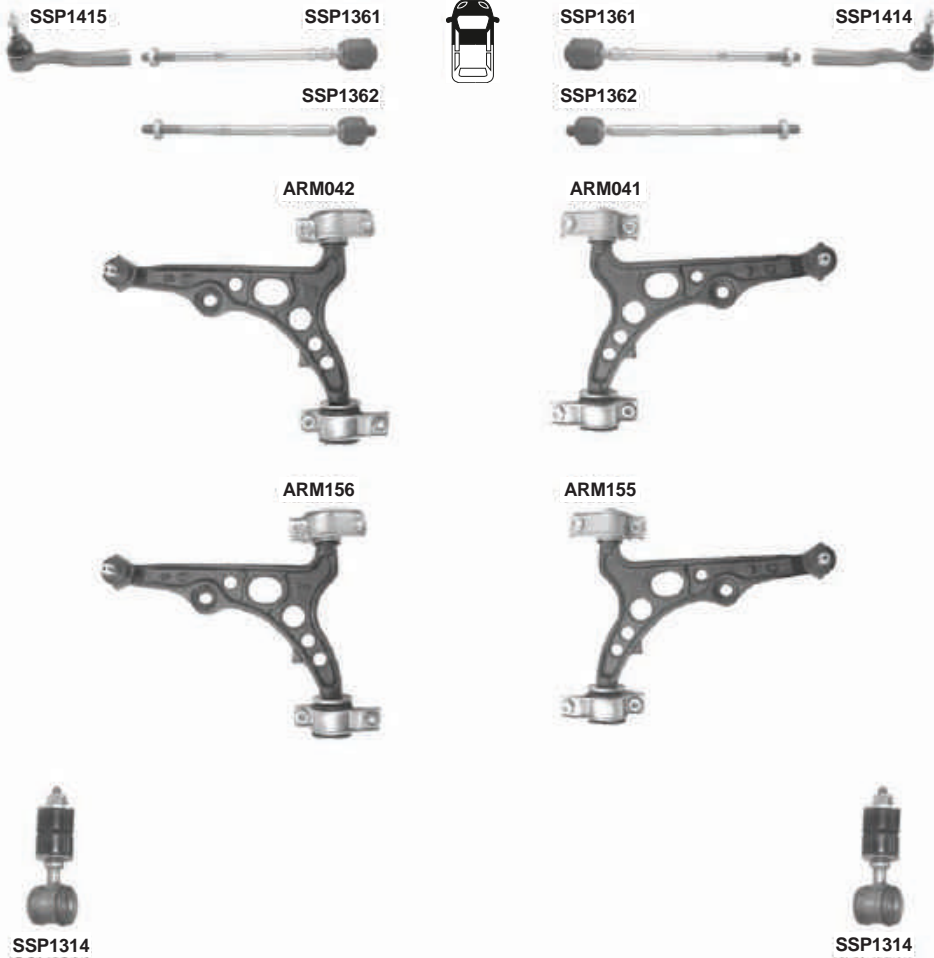

	PART NO.	DESCRIPTION	NOTES	O.E.
ARM041	301181304100	Suspension Control Arm and Ball Joint Assembly - Front Right Lower	Ch.No:7068090-> D= Ø17mm	46423823; 82461082
ARM042	301181304200	Suspension Control Arm and Ball Joint Assembly - Front Left	Ch.No:7068090-> D= Ø17mm	46423822; 82461081
ARM155	301181315500	Suspension Control Arm and Ball Joint Assembly - Front Right Lower	Ch.-> 068090 D=Ø 15mm	7601062; 93501181
ARM156	301181315600	Suspension Control Arm and Ball Joint Assembly - Front Left	Ch.-> 068090 D=Ø 15mm	7601057; 93501180
SSP1314	301181313140	Suspension Stabilizer Bar Link - Front	M10x1,25Rht - L=114mm	12574521; 7601643; 7601642; 60570627
SSP1361	301181313610	Steering Tie Rod - Front Inner	Manual Steering M12x1,5 - L=276.8mm	5958244; SE022162449S; 7633721
SSP1362	301181313620	Steering Tie Rod - Front Inner	Power Steering M12x1,5 L=277mm	9941625
SSP1414	301181314140	Steering Tie Rod End - Front Right	M12x1,5Rht	60806355; 9947438; 9947436
SSP1415	301181314150	Steering Tie Rod End - Front Left	M12x1,5Rht	60806356; 9947439; 9947438



FIAT TIPO



1987-2000

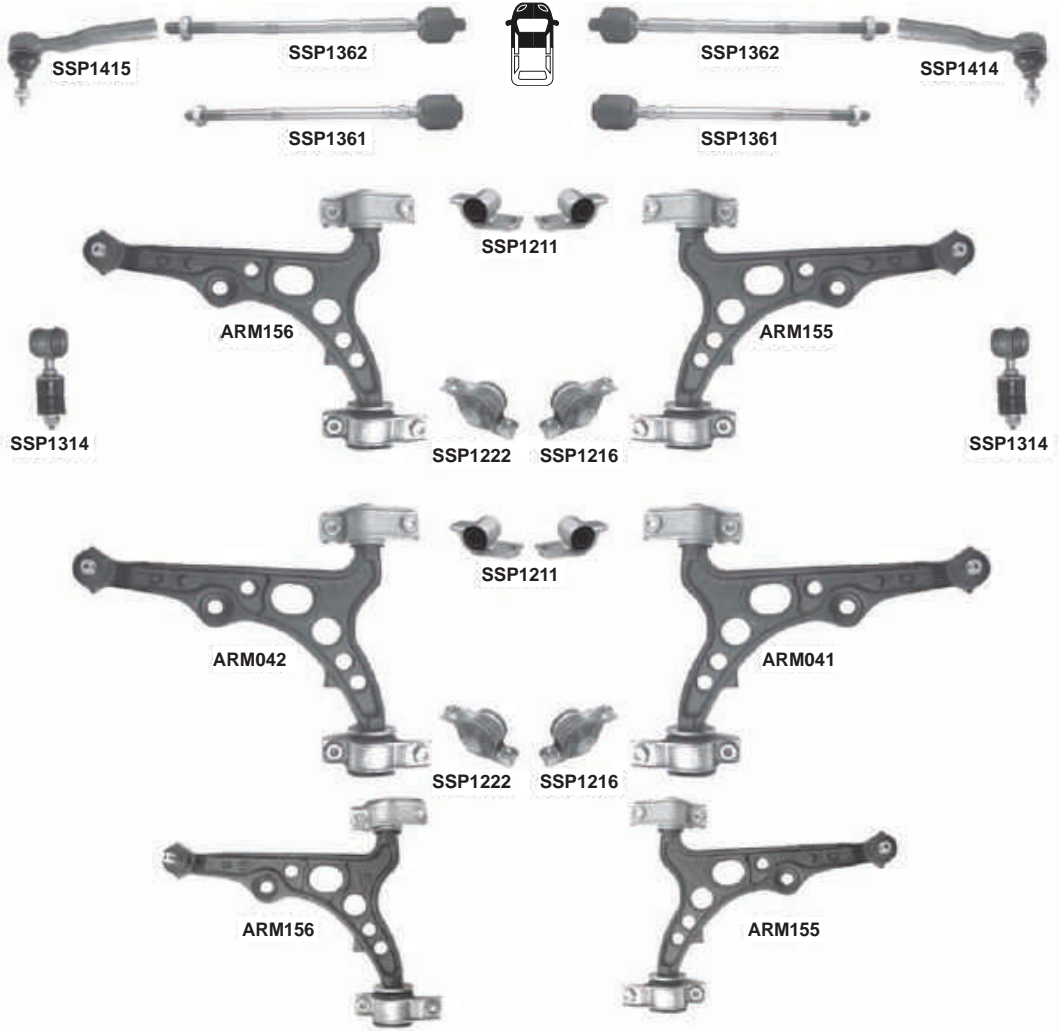

**FIAT TIPO****1987-2000**

	PART NO.	DESCRIPTION	NOTES	O.E.
ARM041	301181304100	Suspension Control Arm and Ball Joint Assembly - Front Right Lower	Ch.No:7068090-> D= Ø17mm	46423823; 82461082
ARM042	301181304200	Suspension Control Arm and Ball Joint Assembly - Front Left	Ch.No:7068090-> D= Ø17mm	46423822; 82461081
ARM155	301181315500	Suspension Control Arm and Ball Joint Assembly - Front Right Lower	Ch.-> 068090 D=Ø 15mm	7601062; 93501181
ARM156	301181315600	Suspension Control Arm and Ball Joint Assembly - Front Left	Ch.-> 068090 D=Ø 15mm	7601057; 93501180
SSP1211	301181312110	Bush / Silent block - Track control arm	"ARM008 / ARM007 / ARM041 / ARM042 / ARM155 / ARM156 D=Ø20,9mm - Center:83mm"	7601064
SSP1216	301181312160	Bush / Silent block - Track control arm - Rear Rh	ARM007 / ARM041 / ARM155	7601065
SSP1222	301181312220	Bush / Silent block - Track control arm - Rear Lh	ARM008 / ARM042 / ARM156	7601068
SSP1314	301181313140	Suspension Stabilizer Bar Link - Front	M10x1,25Rht - L=114mm	12574521; 7601643; 7601642; 60570627
SSP1361	301181313610	Steering Tie Rod - Front Inner	Manual Steering M12x1,5 - L=276.8mm	5958244; SE022162449S; 7633721
SSP1362	301181313620	Steering Tie Rod - Front Inner	Power Steering M12x1,5 L=277mm	9941625
SSP1414	301181314140	Steering Tie Rod End - Front Right	M12x1,5Rht	60806355; 9947438; 9947436
SSP1415	301181314150	Steering Tie Rod End - Front Left	M12x1,5Rht	60806356; 9947439; 9947438



PART NO.	DESCRIPTION	NOTES	O.E.
ARM482 301181348200	Suspension Control Arm and Ball Joint Assembly - Front Left		52011614
SSP0070 301191600700	Steering Tie Rod - Front	B= M14x1.5	Part of 52014014
SSP0404 301191604040	Steering Tie Rod End - Front	M14X1.5	77367379
SSP1827 301191618270	Suspension Ball Joint - Front Lower		52026562
SSP2163 301191621630	Suspension Stabilizer Bar Link - Front		51939949



FIAT ULYSSE 121



06/1994-08/2002

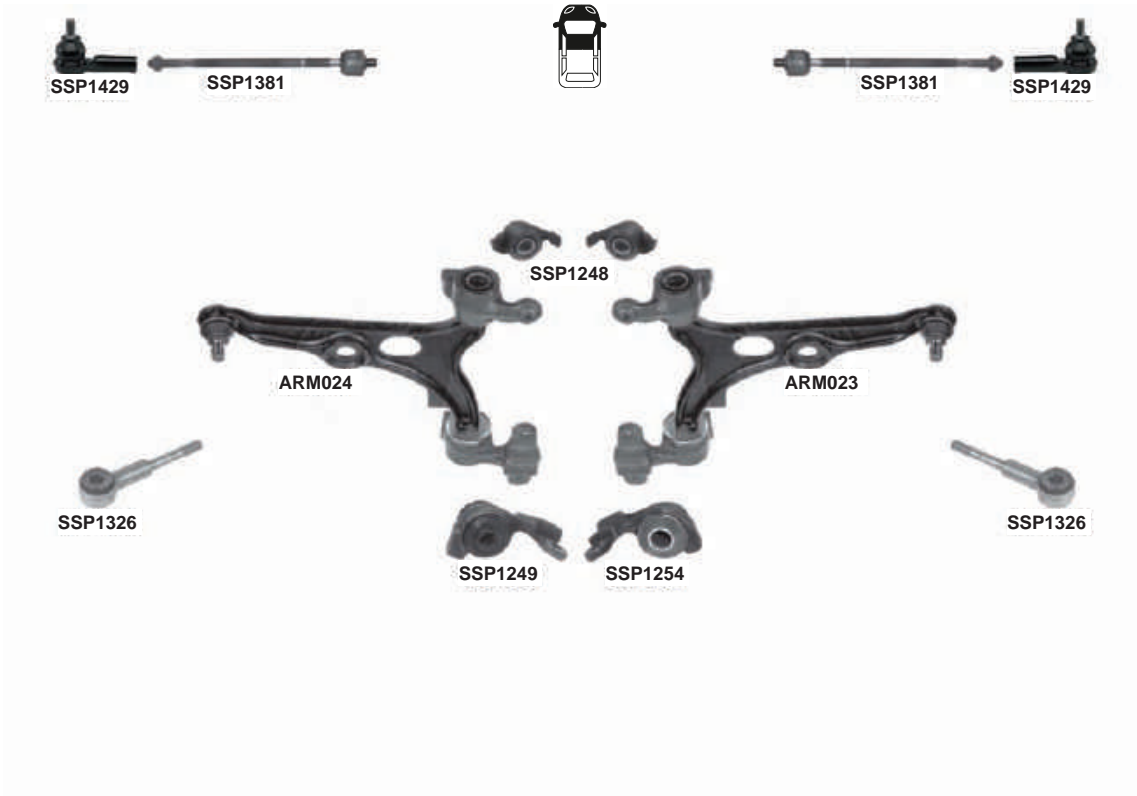

PART NO.	DESCRIPTION	NOTES	O.E.
ARM023	301181302300	Suspension Control Arm and Ball Joint Assembly - Front Right Lower	1313084080; 3521.K4; 3521.83; 3521.C9; 1322664080; 1317390080; 1316736080
ARM024	301181302400	Suspension Control Arm and Ball Joint Assembly - Front Left	1313083080; 3520.G9; 3520.94; 3520.C3; 1322663080; 1317389080; 1316735080
SSP1248	301181312480	Bush / Silent block - Track control arm	ARM023 / ARM024 / ARM035 / ARM036 1312317080
SSP1249	301181312490	Bush / Silent block - Track control arm - Lh	ARM024 1305551080
SSP1254	301181312540	Bush / Silent block - Track control arm - Rh	ARM023 1305552080
SSP1326	301181313260	Suspension Stabilizer Bar Link - Front	L=122mm 1308664080; 5087.35; 1317425080
SSP1381	301181313810	Steering Tie Rod - Front Inner	M14x1,5 - L=309mm 3812.A4; 9566950880
SSP1429	301181314290	Steering Tie Rod End - Front Outer	M14x1,5Rht - D=Ø14,4mm 1306003080; 9404059580; 4059.09

FIAT ULYSSE 179AX



09/2002-2011



PART NO.	DESCRIPTION	NOTES	O.E.
ARM035	301181303500 Suspension Control Arm and Ball Joint Assembly - Front Right Lower		1346385080; 93501488; 3521.H1
ARM036	301181303600 Suspension Control Arm and Ball Joint Assembly - Front Left		1346384080; 93501487; 3521.H0
SSP1241	301181312410 Bush / Silent block - Track control arm - Rh	ARM035 / ARM073	
SSP1242	301181312420 Bush / Silent block - Track control arm - Lh	ARM036 / ARM074	
SSP1248	301181312480 Bush / Silent block - Track control arm	ARM023 / ARM024 / ARM035 / ARM036	1312317080
SSP1341	301181313410 Suspension Stabilizer Bar Link - Front	L=262,5mm	1331209080; 5087.51
SSP1384	301181313840 Steering Tie Rod - Front	M14x1,5 - L=308mm	3812.E2; 77362280
SSP1432	301181314320 Steering Tie Rod End - Front Outer	M14x1,5Rht - D=Ø15,45mm	4059.12; 77362279

**FIAT UNO 146A/E**

02/1983-2001

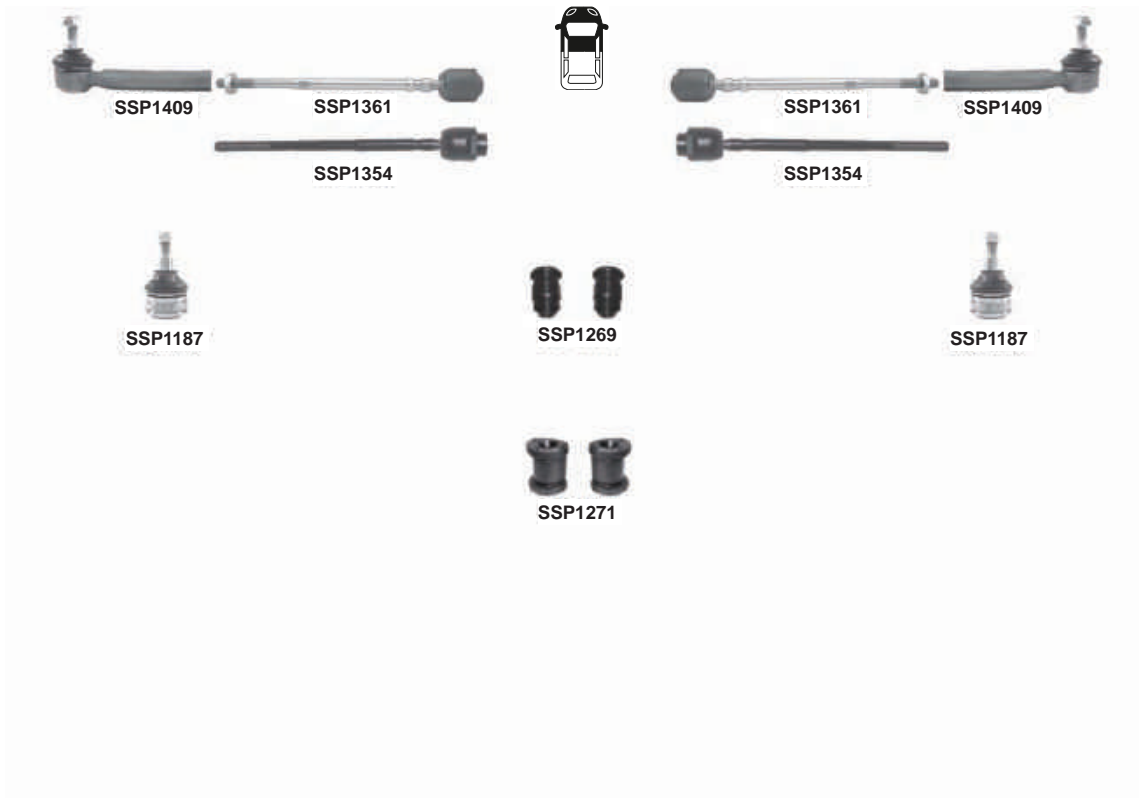

PART NO.	DESCRIPTION	NOTES	O.E.
SSP1187 301181311870	Suspension Ball Joint - Front Upper		4402644; SE141140104A; 4402649
SSP1269 301181312690	Bush / Silent block - Track control arm	ARM001 / ARM002 / ARM009 / ARM010 / ARM029 / ARM030	7673581
SSP1271 301181312710	Bush / Silent block - Track control arm	ARM001 / ARM002 / ARM009 / ARM010	5927293, 7673582
SSP1354 301181313540	Steering Tie Rod - Front	Power steering M12x1,5	
SSP1361 301181313610	Steering Tie Rod - Front Inner	Manual Steering M12x1,5 - L=276.8mm	5958244; SE022162449S; 7633721
SSP1409 301181314090	Steering Tie Rod End - Front	M12x1,5Rht - L=127mm	5958246; 5983406; 5983404

FIAT UNO CS



1983-1996

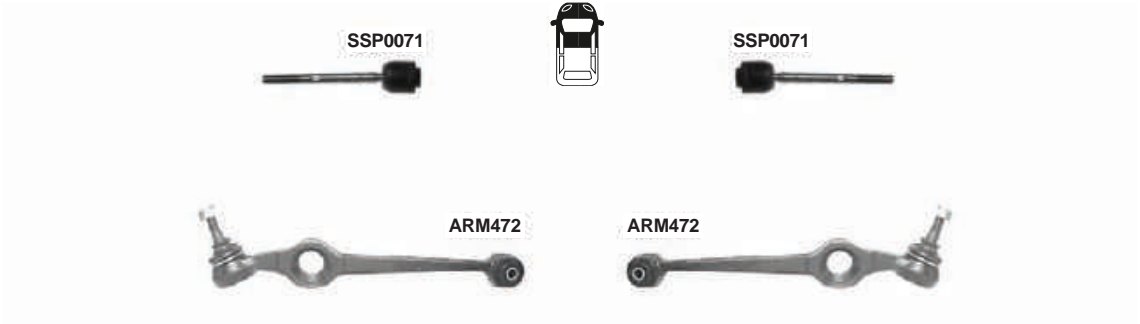

PART NO.	DESCRIPTION	NOTES	O.E.
ARM472 301181347200	Suspension Control Arm and Ball Joint Assembly - Front	With Silent Block (10mm)	7543760; 7674825; 7591277
SSP0071 301191600710	Steering Tie Rod - Front	M12x1.5 - L=192mm	5960321; SE141162449A

**FORD B-MAX I**

2012-

**ARM552****ARM551**

	PART NO.	DESCRIPTION	NOTES	O.E.
ARM551	301181355100	Suspension Control Arm and Ball Joint Assembly - Front Right		1751952; 1834054
ARM552	301181355200	Suspension Control Arm and Ball Joint Assembly - Front Left		1751955; 1834055
SSP1832	301191618320	Suspension Ball Joint - Front Lower		1540724 Part of; Part of 1751955; Part of 1751952; Part of BE8Z3078A; Part of BE8Z3079A



FORD C-MAX I



02/2007-11/2010

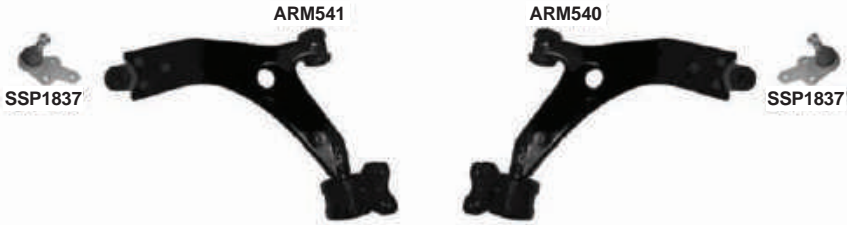



FORD C-MAX I



02/2007-11/2010

PART NO.	DESCRIPTION	NOTES	O.E.
ARM535	301181353500 Lateral Arm - Rear Upper	Only: C-Max 1.6 - 2.0 TDCI	1061660; YS4Z5500AA; 1M515500AC; 98AG5500AG; 1M515500AB; 1329730; 1317609
ARM540	301181354000 Suspension Control Arm and Ball Joint Assembly - Front Right Lower	D=Ø18mm	1254310; 1348191; 1328670; 1332074; 1309644; 1309148; 1305341
ARM541	301181354100 Suspension Control Arm and Ball Joint Assembly - Front Left Lower	D=Ø18mm	1254311; 1348192; 1328671; 1332075; 1309645; 1309149; 1305342
ARM543	301181354300 Suspension Control Arm and Ball Joint Assembly - Front Right	D=Ø21mm	1420859; 4M513A423AD; 4M513A423AF; 31277462; 31262037; 31201180
ARM544	301181354400 Suspension Control Arm and Ball Joint Assembly - Front Left Lower	D=Ø21mm	1420858; 4M513A424AD; 4M513A424AF; 31277463; 31262039; 30714442
ARM558	301181355800 Lateral Arm - Rear Upper		1502440; 8V415500AA
SSP0084	301191600840 Steering Tie Rod - Front Inner	M16x1,5 - L=293mm	1251937; 4M513L519AB; 3M513L519AA; 3M513L519AB; 30776283; 1377655; 1317453
SSP0421	301191604210 Steering Tie Rod End - Front Right	M16x1,5Rht	1317447; 4M513289AB; 30723104; 274501; 1328877
SSP0422	301191604220 Steering Tie Rod End - Front Left	M16x1,5Rht	1317446; 30723103; 4M513290AB; 274500; 1388549; 1328881
SSP1836	301191618360 Suspension Ball Joint - Front Lower	D=17,8mm	1470387; 3M513395BC
SSP1837	301191618370 Suspension Ball Joint - Front	D=Ø15mm	1234382; 3M513K209AA
SSP2190	301191621900 Suspension Stabilizer Bar Link - Front	L=298mm	1223792; AV613B438BAN; 8623576; AV613B438AA; 3M513B438AB; 1686594; 1230909
SSP2191	301191621910 Suspension Stabilizer Bar Link - Front	(Clip-on patented design) L=298mm	AV613B438AA*
SSP2192	301191621920 Suspension Stabilizer Bar Link - Rear	L=76mm	1310333; BP4K28170H; BP4K28170D; BP4K28170G; 30714466; 30683232; 1335548



FORD C-MAX II



12/2010-

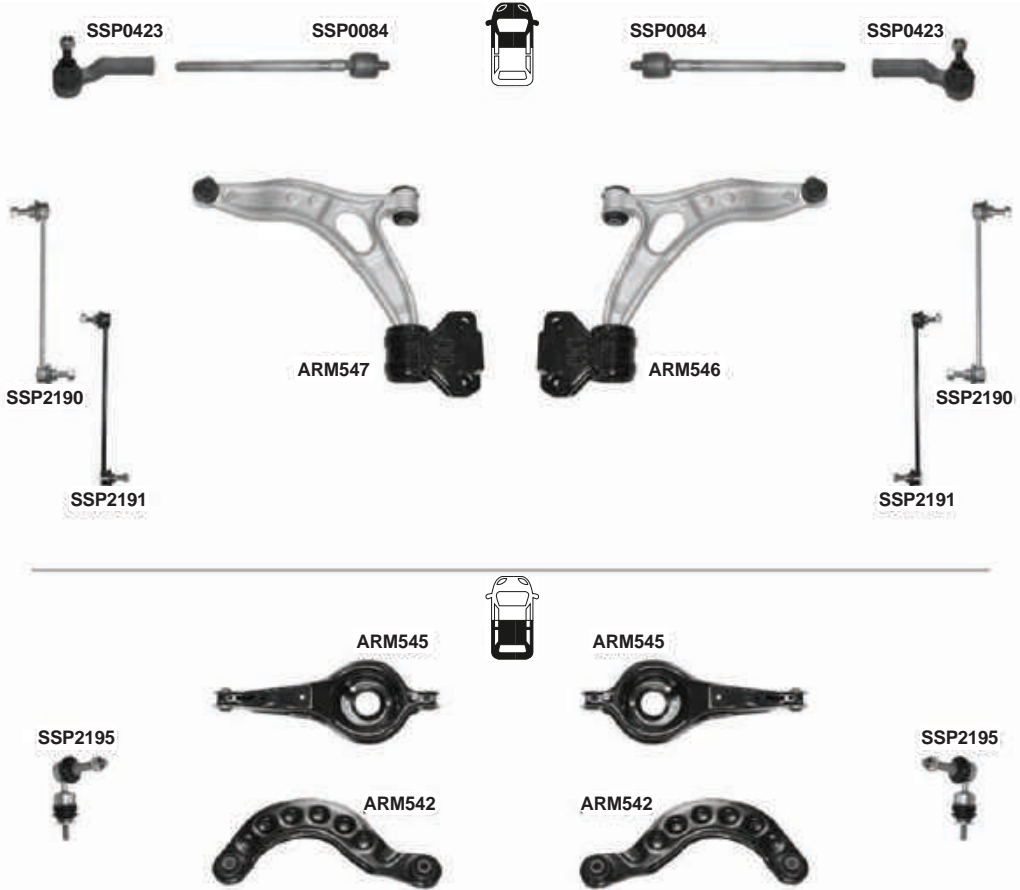

PART NO.	DESCRIPTION	NOTES	O.E.
ARM542	301181354200 Lateral Arm - Rear Upper		1686184; AV6Z5500B; AV615500CB; 1752736
ARM545	301181354500 Lateral Arm - Rear		BV615K652AE
ARM546	301181354600 Suspension Control Arm and Ball Joint Assembly - Front Right Lower	(Alm)	1749993; AV613A423MA; AV613A423PA
ARM547	301181354700 Suspension Control Arm and Ball Joint Assembly - Front Left Lower	(Alm)	1749992; AV613A424MA; AV613A424PA
SSP0084	301191600840 Steering Tie Rod - Front Inner	M16x1,5 - L=293mm	1251937; 4M513L519AB; 3M513L519AA; 3M513L519AB; 30776283; 1377655; 1317453
SSP0423	301191604230 Steering Tie Rod End - Front Right	M16X1,5	1714576; 1748237; 1826501; 1780102
SSP0424	301191604240 Steering Tie Rod End - Front Left	M16X1,5	1714700; BV6C3C437BA; BV6C3C437BB; BV6Z3A130E; 1748239; 1826505; 1780103
SSP2190	301191621900 Suspension Stabilizer Bar Link - Front	L=298mm	1223792; AV613B438BAN; 8623576; AV613B438AA; 3M513B438AB; 1686594; 1230909
SSP2191	301191621910 Suspension Stabilizer Bar Link - Front	(Clip-on patented design) L=298mm	AV613B438AA*
SSP2195	301191621950 Suspension Stabilizer Bar Link - Rear	L=76mm	1714891; BV615C486BAA



FORD C-MAX II USA



2013-2015

SSP0074



SSP0074



PART NO.	DESCRIPTION	NOTES	O.E.
SSP0074 301191600740	Steering Tie Rod - Front		AV6Z3280E



	PART NO.	DESCRIPTION	NOTES	O.E.
ARM567	301181356700	Suspension Control Arm and Ball Joint Assembly - Front Right Lower	Usa Market,Aluminium	BV6Z3078F
ARM568	301181356800	Suspension Control Arm and Ball Joint Assembly - Front Left Lower	Usa Market, Aluminium	BV6Z3079F



FORD COUGAR



08/1998-12/2001



PART NO.	DESCRIPTION	NOTES	O.E.
SSP2218 301191622180	Suspension Stabilizer Bar Link - Front	(Clip-on patented design) L=237,5mm	6960036*



FORD COURIER

 1994-1996



SSP1831



SSP1831

PART NO.	DESCRIPTION	NOTES	O.E.
SSP1831 301191618310	Suspension Ball Joint - Front	D=Ø16.5 mm	1030025; 94FB3395A2B; 1047797



FORD COURIER



08/1996-12/2001

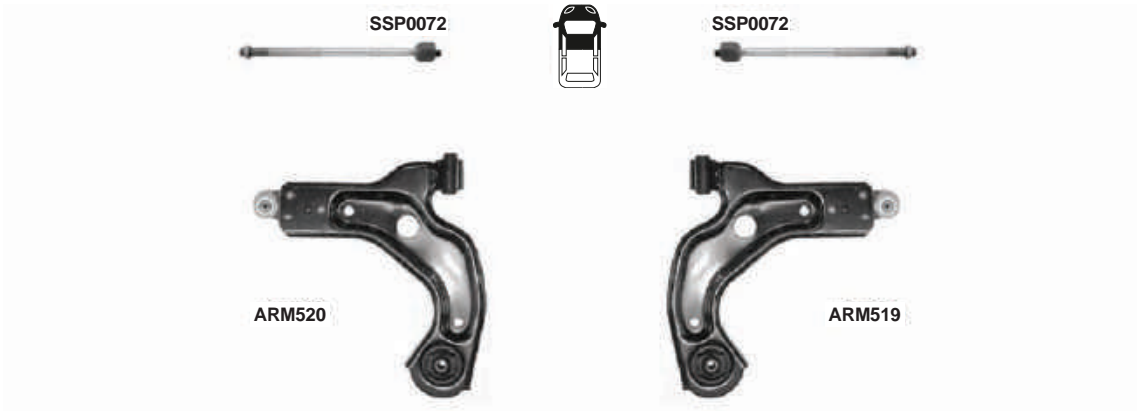

	PART NO.	DESCRIPTION	NOTES	O.E.
ARM517	301181351700	Suspension Control Arm and Ball Joint Assembly - Front Right Lower		1058326
ARM518	301181351800	Suspension Control Arm and Ball Joint Assembly - Front Left Lower		1058332
ARM519	301181351900	Suspension Control Arm and Ball Joint Assembly - Front Right Lower		1071690; 98FB3042BD; 98FB3042BC
ARM520	301181352000	Suspension Control Arm and Ball Joint Assembly - Front Left Lower		1071702; 98FB3051BD; 98FB3051BC
SSP0072	301191600720	Steering Tie Rod - Front	M14x2 - L=313mm	1044014; B196FB3L519BA; 1E0032240



FORD COURIER I



2014-



	PART NO.	DESCRIPTION	NOTES	O.E.
ARM551	301181355100	Suspension Control Arm and Ball Joint Assembly - Front Right		1751952; 1834054
ARM552	301181355200	Suspension Control Arm and Ball Joint Assembly - Front Left		1751955; 1834055
SSP1832	301191618320	Suspension Ball Joint - Front Lower		1540724 Part of; Part of 1751955; Part of 1751952; Part of BE8Z3078A; Part of BE8Z3079A
SSP2216	301191622160	Suspension Stabilizer Bar Link - Front	L=290mm	1763714; BK213B438AA



FORD CROWN VICTORIA 2nd Gen 

1998-2011



PART NO.	DESCRIPTION	NOTES	O.E.
SSP2170 301191621700	Suspension Stabilizer Bar Link - Front		3W1Z5K484AA



FORD EDGE U387



2006-2014

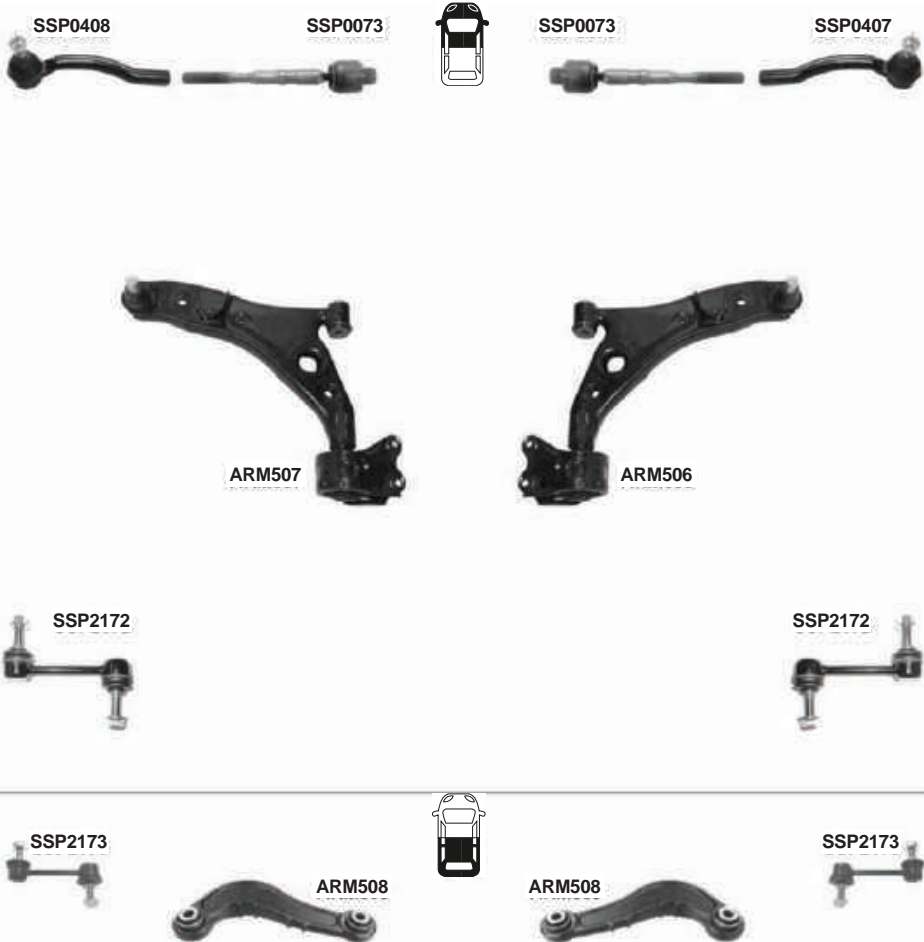

PART NO.	DESCRIPTION	NOTES	O.E.
ARM506	301181350600 Suspension Control Arm and Ball Joint Assembly - Front Right Lower		8T4Z3078A
ARM507	301181350700 Suspension Control Arm and Ball Joint Assembly - Front Left Lower		8T4Z3079A
ARM508	301181350800 Lateral Arm - Rear		7T4Z5500A
SSP0073	301191600730 Steering Tie Rod - Front		7T4Z3280A
SSP0407	301191604070 Steering Tie Rod End - Front Right		7T4Z3A130A
SSP0408	301191604080 Steering Tie Rod End - Front Left		7T4Z3A130B
SSP2172	301191621720 Suspension Stabilizer Bar Link - Front		7T4Z5K483A
SSP2173	301191621730 Suspension Stabilizer Bar Link - Rear		7T4Z5A486AA



FORD ESCAPE 3rd Gen



2013-

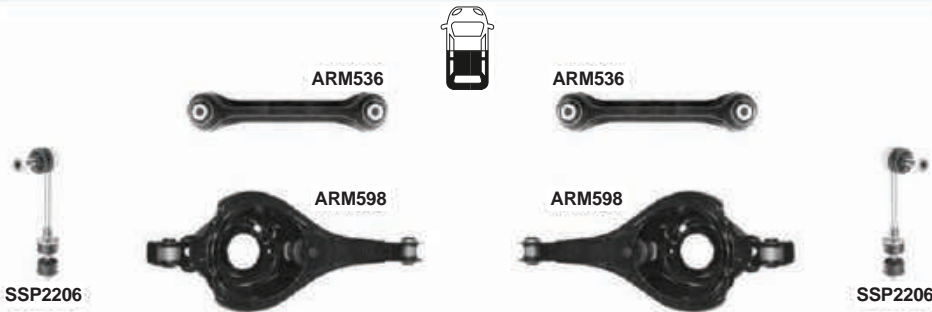
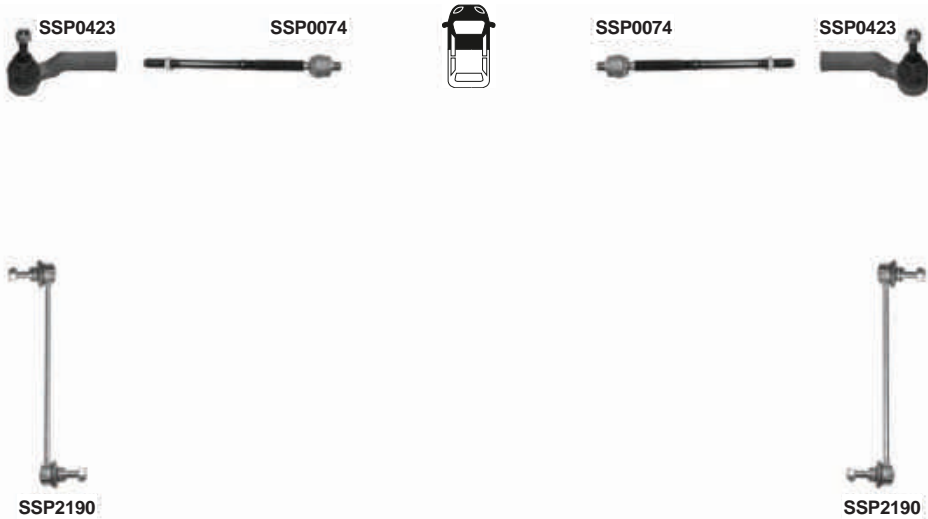

PART NO.	DESCRIPTION	NOTES	O.E.
ARM536	301181353600 Lateral Arm - Rear Lower		1061668; CV6Z5500L; 98AG5K743AF; BV615K743AA; 31277675; 2463500053; 1703145; 1753556
ARM598	301181359800 Lateral Arm - Rear Lower		1782008; CV615K652AAA; CV6Z5500J
SSP0074	301191600740 Steering Tie Rod - Front		AV6Z3280E
SSP0423	301191604230 Steering Tie Rod End - Front Right	M16X1,5	1714576; 1748237; 1826501; 1780102
SSP0424	301191604240 Steering Tie Rod End - Front Left	M16X1,5	1714700; BV6C3C437BA; BV6C3C437BB; BV6Z3A130E; 1748239; 1826505; 1780103
SSP2190	301191621900 Suspension Stabilizer Bar Link - Front	L=298mm	1223792; AV613B438BAN; 8623576; AV613B438AA; 3M513B438AB; 1686594; 1230909
SSP2206	301191622060 Suspension Stabilizer Bar Link - Rear		1502681; 8V415C486AA; CV615C486AAB



FORD ESCORT



1990-2000



SSP2178



SSP2178

PART NO.		DESCRIPTION	NOTES	O.E.
SSP2178	301191621780	Suspension Stabilizer Bar Link - Front	L=237mm	1061631; 1S613B438AA; 98AG3B438AB; 1E0034170; 1661237; 1130273



FORD EXPEDITION 1st Gen



1997-2002



PART NO.	DESCRIPTION	NOTES	O.E.
SSP0425 301191604250	Steering Tie Rod End - Front		2L3Z3A130CA



FORD EXPEDITION 2nd Gen



2003-2006

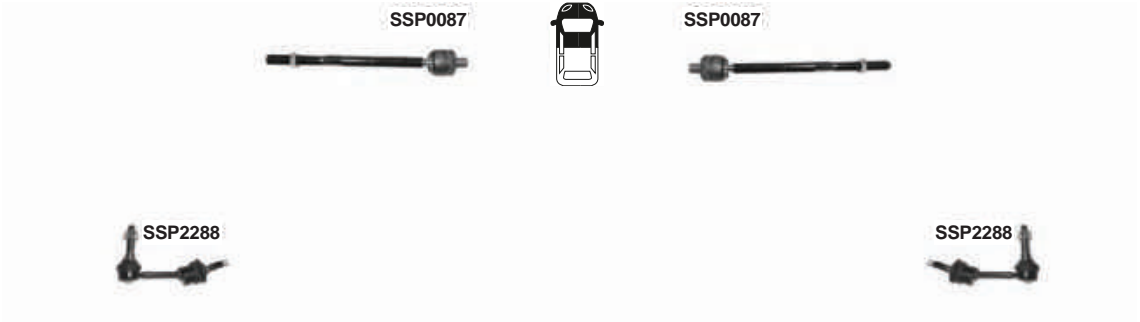

	PART NO.	DESCRIPTION	NOTES	O.E.
ARM553	301181355300	Suspension Control Arm and Ball Joint Assembly - Front right lower		6L1Z3078AA
ARM554	301181355400	Suspension Control Arm and Ball Joint Assembly - Front left lower		6L1Z3079AA
SSP0087	301191600870	Steering Tie Rod - Front		2L1Z3280GA
SSP2288	301191622880	Suspension Stabilizer Bar Link - Front	L=126mm	2L1Z5K483AD

**FORD EXPEDITION 3rd Gen U324** 

2007-2015

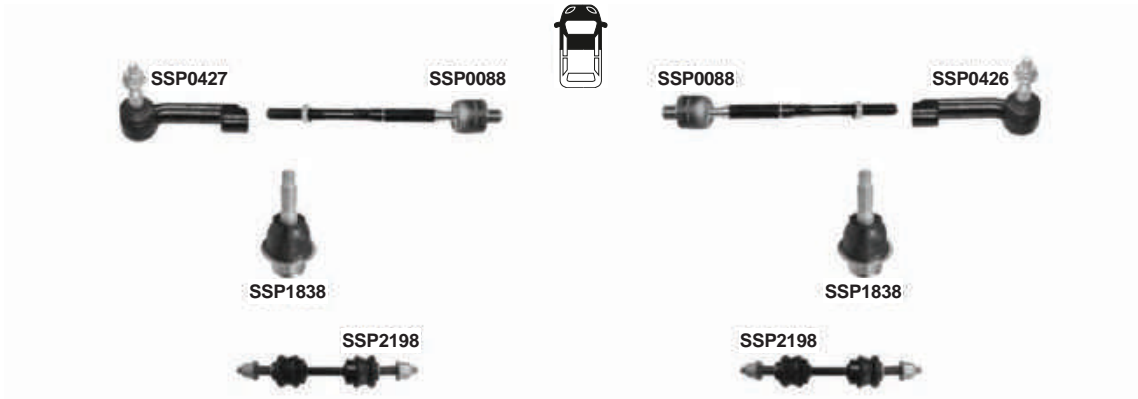

PART NO.	DESCRIPTION	NOTES	O.E.
SSP0088 301191600880	Steering Tie Rod - Front		9L3Z3280A
SSP0426 301191604260	Steering Tie Rod End - Front Right		7L1Z3A130R
SSP0427 301191604270	Steering Tie Rod End - Front Left		7L1Z3A130L
SSP1838 301191618380	Suspension Ball Joint - Front Lower		9L3Z3050A
SSP2198 301191621980	Suspension Stabilizer Bar Link - Front		7L1Z5K483B



PART NO.	DESCRIPTION	NOTES	O.E.
SSP1843 301191618430	Suspension Ball Joint - Front Upper		Part of 104230; Part of F5TZ3082A



FORD EXPLORER UN105/UN150



1995-2001



PART NO.	DESCRIPTION	NOTES	O.E.
ARM501 301181350100	Suspension Control Arm and Ball Joint Assembly - Front Left Upper		2L5Z3083AA



PART NO.	DESCRIPTION	NOTES	O.E.
SSP1830 301191618300	Suspension Ball Joint - Front Lower		BL5Z3050A
SSP1843 301191618430	Suspension Ball Joint - Front Upper		Part of 104230; Part of F5TZ3082A



FORD EXPLORER U251



2006-2010



PART NO.	DESCRIPTION	NOTES	O.E.
SSP1829 301191618290	Suspension Ball Joint - Front Upper		6L2Z3085AA; 6L2Z3084AA



FORD EXPLORER U502



2010-2015

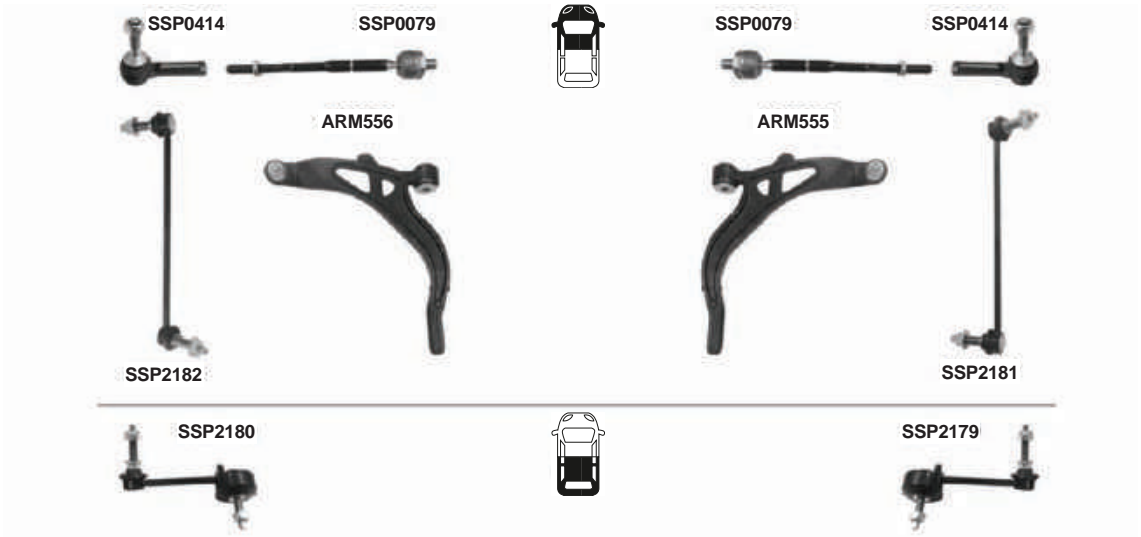

PART NO.	DESCRIPTION	NOTES	O.E.
ARM555	301181355500 Suspension Control Arm and Ball Joint Assembly - Front Right Lower		GB5Z3078C
ARM556	301181355600 Suspension Control Arm and Ball Joint Assembly - Front Left Lower		GB5Z3079A
SSP0079	301191600790 Steering Tie Rod - Front		BB5Z3280A
SSP0414	301191604140 Steering Tie Rod End - Front		BB5Z3A130B
SSP2179	301191621790 Suspension Stabilizer Bar Link - Rear Right		AA8Z5K484A; DG1Z5K484A
SSP2180	301191621800 Suspension Stabilizer Bar Link - Rear Left		AA8Z5K484B; DG1Z5K484B
SSP2181	301191621810 Suspension Stabilizer Bar Link - Front Right		BB5Z5K484A
SSP2182	301191621820 Suspension Stabilizer Bar Link - Front Left		BB5Z5K483A



FORD EXPLORER SPORT TRAC 2nd Gen  2007-2010



PART NO.	DESCRIPTION	NOTES	O.E.
SSP1829 301191618290	Suspension Ball Joint - Front Upper		6L2Z3085AA; 6L2Z3084AA



FORD F-150 10th Gen



1997-2003

SSP0425



SSP0425



PART NO.	DESCRIPTION	NOTES	O.E.
SSP0425 301191604250	Steering Tie Rod End - Front		2L3Z3A130CA

**FORD F-150 12th Gen**

2009-2015

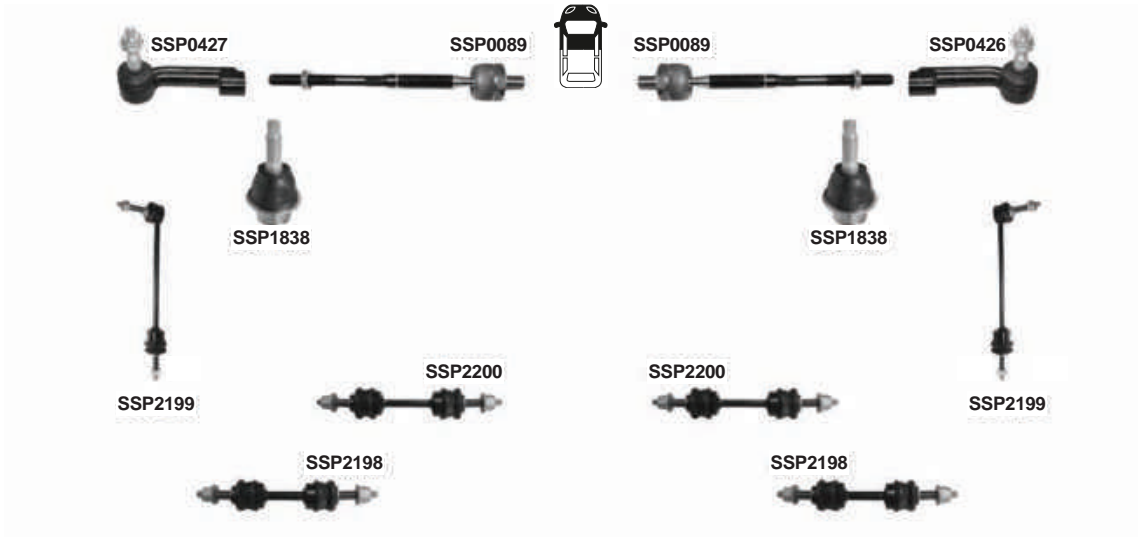

PART NO.	DESCRIPTION	NOTES	O.E.
SSP0089 301191600890	Steering Tie Rod - Front		FL3Z3280A; FR3Z3280A; GR3Z3280C
SSP0426 301191604260	Steering Tie Rod End - Front Right		7L1Z3A130R
SSP0427 301191604270	Steering Tie Rod End - Front Left		7L1Z3A130L
SSP1838 301191618380	Suspension Ball Joint - Front Lower		9L3Z3050A
SSP2198 301191621980	Suspension Stabilizer Bar Link - Front		7L1Z5K483B
SSP2199 301191621990	Suspension Stabilizer Bar Link - Front		AL3Z5K483A
SSP2200 301191622000	Suspension Stabilizer Bar Link - Front	4WD	9L3Z5K483D



FORD FIESTA III



1994-1996

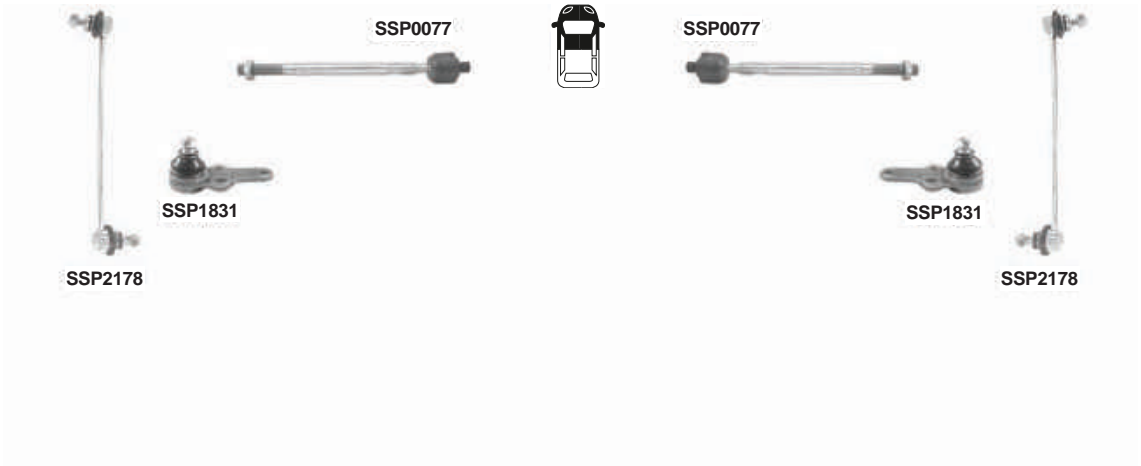

PART NO.	DESCRIPTION	NOTES	O.E.
SSP0077 301191600770	Steering Tie Rod - Front Inner	½"x20 - L=300mm	4048739; XS5C3L519AA; 6790700
SSP1831 301191618310	Suspension Ball Joint - Front	D=Ø16.5 mm	1030025; 94FB3395A2B; 1047797
SSP2178 301191621780	Suspension Stabilizer Bar Link - Front	L=237mm	1061631; 1S613B438AA; 98AG3B438AB; 1E0034170; 1661237; 1130273

**FORD FIESTA IV Box JV**

1996-1998

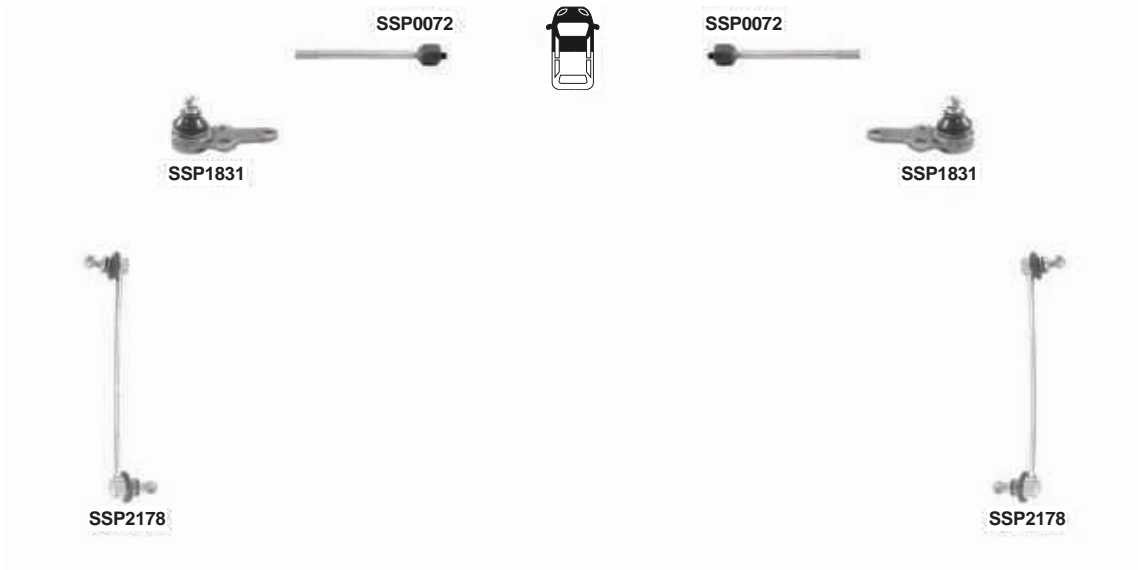

PART NO.	DESCRIPTION	NOTES	O.E.
SSP0072 301191600720	Steering Tie Rod - Front	M14x2 - L=313mm	1044014; B196FB3L519BA; 1E0032240
SSP1831 301191618310	Suspension Ball Joint - Front	D=Ø16.5 mm	1030025; 94FB3395A2B; 1047797
SSP2178 301191621780	Suspension Stabilizer Bar Link - Front	L=237mm	1061631; 1S613B438AA; 98AG3B438AB; 1E0034170; 1661237; 1130273



FORD FIESTA V



01/2002-09/2008

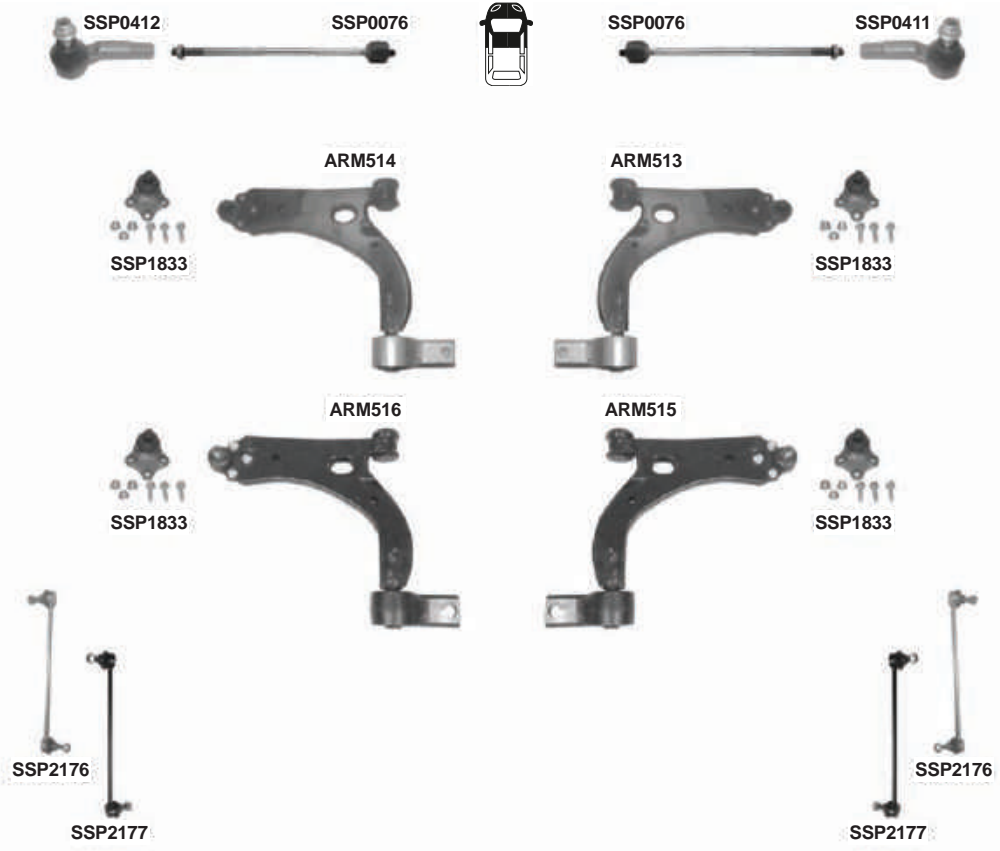

PART NO.	DESCRIPTION	NOTES	O.E.
ARM513	301181351300 Suspension Control Arm and Ball Joint Assembly - Front Right Lower		1146130; DD3234300; 1436097; 1212807
ARM514	301181351400 Suspension Control Arm and Ball Joint Assembly - Front Left Lower		1146131; DD3234350; 1436095; 1212808
ARM515	301181351500 Suspension Control Arm and Ball Joint Assembly - Front Right Lower	(Bush Casting)	Y125613042AH
ARM516	301181351600 Suspension Control Arm and Ball Joint Assembly - Front Left Lower	(Bush Casting)	Y125613051AH
SSP0076	301191600760 Steering Tie Rod - Front	M14x1,5 - L=278mm	2S6J3289AC; Y12S6C3280KB; DE9032240; 4472940; 4342539
SSP0411	301191604110 Steering Tie Rod End - Front Right	M14x1,5Rht	1202548; Y1256J3289AC; DE9032280
SSP0412	301191604120 Steering Tie Rod End - Front Left	M14x1,5Rht	1202549; Y1256J3290AC; DE9032290
SSP1833	301191618330 Suspension Ball Joint - Front Lower	D=Ø16,5mm	1679382; 2S613395AB
SSP2176	301191621760 Suspension Stabilizer Bar Link - Front	L=284mm	1146150; Y125613B438AC; DD3234170
SSP2177	301191621770 Suspension Stabilizer Bar Link - Front	(Clip-on patented design) L=284mm	Y125613B438AC*



FORD FIESTA VI



10/2008-2016



	PART NO.	DESCRIPTION	NOTES	O.E.
ARM511	301181351100	Suspension Control Arm and Ball Joint Assembly - Front Right Lower		1737309; D65134300B; 8V513042BH; 8V513042BD; BE8Z3078A
ARM512	301181351200	Suspension Control Arm and Ball Joint Assembly - Front Left Lower		1737305; D65134350B; 8V513051BH; 8V513051BD; BE8Z3079A
SSP0075	301191600750	Steering Tie Rod - Front	14x1,5 - L=294mm	1545457; 8V513L519AA
SSP0409	301191604090	Steering Tie Rod End - Front Right		1545338; 8V518C367AA; BE8Z3A130
SSP0410	301191604100	Steering Tie Rod End - Front Left		1545339; 8V513C437AA; BE8Z3A131A
SSP1832	301191618320	Suspension Ball Joint - Front Lower		1540724 Part of; Part of 1751955; Part of 1751952; Part of BE8Z3078A; Part of BE8Z3079A
SSP2174	301191621740	Suspension Stabilizer Bar Link - Front	Alm. L=251mm	1513343; D65134170; 8V513B438BA; 8V513B438AB; 1745924; 8V5Z5K484B
SSP2175	301191621750	Suspension Stabilizer Bar Link - Front	Metal - L=251mm	1513343*; D65134170*; 8V513B438AB*; 8V5Z5K484B



	PART NO.	DESCRIPTION	NOTES	O. E.
ARM511	301181351100	Suspension Control Arm and Ball Joint Assembly - Front Right Lower		1737309; D65134300B; 8V513042BH; 8V513042BD; BE8Z3078A
ARM512	301181351200	Suspension Control Arm and Ball Joint Assembly - Front Left Lower		1737305; D65134350B; 8V513051BH; 8V513051BD; BE8Z3079A
SSP0409	301191604090	Steering Tie Rod End - Front Right		1545338; 8V518C367AA; BE8Z3A130
SSP0410	301191604100	Steering Tie Rod End - Front Left		1545339; 8V513C437AA; BE823A131A
SSP1832	301191618320	Suspension Ball Joint - Front Lower		1540724 Part of; Part of 1751955; Part of 1751952; Part of BE8Z3078A; Part of BE8Z3079A
SSP2174	301191621740	Suspension Stabilizer Bar Link -	Usa type	1513343; D65134170; 8V513B438BA; 8V513B438AB; 1745924; 8V5Z5K484B
SSP2175	301191621750	Suspension Stabilizer Bar Link - Front		1513343*; D65134170*; 8V513B438AB*; 8V5Z5K484B



FORD FOCUS I



10/1998-11/2004





FORD FOCUS I



10/1998-11/2004



PART NO.	DESCRIPTION	NOTES	O.E.
ARM535	301181353500 Lateral Arm - Rear Upper		1061660; YS4Z5500AA; 1M515500AC; 98AG5500AG; 1M515500AB; 1329730; 1317609
ARM536	301181353600 Lateral Arm - Rear Lower		1061668; CV6Z5500L; 98AG5K743AF; BV615K743AA; 31277675; 2463500053; 1703145; 1753556
ARM537	301181353700 Lateral Arm - Rear Lower Rearward		1064128; 98AG5K652AK; 4M515K652AD; 30666105; 1357017
ARM538	301181353800 Suspension Control Arm and Ball Joint Assembly - Front Right Lower		1071214; 98AG3042AK; 1090730
ARM539	301181353900 Suspension Control Arm and Ball Joint Assembly - Front Left Lower		1073215; 98AG3051AK; 1090738
ARM558	301181355800 Lateral Arm - Rear Upper		1502440; 8V415500AA
SSP0083	301191600830 Steering Tie Rod - Front	M14x2 - L=343mm	1085520; YS4Z3280AA; 98AG3L519AA; 3707333
SSP0419	301191604190 Steering Tie Rod End - Front Right	M14x2Rht	1074305; 98AX3270AA; 98AG3289AA; 1107013
SSP0420	301191604200 Steering Tie Rod End - Front Left	M14x2Rht	1074306; YS4Z3A130AA; 98AX3270BA; 98AG3290AA; 1107015
SSP1835	301191618350 Suspension Ball Joint - Front	D=Ø17,5mm	1207974; 94FB3395B2A; 1212809
SSP2186	301191621860 Suspension Stabilizer Bar Link - Rear	L=115mm	1061702
SSP2187	301191621870 Suspension Stabilizer Bar Link - Rear	L=110mm	1203093; 2M515E594AA
SSP2188	301191621880 Suspension Stabilizer Bar Link - Front	Mod:1.4 SE16V Alm. L=237mm	1111769; YS413B438AB; 98AG3B438AD; 1209035
SSP2189	301191621890 Suspension Stabilizer Bar Link - Front	Only: 2.0 E16V L=237mm	1106269; YS713B438AA



FORD FOCUS II



11/2004-03/2011

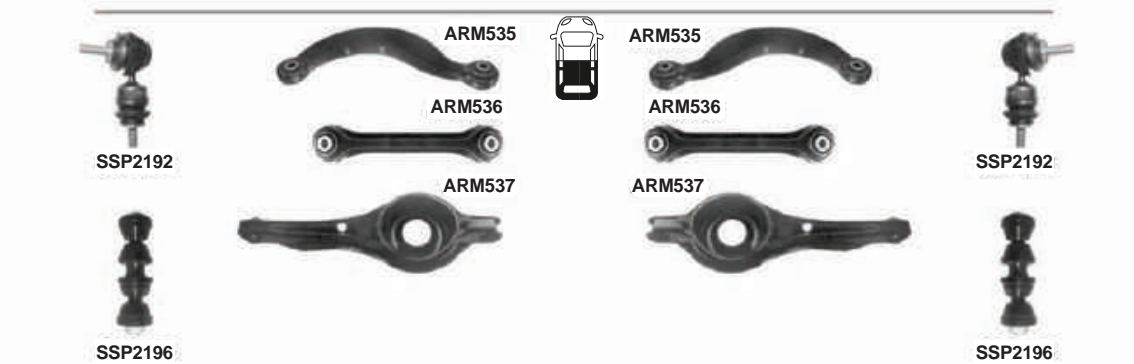
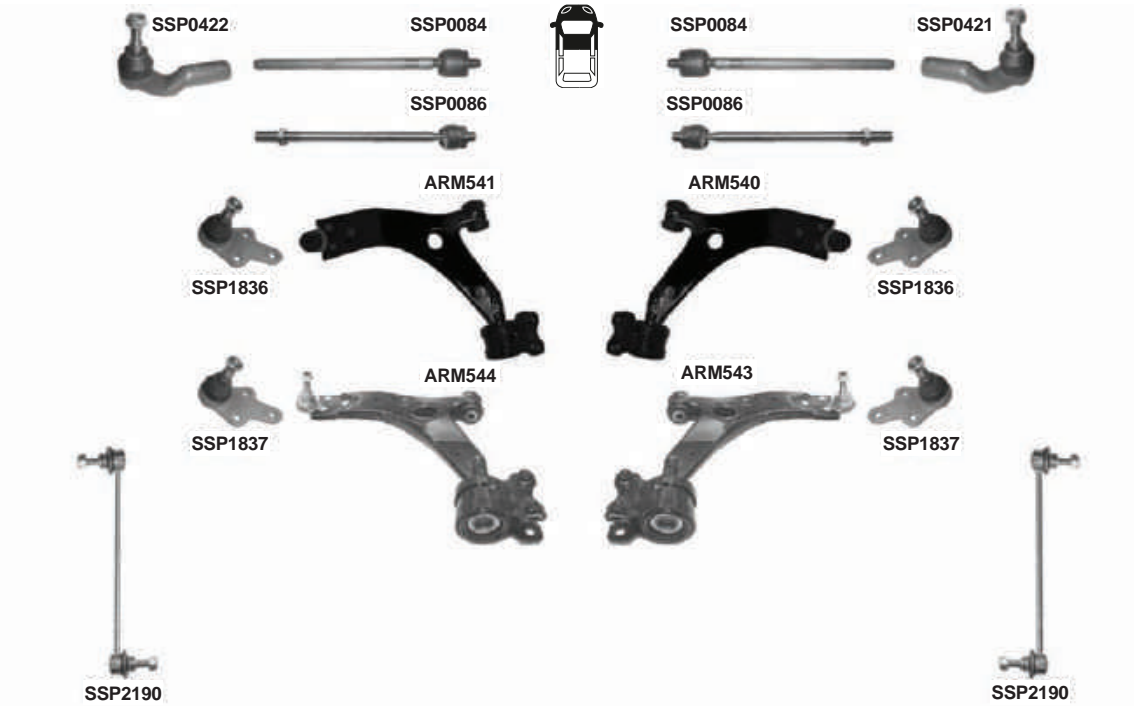



FORD FOCUS II



11/2004-03/2011

PART NO.	DESCRIPTION	NOTES	O.E.
ARM535	301181353500 Lateral Arm - Rear Upper		1061660; YS4Z5500AA; 1M515500AC; 98AG5500AG; 1M515500AB; 1329730; 1317609
ARM536	301181353600 Lateral Arm - Rear Lower		1061668; CV6Z5500L; 98AG5K743AF; BV615K743AA; 31277675; 2463500053; 1703145; 1753556
ARM537	301181353700 Lateral Arm - Rear Lower Rearward		1064128; 98AG5K652AK; 4M515K652AD; 30666105; 1357017
ARM540	301181354000 Suspension Control Arm and Ball Joint Assembly - Front Right Lower	Ball Joint D=Ø18mm	1254310; 1348191; 1328670; 1332074; 1309644; 1309148; 1305341
ARM541	301181354100 Suspension Control Arm and Ball Joint Assembly - Front Left Lower	D=Ø18mm	1254311; 1348192; 1328671; 1332075; 1309645; 1309149; 1305342
ARM543	301181354300 Suspension Control Arm and Ball Joint Assembly - Front Right	D=Ø21mm	1420859; 4M513A423AD; 4M513A423AF; 31277462; 31262037; 31201180
ARM544	301181354400 Suspension Control Arm and Ball Joint Assembly - Front Left Lower	D=Ø21mm	1420858; 4M513A424AD; 4M513A424AF; 31277463; 31262039; 30714442
ARM558	301181355800 Lateral Arm - Rear Upper		1502440; 8V415500AA
SSP0084	301191600840 Steering Tie Rod - Front Inner	M16x1.5, L=293mm	1251937; 4M513L519AB; 3M513L519AA; 3M513L519AB; 30776283; 1377655; 1317453
SSP0086	301191600860 Steering Tie Rod - Front Inner	M16x1,5 - A = L-293MM	1377655; 4M513L519AB
SSP0421	301191604210 Steering Tie Rod End - Front Right	M16x1,5Rht	1317447; 4M513289AB; 30723104; 274501; 1328877
SSP0422	301191604220 Steering Tie Rod End - Front Left	M16x1,5Rht	1317446; 30723103; 4M513290AB; 274500; 1388549; 1328881
SSP1836	301191618360 Suspension Ball Joint - Front Lower	D=17,8mm	1470387; 3M513395BC
SSP1837	301191618370 Suspension Ball Joint - Front	D=Ø15mm	1234382; 3M513K209AA
SSP2190	301191621900 Suspension Stabilizer Bar Link - Front	L=298mm	1223792; AV613B438BAN; 8623576; AV613B438AA; 3M513B438AB; 1686594; 1230909
SSP2191	301191621910 Suspension Stabilizer Bar Link - Front	(Clip-on patented design) L=298mm / L=298mm	AV613B438AA*
SSP2192	301191621920 Suspension Stabilizer Bar Link - Rear	L=76mm	1310333; BP4K28170H; BP4K28170D; BP4K28170G; 30714466; 30683232; 1335548
SSP2196	301191621960 Suspension Stabilizer Bar Link - Rear		1500682; 1719542; 8M515E494AB; 8M515E494AA



FORD FOCUS II USA made



2005-2010

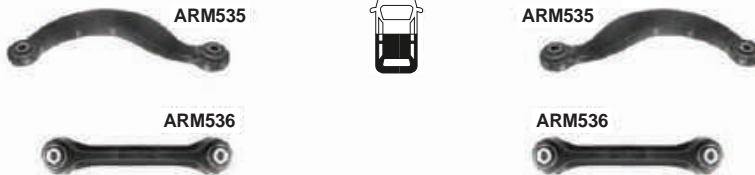

PART NO.	DESCRIPTION	NOTES	O.E.
ARM533	301181353300 Suspension Control Arm and Ball Joint Assembly - Front Right Lower		8S4Z3078A
ARM534	301181353400 Suspension Control Arm and Ball Joint Assembly - Front Left Lower		8S4Z3079A
ARM535	301181353500 Lateral Arm - Rear Upper		1061660; YS4Z5500AA; 1M515500AC; 98AG5500AG; 1M515500AB; 1329730; 1317609
ARM536	301181353600 Lateral Arm - Rear Lower		1061668; CV6Z5500L; 98AG5K743AF; BV615K743AA; 31277675; 2463500053; 1703145; 1753556
SSP0081	301191600810 Steering Tie Rod - Front	with fixed ratio.	9S4Z3280A
SSP0082	301191600820 Steering Tie Rod - Front	ithout fixed ratio. 2009-2011, with rest travel	9S4Z3280B
SSP0417	301191604170 Steering Tie Rod End - Front Right		8S4Z3A130B
SSP0418	301191604180 Steering Tie Rod End - Front Left		8S4Z3A130A
SSP1834	301191618340 Suspension Ball Joint - Front Lower		Part of 8S4Z3078A/8S4Z3079A
SSP2185	301191621850 Suspension Stabilizer Bar Link - Front		AS4Z5K484A



FORD FOCUS III



04/2011-

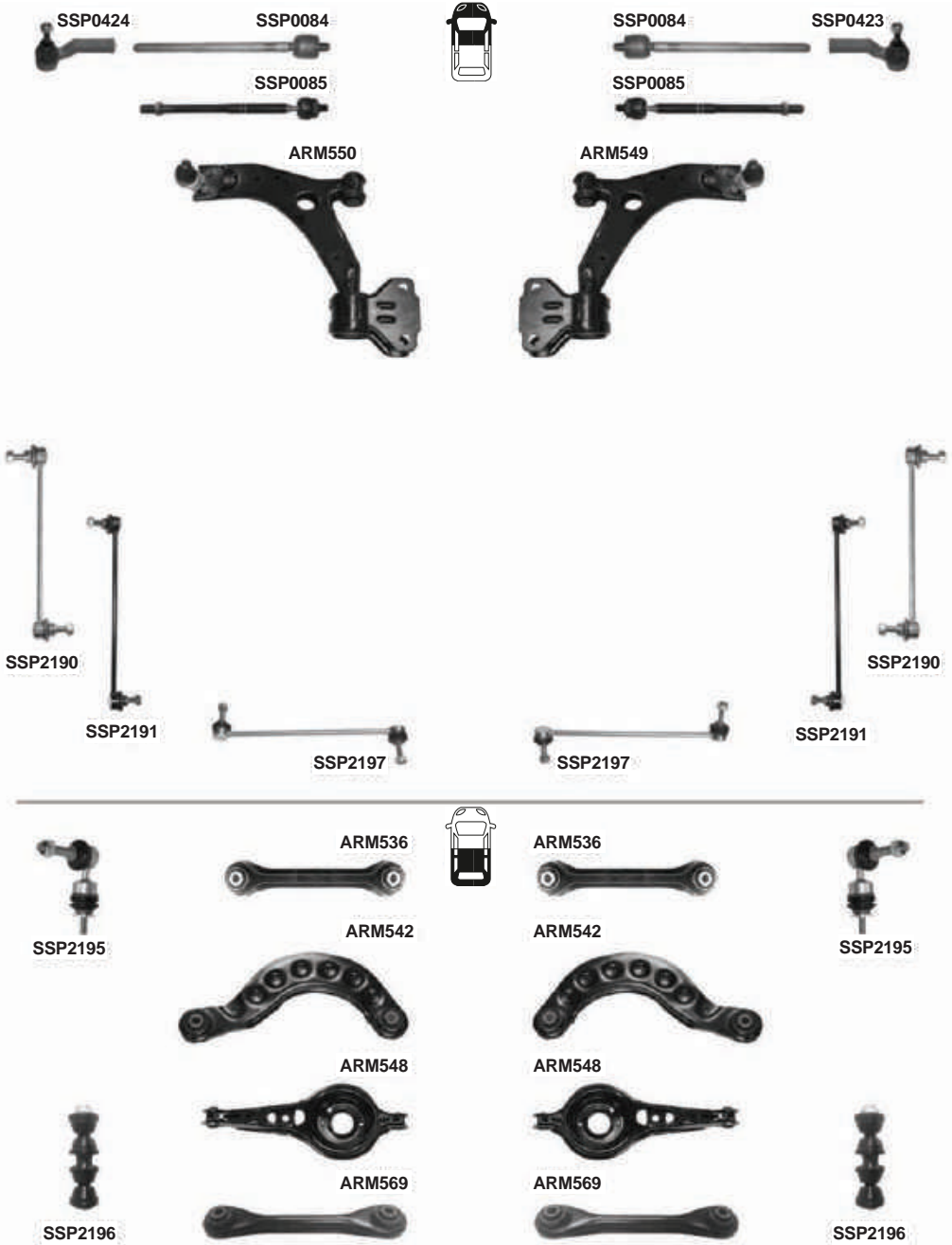



FORD FOCUS III



04/2011-

PART NO.	DESCRIPTION	NOTES	O.E.
ARM536	301181353600 Lateral Arm - Rear Lower		1061668; CV6Z5500L; 98AG5K743AF; BV615K743AA; 31277675; 2463500053; 1703145; 1753556
ARM542	301181354200 Lateral Arm - Rear Upper		1686184; AV6Z5500B; AV615500CB; 1752736
ARM548	301181354800 Lateral Arm - Rear Lower		1719019; BV615K652ED
ARM549	301181354900 Suspension Control Arm and Ball Joint Assembly - Front Right Lower		1702970; 8V613A423AAB; 8V613A423AAC
ARM550	301181355000 Suspension Control Arm and Ball Joint Assembly - Front Left Lower		1702983; BV613A424AAB; BV613A424AAC
ARM569	301181356900 Lateral Arm - Rear Lower Forward	(U.S.A Market)	BV6Z5500D
ARM570	301181357000 Suspension Control Arm and Ball Joint Assembly - Front Right Lower	Usa Market	F1FZ3078A
ARM571	301181357100 Suspension Control Arm and Ball Joint Assembly - Front Left Lower	Usa Market	F1FZ3079A
SSP0084	301191600840 Steering Tie Rod - Front Inner	M16x1.5, L=293mm	1251937; 4M513L519AB; 3M513L519AA; 3M513L519AB; 30776283; 1377655; 1317453
SSP0085	301191600850 Steering Tie Rod - Front	Type:Electrical Hydraulic Steering M16x1.5, L=300mm	1754076; BV613L519AC; BV613L519AB; 1836649; BV613L519AA; 1899978
SSP0423	301191604230 Steering Tie Rod End - Front Right	M16X1,5	1714576; 1748237; 1826501; 1780102
SSP0424	301191604240 Steering Tie Rod End - Front Left	M16X1,5	1714700; BV6C3C437BA; BV6C3C437BB; BV6Z3A130E; 1748239; 1826505; 1780103
SSP2190	301191621900 Suspension Stabilizer Bar Link - Front	L=298mm	1223792; AV613B438BAN; 8623576; AV613B438AA; 3M513B438AB; 1686594; 1230909
SSP2191	301191621910 Suspension Stabilizer Bar Link - Front	(Clip-on patented design) L=298mm / L=298mm	AV613B438AA*
SSP2195	301191621950 Suspension Stabilizer Bar Link - Rear	L=76mm	1714891; BV615C486BAA
SSP2196	301191621960 Suspension Stabilizer Bar Link - Rear		1500682; 1719542; 8M515E494AB; 8M515E494AA
SSP2197	301191621970 Suspension Stabilizer Bar Link - Front	Europe Made	AV613B438BA; AV6Z5K484B
SSP2596	301191625960 Suspension Stabilizer Bar Link - Rear	Usa Made	31317271; CV6Z5K484F; 31429024



PART NO.	DESCRIPTION	NOTES	O.E.
ARM536	301181353600 Lateral Arm - Rear Lower		1061668; CV6Z5500L; 98AG5K743AF; BV615K743AA; 31277675; 2463500053; 1703145; 1753556
ARM542	301181354200 Lateral Arm - Rear Upper		1686184; AV6Z5500B; AV615500CB; 1752736
ARM546	301181354600 Suspension Control Arm and Ball Joint Assembly - Front Right Lower	(Alm)	1749993; AV613A423MA; AV613A423PA
ARM547	301181354700 Suspension Control Arm and Ball Joint Assembly - Front Left Lower	(Alm)	1749992; AV613A424MA; AV613A424PA
ARM567	301181356700 Suspension Control Arm and Ball Joint Assembly - Front Right Lower	Usa Market, Aluminium	BV6Z3078F
ARM568	301181356800 Suspension Control Arm and Ball Joint Assembly - Front Left Lower	Usa Market, Aluminium	BV6Z3079F
SSP0074	301191600740 Steering Tie Rod - Front		AV6Z3280E
SSP0423	301191604230 Steering Tie Rod End - Front Right	M16X1,5	1714576; 1748237; 1826501; 1780102
SSP0424	301191604240 Steering Tie Rod End - Front Left	M16X1,5	1714700; BV6C3C437BA; BV6C3C437BB; BV6Z3A130E; 1748239; 1826505; 1780103



FORD FUSION



2003-2009

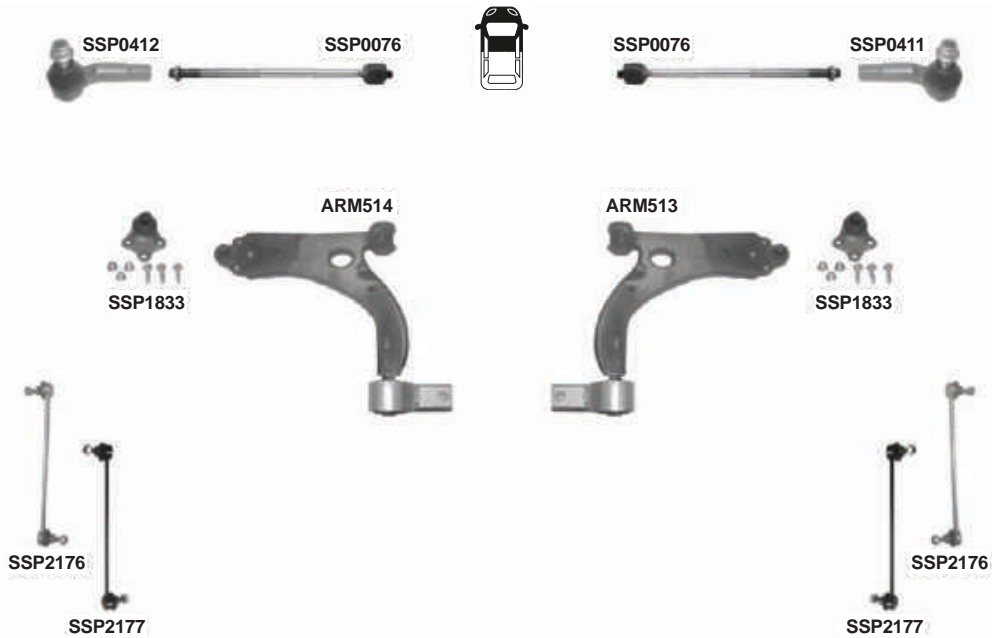

PART NO.	DESCRIPTION	NOTES	O.E.
ARM513	301181351300	Suspension Control Arm and Ball Joint Assembly - Front Right Lower	1146130; DD3234300; 1436097; 1212807
ARM514	301181351400	Suspension Control Arm and Ball Joint Assembly - Front Left Lower	1146131; DD3234350; 1436095; 1212808
SSP0076	301191600760	Steering Tie Rod - Front	M14x1,5 - L=278mm 2S6J3289AC; Y12S6C3280KB; DE9032240; 4472940; 4342539
SSP0411	301191604110	Steering Tie Rod End - Front Right	M14x1,5Rht 1202548; Y1256J3289AC; DE9032280
SSP0412	301191604120	Steering Tie Rod End - Front Left	M14x1,5Rht 1202549; Y1256J3290AC; DE9032290
SSP1833	301191618330	Suspension Ball Joint - Front Lower	D=Ø16,5mm 1679382; 2S613395AB
SSP2176	301191621760	Suspension Stabilizer Bar Link - Front	L=284mm 1146150; Y125613B438AC; DD3234170
SSP2177	301191621770	Suspension Stabilizer Bar Link - Front	(Clip-on patented design) L=284mm Y125613B438AC*



FORD FUSION 1st Gen USA made



2006-2012

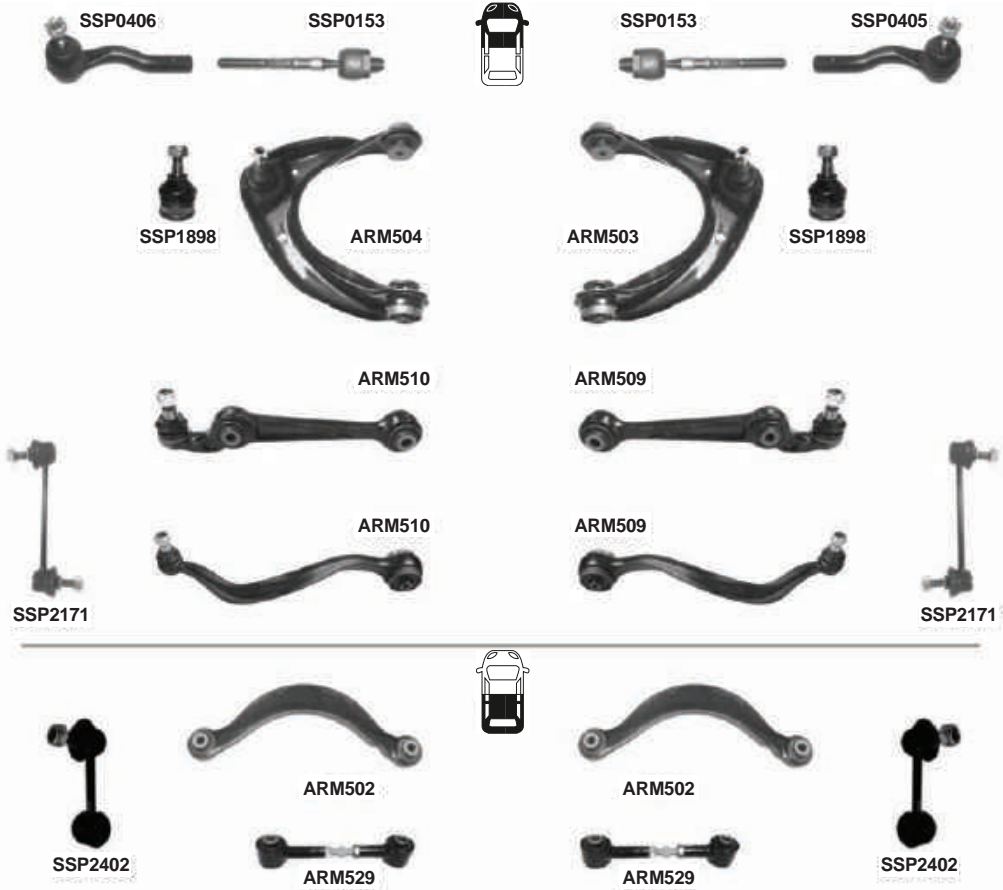

PART NO.	DESCRIPTION	NOTES	O.E.
ARM502 301181350200	Lateral Arm - Rear Upper		AE5Z5500A; G26A28C10
ARM503 301181350300	Suspension Control Arm and Ball Joint Assembly - Front Right Upper		AE5Z3084A
ARM504 301181350400	Suspension Control Arm and Ball Joint Assembly - Front Left Upper		AE5Z3085A
ARM505 301181350500	Suspension Control Arm and Ball Joint Assembly - Front Lower		AE5Z3078A
ARM509 301181350900	Suspension Control Arm and Ball Joint Assembly - Front Right		BE5Z3078B; 7E5Z3078L; GJ6A34J00D; GJ6A34J00C; GJ6A34J00B
ARM510 301181351000	Suspension Control Arm and Ball Joint Assembly - Front Left		BE5Z3079B; 7E5Z3079L; GJ6A34J50D; GJ6A34J50C; GJ6A34J50B
ARM529 301181352900	Lateral Arm - Rear Lower		9E5Z5500A; G26A28500A; G26A28500D; G26A28500B; G62A28500B; GJ6A28500D; GK2A28500
SSP0153 301191601530	Steering Tie Rod - Front		6E5Z3332B; GJ6E32240
SSP0405 301191604050	Steering Tie Rod End - Front Right		AE5Z3A130B
SSP0406 301191604060	Steering Tie Rod End - Front Left		AE5Z3A130A
SSP1898 301191618980	Suspension Ball Joint - Front Upper		GJ6A34540
SSP2171 301191621710	Suspension Stabilizer Bar Link - Front		AE5Z5K483A
SSP2402 301191624020	Suspension Stabilizer Bar Link - Rear		5M8Z5A486A; GJ6A28170A

**FORD FUSION 2nd Gen****2013-****SSP0431****SSP0430**

	PART NO.	DESCRIPTION	NOTES	O.E.
ARM564	301181356400	Suspension Control Arm and Ball Joint Assembly - Front Right	ALM. Usa Made	1927131; FG9C3A052ANB; GS7Z3079A
ARM565	301181356500	Suspension Control Arm and Ball Joint Assembly - Front Left	ALM. Usa Made	1927132; FG9C3A053ANB; GS7Z3078A
SSP0093	301191600930	Steering Tie Rod - Front		DG9Z3280A
SSP0430	301191604300	Steering Tie Rod End - Front Right	Usa Market	DG9Z3A130A
SSP0431	301191604310	Steering Tie Rod End - Front Left	Usa Market	DG9Z3A130B
SSP2183	301191621830	Suspension Stabilizer Bar Link - Front		5182780; DG9Z5C486A; DG9Z5K484A; DG9C3B438ANC
SSP2184	301191621840	Suspension Stabilizer Bar Link - Rear		5182818; DG9C5C486AXC



FORD GALAXY



05/1995-04/2006

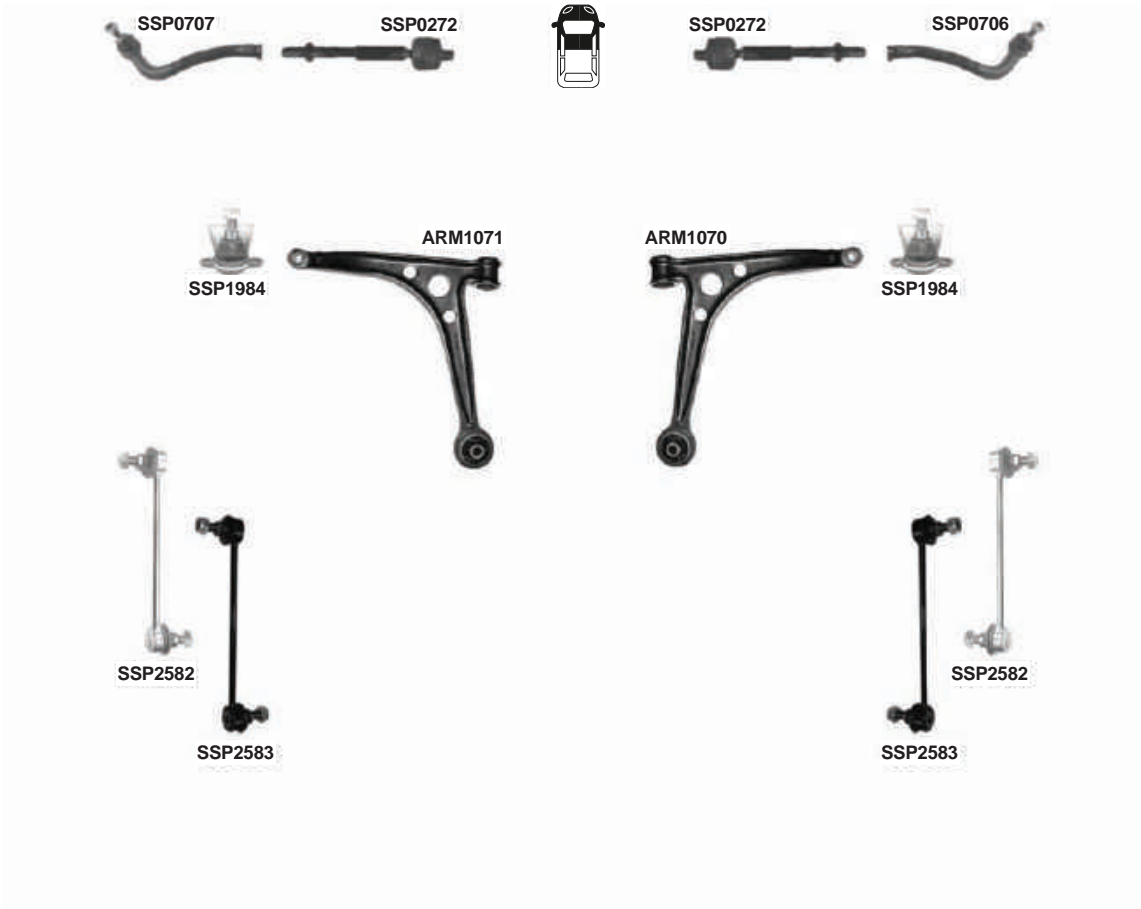

PART NO.	DESCRIPTION	NOTES	O.E.
ARM1070 301181310700	Suspension Control Arm - Front Right Lower		1012632; 95VW3078AC; 7M0407152B
ARM1071 301181310710	Suspension Control Arm - Front Left		1007602; 95VW3079AC; 7M0407151B
SSP0272 301191602720	Steering Tie Rod - Front Inner	M14x1,5 - L=182.5mm	7M0422803/4EF
SSP0706 301191607060	Steering Tie Rod End - Front Right	M14x1,5Rht	1092378; 7M0422818B; 7M0422818
SSP0707 301191607070	Steering Tie Rod End - Front Left	M14x1,5Rht	1092380; 7M0422817B; 7M0422817
SSP1984 301191619840	Suspension Ball Joint - Front		7200946 7M0407365A; YM213395BA; 7M3407365A
SSP2582 301191625820	Suspension Stabilizer Bar Link - Front	L=205mm	1009591; 95VW5489AC; 7M0411317D
SSP2583 301191625830	Suspension Stabilizer Bar Link - Front	(Clip-on patented design) L=205mm	1009591*; 95VW5489AC*



FORD GALAXY



05/2006-

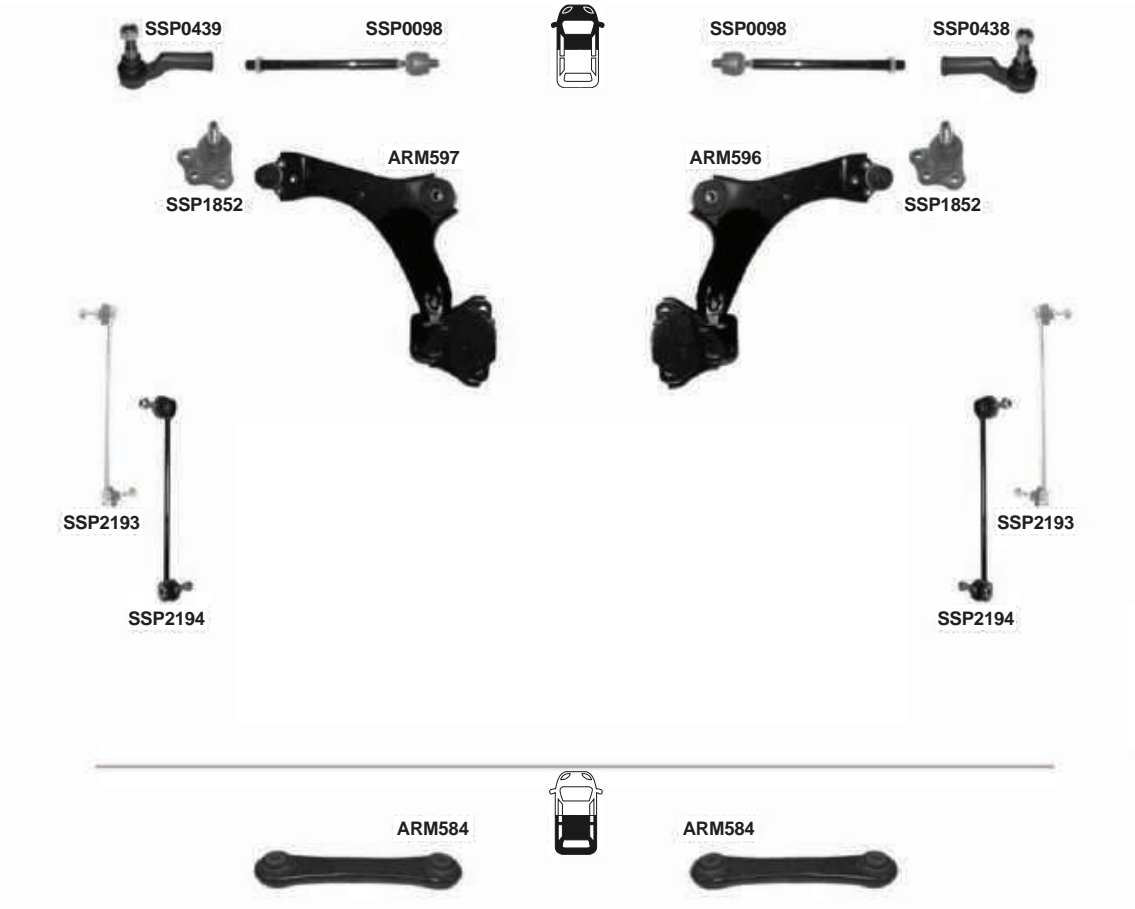

PART NO.	DESCRIPTION	NOTES	O.E.
ARM584	301181358400 Lateral Arm - Rear	L=194,5	1377449; 1381843; 6G915K743XAD
ARM596	301181359600 Suspension Control Arm and Ball Joint Assembly - Front Right Lower		1469024; 7G9N3A052BA; 1507181; 31317662; 31277344
ARM597	301181359700 Suspension Control Arm and Ball Joint Assembly - Front Left Lower		1469026; 7G9N3A053BA; 31277343; 1507182; 31200448; 30760720
SSP0098	301191600980 Steering Tie Rod - Front	M18x1,5 - L=315mm	1433271; 6G913280AB
SSP0438	301191604380 Steering Tie Rod End - Front Right	M18x1,5	1433273; LR002609; 30776248; 6G913290AA; 31280001
SSP0439	301191604390 Steering Tie Rod End - Front Left	M18x1,5	1433274; LR002610; 30776249; 6G913289AA; 31280001
SSP1852	301191618520 Suspension Ball Joint - Front		1469026 Part of; 30671637 Part of; 6G9N3395AA Part of
SSP2193	301191621930 Suspension Stabilizer Bar Link - Front	L=300mm	1377849; 6G9N3B438BA; 30648461
SSP2194	301191621940 Suspension Stabilizer Bar Link - Front	(Clip-on patented design) L=300mm	6G9N3B438BA*

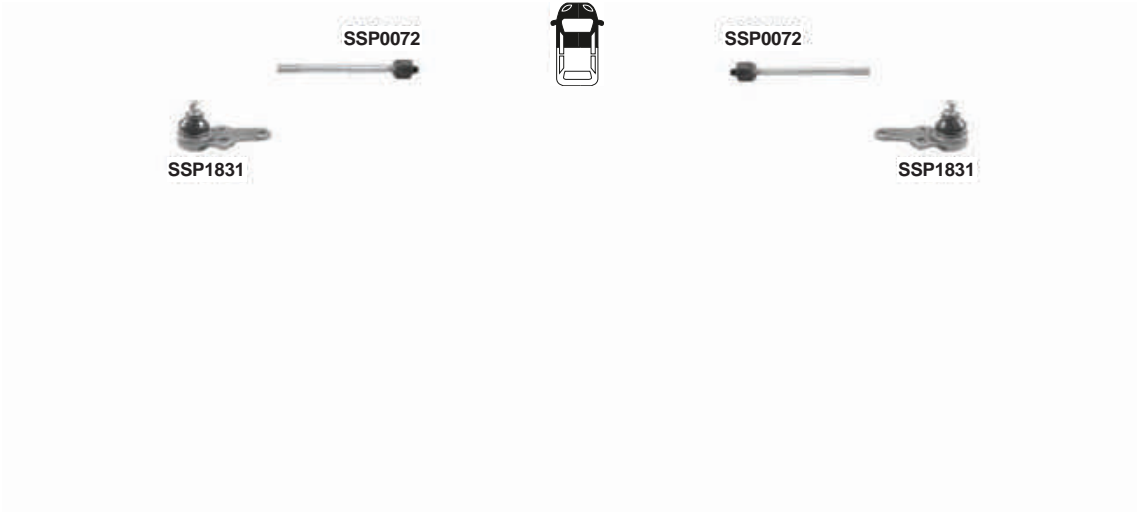

	PART NO.	DESCRIPTION	NOTES	O.E.
SSP0072	301191600720	Steering Tie Rod - Front	M14x2 - L=313mm	1044014; B196FB3L519BA; 1E0032240
SSP1831	301191618310	Suspension Ball Joint - Front	D=Ø16.5 mm	1030025; 94FB3395A2B; 1047797



FORD KA RB



1996-2008



SSP0413

SSP0077



SSP0077

SSP0413



SSP0078



SSP0078



ARM522



ARM521



SSP1831



ARM524



ARM523



SSP1831



SSP1831



ARM526



ARM525



SSP1831



SSP1831



ARM528



ARM527



SSP1831



SSP2178



SSP2178



FORD KA RB



1996-2008

PART NO.	DESCRIPTION	NOTES	O.E.
ARM521	301181352100 Suspension Control Arm and Ball Joint Assembly - Front Right Lower	Manual Steering	1032098
ARM522	301181352200 Suspension Control Arm and Ball Joint Assembly - Front Left Lower	Manual Steering	1032101
ARM523	301181352300 Suspension Control Arm and Ball Joint Assembly - Front Right Lower	Power Steerin Manual	1032100; 97KB3486GA; 97KB3042FB; 97KB3042DB; 97KB3042BD
ARM524	301181352400 Suspension Control Arm and Ball Joint Assembly - Front Left Lower	Power Steering	1032102; 97KB3051FB; 97KB3051DB
ARM525	301181352500 Suspension Control Arm and Ball Joint Assembly - Front Right Lower	Manual Steering	1063987; 97KB3042BD
ARM526	301181352600 Suspension Control Arm and Ball Joint Assembly - Front Left Lower	Manual Steering	1063988; 97KB3051FB
ARM527	301181352700 Suspension Control Arm and Ball Joint Assembly - Front Right Lower	Power Steering	1028438; 97KB3042AC; 1063985
ARM528	301181352800 Suspension Control Arm and Ball Joint Assembly - Front Left Lower	Power Steering	1028443; 97KB3051AC; 1063986
SSP0077	301191600770 Steering Tie Rod - Front Inner	½"x20 - L=300mm	4048739; XS5C3L519AA; 6790700
SSP0078	301191600780 Steering Tie Rod - Front	only 1.6 LT 495gr	1250339
SSP0413	301191604130 Steering Tie Rod End - Front	½"x20	1032689; 1034417
SSP1831	301191618310 Suspension Ball Joint - Front	D=Ø16.5 mm	1030025; 94FB3395A2B; 1047797
SSP2178	301191621780 Suspension Stabilizer Bar Link - Front	L=237mm	1061631; 1S613B438AA; 98AG3B438AB; 1E0034170; 1661237; 1130273

**FORD KA II**

12/2008-

**SSP1413****SSP1412****ARM476****ARM475****SSP1313****ARM531****ARM530****SSP1313**

PART NO.	DESCRIPTION	NOTES	O.E.
ARM475 301181347500	Suspension Control Arm and Ball Joint Assembly - Front Right Lower		1540724; 9S513078BC; 50710621; 50709580
ARM476 301181347600	Suspension Control Arm and Ball Joint Assembly - Front Left		1540725; 9S513078AC; 50710620; 50709579
ARM530 301181353000	Suspension Control Arm and Ball Joint Assembly - Front Right	Type : MKII	1639575; 9S513078BC
ARM531 301181353100	Suspension Control Arm and Ball Joint Assembly - Front Left Lower	Type : MKII	1639574; 9S513078AC
SSP1313 301181313130	Suspension Stabilizer Bar Link - Front	L=287mm	1580517; 9S515K484AB; 51801136
SSP1412 301181314120	Steering Tie Rod End - Front Right	M12x1,5Rht	1546260; 9S513270BA; 77362508
SSP1413 301181314130	Steering Tie Rod End - Front Left	M12x1,5Rht	1546259; 9S513270AA; 77362507



FORD KUGA I



02/2008-02/2013

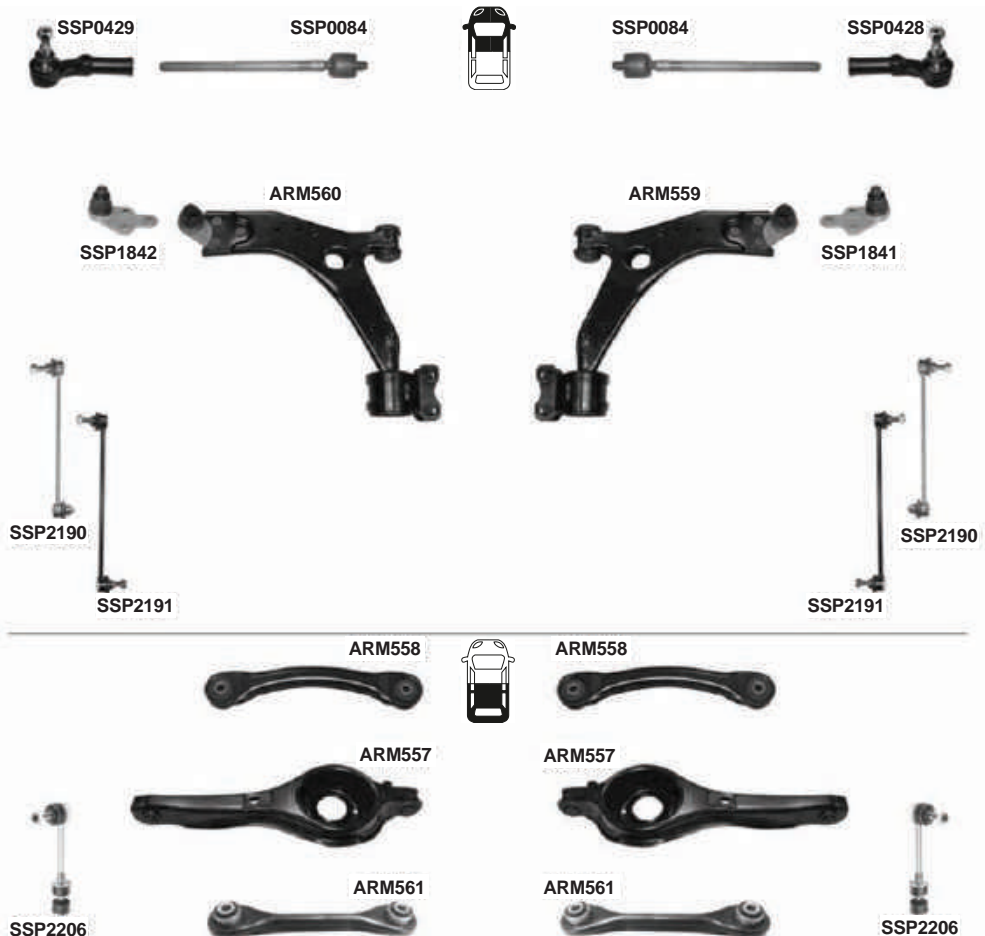

PART NO.	DESCRIPTION	NOTES	O.E.
ARM557 301181355700	Lateral Arm - Rear Lower		1502729; 8V415K652AA
ARM558 301181355800	Lateral Arm - Rear Upper		1502440; 8V415500AA
ARM559 301181355900	Suspension Control Arm and Ball Joint Assembly - Front Right Lower		1723323; 8V413A423AC
ARM560 301181356000	Suspension Control Arm and Ball Joint Assembly - Front Left Lower		1723324; 8V413A424AC
ARM561 301181356100	Lateral Arm - Rear Upper	L=223 mm	1500111; 8V415K743AA
SSP0084 301191600840	Steering Tie Rod - Front Inner	M16x1,5 - L=293mm	1251937; 4M513L519AB; 3M513L519AA; 3M513L519AB; 30776283; 1377655; 1317453
SSP0428 301191604280	Steering Tie Rod End - Front Right	M16X1,5	1541485; 8V413C367AA
SSP0429 301191604290	Steering Tie Rod End - Front Left	M16X1,5	1541488; 8V413C437AA
SSP1841 301191618410	Suspension Ball Joint - Front Right Lower		Part of 1723323
SSP1842 301191618420	Suspension Ball Joint - Front Left Lower		Part of 1723324
SSP2190 301191621900	Suspension Stabilizer Bar Link - Front	L=298mm	1223792; AV613B438BAN; 8623576; AV613B438AA; 3M513B438AB; 1686594; 1230909
SSP2191 301191621910	Suspension Stabilizer Bar Link - Front	(Clip-on patented design) L=298mm	AV613B438AA*
SSP2206 301191622060	Suspension Stabilizer Bar Link - Rear	L=179mm	1502681; 8V415C486AA; CV615C486AAB



FORD KUGA II



03/2013-



PART NO.	DESCRIPTION	NOTES	O.E.
ARM558	301181355800 Lateral Arm - Rear Upper		1502440; 8V415500AA
ARM562	301181356200 Suspension Control Arm and Ball Joint Assembly - Front Right Lower		1793236; CV613A423AAC; CV6Z3079F
ARM563	301181356300 Suspension Control Arm and Ball Joint Assembly - Front Left Lower		1793237; CV613A424AAC; CV6Z3078C
ARM598	301181359800 Lateral Arm - Rear Lower		1782008; CV615K652AAA; CV6Z5500J
SSP0092	301191600920 Steering Tie Rod - Front	M16X1,5 - L=293mm	1714484; AV6C3L519BA; AV6C3L519BAN; AV6C3L519AA; 1715414; 31317779; 1780104
SSP0423	301191604230 Steering Tie Rod End - Front Right	M16X1,5	1714576; 1748237; 1826501; 1780102
SSP0424	301191604240 Steering Tie Rod End - Front Left	M16X1,5	1714700; BV6C3C437BA; BV6C3C437BB; BV6Z3A130E; 1748239; 1826505; 1780103
SSP2190	301191621900 Suspension Stabilizer Bar Link - Front	L=298mm	1223792; AV613B438BAN; 8623576; AV613B438AA; 3M513B438AB; 1686594; 1230909
SSP2206	301191622060 Suspension Stabilizer Bar Link - Rear	L=179mm	1502681; 8V415C486AA; CV615C486AAB

FORD MONDEO II



06/1996-10/2000



PART NO.	DESCRIPTION	NOTES	O.E.
SSP0097 301191600970	Steering Tie Rod - Front	M16*1,5 - L=340mm	1S713B438BB; 1S7C3280BB; 7294416; 3903147
SSP2217 301191622170	Suspension Stabilizer Bar Link - Front	L=237,5mm	1S713B438AC; 2T1Z5K484AA; 6960036; 93BB3B438CA; 7T1Z5K484A
SSP2218 301191622180	Suspension Stabilizer Bar Link - Front	(Clip-on patented design) L=237,5mm	6960036*



FORD MONDEO III



11/2000-03/2007

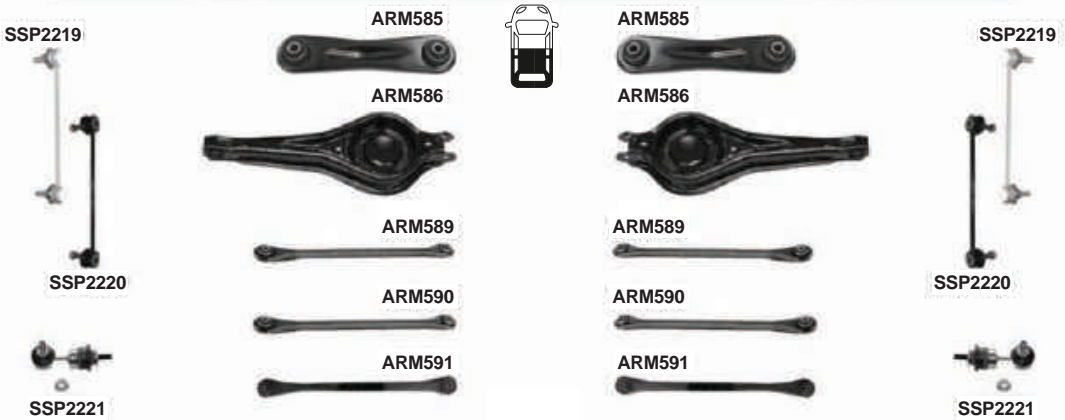
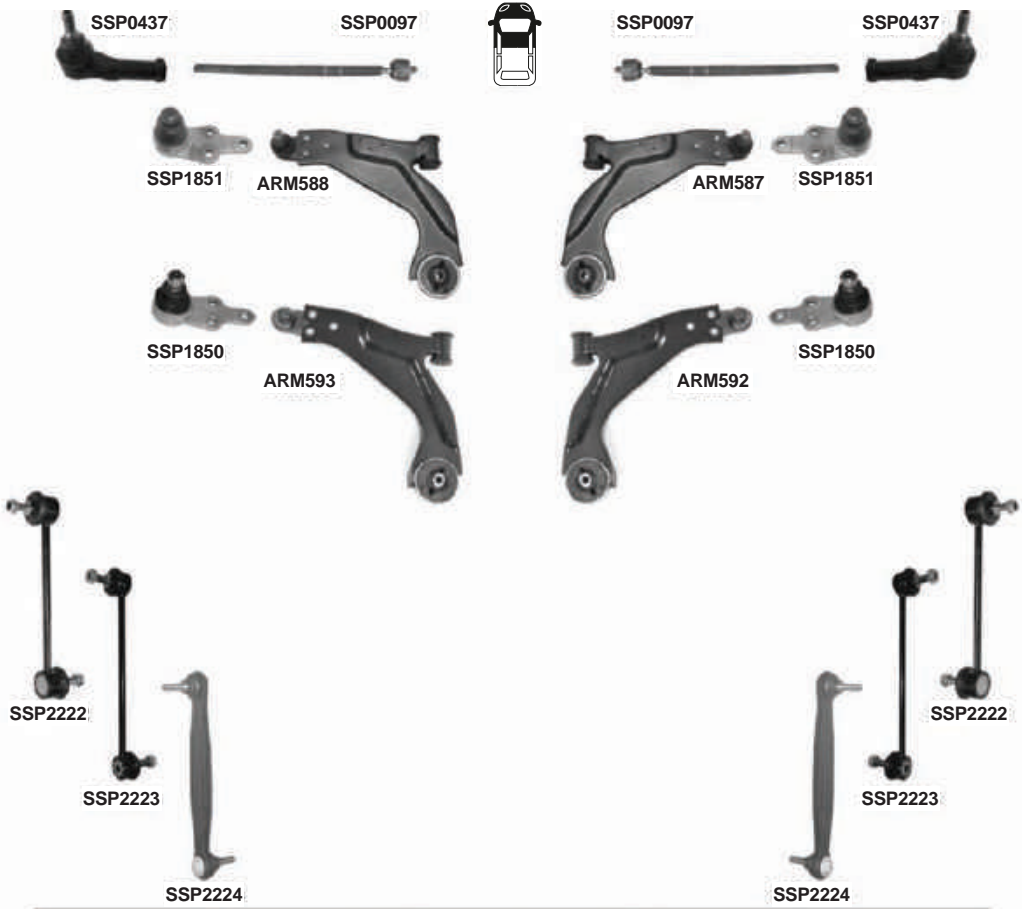

FORD MONDEO III



11/2000-03/2007

PART NO.	DESCRIPTION	NOTES	O.E.
ARM585	301181358500 Lateral Arm - Rear Lower Forward		1220005; 1230619; 1S715K743CA
ARM586	301181358600 Lateral Arm - Rear Lower		1214290; 1S715K652CA
ARM587	301181358700 Suspension Control Arm and Ball Joint Assembly - Front Right Lower		1203923; 1S713042AN; 1S713042AP; 1S713042AM; 1311416; 1S713042AK; 1S713042AH
ARM588	301181358800 Suspension Control Arm and Ball Joint Assembly - Front Left Lower		1203924; 1S713051AN; 1S713051AP; 1S713051AM; 1311417; 1S713051AK; 1S713051AH
ARM589	301181358900 Lateral Arm - Rear Upper Forward		1117859; 1118921; 1S715K743AC; 1S715K743AB
ARM590	301181359000 Lateral Arm - Rear Upper Rearward	L=600 mm	1117857; 1118920; 1S715K652AC; 1S715K652AB
ARM591	301181359100 Lateral Arm - Rear Lower	L=575mm	1124242; 1206474
ARM592	301181359200 Suspension Control Arm and Ball Joint Assembly - Front Right Lower	2.2 TDCI	1S713042AL/AM/AK
ARM593	301181359300 Suspension Control Arm and Ball Joint Assembly - Front Left Lower	2.2 TDCI	1S713051AL/AM/AK
SSP0097	301191600970 Steering Tie Rod - Front	M16*1,5 - L=340mm	1S713B438BB; 1S7C3280BB; 7294416; 3903147
SSP0437	301191604370 Steering Tie Rod End - Front	M16x1,5Rht	1138314; C2S12013; 1S713290AB; 1X433289AB; 1S713290BB
SSP1850	301191618500 Suspension Ball Joint - Front Lower	2.2 TDCI D=Ø21mm	1S713395AF
SSP1851	301191618510 Suspension Ball Joint - Front	D=Ø21mm	1679376; C2S8390; 1X43395AB; C2S37075; C2S19367
SSP2219	301191622190 Suspension Stabilizer Bar Link - Rear		1127648; 1S715C486AD
SSP2220	301191622200 Suspension Stabilizer Bar Link - Rear	(Clip-on patented design)	1103452; 1127648; 1S715C486AD
SSP2221	301191622210 Suspension Stabilizer Bar Link - Rear	Only : SW 1,8 SFI L=51mm	1130452; 1S715C486BE
SSP2222	301191622220 Suspension Stabilizer Bar Link - Front	Metal L=249mm	1127646; 1S713B438AC; SX433B438AA; C2S26883
SSP2223	301191622230 Suspension Stabilizer Bar Link - Front	Metal (Clip-on patented design) L=249mm	1117698; 1127646; C2S26883
SSP2224	301191622240 Suspension Stabilizer Bar Link - Front	Plastic L=250mm	1219698; 1S13B438BA; C2S26883; 5X433B438AA



FORD MONDEO IV



04/2007-08/2014

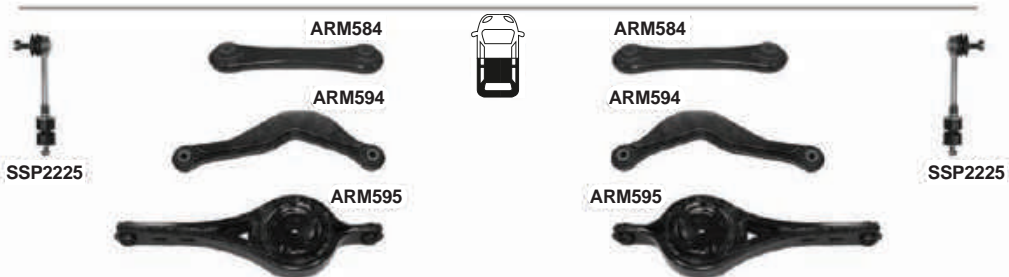

PART NO.	DESCRIPTION	NOTES	O.E.
ARM584	301181358400 Lateral Arm - Rear	L=194,5	1377449; 1381843; 6G915K743XAD
ARM594	301181359400 Lateral Arm - Rear Upper		1457609; 6G915500BAA
ARM595	301181359500 Lateral Arm - Rear		1469125; 6G915K652XAE
ARM596	301181359600 Suspension Control Arm and Ball Joint Assembly - Front Right Lower		1469024; 7G9N3A052BA; 1507181; 31317662; 31277344
ARM597	301181359700 Suspension Control Arm and Ball Joint Assembly - Front Left Lower		1469026; 7G9N3A053BA; 31277343; 1507182; 31200448; 30760720
SSP0098	301191600980 Steering Tie Rod - Front	M18x1,5 - L=315mm	1433271; 6G913280AB
SSP0438	301191604380 Steering Tie Rod End - Front Right	M18x1,5	1433273; LR002609; 30776248; 6G913290AA; 31280001
SSP0439	301191604390 Steering Tie Rod End - Front Left	M18x1,5	1433274; LR002610; 30776249; 6G913289AA; 31280001
SSP1852	301191618520 Suspension Ball Joint - Front		1469026 Part of; 30671637 Part of; 6G9N3395AA Part of
SSP2193	301191621930 Suspension Stabilizer Bar Link - Front	L=300mm	1377849; 6G9N3B438BA; 30648461
SSP2194	301191621940 Suspension Stabilizer Bar Link - Front	(Clip-on patented design) L=300mm	6G9N3B438BA*
SSP2225	301191622250 Suspension Stabilizer Bar Link - Rear	L=116mm	1377416; 1425853; 6G91SC486XAB; 30760678



PART NO.	DESCRIPTION	NOTES	O.E.
ARM532	301181353200 Lateral Arm - Rear Upper		DG9C5500BXA
ARM564	301181356400 Suspension Control Arm and Ball Joint Assembly - Front Right	ALM. Europe made	1927131; FG9C3A052ANB; GS7Z3079A
ARM565	301181356500 Suspension Control Arm and Ball Joint Assembly - Front Left	ALM. Europe Made	1927132; FG9C3A053ANB; GS7Z3078A
ARM566	301181356600 Lateral Arm - Rear Upper		DG9Z5500A
SSP0080	301191600800 Steering Tie Rod - Front	Europen made, (Electric power steering)	1824228; DG9C3D032BA
SSP0415	301191604150 Steering Tie Rod End - Front Right	B = M14X2	1802974; DG9C3289CA
SSP0416	301191604160 Steering Tie Rod End - Front Left	B = M14X2	1802977; DG9C3290CA
SSP2183	301191621830 Suspension Stabilizer Bar Link - Front		5182780; DG9Z5C486A; DG9Z5K484A; DG9C3B438ANC
SSP2184	301191621840 Suspension Stabilizer Bar Link - Rear		5182818; DG9C5C486AXC



FORD MUSTANG 4th Gen



1994-2004



PART NO.	DESCRIPTION	NOTES	O.E.
SSP2118 301191621180	Suspension Stabilizer Bar Link - Front		6W1Z5664AA; 4656260AA; 25747956; 15963924

FORD MUSTANG 5th Gen



2005-2010

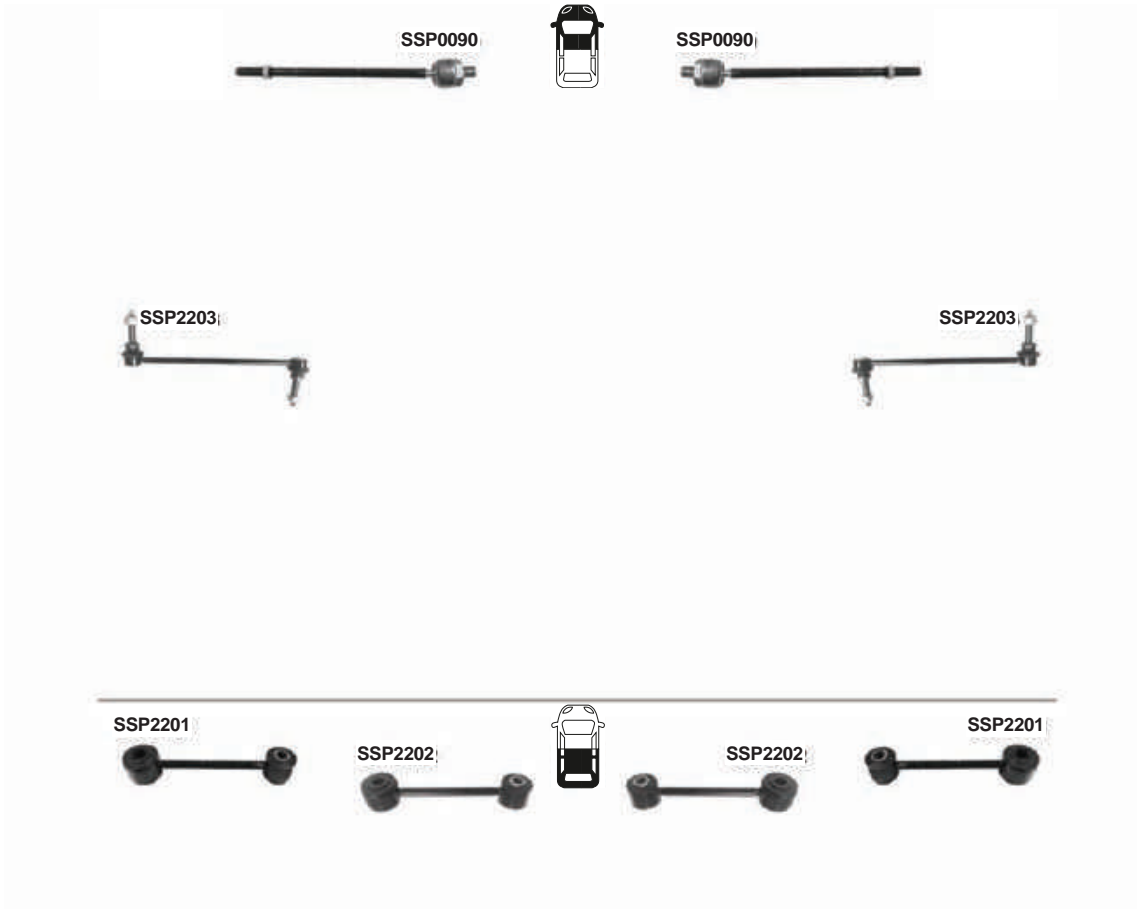

PART NO.	DESCRIPTION	NOTES	O.E.
SSP0090 301191600900	Steering Tie Rod - Front	POWER - HYDRAULIC. Mustang 2010.	9R3Z3280B
SSP2201 301191622010	Suspension Stabilizer Bar Link - Rear	Mustang. Shelby. with upsized stabilizer	5R3Z5C488AA
SSP2202 301191622020	Suspension Stabilizer Bar Link - Rear	Mustang sally package. Coupe,Base, gt, convertible.	5R3Z5C488BA
SSP2203 301191622030	Suspension Stabilizer Bar Link - Front		8R3Z5K483A; 8R3Z5K483B



FORD MUSTANG 5th Gen



2005-2015



PART NO.	DESCRIPTION	NOTES	O.E.
SSP1839 301191618390	Suspension Ball Joint - Front Lower		Part of 4R3Z3078B; Part of 4R3Z3079B
SSP1840 301191618400	Suspension Ball Joint - Front Lower		CR3Z3078D



FORD MUSTANG 5th Gen



2010-2015

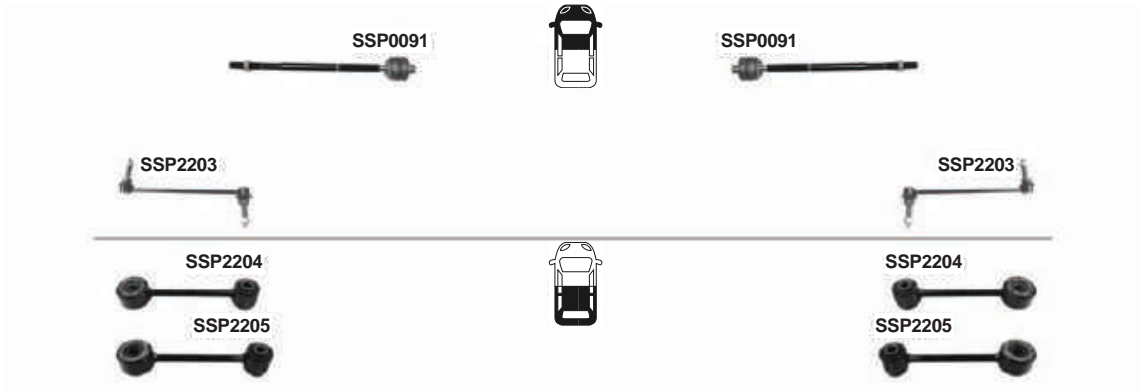

PART NO.	DESCRIPTION	NOTES	O.E.
SSP0091 301191600910	Steering Tie Rod - Front	POWER - ELECTRIC. Mustang 2011-14, with 17 wheels.	BR3Z3280A; BR3Z3280B
SSP0424 301191604240	Steering Tie Rod End - Front Left	M16X1,5	1714700; BV6C3C437BA; BV6C3C437BB; BV6Z3A130E; 1748239; 1826505; 1780103
SSP2203 301191622030	Suspension Stabilizer Bar Link - Front		8R3Z5K483A; 8R3Z5K483B
SSP2204 301191622040	Suspension Stabilizer Bar Link - Rear	Coupe; w/o Special Vehicle Package	CR3Z5C488Q
SSP2205 301191622050	Suspension Stabilizer Bar Link - Rear	Without performance package.	CR3Z5C488R



FORD MUSTANG 6th Gen



2013-2016

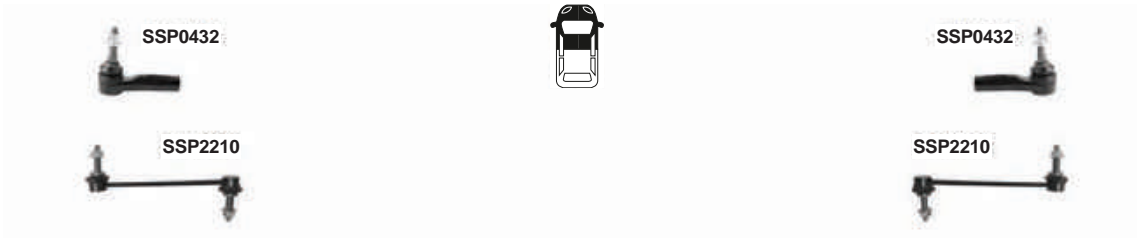

PART NO.	DESCRIPTION	NOTES	O.E.
SSP0089 301191600890	Steering Tie Rod - Front	standart	FL3Z3280A; FR3Z3280A; GR3Z3280C
SSP0432 301191604320	Steering Tie Rod End - Front		FR3Z3A130A
SSP2210 301191622100	Suspension Stabilizer Bar Link - Front	Steel Type	FR3Z5K483A



FORD POLICE INTERCEPTOR UTILITY  **2013-2016**

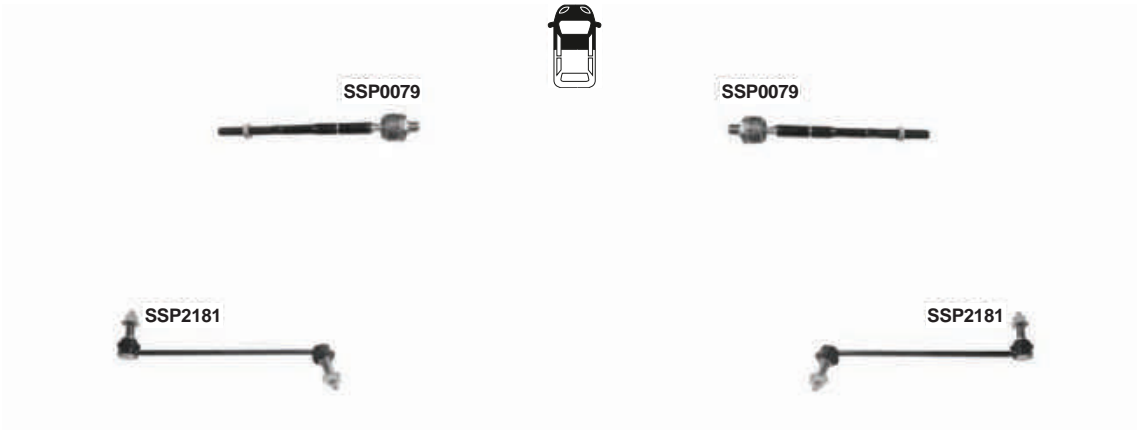

PART NO.	DESCRIPTION	NOTES	O.E.
SSP0079 301191600790	Steering Tie Rod - Front		BB5Z3280A
SSP2181 301191621810	Suspension Stabilizer Bar Link - Front Right		BB5Z5K484A
SSP2182 301191621820	Suspension Stabilizer Bar Link - Front Left		BB5Z5K483A

**FORD PUMA**

03/1997-06/2002

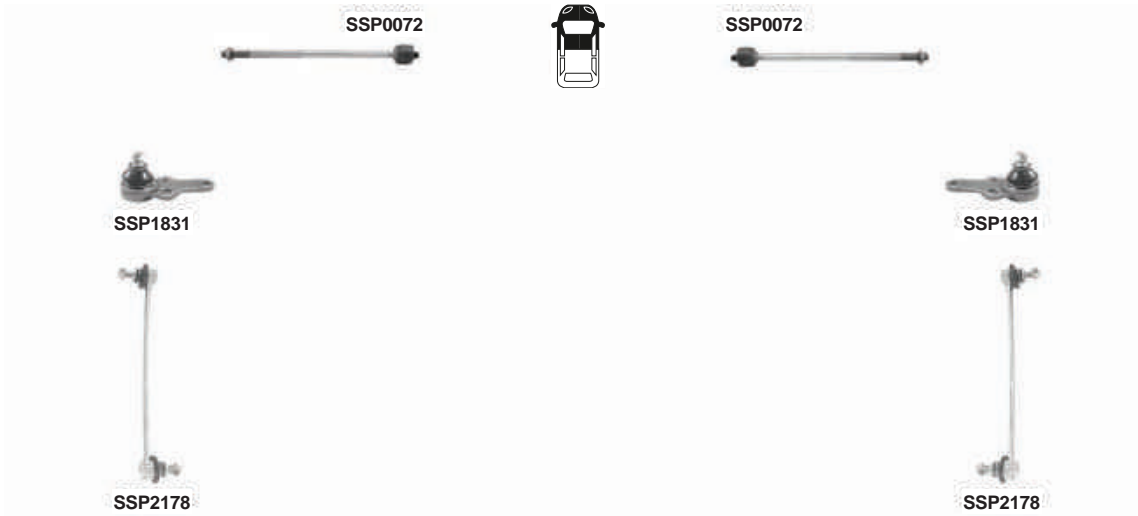

PART NO.	DESCRIPTION	NOTES	O.E.
SSP0072 301191600720	Steering Tie Rod - Front	M14x2 - L=313mm	1044014; B196FB3L519BA; 1E0032240
SSP1831 301191618310	Suspension Ball Joint - Front	D=Ø16.5 mm	1030025; 94FB3395A2B; 1047797
SSP2178 301191621780	Suspension Stabilizer Bar Link - Front	L=237mm	1061631; 1S613B438AA; 98AG3B438AB; 1E0034170; 1661237; 1130273



PART NO.	DESCRIPTION	NOTES	O.E.
ARM501 301181350100	Suspension Control Arm and Ball Joint Assembly - Front Left Upper		2L5Z3083AA



FORD RANGER I USA made



1998-2003



SSP1843



SSP1843

PART NO.	DESCRIPTION	NOTES	O.E.
SSP1843 301191618430	Suspension Ball Joint - Front Upper		Part of 104230; Part of F5TZ3082A



PART NO.	DESCRIPTION	NOTES	O.E.
SSP1830 301191618300	Suspension Ball Joint - Front Lower		BL5Z3050A



FORD RANGER II



06/2006-03/2011



PART NO.	DESCRIPTION	NOTES	O.E.
SSP1830 301191618300	Suspension Ball Joint - Front Lower		BL5Z3050A



FORD S-MAX WA6

05/2006-

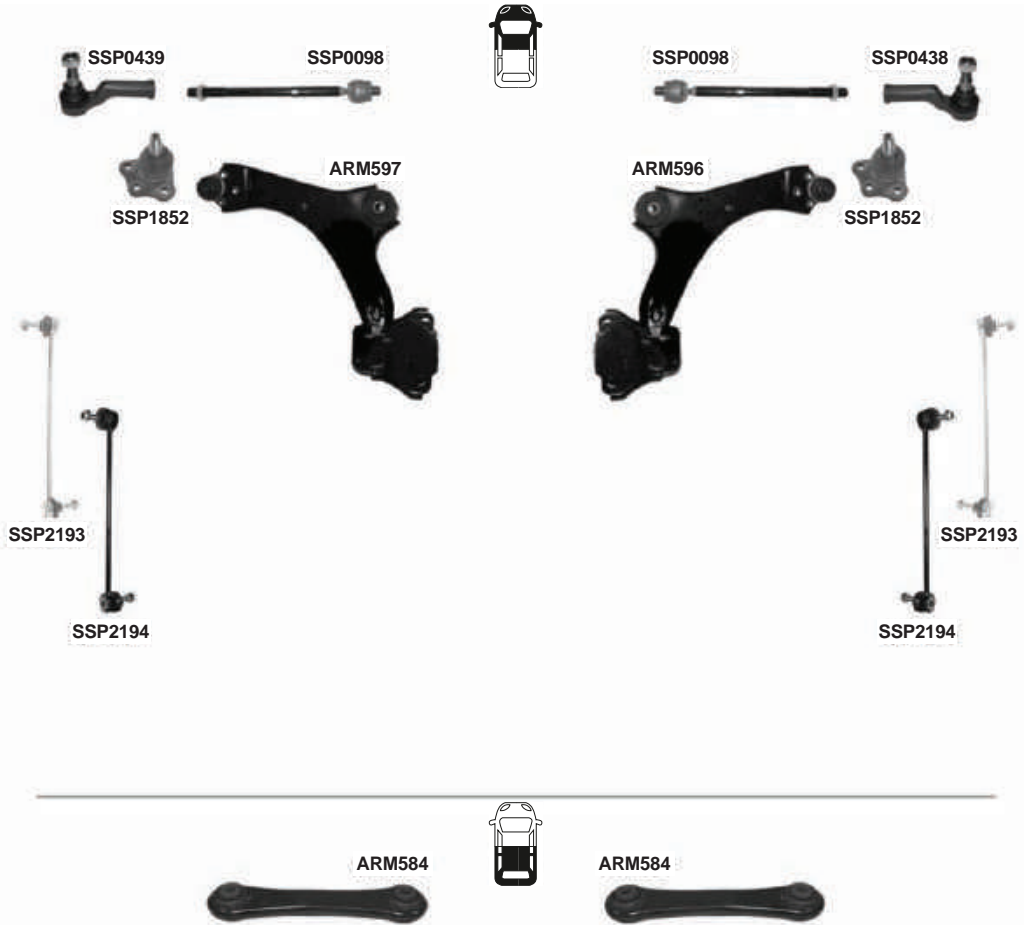

PART NO.	DESCRIPTION	NOTES	O.E.
ARM584	Lateral Arm - Rear	L=194,5	1377449; 1381843; 6G915K743XAD
ARM596	Suspension Control Arm and Ball Joint Assembly - Front Right Lower		1469024; 7G9N3A052BA; 1507181; 31317662; 31277344
ARM597	Suspension Control Arm and Ball Joint Assembly - Front Left Lower		1469026; 7G9N3A053BA; 31277343; 1507182; 31200448; 30760720
SSP0098	Steering Tie Rod - Front	M18x1,5 - L=315mm	1433271; 6G913280AB
SSP0438	Steering Tie Rod End - Front Right	M18x1,5	1433273; LR002609; 30776248; 6G913290AA; 31280001
SSP0439	Steering Tie Rod End - Front Left	M18x1,5	1433274; LR002610; 30776249; 6G913289AA; 31280001
SSP1852	Suspension Ball Joint - Front		1469026 Part of; 30671637 Part of; 6G9N3395AA Part of
SSP2193	Suspension Stabilizer Bar Link - Front	L=300mm	1377849; 6G9N3B438BA; 30648461
SSP2194	Suspension Stabilizer Bar Link - Front	(Clip-on patented design) L=300mm	6G9N3B438BA*



FORD TRANSIT V184



2000-06/2006

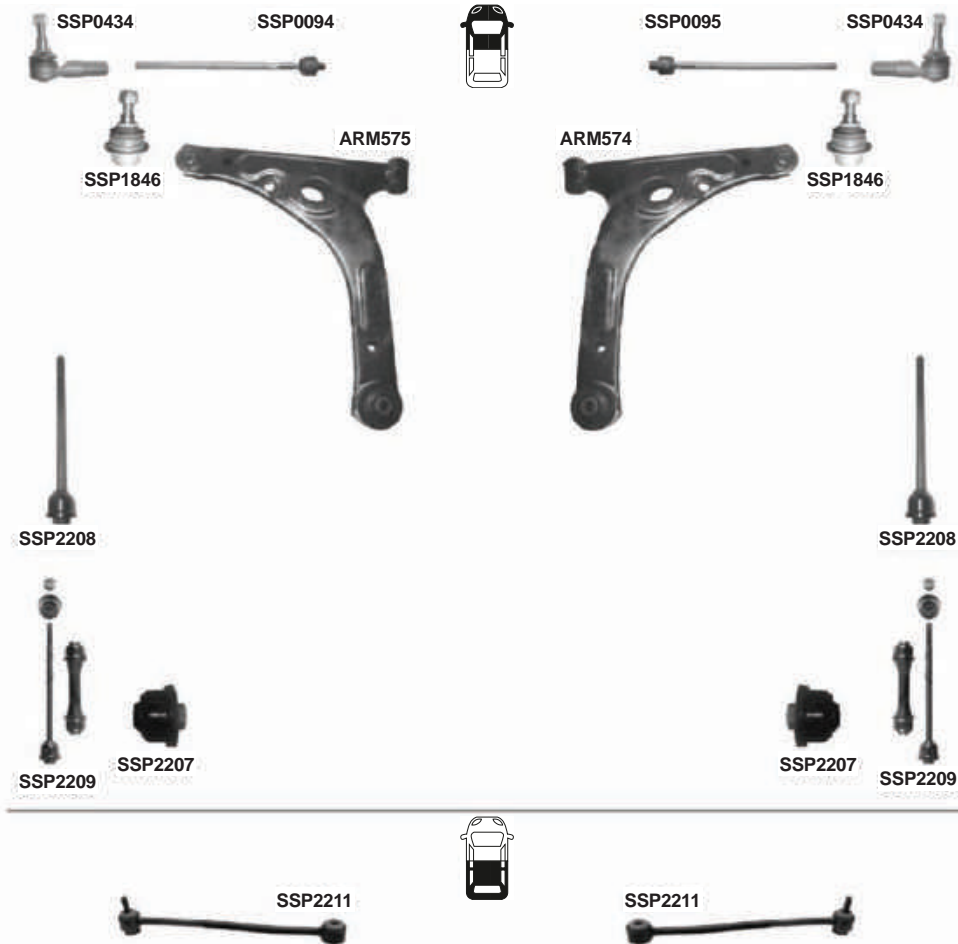

PART NO.	DESCRIPTION	NOTES	O.E.
ARM574 301181357400	Suspension Control Arm - Front Right Lower		01YC153A052; 4042022; 4540774
ARM575 301181357500	Suspension Control Arm - Front Left Lower		01YC153A053; 4042023; 4540775
SSP0094 301191600940	Steering Tie Rod - Left	M16x1,5 - L=380mm	1370709; YC153L519AB; YC153L519AA; 4059923; 6C113L519AA; 4602028
SSP0095 301191600950	Steering Tie Rod - Right	M20x1,5 - L=380mm	1370710; YC153L519BB; YC153L519BA; 4059924; 6C113L519BA; 4577976
SSP0434 301191604340	Steering Tie Rod End - Front	M16x1,5Rht	1370741; 4047091; YC153289AA; 6C113289AA
SSP1846 301191618460	Suspension Ball Joint - Front Lower		2T1Z3468A; YC1A3395BA; YC153395AB; 4120734; 4616978; 4173761
SSP2207 301191622070	Suspension Stabilizer Bar Link - Front	Small	3933468; F75A5C491BA
SSP2208 301191622080	Suspension Stabilizer Bar Link - Front	Inner	4041494; 4C155495AA; YL155495AA
SSP2209 301191622090	Suspension Stabilizer Bar Link - Front	Completo	3736028 S1
SSP2211 301191622110	Suspension Stabilizer Bar Link - Rear	L=347,5mm	4042068; YC155C486AE



FORD TRANSIT V347-348

07/2006-04/2014



**FORD TRANSIT V347-348**

07/2006-04/2014

PART NO.	DESCRIPTION	NOTES	O.E.
ARM574	301181357400 Suspension Control Arm - Front Right Lower		01YC153A052; 4042022; 4540774
ARM575	301181357500 Suspension Control Arm - Front Left Lower		01YC153A053; 4042023; 4540775
ARM576	301181357600 Suspension Control Arm - Front Right Lower	Only : Heavy duty	6C113A052BD
ARM577	301181357700 Suspension Control Arm - Front Left Lower	Only : Heavy duty	6C113A053BD
SSP0094	301191600940 Steering Tie Rod - Left	M16x1,5 - L=380mm	1370709; YC153L519AB; YC153L519AA; 4059923; 6C113L519AA; 4602028
SSP0095	301191600950 Steering Tie Rod - Right	M20x1,5 - L=380mm	1370710; YC153L519BB; YC153L519BA; 4059924; 6C113L519BA; 4577976
SSP0434	301191604340 Steering Tie Rod End - Front	M16x1,5Rht	1370741; 4047091; YC153289AA; 6C113289AA
SSP1846	301191618460 Suspension Ball Joint - Front Lower		2T1Z3468A; YC1A3395BA; YC153395AB; 4120734; 4616978; 4173761
SSP1847	301191618470 Suspension Ball Joint - Front Lower	(Heavy Duty)	1417351; KT6C113K209AA
SSP2211	301191622110 Suspension Stabilizer Bar Link - Rear	L=347,5mm	4042068; YC155C486AE
SSP2215	301191622150 Suspension Stabilizer Bar Link - Front	L=290mm	3C113B438AC; 4519467



FORD TRANSIT V363



04/2014-



PART NO.	DESCRIPTION	NOTES	O.E.
ARM578 301181357800	Suspension Control Arm - Front Right		1828699; BK313A052AD
ARM579 301181357900	Suspension Control Arm - Front Left		1828700; BK313A053AD
SSP0096 301191600960	Steering Tie Rod - Front	M16x1.5 - L=382mm	1763991; BK213L519AA
SSP0436 301191604360	Steering Tie Rod End - Front	M16x1.5	1763989; BK213289AA
SSP1848 301191618480	Suspension Ball Joint - Front Lower	Only: ->410/460 lik Type Front	1817754; KTBK313K209AA
SSP1849 301191618490	Suspension Ball Joint - Front Lower	Only: ->350 lik Type Front	1817752; KTBK213K209AB
SSP2216 301191622160	Suspension Stabilizer Bar Link - Front	L=290mm	1763714; BK213B438AA



FORD TRANSIT CONNECT



04/2002-09/2013

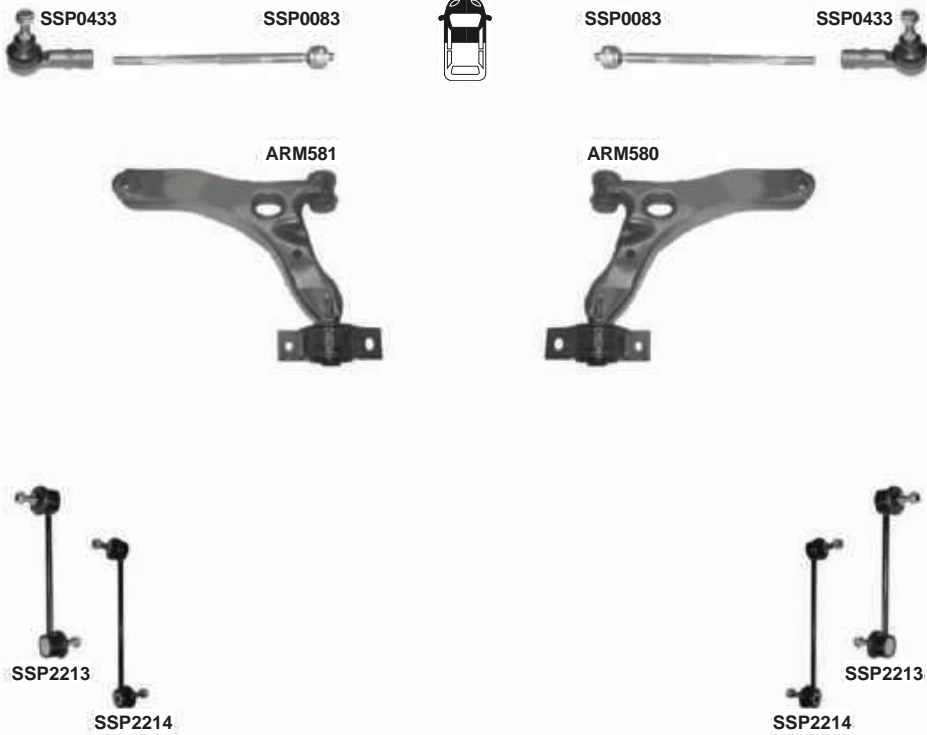

	PART NO.	DESCRIPTION	NOTES	O. E.
ARM580	301181358000	Suspension Control Arm - Front Right Lower		1332454; 4366973; W12T1043042BG; 4371925
ARM581	301181358100	Suspension Control Arm - Front Left Lower		1332455; 2T143051BG; 4371926; 4366974
SSP0083	301191600830	Steering Tie Rod - Front	M14x2 - L=343mm	1085520; YS4Z3280AA; 98AG3L519AA; 3707333
SSP0433	301191604330	Steering Tie Rod End - Front	Usa Market	2T1Z3A130A
SSP0435	301191604350	Steering Tie Rod End - Front	M14X2	2T1Z3A130A; 4381840; W12T143289AA
SSP1846	301191618460	Suspension Ball Joint - Front Lower		2T1Z3468A; YC1A3395BA; YC153395AB; 4120734; 4616978; 4173761
SSP2212	301191622120	Suspension Stabilizer Bar Link - Rear	L=133mm	1332463; 4436609; W12T145C486AD
SSP2213	301191622130	Suspension Stabilizer Bar Link - Front	L=238mm	1332453; 2T143B438BA; 4367012; 2T143B438BB
SSP2214	301191622140	Suspension Stabilizer Bar Link - Front	(Clip-on patented design) L=238mm	1332453; 2T143B438BA; W12T143B438BA; 4367012



FORD TRANSIT CONNECT USA made  **2010-2013**



PART NO.	DESCRIPTION	NOTES	O.E.
SSP0083 301191600830	Steering Tie Rod - Front		1085520; YS4Z3280AA; 98AG3L519AA; 3707333
SSP2217 301191622170	Suspension Stabilizer Bar Link - Front	Steel type	1S713B438AC; 2T1Z5K484AA; 6960036; 93BB3B438CA; 7T1Z5K484A

**FORD TRANSIT CONNECT II**

2013-



	PART NO.	DESCRIPTION	NOTES	O.E.
ARM572	301181357200	Suspension Control Arm and Ball Joint Assembly - Front Right		DV613A423AF
ARM573	301181357300	Suspension Control Arm and Ball Joint Assembly - Front Left		DV613A424AF; 1933100
SSP0092	301191600920	Steering Tie Rod - Front	M16X1,5 - L=293mm	1714484; AV6C3L519BA; AV6C3L519BAN; AV6C3L519AA; 1715414; 31317779; 1780104
SSP1844	301191618440	Suspension Ball Joint - Front Right Lower		Part of DV613A424AF
SSP1845	301191618450	Suspension Ball Joint - Front Right Lower		Part of DV613A423AF



FORD TRANSIT CUSTOM



12/2012-



PART NO.	DESCRIPTION	NOTES	O.E.
ARM582 301181358200	Suspension Control Arm - Front Right Lower		1831354; BK213A052AE
ARM583 301181358300	Suspension Control Arm - Front Left Lower		1831355; BK213A053AE
SSP0096 301191600960	Steering Tie Rod - Front	M16x1.5 - L=382mm	1763991; BK213L519AA
SSP0436 301191604360	Steering Tie Rod End - Front	M16x1.5	1763989; BK213289AA
SSP1849 301191618490	Suspension Ball Joint - Front Lower		1817752; KTBK213K209AB
SSP2216 301191622160	Suspension Stabilizer Bar Link - Front	L=290mm	1763714; BK213B438AA



	PART NO.	DESCRIPTION	NOTES	O.E.
ARM404	301181340400	Suspension Control Arm and Ball Joint Assembly - Front Right Lower		20774419
ARM405	301181340500	Suspension Control Arm and Ball Joint Assembly - Front Left Lower		25995438

GMC ACADIA



2007-2017

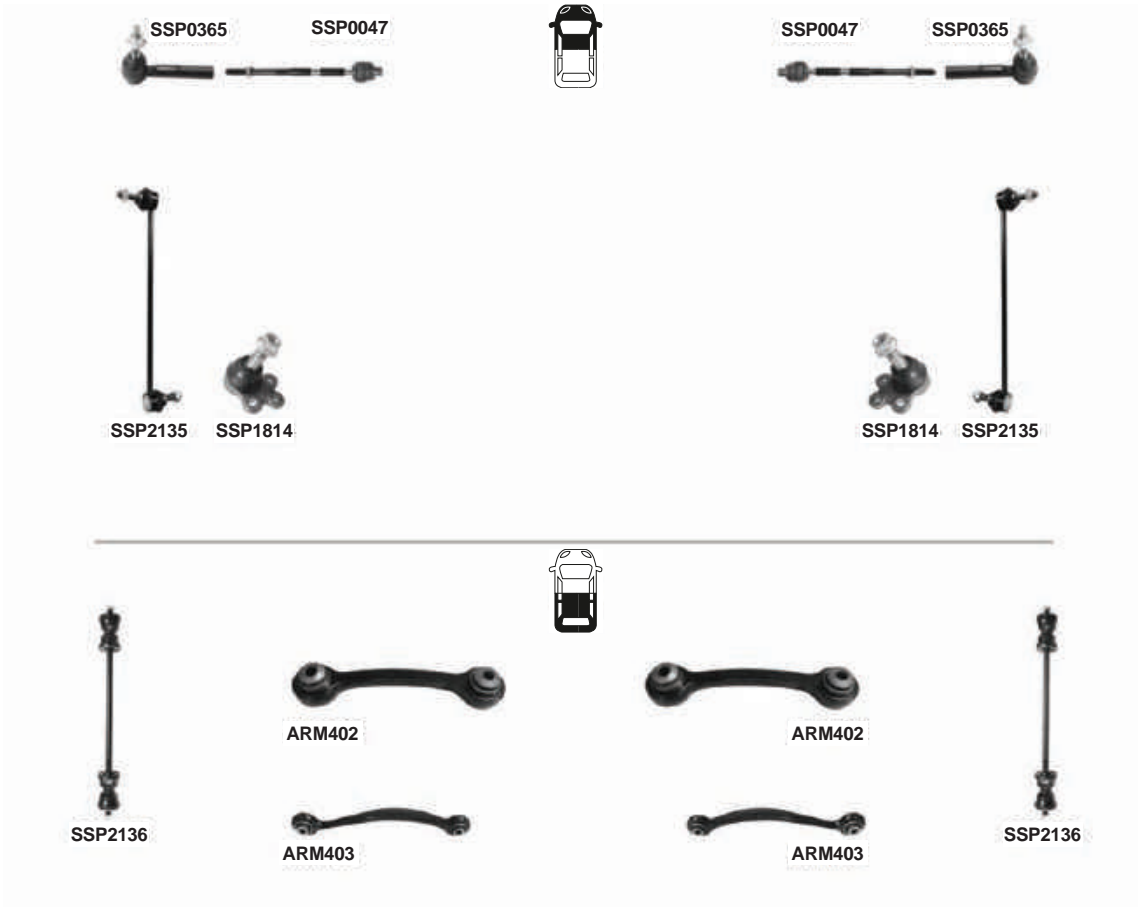

PART NO.	DESCRIPTION	NOTES	O.E.
ARM402	301181340200 Lateral Arm - Rear Upper		15148024
ARM403	301181340300 Lateral Arm - Rear Lower		23461856
SSP0047	301191600470 Steering Tie Rod - Front		20817752
SSP0365	301191603650 Steering Tie Rod End - Front		15869897
SSP1814	301191618140 Suspension Ball Joint - Front		19207521
SSP2135	301191621350 Suspension Stabilizer Bar Link - Front		20905104
SSP2136	301191621360 Suspension Stabilizer Bar Link - Rear		15129234



GMC CANYON 1st Gen



(2004-2007) 2004-2012



SSP0362



SSP0362

PART NO.	DESCRIPTION	NOTES	O.E.
SSP0362 301191603620	Steering Tie Rod End - Front Outer		26095458



ARM401



ARM400



	PART NO.	DESCRIPTION	NOTES	O.E.
ARM400	301181340000	Suspension Control Arm - Front Right		25786775
ARM401	301181340100	Suspension Control Arm - Front Left		25786774



GMC JIMMY 2nd Gen



1995-2001



PART NO.	DESCRIPTION	NOTES	O.E.
SSP2121 301191621210	Suspension Stabilizer Bar Link - Rear		15697702
SSP2131 301191621310	Suspension Stabilizer Bar Link - Front		22710259



PART NO.	DESCRIPTION	NOTES	O.E.
SSP0350 301191603500	Steering Tie Rod End - Front		26095475; ES80311



MAGNETI
MARELLI

GMC SAVANA 2500



2003-



PART NO.	DESCRIPTION	NOTES	O.E.
SSP0350 301191603500	Steering Tie Rod End - Front		26095475; ES80311



PART NO.	DESCRIPTION	NOTES	O.E.
ARM398 301181339800	Suspension Control Arm and Ball Joint Assembly - Front Right Lower	w/Police Package	25997510
ARM399 301181339900	Suspension Control Arm and Ball Joint Assembly - Front Left Lower	w/Police Package	25997509
SSP1810 301191618100	Suspension Ball Joint - Front Lower	with Police Package	Part of 25997509; Part of 25997510



PART NO.	DESCRIPTION	NOTES	O.E.
SSP2119 301191621190	Suspension Stabilizer Bar Link - Rear		15089907



GMC TERRAIN



2010-

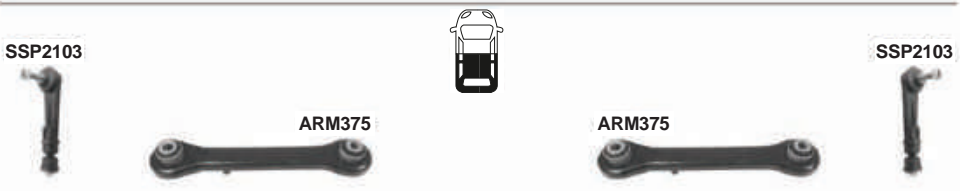
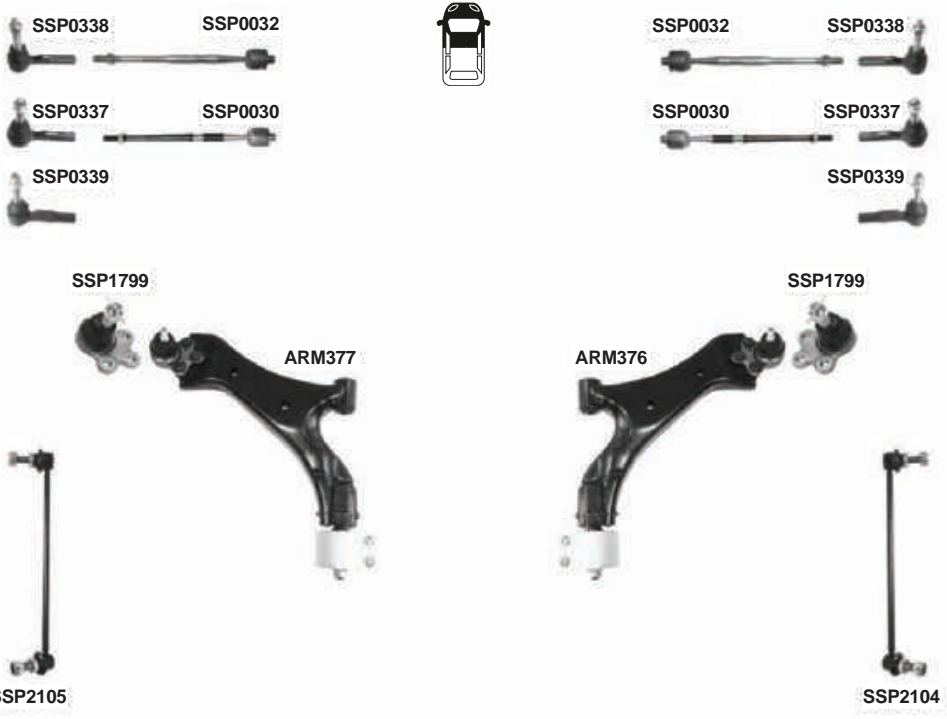

PART NO.	DESCRIPTION	NOTES	O.E.
ARM375 301181337500	Lateral Arm - Rear		22678193
ARM376 301181337600	Suspension Control Arm and Ball Joint Assembly - Front Right Lower		20945780
ARM377 301181337700	Suspension Control Arm and Ball Joint Assembly - Front Left Lower		20945779
SSP0030 301191600300	Steering Tie Rod - Front	POWER/ELECTRIC	19149839
SSP0032 301191600320	Steering Tie Rod - Front	POWER/HYDRAULIC	19210063
SSP00337 301191603370	Steering Tie Rod End - Front		19149840
SSP00338 301191603380	Steering Tie Rod End - Front	Power/Hydraulic Steering	19210064
SSP00339 301191603390	Steering Tie Rod End - Front	Power Electric	19207057
SSP1799 301191617990	Suspension Ball Joint - Front Lower		19258791; 20945779/20945780**
SSP2103 301191621030	Suspension Stabilizer Bar Link - Rear		15146379
SSP2104 301191621040	Suspension Stabilizer Bar Link - Front Right		15218267
SSP2105 301191621050	Suspension Stabilizer Bar Link - Front Left		15218268



GMC YUKON 1st Gen



1992-2000



PART NO.	DESCRIPTION	NOTES	O.E.
SSP1811 301191618110	Suspension Ball Joint - Front Lower	AWD	12383410; 12380415
SSP2132 301191621320	Suspension Stabilizer Bar Link - Rear		15961007



GMC YUKON 2nd Gen GMT800



2000-2006

SSP1793



SSP1793

PART NO.	DESCRIPTION	NOTES	O.E.
SSP1793 301191617930	Suspension Ball Joint - Front Upper		12475485; 12475486; K6540



MAGNETI
MARELLI

GMC YUKON



2004-2012



PART NO.	DESCRIPTION	NOTES	O.E.
SSP1803 301191618030	Suspension Ball Joint - Front Upper		89040241



GMC YUKON GMT900



2007-2014

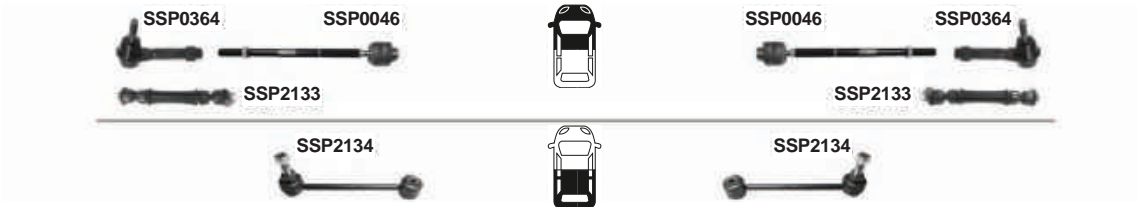

	PART NO.	DESCRIPTION	NOTES	O.E.
ARM398	301181339800	Suspension Control Arm and Ball Joint Assembly - Front Right Lower	w/Police Package	25997510
ARM399	301181339900	Suspension Control Arm and Ball Joint Assembly - Front Left Lower	w/Police Package	25997509
SSP0046	301191600460	Steering Tie Rod - Front		19178561
SSP0364	301191603640	Steering Tie Rod End - Front Outer		15254061
SSP1810	301191618100	Suspension Ball Joint - Front Lower	with Police Package	Part of 25997509; Part of 25997510
SSP2133	301191621330	Suspension Stabilizer Bar Link - Front		25918049
SSP2134	301191621340	Suspension Stabilizer Bar Link - Rear		15257472



MAGNETI
MARELLI

HYUNDAI ACCENT I



01/1994-01/2000



SSP1854



SSP1854

PART NO.	DESCRIPTION	NOTES	O.E.
SSP1854 301191618540	Suspension Ball Joint - Front		5450322000; 5453025000; 5450322A00; 5450331600



HYUNDAI ACCENT II



02/2000-11/2005

SSP0443



SSP0443



SSP1854



SSP1854



SSP2229



SSP2228

PART NO.	DESCRIPTION	NOTES	O.E.
SSP0443 301191604430	Steering Tie Rod End - Front	M14x1,5Rht	5682025000
SSP1854 301191618540	Suspension Ball Joint - Front		5450322000; 5453025000; 5450322A00; 5450331600
SSP2228 301191622280	Suspension Stabilizer Bar Link - Front Right	L=60mm	5483017020; 5483025020
SSP2229 301191622290	Suspension Stabilizer Bar Link - Front Left	L=60mm	5483017010; 5483025010



HYUNDAI ACCENT III, MC



11/2005-11/2010



ARM604



ARM603



SSP1857



SSP1857



SSP2239



SSP2238

	PART NO.	DESCRIPTION	NOTES	O.E.
ARM603	301181360300	Suspension Control Arm - Front Right Lower	Power Steering	54501-1E100
ARM604	301181360400	Suspension Control Arm - Front Left Lower	Power Steering	5,45E+105
SSP1857	301191618570	Suspension Ball Joint - Front		517601G000
SSP2238	301191622380	Suspension Stabilizer Bar Link - Front Right	L=285mm	548401; 548401G500; 548402C000
SSP2239	301191622390	Suspension Stabilizer Bar Link - Front Left	L=285mm	548301G000; 548301G500; 548302C000

HYUNDAI ACCENT IV, RB



2011-



PART NO.	DESCRIPTION	NOTES	O.E.
SSP0101 301191601010	Steering Tie Rod - Front	M16X1,5 - L=218mm	565400U500; 545400U500
SSP0446 301191604460	Steering Tie Rod End - Front Right	M16X1,5	568200U590; 568201W090
SSP0447 301191604470	Steering Tie Rod End - Front Left	M16X1,5	568200U500; 568201W000
SSP1856 301191618560	Suspension Ball Joint - Front Lower		545300U000; 545303X000
SSP2235 301191622350	Suspension Stabilizer Bar Link - Front	L=282mm	548300U000; 548304L000



MAGNETI
MARELLI

HYUNDAI ATOS PRIMA/AMICA



02/1998-11/2008

SSP0442



SSP0442



PART NO.	DESCRIPTION	NOTES	O.E.
SSP0442 301191604420	Steering Tie Rod End - Front	M12x1,25Rht	5682028000; MB912076



HYUNDAI AVANTE TOURING



1995-2000

SSP1854



SSP1854



PART NO.	DESCRIPTION	NOTES	O.E.
SSP1854 301191618540	Suspension Ball Joint - Front		5450322000; 5453025000; 5450322A00; 5450331600



HYUNDAI COUPE



05/2002-08/2009

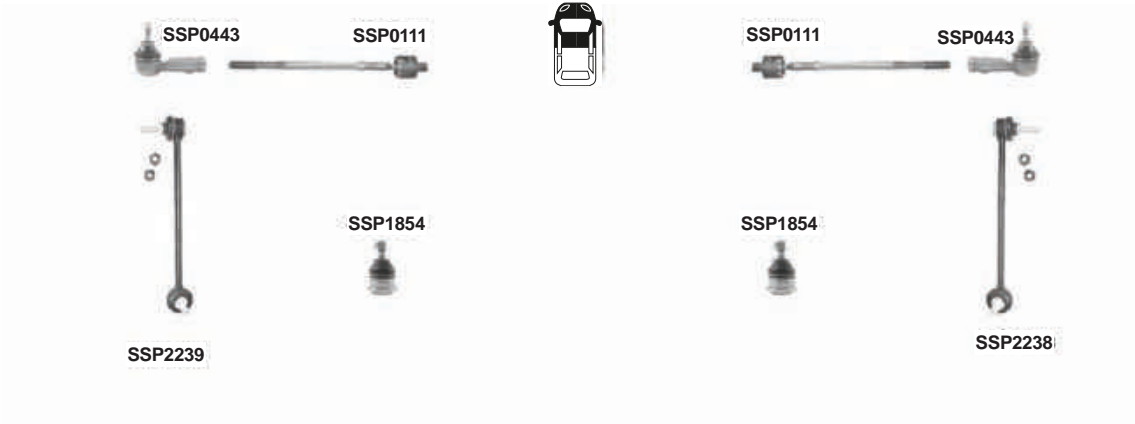

PART NO.	DESCRIPTION	NOTES	O.E.
SSP0111 301191601110	Steering Tie Rod - Front	M14x1,5 - L=322mm	5771634000; 5775517000; 5778526200
SSP0443 301191604430	Steering Tie Rod End - Front	M14x1,5Rht	5682025000
SSP1854 301191618540	Suspension Ball Joint - Front		5450322000; 5453025000; 5450322A00; 5450331600
SSP2238 301191622380	Suspension Stabilizer Bar Link - Front Right	L=285mm	548401; 548401G500; 548402C000
SSP2239 301191622390	Suspension Stabilizer Bar Link - Front Left	L=285mm	548301G000; 548301G500; 548302C000



HYUNDAI ELANTRA 1st Gen, J1  10/1990-11/1995



PART NO.	DESCRIPTION	NOTES	O.E.
SSP0442 301191604420	Steering Tie Rod End - Front	M12x1,25Rht	5682028000; MB912076



HYUNDAI ELANTRA J2/RD



11/1995-09/2000

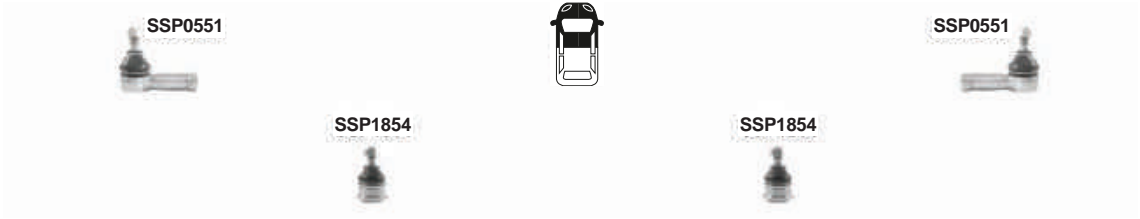

	PART NO.	DESCRIPTION	NOTES	O.E.
SSP0551	301191605510	Steering Tie Rod End - Front	M14x1,5Rht	5682036000; MB912519; MB192430; MB616286
SSP1854	301191618540	Suspension Ball Joint - Front		5450322000; 5453025000; 5450322A00; 5450331600



HYUNDAI ELANTRA 3th Gen, XD 06/2000-07/2006



PART NO.	DESCRIPTION	NOTES	O.E.
SSP0111 301191601110	Steering Tie Rod - Front	M14x1,5 - L=322mm	5771634000; 5775517000; 5778526200
SSP0443 301191604430	Steering Tie Rod End - Front	M14x1,5Rht	5682025000
SSP1854 301191618540	Suspension Ball Joint - Front		5450322000; 5453025000; 5450322A00; 5450331600



HYUNDAI ELANTRA Touring, Wagon 10/2007-11/2011

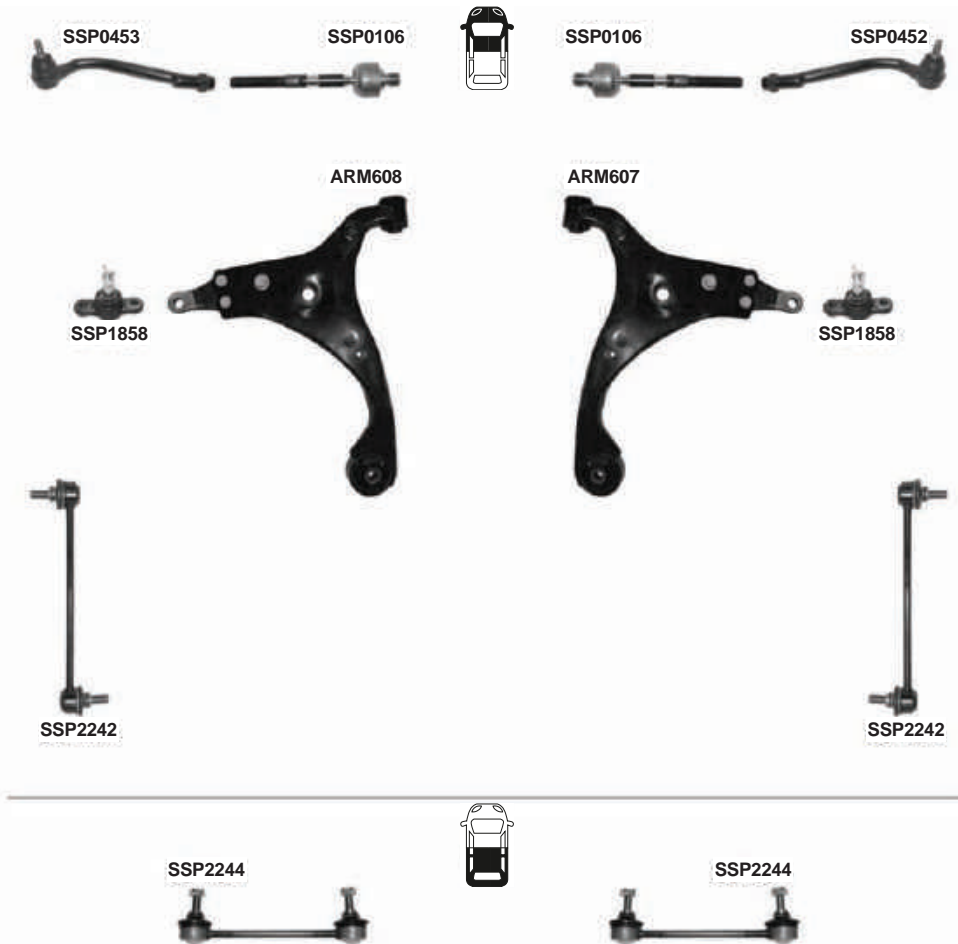

PART NO.	DESCRIPTION	NOTES	O.E.
ARM607	Suspension Control Arm - Front Right Lower		545012H000
ARM608	Suspension Control Arm - Front Left Lower		545002H000
SSP0106	Steering Tie Rod - Front	M14x1,5 - L=156.5mm	565402H000
SSP0452	Steering Tie Rod End - Front Right	M14x1,5	568202H090
SSP0453	Steering Tie Rod End - Front Left	M14x1,5	568202H000
SSP1858	Suspension Ball Joint - Front		517602G000
SSP2242	Suspension Stabilizer Bar Link - Front	L=243.5mm	548302H000; 548302H100
SSP2244	Suspension Stabilizer Bar Link - Rear		555301H000; 555302H000



HYUNDAI ELANTRA 5th Gen, MD/UD



2012-2015



PART NO.	DESCRIPTION	NOTES	O.E.
SSP0454 301191604540	Steering Tie Rod End - Front Right	M16X1,5	568203X090; 56820A6090
SSP0455 301191604550	Steering Tie Rod End - Front Left	M16X1,5	568203X000; 56820A6000
SSP1856 301191618560	Suspension Ball Joint - Front Lower		545300U000; 545303X000
SSP2235 301191622350	Suspension Stabilizer Bar Link - Front	L=282mm	548300U000; 548304L000



HYUNDAI Elantra GT



12/2011-

SSP0455



SSP0107



SSP0107



SSP0454



SSP1859

ARM610



ARM609



SSP1859



SSP2235



SSP2235



SSP2245



SSP2245

	PART NO.	DESCRIPTION	NOTES	O.E.
ARM609	301181360900	Suspension Control Arm and Ball Joint Assembly - Front Right Lower		54501A6200
ARM610	301181361000	Suspension Control Arm and Ball Joint Assembly - Front Left Lower		54500A6200
SSP0107	301191601070	Steering Tie Rod - Front	M16X1,5 - L=218mm	56540A6000
SSP0454	301191604540	Steering Tie Rod End - Front Right	M16X1,5	568203X090; 56820A6090
SSP0455	301191604550	Steering Tie Rod End - Front Left	M16X1,5	568203X000; 56820A6000
SSP1859	301191618590	Suspension Ball Joint - Front		545303S100
SSP2235	301191622350	Suspension Stabilizer Bar Link - Front	L=282mm	548300U000; 548304L000
SSP2245	301191622450	Suspension Stabilizer Bar Link - Rear	L=88mm	555303R000; 555403R000



HYUNDAI EXCEL



1994-1998



SSP1854



SSP1854

PART NO.	DESCRIPTION	NOTES	O.E.
SSP1854 301191618540	Suspension Ball Joint - Front		5450322000; 5453025000; 5450322A00; 5450331600



HYUNDAI GALOPPER II



08/1998-12/2003



SSP1899



SSP1899

PART NO.	DESCRIPTION	NOTES	O.E.
SSP1899 301191618990	Suspension Ball Joint - Front Upper		5441744000; MB109585



HYUNDAI GETZ (TB)



08/2002-06/2011

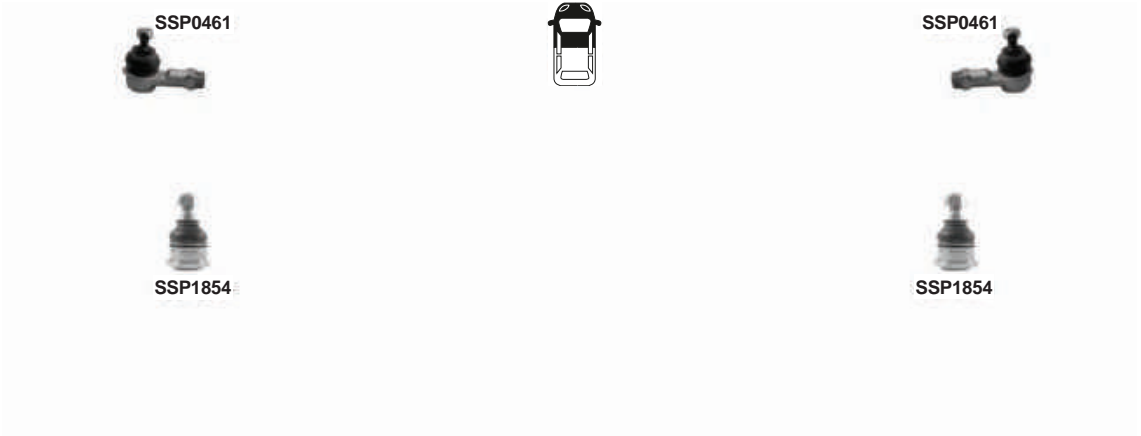

PART NO.	DESCRIPTION	NOTES	O.E.
SSP0461 301191604610	Steering Tie Rod End - Front	M14x1,5Rht	568203B000
SSP1854 301191618540	Suspension Ball Joint - Front		5450322000; 5453025000; 5450322A00; 5450331600

**HYUNDAI Grand i10 IA/BA**

12/2013-

**SSP1873****SSP1873****SSP2247****SSP2246**

PART NO.	DESCRIPTION	NOTES	O.E.
SSP1873 301191618730	Suspension Ball Joint - Front Lower		545302K000
SSP2246 301191622460	Suspension Stabilizer Bar Link - Front Right	L=229,5mm	548400X000; 54840B4000
SSP2247 301191622470	Suspension Stabilizer Bar Link - Front Left	L=229,5mm	548300X000; 54830B4000



HYUNDAI H 1 I



02/2008-



SSP0445



SSP0102

SSP0444



SSP1855



SSP1855



SSP2232



SSP2231



SSP2234



SSP2233

PART NO.	DESCRIPTION	NOTES	O.E.
SSP0102 301191601020	Steering Tie Rod - Front Right	M14x1,5 - L=231mm	577244H100
SSP0444 301191604440	Steering Tie Rod End - Front Right	M14x1,5	568204H100
SSP0445 301191604450	Steering Tie Rod End - Front Left	M14x1,5	568204H000
SSP1855 301191618550	Suspension Ball Joint - Front Lower	D=Ø20mm	545303J000
SSP2231 301191622310	Suspension Stabilizer Bar Link - Front Right	L=275mm	548404H000
SSP2232 301191622320	Suspension Stabilizer Bar Link - Front Left	L=275mm	548304H000
SSP2233 301191622330	Suspension Stabilizer Bar Link - Rear Right	L=85mm	555404H000
SSP2234 301191622340	Suspension Stabilizer Bar Link - Rear Left	L=85mm	555304H000



HYUNDAI H100 PICK-UP



1992-1997



SSP1901



SSP1901

	PART NO.	DESCRIPTION	NOTES	O.E.
SSP1900	301191619000	Suspension Ball Joint - Front Lower		5452443301; MB349475; MB527383; 545244330A; MB176309
SSP1901	301191619010	Suspension Ball Joint - Front Upper		544174AA00; MB527350; MR241623; MB241623; MB527349



HYUNDAI H100 PICK-UP



10/1997-04/2004



PART NO.	DESCRIPTION	NOTES	O.E.
SSP0550 301191605500	Steering Tie Rod End - Front Outer	M14x1,5Rht	5687243010; MB166426; MB527650



HYUNDAI H100 VAN



05/1993-10/2004

**SSP0550****SSP0550****SSP1901****SSP1901****SSP1900****SSP1900**

PART NO.	DESCRIPTION	NOTES	O.E.
SSP0550 301191605500	Steering Tie Rod End - Front Outer	M14x1,5Rht	5687243010; MB166426; MB527650
SSP1900 301191619000	Suspension Ball Joint - Front Lower		5452443301; MB349475; MB527383; 545244330A; MB176309
SSP1901 301191619010	Suspension Ball Joint - Front Upper		544174AA00; MB527350; MR241623; MB241623; MB527349



HYUNDAI I10 (PA)



02/2008-11/2013

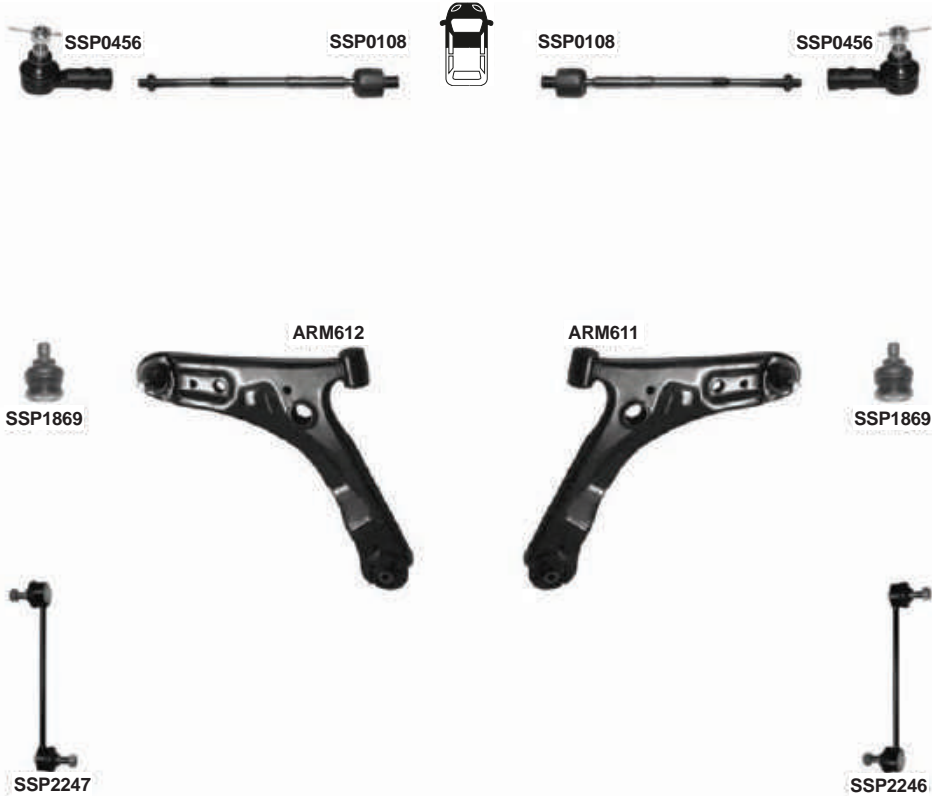

PART NO.	DESCRIPTION	NOTES	O.E.
ARM611	Suspension Control Arm and Ball Joint Assembly - Front Right Lower		545010X000
ARM612	Suspension Control Arm and Ball Joint Assembly - Front Left Lower		545000X000
SSP0108	Steering Tie Rod - Front	M12x1,25 - L=296mm	577240X000
SSP0456	Steering Tie Rod End - Front	M12x1,25	568200X000; 568200X900
SSP1869	Suspension Ball Joint - Front Lower		5435007000; 5453007000
SSP2246	Suspension Stabilizer Bar Link - Front Right	L=229,5mm	548400X000; 54840B4000
SSP2247	Suspension Stabilizer Bar Link - Front Left	L=229,5mm	548300X000; 54830B4000



HYUNDAI I20 (PB,PBT)



09/2008-08/2014

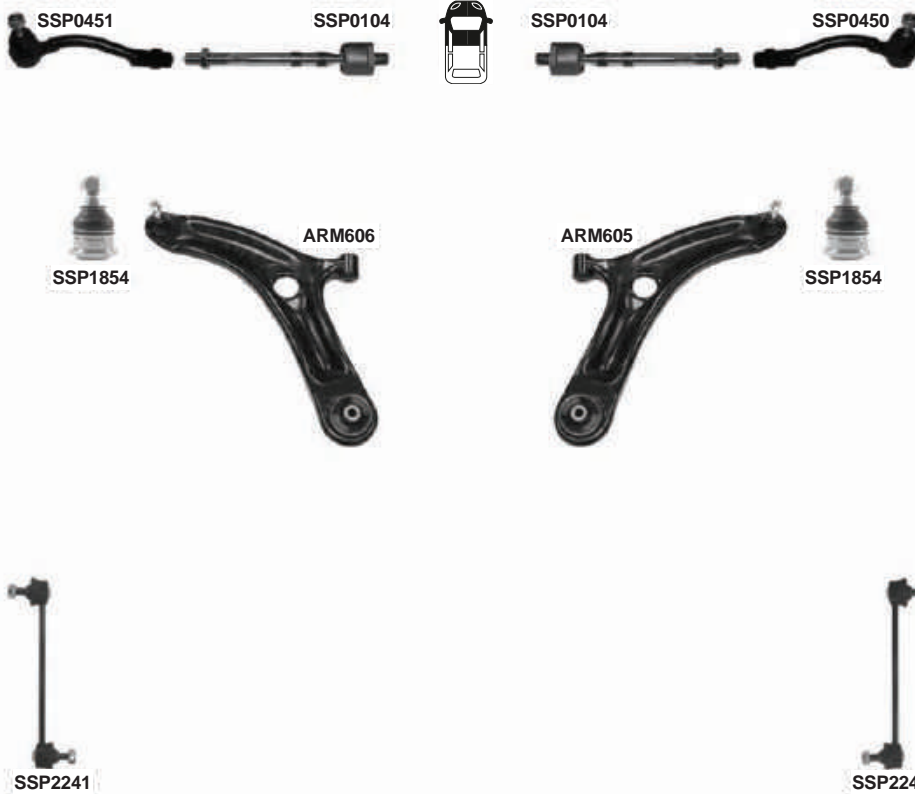

PART NO.	DESCRIPTION	NOTES	O.E.
ARM605	301181360500 Suspension Control Arm and Ball Joint Assembly - Front Right Lower		545011J500
ARM606	301181360600 Suspension Control Arm and Ball Joint Assembly - Front Left Lower		545001J500
SSP0104	301191601040 Steering Tie Rod - Front	M16x1,5 - L=222mm	577241J000
SSP0450	301191604500 Steering Tie Rod End - Front Right	M16x1,5	568202K050
SSP0451	301191604510 Steering Tie Rod End - Front Left	M16x1,5	568202K000
SSP1854	301191618540 Suspension Ball Joint - Front		5450322000; 5453025000; 5450322A00; 5450331600
SSP2240	301191622400 Suspension Stabilizer Bar Link - Front Right	L=216mm	548401J000
SSP2241	301191622410 Suspension Stabilizer Bar Link - Front Left	L=216mm	548301J000



HYUNDAI I20 II



11/2014-

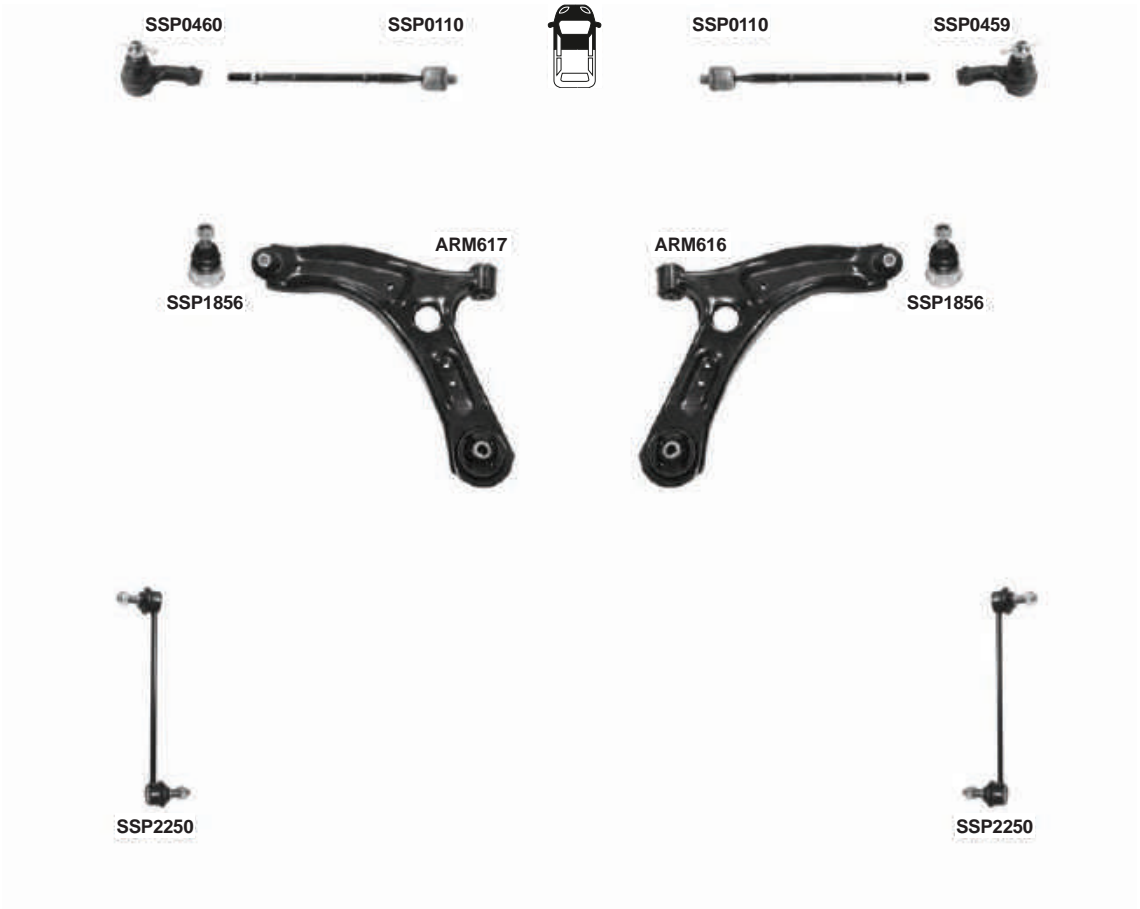

PART NO.	DESCRIPTION	NOTES	O.E.
ARM616	301181361600 Suspension Control Arm and Ball Joint Assembly - Front Right Lower		54501C8000
ARM617	301181361700 Suspension Control Arm and Ball Joint Assembly - Front Left Lower		54500C8000
SSP0110	301191601100 Steering Tie Rod - Front		56540C8000
SSP0459	301191604590 Steering Tie Rod End - Front Right	A = L-78MM / C = M14X1.5	56820C8900; 56820C9000
SSP0460	301191604600 Steering Tie Rod End - Front Left	A = L-78MM / C = M14X1.5	56820C8000
SSP1856	301191618560 Suspension Ball Joint - Front Lower		545300U000; 545303X000
SSP2250	301191622500 Suspension Stabilizer Bar Link - Front	L=282mm	54830C8000



HYUNDAI I30 FD



10/2007-11/2011

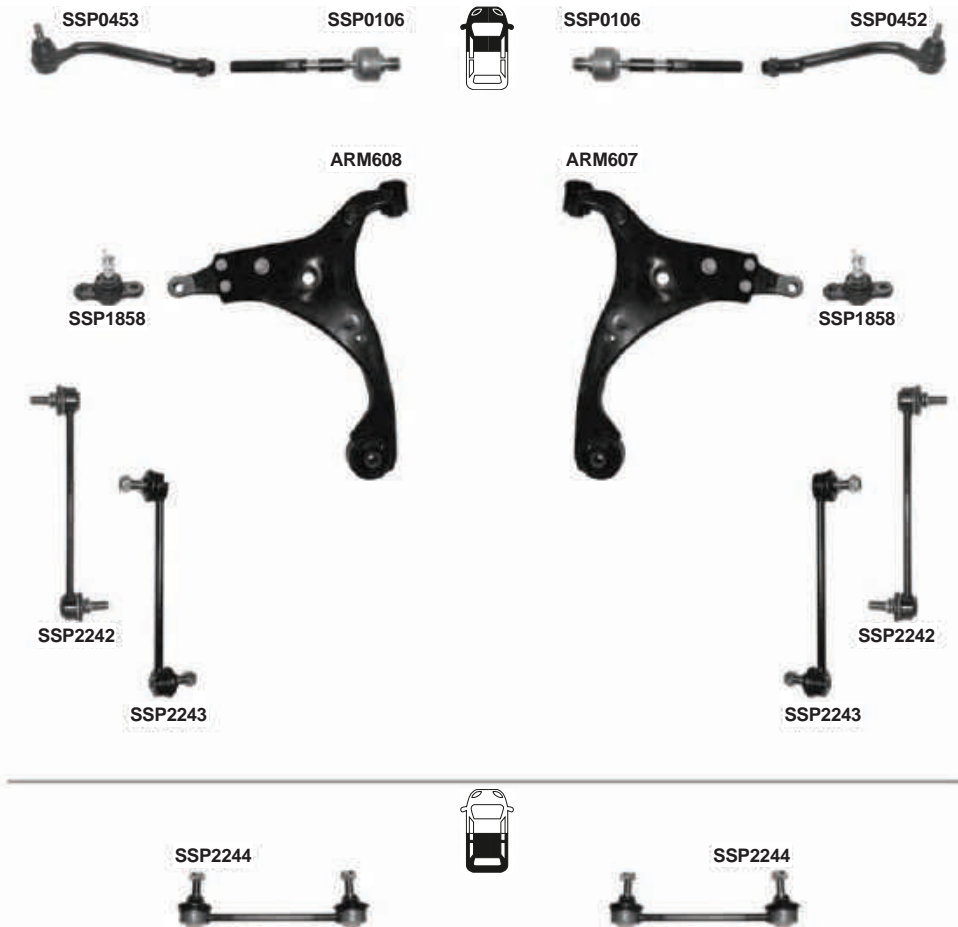

	PART NO.	DESCRIPTION	NOTES	O.E.
ARM607	301181360700	Suspension Control Arm - Front Right Lower		545012H000
ARM608	301181360800	Suspension Control Arm - Front Left Lower		545002H000
SSP0106	301191601060	Steering Tie Rod - Front	M14x1,5 - L=156.5mm	565402H000
SSP0452	301191604520	Steering Tie Rod End - Front Right	M14x1,5	568202H090
SSP0453	301191604530	Steering Tie Rod End - Front Left	M14x1,5	568202H000
SSP1858	301191618580	Suspension Ball Joint - Front		517602G000
SSP2242	301191622420	Suspension Stabilizer Bar Link - Front	L=243.5mm	548302H000; 548302H100
SSP2243	301191622430	Suspension Stabilizer Bar Link - Front	(Clip-on patented design) L=243.5mm	548302H000*
SSP2244	301191622440	Suspension Stabilizer Bar Link - Rear		555301H000; 555302H000



HYUNDAI I30 GD



12/2011-

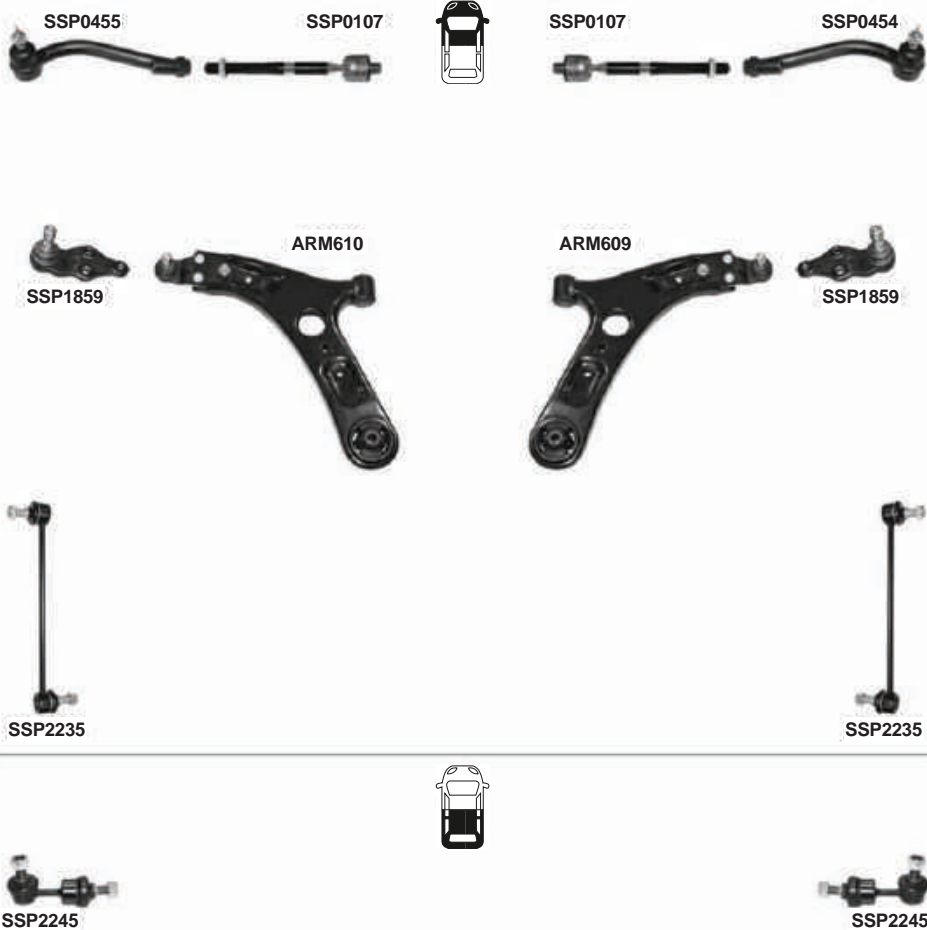

PART NO.	DESCRIPTION	NOTES	O.E.
ARM609	301181360900 Suspension Control Arm and Ball Joint Assembly - Front Right Lower		54501A6200
ARM610	301181361000 Suspension Control Arm and Ball Joint Assembly - Front Left Lower		54500A6200
ARM618	301181361800 Lateral Arm - Rear		55100A6005
ARM642	301181364200 Suspension Control Arm and Ball Joint Assembly - Front Right Lower		54501A2600
ARM643	301181364300 Suspension Control Arm and Ball Joint Assembly - Front Left Lower		54500A2600
SSP0107	301191601070 Steering Tie Rod - Front	M16X1,5 - L=218mm	56540A6000
SSP0454	301191604540 Steering Tie Rod End - Front Right	M16X1,5	568203X090; 56820A6090
SSP0455	301191604550 Steering Tie Rod End - Front Left	M16X1,5	568203X000; 56820A6000
SSP1859	301191618590 Suspension Ball Joint - Front		545303S100
SSP2235	301191622350 Suspension Stabilizer Bar Link - Front	L=282mm	548300U000; 548304L000
SSP2245	301191622450 Suspension Stabilizer Bar Link - Rear	L=88mm	555303R000; 555403R000
SSP2285	301191622850 Suspension Stabilizer Bar Link - Front		548304L000

**HYUNDAI I30 PD**

2017-



	PART NO.	DESCRIPTION	NOTES	O.E.
ARM609	301181360900	Suspension Control Arm and Ball Joint Assembly - Front Right Lower		54501A6200
ARM610	301181361000	Suspension Control Arm and Ball Joint Assembly - Front Left Lower		54500A6200
ARM618	301181361800	Lateral Arm - Rear		55100A6005
ARM642	301181364200	Suspension Control Arm and Ball Joint Assembly - Front Right Lower		54501A2600
ARM643	301181364300	Suspension Control Arm and Ball Joint Assembly - Front Left Lower		54500A2600
SSP0107	301191601070	Steering Tie Rod - Front		56540A6000
SSP0454	301191604540	Steering Tie Rod End - Front Right		568203X090; 56820A6090
SSP0455	301191604550	Steering Tie Rod End - Front Left		568203X000; 56820A6000
SSP1859	301191618590	Suspension Ball Joint - Front		545303S100
SSP2245	301191622450	Suspension Stabilizer Bar Link - Rear		555303R000; 555403R000
SSP2285	301191622850	Suspension Stabilizer Bar Link - Front		548304L000



HYUNDAI I800 800



10/2007-

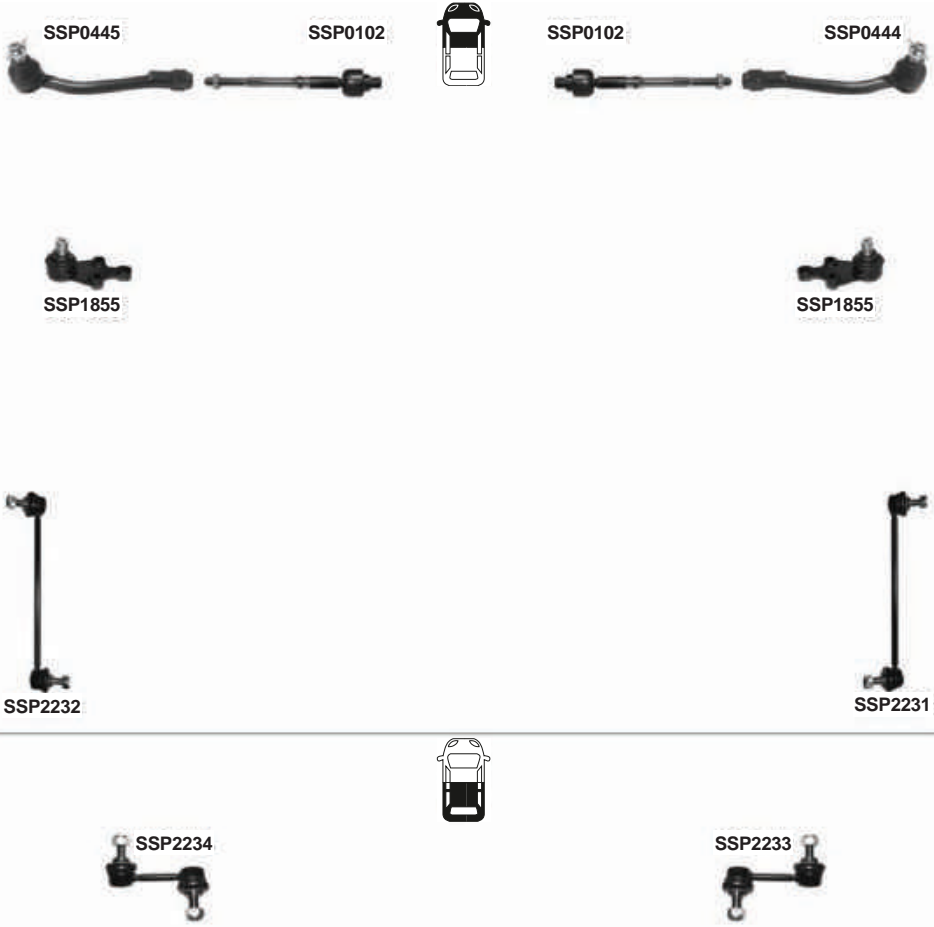

PART NO.	DESCRIPTION	NOTES	O.E.
SSP0102 301191601020	Steering Tie Rod - Front Right	M14x1,5 - L=231mm	577244H100
SSP0444 301191604440	Steering Tie Rod End - Front Right	M14x1,5	568204H100
SSP0445 301191604450	Steering Tie Rod End - Front Left	M14x1,5	568204H000
SSP1855 301191618550	Suspension Ball Joint - Front Lower	D=Ø20mm	545303J000
SSP2231 301191622310	Suspension Stabilizer Bar Link - Front Right	L=275mm	548404H000
SSP2232 301191622320	Suspension Stabilizer Bar Link - Front Left	L=275mm	548304H000
SSP2233 301191622330	Suspension Stabilizer Bar Link - Rear Right	L=85mm	555404H000
SSP2234 301191622340	Suspension Stabilizer Bar Link - Rear Left	L=85mm	555304H000

**HYUNDAI i40 (VF)**

2011-



PART NO.	DESCRIPTION	NOTES	O.E.
ARM613	301181361300 Lateral Arm - Rear		551003Z000
ARM614	301181361400 Suspension Control Arm and Ball Joint Assembly - Front Right		545013Z000
ARM615	301181361500 Suspension Control Arm and Ball Joint Assembly - Front Left		545003Z000
SSP0109	301191601090 Steering Tie Rod - Front		577243Z000
SSP0457	301191604570 Steering Tie Rod End - Front Right Outer		568203V100
SSP0458	301191604580 Steering Tie Rod End - Front Left Outer		568203V190
SSP2248	301191622480 Suspension Stabilizer Bar Link - Rear	L=96mm	545303Z000; 555403Z000
SSP2249	301191622490 Suspension Stabilizer Bar Link - Front		548303Z000



HYUNDAI ix20 (JC)



11/2010-

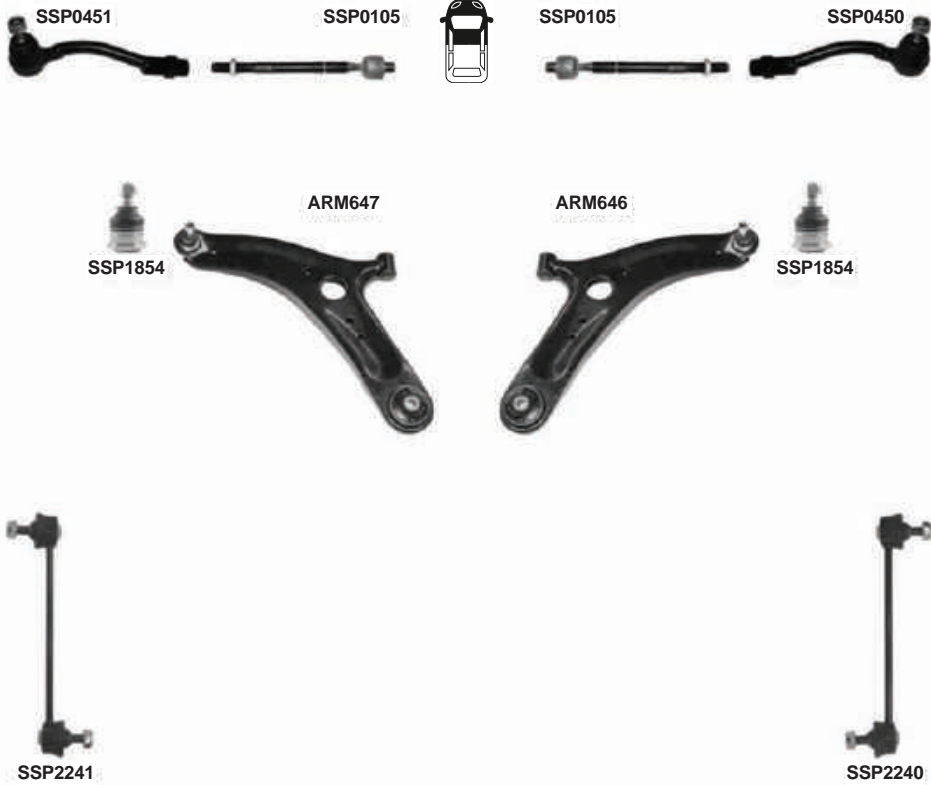

	PART NO.	DESCRIPTION	NOTES	O.E.
ARM646	301181364600	Suspension Control Arm and Ball Joint Assembly - Front Right Lower		545011P100
ARM647	301181364700	Suspension Control Arm and Ball Joint Assembly - Front Left Lower		545001P100
SSP0105	301191601050	Steering Tie Rod - Front	M16X1,5 - L=249mm	565402K000; 565403J000*
SSP0450	301191604500	Steering Tie Rod End - Front Right	M16x1,5	568202K050
SSP0451	301191604510	Steering Tie Rod End - Front Left	M16x1,5	568202K000
SSP1854	301191618540	Suspension Ball Joint - Front		5450322000; 5453025000; 5450322A00; 5450331600
SSP2240	301191622400	Suspension Stabilizer Bar Link - Front Right	L=216mm	548401J000
SSP2241	301191622410	Suspension Stabilizer Bar Link - Front Left	L=216mm	548301J000



HYUNDAI ix35



01/2010-2015

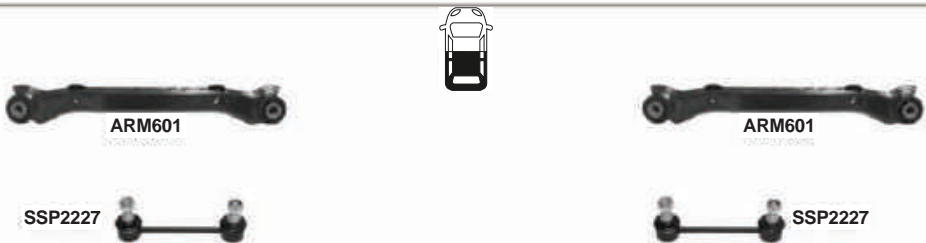
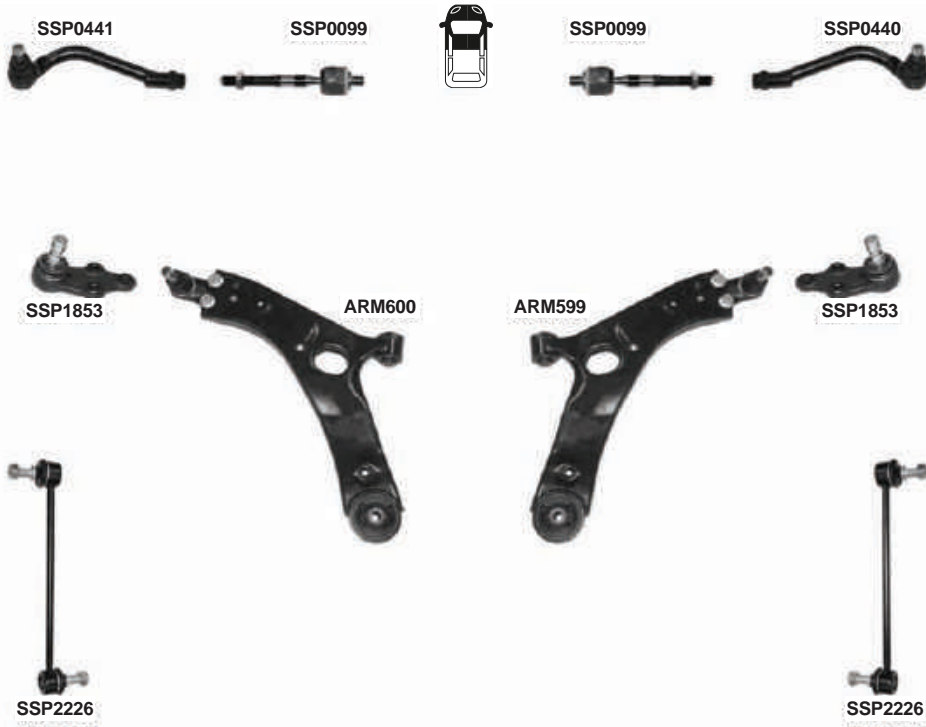

	PART NO.	DESCRIPTION	NOTES	O.E.
ARM599	301181359900	Suspension Control Arm and Ball Joint Assembly - Front Right Lower		545012Y000; 545012Y002
ARM600	301181360000	Suspension Control Arm and Ball Joint Assembly - Front Left Lower		545002Y000; 545002Y002
ARM601	301181360100	Lateral Arm - Rear Upper		551002S000; 551002S050
SSP0099	301191600990	Steering Tie Rod - Front	M16X1,5 - L=183mm	577242S000; 577242S100
SSP0440	301191604400	Steering Tie Rod End - Front Right	M16X1,5	568202S050; 568203Q500
SSP0441	301191604410	Steering Tie Rod End - Front Left	M16X1,5	568202S000; 568203Q000
SSP1853	301191618530	Suspension Ball Joint - Front Lower		545303S000
SSP2226	301191622260	Suspension Stabilizer Bar Link - Front	L=267mm	548302S200
SSP2227	301191622270	Suspension Stabilizer Bar Link - Rear	L=140mm	555302S200



HYUNDAI ix55



09/2008-



PART NO.	DESCRIPTION	NOTES	O.E.
SSP0100 301191601000	Steering Tie Rod - Front	M-16X1,5 - L=218mm	577243J000
SSP0462 301191604620	Steering Tie Rod End - Front Right	M16x1,5	568202B900; 568202P900
SSP0463 301191604630	Steering Tie Rod End - Front Left	M16x1,5	568202B000; 568202P000
SSP1855 301191618550	Suspension Ball Joint - Front Lower	D=Ø20mm	545303J000
SSP2255 301191622550	Suspension Stabilizer Bar Link - Front Right	L=341mm	548402B000; 548402B200
SSP2256 301191622560	Suspension Stabilizer Bar Link - Front Right	(Clip-on patented design) L=341mm	548402B000*
SSP2257 301191622570	Suspension Stabilizer Bar Link - Front Left	L=341mm	548302B000; 548302B200
SSP2258 301191622580	Suspension Stabilizer Bar Link - Front Left	(Clip-on patented design) L=341mm	548302B000*



HYUNDAI MATRIX



06/2001-08/2010

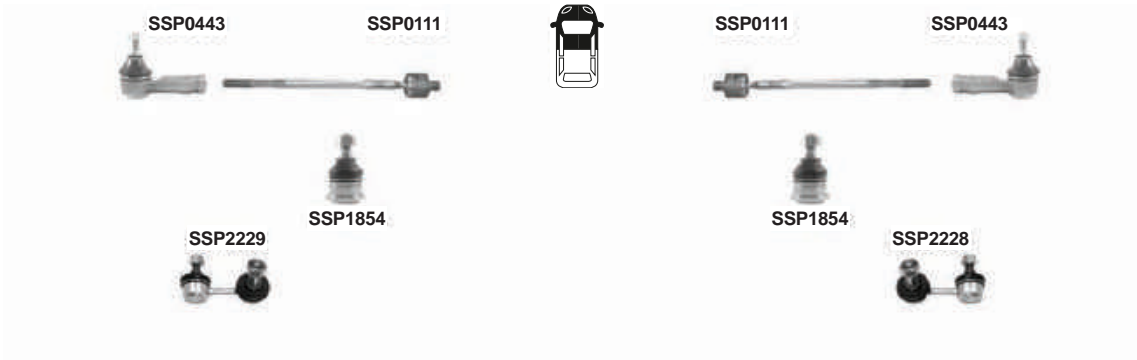

PART NO.	DESCRIPTION	NOTES	O.E.
SSP0111 301191601110	Steering Tie Rod - Front	M14x1,5 - L=322mm	5771634000; 5775517000; 5778526200
SSP0443 301191604430	Steering Tie Rod End - Front	M14x1,5Rht	5682025000
SSP1854 301191618540	Suspension Ball Joint - Front		5450322000; 5453025000; 5450322A00; 5450331600
SSP2228 301191622280	Suspension Stabilizer Bar Link - Front Right	L=60mm	5483017020; 5483025020
SSP2229 301191622290	Suspension Stabilizer Bar Link - Front Left	L=60mm	5483017010; 5483025010



HYUNDAI PONY EXCEL II



1985-1989



PART NO.	DESCRIPTION	NOTES	O.E.
SSP0550 301191605500	Steering Tie Rod End - Front Outer	M14x1,5Rht	5687243010; MB166426; MB527650



HYUNDAI Santa Fe I SM



02/2001-02/2006



PART NO.	DESCRIPTION	NOTES	O.E.
ARM619	Suspension Control Arm and Ball Joint Assembly - Front Right Lower		5450226000
ARM620	Suspension Control Arm and Ball Joint Assembly - Front Left Lower		5450126000
SSP0111	Steering Tie Rod - Front	M14x1,5 - L=322mm	5771634000; 5775517000; 5778526200
SSP0461	Steering Tie Rod End - Front	M14x1,5Rht	568203B000
SSP1860	Suspension Ball Joint - Front Lower		545033BA00; 545303B000
SSP2251	Suspension Stabilizer Bar Link - Front Right	L=263mm	5484026000; 5484026100
SSP2252	Suspension Stabilizer Bar Link - Front Left	L=263mm	5483026000; 5483026100
SSP2253	Suspension Stabilizer Bar Link - Rear Right	L=117,5mm	5553026600
SSP2254	Suspension Stabilizer Bar Link - Rear Left	L=117,5mm	5554026600



HYUNDAI Santa Fe II CM



03/2006-08/2012

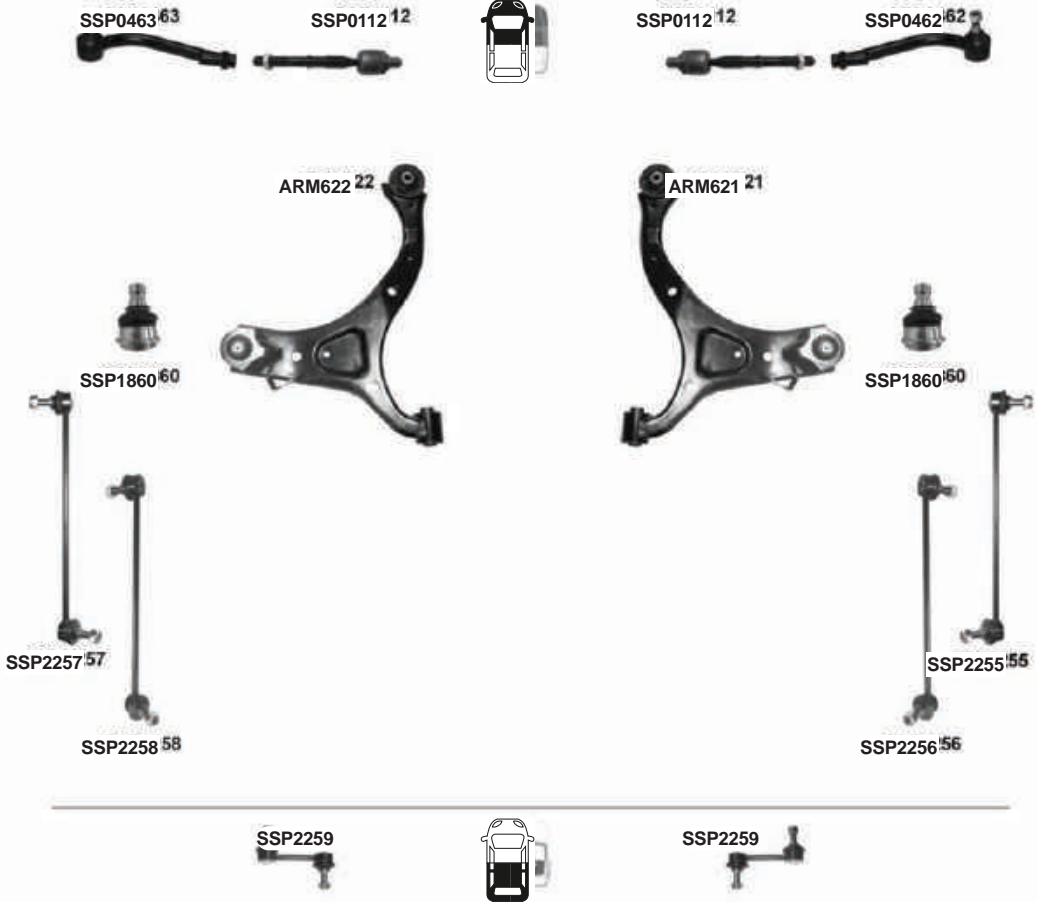

PART NO.	DESCRIPTION	NOTES	O.E.
ARM621	301181362100 Suspension Control Arm and Ball Joint Assembly - Front Right Lower		545012B100
ARM622	301181362200 Suspension Control Arm and Ball Joint Assembly - Front Left Lower		545002B100
SSP0112	301191601120 Steering Tie Rod - Front	M16x1,5 - L=194mm	577242B000
SSP0462	301191604620 Steering Tie Rod End - Front Right	M16x1,5	568202B900; 568202P900
SSP0463	301191604630 Steering Tie Rod End - Front Left	M16x1,5	568202B000; 568202P000
SSP1860	301191618600 Suspension Ball Joint - Front Lower		545033BA00; 545303B000
SSP2255	301191622550 Suspension Stabilizer Bar Link - Front Right	L=341mm	548402B000; 548402B200
SSP2256	301191622560 Suspension Stabilizer Bar Link - Front Right	(Clip-on patented design) L=341mm	548402B000*
SSP2257	301191622570 Suspension Stabilizer Bar Link - Front Left	L=341mm	548302B000; 548302B200
SSP2258	301191622580 Suspension Stabilizer Bar Link - Front Left	(Clip-on patented design) L=341mm	548302B000*
SSP2259	301191622590 Suspension Stabilizer Bar Link - Rear	L=99,5mm	555302B000; 555302B200

**HYUNDAI Santa Fe III DM**

09/2012-

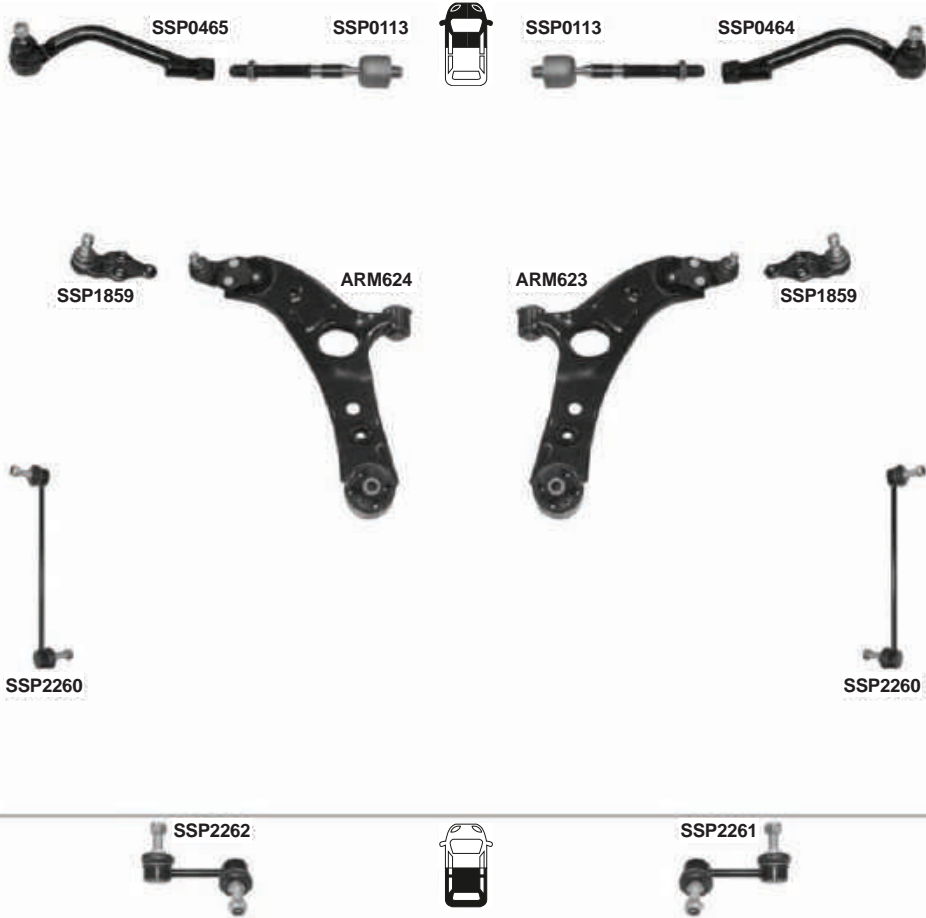

PART NO.	DESCRIPTION	NOTES	O.E.
ARM623	301181362300 Suspension Control Arm and Ball Joint Assembly - Front Right Lower		545012W200
ARM624	301181362400 Suspension Control Arm and Ball Joint Assembly - Front Left Lower		545002W200
SSP0113	301191601130 Steering Tie Rod - Front		577242W000
SSP0464	301191604640 Steering Tie Rod End - Front Right	M16X1,5	568202W050
SSP0465	301191604650 Steering Tie Rod End - Front Left	M16X1,5	568202W000
SSP1859	301191618590 Suspension Ball Joint - Front		545303S100
SSP2260	301191622600 Suspension Stabilizer Bar Link - Front	L=328mm	548302W000
SSP2261	301191622610 Suspension Stabilizer Bar Link - Rear Right	L=88mm	555402W110
SSP2262	301191622620 Suspension Stabilizer Bar Link - Rear Left	L=88mm	555302W100



HYUNDAI SONATA I



09/1988-05/1993



SSP0461



SSP0461

PART NO.	DESCRIPTION	NOTES	O.E.
SSP0461 301191604610	Steering Tie Rod End - Front	M14x1,5Rht	568203B000



HYUNDAI SONATA II



05/1993-06/1998



PART NO.	DESCRIPTION	NOTES	O.E.
SSP0111 301191601110	Steering Tie Rod - Front	M14x1,5 - L=322mm	5771634000; 5775517000; 5778526200
SSP0551 301191605510	Steering Tie Rod End - Front	M14x1,5Rht	5682036000; MB912519; MB192430; MB616286



HYUNDAI SONATA VI



2011-2015



ARM601



ARM601

PART NO.	DESCRIPTION	NOTES	O.E.
ARM601 301181360100	Lateral Arm - Rear Upper		551002S000; 551002S050



HYUNDAI STAREX (H1)



01/1996-11/2007



PART NO.	DESCRIPTION	NOTES	O.E.
SSP1901 301191619010	Suspension Ball Joint - Front Upper		544174AA00; MB527350; MR241623; MB241623; MB527349
SSP2230 301191622300	Suspension Stabilizer Bar Link - Rear	L=115mm	555304A001; MR267875



HYUNDAI TIBURON



1997-2008



PART NO.	DESCRIPTION	NOTES	O.E.
SSP0443 301191604430	Steering Tie Rod End - Front	M14x1,5Rht	5682025000



HYUNDAI TUCSON JM



08/2004-03/2010



PART NO.	DESCRIPTION	NOTES	O.E.
ARM602 301181360200	Lateral Arm - Rear		55220-2E010
ARM640 301181364000	Suspension Control Arm and Ball Joint Assembly - Front Right Lower		545011F000; 5450120000000000; 5,45012E+35
ARM641 301181364100	Suspension Control Arm and Ball Joint Assembly - Front Left Lower		545001F000; 5450020000000000; 5,45002E+35
SSP0103 301191601030	Steering Tie Rod - Front	L=243.7mm - M16x1,5Rht.	57724-2E000
SSP0448 301191604480	Steering Tie Rod End - Front Right	M16x1,5Rht	568202E900
SSP0449 301191604490	Steering Tie Rod End - Front Left	M16x1,5Rht	56820-2E000
SSP1870 301191618700	Suspension Ball Joint - Front		51760-2E000; 51770-2E010; 51760-2E010; 51770-2E000
SSP1871 301191618710	Suspension Ball Joint - Front Lower		545012E030 / 545002E030 Part of
SSP2236 301191622360	Suspension Stabilizer Bar Link - Rear	L=219mm	55530-2E000
SSP2237 301191622370	Suspension Stabilizer Bar Link - Front	L=238mm	54830-2E000



HYUNDAI TUCSON 2nd Gen



2010-2015



PART NO.	DESCRIPTION	NOTES	O.E.
ARM601 301181360100	Lateral Arm - Rear Upper		551002S000; 551002S050

**HYUNDAI VERACRUZ**

2008-2015

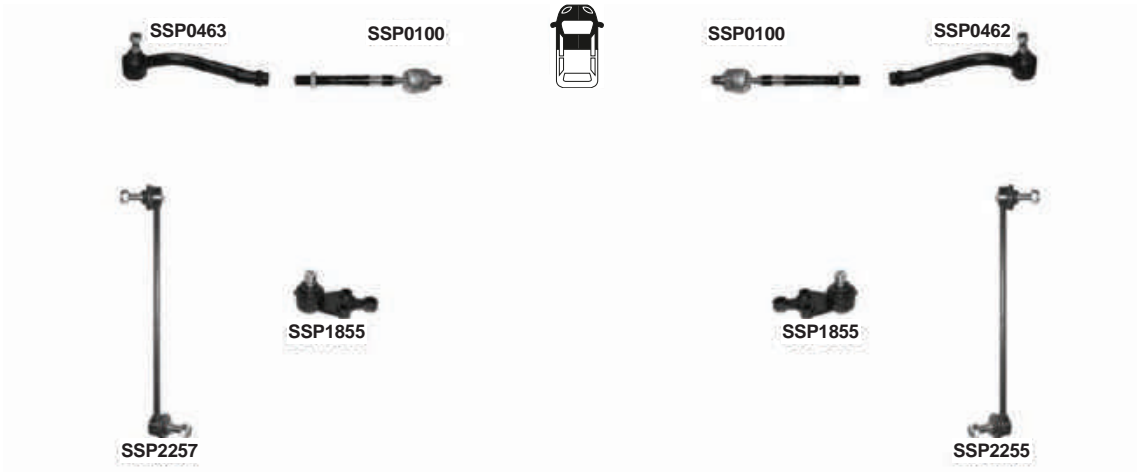

PART NO.	DESCRIPTION	NOTES	O.E.
SSP0100 301191601000	Steering Tie Rod - Front	M-16X1,5 - L=218mm	577243J000
SSP0462 301191604620	Steering Tie Rod End - Front Right	M16x1,5	568202B900; 568202P900
SSP0463 301191604630	Steering Tie Rod End - Front Left	M16x1,5	568202B000; 568202P000
SSP1855 301191618550	Suspension Ball Joint - Front Lower	D=Ø20mm	545303J000
SSP2255 301191622550	Suspension Stabilizer Bar Link - Front Right	L=341mm	548402B000; 548402B200
SSP2257 301191622570	Suspension Stabilizer Bar Link - Front Left	L=341mm	548302B000; 548302B200



INFINITI G20 1st Gen, P10



1990-1996



ARM838



ARM837



SSP2446



SSP1916



SSP2446

SSP1916

	PART NO.	DESCRIPTION	NOTES	O.E.
ARM837	301181383700	Suspension Control Arm - Front Right Upper		545242F010; 5452486J10; 545242J001; 5452450J00
ARM838	301181383800	Suspension Control Arm - Front Left Upper		545252F010; 5452586J10; 545252J001; 5452550J00
ARM839	301181383900	Suspension Control Arm and Ball Joint Assembly - Right Lower		545002F500; 545009F000
ARM840	301181384000	Suspension Control Arm and Ball Joint Assembly - Left Lower		545012F500; 545019F000
SSP1916	301191619160	Suspension Ball Joint - Front Lower		4016050A00; 4016070J00; 4016050J25; 4016060Y60
SSP1917	301191619170	Suspension Ball Joint - Front Lower		4016050Y00; 4016052Y00; 4016060Y20
SSP2446	301191624460	Suspension Stabilizer Bar Link - Front		5461850J20



INFINITI QX4 R50



1997-2004

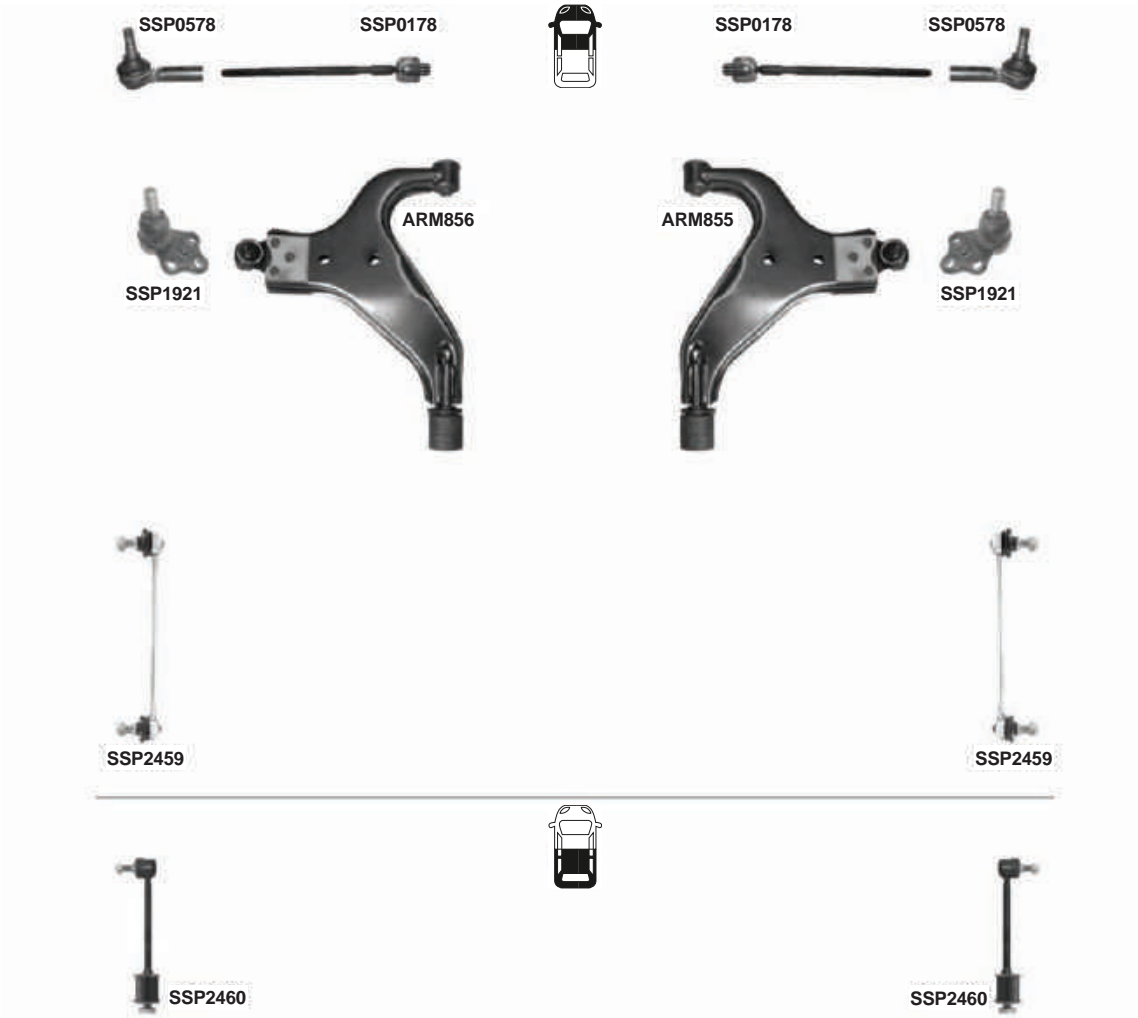

PART NO.	DESCRIPTION	NOTES	O.E.
ARM855 301181385500	Suspension Control Arm and Ball Joint Assembly - Front Right Lower		545000W000*
ARM856 301181385600	Suspension Control Arm and Ball Joint Assembly - Front Left Lower		545010W000*
SSP0178 301191601780	Steering Tie Rod - Front		485210W025
SSP0578 301191605780	Steering Tie Rod End - Front Outer		485200P725; 485203S525; 485200W025; 485203S500
SSP1921 301191619210	Suspension Ball Joint - Front Lower		401600W000; 401600W025
SSP2459 301191624590	Suspension Stabilizer Bar Link - Front		5461801F00; 546180W001
SSP2460 301191624600	Suspension Stabilizer Bar Link - Rear		1954821; 562600F001; 562600W001



INFINITI QX56 1st Gen



2004-2010

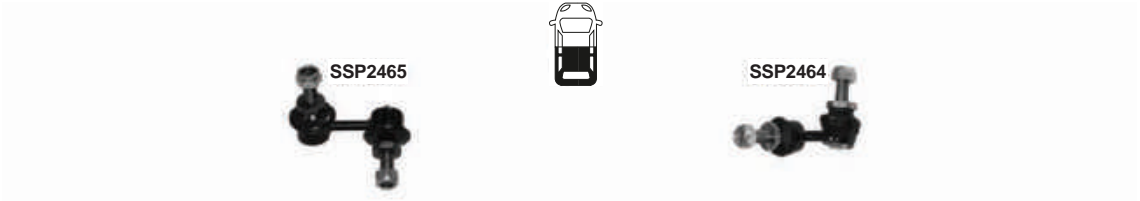

PART NO.	DESCRIPTION	NOTES	O.E.
SSP2464 301191624640	Suspension Stabilizer Bar Link - Rear Right		56261EA500; 9L3Z5K483D
SSP2465 301191624650	Suspension Stabilizer Bar Link - Rear Left		56261EA510



INFINITI QX60



2014-



PART NO.	DESCRIPTION	NOTES	O.E.
SSP2474 301191624740	Suspension Stabilizer Bar Link - Front Right		546183JA0C*
SSP2475 301191624750	Suspension Stabilizer Bar Link - Front Left		546683JA0B*



ISUZU ASCENDER



2003-2008

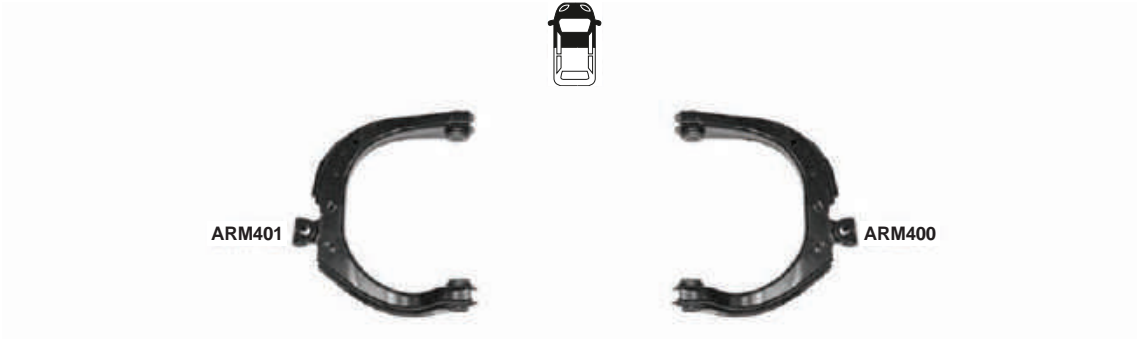

	PART NO.	DESCRIPTION	NOTES	O.E.
ARM400	301181340000	Suspension Control Arm - Front Right		25786775
ARM401	301181340100	Suspension Control Arm - Front Left		25786774

**IVECO DAILY III**

05/1999-05/2006

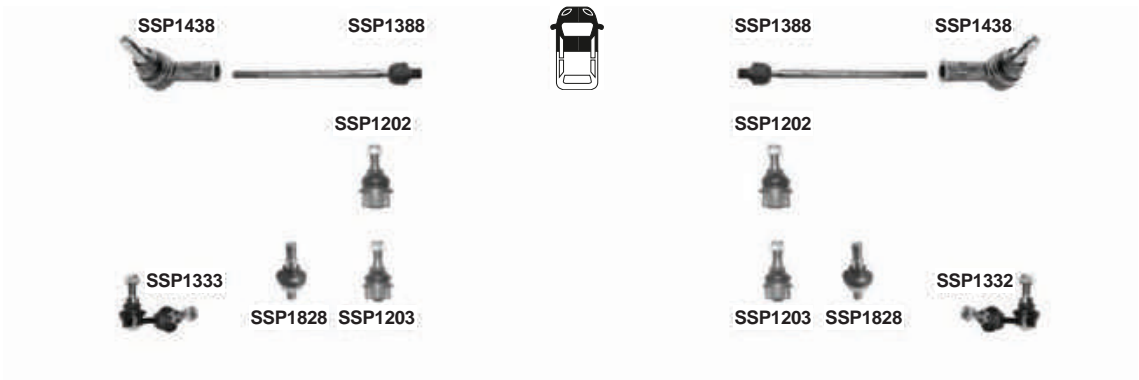

	PART NO.	DESCRIPTION	NOTES	O.E.
ARM497	301181349700	Suspension Control Arm and Ball Joint Assembly - Front Right Upper		500379802
ARM498	301181349800	Suspension Control Arm and Ball Joint Assembly - Front Left Upper		500379801
ARM499	301181349900	Suspension Control Arm and Ball Joint Assembly - Front Right Lower		6570gr
SSP1202	301181312020	Suspension Ball Joint - Front		-
SSP1203	301181312030	Suspension Ball Joint - Front Lower		-
SSP1332	301181313320	Suspension Stabilizer Bar Link - Front Right	L=50mm	500383975
SSP1333	301181313330	Suspension Stabilizer Bar Link - Front Left	L=50mm	500383976
SSP1388	301181313880	Steering Tie Rod - Front	M16x1,5Rht - L=345 mm	2992593
SSP1438	301181314380	Steering Tie Rod End - Front	M16x1,5Rht	42534911
SSP1828	301191618280	Suspension Ball Joint - Front Lower	for vehicles with stabilizer	504212584; 504212586



IVECO DAILY IV



06/2006-



PART NO.	DESCRIPTION	NOTES	O.E.
SSP1388 301181313880	Steering Tie Rod - Front	M16x1,5Rht - L=345 mm	2992593
SSP1438 301181314380	Steering Tie Rod End - Front	M16x1,5Rht	42534911



IVECO DAILY I-GRINTA



1978-1998



SSP1204



SSP1204

PART NO.	DESCRIPTION	NOTES	O.E.
SSP1204 301181312040	Suspension Ball Joint - Front Lower	30-32-35-40	3302242; 93807545



IVECO DAILY II



05/1999-05/2006

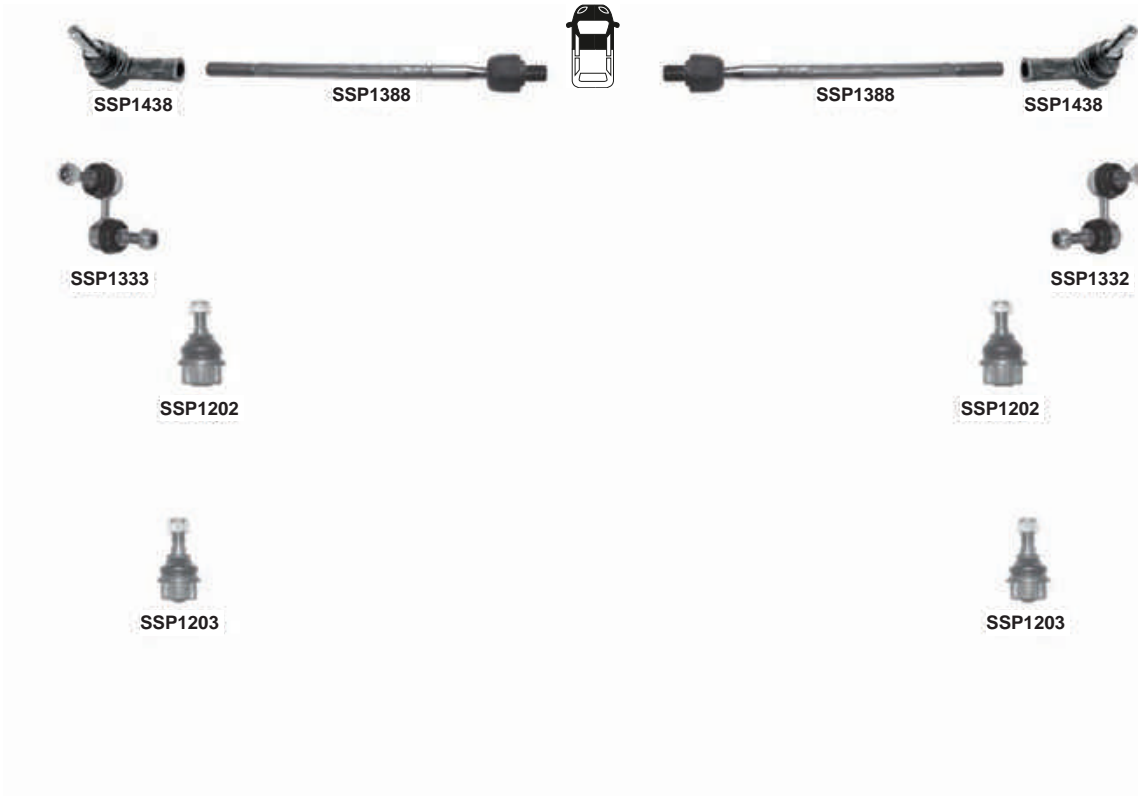

PART NO.	DESCRIPTION	NOTES	O.E.
SSP1202 301181312020	Ball joint upper		
SSP1203 301181312030	Ball joint lower		
SSP1332 301181313320	Stabilizer link front Rh	L=50mm	500383975
SSP1333 301181313330	Stabilizer link front Lh	L=50mm	500383976
SSP1388 301181313880	Axial joint	M16x1,5Rht - L=345mm	2992593
SSP1438 301181314380	Tie rod end	M16x1,5Rht	42534911



JAGUAR X-TYPE



06/2001-11/2009

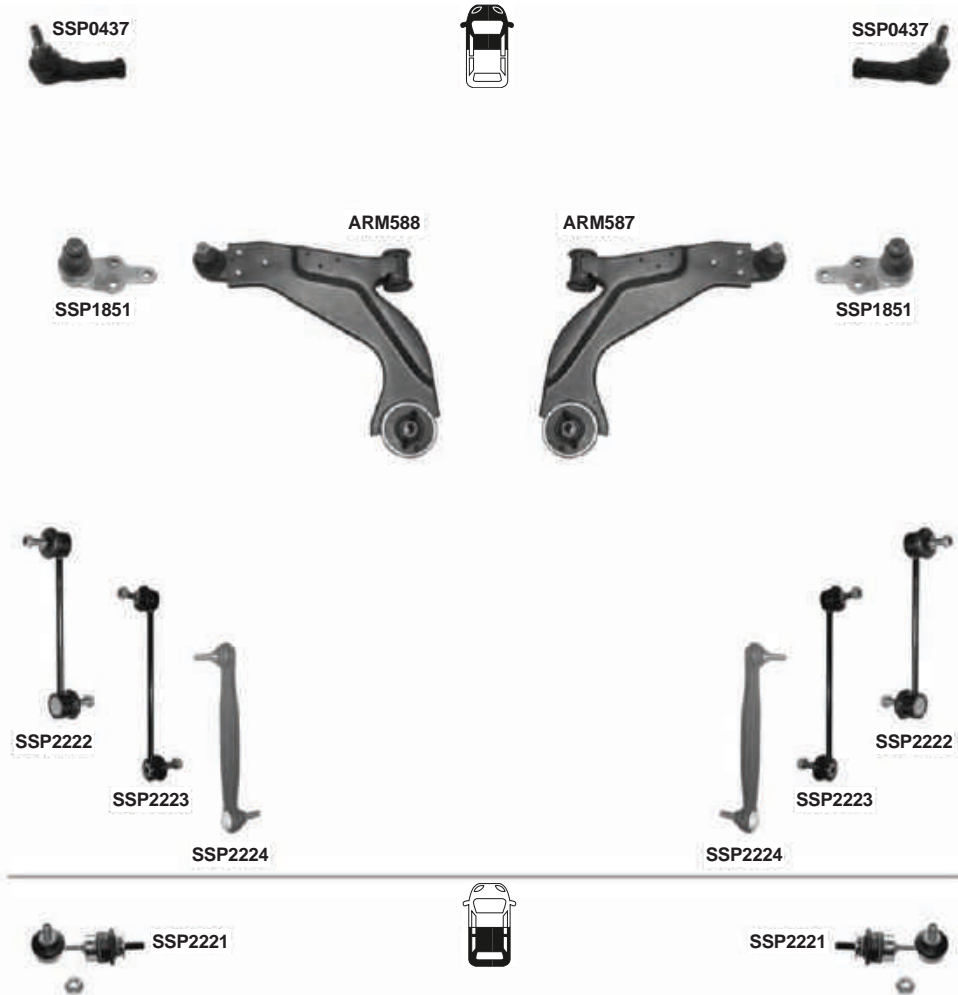

PART NO.	DESCRIPTION	NOTES	O.E.
ARM587	301181358700	Suspension Control Arm and Ball Joint Assembly - Front Right Lower	1203923; 1S713042AN; 1S713042AP; 1S713042AM; 1311416; 1S713042AK; 1S713042AH
ARM588	301181358800	Suspension Control Arm and Ball Joint Assembly - Front Left Lower	1203924; 1S713051AN; 1S713051AP; 1S713051AM; 1311417; 1S713051AK; 1S713051AH
SSP0437	301191604370	Steering Tie Rod End - Front	M16x1,5Rht 1138314; C2S12013; 1S713290AB; 1X433289AB; 1S713290BB
SSP1851	301191618510	Suspension Ball Joint - Front	D=Ø21mm 1679376; C2S8390; 1X43395AB; C2S37075; C2S19367
SSP2221	301191622210	Suspension Stabilizer Bar Link - Rear	L=51mm 1130452; 1S715C486BE
SSP2222	301191622220	Suspension Stabilizer Bar Link - Front	Metal L=249mm 1127646; 1S713B438AC; SX433B438AA; C2S26883
SSP2223	301191622230	Suspension Stabilizer Bar Link - Front	Metal (Clip-on patented design) L=249mm 1117698; 1127646; C2S26883
SSP2224	301191622240	Suspension Stabilizer Bar Link - Front	Plastic L=250mm 1219698; 1S13B438BA; C2S26883; 5X433B438AA



JEEP CHEROKEE 2nd Gen, XJ



10/1984-03/2001



PART NO.	DESCRIPTION	NOTES	O.E.
SSP1205 301181312050	Suspension Ball Joint - Front Lower		Part of 83500202
SSP1206 301181312060	Suspension Ball Joint - Front Upper		8983500202
SSP1209 301181312090	Suspension Ball Joint - Front Lower		-
SSP1861 301191618610	Suspension Ball Joint - Front		83500202



JEEP CHEROKEE XJ



1991-1999



PART NO.	DESCRIPTION	NOTES	O.E.
SSP1441 301181314410	Steering Tie Rod End - Front Left		52005739



JEEP CHEROKEE KJ



01/2001-01/2008

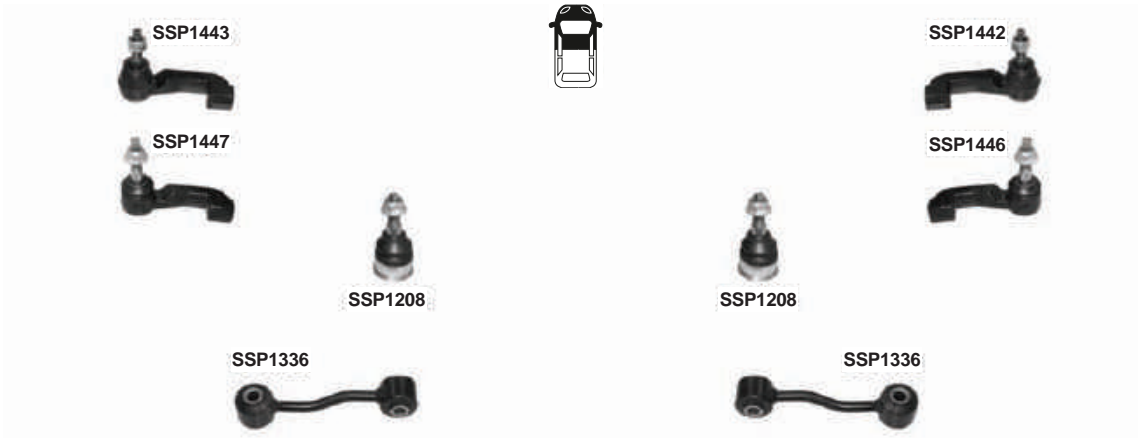

	PART NO.	DESCRIPTION	NOTES	O.E.
ARM627	301181362700	Suspension Control Arm and Ball Joint Assembly - Front Right Lower		52088636AD
ARM628	301181362800	Suspension Control Arm and Ball Joint Assembly - Front Left Lower		52088637AD
SSP1208	301181312080	Suspension Ball Joint - Front Lower		5114037AI; 5110437AA; 5110437AI; 5069161AA
SSP1336	301181313360	Suspension Stabilizer Bar Link - Front	L=149 mm	52088662AB
SSP1442	301181314420	Steering Tie Rod End - Front Right Outer	(Type: 3.7i V6) M14X1,5	K52125483AA
SSP1443	301181314430	Steering Tie Rod End - Front Left	(Type: 3.7i V6) M14X1,5	K52125484AA
SSP1446	301181314460	Steering Tie Rod End - Front Right Outer	M16X1,5	5072444AA; 52128520AA
SSP1447	301181314470	Steering Tie Rod End - Front Left Outer	M16X1,5	5072445AA; 52128521AA



JEEP CHEROKEE KK



01/2008-2013



SSP1447



SSP1446



SSP1336



SSP1208



SSP1208



SSP1336

	PART NO.	DESCRIPTION	NOTES	O.E.
SSP1208	301181312080	Suspension Ball Joint - Front Lower		5114037AI; 5110437AA; 5110437AI; 5069161AA
SSP1336	301181313360	Stabilizer link front	L=149mm	52089467AB
SSP1446	301181314460	Tie rod end Rh	M16x1,5	5072445AA
SSP1447	301181314470	Steering Tie Rod End - Front Left Outer	M16X1,5	5072445AA; 52128521AA



PART NO.	DESCRIPTION	NOTES	O.E.
SSP0114 301191601140	Steering Tie Rod - Front		68066486AA

**JEEP COMMANDER XK**

2005-2010



	PART NO.	DESCRIPTION	NOTES	O.E.
ARM625	301181362500	Suspension Control Arm and Ball Joint Assembly - Front Right Lower		52089980A
ARM626	301181362600	Suspension Control Arm and Ball Joint Assembly - Front Left Lower		52089981A
SSP1207	301181312070	Suspension Ball Joint - Front Lower		5135651AE
SSP1334	301181313340	Suspension Stabilizer Bar Link - Rear		52089486AE
SSP1335	301181313350	Suspension Stabilizer Bar Link - Front		52089467AB
SSP1444	301181314440	Steering Tie Rod End - Front Right		5143556AC
SSP1445	301181314450	Steering Tie Rod End - Front Left		5143555AC
SSP1862	301191618620	Suspension Ball Joint - Front Upper		52090206AF



JEEP COMPASS MK49



06/2006-2015



PART NO.	DESCRIPTION	NOTES	O.E.
ARM629	301181362900 Suspension Control Arm and Ball Joint Assembly - Front Right		5105040AH; 5105040AD
ARM630	301181363000 Suspension Control Arm and Ball Joint Assembly - Front Left		5105041AH; 5105041AC
SSP1337	301181313370 Suspension Stabilizer Bar Link - Rear	L=80 mm	05174245AD
SSP1338	301181313380 Suspension Stabilizer Bar Link - Front	L=265mm	05174185AC
SSP1391	301181313910 Steering Tie Rod - Front	M14X1,5 - L=298mm	68040224AA
SSP1406	301181314060 Steering Tie Rod End - Front	M14x1,5	05066373AB; K05183761AA; ES3008RL; 5183761AA; 05183761AD
SSP1865	301191618650 Suspension Ball Joint - Front Lower		5105041AC / 5105041AH Part of; 5105040AC / 5105040AH Part of
SSP2269	301191622690 Suspension Stabilizer Bar Link - Front		5151803AA



JEEP GRAND CHEROKEE I ZJ



09/1991-05/1999



PART NO.	DESCRIPTION	NOTES	O.E.
SSP1205 301181312050	Suspension Ball Joint - Front Lower		Part of 83500202
SSP1206 301181312060	Suspension Ball Joint - Front Upper		8983500202
SSP1441 301181314410	Steering Tie Rod End - Front Left	M22x1,5Lht	52005739
SSP1861 301191618610	Suspension Ball Joint - Front		83500202
SSP2263 301191622630	Suspension Stabilizer Bar Link - Front		52088437; 52087846



JEEP GRAND CHEROKEE II WJ, WG  06/1999-05/2005

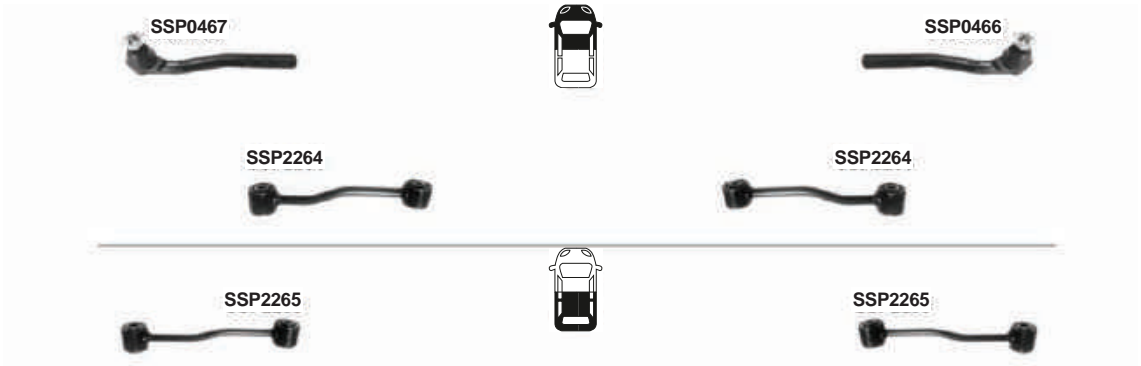

PART NO.	DESCRIPTION	NOTES	O.E.
SSP0466 301191604660	Steering Tie Rod End - Front Right	M12X1,5	52088466; 52088870AA
SSP0467 301191604670	Steering Tie Rod End - Front Left	M12X1,5	52088467; 52088869AA
SSP1863 301191618630	Suspension Ball Joint - Front Lower		68004085AA
SSP1864 301191618640	Suspension Ball Joint - Front Upper		5012432AA
SSP2264 301191622640	Suspension Stabilizer Bar Link - Front		52088283
SSP2265 301191622650	Suspension Stabilizer Bar Link - Rear		52088319; 52088319AB



JEEP GRAND CHEROKEE III WHWK 06/2005-12/2010



SSP1445



SSP1444



SSP1207



SSP1207



SSP1335



SSP1335



SSP1334



SSP1334



	PART NO.	DESCRIPTION	NOTES	O.E.
ARM625	301181362500	Suspension Control Arm and Ball Joint Assembly - Front Right Lower		52089980A
ARM626	301181362600	Suspension Control Arm and Ball Joint Assembly - Front Left Lower		52089981A
SSP0114	301191601140	Steering Tie Rod - Front		68066486AA
SSP1207	301181312070	Suspension Ball Joint - Front Lower		5135651AE
SSP1334	301181313340	Suspension Stabilizer Bar Link - Rear	L=240 mm	52089486AE
SSP1335	301181313350	Suspension Stabilizer Bar Link - Front	L=230 mm	52089467AB
SSP1444	301181314440	Steering Tie Rod End - Front Right	M16X1,5	5143556AC
SSP1445	301181314450	Steering Tie Rod End - Front Left	M16X1,5	5143555AC
SSP1862	301191618620	Suspension Ball Joint - Front Upper		52090206AF



JEEP GRAND CHEROKEE WK2



2011-

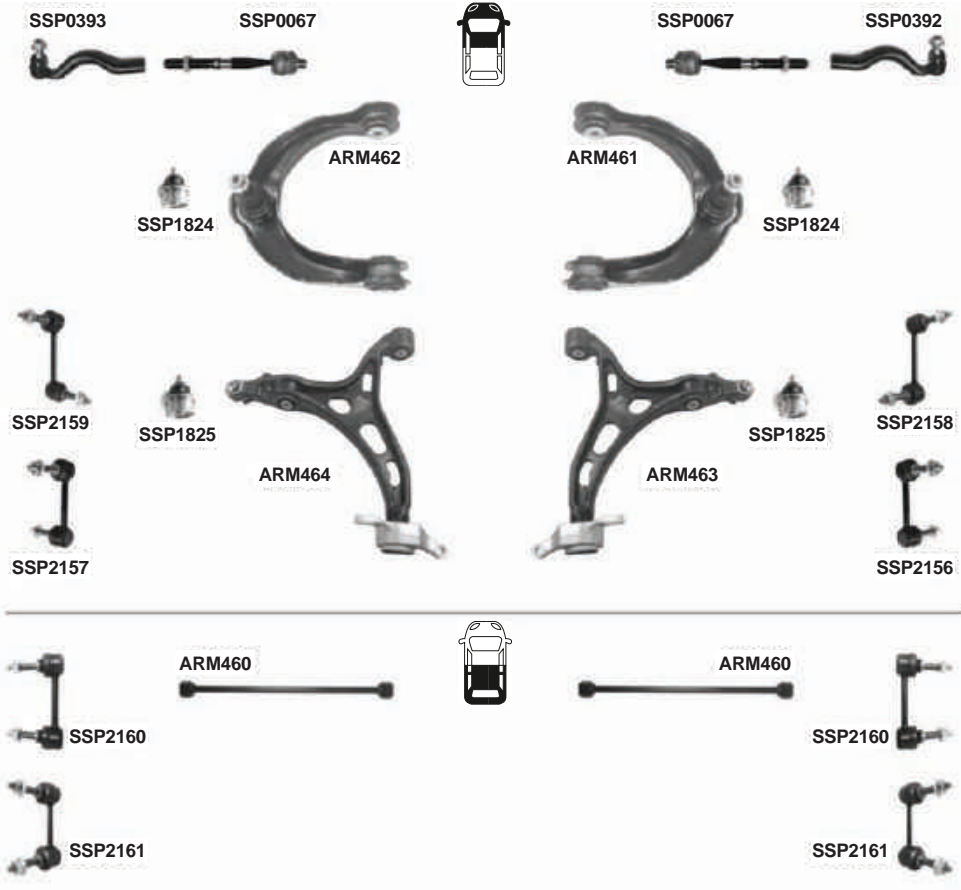

**JEEP GRAND CHEROKEE WK2****2011-**

	PART NO.	DESCRIPTION	NOTES	O.E.
ARM460	301181346000	Lateral Arm - Rear		52124840AB
ARM461	301181346100	Suspension Control Arm and Ball Joint Assembly - Front Right Upper		68217808AA
ARM462	301181346200	Suspension Control Arm and Ball Joint Assembly - Front Left Upper		68217809AA
ARM463	301181346300	Suspension Control Arm - Front Right Lower		5168158AA; 68022600AD; 5168158AB
ARM464	301181346400	Suspension Control Arm - Front Left Lower		5168159AA; 68022601AD; 5168159AB
SSP0067	301191600670	Steering Tie Rod - Front		68105872AA; 68105872AB
SSP0392	301191603920	Steering Tie Rod End - Front Right		68069646AB
SSP0393	301191603930	Steering Tie Rod End - Front Left		68069647AB
SSP1824	301191618240	Suspension Ball Joint - Front Upper		68217808AA; 68217809AA
SSP1825	301191618250	Suspension Ball Joint - Front Lower		68069648AB
SSP2156	301191621560	Suspension Stabilizer Bar Link - Front Right	sport suspension	68091836AA
SSP2157	301191621570	Suspension Stabilizer Bar Link - Front Left		68091837AA
SSP2158	301191621580	Suspension Stabilizer Bar Link - Front Right	standart type	68069654AB
SSP2159	301191621590	Suspension Stabilizer Bar Link - Front Left	standart type	68069655AB
SSP2160	301191621600	Suspension Stabilizer Bar Link - Rear	standart type	68069682AA
SSP2161	301191621610	Suspension Stabilizer Bar Link - Rear	Performance Package	68091853AA



JEEP LIBERTY KJ



01/2001-05/2007



SSP1447



SSP1446



SSP1336



SSP1208



SSP1208



SSP1336

	PART NO.	DESCRIPTION	NOTES	O.E.
ARM627	301181362700	Suspension Control Arm and Ball Joint Assembly - Front Right Lower		52088636AD
ARM628	301181362800	Suspension Control Arm and Ball Joint Assembly - Front Left Lower		52088637AD
SSP1208	301181312080	Suspension Ball Joint - Front Lower		5114037AI; 5110437AA; 5110437AI; 5069161AA
SSP1336	301181313360	Suspension Stabilizer Bar Link - Front	L=149 mm	52088662AB
SSP1446	301181314460	Steering Tie Rod End - Front Right Outer	M16X1,5	5072444AA; 52128520AA
SSP1447	301181314470	Steering Tie Rod End - Front Left Outer	M16X1,5	5072445AA; 52128521AA



JEEP LIBERTY KK



2008-2014

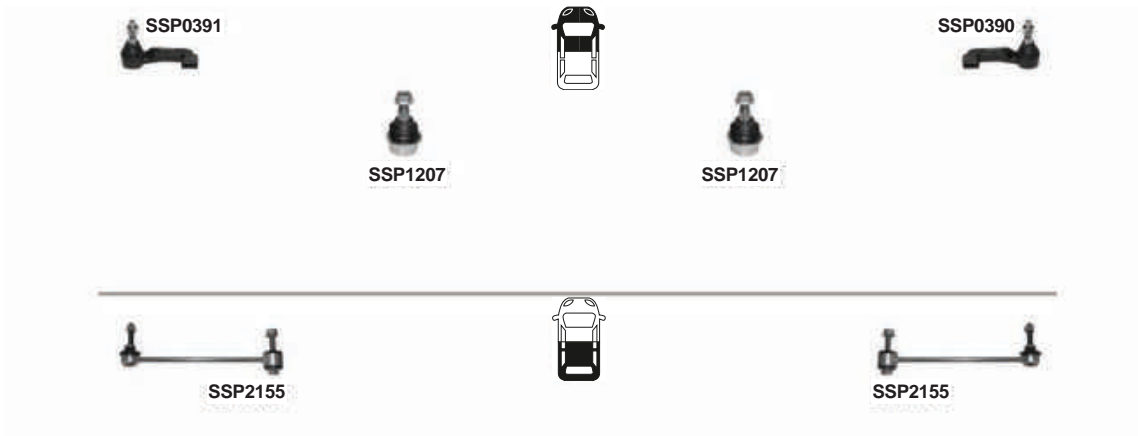

	PART NO.	DESCRIPTION	NOTES	O.E.
SSP0390	301191603900	Steering Tie Rod End - Front Right	M16X1,5	52125366AA
SSP0391	301191603910	Steering Tie Rod End - Front Left	M16X1,5	52125367AA
SSP1207	301181312070	Suspension Ball Joint - Front Lower		5135651AE
SSP2155	301191621550	Suspension Stabilizer Bar Link - Rear	L=180mm	68029024AA



JEEP PATRIOT



2007-2015

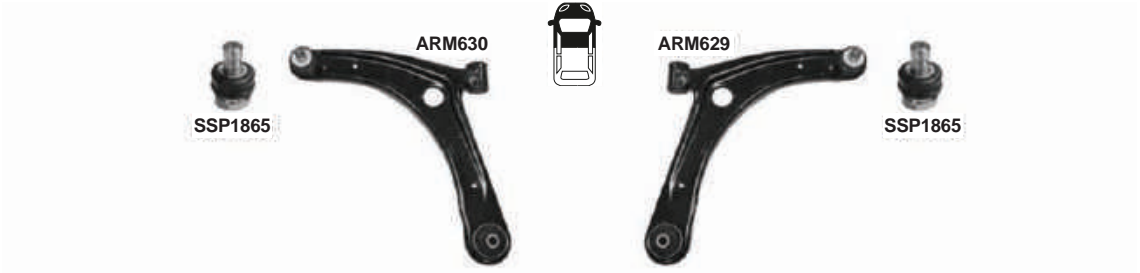

	PART NO.	DESCRIPTION	NOTES	O.E.
ARM629	301181362900	Suspension Control Arm and Ball Joint Assembly - Front Right		5105040AH; 5105040AD
ARM630	301181363000	Suspension Control Arm and Ball Joint Assembly - Front Left		5105041AH; 5105041AC
SSP1865	301191618650	Suspension Ball Joint - Front Lower		5105041AC / 5105041AH Part of; 5105040AC / 5105040AH Part of
SSP2269	301191622690	Suspension Stabilizer Bar Link - Front		5151803AA



JEEP RENEGADE



07/2014-



	PART NO.	DESCRIPTION	NOTES	O.E.
ARM479	301181347900	Suspension Control Arm and Ball Joint Assembly - Front Right	4X4	51939751
ARM480	301181348000	Suspension Control Arm and Ball Joint Assembly - Front Left	4X4	51939755
ARM483	301181348300	Suspension Control Arm and Ball Joint Assembly - Front Right Lower		51959820
ARM484	301181348400	Suspension Control Arm and Ball Joint Assembly - Front Left Lower		51961341
SSP0402	301191604020	Steering Tie Rod End - Front Right		77366699
SSP0403	301191604030	Steering Tie Rod End - Front Left		77366698
SSP1826	301191618260	Suspension Ball Joint - Front Lower		Part of:51961341/59820*; 51945321
SSP2163	301191621630	Suspension Stabilizer Bar Link - Front		51939949
SSP2164	301191621640	Suspension Stabilizer Bar Link - Rear	plastic type	53403319; 51942168



JEEP WRANGLER I



1991-1996



PART NO.	DESCRIPTION	NOTES	O.E.
SSP1863 301191618630	Suspension Ball Joint - Front Lower		68004085AA
SSP1864 301191618640	Suspension Ball Joint - Front Upper		5012432AA



JEEP WRANGLER TJ



08/1996-03/2007



SSP2266



SSP2266



PART NO.	DESCRIPTION	NOTES	O.E.
SSP1863 301191618630	Suspension Ball Joint - Front Lower		68004085AA
SSP1864 301191618640	Suspension Ball Joint - Front Upper		5012432AA
SSP2266 301191622660	Suspension Stabilizer Bar Link - Front		52087771; 52087771AB



JEEP WRANGLER JK

 04/2007-

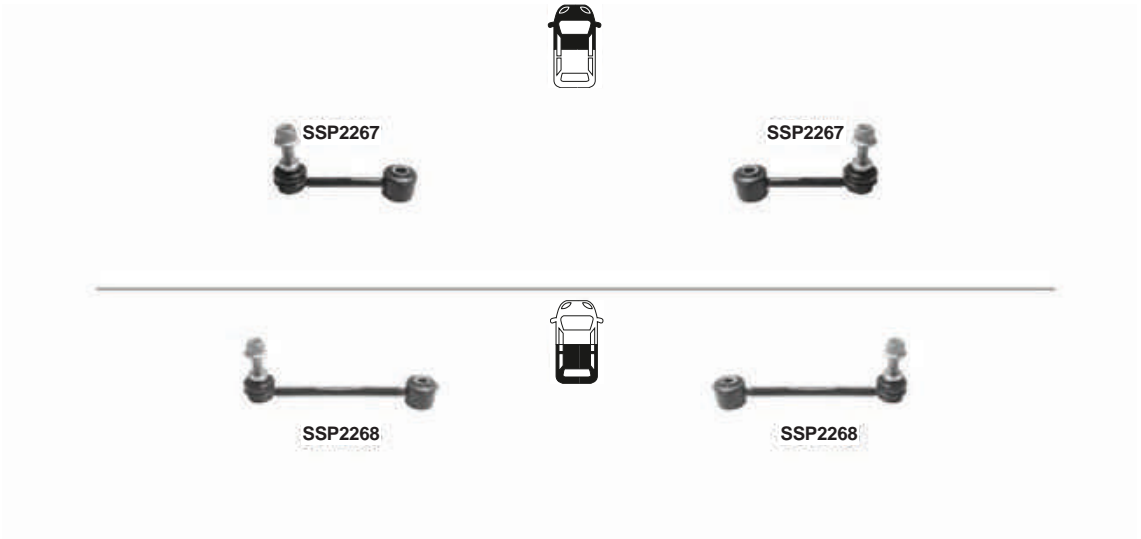

PART NO.	DESCRIPTION	NOTES	O.E.
SSP1863 301191618630	Suspension Ball Joint - Front Lower		68004085AA
SSP1864 301191618640	Suspension Ball Joint - Front Upper		5012432AA
SSP2267 301191622670	Suspension Stabilizer Bar Link - Front		52059975AC
SSP2268 301191622680	Suspension Stabilizer Bar Link - Rear		52060011AB



KIA BONGO



1997-2005

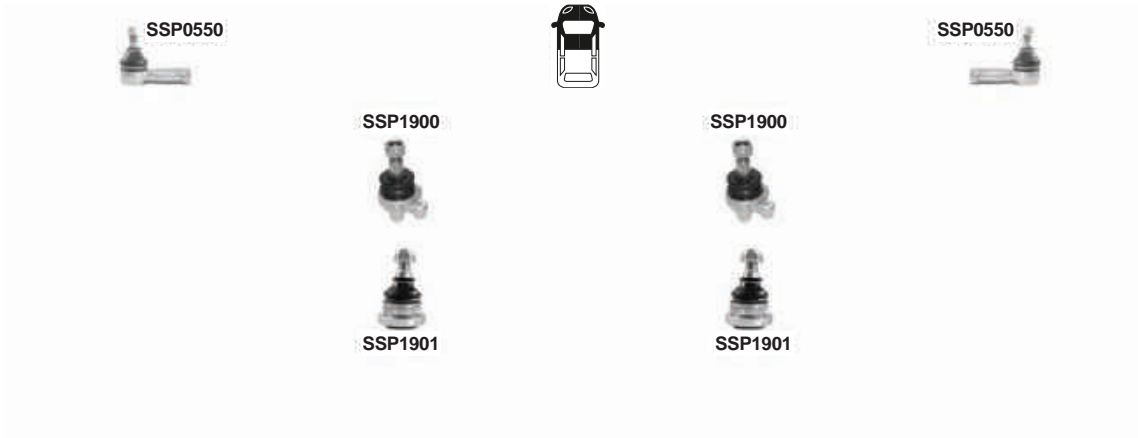

PART NO.	DESCRIPTION	NOTES	O.E.
SSP0550 301191605500	Steering Tie Rod End - Front Outer	M14x1,5Rht	5687243010; MB166426; MB527650
SSP1900 301191619000	Suspension Ball Joint - Front Lower		5452443301; MB349475; MB527383; 545244330A; MB176309
SSP1901 301191619010	Suspension Ball Joint - Front Upper		544174AA00; MB527350; MR241623; MB241623; MB527349



KIA CEED I



12/2006-04/2012

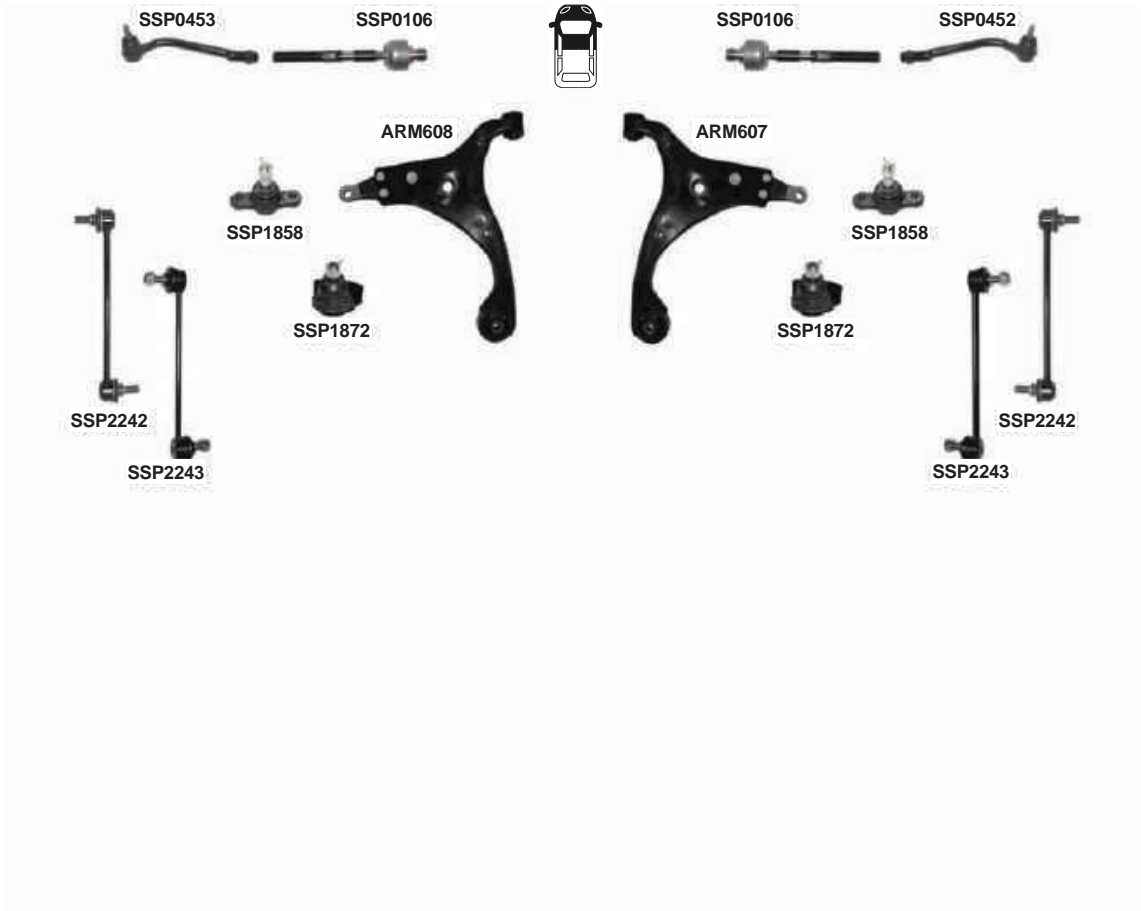

PART NO.	DESCRIPTION	NOTES	O.E.
ARM607	301181360700 Suspension Control Arm - Front Right Lower		545012H000
ARM608	301181360800 Suspension Control Arm - Front Left Lower		545002H000
SSP0106	301191601060 Steering Tie Rod - Front	M14x1,5 - L=156.5mm	565402H000
SSP0452	301191604520 Steering Tie Rod End - Front Right	M14x1,5	568202H090
SSP0453	301191604530 Steering Tie Rod End - Front Left	M14x1,5	568202H000
SSP1858	301191618580 Suspension Ball Joint - Front		517602G000
SSP1872	301191618720 Suspension Ball Joint - Front Lower		517602R000
SSP2242	301191622420 Suspension Stabilizer Bar Link - Front	L=243.5mm	548302H000; 548302H100
SSP2243	301191622430 Suspension Stabilizer Bar Link - Front	(Clip-on patented design) L=243.5mm	548302H000*



KIA CEED II



05/2012-

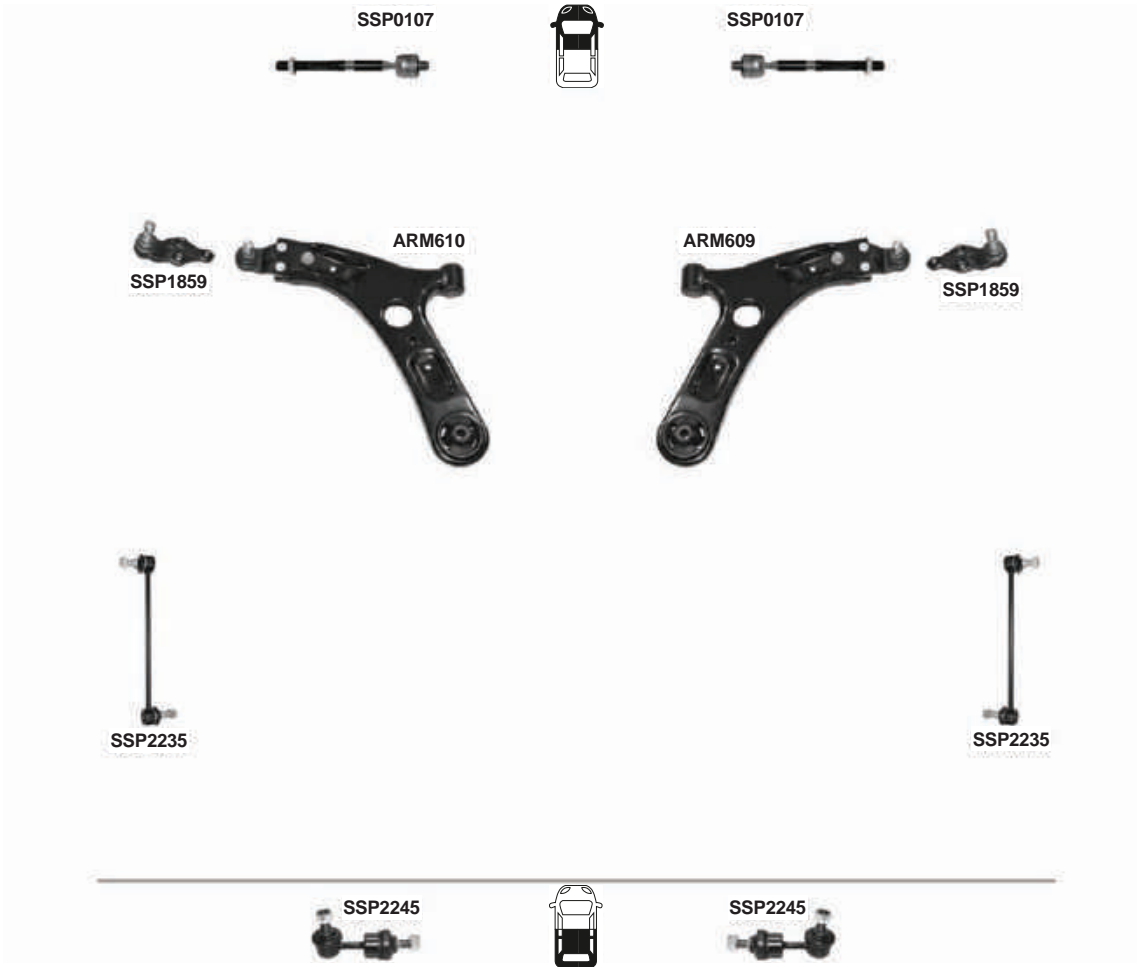

PART NO.	DESCRIPTION	NOTES	O.E.
ARM609	301181360900 Suspension Control Arm and Ball Joint Assembly - Front Right Lower		54501A6200
ARM610	301181361000 Suspension Control Arm and Ball Joint Assembly - Front Left Lower		54500A6200
ARM618	301181361800 Lateral Arm - Rear		55100A6005
ARM642	301181364200 Suspension Control Arm and Ball Joint Assembly - Front Right Lower		54501A2600
ARM643	301181364300 Suspension Control Arm and Ball Joint Assembly - Front Left Lower		54500A2600
SSP0107	301191601070 Steering Tie Rod - Front	M16X1,5 - L=218mm	56540A6000
SSP1859	301191618590 Suspension Ball Joint - Front		545303S100
SSP2235	301191622350 Suspension Stabilizer Bar Link - Front	L=282mm	548300U000; 548304L000
SSP2245	301191622450 Suspension Stabilizer Bar Link - Rear	L=88mm	555303R000; 555403R000
SSP2285	301191622850 Suspension Stabilizer Bar Link - Front		548304L000



KIA CERATO (LD)



03/2004-07/2011



SSP0443



SSP0443



SSP1854



SSP1854

PART NO.	DESCRIPTION	NOTES	O.E.
SSP0443 301191604430	Steering Tie Rod End - Front	M14x1,5Rht	5682025000
SSP1854 301191618540	Suspension Ball Joint - Front		5450322000; 5453025000; 5450322A00; 5450331600



KIA Forte 1st Gen



2010-2013

SSP0453



SSP0106



SSP0106



SSP0452



SSP1858



SSP1858

SSP2242



SSP2242



PART NO.	DESCRIPTION	NOTES	O.E.
SSP0106 301191601060	Steering Tie Rod - Front	M14x1,5 - L=156.5mm	565402H000
SSP0452 301191604520	Steering Tie Rod End - Front Right	M14x1,5	568202H090
SSP0453 301191604530	Steering Tie Rod End - Front Left	M14x1,5	568202H000
SSP1858 301191618580	Suspension Ball Joint - Front		517602G000
SSP2242 301191622420	Suspension Stabilizer Bar Link - Front	L=243.5mm	548302H000; 548302H100



KIA Forte Coup 1st Gen



2010-2013

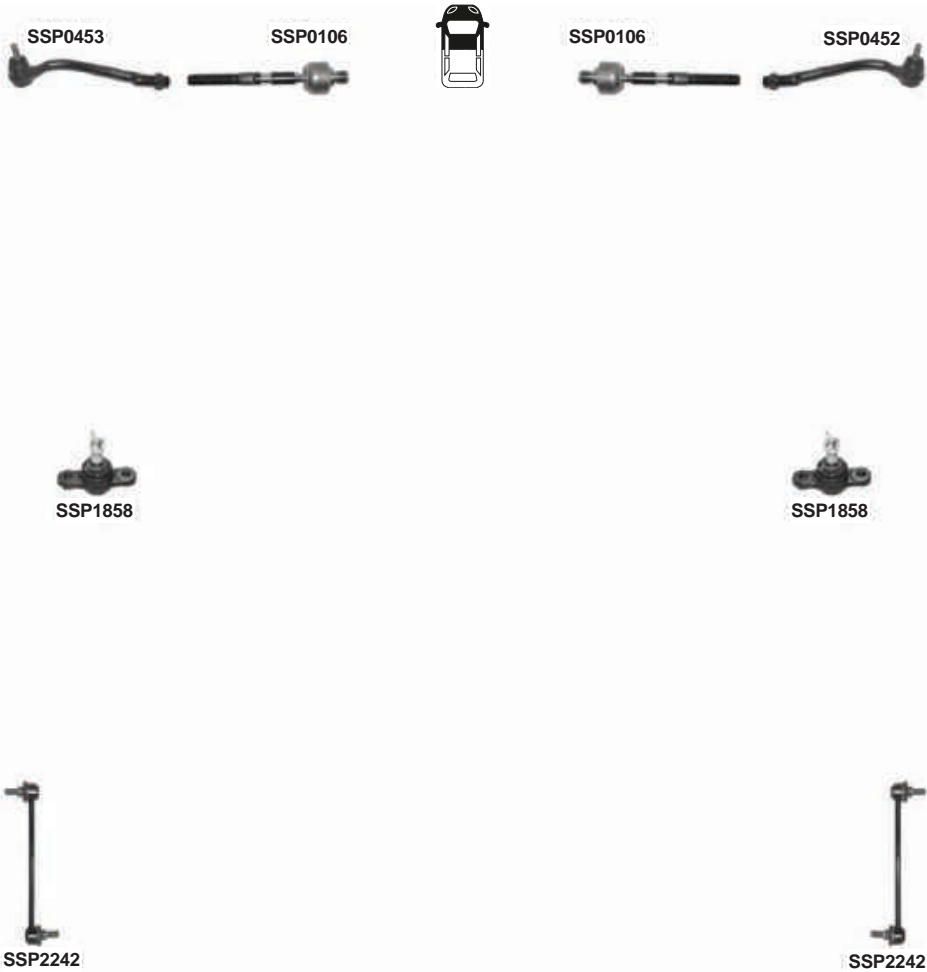

PART NO.	DESCRIPTION	NOTES	O.E.
SSP0106 301191601060	Steering Tie Rod - Front	M14x1,5 - L=156.5mm	565402H000
SSP0452 301191604520	Steering Tie Rod End - Front Right	M14x1,5	568202H090
SSP0453 301191604530	Steering Tie Rod End - Front Left	M14x1,5	568202H000
SSP1858 301191618580	Suspension Ball Joint - Front		517602G000
SSP2242 301191622420	Suspension Stabilizer Bar Link - Front	L=243.5mm	548302H000; 548302H100



KIA Forte5 1st Gen



2010-2013

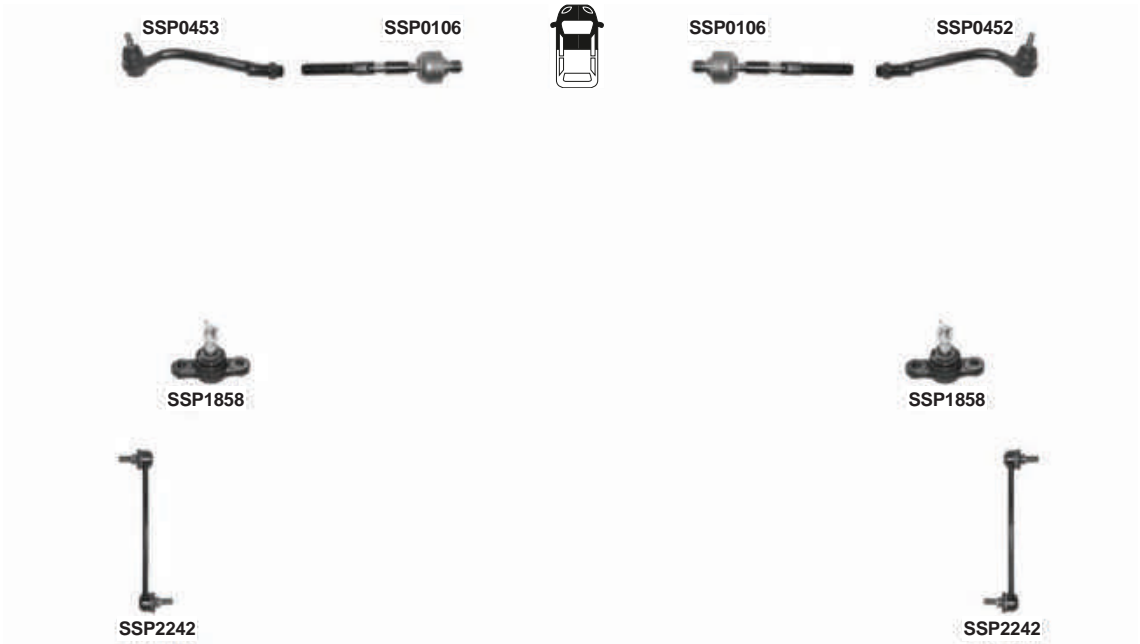

PART NO.	DESCRIPTION	NOTES	O.E.
SSP0106 301191601060	Steering Tie Rod - Front	M14x1,5 - L=156.5mm	565402H000
SSP0452 301191604520	Steering Tie Rod End - Front Right	M14x1,5	568202H090
SSP0453 301191604530	Steering Tie Rod End - Front Left	M14x1,5	568202H000
SSP1858 301191618580	Suspension Ball Joint - Front		517602G000
SSP2242 301191622420	Suspension Stabilizer Bar Link - Front	L=243.5mm	548302H000; 548302H100



KIA OPTIMA 3rd Gen

 01/2010-



SSP1859



SSP1859



SSP2245



SSP2245

PART NO.	DESCRIPTION	NOTES	O.E.
SSP0457 301191604570	Steering Tie Rod End - Front Right Outer		568203V100
SSP0458 301191604580	Steering Tie Rod End - Front Left Outer		568203V190
SSP1859 301191618590	Suspension Ball Joint - Front		545303S100
SSP2245 301191622450	Suspension Stabilizer Bar Link - Rear	L=88mm	555303R000; 555403R000



KIA PICANTO BA



05/2004-04/2011

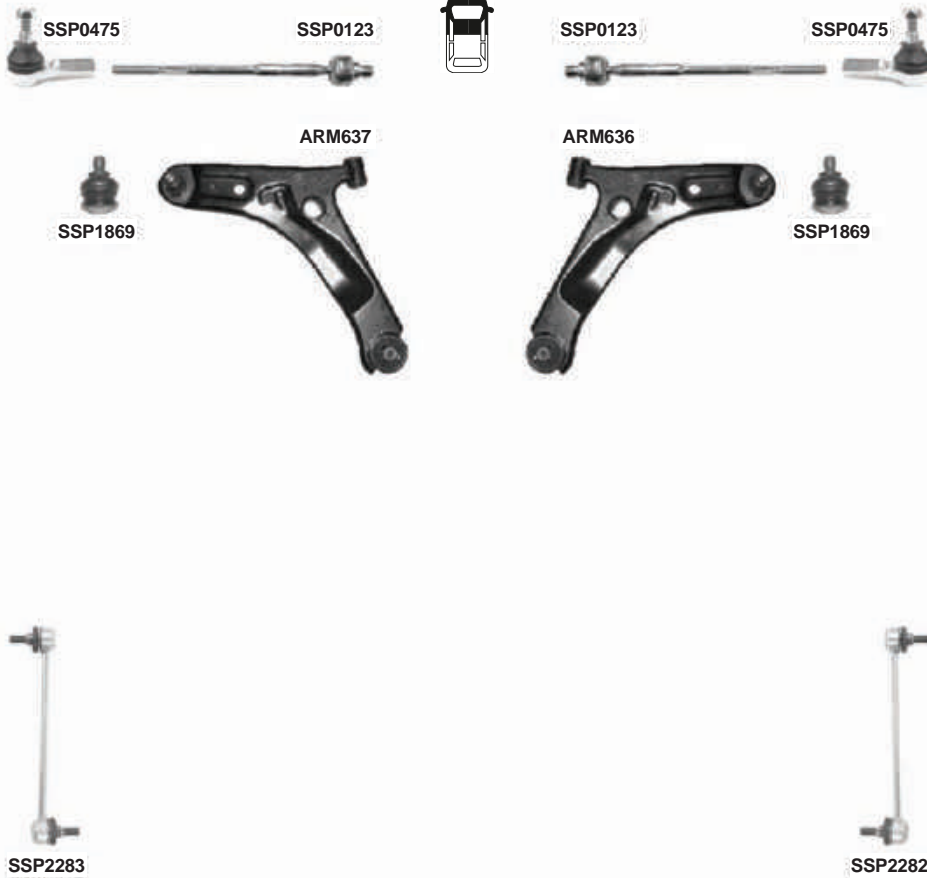

	PART NO.	DESCRIPTION	NOTES	O.E.
ARM636	301181363600	Suspension Control Arm and Ball Joint Assembly - Front Right Lower		5450107100
ARM637	301181363700	Suspension Control Arm and Ball Joint Assembly - Front Left Lower		5450007100
SSP0123	301191601230	Steering Tie Rod - Front	M12x1,25 - L=243mm	5772407100
SSP0475	301191604750	Steering Tie Rod End - Front	M12x1,25	5682007200
SSP1869	301191618690	Suspension Ball Joint - Front Lower		5435007000; 5453007000
SSP2282	301191622820	Suspension Stabilizer Bar Link - Front Right	L=225mm	5484007000
SSP2283	301191622830	Suspension Stabilizer Bar Link - Front Left	L=225mm	5483007000



KIA PICANTO TA



05/2011-

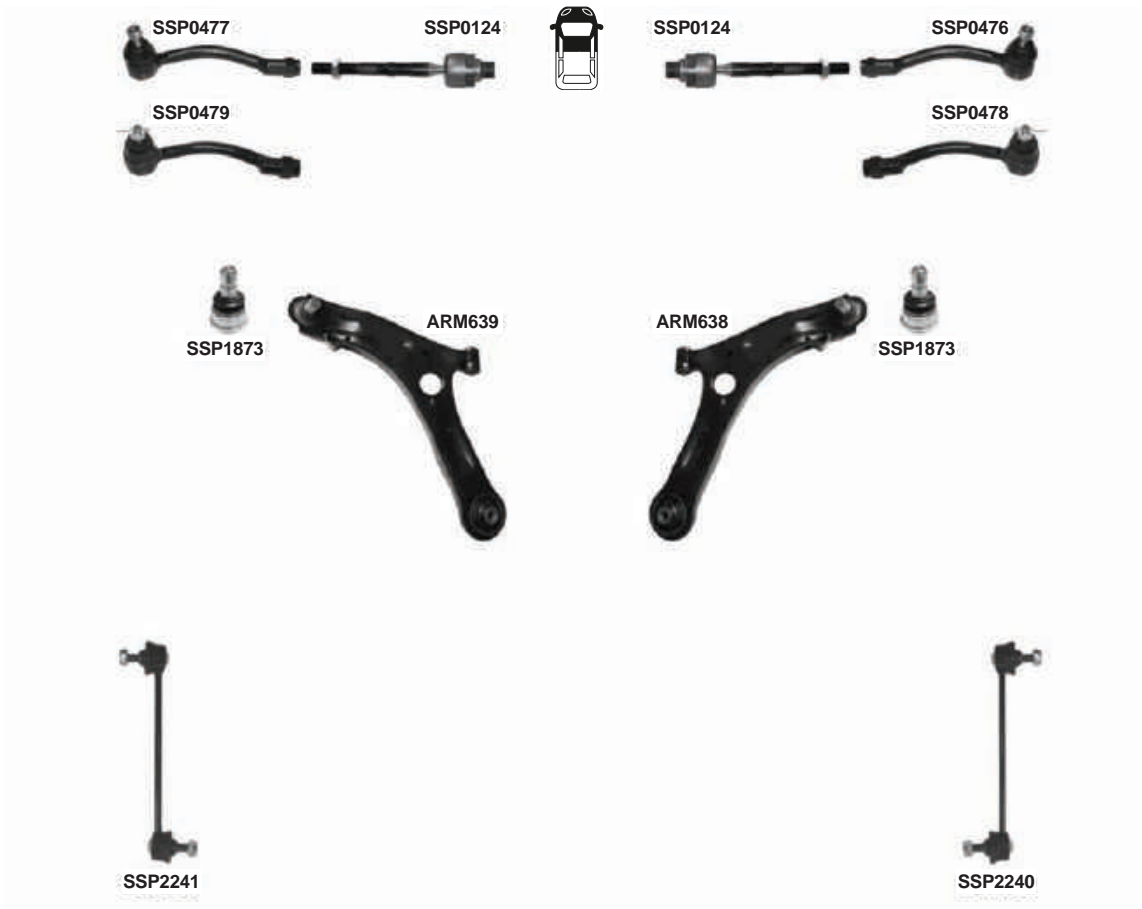

PART NO.	DESCRIPTION	NOTES	O.E.
ARM638	Suspension Control Arm and Ball Joint Assembly - Front Right Lower		545011Y000
ARM639	Suspension Control Arm and Ball Joint Assembly - Front Left Lower		545001Y000
SSP0124	Steering Tie Rod - Front	M14x1.5 - L=183mm	577241Y500
SSP0476	Steering Tie Rod End - Front Right	M14x1.5	568201Y550
SSP0477	Steering Tie Rod End - Front Left	M14x1.5	568201Y500
SSP0478	Steering Tie Rod End - Front Right	M14x1.5	568201Y551
SSP0479	Steering Tie Rod End - Front Left	M14x1.5	568201Y501
SSP1873	Suspension Ball Joint - Front Lower		545302K000
SSP2240	Suspension Stabilizer Bar Link - Front Right	L=216mm	548401J000
SSP2241	Suspension Stabilizer Bar Link - Front Left	L=216mm	548301J000



KIA RIO DC



09/2000-02/2005



SSP2281



ARM635



SSP2280



SSP2279



SSP2278

PART NO.	DESCRIPTION	NOTES	O.E.
ARM635	Suspension Control Arm and Ball Joint Assembly - Front Right Lower		OK30B34300B
SSP0120	Steering Tie Rod - Front	M12x1,25 - L=279mm	KDX5332240
SSP0472	Steering Tie Rod End - Front	M12x1,25	5682007000; 5682007200; MDX5032280
SSP2278	Suspension Stabilizer Bar Link - Front Right	L=240mm	0K033C3415A; OK33C34150A
SSP2279	Suspension Stabilizer Bar Link - Front Left	L=240mm	0K33C34160A; OK33C34160A
SSP2280	Suspension Stabilizer Bar Link - Front Right	L=219 mm	54830FD000
SSP2281	Suspension Stabilizer Bar Link - Front Left	L=219 mm	54820FD000



KIA RIO JB



03/2005-08/2011

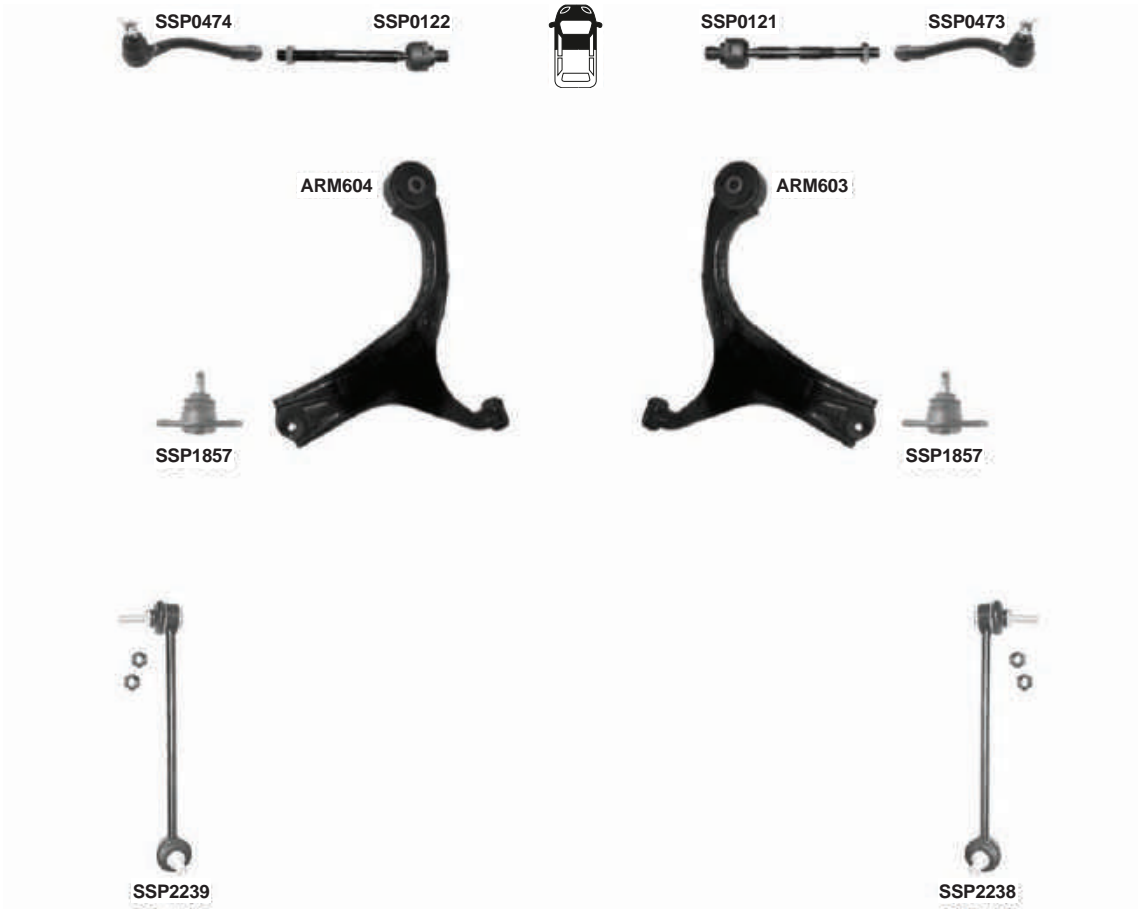

PART NO.	DESCRIPTION	NOTES	O.E.
ARM603	Suspension Control Arm - Front Right Lower		54501-1E100
ARM604	Suspension Control Arm - Front Left Lower		5,45E+105
SSP0121	Steering Tie Rod - Right	M14x1,5 - L=185mm	577241G100
SSP0122	Steering Tie Rod - Left	M14x1.5 - L=185mm	577241G000
SSP0473	Steering Tie Rod End - Front Right	M14x1,5	568201G000
SSP0474	Steering Tie Rod End - Front Left	M14x1,5	568201G900
SSP1857	Suspension Ball Joint - Front		517601G000
SSP2238	Suspension Stabilizer Bar Link - Front Right	L=285mm	548401; 548401G500; 548402C000
SSP2239	Suspension Stabilizer Bar Link - Front Left	L=285mm	548301G000; 548301G500; 548302C000



KIA RIO5 JB



03/2005-08/2011

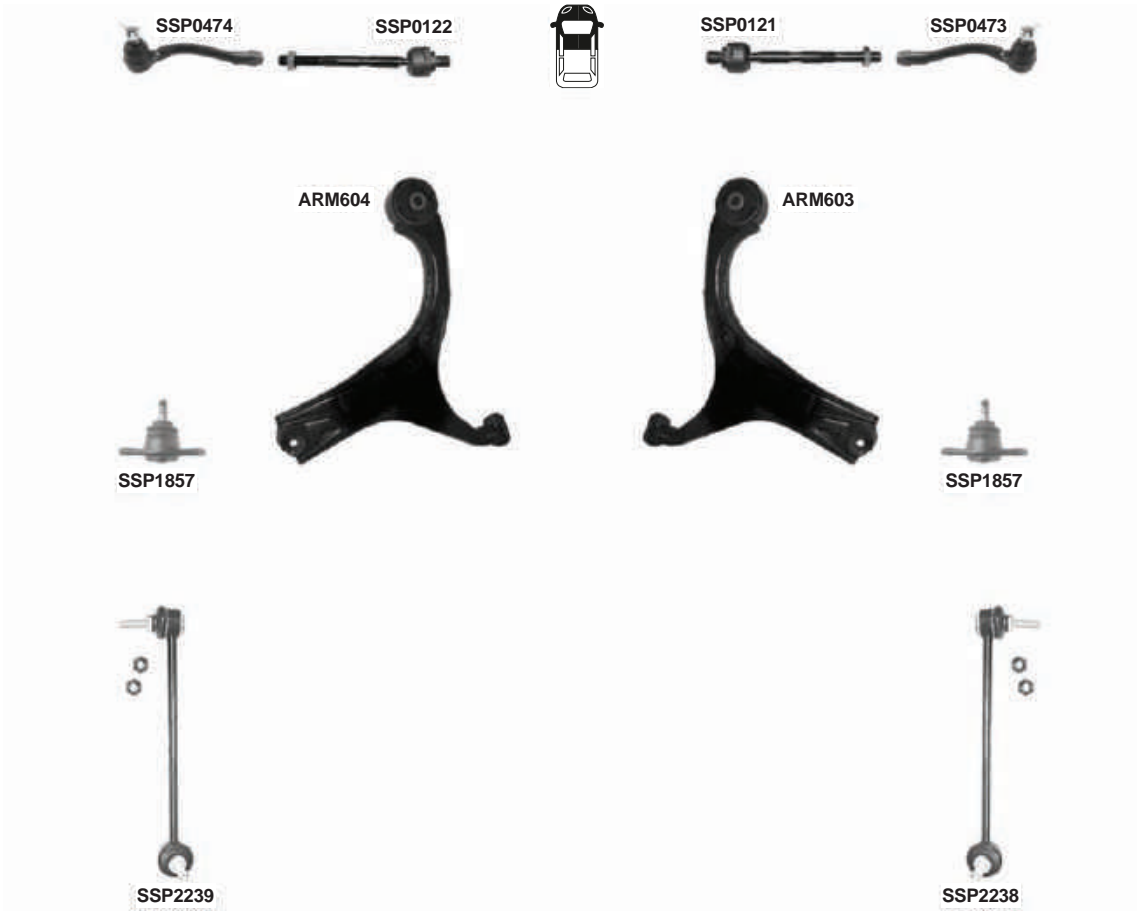

PART NO.	DESCRIPTION	NOTES	O.E.
ARM603	301181360300 Suspension Control Arm - Front Right Lower		54501-1E100
ARM604	301181360400 Suspension Control Arm - Front Left Lower		5,45E+105
SSP0121	301191601210 Steering Tie Rod - Right	M14x1,5 - L=185mm	577241G100
SSP0122	301191601220 Steering Tie Rod - Left	M14x1.5 - L=185mm	577241G000
SSP0473	301191604730 Steering Tie Rod End - Front Right	M14x1,5	568201G000
SSP0474	301191604740 Steering Tie Rod End - Front Left	M14x1,5	568201G900
SSP1857	301191618570 Suspension Ball Joint - Front		517601G000
SSP2238	301191622380 Suspension Stabilizer Bar Link - Front Right	L=285mm	548401; 548401G500; 548402C000
SSP2239	301191622390 Suspension Stabilizer Bar Link - Front Left	L=285mm	548301G000; 548301G500; 548302C000



KIA RIO UB



09/2011-

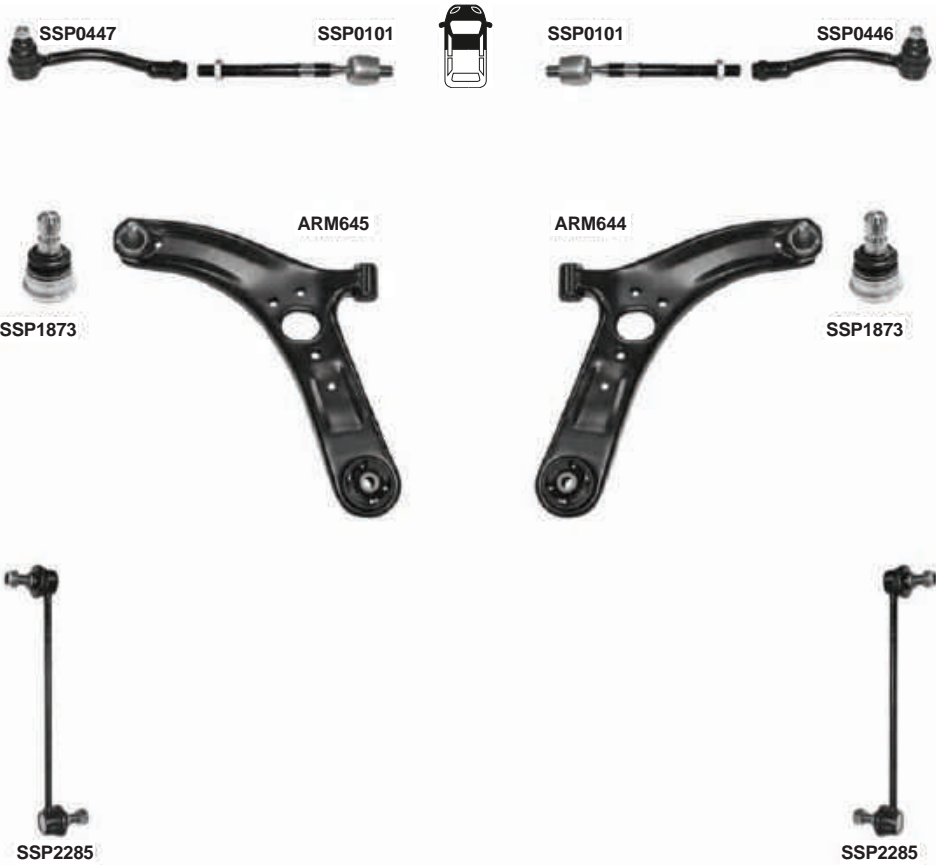

PART NO.	DESCRIPTION	NOTES	O.E.
ARM644	301181364400 Suspension Control Arm and Ball Joint Assembly - Front Right Lower		545011W000
ARM645	301181364500 Suspension Control Arm and Ball Joint Assembly - Front Left Lower		545001W000
SSP0101	301191601010 Steering Tie Rod - Front	M16X1,5 - L=218mm	565400U500; 545400U500
SSP0446	301191604460 Steering Tie Rod End - Front Right	M16X1,5	568200U590; 568201W090
SSP0447	301191604470 Steering Tie Rod End - Front Left	M16X1,5	568200U500; 568201W000
SSP1873	301191618730 Suspension Ball Joint - Front Lower		545302K000
SSP2285	301191622850 Suspension Stabilizer Bar Link - Front	L=282mm	548304L000



KIA SEDONA III



06/2006-2014



SSP1855



SSP1855

PART NO.	DESCRIPTION	NOTES	O.E.
SSP1855 301191618550	Suspension Ball Joint - Front Lower	D=Ø20mm	545303J000

KIA SORENTO JC, BL



08/2002-10/2009

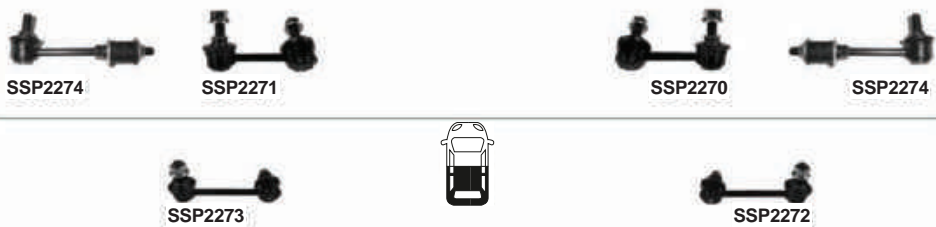
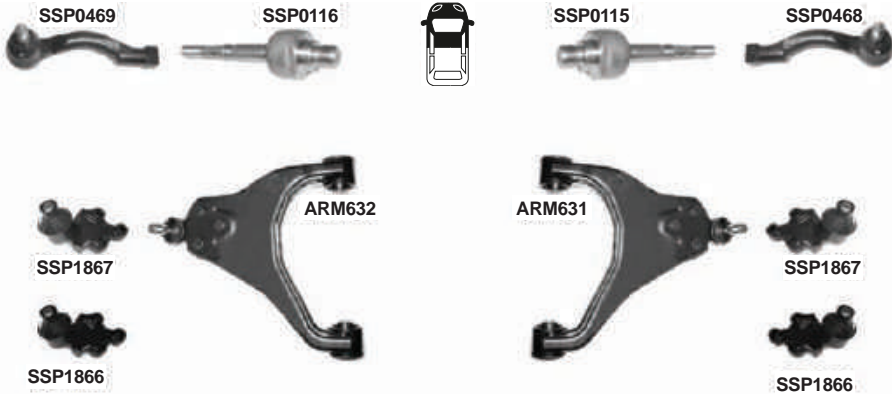

PART NO.	DESCRIPTION	NOTES	O.E.
ARM631	301181363100 Suspension Control Arm and Ball Joint Assembly - Front Right Lower	Ball Joint D=Ø14mm	54520-3E000; 5452030
ARM632	301181363200 Suspension Control Arm and Ball Joint Assembly - Front Left Lower	Ball Joint D=Ø14mm	54510-3E000; 5451030
SSP0115	301191601150 Steering Tie Rod - Right	M14x1,5 L=172mm	57731-3E010
SSP0116	301191601160 Steering Tie Rod - Left	M14x1,5 L=172mm	57732-3E010
SSP0468	301191604680 Steering Tie Rod End - Front Right	M14x1,5Rht	568203E900
SSP0469	301191604690 Steering Tie Rod End - Front Left	M14x1,5Rht	56820-3E000
SSP1866	301191618660 Suspension Ball Joint - Front Lower	(4WD) D=Ø12mm	545703; 5457030
SSP1867	301191618670 Suspension Ball Joint - Front	D=Ø14mm	545203E000 Part of
SSP2270	301191622700 Suspension Stabilizer Bar Link - Front Right	L=85mm	54811-3E060
SSP2271	301191622710 Suspension Stabilizer Bar Link - Front Left	L=80mm	54811-3E010
SSP2272	301191622720 Suspension Stabilizer Bar Link - Rear Left	L=120mm	55580-3E000
SSP2273	301191622730 Suspension Stabilizer Bar Link - Rear Right	L=120mm	55580-3E050
SSP2274	301191622740 Suspension Stabilizer Bar Link - Front	L=149.5mm	54810-3E000



KIA SORENTO XM



2009-2014

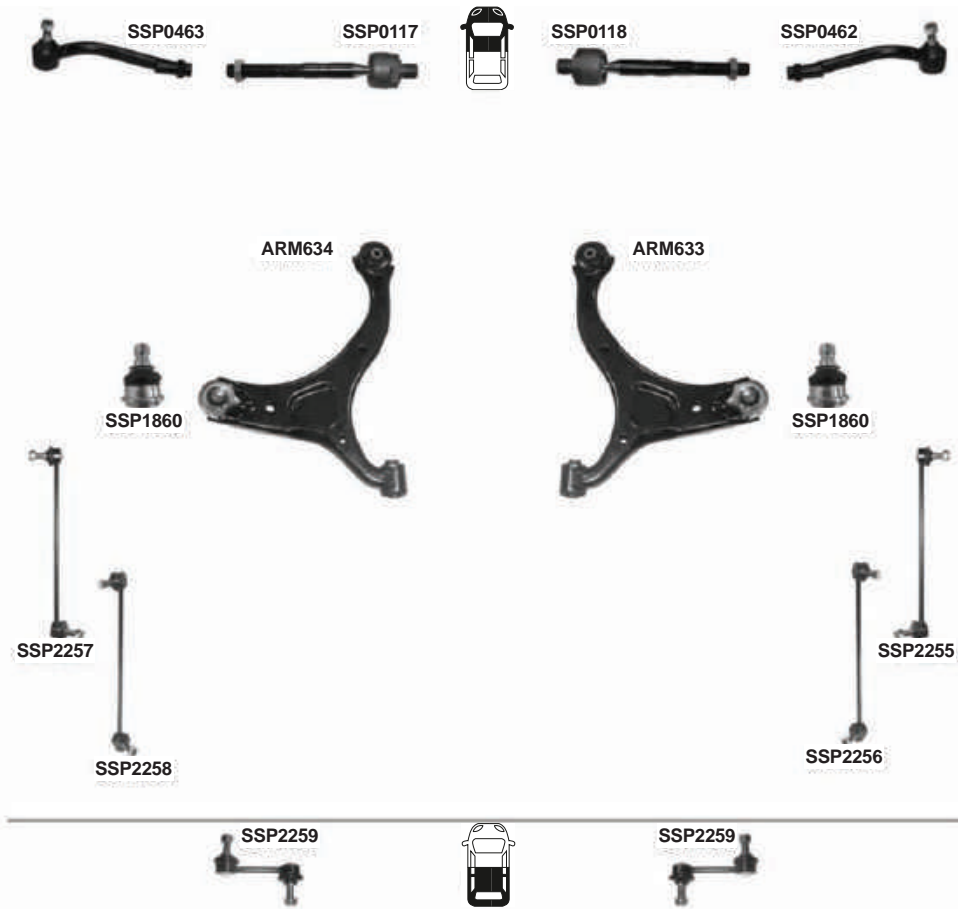

PART NO.	DESCRIPTION	NOTES	O.E.
ARM633	301181363300 Suspension Control Arm and Ball Joint Assembly - Front Right Lower		545012P000
ARM634	301181363400 Suspension Control Arm and Ball Joint Assembly - Front Left Lower		545002P000
SSP0117	301191601170 Steering Tie Rod - Left	M16x1.5 - L=187mm	577242P100
SSP0118	301191601180 Steering Tie Rod - Right	M16x1.5 - L=187mm	577242P000
SSP0462	301191604620 Steering Tie Rod End - Front Right	M16x1,5	568202B900; 568202P900
SSP0463	301191604630 Steering Tie Rod End - Front Left	M16x1,5	568202B000; 568202P000
SSP1860	301191618600 Suspension Ball Joint - Front Lower		545033BA00; 545303B000
SSP2255	301191622550 Suspension Stabilizer Bar Link - Front Right	L=341mm	548402B000; 548402B200
SSP2256	301191622560 Suspension Stabilizer Bar Link - Front Right	(Clip-on patented design) L=341mm	548402B000*
SSP2257	301191622570 Suspension Stabilizer Bar Link - Front Left	L=341mm	548302B000; 548302B200
SSP2258	301191622580 Suspension Stabilizer Bar Link - Front Left	(Clip-on patented design) L=341mm	548302B000*
SSP2259	301191622590 Suspension Stabilizer Bar Link - Rear	L=99,5mm	555302B000; 555302B200



KIA SORENTO UM, III



2015-

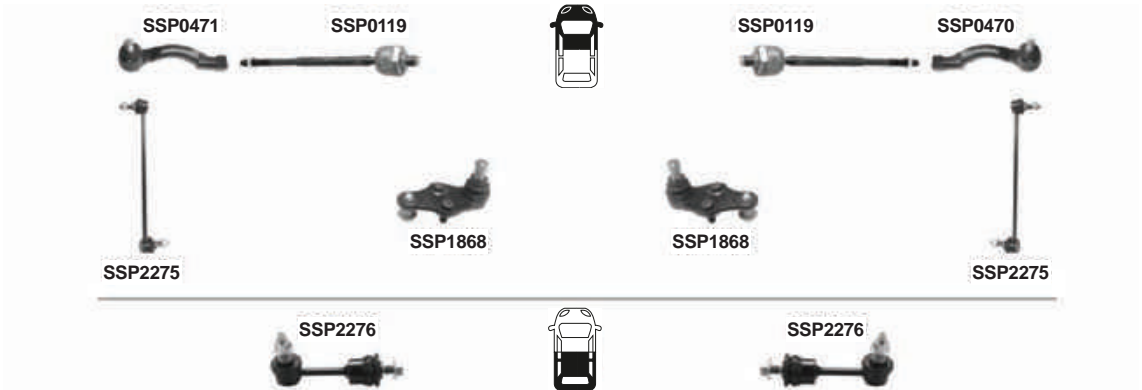

PART NO.	DESCRIPTION	NOTES	O.E.
SSP0119 301191601190	Steering Tie Rod - Front		57724C5000
SSP0470 301191604700	Steering Tie Rod End - Front Right		56825C1090
SSP0471 301191604710	Steering Tie Rod End - Front Left		56820C1000
SSP1868 301191618680	Suspension Ball Joint - Front Lower		54530C5100
SSP2275 301191622750	Suspension Stabilizer Bar Link - Front	L=350mm / M12x1.25	54830C5000
SSP2276 301191622760	Suspension Stabilizer Bar Link - Rear	A = 116 mm	55530C5000; 55540C5000



KIA SOUL AM



02/2009-2014

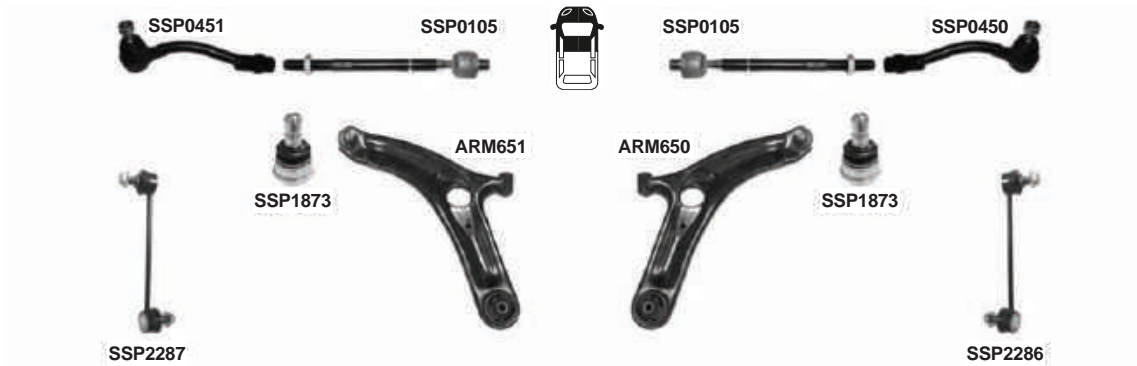

	PART NO.	DESCRIPTION	NOTES	O.E.
ARM648	301181364800	Suspension Control Arm and Ball Joint Assembly - Front Right Lower		545012K600
ARM649	301181364900	Suspension Control Arm and Ball Joint Assembly - Front Left Lower		545002K600
ARM650	301181365000	Suspension Control Arm and Ball Joint Assembly - Front Right Lower	6speed auto transmission	545012K200; 545012K500
ARM651	301181365100	Suspension Control Arm and Ball Joint Assembly - Front Left Lower	6speed auto transmission	545002K200; 545002K500
SSP0105	301191601050	Steering Tie Rod - Front	M16X1,5 - L=249mm	565402K000; 565403J000*
SSP0450	301191604500	Steering Tie Rod End - Front Right	M16x1,5	568202K050
SSP0451	301191604510	Steering Tie Rod End - Front Left	M16x1,5	568202K000
SSP1873	301191618730	Suspension Ball Joint - Front Lower		545302K000
SSP2286	301191622860	Suspension Stabilizer Bar Link - Front Right	L=216mm	548402K000
SSP2287	301191622870	Suspension Stabilizer Bar Link - Front Left	L=216mm	548302K000



KIA SPECTRA 1st Gen, LD



2004-2009

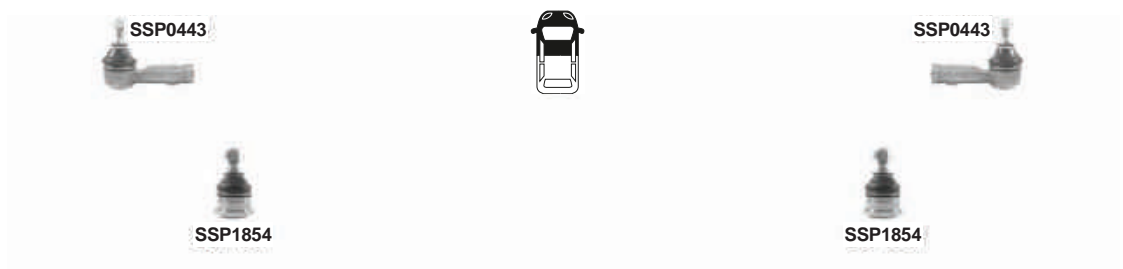

PART NO.	DESCRIPTION	NOTES	O.E.
SSP0443 301191604430	Steering Tie Rod End - Front	M14x1,5Rht	5682025000
SSP1854 301191618540	Suspension Ball Joint - Front		5450322000; 5453025000; 5450322A00; 5450331600



MAGNETI
MARELLI

KIA SPORTAGE NB7



1993-2004



PART NO.	DESCRIPTION	NOTES	O.E.
SSP2277 301191622770	Suspension Stabilizer Bar Link - Front		K01134160A



KIA SPORTAGE JE



09/2004-06/2010

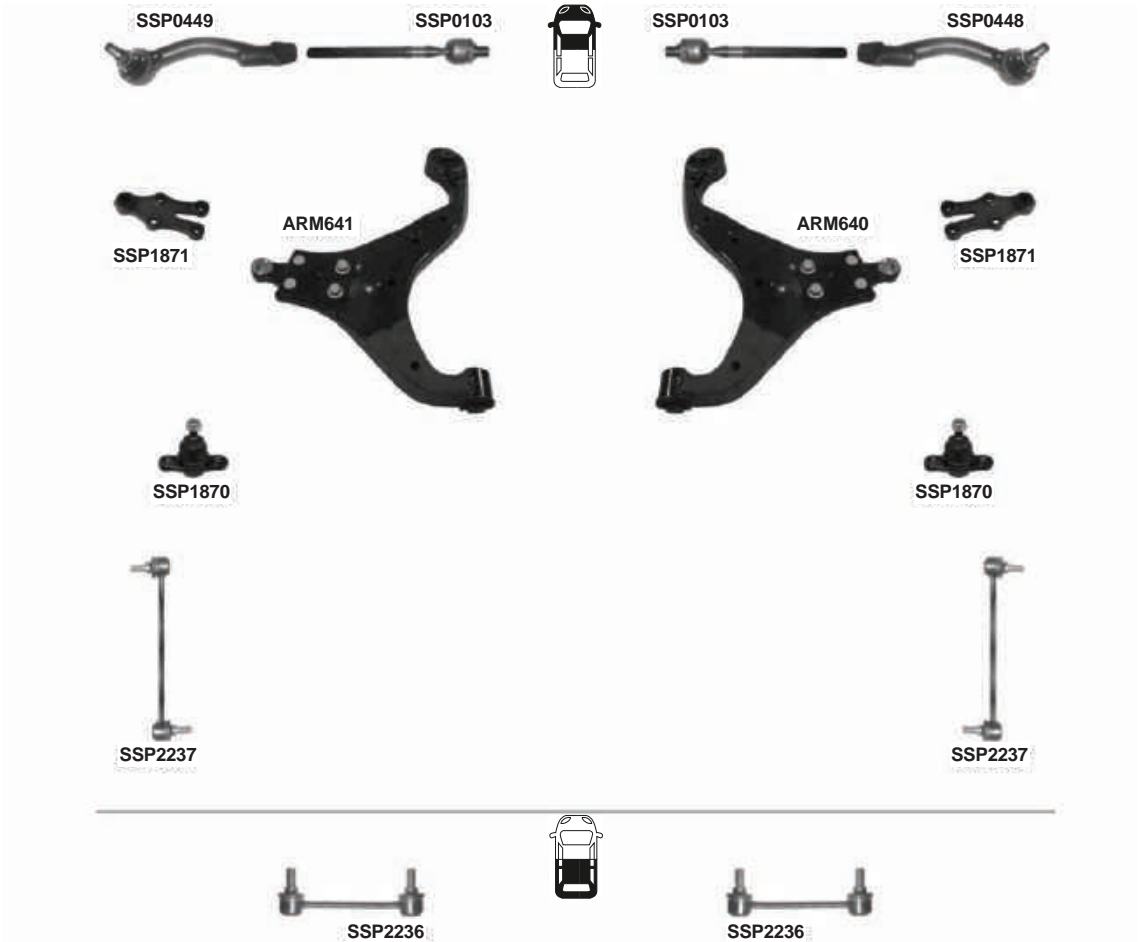

PART NO.	DESCRIPTION	NOTES	O.E.
ARM602 301181360200	Lateral Arm - Rear		55220-2E010
ARM640 301181364000	Suspension Control Arm and Ball Joint Assembly - Front Right Lower		545011F000; 5450120000000000; 5,45012E+35
ARM641 301181364100	Suspension Control Arm and Ball Joint Assembly - Front Left Lower		545001F000; 5450020000000000; 5,45002E+35
SSP0103 301191601030	Steering Tie Rod - Front	L=243.7mm - M16x1,5Rht.	57724-2E000
SSP0448 301191604480	Steering Tie Rod End - Front Right	M16x1,5Rht	568202E900
SSP0449 301191604490	Steering Tie Rod End - Front Left	M16x1,5Rht	56820-2E000
SSP1870 301191618700	Suspension Ball Joint - Front		51760-2E000; 51770-2E010; 51760- 2E010; 51770-2E000
SSP1871 301191618710	Suspension Ball Joint - Front Lower		545012E030 / 545002E030 Part of
SSP2236 301191622360	Suspension Stabilizer Bar Link - Rear	L=219mm	55530-2E000
SSP2237 301191622370	Suspension Stabilizer Bar Link - Front	L=238mm	54830-2E000



KIA SPORTAGE SL



07/2010-08/2015

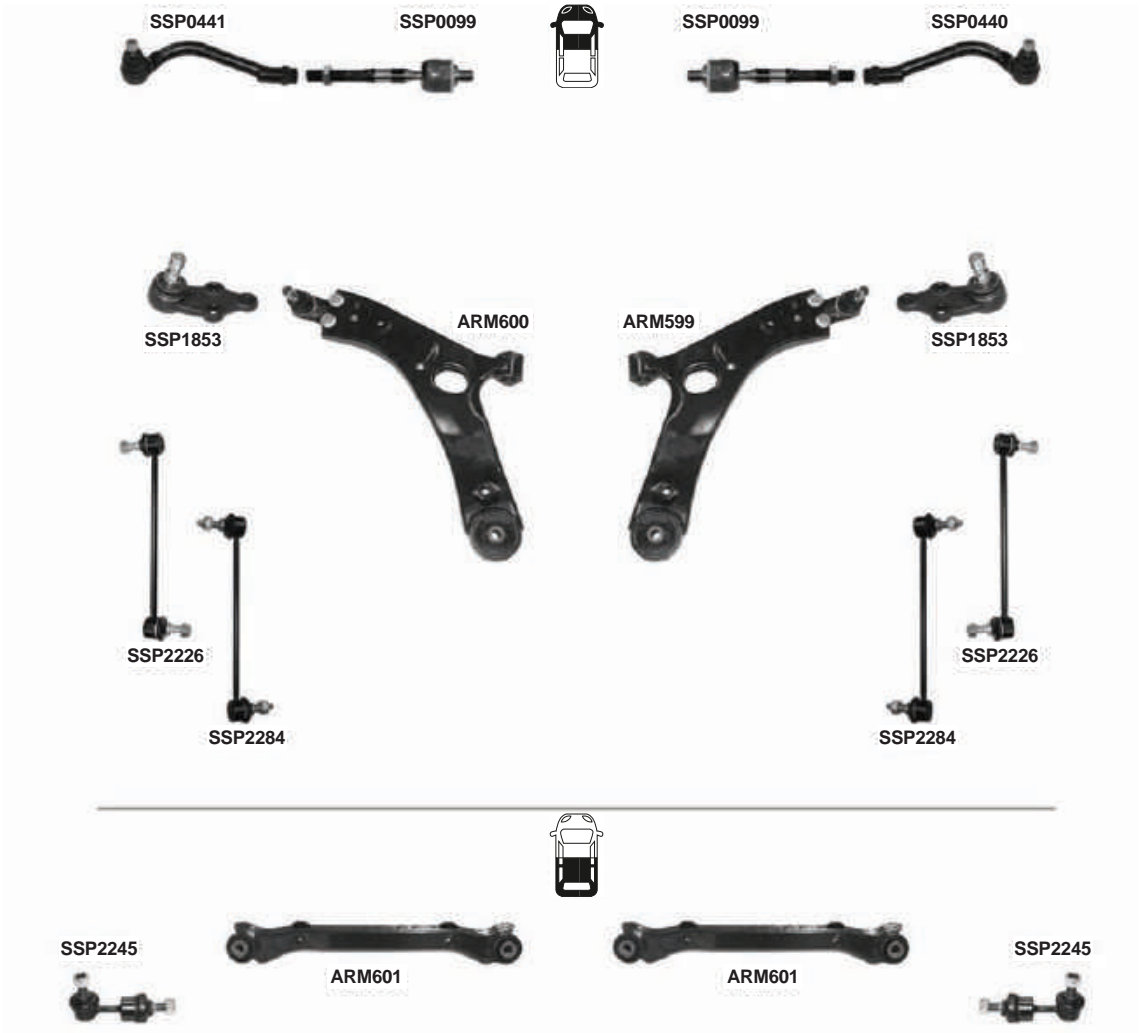

	PART NO.	DESCRIPTION	NOTES	O.E.
ARM599	301181359900	Suspension Control Arm and Ball Joint Assembly - Front Right Lower		545012Y000; 545012Y002
ARM600	301181360000	Suspension Control Arm and Ball Joint Assembly - Front Left Lower		545002Y000; 545002Y002
ARM601	301181360100	Lateral Arm - Rear Upper		551002S000; 551002S050
SSP0099	301191600990	Steering Tie Rod - Front	M16X1,5 - L=183mm	577242S000; 577242S100
SSP0440	301191604400	Steering Tie Rod End - Front Right	M16X1,5	568202S050; 568203Q500
SSP0441	301191604410	Steering Tie Rod End - Front Left	M16X1,5	568202S000; 568203Q000
SSP1853	301191618530	Suspension Ball Joint - Front Lower		545303S000
SSP2226	301191622260	Suspension Stabilizer Bar Link - Front	L=267mm	548302S200
SSP2245	301191622450	Suspension Stabilizer Bar Link - Rear	L=88mm	555303R000; 555403R000
SSP2284	301191622840	Suspension Stabilizer Bar Link - Front	(2.0 GDI 4W4 L=267mm	543803U000; 548303U000



KIA VENGA AM



02/2010-

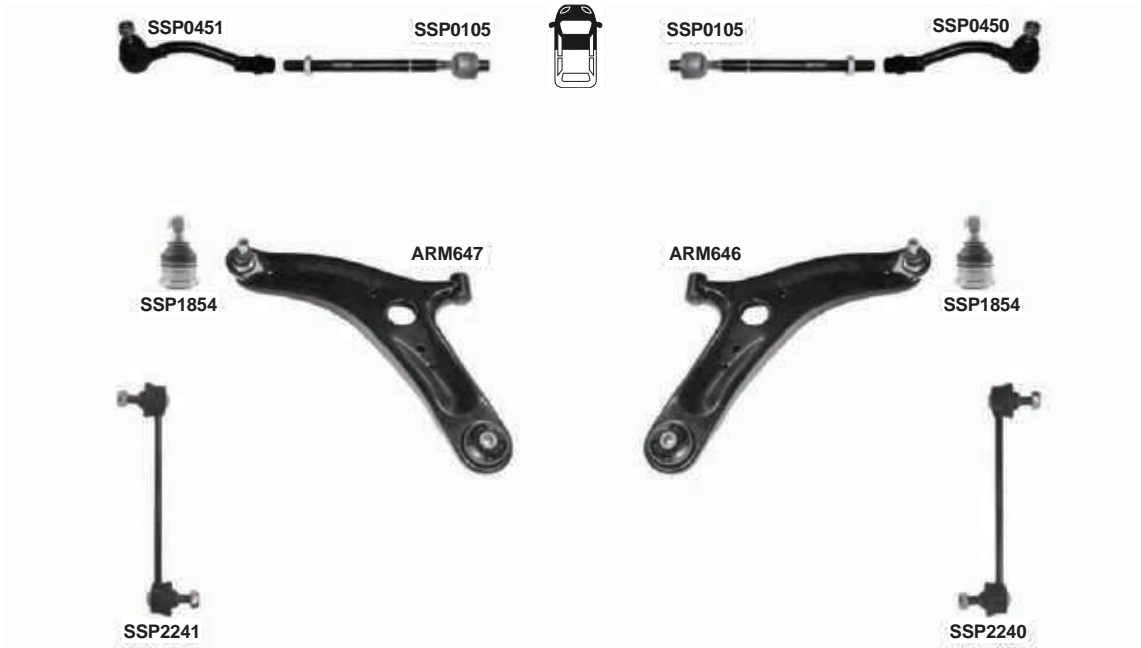

PART NO.	DESCRIPTION	NOTES	O.E.
ARM646	301181364600 Suspension Control Arm and Ball Joint Assembly - Front Right Lower		545011P100
ARM647	301181364700 Suspension Control Arm and Ball Joint Assembly - Front Left Lower		545001P100
SSP0105	301191601050 Steering Tie Rod - Front	M16X1,5 - L=249mm	565402K000; 565403J000*
SSP0450	301191604500 Steering Tie Rod End - Front Right	M16x1,5	568202K050
SSP0451	301191604510 Steering Tie Rod End - Front Left	M16x1,5	568202K000
SSP1854	301191618540 Suspension Ball Joint - Front		5450322000; 5453025000; 5450322A00; 5450331600
SSP2240	301191622400 Suspension Stabilizer Bar Link - Front Right	L=216mm	548401J000
SSP2241	301191622410 Suspension Stabilizer Bar Link - Front Left	L=216mm	548301J000



LANCIA DEDRA 835



1989-1999

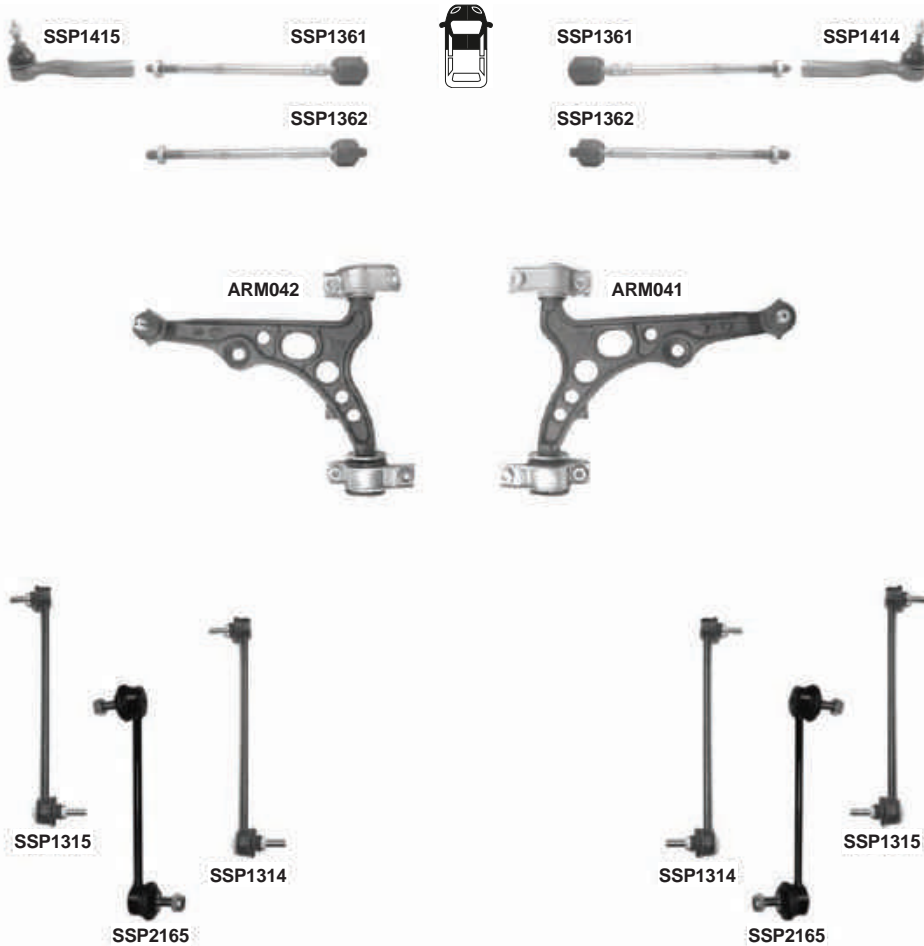

	PART NO.	DESCRIPTION	NOTES	O.E.
ARM041	301181304100	Suspension Control Arm and Ball Joint Assembly - Front Right Lower	D= Ø17mm	46423823; 82461082
ARM042	301181304200	Suspension Control Arm and Ball Joint Assembly - Front Left	D= Ø17mm	46423822; 82461081
SSP1314	301181313140	Suspension Stabilizer Bar Link - Front	M10x1,25Rht - L=114mm	12574521; 7601643; 7601642; 60570627
SSP1315	301181313150	Suspension Stabilizer Bar Link - Front	L=274,5mm	46413122; 51701045
SSP1361	301181313610	Steering Tie Rod - Front Inner	Manual Steering M12x1,5 - L=276.8mm	5958244; SE022162449S; 7633721
SSP1362	301181313620	Steering Tie Rod - Front Inner	Power Steering M12x1,5 L=277mm	9941625
SSP1414	301181314140	Steering Tie Rod End - Front Right	M12x1,5Rht	60806355; 9947438; 9947436
SSP1415	301181314150	Steering Tie Rod End - Front Left	M12x1,5Rht	60806356; 9947439; 9947438
SSP2165	301191621650	Suspension Stabilizer Bar Link - Front	(Clip-on patented design) L=274,5mm	46413122*



LANCIA DELTA II



1993-2000

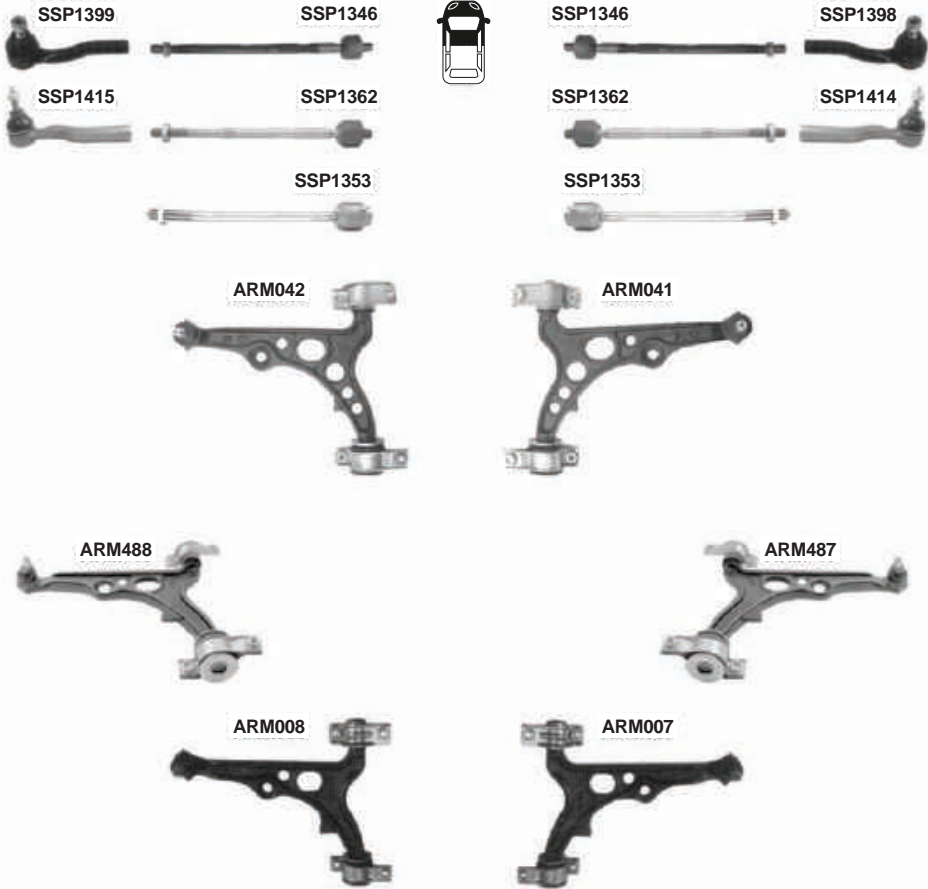



LANCIA DELTA II



1993-2000

	PART NO.	DESCRIPTION	NOTES	O.E.
ARM007	301181300700	Suspension Control Arm and Ball Joint Assembly - Front Right	D=Ø17mm	46456050; 60809814; 60586772
ARM008	301181300800	Suspension Control Arm and Ball Joint Assembly - Front Left Lower	D=Ø17mm	46456049; 60809813; 60586771
ARM041	301181304100	Suspension Control Arm and Ball Joint Assembly - Front Right Lower	D= Ø17mm	46423823; 82461082
ARM042	301181304200	Suspension Control Arm and Ball Joint Assembly - Front Left	D= Ø17mm	46423822; 82461081
ARM487	301181348700	Suspension Control Arm and Ball Joint Assembly - Front Right Lower	Forging D=Ø17mm	60813014; 60813044
ARM488	301181348800	Suspension Control Arm and Ball Joint Assembly - Front Left	Forging D=Ø17mm	60813013; 60813043
SSP1346	301181313460	Steering Tie Rod - Front Inner	Power Steering M12x1,5 Rht - L=285mm	9944452
SSP1353	301181313530	Steering Tie Rod - Front	Power Steering M12x1,5Rht L=285mm	59588244
SSP1362	301181313620	Steering Tie Rod - Front Inner	Power Steering M12x1,5 L=277mm	9941625
SSP1398	301181313980	Steering Tie Rod End - Front Right Outer	M12x1,5Rth	60565705; 7678717
SSP1399	301181313990	Steering Tie Rod End - Front Left Outer	M12x1,5Rth	60565706; 9947437; 7678718; 9947435
SSP1414	301181314140	Steering Tie Rod End - Front Right	M12x1,5Rht	60806355; 9947438; 9947436
SSP1415	301181314150	Steering Tie Rod End - Front Left	M12x1,5Rht	60806356; 9947439; 9947438



LANCIA DELTA III (844)



09/2008-

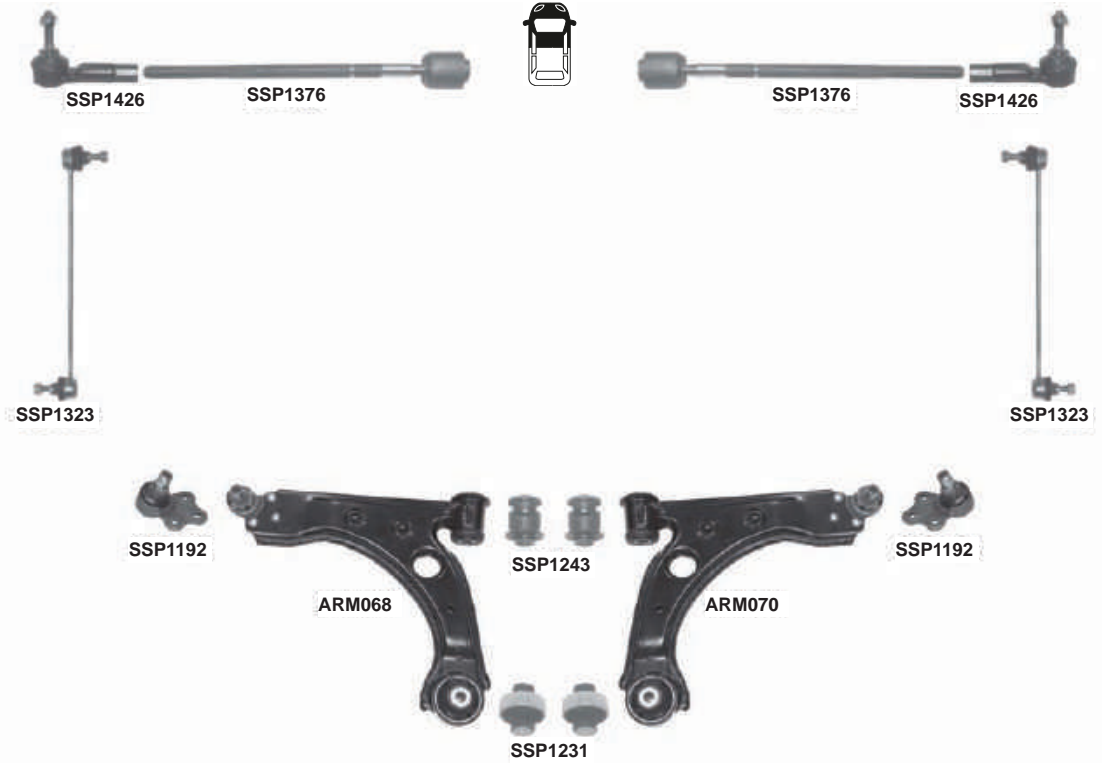

PART NO.	DESCRIPTION	NOTES	O.E.
ARM068	Suspension Control Arm and Ball Joint Assembly - Front Left Lower		50705464; 51827736
ARM070	Suspension Control Arm and Ball Joint Assembly - Front Right Lower		50705465; 51827737
SSP1192	Suspension Ball Joint - Front Lower		50706463
SSP1231	Bush / Silent block - Track control arm	ARM017 / ARM018 / ARM068 / ARM070 / ARM153 / ARM154	50700778
SSP1243	Bush / Silent block - Track control arm	ARM068 / ARM070 / ARM153 / ARM154	
SSP1323	Suspension Stabilizer Bar Link - Front	L=290mm	50700464; 51801136
SSP1376	Steering Tie Rod - Front	M14x1,5 - L=317mm	9949217
SSP1426	Steering Tie Rod End - Front	M14x1,5	9949218

**LANCIA KAPPA**

08/1994-10/2001



PART NO.	DESCRIPTION	NOTES	O.E.
SSP1319 301181313190	Suspension Stabilizer Bar Link - Front	L=100mm	46462049



LANCIA LYBRA



07/1999-10/2005

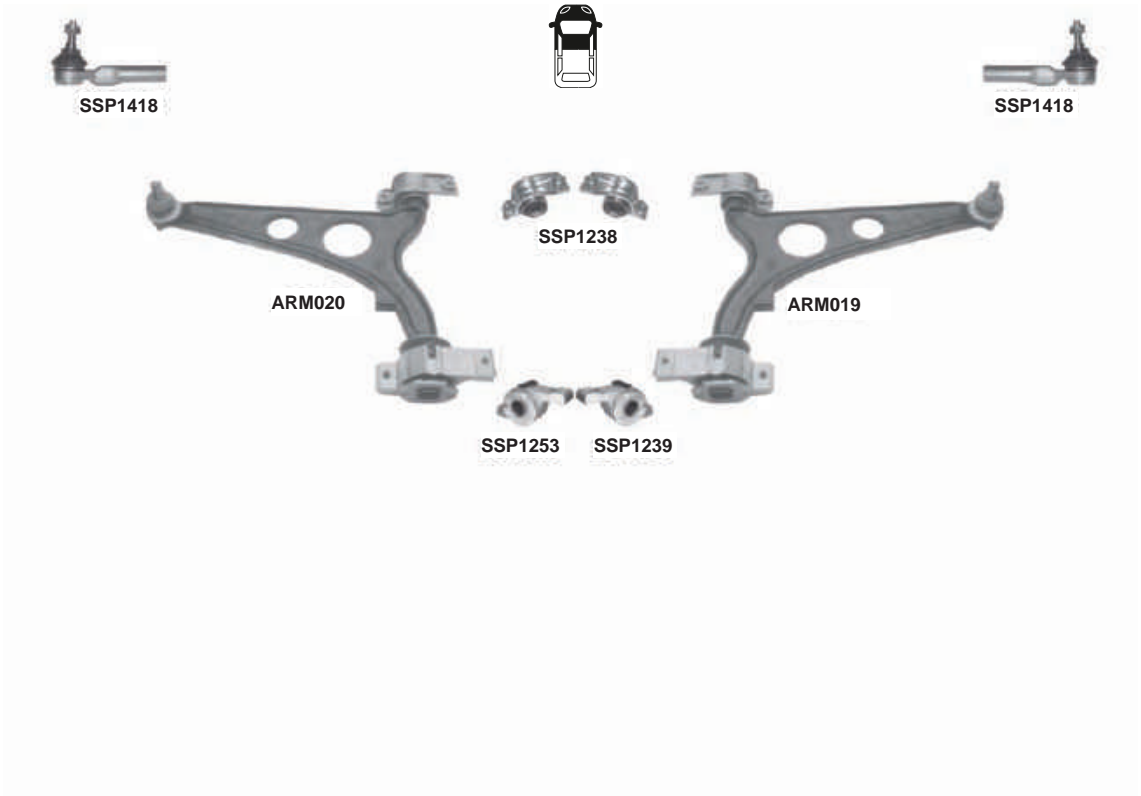

	PART NO.	DESCRIPTION	NOTES	O.E.
ARM019	301181301900	Suspension Control Arm and Ball Joint Assembly - Front Right Lower		46522147; 46764747
ARM020	301181302000	Suspension Control Arm and Ball Joint Assembly - Front Left		46525407; 46764746
SSP1238	301181312380	Bush / Silent block - Track control arm	ARM019 / ARM020	
SSP1239	301181312390	Bush / Silent block - Track control arm - Rh	ARM003 / ARM019 Outer	
SSP1253	301181312530	Bush / Silent block - Track control arm - Lh	ARM004 / ARM020 Outer	
SSP1381	301181313810	Steering Tie Rod - Front Inner	M14x1,5 - L=309mm	3812.A4; 9566950880
SSP1418	301181314180	Steering Tie Rod End - Front	M14x1,5Rht	46527567; 9947926; 9947719



LANCIA MUSA 350



10/2004-

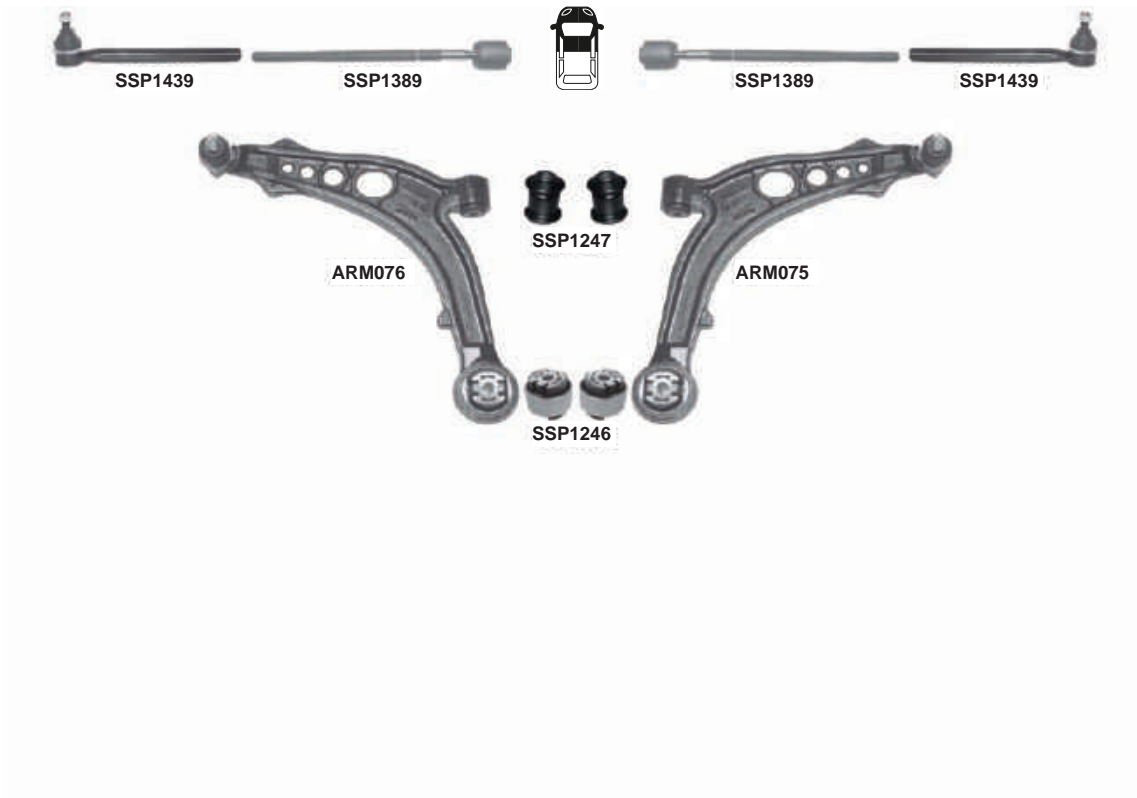

	PART NO.	DESCRIPTION	NOTES	O.E.
ARM075	301181307500	Suspension Control Arm and Ball Joint Assembly - Front Right Lower		50703231
ARM076	301181307600	Suspension Control Arm and Ball Joint Assembly - Front Left		50703232
SSP1246	301181312460	Bush / Silent block - Track control arm - Lower	ARM075 / ARM076 / ARM081 / ARM082	
SSP1247	301181312470	Bush / Silent block - Track control arm	ARM075 / ARM076	
SSP1389	301181313890	Steering Tie Rod - Front	M14x1,5 - L=258mm	77362502
SSP1439	301181314390	Steering Tie Rod End - Front	M14x1,5Rht	7362503; 77362503

LANCIA NUOVA DELTA



1993-2000

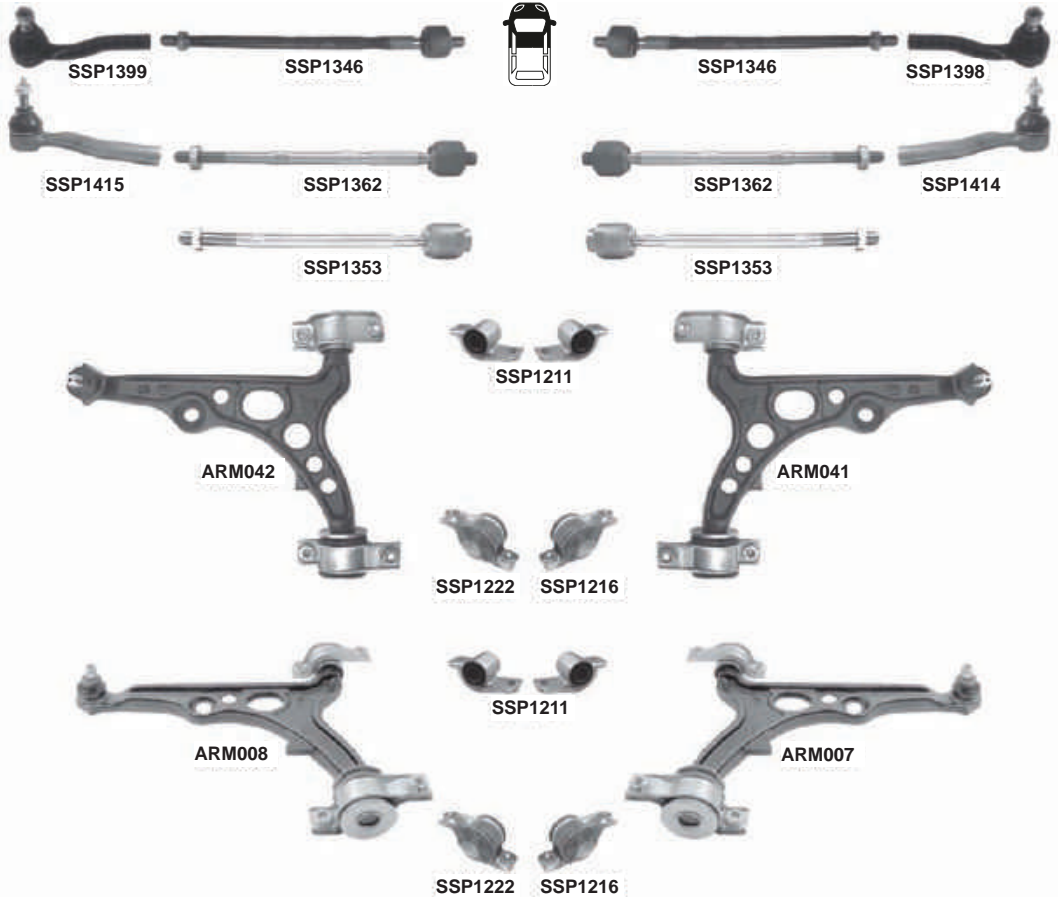

PART NO.	DESCRIPTION	NOTES	O.E.
ARM007	301181300700 Track control arm Rh	Bush / Silent block SSP1211 / SSP1216 - D=Ø17mm	4642627, 46456050, 60566772, 60809814, 60813014, 60813044
ARM008	301181300800 Track control arm Lh	Bush / Silent block SSP1211 / SSP1222 - D=Ø17mm	4642626, 46456049, 60566771, 60809813, 60813013, 60813043
ARM041	301181304100 Track control arm Rh	Bush / Silent block SSP1211 / SSP1216 - D=Ø17mm	46423823, 2674502, 82461082
ARM042	301181304200 Track control arm Lh	Bush / Silent block SSP1211 / SSP1222 - D=Ø17mm	46423822, 82461081
SSP1211	301181312110 Bush / Silent block - Track control arm	ARM008 / ARM007 / ARM041 / ARM042 / ARM155 / ARM156 - D=Ø20,9mm - Center=83mm	7601064
SSP1216	301181312160 Bush / Silent block - Track control arm - Rear Rh	ARM007 / ARM041 / ARM155	7601065
SSP1222	301181312220 Bush / Silent block - Track control arm - Rear Lh	ARM008 / ARM042 / ARM156	7601068
SSP1346	301181313460 Axial joint	M12x1,5Rht - L=285mm Power Steering	9944452
SSP1353	301181313530 Axial joint	M12x1,5Rht - L=285mm Power Steering	59588244
SSP1362	301181313620 Axial joint	M12x1,5 - L=277mm Power Steering	9941625
SSP1398	301181313980 Tie rod end Rh	M12x1,5Rht	60565705, 7678717
SSP1399	301181313990 Tie rod end Lh	M12x1,5Rht	60565706, 7678718, 9947435, 9947437
SSP1414	301181314140 Tie rod end Rh	M12x1,5Rht	60806355, 9947436, 9947438
SSP1415	301181314150 Tie rod end Lh	M12x1,5Rht	60806356, 9947438, 9947439



LANCIA PHEDRA



09/2002-11/2010

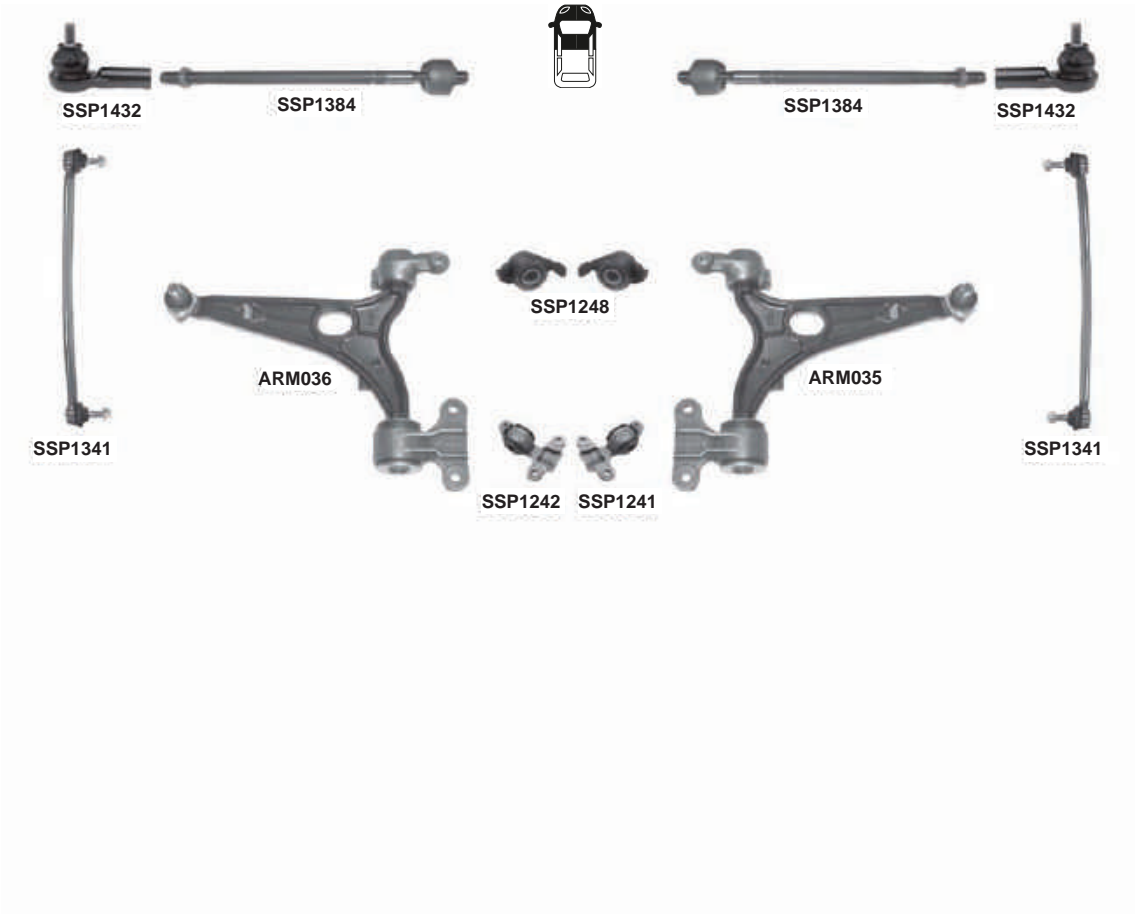

PART NO.	DESCRIPTION	NOTES	O.E.
ARM035	301181303500 Suspension Control Arm and Ball Joint Assembly - Front Right Lower		1346385080; 93501488; 3521.H1
ARM036	301181303600 Suspension Control Arm and Ball Joint Assembly - Front Left		1346384080; 93501487; 3521.H0
SSP1241	301181312410 Bush / Silent block - Track control arm - Rh	ARM035 / ARM073	
SSP1242	301181312420 Bush / Silent block - Track control arm - Lh	ARM036 / ARM074	
SSP1248	301181312480 Bush / Silent block - Track control arm	ARM023 / ARM024 / ARM035 / ARM036	
SSP1341	301181313410 Suspension Stabilizer Bar Link - Front	L=262,5mm	1331209080; 5087.51
SSP1384	301181313840 Steering Tie Rod - Front	M14x1,5 - L=308mm	3812.E2; 77362280
SSP1432	301181314320 Steering Tie Rod End - Front Outer	M14x1,5Rht - D=Ø15,45mm	4059.12; 77362279



LANCIA THEMA



1984-1994



PART NO.	DESCRIPTION	NOTES	O.E.
SSP1345 301181313450	Steering Tie Rod - Front Inner	Only:2.0 lt H.D M12x1,5 - L=267mm	9947361



LANCIA Y 10



1985-1996

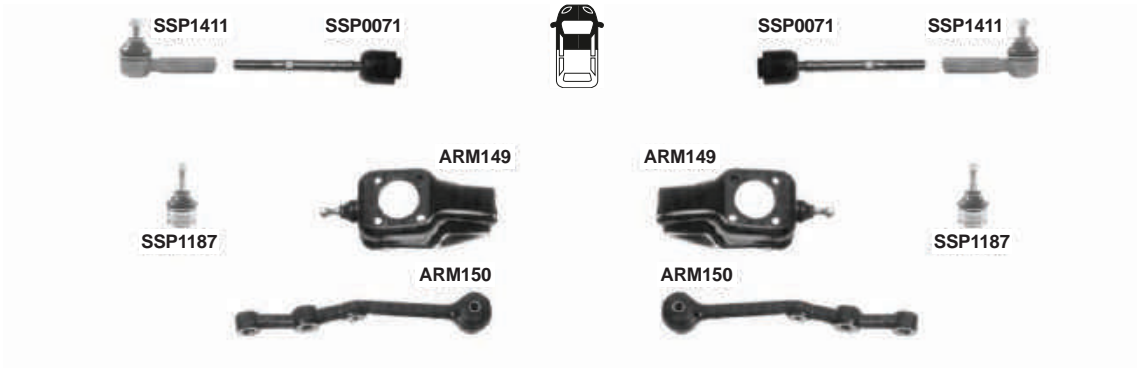

	PART NO.	DESCRIPTION	NOTES	O.E.
ARM149	301181314900	Suspension Control Arm and Ball Joint Assembly - Front Upper		4408138; SE028140104A*; 5995503
ARM150	301181315000	Suspension Control Arm - Front Lower		4402672; SE141156110A; 7601261
SSP0071	301191600710	Steering Tie Rod - Front	M12x1,5 - L=192mm	5960321; SE141162449A
SSP1187	301181311870	Suspension Ball Joint - Front Upper		4402644; SE141140104A; 4402649
SSP1411	301181314110	Steering Tie Rod End - Front	M12x1,5Rht	5960835; SE141162410A



LANCIA Y



11/1995-09/2003

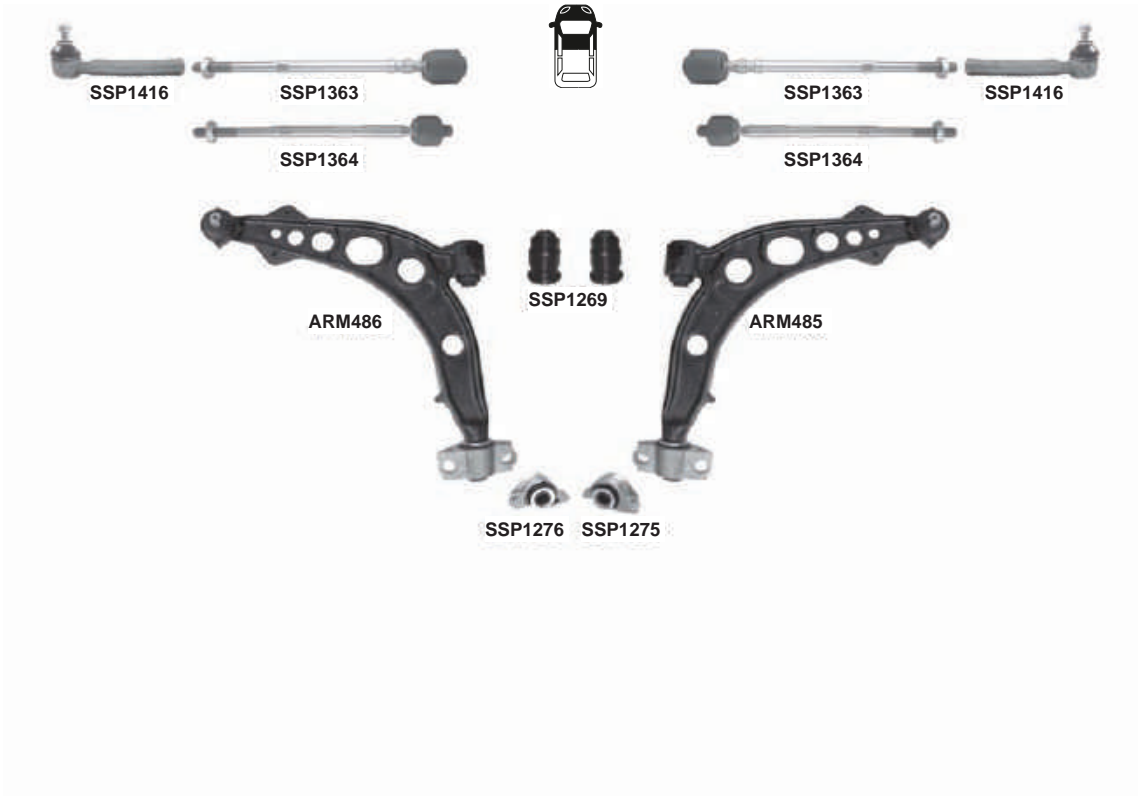

PART NO.	DESCRIPTION	NOTES	O.E.
ARM485 301181348500	Suspension Control Arm and Ball Joint Assembly - Front Right Lower		46402682; 7750978; 46430003
ARM486 301181348600	Suspension Control Arm and Ball Joint Assembly - Front Left		46402681; 7750977; 46430002
SSP1269 301181312690	Bush / Silent block - Track control arm	ARM001 / ARM002 / ARM009 / ARM010 / ARM029 / ARM030	7673581
SSP1275 301181312750	Bush / Silent block - Track control arm - Rh	ARM029	7775344
SSP1276 301181312760	Bush / Silent block - Track control arm - Lh	ARM030	7775343
SSP1363 301181313630	Steering Tie Rod - Front	Manual steering M12x1,5 - L=280mm	7701491; 9946948
SSP1364 301181313640	Steering Tie Rod - Front	M12x1.5Rht - L=271.3mm	9945562
SSP1416 301181314160	Steering Tie Rod End - Front	M12x1,5Rht	7752285; 9946949



LANCIA YPSILON 843



10/2003-12/2011

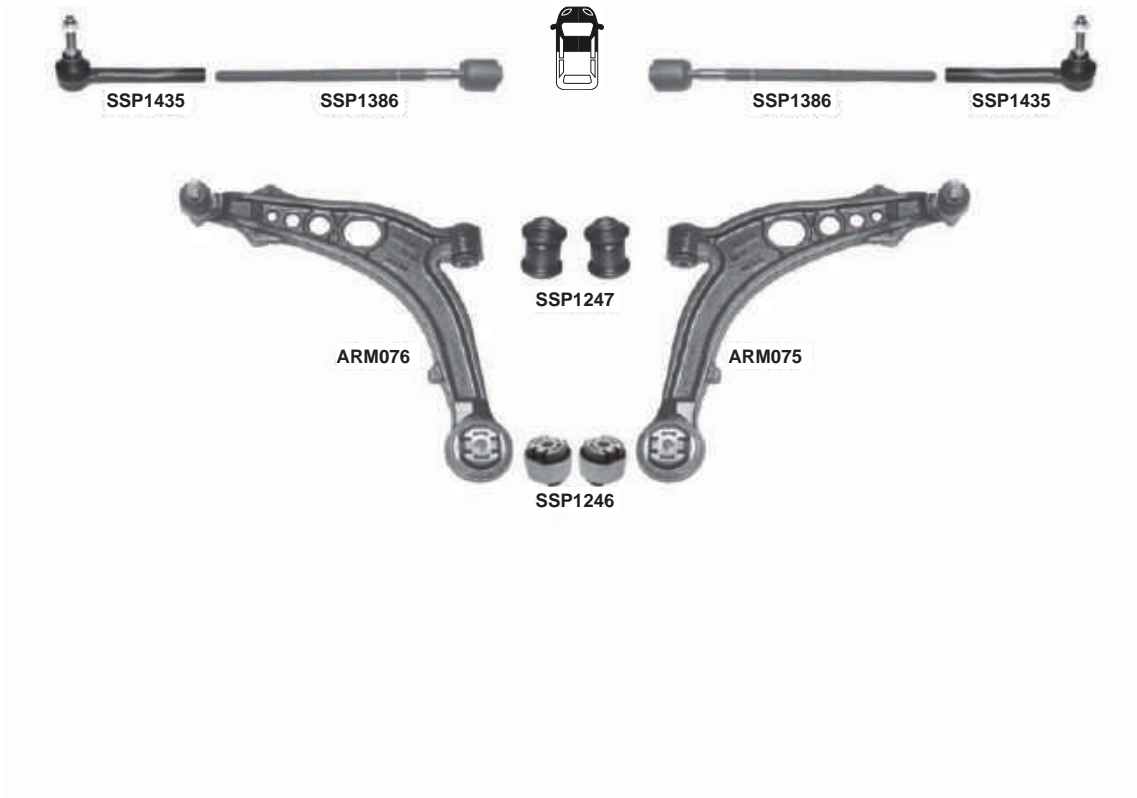

PART NO.	DESCRIPTION	NOTES	O.E.
ARM075 301181307500	Suspension Control Arm and Ball Joint Assembly - Front Right Lower		50703231
ARM076 301181307600	Suspension Control Arm and Ball Joint Assembly - Front Left		50703232
SSP1246 301181312460	Bush / Silent block - Track control arm - Lower	ARM075 / ARM076 / ARM081 / ARM082	
SSP1247 301181312470	Bush / Silent block - Track control arm	ARM075 / ARM076	
SSP1386 301181313860	Steering Tie Rod - Front	M12x1,5 - L=259mm	77362380
SSP1435 301181314350	Steering Tie Rod End - Front	M12x1,5Rht	77362381



LANCIA YPSILON 312, 846



05/2011-



SSP0399



SSP0399



ARM471



ARM470



SSP1313



SSP1313

PART NO.	DESCRIPTION	NOTES	O.E.
ARM470 301181347000	Suspension Control Arm and Ball Joint Assembly - Front Right Lower		51890709; 51956709; 51905058
ARM471 301181347100	Suspension Control Arm and Ball Joint Assembly - Front Left Lower		51890706; 51956712; 51905057
SSP0399 301191603990	Steering Tie Rod End - Front	M12X1,5	77365815
SSP1313 301181313130	Suspension Stabilizer Bar Link - Front	L=287mm	1580517; 9S515K484AB; 51801136



LANCIA Z



1994-2003

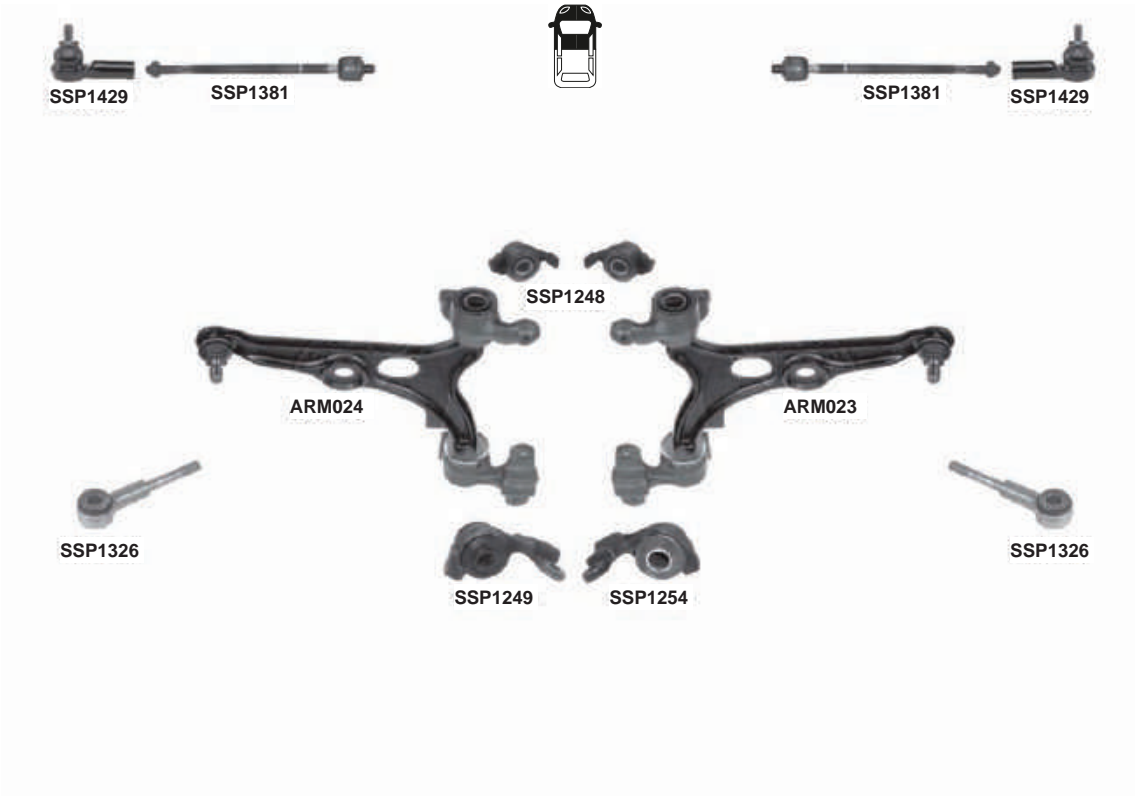

PART NO.	DESCRIPTION	NOTES	O.E.
ARM023 301181302300	Track control arm Rh	Bush / Silent block SSP1248 / SSP1254	1313084080, 1317390080, 3521.83, 3521.C9, 93500973
ARM024 301181302400	Suspension Control Arm and Ball Joint Assembly - Front Left		1313083080; 3520.G9; 3520.94; 3520.C3; 1322663080; 1317389080; 1316735080
SSP1248 301181312480	Bush / Silent block - Track control arm	ARM023 / ARM024 / ARM035 / ARM036	1312317080
SSP1249 301181312490	Bush / Silent block - Track control arm - Lh	ARM024	1305551080
SSP1254 301181312540	Bush / Silent block - Track control arm - Rh	ARM023	1305552080
SSP1326 301181313260	Stabilizer link front	L=122mm	1308664080, 1317425080, 5087.35
SSP1381 301181313810	Steering Tie Rod - Front Inner	M14x1,5 - L=309mm	3812.A4; 9566950880
SSP1429 301181314290	Steering Tie Rod End - Front Outer	M14x1,5Rht - D=Ø14,4mm	1306003080; 9404059580; 4059.09



LANCIA z



2004-2010

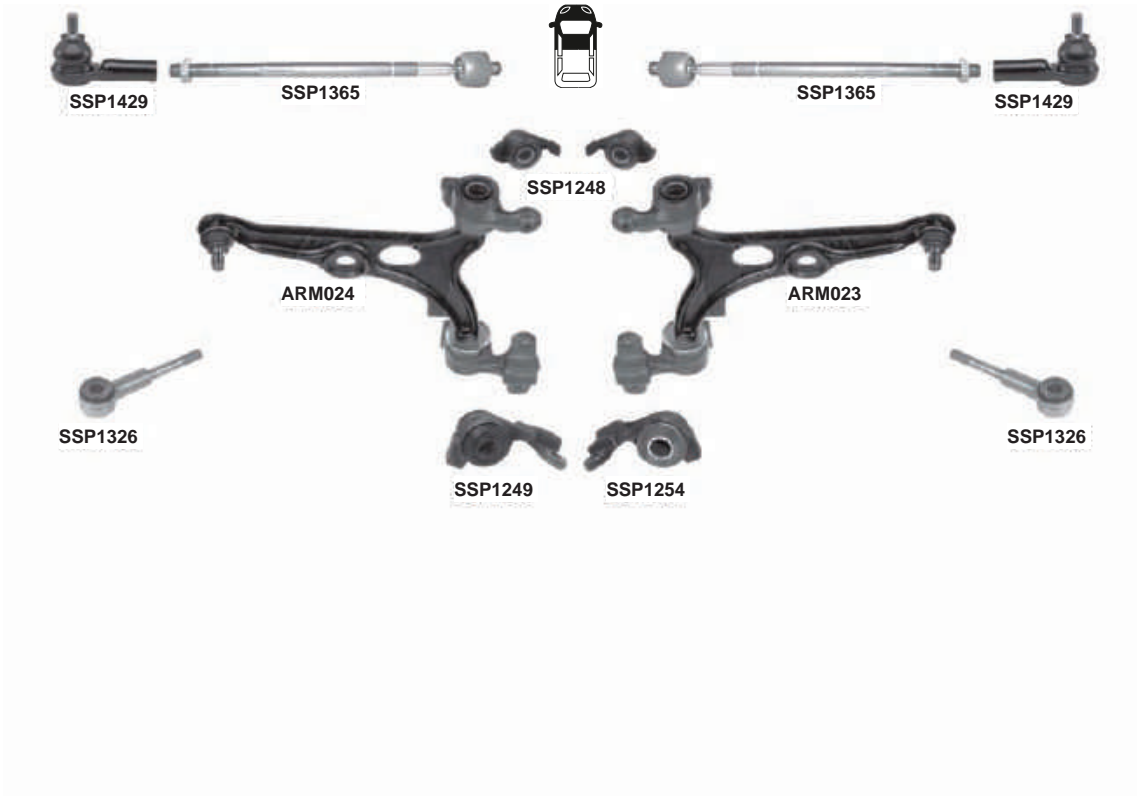

PART NO.	DESCRIPTION	NOTES	O.E.
ARM023 301181302300	Suspension Control Arm and Ball Joint Assembly - Front Right Lower		1313084080; 3521.K4; 3521.83; 3521.C9; 1322664080; 1317390080; 1316736080
ARM024 301181302400	Track control arm Lh	Bush / Silent block SSP1248 / SSP1249	"1313083080, 1317389080, 3520.C3, 3520.G9, 93500972"
SSP1248 301181312480	Bush / Silent block - Track control arm	ARM023 / ARM024 / ARM035 / ARM036	1312317080
SSP1249 301181312490	Bush / Silent block - Track control arm - Lh	ARM024	1305551080
SSP1254 301181312540	Bush / Silent block - Track control arm - Rh	ARM023	1305552080
SSP1326 301181313260	Suspension Stabilizer Bar Link - Front	L=122mm	1308664080; 5087.35; 1317425080
SSP1365 301181313650	Steering Tie Rod - Front Inner	M14x1,5Rht - L=309.3mm	9947713



LAND ROVER FREELANDER II



10/2006-08/2014



	PART NO.	DESCRIPTION	NOTES	O.E.
SSP0438	301191604380	Steering Tie Rod End - Front Right	M18x1,5	1433273; LR002609; 30776248; 6G913290AA; 31280001
SSP0439	301191604390	Steering Tie Rod End - Front Left	M18x1,5	1433274; LR002610; 30776249; 6G913289AA; 31280001



LAND ROVER LR2 L359



2006-2015



SSP0439



SSP0438

PART NO.	DESCRIPTION	NOTES	O.E.
SSP0438 301191604380	Steering Tie Rod End - Front Right	M18x1,5	1433273; LR002609; 30776248; 6G913290AA; 31280001
SSP0439 301191604390	Steering Tie Rod End - Front Left	M18x1,5	1433274; LR002610; 30776249; 6G913289AA; 31280001



LDV MAXUS



2005-



PART NO.	DESCRIPTION	NOTES	O.E.
SSP1197 301181311970	Suspension Ball Joint - Front Lower	Only : 1,8Q	1300473080; 542410095; 3640.33



LEXUS ES300 XV10



1991-2001

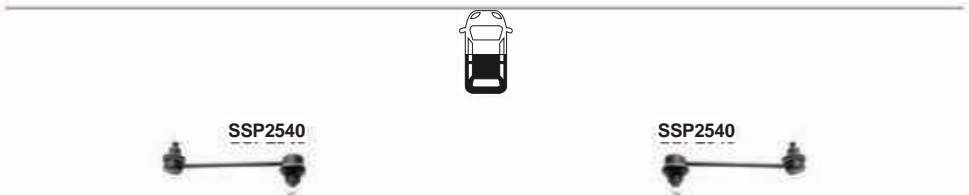

PART NO.	DESCRIPTION	NOTES	O.E.
SSP0666 301191606660	Steering Tie Rod End - Front		4504629255
SSP2540 301191625400	Suspension Stabilizer Bar Link - Front Left		4881006030; 4883033010
SSP2541 301191625410	Suspension Stabilizer Bar Link - Rear		4883006020; 4883048010; 4883006030



LEXUS GX470 J120



2003-2010

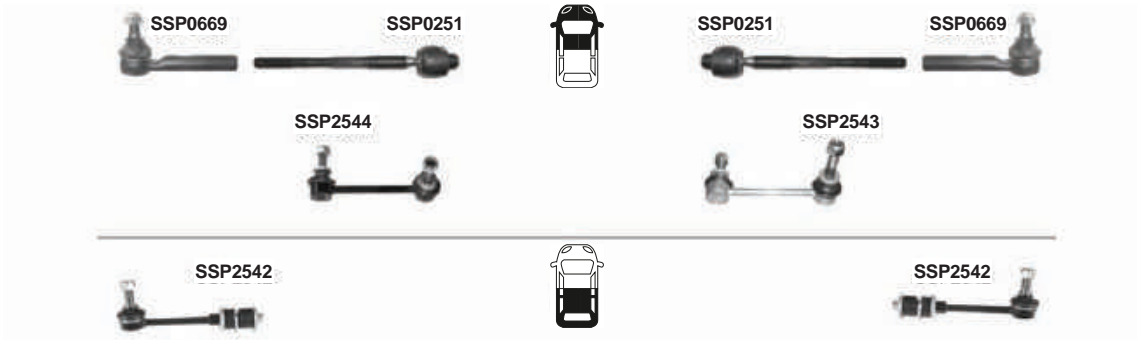

PART NO.	DESCRIPTION	NOTES	O.E.
SSP0251 301191602510	Steering Tie Rod - Front		4550339235
SSP0669 301191606690	Steering Tie Rod End - Front		4504539505
SSP2542 301191625420	Suspension Stabilizer Bar Link - Rear		4883060030
SSP2543 301191625430	Suspension Stabilizer Bar Link - Front Right		4882060050
SSP2544 301191625440	Suspension Stabilizer Bar Link - Front Left		4881060040



LEXUS HS250h



2010-2012



	PART NO.	DESCRIPTION	NOTES	O.E.
ARM997	301181399700	Suspension Control Arm and Ball Joint Assembly - Front Right Lower		4806802130*; 4806812300*
ARM998	301181399800	Suspension Control Arm and Ball Joint Assembly - Front Left Lower		4806902130*; 4806912300*
SSP1974	301191619740	Suspension Ball Joint - Front		4333009630; 4333049095; 4333019245

**LEXUS LX470 J100**

1998-2007

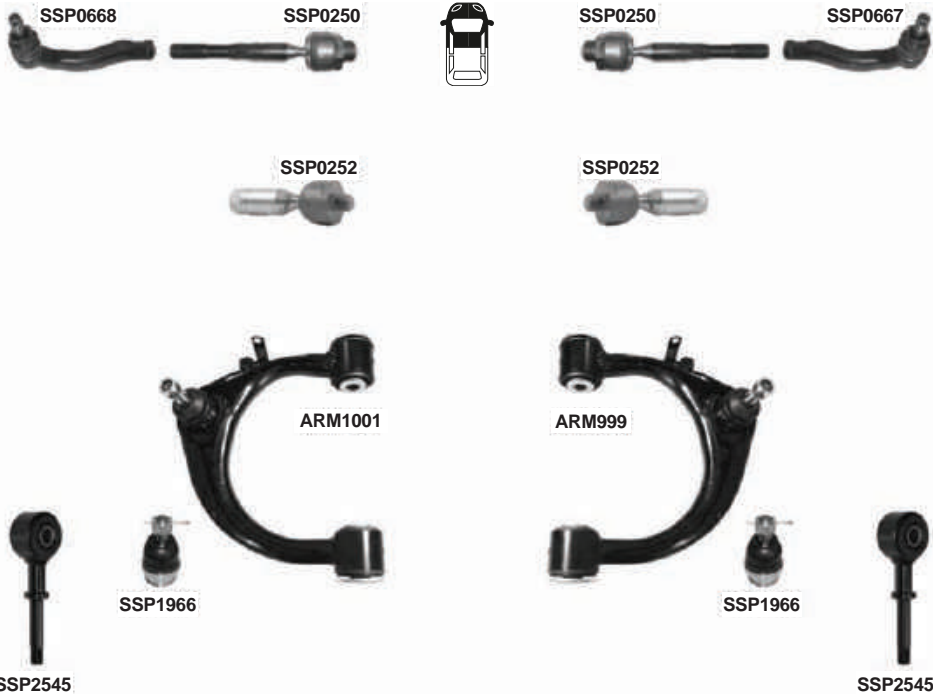

	PART NO.	DESCRIPTION	NOTES	O.E.
ARM999	301181399900	Suspension Control Arm and Ball Joint Assembly - Front Right Upper		4861060030
ARM1001	301181310010	Suspension Control Arm and Ball Joint Assembly - Front Left Upper		4863060010
SSP0250	301191602500	Steering Tie Rod - Front Inner		4550369025
SSP0252	301191602520	Steering Tie Rod - Front		4550339075
SSP0667	301191606670	Steering Tie Rod End - Front Right		4504669205
SSP0668	301191606680	Steering Tie Rod End - Front Left		4504769115
SSP1966	301191619660	Suspension Ball Joint - Front Lower		Part of 4862060010; Part of 4864060010
SSP2545	301191625450	Suspension Stabilizer Bar Link - Front		4882060032



LEXUS RX300



1999-2003

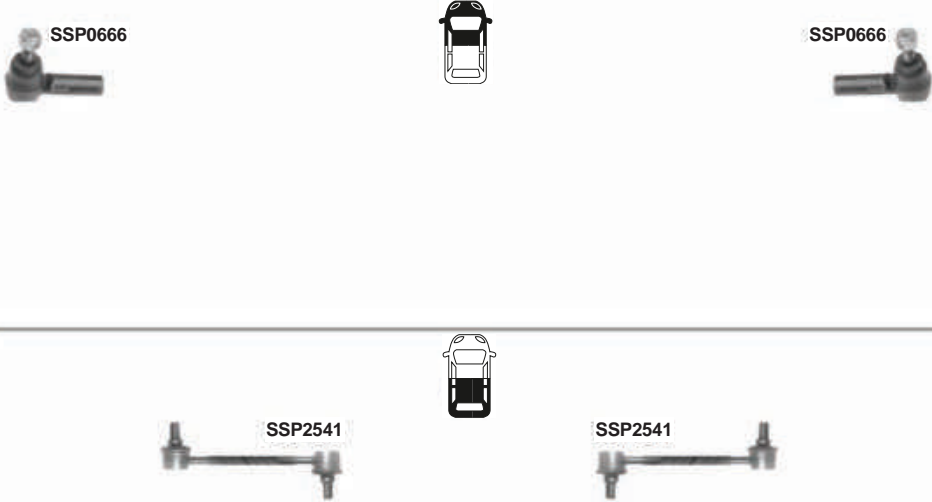

PART NO.	DESCRIPTION	NOTES	O.E.
SSP0666 301191606660	Steering Tie Rod End - Front		4504629255
SSP2540 301191625400	Suspension Stabilizer Bar Link - Front Left		4881006030; 4883033010
SSP2541 301191625410	Suspension Stabilizer Bar Link - Rear		4883006020; 4883048010; 4883006030



LEXUS RX330 MHU3, GSU3, MCU3  02/2003-12/2008



PART NO.	DESCRIPTION	NOTES	O.E.
SSP2541 301191625410	Suspension Stabilizer Bar Link - Rear		4883006020; 4883048010; 4883006030



LEXUS RX350 MHU3, GSU3, MCU3  02/2003-12/2008



PART NO.	DESCRIPTION	NOTES	O.E.
SSP2541 301191625410	Suspension Stabilizer Bar Link - Rear		4883006020; 4883048010; 4883006030



LEXUS RX400h MHU3, GSU3, MCU3 02/2003-12/2008



PART NO.	DESCRIPTION	NOTES	O.E.
SSP2541 301191625410	Suspension Stabilizer Bar Link - Rear		4883006020; 4883048010; 4883006030



PART NO.	DESCRIPTION	NOTES	O.E.
SSP1830 301191618300	Suspension Ball Joint - Front Lower		BL5Z3050A



**MAGNETI
MARELLI**

LINCOLN BLACKWOOD



2002-2003

SSP0425



SSP0425



PART NO.	DESCRIPTION	NOTES	O.E.
SSP0425 301191604250	Steering Tie Rod End - Front		2L3Z3A130CA



LINCOLN MKC



2015-2016

SSP0423



SSP0423



PART NO.	DESCRIPTION	NOTES	O.E.
SSP0423 301191604230	Steering Tie Rod End - Front Right	M16X1,5	1714576; 1748237; 1826501; 1780102



LINCOLN MKT



2013-2015

SSP0079



SSP0079



PART NO.	DESCRIPTION	NOTES	O.E.
SSP0079 301191600790	Steering Tie Rod - Front		BB5Z3280A



LINCOLN MKX 1st Gen



2007-2014

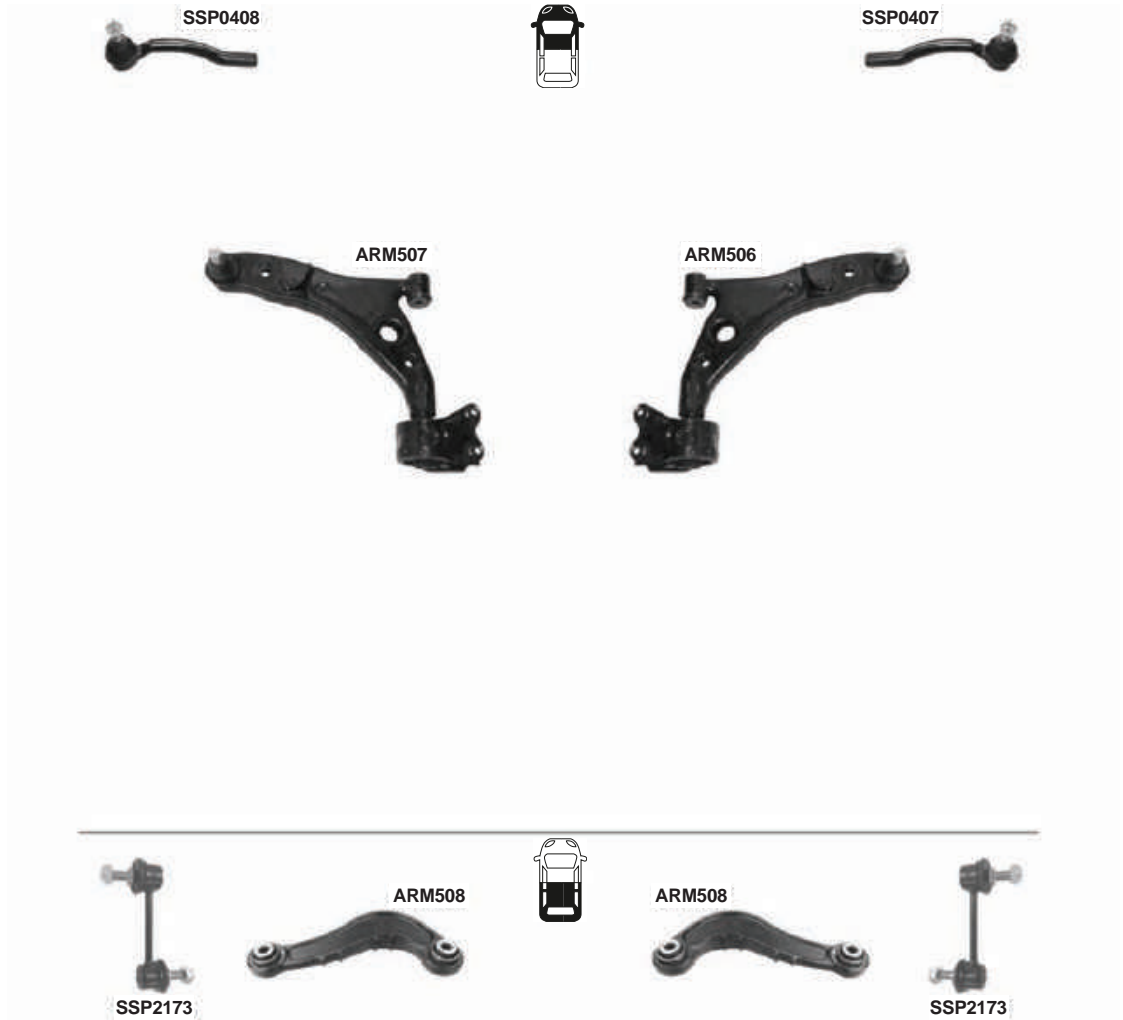

PART NO.	DESCRIPTION	NOTES	O.E.
ARM506	301181350600	Suspension Control Arm and Ball Joint Assembly - Front Right Lower	8T4Z3078A
ARM507	301181350700	Suspension Control Arm and Ball Joint Assembly - Front Left Lower	8T4Z3079A
ARM508	301181350800	Lateral Arm - Rear	7T4Z5500A
SSP0407	301191604070	Steering Tie Rod End - Front Right	7T4Z3A130A
SSP0408	301191604080	Steering Tie Rod End - Front Left	7T4Z3A130B
SSP2173	301191621730	Suspension Stabilizer Bar Link - Rear	7T4Z5A486AA



LINCOLN MKZ 1st Gen



2006-2012

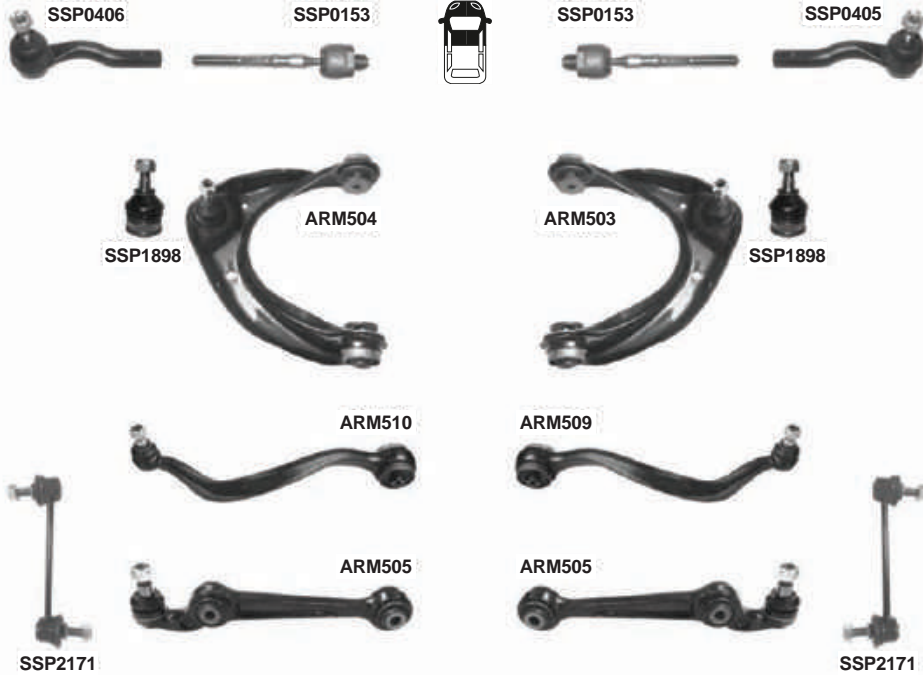



LINCOLN MKZ 1st Gen



2006-2012

PART NO.	DESCRIPTION	NOTES	O.E.
ARM502	301181350200 Lateral Arm - Rear Upper		AE5Z5500A; G26A28C10
ARM503	301181350300 Suspension Control Arm and Ball Joint Assembly - Front Right Upper		AE5Z3084A
ARM504	301181350400 Suspension Control Arm and Ball Joint Assembly - Front Left Upper		AE5Z3085A
ARM505	301181350500 Suspension Control Arm and Ball Joint Assembly - Front Lower		AE5Z3078A
ARM509	301181350900 Suspension Control Arm and Ball Joint Assembly - Front Right		BE5Z3078B; 7E5Z3078L; GJ6A34J00D; GJ6A34J00C; GJ6A34J00B
ARM510	301181351000 Suspension Control Arm and Ball Joint Assembly - Front Left		BE5Z3079B; 7E5Z3079L; GJ6A34J50D; GJ6A34J50C; GJ6A34J50B
ARM529	301181352900 Lateral Arm - Rear Lower		9E5Z5500A; G26A28500A; G26A28500D; G26A28500B; G62A28500B; GJ6A28500D; GK2A28500
SSP0153	301191601530 Steering Tie Rod - Front		6E5Z3332B; GJ6E32240
SSP0405	301191604050 Steering Tie Rod End - Front Right		AE5Z3A130B
SSP0406	301191604060 Steering Tie Rod End - Front Left		AE5Z3A130A
SSP1898	301191618980 Suspension Ball Joint - Front Upper		GJ6A34540
SSP2171	301191621710 Suspension Stabilizer Bar Link - Front		AE5Z5K483A
SSP2402	301191624020 Suspension Stabilizer Bar Link - Rear		5M8Z5A486A; GJ6A28170A



LINCOLN NAVIGATOR UN173, U228 05/1997-12/2006

**SSP0087****SSP0087****SSP0425****SSP2288****SSP2288**

	PART NO.	DESCRIPTION	NOTES	O.E.
ARM553	301181355300	Suspension Control Arm and Ball Joint Assembly - Front right lower		6L1Z3078AA
ARM554	301181355400	Suspension Control Arm and Ball Joint Assembly - Front left lower		6L1Z3079AA
SSP0087	301191600870	Steering Tie Rod - Front		2L1Z3280GA
SSP0425	301191604250	Steering Tie Rod End - Front		2L3Z3A130CA
SSP2288	301191622880	Suspension Stabilizer Bar Link - Front	L=126mm	2L1Z5K483AD



LINCOLN NAVIGATOR 3rd Gen, U326



2007-2017



PART NO.	DESCRIPTION	NOTES	O.E.
SSP0426 301191604260	Steering Tie Rod End - Front Right		7L1Z3A130R
SSP0427 301191604270	Steering Tie Rod End - Front Left		7L1Z3A130L
SSP1838 301191618380	Suspension Ball Joint - Front Lower		9L3Z3050A
SSP2198 301191621980	Suspension Stabilizer Bar Link - Front		7L1Z5K483B



LINCOLN TOWN CAR 3rd Gen



1998-2011



PART NO.	DESCRIPTION	NOTES	O.E.
SSP2170 301191621700	Suspension Stabilizer Bar Link - Front		3W1Z5K484AA

MAZDA 121 III



03/1996-04/2003

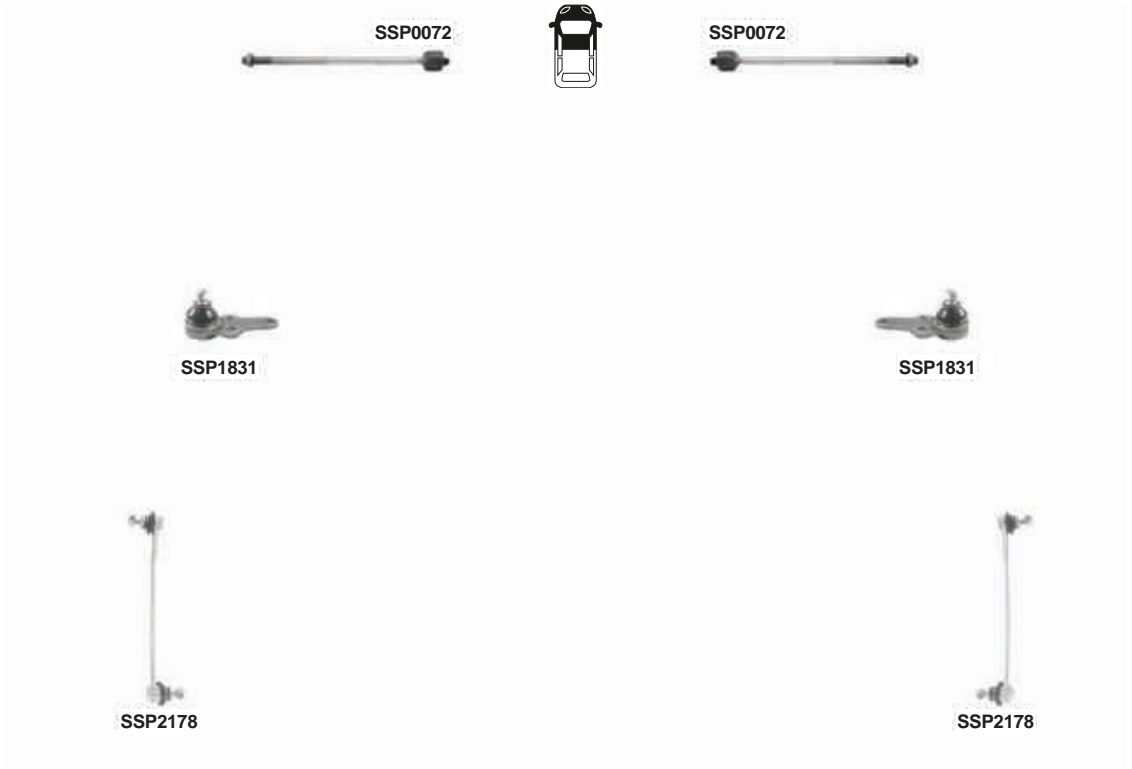

PART NO.	DESCRIPTION	NOTES	O.E.
SSP0072 301191600720	Steering Tie Rod - Front	M14x2 - L=313mm	1044014; B196FB3L519BA; 1E0032240
SSP1831 301191618310	Suspension Ball Joint - Front	D=Ø16.5 mm	1030025; 94FB3395A2B; 1047797
SSP2178 301191621780	Suspension Stabilizer Bar Link - Front	L=237mm	1061631; 1S613B438AA; 98AG3B438AB; 1E0034170; 1661237; 1130273



MAZDA 2 DY



04/2003-06/2007

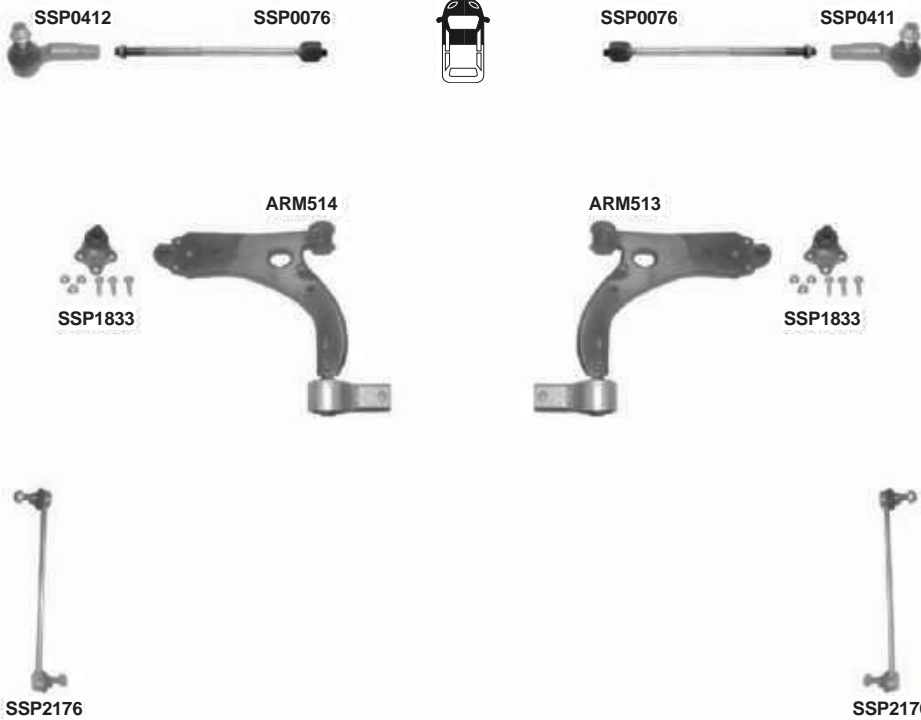

	PART NO.	DESCRIPTION	NOTES	O. E.
ARM513	301181351300	Suspension Control Arm and Ball Joint Assembly - Front Right Lower		1146130; DD3234300; 1436097; 1212807
ARM514	301181351400	Suspension Control Arm and Ball Joint Assembly - Front Left Lower		1146131; DD3234350; 1436095; 1212808
SSP0076	301191600760	Steering Tie Rod - Front	M14x1,5 - L=278mm	2S6J3289AC; Y12S6C3280KB; DE9032240; 4472940; 4342539
SSP0411	301191604110	Steering Tie Rod End - Front Right	M14x1,5Rht	1202548; Y1256J3289AC; DE9032280
SSP0412	301191604120	Steering Tie Rod End - Front Left	M14x1,5Rht	1202549; Y1256J3290AC; DE9032290
SSP1833	301191618330	Suspension Ball Joint - Front Lower	D=Ø16,5mm	1679382; 2S613395AB
SSP2176	301191621760	Suspension Stabilizer Bar Link - Front	L=284mm	1146150; Y125613B438AC; DD3234170
SSP2177	301191621770	Suspension Stabilizer Bar Link - Front	(Clip-on patented design) L=284mm	Y125613B438AC*



MAZDA 2 DE



10/2007-2015

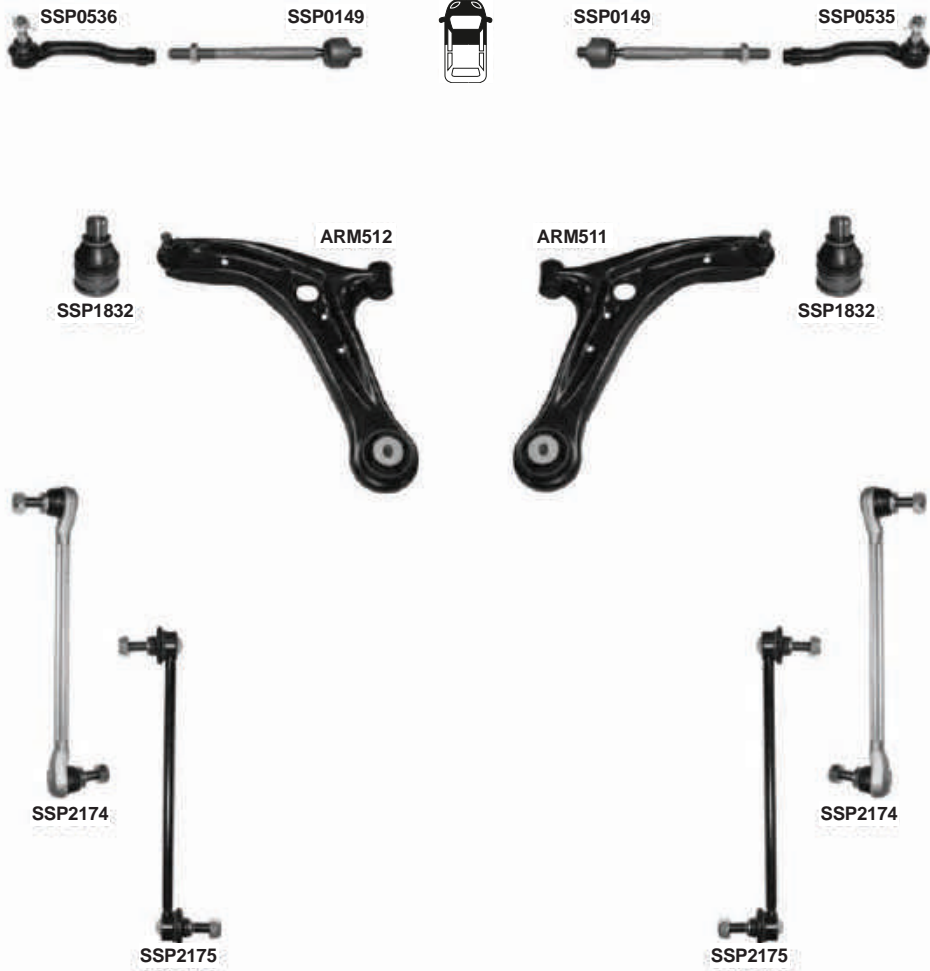

	PART NO.	DESCRIPTION	NOTES	O.E.
ARM511	301181351100	Suspension Control Arm and Ball Joint Assembly - Front Right Lower		1737309; D65134300B; 8V513042BH; 8V513042BD; BE8Z3078A
ARM512	301181351200	Suspension Control Arm and Ball Joint Assembly - Front Left Lower		1737305; D65134350B; 8V513051BH; 8V513051BD; BE8Z3079A
SSP0149	301191601490	Steering Tie Rod - Front	M14X1,5 - L=216mm	D65132240
SSP0535	301191605350	Steering Tie Rod End - Front Right	M14X1,5	D65132280
SSP0536	301191605360	Steering Tie Rod End - Front Left	M14X1,5	D65132290
SSP1832	301191618320	Suspension Ball Joint - Front Lower		1540724 Part of; Part of 1751955; Part of 1751952; Part of BE8Z3078A; Part of BE8Z3079A
SSP2174	301191621740	Suspension Stabilizer Bar Link - Front	Alm. L=251mm	1513343; D65134170; 8V513B438BA; 8V513B438AB; 1745924; 8V5Z5K484B
SSP2175	301191621750	Suspension Stabilizer Bar Link - Front	Metal L=251mm	1513343*; D65134170*; 8V513B438AB*; 8V5Z5K484B



MAZDA 2 DJ



2014-



PART NO.	DESCRIPTION	NOTES	O.E.
SSP2410 301191624100	Suspension Stabilizer Bar Link - Front		DA5A34170



MAZDA 3 BK



10/2003-06/2009

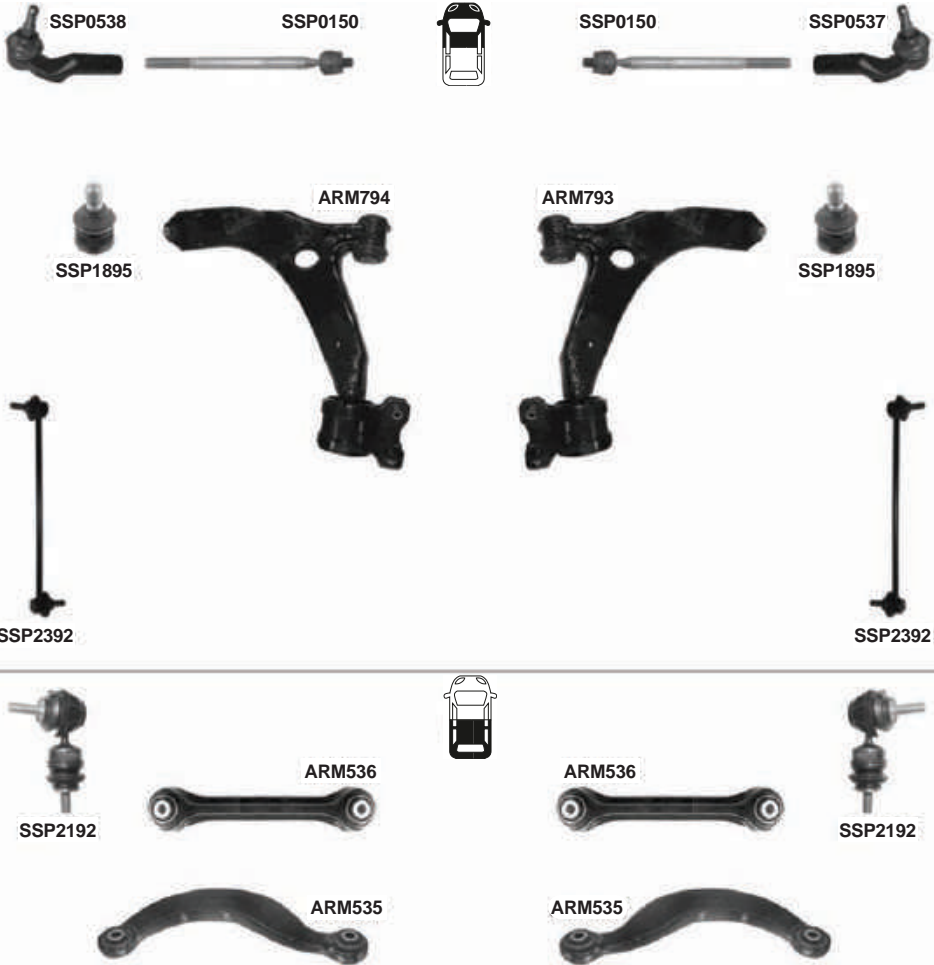

PART NO.	DESCRIPTION	NOTES	O.E.
ARM535 301181353500	Lateral Arm - Rear Upper		1061660; YS4Z5500AA; 1M515500AC; 98AG5500AG; 1M515500AB; 1329730; 1317609
ARM536 301181353600	Lateral Arm - Rear Lower		1061668; CV6Z5500L; 98AG5K743AF; BV615K743AA; 31277675; 2463500053; 1703145; 1753556
ARM793 301181379300	Suspension Control Arm and Ball Joint Assembly - Front Right Lower		B32H34300A; C51334300; BP4K34300B; BP4K34300E; B32H34300C; B32H34300D
ARM794 301181379400	Suspension Control Arm and Ball Joint Assembly - Front Left Lower		B32H34350; C51334350; B32H34350D; BP4K34350E; B32H34350A; B32H34350C
SSP0150 301191601500	Steering Tie Rod - Front	M17x1,5Rht - L=292mm	BP4L32240
SSP0537 301191605370	Steering Tie Rod End - Front Right	M17x1,5Rht	BP4L32280
SSP0538 301191605380	Steering Tie Rod End - Front Left	M17x1,5Rht	BP4L32290
SSP1895 301191618950	Suspension Ball Joint - Front	D=Ø18mm	2L8Z3079AA
SSP2192 301191621920	Suspension Stabilizer Bar Link - Rear	L=76mm	1310333; BP4K28170H; BP4K28170D; BP4K28170G; 30714466; 30683232; 1335548
SSP2392 301191623920	Suspension Stabilizer Bar Link - Front	L=306,5mm	BP4K34170C



MAZDA 3 BL



07/2009-11/2014

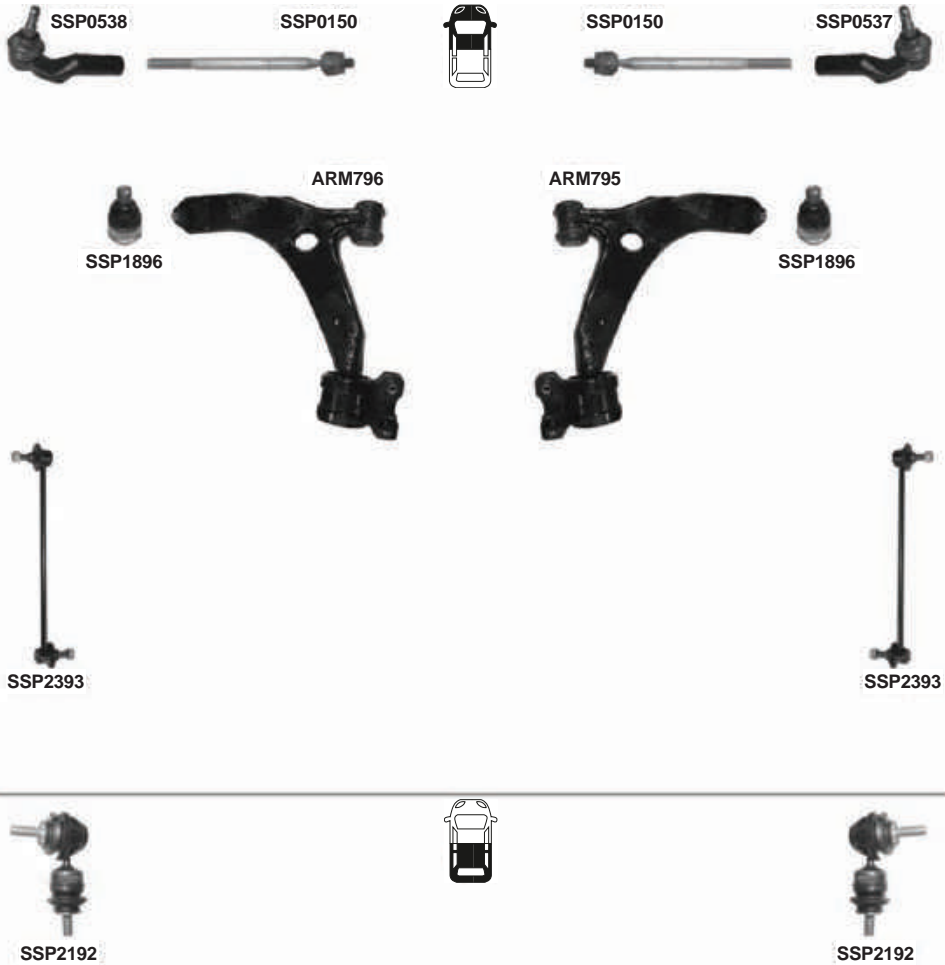

PART NO.	DESCRIPTION	NOTES	O.E.
ARM795 301181379500	Suspension Control Arm and Ball Joint Assembly - Front Right Lower		BBM234300; BBM234300A
ARM796 301181379600	Suspension Control Arm and Ball Joint Assembly - Front Left Lower		BBM234350; BBM234350A
SSP0150 301191601500	Steering Tie Rod - Front	M17x1,5Rht - L=292mm	BP4L32240
SSP0537 301191605370	Steering Tie Rod End - Front Right	M17x1,5Rht	BP4L32280
SSP0538 301191605380	Steering Tie Rod End - Front Left	M17x1,5Rht	BP4L32290
SSP1896 301191618960	Suspension Ball Joint - Front		BBM234300/350 Part of
SSP2192 301191621920	Suspension Stabilizer Bar Link - Rear	L=76mm	1310333; BP4K28170H; BP4K28170D; BP4K28170G; 30714466; 30683232; 1335548
SSP2393 301191623930	Suspension Stabilizer Bar Link - Front	L=298mm	BBM234170A

MAZDA 3 BM



12/2014-



PART NO.	DESCRIPTION	NOTES	O. E.
ARM797	301181379700 Lateral Arm - Rear	L=284mm	BJS728C10
ARM798	301181379800 Lateral Arm - Rear Right		B45A28200
ARM799	301181379900 Lateral Arm - Rear Left		B45A28250
ARM800	301181380000 Suspension Control Arm and Ball Joint Assembly - Front Right Lower	Japan Built	BPN734300A; B45A34300; B60P34300; B60S34300
ARM801	301181380100 Suspension Control Arm and Ball Joint Assembly - Front Left Lower	Japan Built	BPN734300A; B45A34350; B60P34350; B60S34350
SSP0151	301191601510 Steering Tie Rod - Front		GHT232240A
SSP0539	301191605390 Steering Tie Rod End - Front Right	C = M14x1.5	GHT232280
SSP0540	301191605400 Steering Tie Rod End - Front Left	C = M14x1.5	GHT232290
SSP2394	301191623940 Suspension Stabilizer Bar Link - Front Right	L=284mm	B45A34150
SSP2395	301191623950 Suspension Stabilizer Bar Link - Front Left	L=284mm	B45A34170
SSP2396	301191623960 Suspension Stabilizer Bar Link - Rear Right	L=150mm	KD3128170
SSP2397	301191623970 Suspension Stabilizer Bar Link - Rear Left	L=150mm	KD3128190



MAZDA 5 CR19, 2nd Gen

03/2005-08/2010



SSP2392

SSP2392



SSP2192

SSP2192



ARM536

ARM536

ARM535

ARM535



PART NO.	DESCRIPTION	NOTES	O.E.
ARM535	301181353500 Lateral Arm - Rear Upper		1061660; YS4Z5500AA; 1M515500AC; 98AG5500AG; 1M515500AB; 1329730; 1317609
ARM536	301181353600 Lateral Arm - Rear Lower		1061668; CV6Z5500L; 98AG5K743AF; BV615K743AA; 31277675; 2463500053; 1703145; 1753556
ARM793	301181379300 Suspension Control Arm and Ball Joint Assembly - Front Right Lower		B32H34300A; C51334300; BP4K34300B; BP4K34300E; B32H34300C; B32H34300D
ARM794	301181379400 Suspension Control Arm and Ball Joint Assembly - Front Left Lower		B32H34350; C51334350; B32H34350D; BP4K34350E; B32H34350A; B32H34350C
SSP0150	301191601500 Steering Tie Rod - Front	M17x1,5Rht - L=292mm	BP4L32240
SSP0537	301191605370 Steering Tie Rod End - Front Right	M17x1,5Rht	BP4L32280
SSP0538	301191605380 Steering Tie Rod End - Front Left	M17x1,5Rht	BP4L32290
SSP1895	301191618950 Suspension Ball Joint - Front	D=Ø18mm	2L8Z3079AA
SSP2192	301191621920 Suspension Stabilizer Bar Link - Rear	L=76mm	1310333; BP4K28170H; BP4K28170D; BP4K28170G; 30714466; 30683232; 1335548
SSP2392	301191623920 Suspension Stabilizer Bar Link - Front	L=306,5mm	BP4K34170C



MAZDA 6 GG



06/2002-07/2007

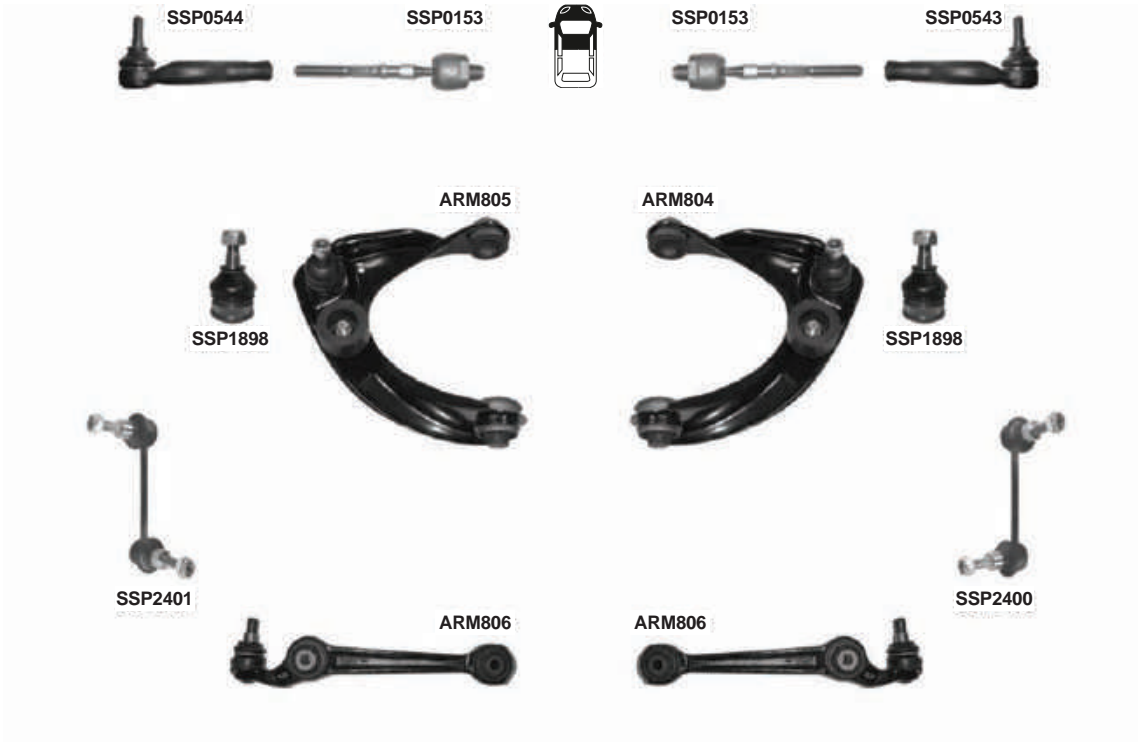

PART NO.	DESCRIPTION	NOTES	O.E.
ARM502 301181350200	Lateral Arm - Rear Upper		AE5Z5500A; G26A28C10
ARM804 301181380400	Suspension Control Arm and Ball Joint Assembly - Front Right Upper		G6JA34J00C; GJ6A34200B; GP9A34200C
ARM805 301181380500	Suspension Control Arm and Ball Joint Assembly - Front Left Upper		GJ6A34250B; G6JA34J050; GP9A34250C
ARM806 301181380600	Suspension Control Arm and Ball Joint Assembly - Front Lower		GJ6A34300B; GJ6A34300C; GJ6A34300D
ARM807 301181380700	Lateral Arm - Rear	FORGED	G26A28C10
SSP0153 301191601530	Steering Tie Rod - Front	M14x1,5 - L=181,5mm	6E5Z3332B; GJ6E32240
SSP0543 301191605430	Steering Tie Rod End - Front Right	M14x1,5Rht	GJ6E32280; GJ6E32280A
SSP0544 301191605440	Steering Tie Rod End - Front Left	M14x1,5Rht	GJ6E32290; GJ6E32290A
SSP1898 301191618980	Suspension Ball Joint - Front Upper		GJ6A34540
SSP2400 301191624000	Suspension Stabilizer Bar Link - Front Right	L=155mm	GJ6A34150A
SSP2401 301191624010	Suspension Stabilizer Bar Link - Front Left	L=155mm	GJ6A34170A; GK2A34170
SSP2402 301191624020	Suspension Stabilizer Bar Link - Rear	L=77mm	5M8Z5A486A; GJ6A28170A



MAZDA 6 GH



08/2007-12/2012



	PART NO.	DESCRIPTION	NOTES	O.E.
ARM808	301181380800	Suspension Control Arm and Ball Joint Assembly - Front Right Lower		GS1D34300G; GS1D34300L; GS1D34300H; GS1D34300J
ARM809	301181380900	Suspension Control Arm and Ball Joint Assembly - Front Left Lower		GS1D34350G; GS1D34350L ; GS1D34350H; GS1D34350J
ARM810	301181381000	Suspension Control Arm and Ball Joint Assembly - Front Right Upper		GS1D34200A; GS1D34200C
ARM811	301181381100	Suspension Control Arm and Ball Joint Assembly - Front Left Upper		GS1D34250A; GS1D34250C
SSP0154	301191601540	Steering Tie Rod - Front	M14X1,5 - L=165mm	GS1D32240
SSP0545	301191605450	Steering Tie Rod End - Front Right	M14X1,5	GS1D32280
SSP0546	301191605460	Steering Tie Rod End - Front Left	M14X1,5	GS1D32290
SSP2403	301191624030	Suspension Stabilizer Bar Link - Rear		GS1D28170
SSP2404	301191624040	Suspension Stabilizer Bar Link - Front Right	L=159mm	GS1D34150
SSP2405	301191624050	Suspension Stabilizer Bar Link - Front Left	L=159mm	GS1D34170



MAZDA 6 GJ



2013-

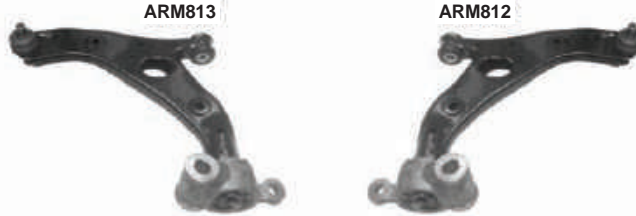

PART NO.	DESCRIPTION	NOTES	O.E.
ARM812 301181381200	Suspension Control Arm and Ball Joint Assembly - Front Right Lower		G46C34300; KD5334300F; KD5334300D; KD5334300G; KD5334300E; GHP934300C; GHP934300D
ARM813 301181381300	Suspension Control Arm and Ball Joint Assembly - Front Left Lower		G46C34350; KD3534350G; KD3534350D; KD3534350F; GHP934350C; GHP934350D
SSP0151 301191601510	Steering Tie Rod - Front		GHT232240A
SSP0539 301191605390	Steering Tie Rod End - Front Right	C = M14x1.5	GHT232280
SSP0540 301191605400	Steering Tie Rod End - Front Left	C = M14x1.5	GHT232290
SSP2396 301191623960	Suspension Stabilizer Bar Link - Rear Right	L=150mm	KD3128170
SSP2397 301191623970	Suspension Stabilizer Bar Link - Rear Left	L=150mm	KD3128190
SSP2406 301191624060	Suspension Stabilizer Bar Link - Front	L=287,5mm	KD3534170



MAZDA CX-3 1st Gen



2015-



PART NO.	DESCRIPTION	NOTES	O.E.
SSP2410 301191624100	Suspension Stabilizer Bar Link - Front		DA5A34170



MAZDA CX-5 KE



11/2011-

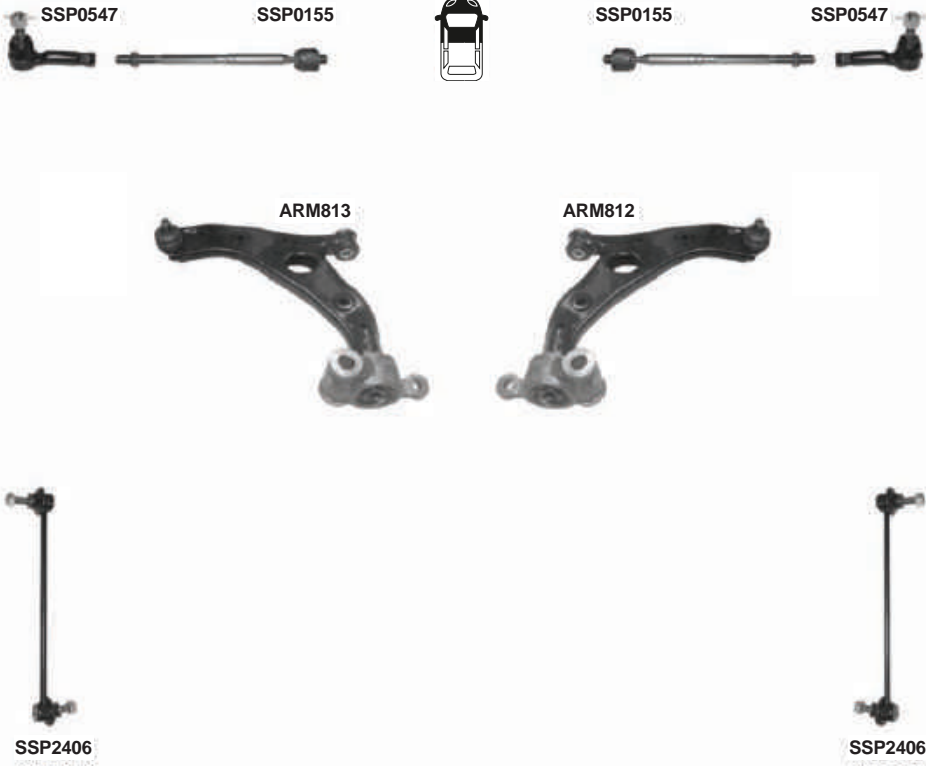

PART NO.	DESCRIPTION	NOTES	O.E.
ARM812 301181381200	Suspension Control Arm and Ball Joint Assembly - Front Right Lower		G46C34300; KD5334300F; KD5334300D; KD5334300G; KD5334300E; GHP934300C; GHP934300D
ARM813 301181381300	Suspension Control Arm and Ball Joint Assembly - Front Left Lower		G46C34350; KD3534350G; KD3534350D; KD3534350F; GHP934350C; GHP934350D
SSP0155 301191601550	Steering Tie Rod - Front	M14X1,5 - L=304mm	KD3132240
SSP0547 301191605470	Steering Tie Rod End - Front	M14X1,5	KD3132280
SSP2406 301191624060	Suspension Stabilizer Bar Link - Front	L=287,5mm	KD3534170



MAZDA CX-7 ER



2007-

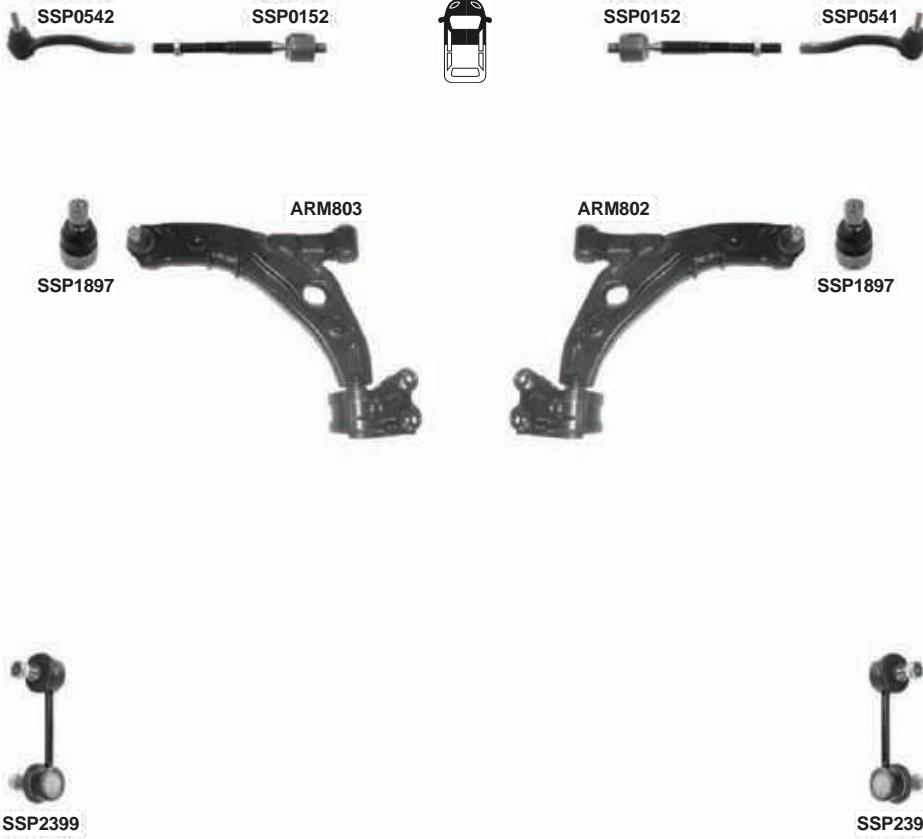

	PART NO.	DESCRIPTION	NOTES	O.E.
ARM802	301181380200	Suspension Control Arm and Ball Joint Assembly - Front Right Lower		EH4434300
ARM803	301181380300	Suspension Control Arm and Ball Joint Assembly - Front Left Lower		EH4434350
SSP0152	301191601520	Steering Tie Rod - Front		4550329795; EG2132240
SSP0541	301191605410	Steering Tie Rod End - Front Right	M14x1.5	EG2132280; EG2132280A; EG2132280B
SSP0542	301191605420	Steering Tie Rod End - Front Left	M14x1.5	EG2132290; EG2132290A; EG2132290B
SSP1897	301191618970	Suspension Ball Joint - Front		Part of EH4434350/300
SSP2390	301191623900	Suspension Stabilizer Bar Link - Rear Left		F15134150; L20634150A
SSP2391	301191623910	Suspension Stabilizer Bar Link - Rear Right		F15134170; L20634150A
SSP2398	301191623980	Suspension Stabilizer Bar Link - Front Right		L20634150A
SSP2399	301191623990	Suspension Stabilizer Bar Link - Front Left		L20634170A



MAZDA CX-9



2007-



ARM815



ARM814



SSP2409



SSP2408



SSP2407



SSP2407



PART NO.	DESCRIPTION	NOTES	O.E.
ARM814 301181381400	Suspension Control Arm and Ball Joint Assembly - Front Right Lower		TD1134300E
ARM815 301181381500	Suspension Control Arm and Ball Joint Assembly - Front Left Lower		TE6934350C
SSP0156 301191601560	Steering Tie Rod - Front		TD1132240A
SSP2407 301191624070	Suspension Stabilizer Bar Link - Rear		L20628170A
SSP2408 301191624080	Suspension Stabilizer Bar Link - Front Right		TD1134150A
SSP2409 301191624090	Suspension Stabilizer Bar Link - Front Left		TD1134170A



MAZDA MX-5 III (NC)



11/2005-



PART NO.	DESCRIPTION	NOTES	O.E.
SSP2389 301191623890	Suspension Stabilizer Bar Link - Rear		F15128170



MAZDA Protege



2001-2003



SSP2420



SSP2420

PART NO.	DESCRIPTION	NOTES	O.E.
SSP2420 301191624200	Suspension Stabilizer Bar Link - Front	L=265mm	5087.58; MN101368



MAZDA RX-8



2003-2011

SSP2389



SSP2389

PART NO.	DESCRIPTION	NOTES	O.E.
SSP2389 301191623890	Suspension Stabilizer Bar Link - Rear		F15128170
SSP2390 301191623900	Suspension Stabilizer Bar Link - Front Right		F15134150; L20634150A
SSP2391 301191623910	Suspension Stabilizer Bar Link - Front Left		F15134170; L20634150A



MERCEDES 190 SERIES W201 1982-1993

ARM670



ARM668

ARM669



ARM667

ARM673



ARM673



ARM666

ARM666



ARM671

ARM671



ARM672

ARM672



PART NO.	DESCRIPTION	NOTES	O.E.
ARM666 301181366600	Lateral Arm - Rear Lower Rearward		2013500653; 2103500653; 2013503253; 2013502753; 2013503153
ARM667 301181366700	Lateral Arm - Rear Right Upper		1243507706; 2103501706
ARM668 301181366800	Suspension Control Arm Kit - Rear Right Upper		1243507706*
ARM669 301181366900	Lateral Arm - Rear Left Upper		1243507606; 2103501606
ARM670 301181367000	Suspension Control Arm Kit - Rear Left Upper		1243507706*
ARM671 301181367100	Lateral Arm - Rear Upper Forward	Rear Axle Short	2013504706; 2013505606
ARM672 301181367200	Lateral Arm - Rear Lower Forward		1243500129; 2103500029
ARM673 301181367300	Suspension Control Arm Kit - Rear		1243500129*



MERCEDES A SERIES W168



1997-2004



	PART NO.	DESCRIPTION	NOTES	O.E.
ARM674	301181367400	Suspension Control Arm and Ball Joint Assembly - Front Right Lower		1683300907; 1683302407
ARM675	301181367500	Suspension Control Arm and Ball Joint Assembly - Front Left Lower		1683300807; 1683302307
SSP0130	301191601300	Steering Tie Rod - Front	M12x1,5 - L=196,5mm	1683301335
SSP0495	301191604950	Steering Tie Rod End - Front Right	M12x1,5Rht	1683301235; 1683301635
SSP0496	301191604960	Steering Tie Rod End - Front Left	M12x1,5Rht	1683301135; 1683301535
SSP1877	301191618770	Suspension Ball Joint - Front		1683330127; 1683330227
SSP2305	301191623050	Suspension Stabilizer Bar Link - Front	Metal L=220mm	1683200589; 1683201089
SSP2306	301191623060	Suspension Stabilizer Bar Link - Front	Plastic L=223mm	1683200389

MERCEDES A SERIES W169



09/2004-06/2012

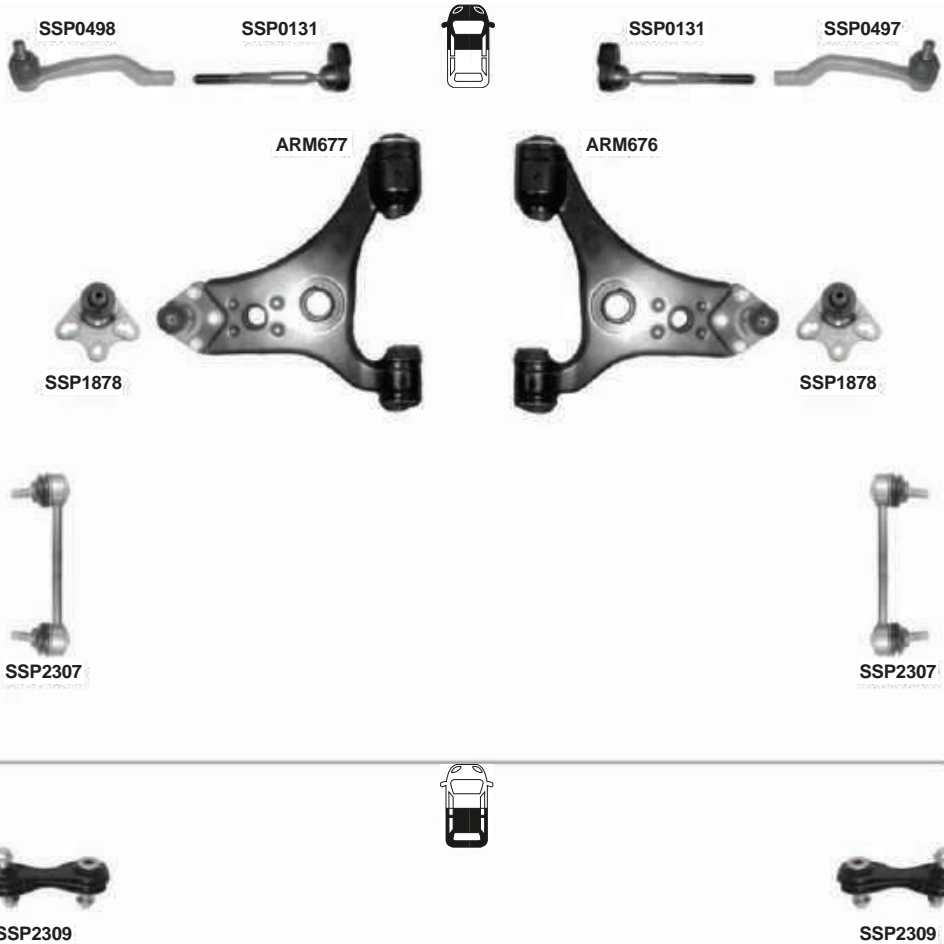

PART NO.	DESCRIPTION	NOTES	O.E.
ARM676	Suspension Control Arm and Ball Joint Assembly - Front Right Lower		1693300607; 1693301007
ARM677	Suspension Control Arm and Ball Joint Assembly - Front Left Lower		1693300507; 1693300907
SSP0131	Steering Tie Rod - Front	Ch:-> J126738 M14x1,5 - L=201,5mm	1693300403; 1693300703
SSP0497	Steering Tie Rod End - Front Right	M14x1,5	1693300603
SSP0498	Steering Tie Rod End - Front Left	M14x1,5	1693300503
SSP1878	Suspension Ball Joint - Front		1693330127
SSP2307	Suspension Stabilizer Bar Link - Front	L=244mm	1693200989
SSP2309	Suspension Stabilizer Bar Link - Rear		1693200589

**MERCEDES A SERIES W176**

06/2012-

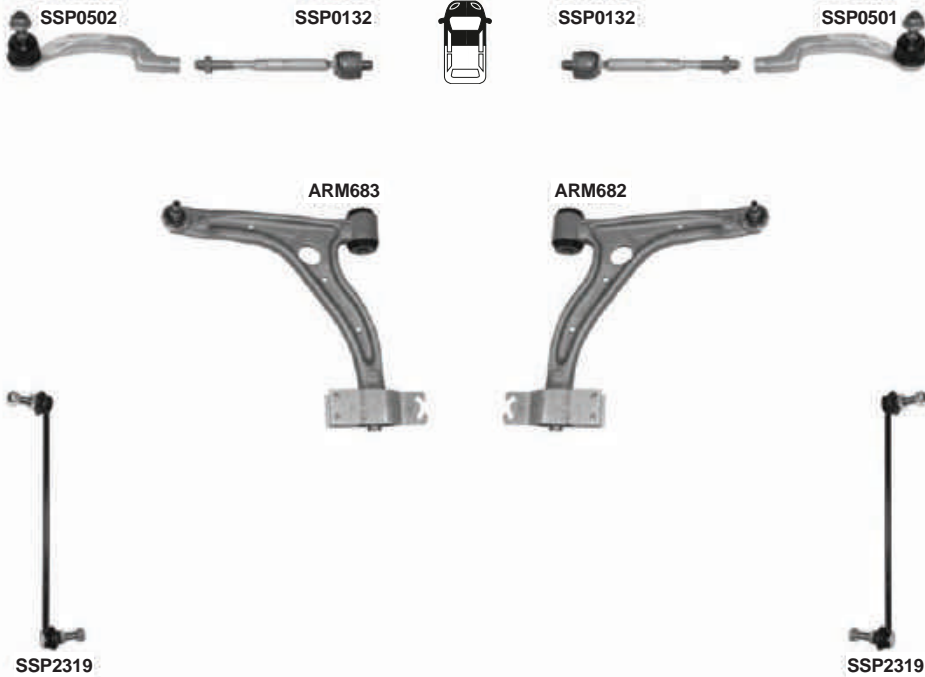

PART NO.	DESCRIPTION	NOTES	O.E.
ARM680	301181368000 Lateral Arm - Rear		2463500053; A2463500053
ARM681	301181368100 Lateral Arm - Rear Upper		2463501006; A2463501006
ARM682	301181368200 Suspension Control Arm and Ball Joint Assembly - Front Right Lower	Alm.	2463301807; 2463304800
ARM683	301181368300 Suspension Control Arm and Ball Joint Assembly - Front Left	Alm.	2463301707; 2463304700
SSP0132	301191601320 Steering Tie Rod - Front	M14X1,5 - L=222mm	2463380000; A2463380000
SSP0501	301191605010 Steering Tie Rod End - Front Right	M14X1,5	2463301800
SSP0502	301191605020 Steering Tie Rod End - Front Left	M14X1,5	2463301700
SSP2318	301191623180 Suspension Stabilizer Bar Link - Rear	L=79mm	2463200489
SSP2319	301191623190 Suspension Stabilizer Bar Link - Front	L=333mm	2463200089*

MERCEDES B SERIES W245



03/2005-11/2011

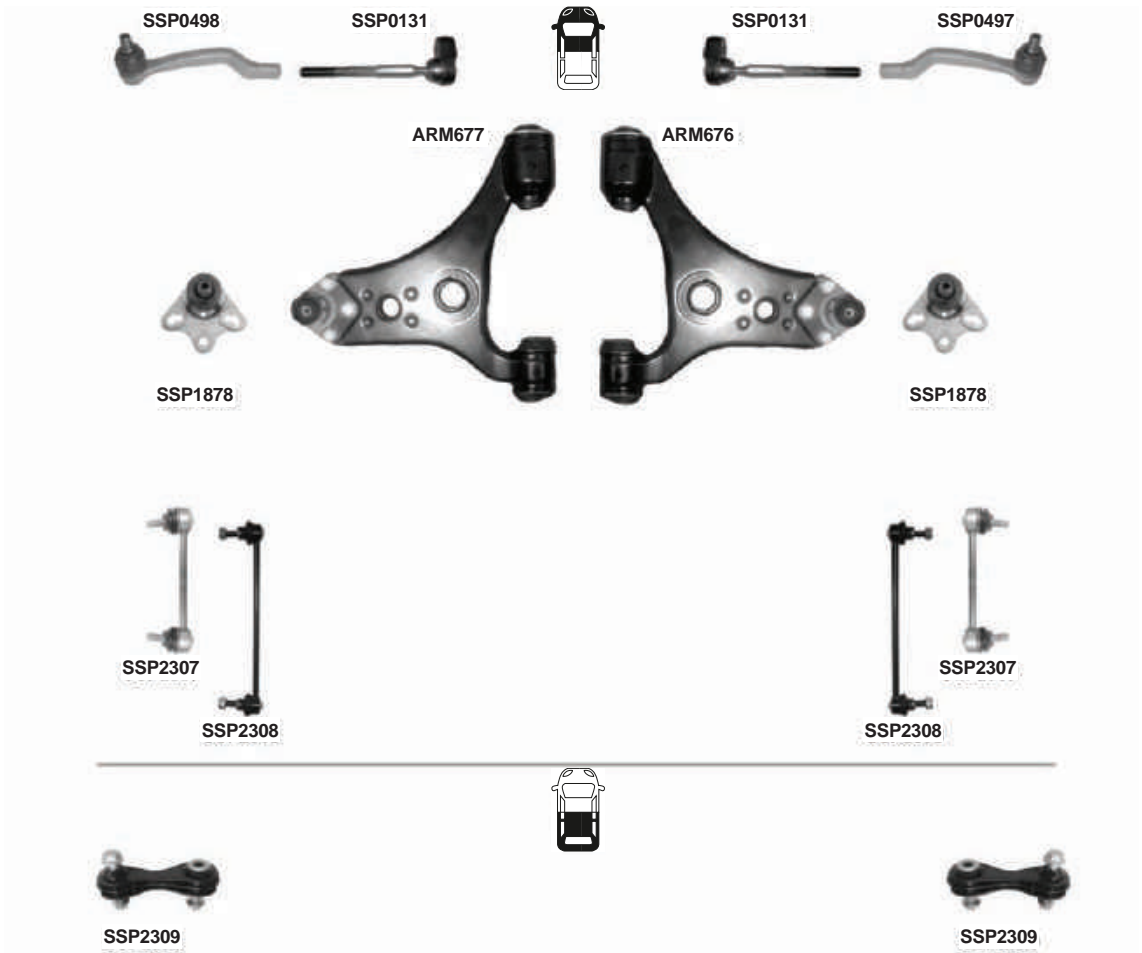

PART NO.	DESCRIPTION	NOTES	O.E.
ARM676	301181367600 Suspension Control Arm and Ball Joint Assembly - Front Right Lower		1693300607; 1693301007
ARM677	301181367700 Suspension Control Arm and Ball Joint Assembly - Front Left Lower		1693300507; 1693300907
SSP0131	301191601310 Steering Tie Rod - Front	Ch:-> J126738 M14x1,5 - L=201,5mm	1693300403; 1693300703
SSP0497	301191604970 Steering Tie Rod End - Front Right	M14x1,5	1693300603
SSP0498	301191604980 Steering Tie Rod End - Front Left	M14x1,5	1693300503
SSP1878	301191618780 Suspension Ball Joint - Front		1693330127
SSP2307	301191623070 Suspension Stabilizer Bar Link - Front	L=244mm	1693200989
SSP2308	301191623080 Suspension Stabilizer Bar Link - Front	Metal.Desing - Ch.1J210987 -> L=244,5mm	1693201389*
SSP2309	301191623090 Suspension Stabilizer Bar Link - Rear		1693200589



MERCEDES B SERIES W246



11/2011-2016

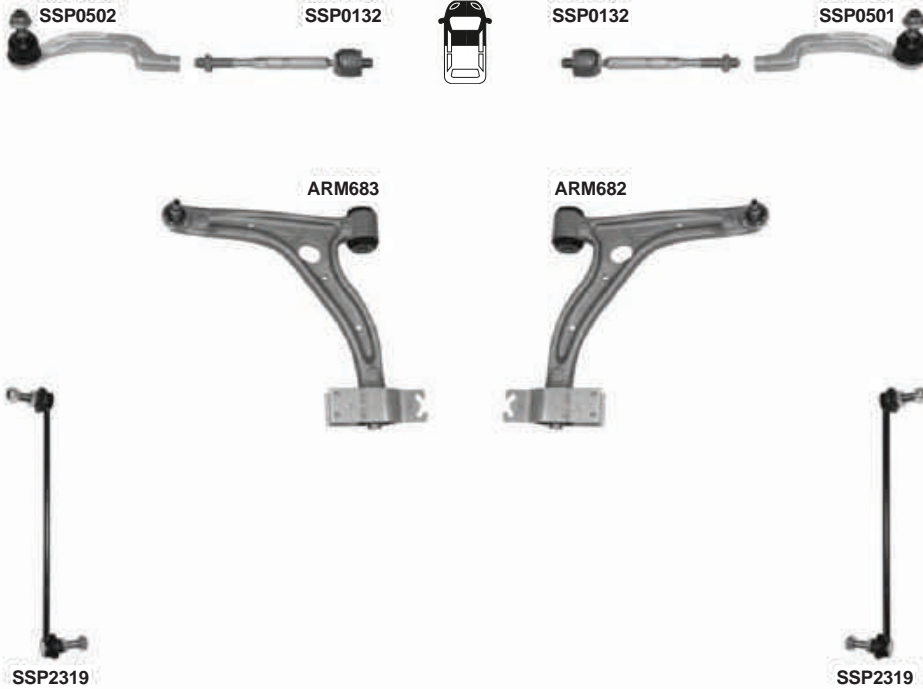

PART NO.	DESCRIPTION	NOTES	O.E.
ARM682 301181368200	Suspension Control Arm and Ball Joint Assembly - Front Right Lower	Alm.	2463301807; 2463304800
ARM683 301181368300	Suspension Control Arm and Ball Joint Assembly - Front Left	Alm.	2463301707; 2463304700
SSP0132 301191601320	Steering Tie Rod - Front	M14X1,5 - L=222mm	2463380000; A2463380000
SSP0501 301191605010	Steering Tie Rod End - Front Right	M14X1,5	2463301800
SSP0502 301191605020	Steering Tie Rod End - Front Left	M14X1,5	2463301700
SSP2318 301191623180	Suspension Stabilizer Bar Link - Rear	L=79mm	2463200489
SSP2319 301191623190	Suspension Stabilizer Bar Link - Front	L=333mm	2463200089*



MERCEDES C SERIES W202



1993-2000





MERCEDES C SERIES W202



1993-2000

	PART NO.	DESCRIPTION	NOTES	O.E.
ARM654	301181365400	Suspension Control Arm and Ball Joint Assembly - Front Right Upper		2023304907; 2103308807; 2083301407; 2103305107
ARM655	301181365500	Suspension Control Arm and Ball Joint Assembly - Front Left Upper		2083301307; 2103505007; 2103304807; 2103308707
ARM666	301181366600	Lateral Arm - Rear Lower Rearward		2013500653; 2103500653; 2013503253; 2013502753; 2013503153
ARM667	301181366700	Lateral Arm - Rear Right Upper		1243507706; 2103501706
ARM668	301181366800	Suspension Control Arm Kit - Rear Right Upper		1243507706*
ARM669	301181366900	Lateral Arm - Rear Left Upper		1243507606; 2103501606
ARM670	301181367000	Suspension Control Arm Kit - Rear Left Upper		1243507606*
ARM671	301181367100	Lateral Arm - Rear Upper Forward	Rear Axle Short	2013504706; 2013505606
ARM672	301181367200	Lateral Arm - Rear Lower Forward		1243500129; 2103500029
ARM673	301181367300	Suspension Control Arm Kit - Rear		1243500129*
SSP0480	301191604800	Steering Tie Rod End - Front	M12x1,5Rht	13307435; 13307735
SSP1874	301191618740	Suspension Ball Joint - Front Lower		2023330027; 2113300335; 2103300035; 2103300435
SSP1875	301191618750	Suspension Ball Joint - Front		Part of 2023304907



MERCEDES C SERIES W203



05/2000-02/2007

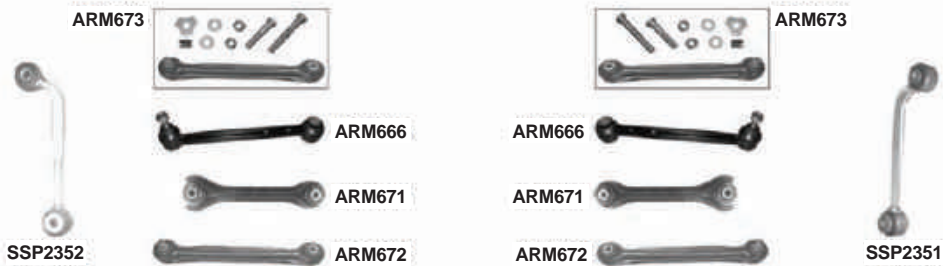
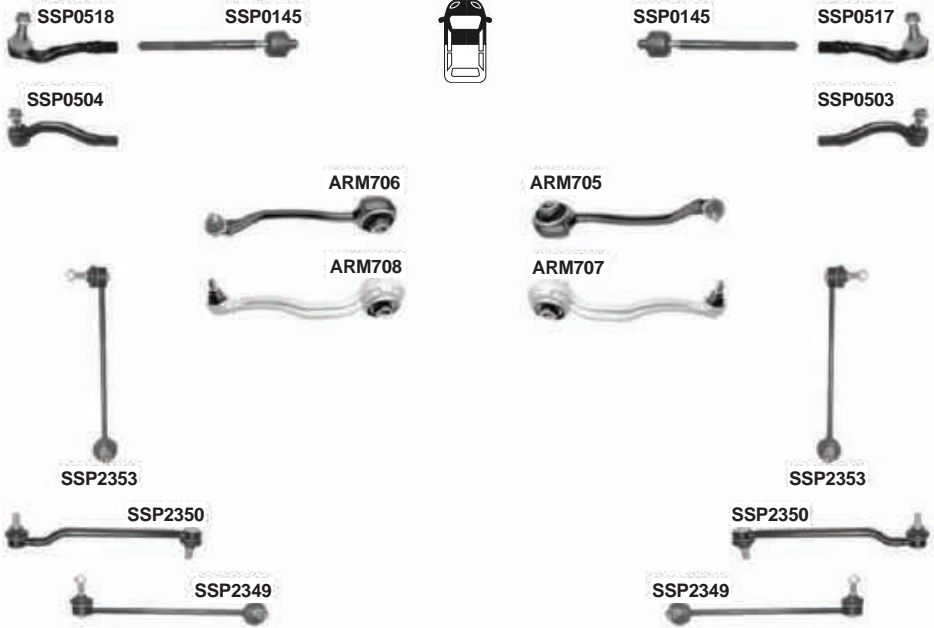

**MERCEDES C SERIES W203****05/2000-02/2007**

	PART NO.	DESCRIPTION	NOTES	O.E.
ARM666	301181366600	Lateral Arm - Rear Lower Rearward		2013500653; 2103500653; 2013503253; 2013502753; 2013503153
ARM667	301181366700	Lateral Arm - Rear Right Upper		1243507706; 2103501706
ARM668	301181366800	Suspension Control Arm Kit - Rear Right Upper		1243507706*
ARM669	301181366900	Lateral Arm - Rear Left Upper		1243507606; 2103501606
ARM670	301181367000	Suspension Control Arm Kit - Rear Left Upper		1243507606*
ARM671	301181367100	Lateral Arm - Rear Upper Forward	Rear Axle Short	2013504706; 2013505606
ARM672	301181367200	Lateral Arm - Rear Lower Forward		1243500129; 2103500029
ARM673	301181367300	Suspension Control Arm Kit - Rear		1243500129*
ARM705	301181370500	Suspension Control Arm and Ball Joint Assembly - Front Left Lower		2033301911; 2033303311
ARM706	301181370600	Suspension Control Arm and Ball Joint Assembly - Front Right Lower		2033302011; 2033303411
ARM707	301181370700	Suspension Control Arm and Ball Joint Assembly - Front Right Upper		2033300211; 2043304411; 2033304011; 2033301711; 2033303611
ARM708	301181370800	Suspension Control Arm and Ball Joint Assembly - Front Left Upper		2033300111; 2043304311; 2033303911; 2033301611; 2033303511
SSP0145	301191601450	Steering Tie Rod - Front Inner	M14x1,5 - L=243mm	2203380715; 2303380015
SSP0503	301191605030	Steering Tie Rod End - Front Right	(4-Matic - 4x4) M14x1,5Rht	2033303403
SSP0504	301191605040	Steering Tie Rod End - Front Left	(4-Matic - 4x4) M14x1,5Rht	2033303303
SSP0517	301191605170	Steering Tie Rod End - Front Right Outer	M14x1,5Rht	2033302003; 2033302403
SSP0518	301191605180	Steering Tie Rod End - Front Left Outer	M14x1,5Rht	2033301903; 2033302303
SSP2349	301191623490	Suspension Stabilizer Bar Link - Front	Only : C230 L=277mm	2033202689; 2033202989
SSP2350	301191623500	Suspension Stabilizer Bar Link - Front	Only 4-matic L=290mm	2033201889; 2033203089
SSP2351	301191623510	Suspension Stabilizer Bar Link - Rear Right	L=188mm	2033200889
SSP2352	301191623520	Suspension Stabilizer Bar Link - Rear Left	L=188 mm	2033200789
SSP2353	301191623530	Suspension Stabilizer Bar Link - Front	Only: X,Elojon sport L=276mm	2033202489; 2033202589; 2033202889



MERCEDES C SERIES W204



10/2007-11/2013

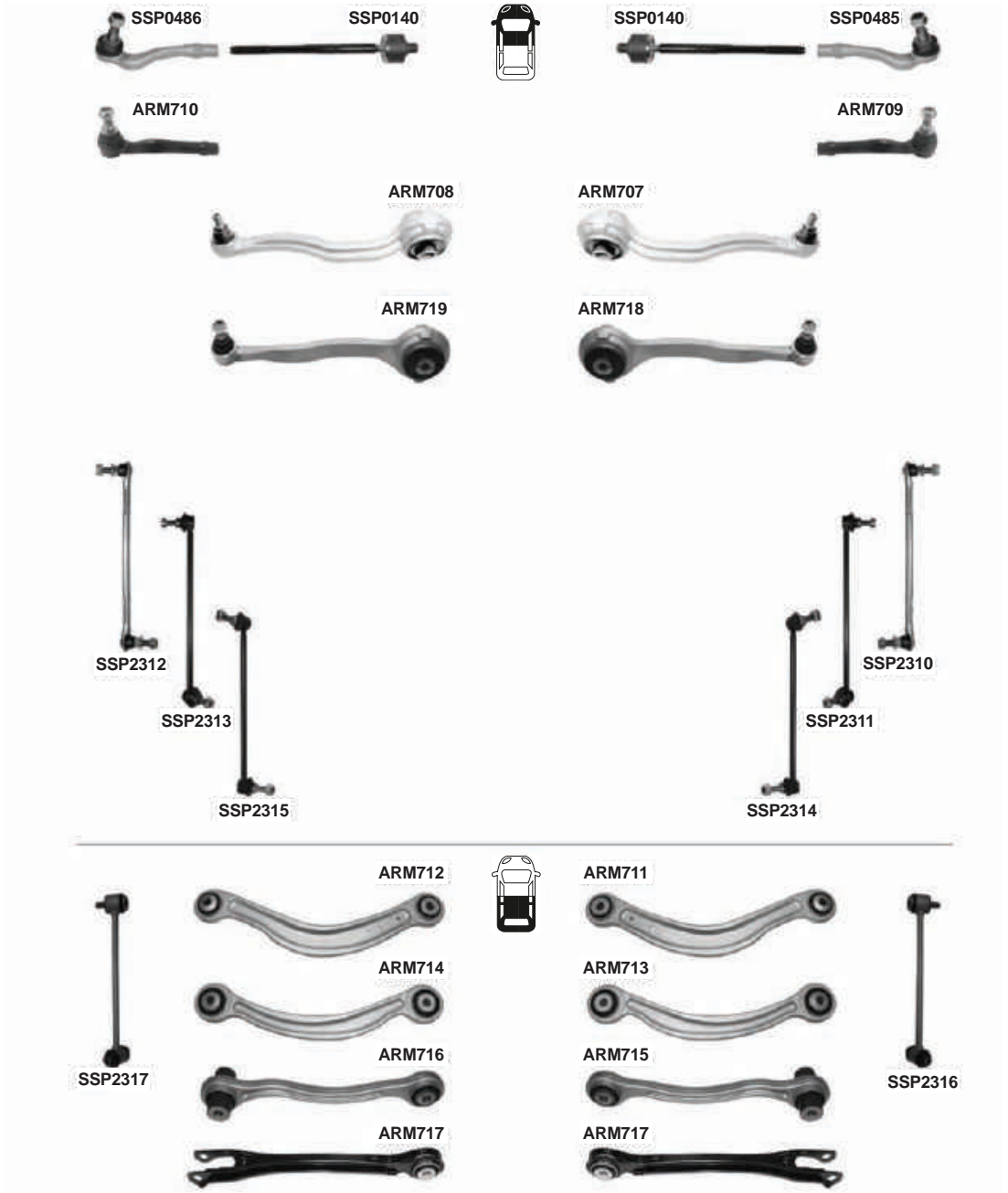

**MERCEDES C SERIES W204**

10/2007-11/2013

	PART NO.	DESCRIPTION	NOTES	O.E.
ARM678	301181367800	Suspension Control Arm and Ball Joint Assembly - Front Right Forward	Aluminium without 4matic, hydromount SB	2043304411
ARM679	301181367900	Suspension Control Arm and Ball Joint Assembly - Front Left Forward	Aluminium, without 4matic, hydromount SB	2043304311
ARM707	301181370700	Suspension Control Arm and Ball Joint Assembly - Front Right Upper		2033300211; 2043304411; 2033304011; 2033301711; 2033303611
ARM708	301181370800	Suspension Control Arm and Ball Joint Assembly - Front Left Upper		2033300111; 2043304311; 2033303911; 2033301611; 2033303511
ARM709	301181370900	Suspension Control Arm and Ball Joint Assembly - Front Right Lower Rearward		2043303211; 2043306811
ARM710	301181371000	Suspension Control Arm and Ball Joint Assembly - Front Left Lower Rearward		2043303111; 2043306711
ARM711	301181371100	Lateral Arm - Rear Right Upper		2043501606; 2043503106
ARM712	301181371200	Lateral Arm - Rear Left Upper		2043501506; 2043503006
ARM713	301181371300	Lateral Arm - Rear Right		2043502206
ARM714	301181371400	Lateral Arm - Rear Left		2043502106
ARM715	301181371500	Lateral Arm - Rear Right Lower		2043500653
ARM716	301181371600	Lateral Arm - Rear Left Lower		2043500553
ARM717	301181371700	Lateral Arm - Rear Lower		2043500029; A2053506303; 2053506303; 2043502706
ARM718	301181371800	Suspension Control Arm and Ball Joint Assembly - Front Right Upper	(HYDRO TYPE)	2043308811
ARM719	301181371900	Suspension Control Arm and Ball Joint Assembly - Front Left Upper	(HYDRO TYPE)	2043308711
SSP0128	301191601280	Steering Tie Rod - Front	Power Steering	2073300500
SSP0140	301191601400	Steering Tie Rod - Front Inner	M14x1,5 - L=275.5mm	2043380015
SSP0483	301191604830	Steering Tie Rod End - Front Right	4-Matic M14X1,5	2043303403
SSP0484	301191604840	Steering Tie Rod End - Front Left	4-Matic M14X1,5	2043303303
SSP0485	301191604850	Steering Tie Rod End - Front Right Outer	M14X1,5	2043301003; A2043301003
SSP0486	301191604860	Steering Tie Rod End - Front Left Outer	M14X1,5	2043300903; A2043300903
SSP2310	301191623100	Suspension Stabilizer Bar Link - Front Right	Alm.Desing L=306mm	2043203889
SSP2311	301191623110	Suspension Stabilizer Bar Link - Front Right	Metal Desing L=306mm	2043203889*
SSP2312	301191623120	Suspension Stabilizer Bar Link - Front Left	Alm.Desing L=306mm	2043203789
SSP2313	301191623130	Suspension Stabilizer Bar Link - Front Left	Metal Desing L=306mm	2043203789*
SSP2314	301191623140	Suspension Stabilizer Bar Link - Front Right	Only: Spor susp. Metal Design L=306mm	2043201889
SSP2315	301191623150	Suspension Stabilizer Bar Link - Front Left	Only: Spor susp. Metal Design L=306mm	2043201789
SSP2316	301191623160	Suspension Stabilizer Bar Link - Rear Right	L=232mm	2043200489
SSP2317	301191623170	Suspension Stabilizer Bar Link - Rear Left	L=232mm	2043200589



MERCEDES C SERIES W205 RWD 12/2013-





MERCEDES C SERIES W205 RWD 12/2013-

PART NO.	DESCRIPTION	NOTES	O.E.
ARM713	301181371300	Lateral Arm - Rear Right	2043502206
ARM714	301181371400	Lateral Arm - Rear Left	2043502106
ARM717	301181371700	Lateral Arm - Rear Lower	2043500029; A2053506303; 2053506303; 2043502706
ARM786	301181378600	Suspension Control Arm and Ball Joint Assembly - Front Right Upper	Aluminium / RWD 2053305601; A2053305601
ARM787	301181378700	Suspension Control Arm and Ball Joint Assembly - Front Left Upper	Aluminium / RWD 2053305501; A2053305501
ARM788	301181378800	Suspension Control Arm and Ball Joint Assembly - Front Right Lower Forward	Aluminium 2053301405; 2053301605
ARM789	301181378900	Suspension Control Arm and Ball Joint Assembly - Front Left Lower Forward	Aluminium 2053301305; 2053301505
ARM790	301181379000	Suspension Control Arm and Ball Joint Assembly - Front Right Lower Rearward	RWD 2053306001; A2053306001
ARM791	301181379100	Suspension Control Arm and Ball Joint Assembly - Front Left Lower Rearward	RWD 2053305901; A2053305901
SSP0142	301191601420	Steering Tie Rod - Front	M14x1.5 - L=245mm 2054600805; A2054600805
SSP0521	301191605210	Steering Tie Rod End - Front Right	M14x1.5 2054600705; A2054600705
SSP0522	301191605220	Steering Tie Rod End - Front Left	M14x1.5 2054600605; A2054600605
SSP2357	301191623570	Suspension Stabilizer Bar Link - Front Right	2053230817; A2053230817
SSP2358	301191623580	Suspension Stabilizer Bar Link - Front Left	2053230717; A2053230717
SSP2359	301191623590	Suspension Stabilizer Bar Link - Rear Right	2053260417; A2053260417
SSP2360	301191623600	Suspension Stabilizer Bar Link - Rear Left	2053260317; A2053260317



MERCEDES C SERIES W205 AWD 12/2013-



SSP2356



SSP2355

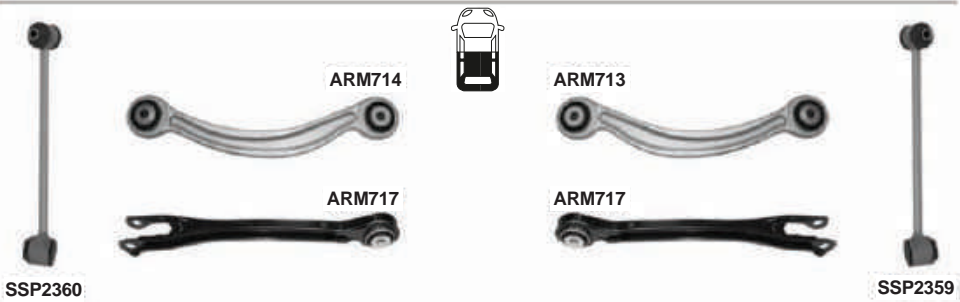



MERCEDES C SERIES W205 AWD 12/2013-

PART NO.	DESCRIPTION	NOTES	O.E.
ARM713	301181371300	Lateral Arm - Rear Right	2043502206
ARM714	301181371400	Lateral Arm - Rear Left	2043502106
ARM717	301181371700	Lateral Arm - Rear Lower	2043500029; A2053506303; 2053506303; 2043502706
ARM720	301181372000	Suspension Control Arm and Ball Joint Assembly - Front Lower	2053305801
SSP0141	301191601410	Steering Tie Rod - Front	M14x1.5 - L=243mm 2054600405; A2054600405
SSP0519	301191605190	Steering Tie Rod End - Front Right	M14x1.5 2054600105; A2054600105
SSP0520	301191605200	Steering Tie Rod End - Front Left	M14x1.5 2054600005; A2054600005
SSP2355	301191623550	Suspension Stabilizer Bar Link - Front Right	L=307,5mm / M12x1,5 2053231017; A2053231017
SSP2356	301191623560	Suspension Stabilizer Bar Link - Front Left	L=307,5mm / M12x1,5 2053230917; A2053230917
SSP2359	301191623590	Suspension Stabilizer Bar Link - Rear Right	2053260417; A2053260417
SSP2360	301191623600	Suspension Stabilizer Bar Link - Rear Left	2053260317; A2053260317



MERCEDES CITAN 415



11/2012-

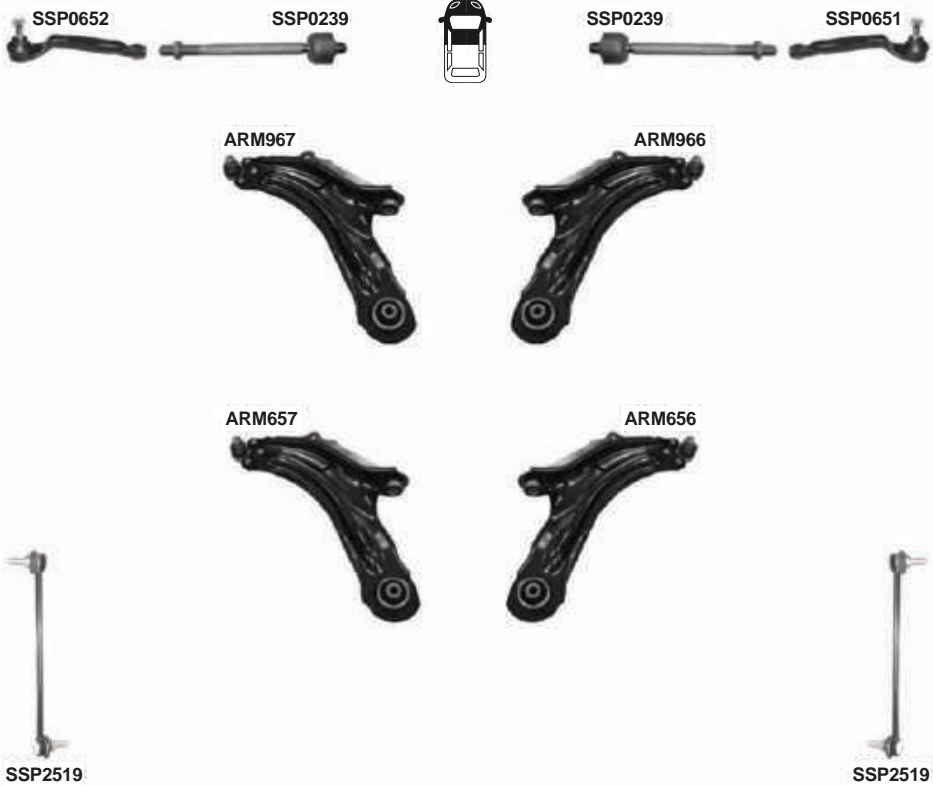

PART NO.	DESCRIPTION	NOTES	O.E.
ARM656	301181365600 Suspension Control Arm and Ball Joint Assembly - Front Right		4153300200; A4153300200
ARM657	301181365700 Suspension Control Arm and Ball Joint Assembly - Front Left		4153300300; A4153300300
ARM966	301181396600 Suspension Control Arm and Ball Joint Assembly - Front Right Lower		8200586567
ARM967	301181396700 Suspension Control Arm and Ball Joint Assembly - Front Left Lower		8200586561
SSP0239	301191602390 Steering Tie Rod - Front	M14x1,5 - L=210mm	4154600000; A4154600000; 7701478406; 485215612R
SSP0651	301191606510 Steering Tie Rod End - Front Right	M14x1,5	4154600105; A4154600105; 7701478408
SSP0652	301191606520 Steering Tie Rod End - Front Left	M14x1,5	4154600005; A4154600005; 7701478407
SSP2519	301191625190 Suspension Stabilizer Bar Link - Front	L=283mm	4153200189; A4153200189; 8200669065; 8200166159



MERCEDES CL SERIES C215



03/1999-03/2006

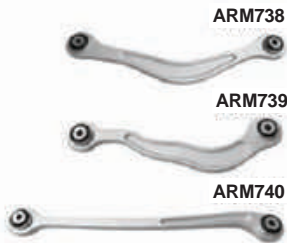

PART NO.	DESCRIPTION	NOTES	O.E.
ARM738	301181373800 Lateral Arm - Rear Upper Rearward		2203502206; 2203521105
ARM739	301181373900 Lateral Arm - Rear Upper Forward		2203502406; A2203521005
ARM740	301181374000 Lateral Arm - Rear Lower Forward		2203502606; A2203520502
ARM741	301181374100 Suspension Control Arm and Ball Joint Assembly - Front Right Lower Forward	Front Lower	2203301711; 2203330405; 2203305711; 2203304311
ARM742	301181374200 Suspension Control Arm and Ball Joint Assembly - Front Left Lower Forward	Front Lower	2203301811; 2203330505; 2203305811; 2203304411
ARM749	301181374900 Suspension Control Arm and Ball Joint Assembly - Front Right Upper		2203301507; 2203309407; 2203308407
ARM750	301181375000 Suspension Control Arm and Ball Joint Assembly - Front Left Upper		2203301407; 2203309307; 2203308307
SSP0145	301191601450 Steering Tie Rod - Front Inner	M14x1,5 - L=243mm	2203380715; 2303380015
SSP0529	301191605290 Steering Tie Rod End - Front	M14x1,5Rht	2203380115; 2303380115; 2303300403; 2303300203; 2203380515
SSP1891	301191618910 Suspension Ball Joint - Front Lower		2113300235; 2203330427; 2203330127; 2203300727; 2113300435
SSP2304	301191623040 Suspension Stabilizer Bar Link - Rear	Plastic L=230mm	1403200889; 1403203589
SSP2369	301191623690 Suspension Stabilizer Bar Link - Rear	Metal L=230mm	2203203689
SSP2371	301191623710 Suspension Stabilizer Bar Link - Front Right	L=128,5mm	2203201689; A2203201689
SSP2372	301191623720 Suspension Stabilizer Bar Link - Front Left	L=128,5mm	2203201589; A2203201589



MERCEDES CLA SERIES W176



06/2012-



**MERCEDES CLA SERIES W176**

06/2012-

PART NO.	DESCRIPTION	NOTES	O.E.
ARM680	301181368000 Lateral Arm - Rear		2463500053; A2463500053
ARM681	301181368100 Lateral Arm - Rear Upper		2463501006; A2463501006
ARM682	301181368200 Suspension Control Arm and Ball Joint Assembly - Front Right Lower	Alm.	2463301807; 2463304800
ARM683	301181368300 Suspension Control Arm and Ball Joint Assembly - Front Left	Alm.	2463301707; 2463304700
SSP0132	301191601320 Steering Tie Rod - Front	M14X1,5 - L=222mm	2463380000; A2463380000
SSP0501	301191605010 Steering Tie Rod End - Front Right	M14X1,5	2463301800
SSP0502	301191605020 Steering Tie Rod End - Front Left	M14X1,5	2463301700
SSP2318	301191623180 Suspension Stabilizer Bar Link - Rear	L=79mm	2463200489
SSP2319	301191623190 Suspension Stabilizer Bar Link - Front	L=333mm	2463200089*



MERCEDES CLK SERIES A209-C209  06/2002-05/2009

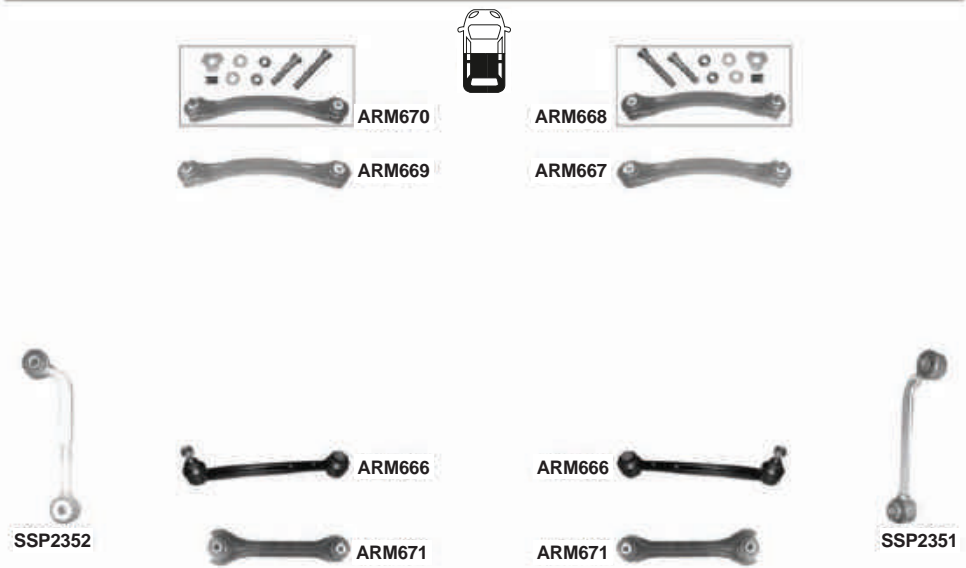
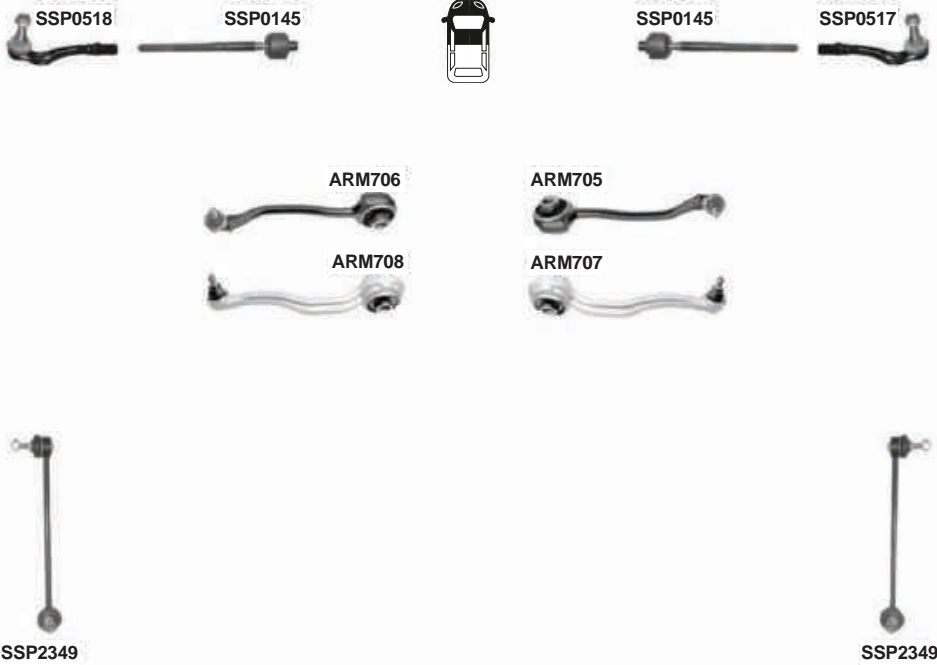



MERCEDES CLK SERIES A209-C209 06/2002-05/2009

PART NO.	DESCRIPTION	NOTES	O.E.
ARM666	301181366600 Lateral Arm - Rear Lower Rearward		2013500653; 2103500653; 2013503253; 2013502753; 2013503153
ARM667	301181366700 Lateral Arm - Rear Right Upper		1243507706; 2103501706
ARM668	301181366800 Suspension Control Arm Kit - Rear Right Upper		1243507706*
ARM669	301181366900 Lateral Arm - Rear Left Upper		1243507606; 2103501606
ARM670	301181367000 Suspension Control Arm Kit - Rear Left Upper		1243507606*
ARM671	301181367100 Lateral Arm - Rear Upper Forward	Rear Axle Short	2013504706; 2013505606
ARM705	301181370500 Suspension Control Arm and Ball Joint Assembly - Front Left Lower		2033301911; 2033303311
ARM706	301181370600 Suspension Control Arm and Ball Joint Assembly - Front Right Lower		2033302011; 2033303411
ARM707	301181370700 Suspension Control Arm and Ball Joint Assembly - Front Right Upper		2033300211; 2043304411; 2033304011; 2033301711; 2033303611
ARM708	301181370800 Suspension Control Arm and Ball Joint Assembly - Front Left Upper		2033300111; 2043304311; 2033303911; 2033301611; 2033303511
SSP0145	301191601450 Steering Tie Rod - Front Inner	M14x1,5 - L=243mm	2203380715; 2303380015
SSP0517	301191605170 Steering Tie Rod End - Front Right Outer	M14x1,5Rht	2033302003; 2033302403
SSP0518	301191605180 Steering Tie Rod End - Front Left Outer	M14x1,5Rht	2033301903; 2033302303
SSP2349	301191623490 Suspension Stabilizer Bar Link - Front	Only : C230 L=277mm	2033202689; 2033202989
SSP2351	301191623510 Suspension Stabilizer Bar Link - Rear Right	L=188mm	2033200889
SSP2352	301191623520 Suspension Stabilizer Bar Link - Rear Left	L=188 mm	2033200789



MERCEDES CLS SERIES C219 RWD  10/2004-12/2010

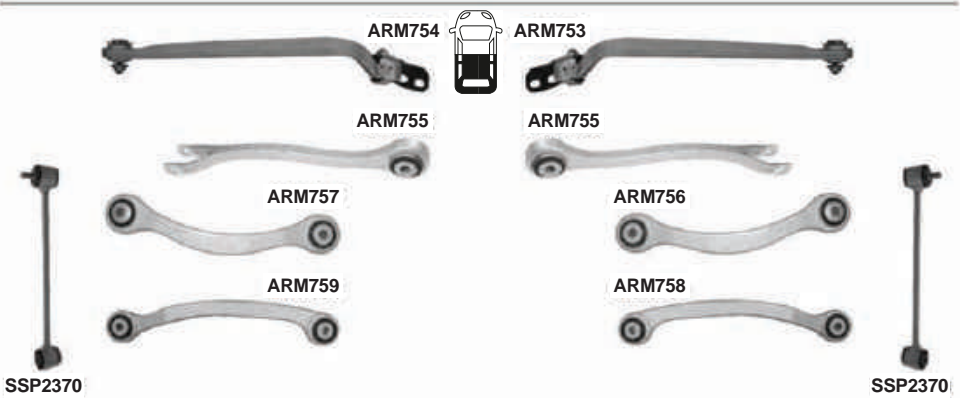
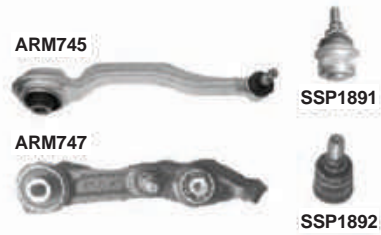
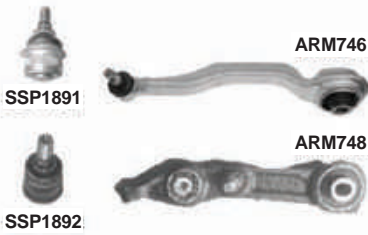



MERCEDES CLS SERIES C219 RWD 10/2004-12/2010

	PART NO.	DESCRIPTION	NOTES	O.E.
ARM745	301181374500	Suspension Control Arm and Ball Joint Assembly - Front Left Lower Forward		2113301111; 2113304311; 2303301711; 2113302911; 2113301511
ARM746	301181374600	Suspension Control Arm and Ball Joint Assembly - Front Right Lower Forward		2113301211; 2113304411; 2303301811; 2113303011; 2113301611
ARM747	301181374700	Suspension Control Arm and Ball Joint Assembly - Front Left Lower Rearward		2113308107; 2113309107
ARM748	301181374800	Suspension Control Arm and Ball Joint Assembly - Front Right Lower Rearward		2113308207; 2113309207
ARM751	301181375100	Suspension Control Arm and Ball Joint Assembly - Front Right Lower		2113304407; 2113306807; 2113309007
ARM752	301181375200	Suspension Control Arm and Ball Joint Assembly - Front Left Lower		2113304307; 2113306707; 2113308907
ARM753	301181375300	Lateral Arm - Rear Right	L=440mm	2303500429
ARM754	301181375400	Lateral Arm - Rear Left	L=440mm	2303500329
ARM755	301181375500	Lateral Arm - Rear Lower	L=368mm	2303502006
ARM756	301181375600	Lateral Arm - Rear Right Upper Forward	L=262mm	2303503606
ARM757	301181375700	Lateral Arm - Rear Left Upper Forward	L=262mm	2303503506
ARM758	301181375800	Lateral Arm - Rear Right Upper Rearward	L=324,5mm	2303502806
ARM759	301181375900	Lateral Arm - Rear Left Upper Rearward	L=324,5mm	2303502706
SSP0530	301191605300	Steering Tie Rod End - Front Right	M14x1,5Rht	2113300203; 2113302403
SSP0531	301191605310	Steering Tie Rod End - Front Left	M14x1,5Rht	2113300103; 2113302303
SSP1891	301191618910	Suspension Ball Joint - Front Lower		2113300235; 2203330427; 2203330127; 2203300727; 2113300435
SSP1892	301191618920	Suspension Ball Joint - Front Lower		2113230068; 2203230368
SSP1893	301191618930	Suspension Ball Joint - Front		2113300427; 2113330227; 2113309907; 2113310008
SSP2370	301191623700	Suspension Stabilizer Bar Link - Rear	L=259,5mm	2113200889; 2113203389
SSP2373	301191623730	Suspension Stabilizer Bar Link - Front Right	L=128,5mm	2113201089
SSP2374	301191623740	Suspension Stabilizer Bar Link - Front Left	L=128,5mm	2113200989



PART NO.	DESCRIPTION	NOTES	O.E.
ARM662 301181366200	Suspension Control Arm and Ball Joint Assembly - Front Lower Rearward	(4-matic Elec. PS. with ASD)	2123301911
SSP2294 301191622940	Suspension Stabilizer Bar Link - Front Right	Steel Type 4Matic	2123202689
SSP2295 301191622950	Suspension Stabilizer Bar Link - Front Left	Steel Type 4matic	2123202589

**MERCEDES E SERIES W124**

1985-1996

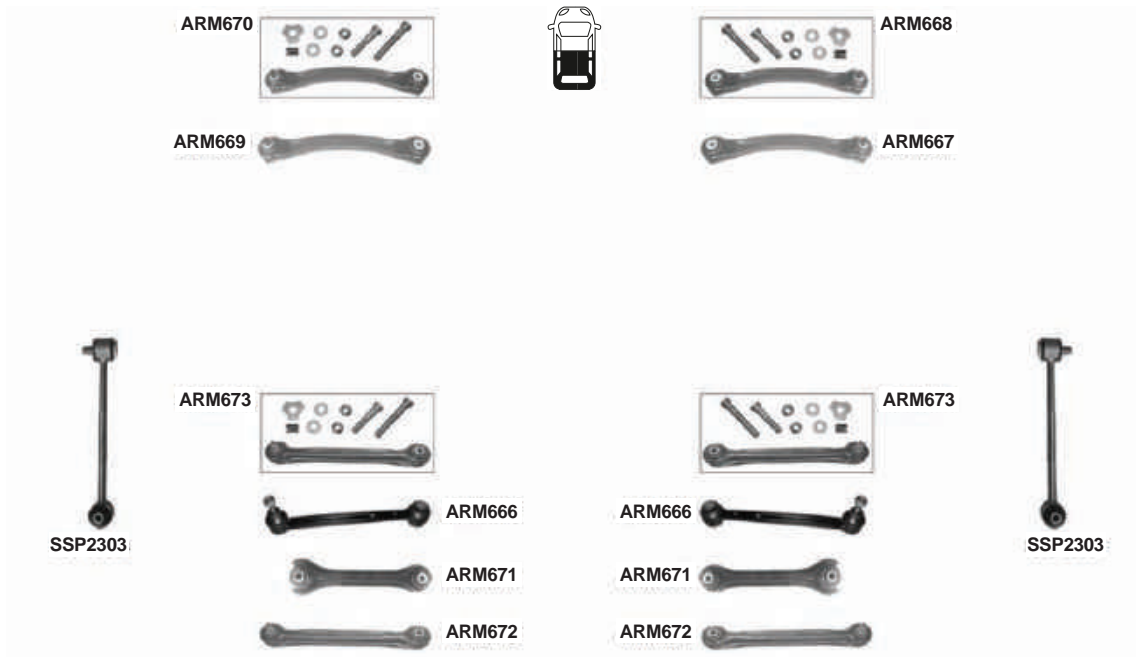

PART NO.	DESCRIPTION	NOTES	O.E.
ARM666	301181366600 Lateral Arm - Rear Lower Rearward		2013500653; 2103500653; 2013503253; 2013502753; 2013503153
ARM667	301181366700 Lateral Arm - Rear Right Upper		1243507706; 2103501706
ARM668	301181366800 Suspension Control Arm Kit - Rear Right Upper		1243507706*
ARM669	301181366900 Lateral Arm - Rear Left Upper		1243507606; 2103501606
ARM670	301181367000 Suspension Control Arm Kit - Rear Left Upper		1243507606*
ARM671	301181367100 Lateral Arm - Rear Upper Forward	Rear Axle Short	2013504706; 2013505606
ARM672	301181367200 Lateral Arm - Rear Lower Forward		1243500129; 2103500029
ARM673	301181367300 Suspension Control Arm Kit - Rear		1243500129*
SSP2303	301191623030 Suspension Stabilizer Bar Link - Rear	Metal L=200mm	1243200489



MERCEDES E SERIES W210



1995-2003

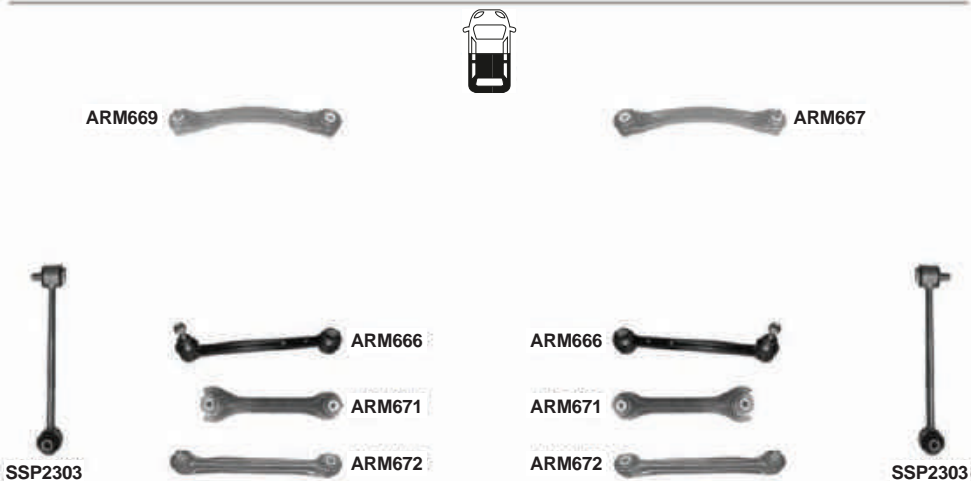
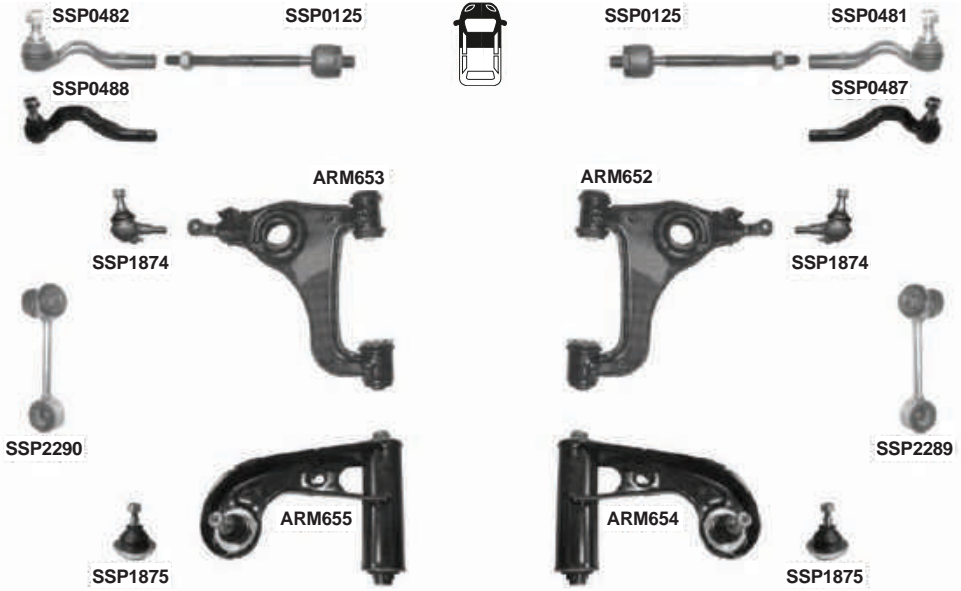



MERCEDES E SERIES W210



1995-2003

PART NO.	DESCRIPTION	NOTES	O.E.
ARM652	301181365200 Suspension Control Arm - Front Right Lower	Lower	2103303507; 2103309107; 2103307707; 2103304507; 2103306207
ARM653	301181365300 Suspension Control Arm - Front Left Lower	Lower	2103303407; 2103309007; 2103306107; 2103307607
ARM654	301181365400 Suspension Control Arm and Ball Joint Assembly - Front Right Upper		2023304907; 2103308807; 2083301407; 2103305107
ARM655	301181365500 Suspension Control Arm and Ball Joint Assembly - Front Left Upper		2083301307; 2103505007; 2103304807; 2103308707
ARM666	301181366600 Lateral Arm - Rear Lower Rearward		2013500653; 2103500653; 2013503253; 2013502753; 2013503153
ARM667	301181366700 Lateral Arm - Rear Right Upper		1243507706; 2103501706
ARM669	301181366900 Lateral Arm - Rear Left Upper		1243507606; 2103501606
ARM671	301181367100 Lateral Arm - Rear Upper Forward	Rear Axle Short	2013504706; 2013505606
ARM672	301181367200 Lateral Arm - Rear Lower Forward		1243500129; 2103500029
SSP0125	301191601250 Steering Tie Rod - Front	M14x1,5 - L=243mm	2103380415
SSP0481	301191604810 Steering Tie Rod End - Front Right Outer	M14x1,5Rht	2103380615
SSP0482	301191604820 Steering Tie Rod End - Front Left Outer	M14x1,5Rht	2103380515
SSP0487	301191604870 Steering Tie Rod End - Front Right	Only :4 - Matic M14x1.5	2103381015
SSP0488	301191604880 Steering Tie Rod End - Front Left	Only :4 - Matic M14x1.5	2103380915
SSP1874	301191618740 Suspension Ball Joint - Front Lower		2023330027; 2113300335; 2103300035; 2103300435
SSP1875	301191618750 Suspension Ball Joint - Front		Part of 2023304907
SSP2289	301191622890 Suspension Stabilizer Bar Link - Front Right	L=115mm	2103202289; 2103203789
SSP2290	301191622900 Suspension Stabilizer Bar Link - Front Left	L=115mm	2103202189; 2103203689
SSP2303	301191623030 Suspension Stabilizer Bar Link - Rear	Metal L=200mm	1243200489



MERCEDES E SERIES W211



03/2003-07/2009

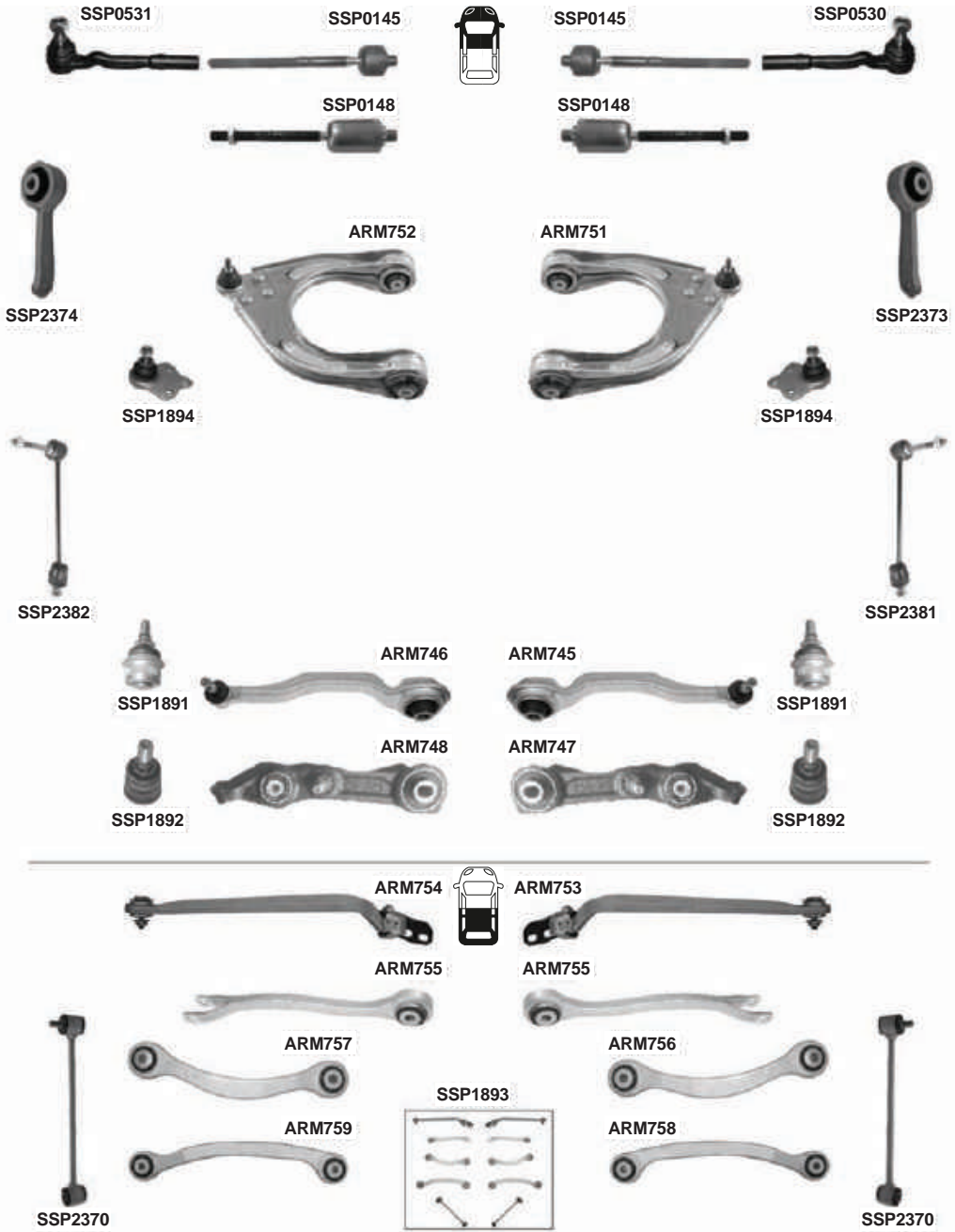

**MERCEDES E SERIES W211****03/2003-07/2009**

	PART NO.	DESCRIPTION	NOTES	O.E.
ARM745	301181374500	Suspension Control Arm and Ball Joint Assembly - Front Left Lower Forward		2113301111; 2113304311; 2303301711; 2113302911; 2113301511
ARM746	301181374600	Suspension Control Arm and Ball Joint Assembly - Front Right Lower Forward		2113301211; 2113304411; 2303301811; 2113303011; 2113301611
ARM747	301181374700	Suspension Control Arm and Ball Joint Assembly - Front Left Lower Rearward		2113308107; 2113309107
ARM748	301181374800	Suspension Control Arm and Ball Joint Assembly - Front Right Lower Rearward		2113308207; 2113309207
ARM751	301181375100	Suspension Control Arm and Ball Joint Assembly - Front Right Lower		2113304407; 2113306807; 2113309007
ARM752	301181375200	Suspension Control Arm and Ball Joint Assembly - Front Left Lower		2113304307; 2113306707; 2113308907
ARM753	301181375300	Lateral Arm - Rear Right	L=440mm	2303500429
ARM754	301181375400	Lateral Arm - Rear Left	L=440mm	2303500329
ARM755	301181375500	Lateral Arm - Rear Lower	L=368mm	2303502006
ARM756	301181375600	Lateral Arm - Rear Right Upper Forward	L=262mm	2303503606
ARM757	301181375700	Lateral Arm - Rear Left Upper Forward	L=262mm	2303503506
ARM758	301181375800	Lateral Arm - Rear Right Upper Rearward	L=324,5mm	2303502806
ARM759	301181375900	Lateral Arm - Rear Left Upper Rearward	L=324,5mm	2303502706
SSP0145	301191601450	Steering Tie Rod - Front Inner	M14x1,5 - L=243mm	2203380715; 2303380015
SSP0148	301191601480	Steering Tie Rod - Front	(Onyl: 4matic 4x4) M14x1,5	2113302903; 2113380015; A2113302903
SSP0530	301191605300	Steering Tie Rod End - Front Right	M14x1,5Rht	2113300203; 2113302403
SSP0531	301191605310	Steering Tie Rod End - Front Left	M14x1,5Rht	2113300103; 2113302303
SSP1891	301191618910	Suspension Ball Joint - Front Lower		2113300235; 2203330427; 2203330127; 2203300727; 2113300435
SSP1892	301191618920	Suspension Ball Joint - Front Lower		2113230068; 2203230368
SSP1893	301191618930	Suspension Ball Joint - Front		2113300427; 2113330227; 2113309907; 2113310008
SSP1894	301191618940	Suspension Ball Joint - Front Upper		A0003301007
SSP2370	301191623700	Suspension Stabilizer Bar Link - Rear	L=259,5mm	2113200889; 2113203389
SSP2373	301191623730	Suspension Stabilizer Bar Link - Front Right	L=128,5mm	2113201089
SSP2374	301191623740	Suspension Stabilizer Bar Link - Front Left	L=128,5mm	2113200989
SSP2381	301191623810	Suspension Stabilizer Bar Link - Front Right	4matic 4X4	2113204889
SSP2382	301191623820	Suspension Stabilizer Bar Link - Front Left	4matic 4X4	2113204789



MERCEDES E SERIES W212



01/2009-2016

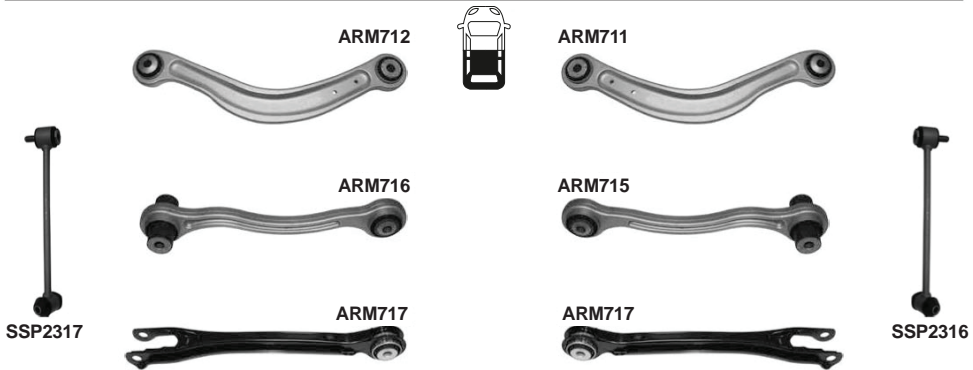
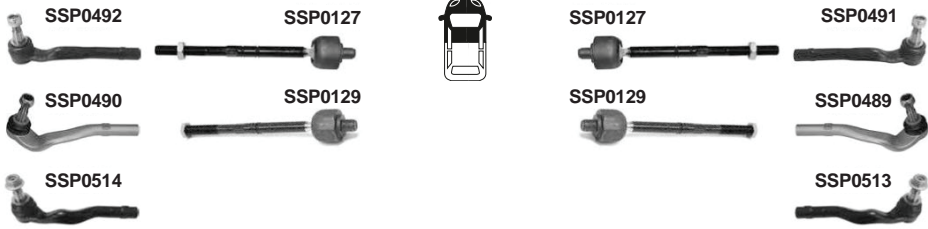

**MERCEDES E SERIES W212**

01/2009-2016

	PART NO.	DESCRIPTION	NOTES	O.E.
ARM658	301181365800	Suspension Control Arm and Ball Joint Assembly - Front Right Lower Forward		2123302811
ARM659	301181365900	Suspension Control Arm and Ball Joint Assembly - Front Left Lower Forward		2123302711
ARM660	301181366000	Suspension Control Arm - Front Right Lower Rearward		2123303011
ARM661	301181366100	Suspension Control Arm - Front Left Lower Rearward		2123302911
ARM711	301181371100	Lateral Arm - Rear Right Upper		2043501606; 2043503106
ARM712	301181371200	Lateral Arm - Rear Left Upper		2043501506; 2043503006
ARM715	301181371500	Lateral Arm - Rear Right Lower		2043500653
ARM716	301181371600	Lateral Arm - Rear Left Lower		2043500553
ARM717	301181371700	Lateral Arm - Rear Lower		2043500029; A2053506303; 2053506303; 2043502706
SSP0127	301191601270	Steering Tie Rod - Front Inner	M14X1,5 - L=237mm	2123302103
SSP0128	301191601280	Steering Tie Rod - Front	Power Steering	2073300500
SSP0129	301191601290	Steering Tie Rod - Front	(4-matic Elec. PS. with ASD)	2123302803; A2123302803
SSP0489	301191604890	Steering Tie Rod End - Front Right Outer	M14X1,5	2123302203
SSP0490	301191604900	Steering Tie Rod End - Front Left Outer	M14X1,5	2123302303
SSP0491	301191604910	Steering Tie Rod End - Front Right	(4Matic) 4X4, hydro ps M14X1,5	2123301403
SSP0492	301191604920	Steering Tie Rod End - Front Left	(4Matic) 4X4, hydro ps M14X1,5	2123301303
SSP0513	301191605130	Steering Tie Rod End - Front Right	(4Matic) 4X4, elec. ps M14X1,5	2123302703; 2124600205
SSP0514	301191605140	Steering Tie Rod End - Front Left	(4Matic) 4X4, elec. ps M14X1,5	2123302403; 2124600105
SSP1876	301191618760	Suspension Ball Joint - Front Lower		2123300035; 2123300135
SSP2292	301191622920	Suspension Stabilizer Bar Link - Front Right	(ALM) L=324mm	2123201289*
SSP2293	301191622930	Suspension Stabilizer Bar Link - Front Left	(ALM) L=324mm	2123201189*
SSP2294	301191622940	Suspension Stabilizer Bar Link - Front Right	Steel Type 4Matic	2123202689
SSP2295	301191622950	Suspension Stabilizer Bar Link - Front Left	Steel Type 4matic	2123202589
SSP2316	301191623160	Suspension Stabilizer Bar Link - Rear Right	L=232mm	2043200489
SSP2317	301191623170	Suspension Stabilizer Bar Link - Rear Left	L=232mm	2043200589



MERCEDES GL SERIES X164



2006-2012

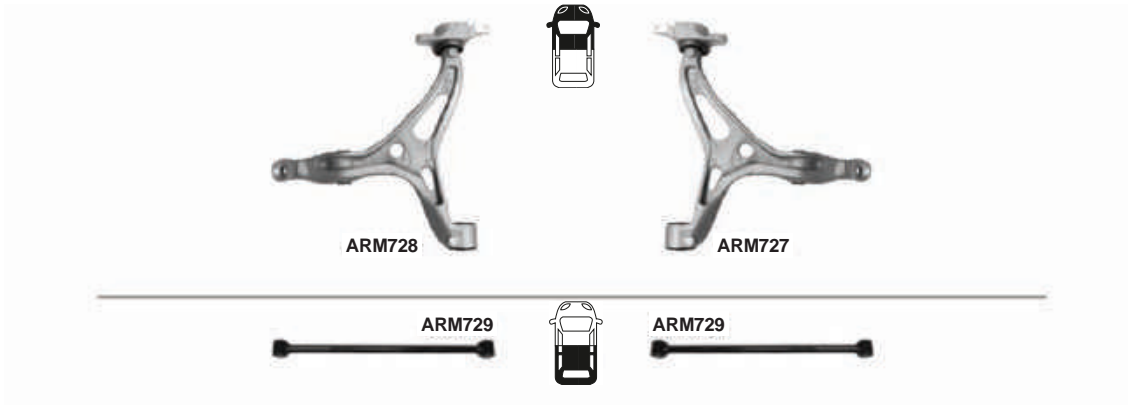

	PART NO.	DESCRIPTION	NOTES	O.E.
ARM727	301181372700	Suspension Control Arm - Front Right		1643301807; 1643303507; 1643303007; 1643302607
ARM728	301181372800	Suspension Control Arm - Front Left		1643301707; 1643303407; 1643302907; 1643302507
ARM729	301181372900	Lateral Arm - Rear		1643500053; 1663500053

**MERCEDES GL SERIES X166**

07/2011-



	PART NO.	DESCRIPTION	NOTES	O.E.
ARM689	301181368900	Suspension Control Arm and Ball Joint Assembly - Front Right Upper	ALM.	1663301807; A1663301807
ARM690	301181369000	Suspension Control Arm and Ball Joint Assembly - Front Left Upper	ALM.	1663301707; A1663301707
ARM691	301181369100	Suspension Control Arm - Front Right Lower	Aluminium	1663300207; A1663300207
ARM692	301181369200	Suspension Control Arm - Front Left Lower	Aluminium	1663300107; A1663300107
ARM693	301181369300	Lateral Arm - Rear Right		1663500206; A1663500206
ARM694	301181369400	Lateral Arm - Rear Left		1663500106; A1663500106
ARM729	301181372900	Lateral Arm - Rear		1643500053; 1663500053
SSP0135	301191601350	Steering Tie Rod - Front	M16X1,5 - L=270mm	1663380315; A1663380315
SSP0508	301191605080	Steering Tie Rod End - Front	M16X1,5	1663300403; A1663300403
SSP1881	301191618810	Suspension Ball Joint - Front Lower		1663300235; A1663300235



MERCEDES GLA SERIES X156



12/2013-



**MERCEDES GLA SERIES X156****12/2013-**

PART NO.	DESCRIPTION	NOTES	O.E.
ARM680	301181368000 Lateral Arm - Rear		2463500053; A2463500053
ARM681	301181368100 Lateral Arm - Rear Upper		2463501006; A2463501006
ARM780	301181378000 Lateral Arm - Rear Right Upper		2463500506; A2463500506
ARM781	301181378100 Lateral Arm - Rear Left Upper		2463500406; A2463500406
ARM784	301181378400 Suspension Control Arm and Ball Joint Assembly - Front Right	ALM.	1563300200; 1563300600; A1563300200
ARM785	301181378500 Suspension Control Arm and Ball Joint Assembly - Front Left	ALM.	1563300100; 1563300500; A1563300100
SSP0132	301191601320 Steering Tie Rod - Front	M14X1,5 - L=222mm	2463380000; A2463380000
SSP0501	301191605010 Steering Tie Rod End - Front Right	M14X1,5	2463301800
SSP0502	301191605020 Steering Tie Rod End - Front Left	M14X1,5	2463301700
SSP2298	301191622980 Suspension Stabilizer Bar Link - Front	(Aluminium) L=333mm	2463200689; A2463200689
SSP2299	301191622990 Suspension Stabilizer Bar Link - Rear		2463200789; A2463200789



MERCEDES GLK SERIES X204

 06/2008-2016



SSP0494



SSP0129

SSP0147



SSP0129

SSP0147



SSP0493



SSP2297



SSP2296



SSP2317

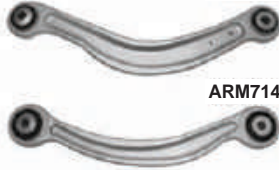

ARM712

ARM714



ARM711

ARM713



SSP2316



MERCEDES GLK SERIES X204



06/2008-2016

	PART NO.	DESCRIPTION	NOTES	O.E.
ARM663	301181366300	Suspension Control Arm and Ball Joint Assembly - Front Lower Rearward	Aluminium Type	2043308011
ARM664	301181366400	Suspension Control Arm and Ball Joint Assembly - Front Right Lower Rearward	Aluminium	2043308211
ARM665	301181366500	Suspension Control Arm and Ball Joint Assembly - Front Left Lower Rearward		2043308111
ARM711	301181371100	Lateral Arm - Rear Right Upper		2043501606; 2043503106
ARM712	301181371200	Lateral Arm - Rear Left Upper		2043501506; 2043503006
ARM713	301181371300	Lateral Arm - Rear Right		2043502206
ARM714	301181371400	Lateral Arm - Rear Left		2043502106
SSP0129	301191601290	Steering Tie Rod - Front	(4-matic Elec. PS. with ASD)	2123302803; A2123302803
SSP0147	301191601470	Steering Tie Rod - Front Inner	M14x1.5 - L=243,5mm	2043380515
SSP0493	301191604930	Steering Tie Rod End - Front Right	M14X1,5	2043302003
SSP0494	301191604940	Steering Tie Rod End - Front Left	M14X1,5	2043301903
SSP2296	301191622960	Suspension Stabilizer Bar Link - Front Right	Metal.Desingn L= 290 mm	2043202289**
SSP2297	301191622970	Suspension Stabilizer Bar Link - Front Left	Metal . Design L=290mm	2043200789**
SSP2316	301191623160	Suspension Stabilizer Bar Link - Rear Right	L=232mm	2043200489
SSP2317	301191623170	Suspension Stabilizer Bar Link - Rear Left	L=232mm	2043200589



MERCEDES ML SERIES W163



1998-06/2005



SSP2363



SSP2362



SSP2361



SSP1888



ARM724



ARM723



SSP1888



SSP2361

PART NO.	DESCRIPTION	NOTES	O.E.
ARM721	301181372100 Suspension Control Arm and Ball Joint Assembly - Front Right		1633330101
ARM722	301181372200 Suspension Control Arm and Ball Joint Assembly - Front Left		1633330001
ARM723	301181372300 Lateral Arm - Rear Right Upper		1633520501
ARM724	301181372400 Lateral Arm - Rear Left Upper		1633520401
ARM725	301181372500 Lateral Arm - Rear Right Upper Rearward		1633500653; 1633500453; 1633500153
ARM726	301181372600 Lateral Arm - Rear Left Upper Rearward		1633500553; 1633500353; 1633500053
SSP0143	301191601430 Steering Tie Rod - Front	M16x1,5 - L=160mm	1633380215; 1633380205
SSP0523	301191605230 Steering Tie Rod End - Front Right	M16x1,5Rht	1633300403
SSP0524	301191605240 Steering Tie Rod End - Front Left	M16x1,5Rht	1633300103
SSP1887	301191618870 Suspension Ball Joint - Front Lower		1633300035; 1633300135
SSP1888	301191618880 Suspension Ball Joint - Rear		1633500013; 1633500113
SSP2361	301191623610 Suspension Stabilizer Bar Link - Rear		1633200032; A1633200032
SSP2362	301191623620 Suspension Stabilizer Bar Link - Front Right	Ch No: -> 1A289559 - Ch No: -> 1X754619	1633200190
SSP2363	301191623630 Suspension Stabilizer Bar Link - Front Left	Ch No: -> 1A289559 - Ch No: -> 1X754619	1633200090



MERCEDES ML SERIES W164



07/2005-05/2011

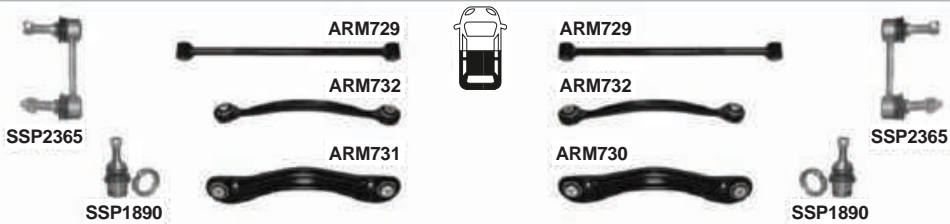
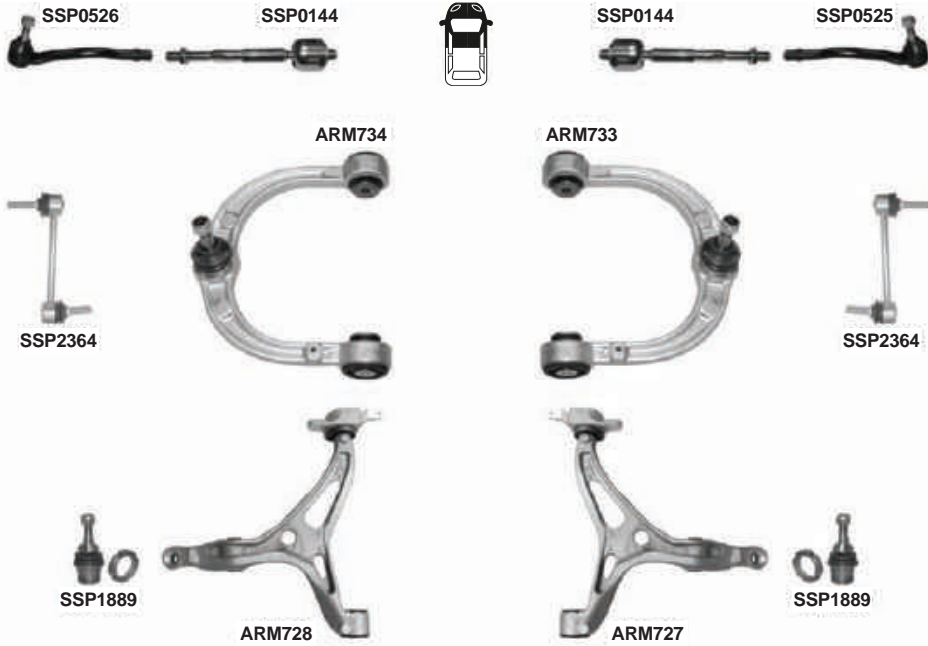

PART NO.	DESCRIPTION	NOTES	O.E.
ARM727	301181372700 Suspension Control Arm - Front Right		1643301807; 1643303507; 1643303007; 1643302607
ARM728	301181372800 Suspension Control Arm - Front Left		1643301707; 1643303407; 1643302907; 1643302507
ARM729	301181372900 Lateral Arm - Rear		1643500053; 1663500053
ARM730	301181373000 Lateral Arm - Rear Right	L=362MM	1643501606
ARM731	301181373100 Lateral Arm - Rear Left	L=362MM	1643501306
ARM732	301181373200 Lateral Arm - Rear		1643501406
ARM733	301181373300 Suspension Control Arm and Ball Joint Assembly - Front Right Upper		2513300807
ARM734	301181373400 Suspension Control Arm and Ball Joint Assembly - Front Left Upper		2513300707
SSP0144	301191601440 Steering Tie Rod - Front	M14x1,5 - L=204mm	1644600005
SSP0525	301191605250 Steering Tie Rod End - Front Right	M14x1,5	1643301203
SSP0526	301191605260 Steering Tie Rod End - Front Left	M14x1,5	1643301103
SSP1889	301191618890 Suspension Ball Joint - Front Lower		1643300935
SSP1890	301191618900 Suspension Ball Joint - Rear		1643520127; 1643530327
SSP2364	301191623640 Suspension Stabilizer Bar Link - Front	L=195,5 mm	1643201332
SSP2365	301191623650 Suspension Stabilizer Bar Link - Rear	L=117mm	1643201232



MERCEDES ML SERIES W166



07/2011-

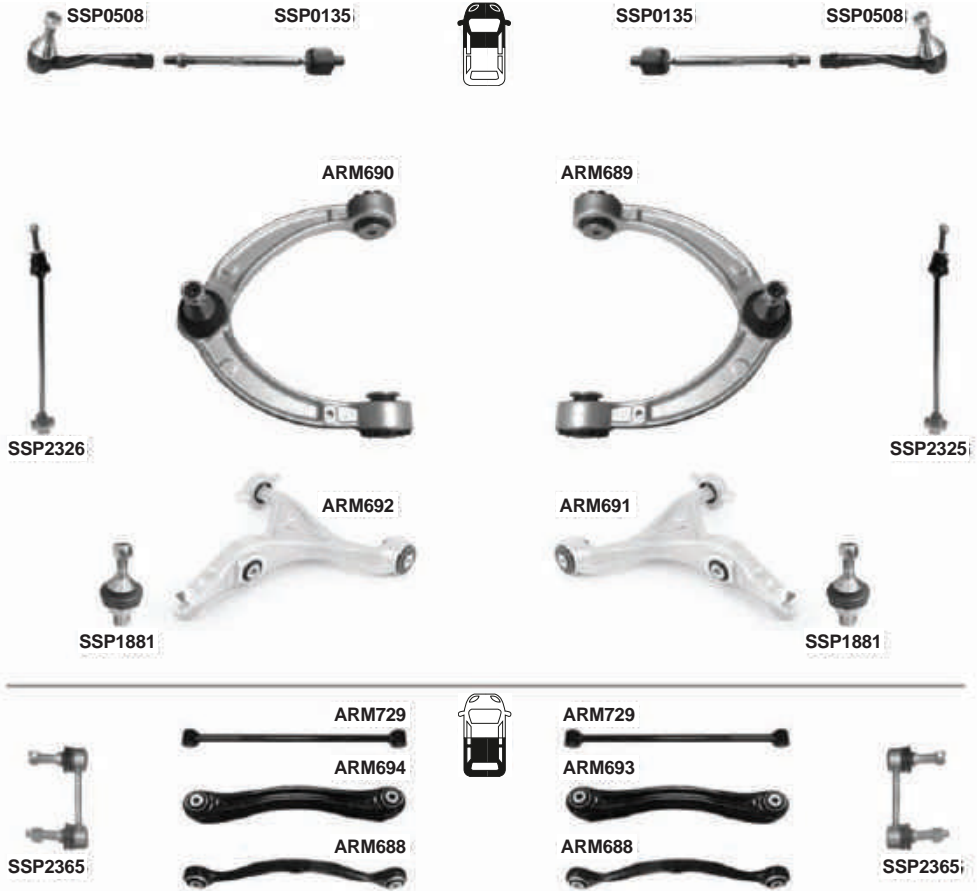

PART NO.	DESCRIPTION	NOTES	O.E.
ARM688	301181368800 Lateral Arm - Rear Forward	A= 193mm	1663500306; A1663500306
ARM689	301181368900 Suspension Control Arm and Ball Joint Assembly - Front Right Upper	ALM.	1663301807; A1663301807
ARM690	301181369000 Suspension Control Arm and Ball Joint Assembly - Front Left Upper	ALM.	1663301707; A1663301707
ARM691	301181369100 Suspension Control Arm - Front Right Lower	Aluminium	1663300207; A1663300207
ARM692	301181369200 Suspension Control Arm - Front Left Lower	Aluminium	1663300107; A1663300107
ARM693	301181369300 Lateral Arm - Rear Right		1663500206; A1663500206
ARM694	301181369400 Lateral Arm - Rear Left		1663500106; A1663500106
ARM729	301181372900 Lateral Arm - Rear		1643500053; 1663500053
SSP0135	301191601350 Steering Tie Rod - Front	M16X1,5 - L=270mm	1663380315; A1663380315
SSP0508	301191605080 Steering Tie Rod End - Front	M16X1,5	1663300403; A1663300403
SSP1881	301191618810 Suspension Ball Joint - Front Lower		1663300235; A1663300235
SSP2325	301191623250 Suspension Stabilizer Bar Link - Front Right	L=360mm	1663200889; A1663200889
SSP2326	301191623260 Suspension Stabilizer Bar Link - Front Left	L=360mm	1663200789; A1663200789
SSP2365	301191623650 Suspension Stabilizer Bar Link - Rear	L=117mm	1643201232



MERCEDES R SERIES W251



09/2006-08/2013

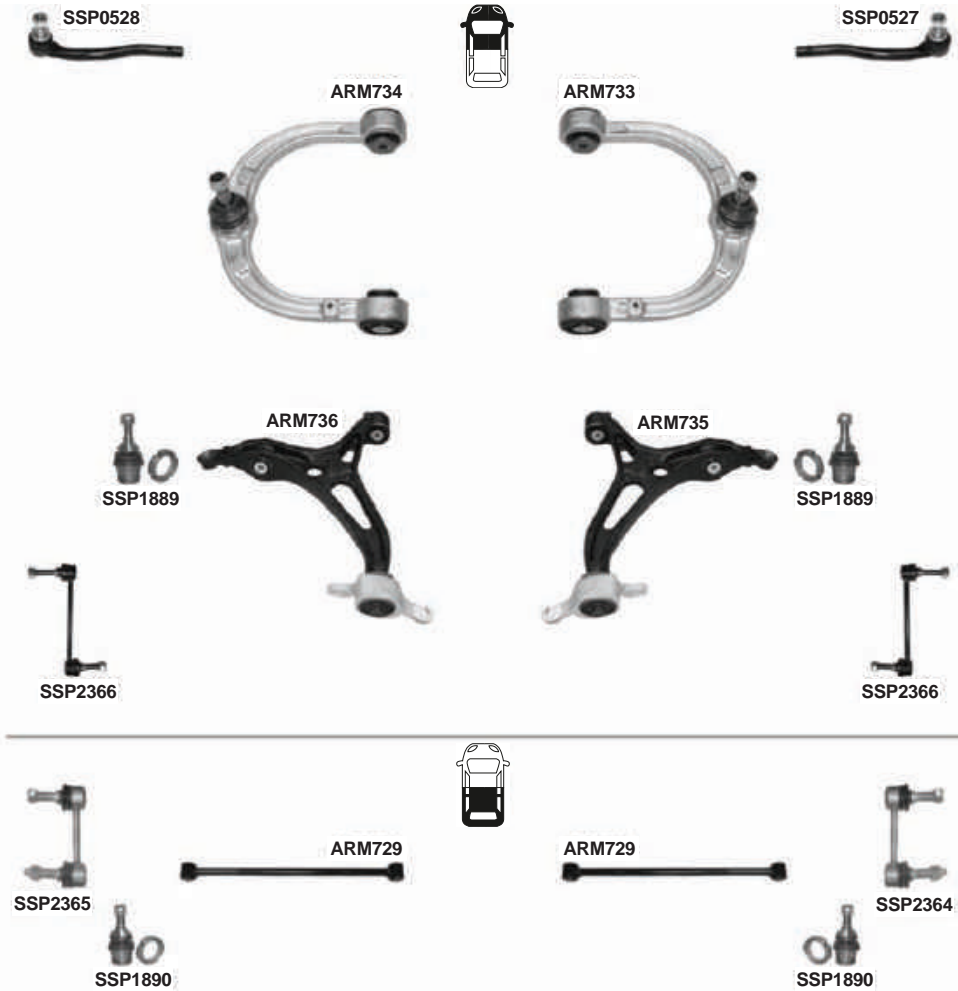

PART NO.	DESCRIPTION	NOTES	O.E.
ARM729 301181372900	Lateral Arm - Rear		1643500053; 1663500053
ARM733 301181373300	Suspension Control Arm and Ball Joint Assembly - Front Right Upper		2513300807
ARM734 301181373400	Suspension Control Arm and Ball Joint Assembly - Front Left Upper		2513300707
ARM735 301181373500	Suspension Control Arm - Front Right		2513302007; A2513302007
ARM736 301181373600	Suspension Control Arm - Front Left		2513301907; A2513301907
SSP0527 301191605270	Steering Tie Rod End - Front Right	M14X1,5	2513300803
SSP0528 301191605280	Steering Tie Rod End - Front Left	M14X1,5	2513300703
SSP1889 301191618890	Suspension Ball Joint - Front Lower		1643300935
SSP1890 301191618900	Suspension Ball Joint - Rear		1643520127; 1643530327
SSP2364 301191623640	Suspension Stabilizer Bar Link - Front	L=195,5 mm	1643201332
SSP2365 301191623650	Suspension Stabilizer Bar Link - Rear	L=117mm	1643201232
SSP2366 301191623660	Suspension Stabilizer Bar Link - Front	Ch.No: A064885-> L=235mm	1643202132



PART NO.	DESCRIPTION	NOTES	O.E.
SSP2304 301191623040	Suspension Stabilizer Bar Link - Rear	Plastic L=230mm	1403200889; 1403203589



MERCEDES S SERIES W220



1999-2005

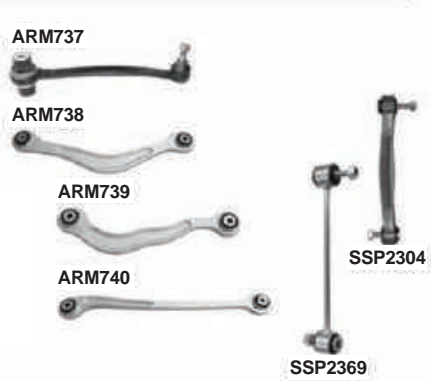
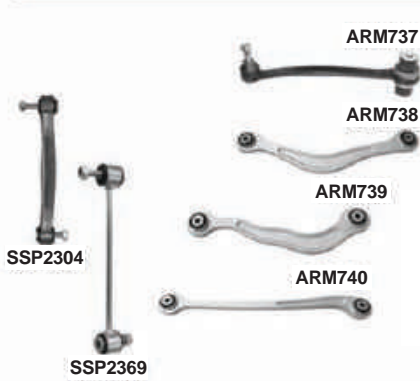
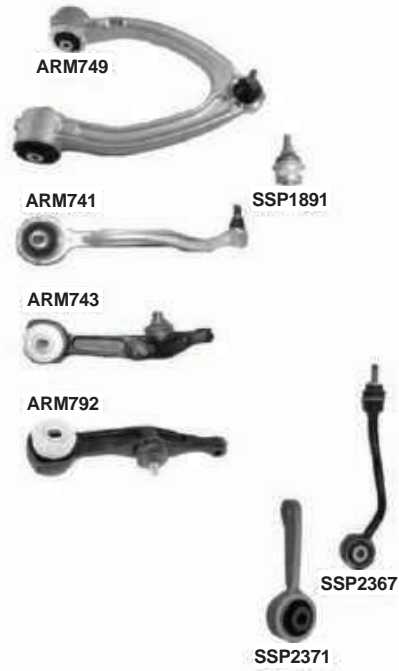



MERCEDES S SERIES W220



1999-2005

PART NO.	DESCRIPTION	NOTES	O.E.
ARM737	301181373700 Lateral Arm - Rear Lower Rearward		2203500453; 2203520003
ARM738	301181373800 Lateral Arm - Rear Upper Rearward		2203502206; 2203521105
ARM739	301181373900 Lateral Arm - Rear Upper Forward		2203502406; A2203521005
ARM740	301181374000 Lateral Arm - Rear Lower Forward		2203502606; A2203520502
ARM741	301181374100 Suspension Control Arm and Ball Joint Assembly - Front Right Lower Forward	Front Lower	2203301711; 2203330405; 2203305711; 2203304311
ARM742	301181374200 Suspension Control Arm and Ball Joint Assembly - Front Left Lower Forward	Front Lower	2203301811; 2203330505; 2203305811; 2203304411
ARM743	301181374300 Suspension Control Arm and Ball Joint Assembly - Front Left Lower Rearward		2203307707; 2203308907
ARM744	301181374400 Suspension Control Arm and Ball Joint Assembly - Front Right Lower Rearward		2203307807; 2203309007
ARM749	301181374900 Suspension Control Arm and Ball Joint Assembly - Front Right Upper		2203301507; 2203309407; 2203308407
ARM750	301181375000 Suspension Control Arm and Ball Joint Assembly - Front Left Upper		2203301407; 2203309307; 2203308307
ARM792	301181379200 Suspension Control Arm - Front Lower Rearward	Ch-> : 028009 Only : A.B.C li	2153300307; 2153300706; 2153300707
SSP0145	301191601450 Steering Tie Rod - Front Inner	M14x1,5 - L=243mm	2203380715; 2303380015
SSP0529	301191605290 Steering Tie Rod End - Front	M14x1,5Rht	2203380115; 2303380115; 2303300403; 2303300203; 2203380515
SSP1891	301191618910 Suspension Ball Joint - Front Lower		2113300235; 2203330427; 2203330127; 2203300727; 2113300435
SSP2304	301191623040 Suspension Stabilizer Bar Link - Rear	Plastic L=230mm	1403200889; 1403203589
SSP2367	301191623670 Suspension Stabilizer Bar Link - Front Right	Only: 4Matic L=258.6mm	2203203489
SSP2368	301191623680 Suspension Stabilizer Bar Link - Front Left	Only: 4Matic L=258.6mm	2203203389
SSP2369	301191623690 Suspension Stabilizer Bar Link - Rear	Metal L=230mm	2203203689
SSP2371	301191623710 Suspension Stabilizer Bar Link - Front Right	L=128,5mm	2203201689; A2203201689
SSP2372	301191623720 Suspension Stabilizer Bar Link - Front Left	L=128,5mm	2203201589; A2203201589



MERCEDES S SERIES W221



10/2005-04/2013

SSP0532



SSP0146



SSP0146



SSP0532



ARM767



ARM766



ARM761



ARM760



ARM763



ARM762



ARM771



ARM770



ARM783



ARM782



SSP2376



SSP2375

ARM777



ARM776



ARM779



ARM778



ARM773



ARM772



ARM775



ARM774



SSP2378



SSP2377





MERCEDES S SERIES W221



10/2005-04/2013

PART NO.	DESCRIPTION	NOTES	O.E.
ARM760	301181376000	Suspension Control Arm and Ball Joint Assembly - Front Right Lower Forward	2213300241; 2213306411
ARM761	301181376100	Suspension Control Arm and Ball Joint Assembly - Front Left Lower Forward	2213302311; 2213306311
ARM762	301181376200	Suspension Control Arm and Ball Joint Assembly - Front Right Lower	2213306807; 2213308207
ARM763	301181376300	Suspension Control Arm and Ball Joint Assembly - Front Left Lower	2213306707; 2213308107
ARM766	301181376600	Suspension Control Arm and Ball Joint Assembly - Front Right Upper	2213300407; 2213309007
ARM767	301181376700	Suspension Control Arm and Ball Joint Assembly - Front Left Upper	2213300307; 2213308907
ARM770	301181377000	Suspension Control Arm and Ball Joint Assembly - Front Right	Ch: -> 097048 / -> :0-28/06/2006 (Only:487 li,Type ABC) 2213306807; 2213307207; 2213308207
ARM771	301181377100	Suspension Control Arm and Ball Joint Assembly - Front Left	Ch:->097048 (Only:487 li,Type ABC) 2213306707; 2213307107
ARM772	301181377200	Lateral Arm - Rear Right Lower Rearward	2213500806; A2213500806
ARM773	301181377300	Lateral Arm - Rear Left Lower Rearward	2213500706; A2213500706
ARM774	301181377400	Lateral Arm - Rear Right Lower	A = 285 MM 2213501253; A2213501253
ARM775	301181377500	Lateral Arm - Rear Left Lower Forward	A = 285 MM 2213501153; A2213501153
ARM776	301181377600	Lateral Arm - Rear Right Upper Forward	2213501006; A2213501006
ARM777	301181377700	Lateral Arm - Rear Left Upper Forward	2213500206; A2213500206
ARM778	301181377800	Lateral Arm - Rear Right Upper Rearward	2213500606; A2213500606
ARM779	301181377900	Lateral Arm - Rear Left Upper Rearward	2213500406; 2233500132; A2213500406
ARM782	301181378200	Suspension Control Arm and Ball Joint Assembly - Front Right	Ch: A000101 -> 2213308807
ARM783	301181378300	Suspension Control Arm and Ball Joint Assembly - Front Left	Ch: A000101 -> 2213308707
SSP0146	301191601460	Steering Tie Rod - Front	M14x1,5 - L=262mm 2213301603
SSP0532	301191605320	Steering Tie Rod End - Front	M14x1,5 2213303903
SSP2375	301191623750	Suspension Stabilizer Bar Link - Front Right	L=262mm 2213200289; 2213300289
SSP2376	301191623760	Suspension Stabilizer Bar Link - Front Left	L=262mm 2213200189; 2213300189
SSP2377	301191623770	Suspension Stabilizer Bar Link - Rear Right	L=241mm 2213202289
SSP2378	301191623780	Suspension Stabilizer Bar Link - Rear Left	L=241mm 2213201989

**MERCEDES S SERIES W221 AWD**  10/2005-04/2013

PART NO.	DESCRIPTION	NOTES	O.E.
ARM764	301181376400	Suspension Control Arm and Ball Joint Assembly - Front Right Lower	2213303811; 2213306611
ARM765	301181376500	Suspension Control Arm and Ball Joint Assembly - Front Right Lower Forward	2213303711; 2213306511
ARM766	301181376600	Suspension Control Arm and Ball Joint Assembly - Front Right Upper	2213300407; 2213309007
ARM767	301181376700	Suspension Control Arm and Ball Joint Assembly - Front Left Upper	2213300307; 2213308907
ARM768	301181376800	Suspension Control Arm and Ball Joint Assembly - Front Right	2213307807
ARM769	301181376900	Suspension Control Arm and Ball Joint Assembly - Front Left	2213307707
SSP0147	301191601470	Steering Tie Rod - Front Inner	M14x1.5 - L=243,5mm 2043380515
SSP0533	301191605330	Steering Tie Rod End - Front Right	M14x1,5 2213302003; 2213303403
SSP0534	301191605340	Steering Tie Rod End - Front Left	M14x1,5 2213301903; 2213303303
SSP2377	301191623770	Suspension Stabilizer Bar Link - Rear Right	L=241mm 2213202289
SSP2378	301191623780	Suspension Stabilizer Bar Link - Rear Left	L=241mm 2213201989
SSP2379	301191623790	Suspension Stabilizer Bar Link - Front Right	L=289.5mm 2213201689
SSP2380	301191623800	Suspension Stabilizer Bar Link - Front Left	L=289.5mm 2213201589



MERCEDES S SERIES W222, V222, X222



2014-



SSP2384



SSP2383

	PART NO.	DESCRIPTION	NOTES	O.E.
SSP2383	301191623830	Suspension Stabilizer Bar Link - Front Right	(for vehicles without ABC) A = 256 MM	2223201689; A2223201689
SSP2384	301191623840	Suspension Stabilizer Bar Link - Front Left	(for vehicles without ABC) A = 256 MM	2223201789; A2223201789

**MERCEDES S SERIES W222, V222, X222 AWD****2014-**

PART NO.	DESCRIPTION	NOTES	O.E.
SSP0129 301191601290	Steering Tie Rod - Front	(4-matic Elec. PS. with ASD)	2123302803; A2123302803
SSP0499 301191604990	Steering Tie Rod End - Front Right	4matic	2223300203
SSP0500 301191605000	Steering Tie Rod End - Front Left	4matic	2223300103
SSP2385 301191623850	Suspension Stabilizer Bar Link - Rear Right	(W/O ABC)	2223200489
SSP2386 301191623860	Suspension Stabilizer Bar Link - Rear Left	(W/O ABC)	2223200389
SSP2387 301191623870	Suspension Stabilizer Bar Link - Front Right	(4matic & for vehicles without ABC)	2223201089; A2223201089
SSP2388 301191623880	Suspension Stabilizer Bar Link - Front Left	(4matic & for vehicles without ABC)	2223201189; A2223201189



MERCEDES SL SERIES R129



03/1989-12/2001



PART NO.	DESCRIPTION	NOTES	O.E.
ARM666 301181366600	Lateral Arm - Rear Lower Rearward		2013500653; 2103500653; 2013503253; 2013502753; 2013503153
ARM667 301181366700	Lateral Arm - Rear Right Upper		1243507706; 2103501706
ARM669 301181366900	Lateral Arm - Rear Left Upper		1243507606; 2103501606
ARM671 301181367100	Lateral Arm - Rear Upper Forward	Rear Axle Short	2013504706; 2013505606



MERCEDES SL SERIES R230



10/2001-01/2012

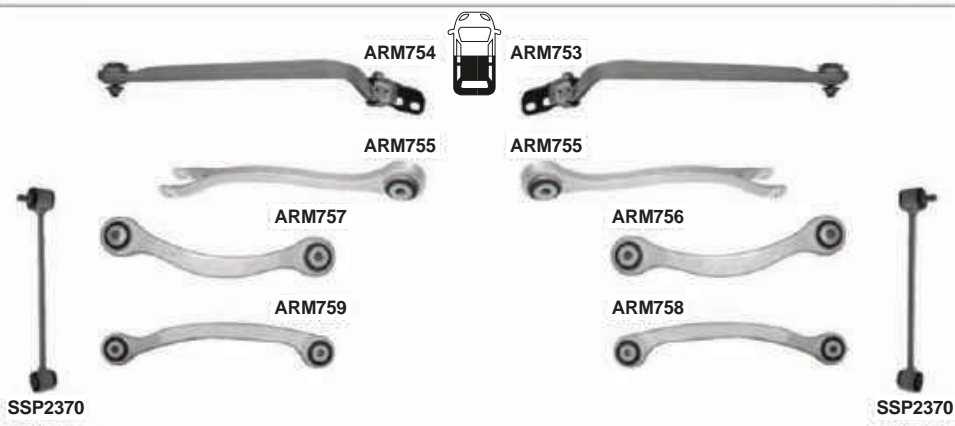
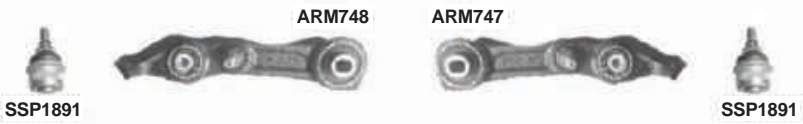



MERCEDES SL SERIES R230



10/2001-01/2012

PART NO.	DESCRIPTION	NOTES	O.E.
ARM745	301181374500 Suspension Control Arm and Ball Joint Assembly - Front Left Lower Forward		2113301111; 2113304311; 2303301711; 2113302911; 2113301511
ARM746	301181374600 Suspension Control Arm and Ball Joint Assembly - Front Right Lower Forward		2113301211; 2113304411; 2303301811; 2113303011; 2113301611
ARM747	301181374700 Suspension Control Arm and Ball Joint Assembly - Front Left Lower Rearward		2113308107; 2113309107
ARM748	301181374800 Suspension Control Arm and Ball Joint Assembly - Front Right Lower Rearward		2113308207; 2113309207
ARM753	301181375300 Lateral Arm - Rear Right	L=440mm	2303500429
ARM754	301181375400 Lateral Arm - Rear Left	L=440mm	2303500329
ARM755	301181375500 Lateral Arm - Rear Lower	L=368mm	2303502006
ARM756	301181375600 Lateral Arm - Rear Right Upper Forward	L=262mm	2303503606
ARM757	301181375700 Lateral Arm - Rear Left Upper Forward	L=262mm	2303503506
ARM758	301181375800 Lateral Arm - Rear Right Upper Rearward	L=324,5mm	2303502806
ARM759	301181375900 Lateral Arm - Rear Left Upper Rearward	L=324,5mm	2303502706
SSP0145	301191601450 Steering Tie Rod - Front Inner	M14x1,5 - L=243mm	2203380715; 2303380015
SSP0529	301191605290 Steering Tie Rod End - Front	M14x1,5Rht	2203380115; 2303380115; 2303300403; 2303300203; 2203380515
SSP1891	301191618910 Suspension Ball Joint - Front Lower		2113300235; 2203330427; 2203330127; 2203300727; 2113300435
SSP1892	301191618920 Suspension Ball Joint - Front Lower		2113230068; 2203230368
SSP1894	301191618940 Suspension Ball Joint - Front Upper		A0003301007
SSP2304	301191623040 Suspension Stabilizer Bar Link - Rear	Plastic L=230mm	1403200889; 1403203589
SSP2370	301191623700 Suspension Stabilizer Bar Link - Rear	L=259,5mm	2113200889; 2113203389



MERCEDES SLK SERIES R170



1997-2004

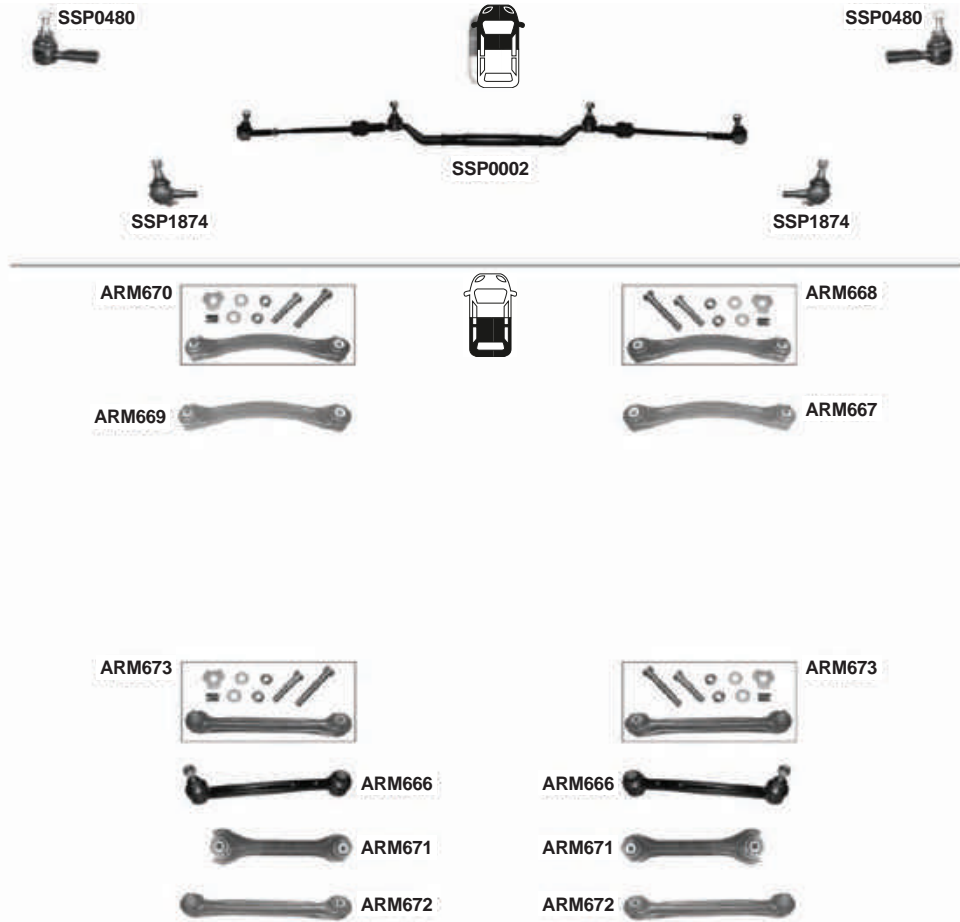

PART NO.	DESCRIPTION	NOTES	O.E.
ARM666	301181366600 Lateral Arm - Rear Lower Rearward		2013500653; 2103500653; 2013503253; 2013502753; 2013503153
ARM667	301181366700 Lateral Arm - Rear Right Upper		1243507706; 2103501706
ARM668	301181366800 Suspension Control Arm Kit - Rear Right Upper		1243507706*
ARM669	301181366900 Lateral Arm - Rear Left Upper		1243507606; 2103501606
ARM670	301181367000 Suspension Control Arm Kit - Rear Left Upper		1243507606*
ARM671	301181367100 Lateral Arm - Rear Upper Forward	Rear Axle Short	2013504706; 2013505606
ARM672	301181367200 Lateral Arm - Rear Lower Forward		1243500129; 2103500029
ARM673	301181367300 Suspension Control Arm Kit - Rear		1243500129*
SSP0002	301191600020 Steering Center Link - N/A	Only : RH Steering	1704630015
SSP0480	301191604800 Steering Tie Rod End - Front	M12x1,5Rht	13307435; 13307735
SSP1874	301191618740 Suspension Ball Joint - Front Lower		2023330027; 2113300335; 2103300035; 2103300435



MERCEDES SLK SERIES R171



03/2004-02/2011

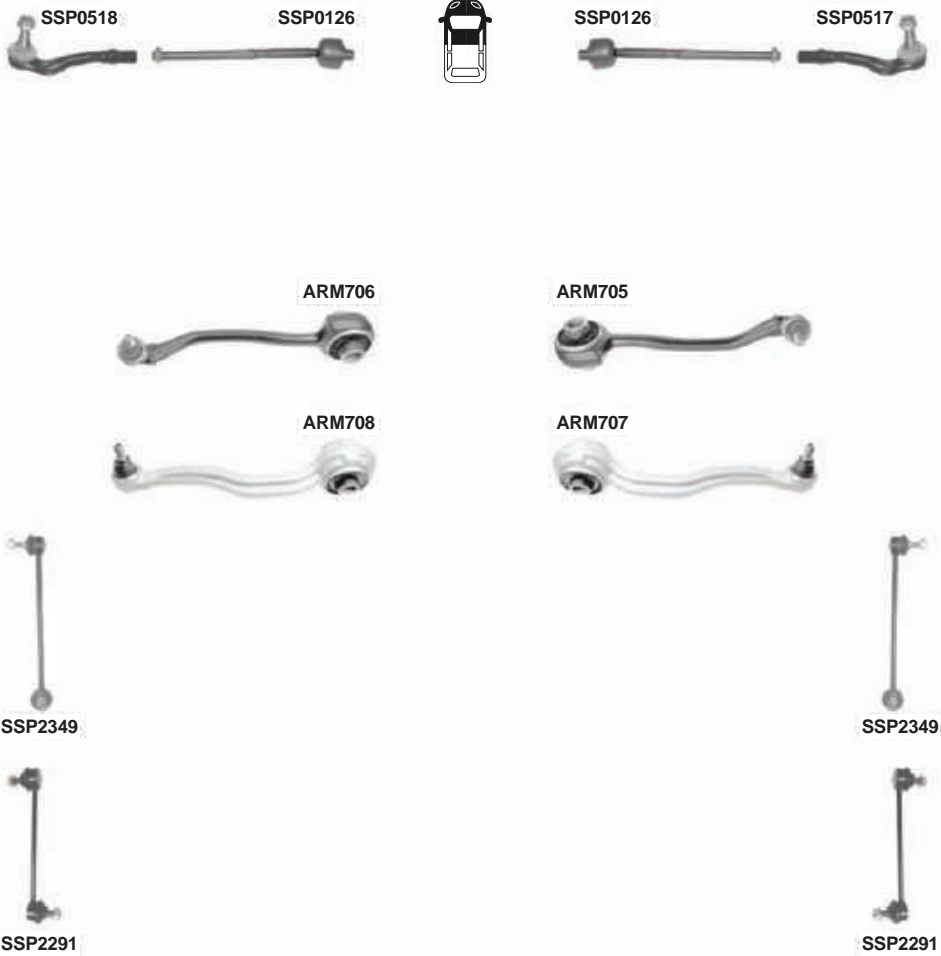

PART NO.	DESCRIPTION	NOTES	O. E.
ARM705 301181370500	Suspension Control Arm and Ball Joint Assembly - Front Left Lower		2033301911; 2033303311
ARM706 301181370600	Suspension Control Arm and Ball Joint Assembly - Front Right Lower		2033302011; 2033303411
ARM707 301181370700	Suspension Control Arm and Ball Joint Assembly - Front Right Upper		2033300211; 2043304411; 2033304011; 2033301711; 2033303611
ARM708 301181370800	Suspension Control Arm and Ball Joint Assembly - Front Left Upper		2033300111; 2043304311; 2033303911; 2033301611; 2033303511
SSP0126 301191601260	Steering Tie Rod - Front	M14x1,5Rht	1713280015
SSP0517 301191605170	Steering Tie Rod End - Front Right Outer	M14x1,5Rht	2033302003; 2033302403
SSP0518 301191605180	Steering Tie Rod End - Front Left Outer	M14x1,5Rht	2033301903; 2033302303
SSP2291 301191622910	Suspension Stabilizer Bar Link - Front		1713230017
SSP2349 301191623490	Suspension Stabilizer Bar Link - Front	Only : C230 L=277mm	2033202689; 2033202989

**MERCEDES SLK SERIES R172**

2011-

**SSP2301****SSP2300****SSP2302****SSP2302**

PART NO.		DESCRIPTION	NOTES	O.E.
SSP2300	301191623000	Suspension Stabilizer Bar Link - Front Right	metal design	1723230217
SSP2301	301191623010	Suspension Stabilizer Bar Link - Front Left	metal design	1723230117
SSP2302	301191623020	Suspension Stabilizer Bar Link - Rear		1723200089; A1723200089



MERCEDES SPRINTER W901,W902,W903



01/1995-05/2006





MERCEDES SPRINTER W901,W902,W903



01/1995-05/2006

	PART NO.	DESCRIPTION	NOTES	O.E.
ARM701	301181370100	Suspension Control Arm and Ball Joint Assembly - Front Right Lower		2D0407022; 9013301907; 9013302507
ARM702	301181370200	Suspension Control Arm and Ball Joint Assembly - Front Left Lower		2D0407021; 9013301807; 9013302407
SSP0138	301191601380	Steering Tie Rod - Front	M16x1,5Rht - L=388mm	9014600155; 9014600455
SSP0515	301191605150	Steering Tie Rod End - Front	M16x1,5Rht	2D0422811; 9014600148
SSP1884	301191618840	Suspension Ball Joint - Front Lower		2D0407361A; 9013331127; 2D0407361B; 9013330727
SSP1885	301191618850	Suspension Ball Joint - Front	4Matic (4x4)	9013331327; 9013331127; 2D0407361B; 9013330727
SSP2339	301191623390	Suspension Stabilizer Bar Link - Front Right	EXC. 616 CDI L=115mm	2D0411052; 9013200389
SSP2340	301191623400	Suspension Stabilizer Bar Link - Front Left	EXC. 616 CDI L=115mm	2D0411051; 9013200289
SSP2341	301191623410	Suspension Stabilizer Bar Link - Rear	L=93mm	2D0511329; 9013200089
SSP2342	301191623420	Suspension Stabilizer Bar Link - Rear	with equipment 904	9013200589; 5118696AA
SSP2343	301191623430	Suspension Stabilizer Bar Link - Front Right	616 CDI	9053200589
SSP2344	301191623440	Suspension Stabilizer Bar Link - Front Left	616 CDI	9053200489
SSP2345	301191623450	Suspension Stabilizer Bar Link - Rear	L=185mm	2E0511051F; 9063201389



MERCEDES SPRINTER W906



06/2006-



PART NO.	DESCRIPTION	NOTES	O.E.
ARM703	301181370300 Suspension Control Arm and Ball Joint Assembly - Front Right Lower		2E0407152M; 9063304107
ARM704	301181370400 Suspension Control Arm and Ball Joint Assembly - Front Left Lower		2E0407151M; 9063304007
SSP0139	301191601390 Steering Tie Rod - Front		2E0713491; 9064600055
SSP0516	301191605160 Steering Tie Rod End - Front		2E0713501; 9064600048
SSP1886	301191618860 Suspension Ball Joint - Front Lower		9063304007
SSP2346	301191623460 Suspension Stabilizer Bar Link - Rear		2E0511051G; 9063201489
SSP2347	301191623470 Suspension Stabilizer Bar Link - Front Right		2E0411318C; 9063201889
SSP2348	301191623480 Suspension Stabilizer Bar Link - Front Left		2E0411317C; 9063201789



MERCEDES Vaneo W414



02/2002-07/2005



SSP2336



SSP2336

PART NO.	DESCRIPTION	NOTES	O.E.
ARM699	301181369900 Suspension Control Arm and Ball Joint Assembly - Front Right Lower		4143300407; 4143300607
ARM700	301181370000 Suspension Control Arm and Ball Joint Assembly - Front Left Lower		4143300307; 4143300507
SSP0136	301191601360 Steering Tie Rod - Front	M14X1,5 Rht - L=196mm	4143300035; 4144600205
SSP0509	301191605090 Steering Tie Rod End - Front Right	M14X1,5Rht.	4143330135; 4144600105
SSP0510	301191605100 Steering Tie Rod End - Front Left	M14X1,5Rht.	4143330235; 4144600005
SSP1883	301191618830 Suspension Ball Joint - Front Lower		4143330127; 4143330227
SSP2336	301191623360 Suspension Stabilizer Bar Link - Front	L=207mm	4143200189; 4143200289; 4143200389



MERCEDES VIANO W639



03/2003-07/2014

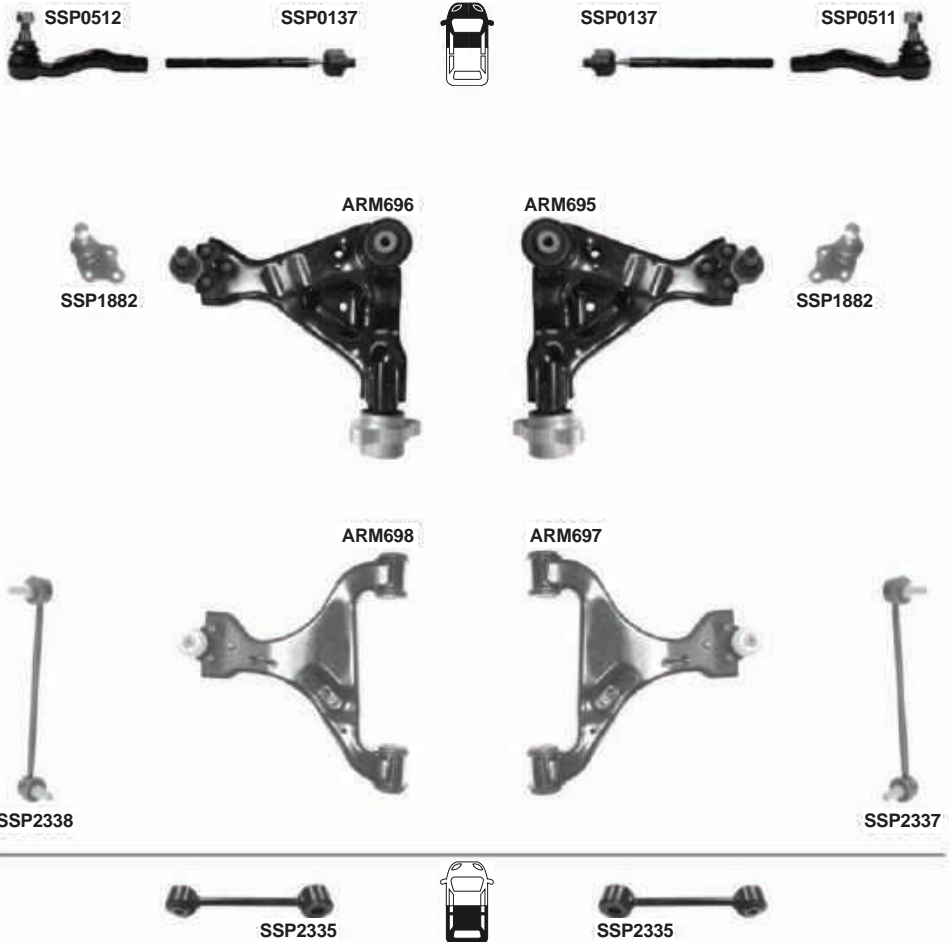

PART NO.	DESCRIPTION	NOTES	O.E.
ARM695	301181369500 Suspension Control Arm and Ball Joint Assembly - Front Right Lower		6393301301; 6393301501
ARM696	301181369600 Suspension Control Arm and Ball Joint Assembly - Front Left Lower		6393301201; 6393301401
ARM697	301181369700 Suspension Control Arm and Ball Joint Assembly - Front Right Lower		6393300510
ARM698	301181369800 Suspension Control Arm and Ball Joint Assembly - Front Left Lower		6393300410
SSP0137	301191601370 Steering Tie Rod - Front	M16x1,5 Rht - L=290 mm	6394600055; 6394600255
SSP0511	301191605110 Steering Tie Rod End - Front Right	M16X1,5 Rht	6394600348
SSP0512	301191605120 Steering Tie Rod End - Front Left	M16X1,5 Rht	6394600048
SSP1882	301191618820 Suspension Ball Joint - Front		6393330227
SSP2335	301191623350 Suspension Stabilizer Bar Link - Rear	Ch:->3603471 A = 145 MM	6393260216; 6393260616
SSP2337	301191623370 Suspension Stabilizer Bar Link - Front Right	L=280mm	6393200389
SSP2338	301191623380 Suspension Stabilizer Bar Link - Front Left	L=280mm	6393200289

**MERCEDES V SERIES W447**

2014-

**SSP0507****SSP0506****ARM687****ARM686****SSP2320****SSP2322****SSP2324****SSP2320****SSP2321****SSP2323**

	PART NO.	DESCRIPTION	NOTES	O.E.
ARM686	301181368600	Suspension Control Arm and Ball Joint Assembly - Front Right Lower		4473301507; A4473301507
ARM687	301181368700	Suspension Control Arm and Ball Joint Assembly - Front Left Lower		4473301407; A4473301407
SSP0506	301191605060	Steering Tie Rod End - Front Right		4474600148; A4474600148
SSP0507	301191605070	Steering Tie Rod End - Front Left		4474600048; A4474600048
SSP2320	301191623200	Suspension Stabilizer Bar Link - Front		4473200489; A4473200489
SSP2321	301191623210	Suspension Stabilizer Bar Link - Front Right		4473200389; A4473200389
SSP2322	301191623220	Suspension Stabilizer Bar Link - Front Left		4473200089; A4473200089
SSP2323	301191623230	Suspension Stabilizer Bar Link - Front Right		4473200289; A4473200289
SSP2324	301191623240	Suspension Stabilizer Bar Link - Front Left		4473200189; A4473200189

MERCEDES VITO W638



03/1997-07/2003

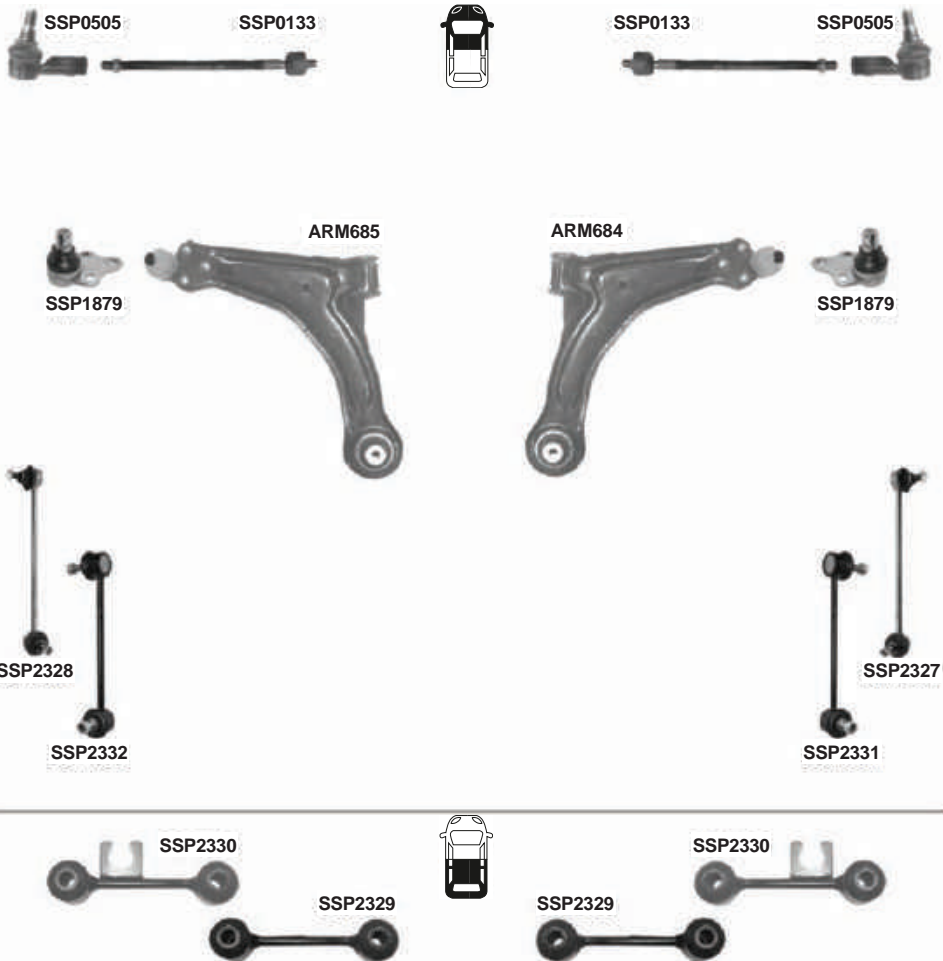

	PART NO.	DESCRIPTION	NOTES	O.E.
ARM684	301181368400	Suspension Control Arm and Ball Joint Assembly - Front Right Lower		6383300110
ARM685	301181368500	Suspension Control Arm and Ball Joint Assembly - Front Left Lower		6383300010
SSP0133	301191601330	Steering Tie Rod - Front	M16x1,5 - L=342,5mm	6384600055
SSP0505	301191605050	Steering Tie Rod End - Front	M16x1,5Rht	6384600048
SSP1879	301191618790	Suspension Ball Joint - Front Lower	D=Ø 22mm	6383300027
SSP2327	301191623270	Suspension Stabilizer Bar Link - Front Right	Ch.No.> 657540 L=250mm	6383230368
SSP2328	301191623280	Suspension Stabilizer Bar Link - Front Left	Ch.No.> 657540 L=250mm	6383230268
SSP2329	301191623290	Suspension Stabilizer Bar Link - Rear	Only Mod : Van L=105mm	6383260016
SSP2330	301191623300	Suspension Stabilizer Bar Link - Rear	Only : Van L=105mm	6383260116
SSP2331	301191623310	Suspension Stabilizer Bar Link - Front Right	Ch.No: 657541 L=230 mm	6383230568
SSP2332	301191623320	Suspension Stabilizer Bar Link - Front Left	Ch.No: 657541 L=230 mm	6383230468



MERCEDES VITO W639



03/2003-07/2014

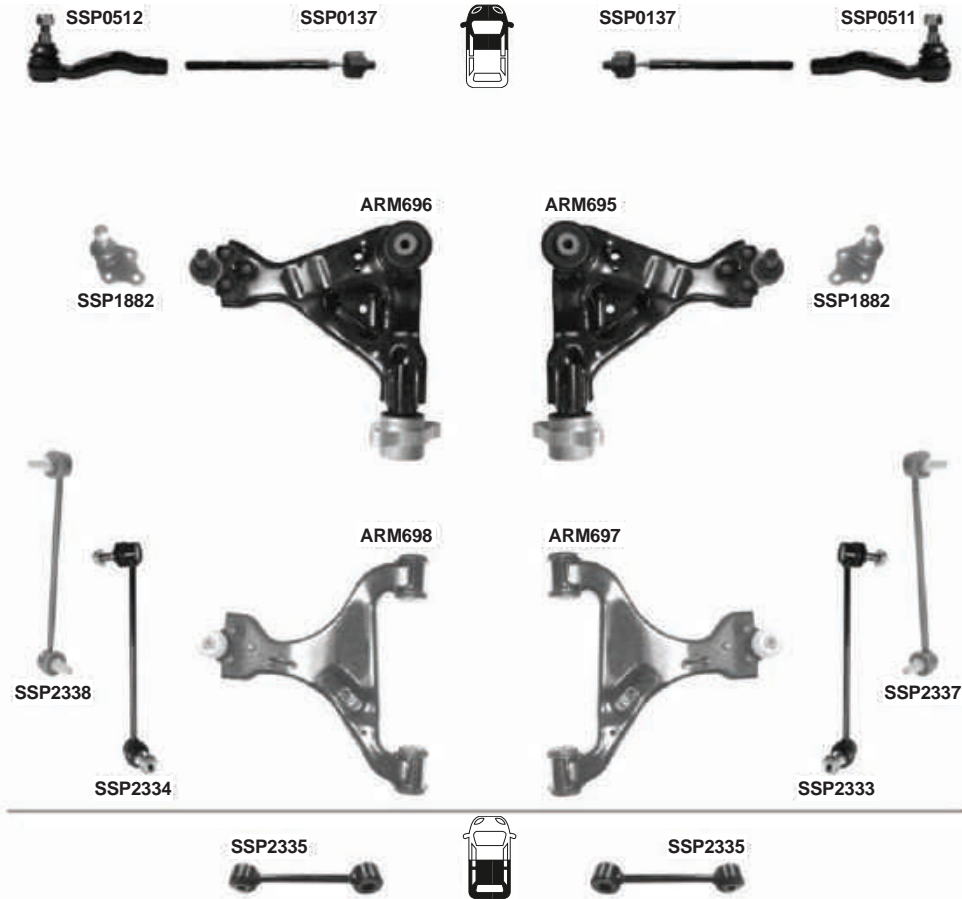

PART NO.	DESCRIPTION	NOTES	O.E.
ARM695 301181369500	Suspension Control Arm and Ball Joint Assembly - Front Right Lower		6393301301; 6393301501
ARM696 301181369600	Suspension Control Arm and Ball Joint Assembly - Front Left Lower		6393301201; 6393301401
ARM697 301181369700	Suspension Control Arm and Ball Joint Assembly - Front Right Lower		6393300510
ARM698 301181369800	Suspension Control Arm and Ball Joint Assembly - Front Left Lower		6393300410
SSP0137 301191601370	Steering Tie Rod - Front	M16x1,5 Rht - L=290 mm	6394600055; 6394600255
SSP0511 301191605110	Steering Tie Rod End - Front Right	M16X1,5 Rht	6394600348
SSP0512 301191605120	Steering Tie Rod End - Front Left	M16X1,5 Rht	6394600048
SSP1882 301191618820	Suspension Ball Joint - Front		6393330227
SSP2333 301191623330	Suspension Stabilizer Bar Link - Front Right	4X4 4-Matic A = 285 mm	6393201089
SSP2334 301191623340	Suspension Stabilizer Bar Link - Front Left	4X4 4-Matic A = 285 mm	6393200989
SSP2335 301191623350	Suspension Stabilizer Bar Link - Rear	Ch:->3603471 A = 145 MM	6393260216; 6393260616
SSP2337 301191623370	Suspension Stabilizer Bar Link - Front Right	L=280mm	6393200389
SSP2338 301191623380	Suspension Stabilizer Bar Link - Front Left	L=280mm	6393200289



MERCEDES VITO W447



2014-

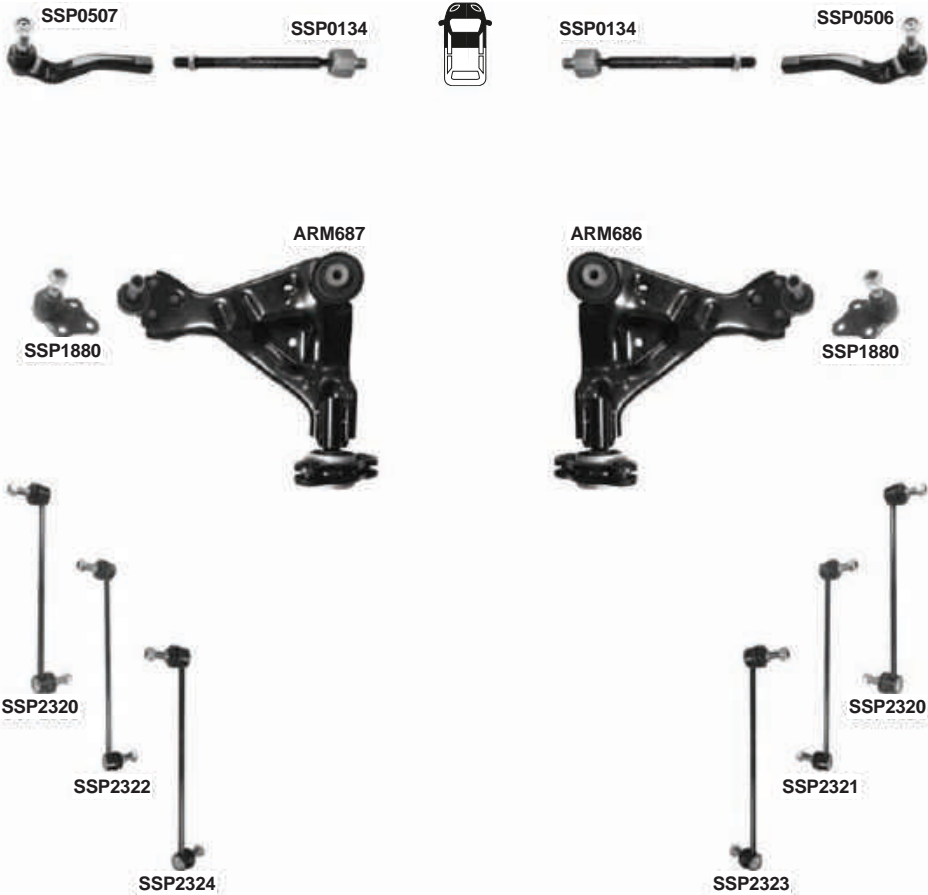

PART NO.	DESCRIPTION	NOTES	O.E.
ARM686	301181368600 Suspension Control Arm and Ball Joint Assembly - Front Right Lower		4473301507; A4473301507
ARM687	301181368700 Suspension Control Arm and Ball Joint Assembly - Front Left Lower		4473301407; A4473301407
SSP0134	301191601340 Steering Tie Rod - Front		4474600055; A4474600055
SSP0506	301191605060 Steering Tie Rod End - Front Right		4474600148; A4474600148
SSP0507	301191605070 Steering Tie Rod End - Front Left		4474600048; A4474600048
SSP1880	301191618800 Suspension Ball Joint - Front Lower		4473330127
SSP2320	301191623200 Suspension Stabilizer Bar Link - Front		4473200489; A4473200489
SSP2321	301191623210 Suspension Stabilizer Bar Link - Front Right		4473200389; A4473200389
SSP2322	301191623220 Suspension Stabilizer Bar Link - Front Left		4473200089; A4473200089
SSP2323	301191623230 Suspension Stabilizer Bar Link - Front Right		4473200289; A4473200289
SSP2324	301191623240 Suspension Stabilizer Bar Link - Front Left		4473200189; A4473200189



MERCURY COUGAR



08/1998-12/2001



SSP2217



SSP2217

PART NO.	DESCRIPTION	NOTES	O.E.
SSP2217 301191622170	Suspension Stabilizer Bar Link - Front	L=237,5mm	1S713B438AC; 2T1Z5K484AA; 6960036; 93BB3B438CA; 7T1Z5K484A



MERCURY MILAN



2006-2011

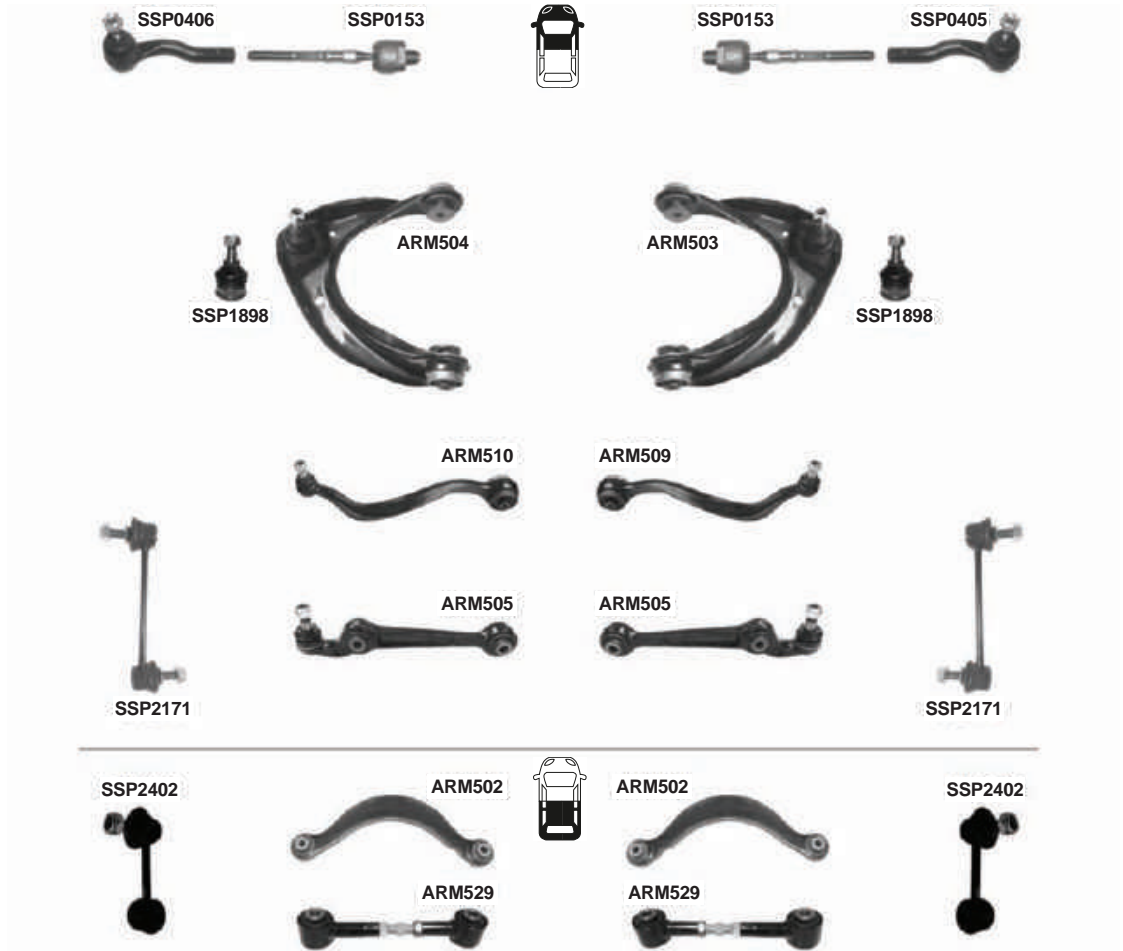

**MERCURY MILAN**

2006-2011

PART NO.	DESCRIPTION	NOTES	O.E.
ARM502	301181350200	Lateral Arm - Rear Upper	AE5Z5500A; G26A28C10
ARM503	301181350300	Suspension Control Arm and Ball Joint Assembly - Front Right Upper	AE5Z3084A
ARM504	301181350400	Suspension Control Arm and Ball Joint Assembly - Front Left Upper	AE5Z3085A
ARM505	301181350500	Suspension Control Arm and Ball Joint Assembly - Front Lower	AE5Z3078A
ARM509	301181350900	Suspension Control Arm and Ball Joint Assembly - Front Right	BE5Z3078B; 7E5Z3078L; GJ6A34J00D; GJ6A34J00C; GJ6A34J00B
ARM510	301181351000	Suspension Control Arm and Ball Joint Assembly - Front Left	BE5Z3079B; 7E5Z3079L; GJ6A34J50D; GJ6A34J50C; GJ6A34J50B
ARM529	301181352900	Lateral Arm - Rear Lower	9E5Z5500A; G26A28500A; G26A28500D; G26A28500B; G62A28500B; GJ6A28500D; GK2A28500
SSP0153	301191601530	Steering Tie Rod - Front	6E5Z3332B; GJ6E32240
SSP0405	301191604050	Steering Tie Rod End - Front Right	AE5Z3A130B
SSP0406	301191604060	Steering Tie Rod End - Front Left	AE5Z3A130A
SSP1898	301191618980	Suspension Ball Joint - Front Upper	GJ6A34540
SSP2171	301191621710	Suspension Stabilizer Bar Link - Front	AE5Z5K483A
SSP2402	301191624020	Suspension Stabilizer Bar Link - Rear	5M8Z5A486A; GJ6A28170A



MINI Cooper (R50, R53)



05/2001-09/2006



SSP1911



SSP1910



SSP1909



SSP1909



ARM830



ARM829



SSP2435

SSP2433

SSP2434



SSP2435

SSP2433

SSP2434



SSP2432



SSP2432



MINI Cooper (R50, R53)



05/2001-09/2006

PART NO.	DESCRIPTION	NOTES	O.E.
ARM829	301181382900	Suspension Control Arm Kit - Front Right	31126761410***
ARM830	301181383000	Suspension Control Arm Kit - Front Left	31126761409
SSP0167	301191601670	Steering Tie Rod - Front	M14x1,5 Rht - L=184mm 32116754563*; 32116754564*
SSP0560	301191605600	Steering Tie Rod End - Front Right	M14x1,5Rht 32216754566
SSP0561	301191605610	Steering Tie Rod End - Front Left	M14x1,5Rht 32216754565
SSP0562	301191605620	Steering Tie Rod End - Front Right	M14x1,5Rht 32116761560
SSP0563	301191605630	Steering Tie Rod End - Front Left	M14x1,5Rht 32136761559
SSP1909	301191619090	Suspension Ball Joint - Front Lower	31126783443; 32126756309
SSP1910	301191619100	Suspension Ball Joint - Front Right	31106779438; 31126753992
SSP1911	301191619110	Suspension Ball Joint - Front Left	31106779437; 31126753991
SSP2432	301191624320	Suspension Stabilizer Bar Link - Rear	L=233mm 33551507999
SSP2433	301191624330	Suspension Stabilizer Bar Link - Front	Only : Cooper L=331mm 31351507989
SSP2434	301191624340	Suspension Stabilizer Bar Link - Front	Only : Cooper L=331mm 31356759537
SSP2435	301191624350	Suspension Stabilizer Bar Link - Front	Only : Cooper (Clip-on patented design) L=331mm 31356759537*



MINI Cooper (R52)



07/2004-11/2007



SSP1911



SSP1910



SSP1909



SSP1909



SSP2434



SSP2434



MINI Cooper (R52)



07/2004-11/2007

PART NO.	DESCRIPTION	NOTES	O.E.
ARM829	301181382900	Suspension Control Arm Kit - Front Right	31126761410***
ARM830	301181383000	Suspension Control Arm Kit - Front Left	31126761409
SSP0167	301191601670	Steering Tie Rod - Front	M14x1,5 Rht - L=184mm 32116754563*; 32116754564*
SSP0562	301191605620	Steering Tie Rod End - Front Right	M14x1,5Rht 32116761560
SSP0563	301191605630	Steering Tie Rod End - Front Left	M14x1,5Rht 32136761559
SSP1909	301191619090	Suspension Ball Joint - Front Lower	31126783443; 32126756309
SSP1910	301191619100	Suspension Ball Joint - Front Right	31106779438; 31126753992
SSP1911	301191619110	Suspension Ball Joint - Front Left	31106779437; 31126753991
SSP2432	301191624320	Suspension Stabilizer Bar Link - Rear	L=233mm 33551507999
SSP2434	301191624340	Suspension Stabilizer Bar Link - Front	Only : Cooper L=331mm 31356759537
SSP2435	301191624350	Suspension Stabilizer Bar Link - Front	Only : Cooper (Clip-on patented design) L=331mm 31356759537*

MINI Cooper (F55,F56)



07/2014-

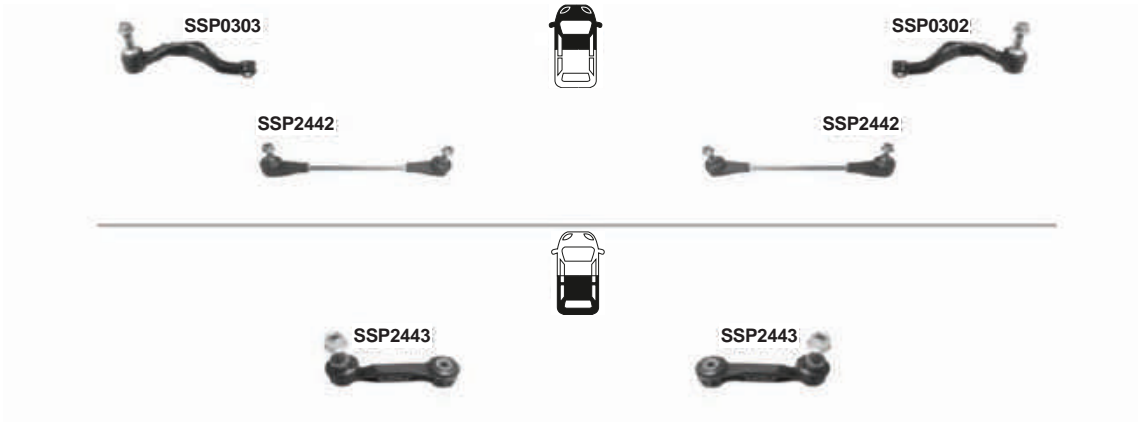

PART NO.	DESCRIPTION	NOTES	O.E.
ARM248 301181324800	Lateral Arm - Rear Upper		33326870773; 33326851563
SSP0169 301191601690	Steering Tie Rod - Front		Part of 32106854733; Part of 32106854736
SSP0302 301191603020	Steering Tie Rod End - Front Right		32106867405; 32106854734
SSP0303 301191603030	Steering Tie Rod End - Front Left		32106867404; 32106854737
SSP2442 301191624420	Suspension Stabilizer Bar Link - Front	A = 320 MM	31306862863
SSP2443 301191624430	Suspension Stabilizer Bar Link - Rear		33506862865



MINI Cooper (R55, R56)



09/2006-05/2010



SSP1914



SSP1912



SSP1912



SSP1913



SSP2437



SSP2437



SSP2436



MINI Cooper (R55, R56)



09/2006-05/2010

	PART NO.	DESCRIPTION	NOTES	O.E.
ARM831	301181383100	Suspension Control Arm Kit - Front Right		31126772302*
ARM832	301181383200	Suspension Control Arm Kit - Front Left Lower		31126772301*
SSP0168	301191601680	Steering Tie Rod - Front	M14x1,5 - L=195,5 mm	32106778548 Part of
SSP0564	301191605640	Steering Tie Rod End - Front Right	M14x1,5	32106778438
SSP0565	301191605650	Steering Tie Rod End - Front Left	M14x1,5	32106778437
SSP1912	301191619120	Suspension Ball Joint - Front		31126772305
SSP1913	301191619130	Suspension Ball Joint - Front Right Lower		31126772304
SSP1914	301191619140	Suspension Ball Joint - Front Left Lower		31126772303
SSP2436	301191624360	Suspension Stabilizer Bar Link - Rear	L=233mm	33506772789
SSP2437	301191624370	Suspension Stabilizer Bar Link - Front	L=299mm	31356778831



MINI Cooper Clubman (F55,F56)



07/2014-



PART NO.	DESCRIPTION	NOTES	O.E.
SSP2032 301191620320	Suspension Stabilizer Bar Link - Front		31306862864

MINI Cooper Countryman (R60)



06/2010-12/2014



PART NO.	DESCRIPTION	NOTES	O.E.
ARM833	301181383300 Suspension Control Arm and Ball Joint Assembly - Front Right		31129806520
ARM834	301181383400 Suspension Control Arm and Ball Joint Assembly - Front Left		31129806519
SSP0168	301191601680 Steering Tie Rod - Front	M14x1,5 - L=195,5 mm	32106778548 Part of
SSP0566	301191605660 Steering Tie Rod End - Front Right	M14x1,5	32109805552
SSP0567	301191605670 Steering Tie Rod End - Front Left	M14x1,5	32109805551
SSP0568	301191605680 Steering Tie Rod End - Front Right	M14x1,5	32109808840
SSP0569	301191605690 Steering Tie Rod End - Front Left	M14x1,5	32109808839
SSP1915	301191619150 Suspension Ball Joint - Front		31109803662
SSP2436	301191624360 Suspension Stabilizer Bar Link - Rear	L=233mm	33506772789
SSP2438	301191624380 Suspension Stabilizer Bar Link - Front Right		31359806352
SSP2439	301191624390 Suspension Stabilizer Bar Link - Front Left		31359806351
SSP2440	301191624400 Suspension Stabilizer Bar Link - Rear Right		33509803516
SSP2441	301191624410 Suspension Stabilizer Bar Link - Rear Left		33509803515



MITSUBISHI 3000GT



1991-1999



PART NO.	DESCRIPTION	NOTES	O.E.
SSP0551 301191605510	Steering Tie Rod End - Front		5682036000; MB912519; MB192430; MB616286



MITSUBISHI ASX (GA,W)



02/2010-

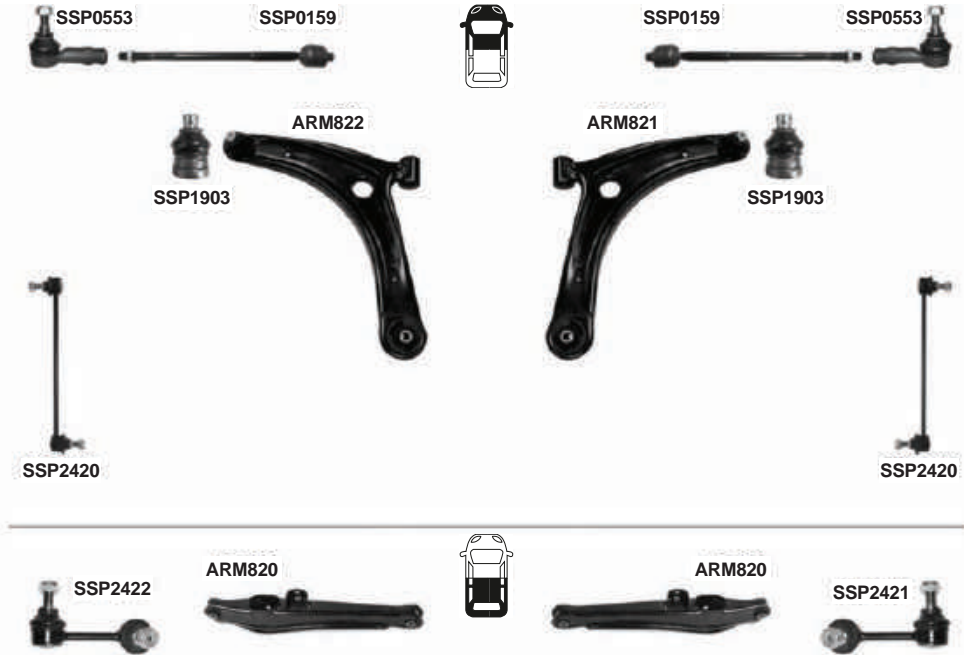

PART NO.	DESCRIPTION	NOTES	O.E.
ARM820 301181382000	Lateral Arm - Rear Lower		4113A011; 1606293080
ARM821 301181382100	Suspension Control Arm and Ball Joint Assembly - Front Right Lower		4013A010; 4013A282; 4013A428
ARM822 301181382200	Suspension Control Arm and Ball Joint Assembly - Front Left Lower		4013A009; 4013A281; 4013A427
SSP0159 301191601590	Steering Tie Rod - Front	M14X1,5 - L=340mm	4422A058; 4422A076
SSP0553 301191605530	Steering Tie Rod End - Front	M14X1,5	4422A002; 4422A052; 1607502480
SSP1903 301191619030	Suspension Ball Joint - Front Lower		Part of 352V0/3521R1/4013A009/4013A0010
SSP2420 301191624200	Suspension Stabilizer Bar Link - Front	L=265mm	5087.58; MN101368
SSP2421 301191624210	Suspension Stabilizer Bar Link - Rear Right	L=80mm	5178.49; MN184194
SSP2422 301191624220	Suspension Stabilizer Bar Link - Rear Left	L=80mm	4156A014; 5178.48



MITSUBISHI CARISMA



07/1995-09/2000

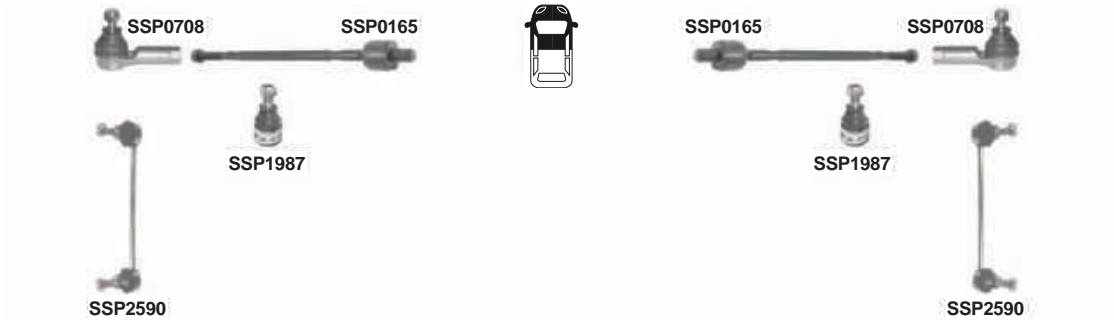

PART NO.	DESCRIPTION	NOTES	O.E.
SSP0165 301191601650	Steering Tie Rod - Front	M12x1,25 - L=310mm	3345797; MB297969; MR244901
SSP0708 301191607080	Steering Tie Rod End - Front	M12x1,25Rht	30870695; MB598023; MB912076; MB241982; 30875012
SSP1987 301191619870	Suspension Ball Joint - Front		30821650*; MB518961; MB303374; 30821651*
SSP2590 301191625900	Suspension Stabilizer Bar Link - Front	L=200mm	30871770; MR131680; 30884358; 30873100



MITSUBISHI CARISMA



09/2000-06/2006

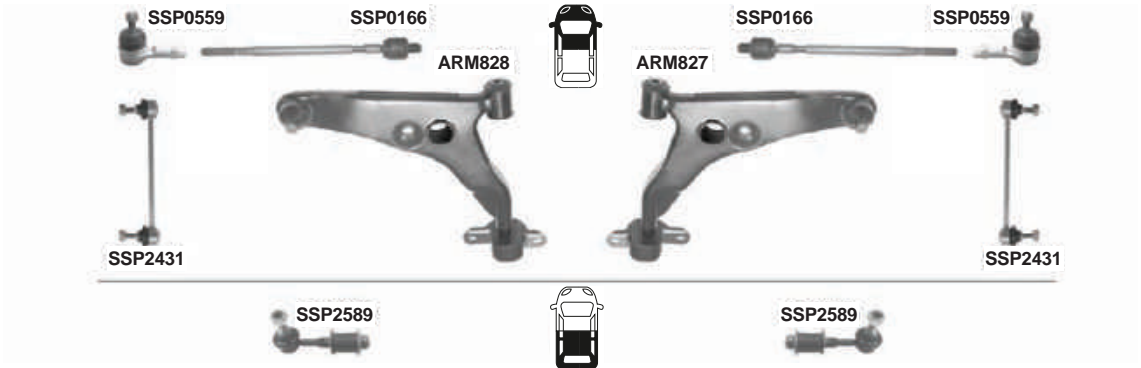

PART NO.	DESCRIPTION	NOTES	O.E.
ARM827	301181382700 Suspension Control Arm and Ball Joint Assembly - Front Right Lower		MR911569; MR916134
ARM828	301181382800 Suspension Control Arm and Ball Joint Assembly - Front Left Lower		MR911570; MR916133
SSP0166	301191601660 Steering Tie Rod - Front	M12x1,25 - L=316,5mm	MR403027
SSP0559	301191605590 Steering Tie Rod End - Front	M12x1,25	MR485672
SSP2431	301191624310 Suspension Stabilizer Bar Link - Front	L=201mm	MR272116
SSP2589	301191625890 Suspension Stabilizer Bar Link - Rear	L=103,5 mm	30852103; MR272118; M884359; 30884359



MITSUBISHI COLT I - II



1978-1988

SSP0550



SSP0550



PART NO.	DESCRIPTION	NOTES	O.E.
SSP0550 301191605500	Steering Tie Rod End - Front Outer	M14x1,5Rht	5687243010; MB166426; MB527650



MITSUBISHI COLT III



04/1988-05/1992



SSP2414



SSP2414

PART NO.	DESCRIPTION	NOTES	O.E.
SSP2414 301191624140	Suspension Stabilizer Bar Link - Front	L=60mm	4056A014; MB892982; MB518982; MB573043



MAGNETI
MARELLI

MITSUBISHI COLT V



03/1996-09/2002

SSP0552



SSP0552



PART NO.	DESCRIPTION	NOTES	O.E.
SSP0552 301191605520	Steering Tie Rod End - Front	M12x1,25Rht	30870695; MB527169; MR535996; 30875012; MB241982



MITSUBISHI COLT VI



10/2002-06/2012



	PART NO.	DESCRIPTION	NOTES	O.E.
ARM825	301181382500	Suspension Control Arm and Ball Joint Assembly - Front Right Lower		4013A150; MN186217; 4543302607; 4543300707
ARM826	301181382600	Suspension Control Arm and Ball Joint Assembly - Front Left Lower		4013A135; MN186218; 4543301907; 4543300807
SSP0558	301191605580	Steering Tie Rod End - Front	M12X1,25	4544600205; MR977606
SSP2538	301191625380	Suspension Stabilizer Bar Link - Front	L=325,5mm	4543200010; MR961477



MITSUBISHI ECLIPSE 1G, 2G, 3G

1990-2005



PART NO.	DESCRIPTION	NOTES	O.E.
SSP0551 301191605510	Steering Tie Rod End - Front		5682036000; MB912519; MB192430; MB616286

MITSUBISHI Expo



05/1991-12/2004

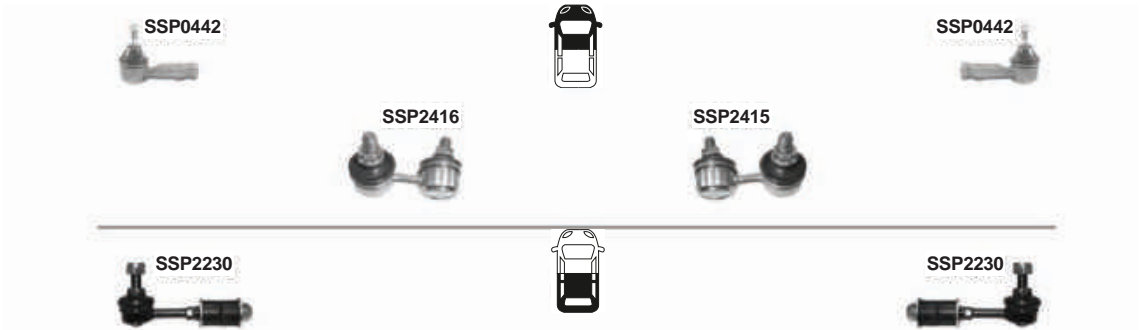

PART NO.	DESCRIPTION	NOTES	O.E.
SSP0442 301191604420	Steering Tie Rod End - Front	M12x1,25Rht	5682028000; MB912076
SSP2230 301191622300	Suspension Stabilizer Bar Link - Rear	L=115mm	555304A001; MR267875
SSP2415 301191624150	Suspension Stabilizer Bar Link - Front Right	L=51mm	MB808076
SSP2416 301191624160	Suspension Stabilizer Bar Link - Front Left	L=51mm	MB672370



MAGNETI
MARELLI

MITSUBISHI GALANT III



06/1983-10/1988



SSP0551



SSP0551



SSP1987



SSP1987

	PART NO.	DESCRIPTION	NOTES	O.E.
SSP0551	301191605510	Steering Tie Rod End - Front	Outer M14x1,5Rht	5682036000; MB912519; MB192430; MB616286
SSP1987	301191619870	Suspension Ball Joint - Front		30821650*; MB518961; MB303374; 30821651*



mitsubishi GALANT V



1992-1996

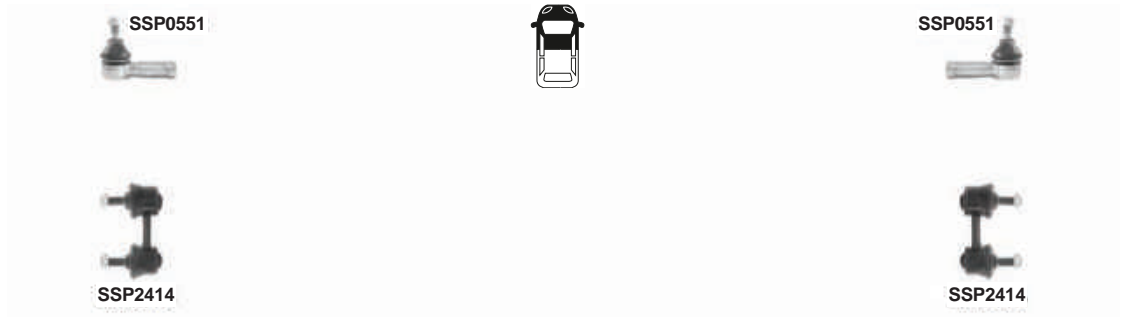

	PART NO.	DESCRIPTION	NOTES	O.E.
SSP0551	301191605510	Steering Tie Rod End - Front	Outer M14x1,5Rht	5682036000; MB912519; MB192430; MB616286
SSP2414	301191624140	Suspension Stabilizer Bar Link - Front	L=60mm	4056A014; MB892982; MB518982; MB573043

**MITSUBISHI GALANT VI**

1996-2004



	PART NO.	DESCRIPTION	NOTES	O.E.
SSP0551	301191605510	Steering Tie Rod End - Front	Outer M14x1,5Rht	5682036000; MB912519; MB192430; MB616286
SSP2150	301191621500	Suspension Stabilizer Bar Link - Front Right		MR333763
SSP2151	301191621510	Suspension Stabilizer Bar Link - Front Left		MR297333



MITSUBISHI L200



2000-10/2005

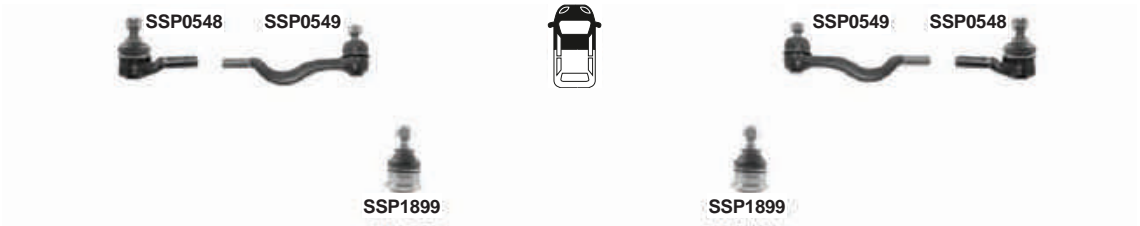

PART NO.	DESCRIPTION	NOTES	O.E.
SSP0548 301191605480	Steering Tie Rod End - Front Outer	M16x1,5Lht	MR241032
SSP0549 301191605490	Steering Tie Rod End - Front Inner	M16x1,5Rht	MR241031
SSP1899 301191618990	Suspension Ball Joint - Front Upper		5441744000; MB109585

**MITSUBISHI L200 (KB_T,KA_T)**

11/2005-

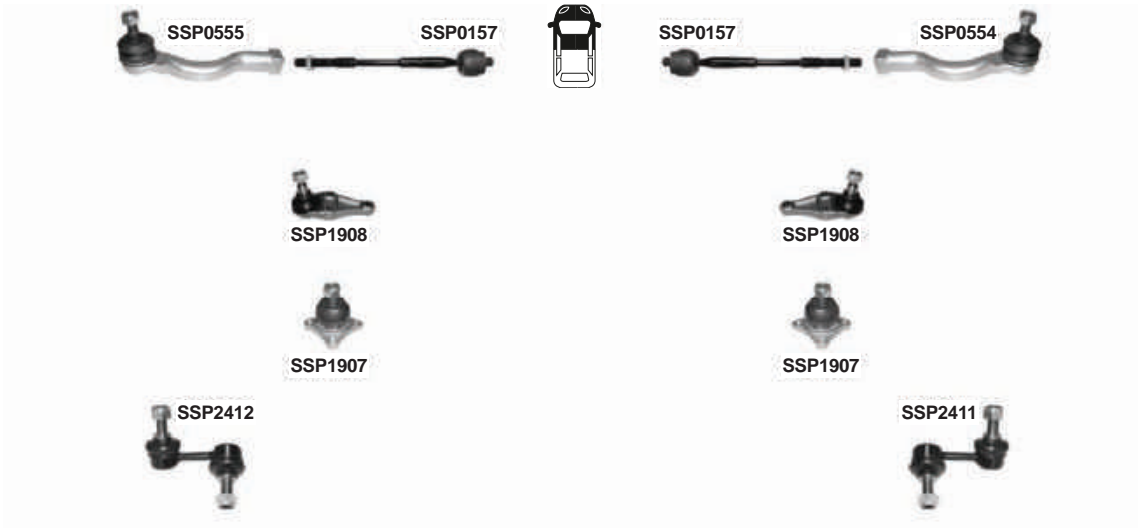

PART NO.	DESCRIPTION	NOTES	O.E.
SSP0157 301191601570	Steering Tie Rod - Front	L=311 mm - M16X1,5	4410A172
SSP0164 301191601640	Steering Tie Rod - Front	For vehicules with bad rod equipment	4410A173
SSP0554 301191605540	Steering Tie Rod End - Front Right	M16X1,5	4422A010; MR508136
SSP0555 301191605550	Steering Tie Rod End - Front Left	M16X1,5	4422A009; MR508135
SSP1907 301191619070	Suspension Ball Joint - Front Lower		14013040; 4013A090; MR496799
SSP1908 301191619080	Suspension Ball Joint - Front Upper		4010A015; MR496792
SSP2411 301191624110	Suspension Stabilizer Bar Link - Front Right	L=65mm	MR992310
SSP2412 301191624120	Suspension Stabilizer Bar Link - Front Left	L=65mm	MR992309



MITSUBISHI L300 2nd Gen



1978-1982



SSP1899



SSP1899

PART NO.	DESCRIPTION	NOTES	O.E.
SSP1899 301191618990	Suspension Ball Joint - Front Upper		5441744000; MB109585



MITSUBISHI L300



1982-1986



PART NO.	DESCRIPTION	NOTES	O.E.
SSP0551 301191605510	Steering Tie Rod End - Front		5682036000; MB912519; MB192430; MB616286



MITSUBISHI L300



1986-02/2006



PART NO.	DESCRIPTION	NOTES	O.E.
SSP0550 301191605500	Steering Tie Rod End - Front Outer	M14x1,5Rht	5687243010; MB166426; MB527650
SSP1900 301191619000	Suspension Ball Joint - Front Lower		5452443301; MB349475; MB527383; 545244330A; MB176309
SSP1901 301191619010	Suspension Ball Joint - Front Upper		544174AA00; MB527350; MR241623; MB241623; MB527349
SSP2413 301191624130	Suspension Stabilizer Bar Link - Front		MB527385



MAGNETI
MARELLI

MITSUBISHI LANCER III



1982-1987



SSP2414

SSP2414

PART NO.	DESCRIPTION	NOTES	O.E.
SSP0552 301191605520	Steering Tie Rod End - Front	M12x1,25Rht	30870695; MB527169; MR535996; 30875012; MB241982
SSP2414 301191624140	Suspension Stabilizer Bar Link - Front	L=60mm	4056A014; MB892982; MB518982; MB573043



MITSUBISHI LANCER (CS, A)



09/2003-07/2008

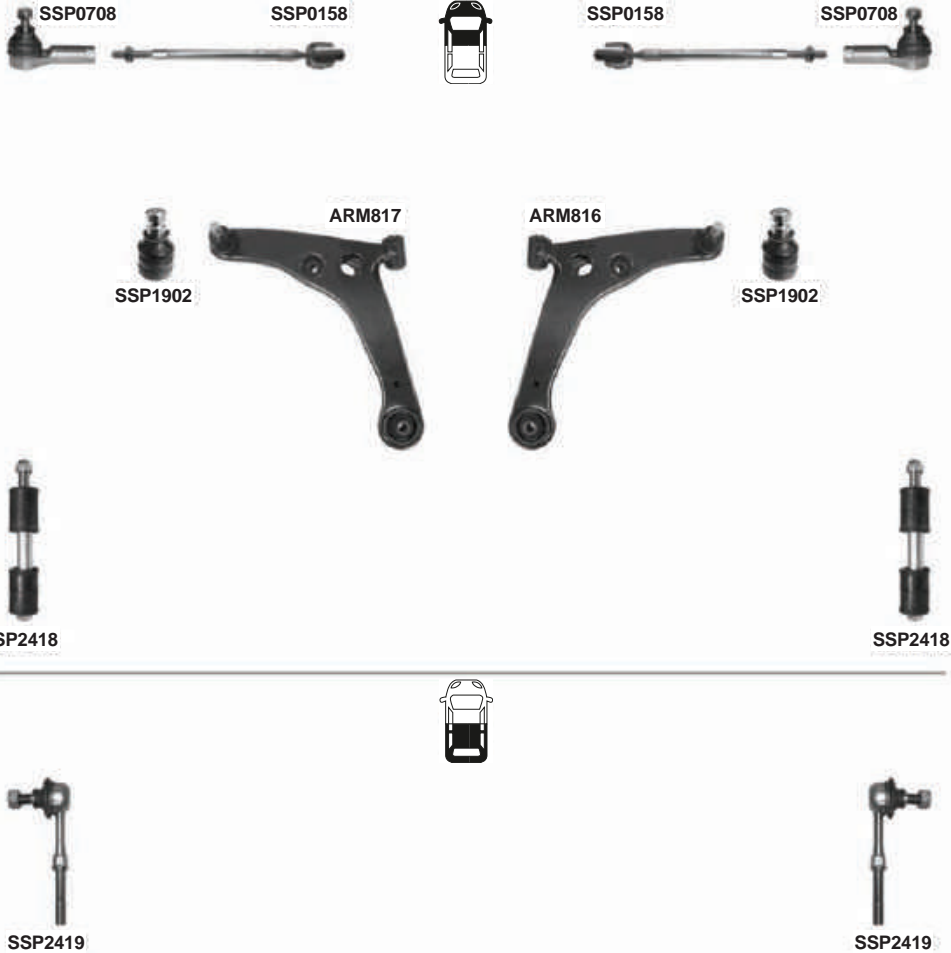

PART NO.	DESCRIPTION	NOTES	O. E.
ARM816	301181381600 Suspension Control Arm and Ball Joint Assembly - Front Right Lower		MR403420
ARM817	301181381700 Suspension Control Arm and Ball Joint Assembly - Front Left Lower		MR403419
SSP0158	301191601580 Steering Tie Rod - Front	M12X1,25 - L=310mm	4422A056; MR491358
SSP0708	301191607080 Steering Tie Rod End - Front	M12x1,25Rht	30870695; MB598023; MB912076; MB241982; 30875012
SSP1902	301191619020 Suspension Ball Joint - Front Lower		MB518206
SSP2418	301191624180 Suspension Stabilizer Bar Link - Front	M10x1,25 - L=131mm	MR954887
SSP2419	301191624190 Suspension Stabilizer Bar Link - Rear	L=116mm	4056A037



MITSUBISHI LANCER (CY2A-CZ4A) 06/2008-



PART NO.	DESCRIPTION	NOTES	O.E.
ARM818 301181381800	Lateral Arm - Rear Forward	L=165.5mm	4117A007; MR491911
ARM819 301181381900	Lateral Arm - Rear Upper	L=315mm	4110A085
ARM820 301181382000	Lateral Arm - Rear Lower		4113A011; 1606293080
ARM821 301181382100	Suspension Control Arm and Ball Joint Assembly - Front Right Lower		4013A010; 4013A282; 4013A428
ARM822 301181382200	Suspension Control Arm and Ball Joint Assembly - Front Left Lower		4013A009; 4013A281; 4013A427
SSP0159 301191601590	Steering Tie Rod - Front	M14X1,5 - L=340mm	4422A058; 4422A076
SSP0553 301191605530	Steering Tie Rod End - Front	M14X1,5	4422A002; 4422A052; 1607502480
SSP1903 301191619030	Suspension Ball Joint - Front Lower		Part of 352V0/3521R1/4013A009/4013A0010
SSP2420 301191624200	Suspension Stabilizer Bar Link - Front	L=265mm	5087.58; MN101368



MITSUBISHI MIRAGE 3rd Gen



1988-1992



PART NO.	DESCRIPTION	NOTES	O.E.
SSP0552 301191605520	Steering Tie Rod End - Front	M12x1,25Rht	30870695; MB527169; MR535996; 30875012; MB241982
SSP2414 301191624140	Suspension Stabilizer Bar Link - Front	L=60mm	4056A014; MB892982; MB518982; MB573043

**MITSUBISHI MONTERO II**

1990-2000

**SSP1904****SSP1906****SSP1905****SSP1904**

PART NO.	DESCRIPTION	NOTES	O.E.
SSP1904 301191619040	Suspension Ball Joint - Front Upper		MB860829; MB860830
SSP1905 301191619050	Suspension Ball Joint - Front Left Lower		MB296269; MB831037
SSP1906 301191619060	Suspension Ball Joint - Front Right Lower		MB831038; MR296270



MITSUBISHI MONTERO III



04/2000-01/2007

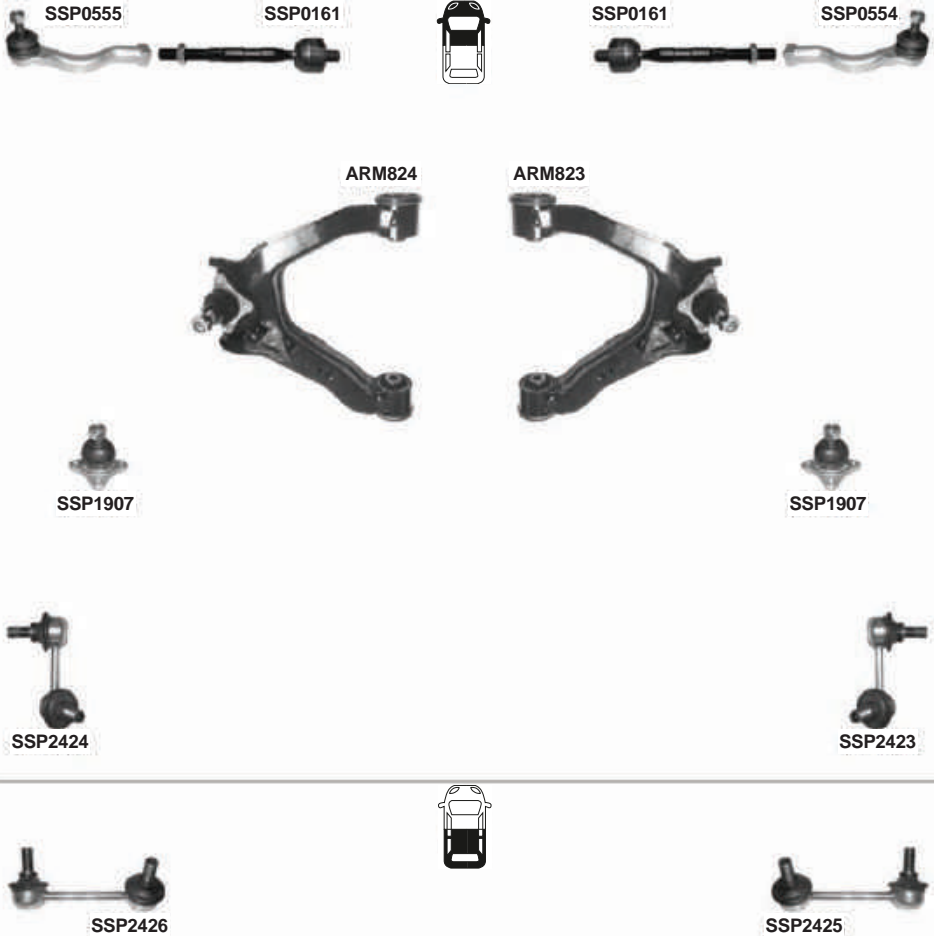

PART NO.	DESCRIPTION	NOTES	O.E.
ARM823	301181382300 Suspension Control Arm and Ball Joint Assembly - Front Right Upper		4010A038; MR496794; 4010A042; 4010A140
ARM824	301181382400 Suspension Control Arm and Ball Joint Assembly - Front Left Upper		4010A037; MR496793; 4010A041; 4010A139
SSP0161	301191601610 Steering Tie Rod - Front	M16x1.5 - L=205 mm	MR510267
SSP0554	301191605540 Steering Tie Rod End - Front Right	M16X1,5	4422A010; MR508136
SSP0555	301191605550 Steering Tie Rod End - Front Left	M16X1,5	4422A009; MR508135
SSP1907	301191619070 Suspension Ball Joint - Front Lower		14013040; 4013A090; MR496799
SSP2423	301191624230 Suspension Stabilizer Bar Link - Front Right	L=78mm	4056A105; MB267876; MR374522
SSP2424	301191624240 Suspension Stabilizer Bar Link - Front Left	L=78mm	4056A106; MB267877; MR374521
SSP2425	301191624250 Suspension Stabilizer Bar Link - Rear Right	L=115mm	4056A37; MR418053
SSP2426	301191624260 Suspension Stabilizer Bar Link - Rear Left	L=115mm	MR418052



MITSUBISHI MONTERO IV



02/2007-

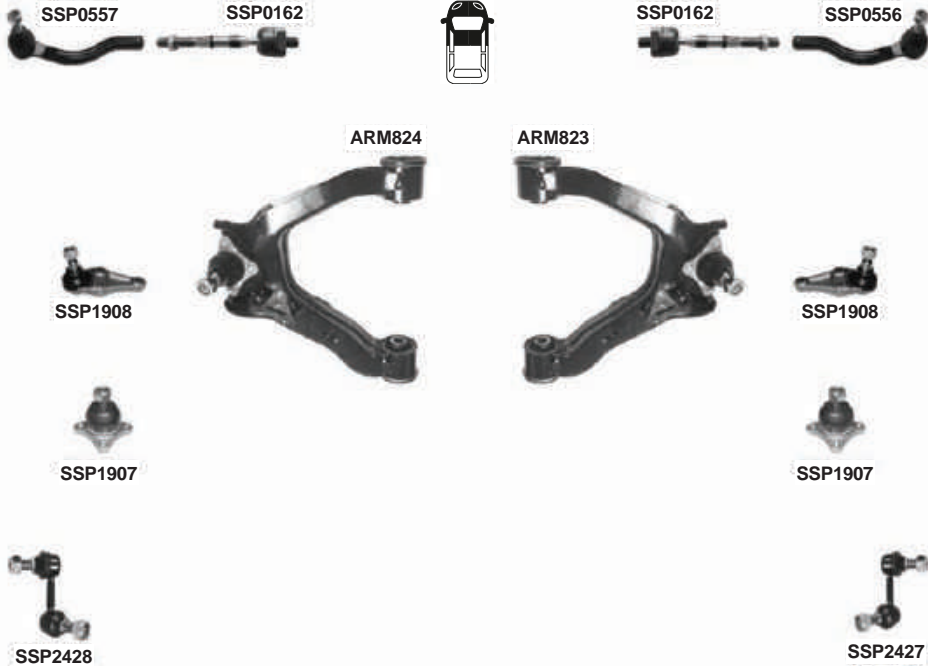

PART NO.	DESCRIPTION	NOTES	O. E.
ARM823	301181382300 Suspension Control Arm and Ball Joint Assembly - Front Right Upper		4010A038; MR496794; 4010A042; 4010A140
ARM824	301181382400 Suspension Control Arm and Ball Joint Assembly - Front Left Upper		4010A037; MR496793; 4010A041; 4010A139
SSP0162	301191601620 Steering Tie Rod - Front	M16x1.5 /L =189MM	4422A036
SSP0556	301191605560 Steering Tie Rod End - Front Right	M16x1.5	4422A038
SSP0557	301191605570 Steering Tie Rod End - Front Left	M16x1.5	4422A037
SSP1907	301191619070 Suspension Ball Joint - Front Lower		14013040; 4013A090; MR496799
SSP1908	301191619080 Suspension Ball Joint - Front Upper		4010A015; MR496792
SSP2427	301191624270 Suspension Stabilizer Bar Link - Front Right	L=78mm	4056A134; MR992192
SSP2428	301191624280 Suspension Stabilizer Bar Link - Front Left	L=78mm	4056A133; MR992191
SSP2429	301191624290 Suspension Stabilizer Bar Link - Rear Right	L=115mm	4056A112; MR418053
SSP2430	301191624300 Suspension Stabilizer Bar Link - Rear Left	L=115mm	4056A111; MR418052



MITSUBISHI OUTLANDER I



03/2001-10/2006



	PART NO.	DESCRIPTION	NOTES	O.E.
SSP0160	301191601600	Steering Tie Rod - Front	M14x1.5 - L=322mm	3812.F1; 4422A012; 4422A057
SSP0553	301191605530	Steering Tie Rod End - Front	M14X1,5	4422A002; 4422A052; 1607502480
SSP1902	301191619020	Suspension Ball Joint - Front Lower		MB518206

**MITSUBISHI OUTLANDER II**

11/2006-07/2012



	PART NO.	DESCRIPTION	NOTES	O.E.
ARM820	301181382000	Lateral Arm - Rear Lower		4113A011; 1606293080
ARM821	301181382100	Suspension Control Arm and Ball Joint Assembly - Front Right Lower		4013A010; 4013A282; 4013A428
ARM822	301181382200	Suspension Control Arm and Ball Joint Assembly - Front Left Lower		4013A009; 4013A281; 4013A427
SSP0160	301191601600	Steering Tie Rod - Front	M14x1.5 - L=322mm	3812.F1; 4422A012; 4422A057
SSP0553	301191605530	Steering Tie Rod End - Front	M14X1,5	4422A002; 4422A052; 1607502480
SSP1903	301191619030	Suspension Ball Joint - Front Lower		Part of 352V0/3521R1/4013A009/4013A0010
SSP2420	301191624200	Suspension Stabilizer Bar Link - Front	L=265mm	5087.58; MN101368
SSP2421	301191624210	Suspension Stabilizer Bar Link - Rear Right	L=80mm	5178.49; MN184194
SSP2422	301191624220	Suspension Stabilizer Bar Link - Rear Left	L=80mm	4156A014; 5178.48



PART NO.	DESCRIPTION	NOTES	O.E.
ARM821 301181382100	Suspension Control Arm and Ball Joint Assembly - Front Right Lower		4013A010; 4013A282; 4013A428
ARM822 301181382200	Suspension Control Arm and Ball Joint Assembly - Front Left Lower		4013A009; 4013A281; 4013A427
SSP0160 301191601600	Steering Tie Rod - Front	M14x1.5 - L=322mm	3812.F1; 4422A012; 4422A057
SSP0553 301191605530	Steering Tie Rod End - Front	M14X1,5	4422A002; 4422A052; 1607502480
SSP1903 301191619030	Suspension Ball Joint - Front Lower	MI-478 / MI-479	Part of 352V0/3521R1/4013A009/4013A0010
SSP2420 301191624200	Suspension Stabilizer Bar Link - Front	L=265mm	5087.58; MN101368
SSP2421 301191624210	Suspension Stabilizer Bar Link - Rear Right	L=80mm	5178.49; MN184194
SSP2422 301191624220	Suspension Stabilizer Bar Link - Rear Left	L=80mm	4156A014; 5178.48



MITSUBISHI Outlander Sport (GA,W) 02/2010-

SSP0553



SSP0159



SSP0159



SSP0553



SSP1903

ARM822



ARM821



SSP1903



SSP2420



SSP2420



SSP2422



ARM820



ARM820



SSP2421



PART NO.	DESCRIPTION	NOTES	O.E.
ARM820 301181382000	Lateral Arm - Rear Lower		4113A011; 1606293080
ARM821 301181382100	Suspension Control Arm and Ball Joint Assembly - Front Right Lower		4013A010; 4013A282; 4013A428
ARM822 301181382200	Suspension Control Arm and Ball Joint Assembly - Front Left Lower		4013A009; 4013A281; 4013A427
SSP0159 301191601590	Steering Tie Rod - Front	M14X1,5 - L=340mm	4422A058; 4422A076
SSP0553 301191605530	Steering Tie Rod End - Front	M14X1,5	4422A002; 4422A052; 1607502480
SSP1903 301191619030	Suspension Ball Joint - Front Lower		Part of 352V0/3521R1/4013A009/4013A0010
SSP2420 301191624200	Suspension Stabilizer Bar Link - Front	L=265mm	5087.58; MN101368
SSP2421 301191624210	Suspension Stabilizer Bar Link - Rear Right	L=80mm	5178.49; MN184194
SSP2422 301191624220	Suspension Stabilizer Bar Link - Rear Left	L=80mm	4156A014; 5178.48



MITSUBISHI PAJERO III



04/2000-01/2007

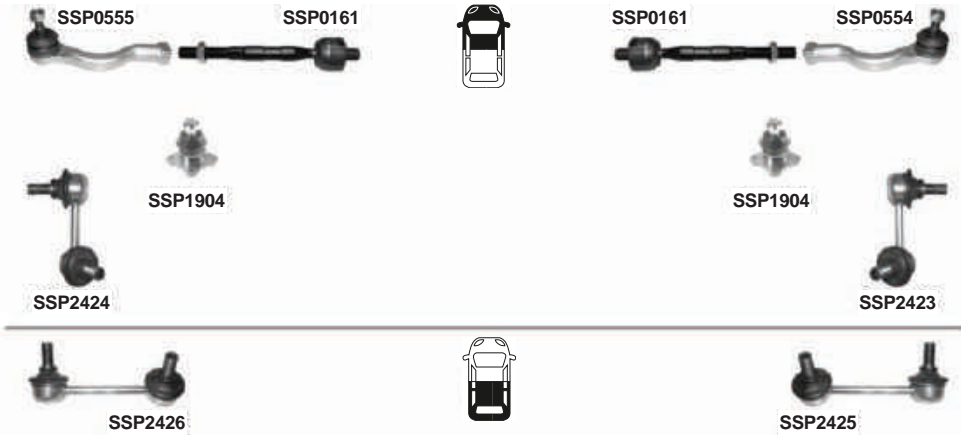

PART NO.	DESCRIPTION	NOTES	O.E.
SSP0161 301191601610	Steering Tie Rod - Front	M16x1.5 - L=205 mm	MR510267
SSP0554 301191605540	Steering Tie Rod End - Front Right	M16X1,5	4422A010; MR508136
SSP0555 301191605550	Steering Tie Rod End - Front Left	M16X1,5	4422A009; MR508135
SSP1904 301191619040	Suspension Ball Joint - Front Upper		MB860829; MB860830
SSP1995 301191619950	Suspension Ball Joint Kit - Front Lower		MR496799
SSP2423 301191624230	Suspension Stabilizer Bar Link - Front Right	L=78mm	4056A105; MB267876; MR374522
SSP2424 301191624240	Suspension Stabilizer Bar Link - Front Left	L=78mm	4056A106; MB267877; MR374521
SSP2425 301191624250	Suspension Stabilizer Bar Link - Rear Right	L=115mm	4056A37; MR418053
SSP2426 301191624260	Suspension Stabilizer Bar Link - Rear Left	L=115mm	MR418052



MITSUBISHI PAJERO IV



02/2007-

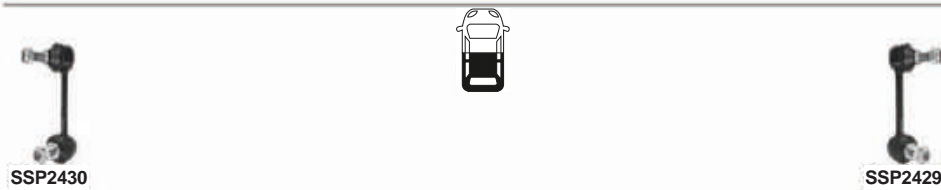
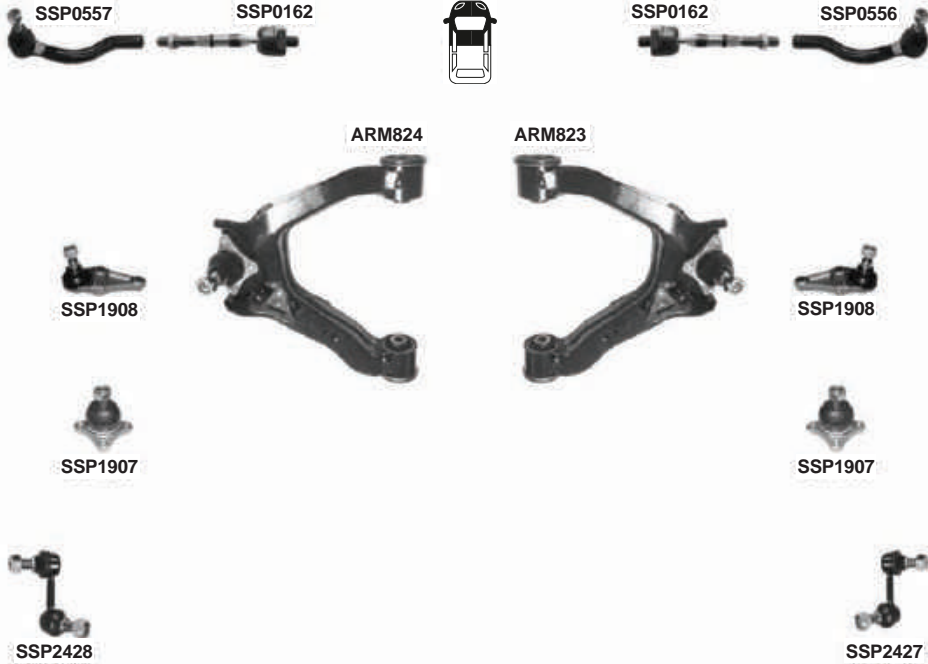

PART NO.	DESCRIPTION	NOTES	O.E.
ARM823	301181382300 Suspension Control Arm and Ball Joint Assembly - Front Right Upper		4010A038; MR496794; 4010A042; 4010A140
ARM824	301181382400 Suspension Control Arm and Ball Joint Assembly - Front Left Upper		4010A037; MR496793; 4010A041; 4010A139
SSP0162	301191601620 Steering Tie Rod - Front	M16x1.5 /L =189MM	4422A036
SSP0556	301191605560 Steering Tie Rod End - Front Right	M16x1.5	4422A038
SSP0557	301191605570 Steering Tie Rod End - Front Left	M16x1.5	4422A037
SSP1907	301191619070 Suspension Ball Joint - Front Lower		14013040; 4013A090; MR496799
SSP1908	301191619080 Suspension Ball Joint - Front Upper		4010A015; MR496792
SSP2427	301191624270 Suspension Stabilizer Bar Link - Front Right	L=78mm	4056A134; MR992192
SSP2428	301191624280 Suspension Stabilizer Bar Link - Front Left	L=78mm	4056A133; MR992191
SSP2429	301191624290 Suspension Stabilizer Bar Link - Rear Right	L=115mm	4056A112; MR418053
SSP2430	301191624300 Suspension Stabilizer Bar Link - Rear Left	L=115mm	4056A111; MR418052

MITSUBISHI PAJERO PININ



09/1999-06/2007

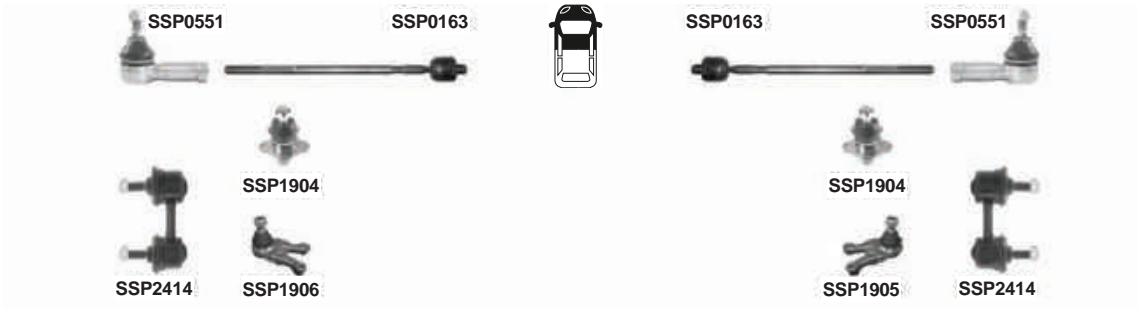

PART NO.	DESCRIPTION	NOTES	O.E.
SSP0163 301191601630	Steering Tie Rod - Front	M14x1.5 - L=346.7mm	MR448255
SSP0551 301191605510	Steering Tie Rod End - Front	Outer M14x1,5Rht	5682036000; MB912519; MB192430; MB616286
SSP1904 301191619040	Suspension Ball Joint - Front Upper		MB860829; MB860830
SSP1905 301191619050	Suspension Ball Joint - Front Left Lower		MB296269; MB831037
SSP1906 301191619060	Suspension Ball Joint - Front Right Lower		MB831038; MR296270
SSP2414 301191624140	Suspension Stabilizer Bar Link - Front	L=60mm	4056A014; MB892982; MB518982; MB573043



MAGNETI
MARELLI

MITSUBISHI RAIDER



2006-2009



PART NO.	DESCRIPTION	NOTES	O.E.
SSP1408 301181314080	Steering Tie Rod End - Front Outer		52013468AB; 68141049AA; 52013468AC

MITSUBISHI SPACE STAR



1998-2004



PART NO.	DESCRIPTION	NOTES	O.E.
SSP0166 301191601660	Steering Tie Rod - Front	M12x1,25 - L=316,5mm	MR403027
SSP0559 301191605590	Steering Tie Rod End - Front	M12x1,25	MR485672



MITSUBISHI Space Star



2012-



SSP2417



SSP2417



PART NO.	DESCRIPTION	NOTES	O.E.
SSP2417 301191624170	Suspension Stabilizer Bar Link - Front		4056A191; A



NISSAN ALMERA (N15)



07/1995-06/2000

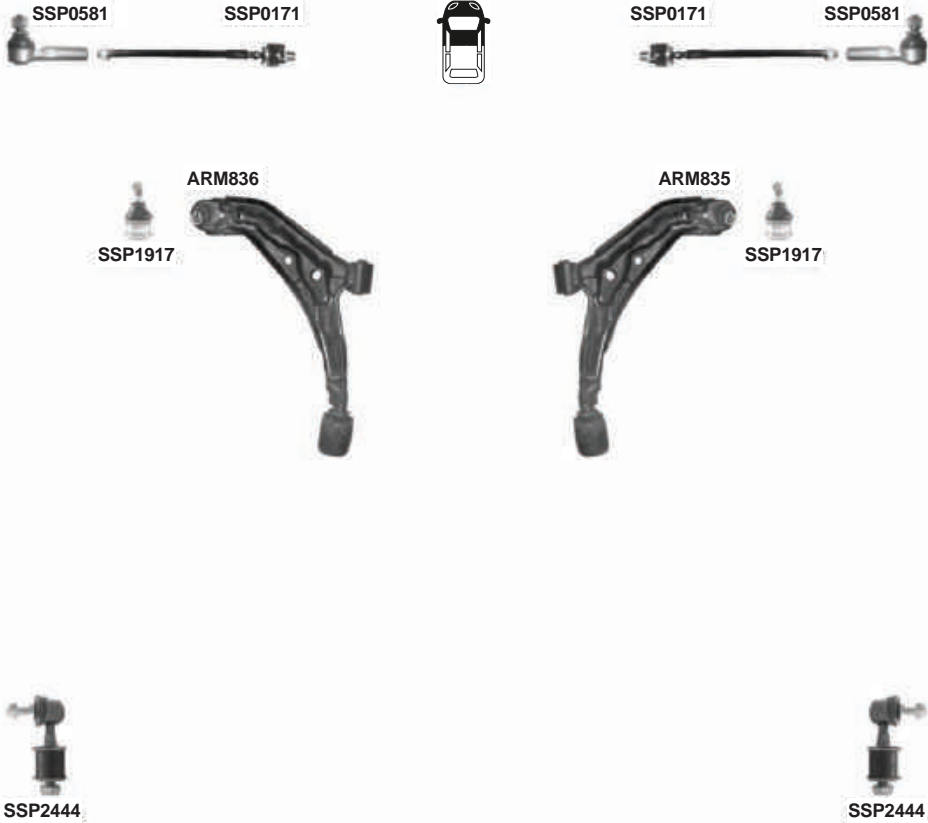

PART NO.	DESCRIPTION	NOTES	O.E.
ARM835 301181383500	Suspension Control Arm and Ball Joint Assembly - Front Right Lower		545000M010; 545004B000; 545000M020; 545000M060
ARM836 301181383600	Suspension Control Arm and Ball Joint Assembly - Front Left Lower		545010M010; 545010M020; 545010M060
SSP0171 301191601710	Steering Tie Rod - Front	Only: 1.4i-1.6i Manual Steering Mx12x1,25 - L=274mm	4852150Y00; 4852160Y05
SSP0581 301191605810	Steering Tie Rod End - Front	Only :1.4i - 1.6i M12x1,25Rht	482500M025
SSP1917 301191619170	Suspension Ball Joint - Front Lower		4016050Y00; 4016052Y00; 4016060Y20
SSP2444 301191624440	Suspension Stabilizer Bar Link - Front	L=36mm	5461850Y00; 54618D5010



NISSAN ALMERA (N16)



07/2000-09/2006



	PART NO.	DESCRIPTION	NOTES	O.E.
ARM861	301181386100	Suspension Control Arm and Ball Joint Assembly - Front Right Lower		545004M410
ARM862	301181386200	Suspension Control Arm and Ball Joint Assembly - Front Left Lower		545014M410
SSP0180	301191601800	Steering Tie Rod - Front	M12X1,5 - L=276mm	485214M527; 485214M588; 485214M528; 485214M587
SSP0582	301191605820	Steering Tie Rod End - Front Outer	M12X1,25	48520BM425
SSP0583	301191605830	Steering Tie Rod End - Front	Only : HB M14X1,5	48520 95F0A
SSP1916	301191619160	Suspension Ball Joint - Front Lower		4016050A00; 4016070J00; 4016050J25; 4016060Y60
SSP2466	301191624660	Suspension Stabilizer Bar Link - Front	L=36mm	546184M400



NISSAN ALMERA (N16)



08/2000-07/2006



SSP0584

SSP0181



SSP0181

SSP0584



SSP1924



SSP1924



SSP2468



SSP2467

PART NO.	DESCRIPTION	NOTES	O.E.
SSP0181 301191601810	Steering Tie Rod - Front	M14X1,5 - L=305mm	485214U110
SSP0584 301191605840	Steering Tie Rod End - Front	M14X1,5	4852015U26
SSP1924 301191619240	Suspension Ball Joint - Front Lower		36160100045; 54501AV600*; 401602Y000; 54500AV600*
SSP2467 301191624670	Suspension Stabilizer Bar Link - Front Left	L=65mm	546684U000
SSP2468 301191624680	Suspension Stabilizer Bar Link - Front Right	L=65mm	546184U000

**NISSAN ALTIMA 4th Gen (L32A, D32)** 

2007-2012

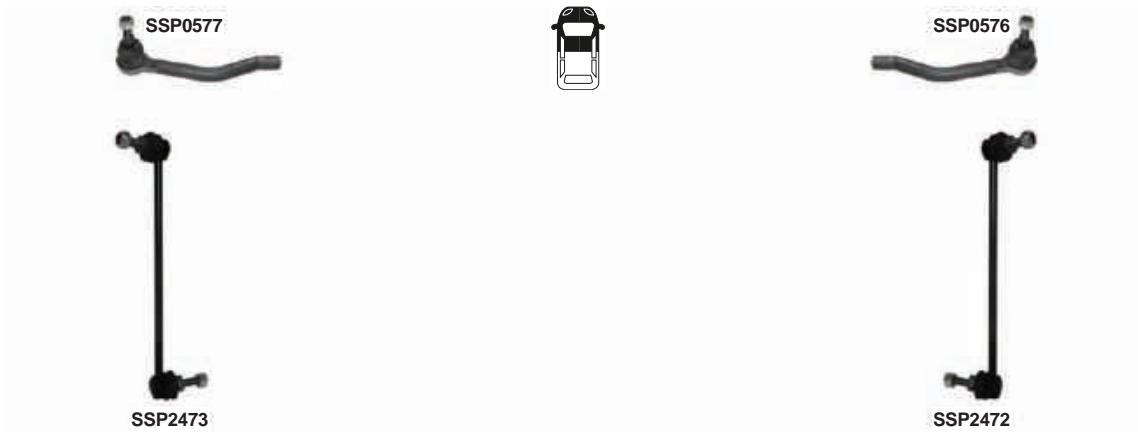

PART NO.	DESCRIPTION	NOTES	O.E.
SSP0576 301191605760	Steering Tie Rod End - Front Right		D85201AA0A; D8520JA00A
SSP0577 301191605770	Steering Tie Rod End - Front Left		D86401AA0A; D8640JA00A
SSP2472 301191624720	Suspension Stabilizer Bar Link - Front Right		546181AA0A; 54618JD00A; 546181AA0E; 54618JA000
SSP2473 301191624730	Suspension Stabilizer Bar Link - Front Left		546681AA0A; 54668JD00A; 546681AA0E; 54668JA000



NISSAN ALTIMA 5th Gen, (L33)



2013-

SSP2475



SSP2474



PART NO.	DESCRIPTION	NOTES	O.E.
SSP2474 301191624740	Suspension Stabilizer Bar Link - Front Right		546183JA0C*
SSP2475 301191624750	Suspension Stabilizer Bar Link - Front Left		546683JA0B*



NISSAN ARMADA



2005-



SSP2465



SSP2464

PART NO.	DESCRIPTION	NOTES	O.E.
SSP2464 301191624640	Suspension Stabilizer Bar Link - Rear Right		56261EA500; 9L3Z5K483D
SSP2465 301191624650	Suspension Stabilizer Bar Link - Rear Left		56261EA510



NISSAN CUBE 3rd Gen, (Z12)



2009-2014



SSP1925



SSP1925

PART NO.	DESCRIPTION	NOTES	O.E.
SSP1925 301191619250	Suspension Ball Joint - Front Lower		Part of 545011KA0B/545001KA0B



NISSAN FRONTIER (D40)



07/2005-

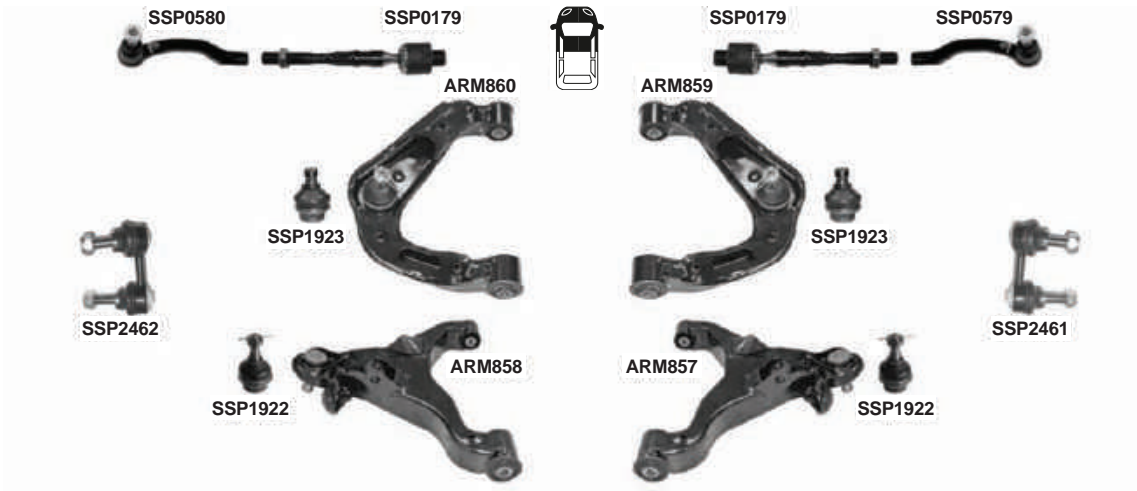

PART NO.	DESCRIPTION	NOTES	O.E.
ARM857	301181385700	Suspension Control Arm and Ball Joint Assembly - Right Lower	54500EB300
ARM858	301181385800	Suspension Control Arm and Ball Joint Assembly - Left Lower	54501EB300
ARM859	301181385900	Suspension Control Arm and Ball Joint Assembly - Front Right Upper	54524EB30A
ARM860	301181386000	Suspension Control Arm and Ball Joint Assembly - Front Left Upper	54525EB30A
SSP0179	301191601790	Steering Tie Rod - Front	M16X1,5 - L=202.5mm 48521EA000
SSP0579	301191605790	Steering Tie Rod End - Front Right	M16x1,5 48640EA01J
SSP0580	301191605800	Steering Tie Rod End - Front Left	M16x1,5 48520EA01J
SSP1922	301191619220	Suspension Ball Joint - Front Lower	D=Ø22mm 40160EA00A Part of; 40160EB310
SSP1923	301191619230	Suspension Ball Joint - Front	40110EA000; 54524EA000
SSP2461	301191624610	Suspension Stabilizer Bar Link - Front Right	54618EA010; 7L1Z5K483B
SSP2462	301191624620	Suspension Stabilizer Bar Link - Front Left	54668EA010

NISSAN INTERSTAR (X70)



07/2002-08/2010

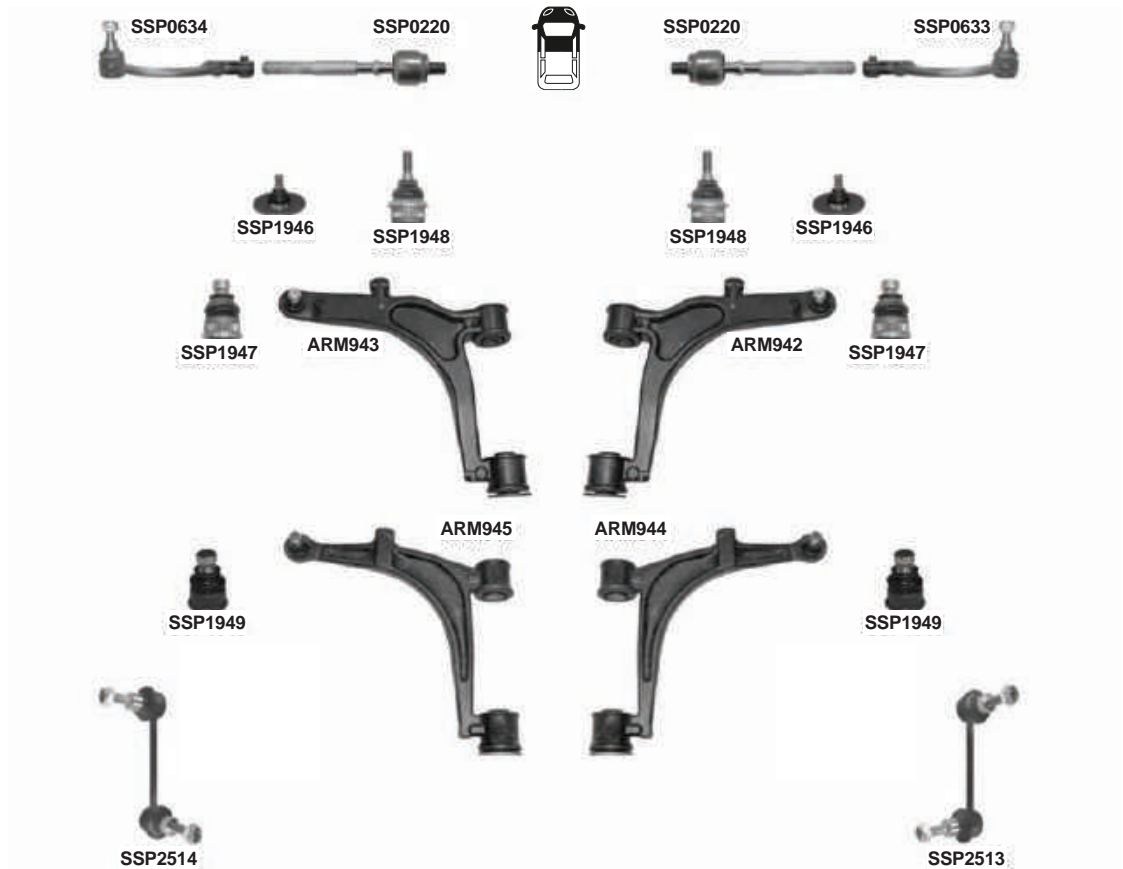

PART NO.	DESCRIPTION	NOTES	O.E.
ARM942	Suspension Control Arm and Ball Joint Assembly - Front Right Lower	Ball Joint D=Ø 22mm	4400048; 7700309190; 8200767825; 7700302119; 5450000QAD
ARM943	Suspension Control Arm and Ball Joint Assembly - Front Left Lower	Ball Joint D=Ø 22mm	4404047; 7700309189; 8200767822; 7700302118; 5450100QAD
ARM944	Suspension Control Arm and Ball Joint Assembly - Front Right	D=Ø24mm	4418630; 93194855; 8200750274
ARM945	Suspension Control Arm and Ball Joint Assembly - Front Left	D=Ø24mm	4418629; 93194853; 8200750273
SSP0220	Steering Tie Rod - Front	M16x1,5 - L=176mm	4501261; 7701470362; 4852100QAF
SSP0633	Steering Tie Rod End - Front Right	M16x1,5Rht	4501263; 9161563; 7701470364; 4852000QAH
SSP0634	Steering Tie Rod End - Front Left	M16x1,5Rht	4501262; 9161562; 7701470363; 4852000QAJ
SSP1946	Suspension Ball Joint - Front Upper		4011000QAA; 7701056970; 4500090; 7700302114; 4401910; 4011000QAB
SSP1947	Suspension Ball Joint - Front Lower	D=Ø22mm	4016000QAD; 9160555; 7700312852; 4500255
SSP1948	Suspension Ball Joint - Front		4016000QAB; 7700312851; 9161561; 4501261; 4500254
SSP1949	Suspension Ball Joint - Front Lower	D=Ø24mm	4016000QOB; 7701070154; 4418631
SSP2513	Suspension Stabilizer Bar Link - Front Right	L=127mm	4500199; 8200713523; 9160499; 7700309071; 5461800QAA
SSP2514	Suspension Stabilizer Bar Link - Front Left	L=127mm	4500198; 8200713522; 9160498; 7700309070; 5461800QAB



NISSAN JUKE



06/2010-

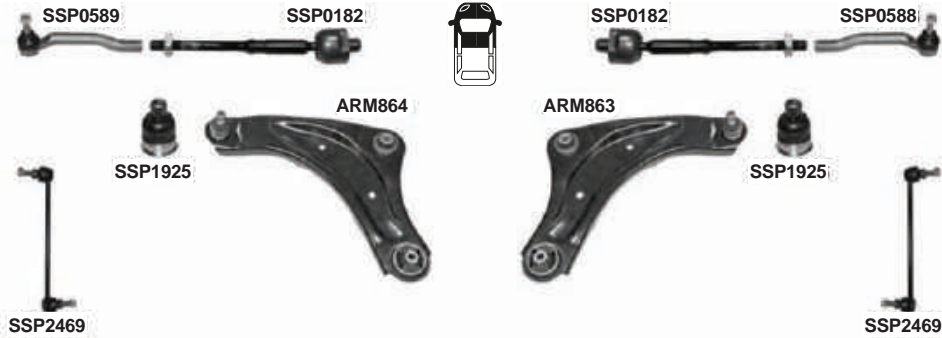

	PART NO.	DESCRIPTION	NOTES	O.E.
ARM863	301181386300	Suspension Control Arm and Ball Joint Assembly - Front Right		545001KA0B
ARM864	301181386400	Suspension Control Arm and Ball Joint Assembly - Front Left		545011KA0B
SSP0182	301191601820	Steering Tie Rod - Front	M12X1,25 - L=215mm	D85211KA0A
SSP0588	301191605880	Steering Tie Rod End - Front Right	M12X1,25	D85201KA0A
SSP0589	301191605890	Steering Tie Rod End - Front Left	M12X1,25	D85401KA0A
SSP1925	301191619250	Suspension Ball Joint - Front Lower		Part of 545011KA0B/545001KA0B
SSP2469	301191624690	Suspension Stabilizer Bar Link - Front	L=284mm	54618CY00A

NISSAN KUBISTAR (X76)



08/2003-07/2007

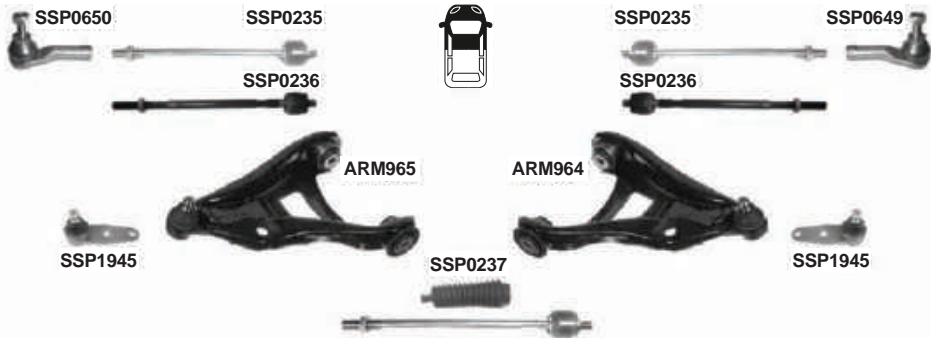

PART NO.	DESCRIPTION	NOTES	O.E.
ARM964	301181396400 Suspension Control Arm and Ball Joint Assembly - Front Right Lower	Hole:Ø12,5mm	5450000QAH; 8200254166
ARM965	301181396500 Suspension Control Arm and Ball Joint Assembly - Front Left Lower	Hole:Ø12,5mm	5450100QAH; 8200254163
SSP0235	301191602350 Steering Tie Rod - Front	Mn.Steering M14x1,5Rht - L=304mm	4852100QAA; 7701472113
SSP0236	301191602360 Steering Tie Rod - Front	Power Steering M14x1,5Rht - L=302.5mm	4852100QAG; 7701473655; 7701472120
SSP0237	301191602370 Steering Tie Rod - Front Inner	M14x1,5Rht - L=303mm	7701472120*; 7701473655*
SSP0649	301191606490 Steering Tie Rod End - Front Right Outer	M14x1,5Rht.	48520AX602; 7701474493; 7701475843; 7701047813; 7701047416
SSP0650	301191606500 Steering Tie Rod End - Front Left Outer	M14x1,5Rht.	48640AX602; 7701475842; 7701474492; 7701474641; 7701047812; 7701047415
SSP1945	301191619450 Suspension Ball Joint - Front Lower	D=Ø16mm - Hole: Ø12,5mm	7702127160



NISSAN LEAF



2010-



	PART NO.	DESCRIPTION	NOTES	O.E.
ARM863	301181386300	Suspension Control Arm and Ball Joint Assembly - Front Right		545001KA0B
ARM864	301181386400	Suspension Control Arm and Ball Joint Assembly - Front Left		545011KA0B
SSP1925	301191619250	Suspension Ball Joint - Front Lower		Part of 545011KA0B/545001KA0B



NISSAN MARCH (K13)



06/2010-

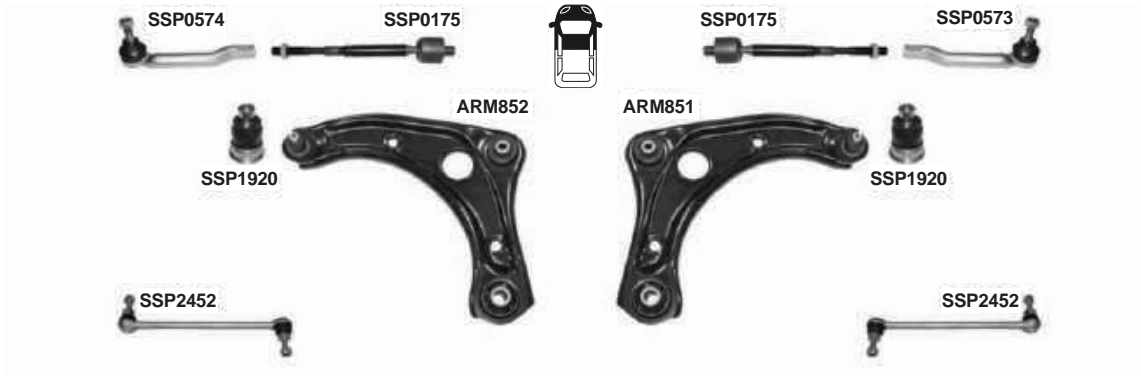

PART NO.	DESCRIPTION	NOTES	O.E.
ARM851 301181385100	Suspension Control Arm and Ball Joint Assembly - Front Right Lower		545001HA0C; 545003VU0A
ARM852 301181385200	Suspension Control Arm and Ball Joint Assembly - Front Left Lower		545011HA0C; 545013VU0A
SSP0175 301191601750	Steering Tie Rod - Front	M12X1,25 - L=227 mm	D85211HA0A
SSP0573 301191605730	Steering Tie Rod End - Front Right	M12X1,25	D85201HA0A
SSP0574 301191605740	Steering Tie Rod End - Front Left	M12X1,25	D86401HA0A
SSP1920 301191619200	Suspension Ball Joint - Front		Part of 545001HA0C/545011HA0C; Part of 545003VU0A/545013VU0A
SSP2452 301191624520	Suspension Stabilizer Bar Link - Front	ALM. L=255 mm	54618JX00A; 54618JX30A



MAGNETI
MARELLI

NISSAN MAXIMA (A33), MAXIMA QX



1999-2003



SSP1924



SSP1924

PART NO.	DESCRIPTION	NOTES	O.E.
SSP1924 301191619240	Suspension Ball Joint - Front Lower		36160100045; 54501AV600*; 401602Y000; 54500AV600*



NISSAN MAXIMA (A35)



2009-2014



PART NO.	DESCRIPTION	NOTES	O.E.
SSP2474 301191624740	Suspension Stabilizer Bar Link - Front Right		546183JA0C*
SSP2475 301191624750	Suspension Stabilizer Bar Link - Front Left		546683JA0B*



MAGNETI
MARELLI

NISSAN MICRA (K10)



12/1982-07/1992



SSP2449



SSP2449

PART NO.	DESCRIPTION	NOTES	O.E.
SSP2449 301191624490	Suspension Stabilizer Bar Link - Rear	L=90mm	562614F702; 562614F725



NISSAN MICRA (K11)



08/1992-01/2003



PART NO.	DESCRIPTION	NOTES	O.E.
ARM847 301181384700	Suspension Control Arm and Ball Joint Assembly - Front Right Lower	Ball Joint Ø 12,4mm	545004F105
ARM848 301181384800	Suspension Control Arm and Ball Joint Assembly - Front Left Lower	Ball Joint Ø 12,4mm	545014F105
ARM849 301181384900	Suspension Control Arm and Ball Joint Assembly - Front Right Lower	Ball Joint Ø13,1mm	545002U711; 545006F600
ARM850 301181385000	Suspension Control Arm and Ball Joint Assembly - Front Left Lower	Ball Joint Ø13,1mm	545012U711; 545016F600
SSP0173 301191601730	Steering Tie Rod - Front	M12x1,25 - L=272.3mm	4852101B25; 4852117B00
SSP0570 301191605700	Steering Tie Rod End - Front	M12x1,25Rht	485204F125
SSP1918 301191619180	Suspension Ball Joint - Front Lower	1998-2003 Ø12.4mm	401604F100; 401604F105
SSP2449 301191624490	Suspension Stabilizer Bar Link - Rear	L=90mm	562614F702; 562614F725



NISSAN MICRA (K12)



02/2003-05/2010



PART NO.	DESCRIPTION	NOTES	O.E.
ARM845	301181384500 Suspension Control Arm and Ball Joint Assembly - Front Right Lower	Ball Joint D=Ø16mm	54500AX600; 54500BC41A
ARM846	301181384600 Suspension Control Arm and Ball Joint Assembly - Front Left Lower	Ball Joint D=Ø16mm	54501AX600; 54501BC41A
SSP0174	301191601740 Steering Tie Rod - Front	M14x1,5Rht - L=200mm	48001AX602*
SSP0219	301191602190 Steering Tie Rod - Front	M14x1,5Rht - L=305.5mm	7701475841
SSP0571	301191605710 Steering Tie Rod End - Front Right	-> 07/2006 M14x1,5	48520AX600
SSP0572	301191605720 Steering Tie Rod End - Front Left	M14x1,5	48640AX600
SSP0649	301191606490 Steering Tie Rod End - Front Right Outer	M14x1,5Rht.	48520AX602; 7701474493; 7701475843; 7701047813; 7701047416
SSP0650	301191606500 Steering Tie Rod End - Front Left Outer	M14x1,5Rht.	48640AX602; 7701475842; 7701474492; 7701474641; 7701047812; 7701047415
SSP1919	301191619190 Suspension Ball Joint - Front	D=Ø16mm	40160AX000
SSP2451	301191624510 Suspension Stabilizer Bar Link - Front	L=248mm	54618AX600; 551107916R; 8200127308



NISSAN MICRA (K13)



06/2010-

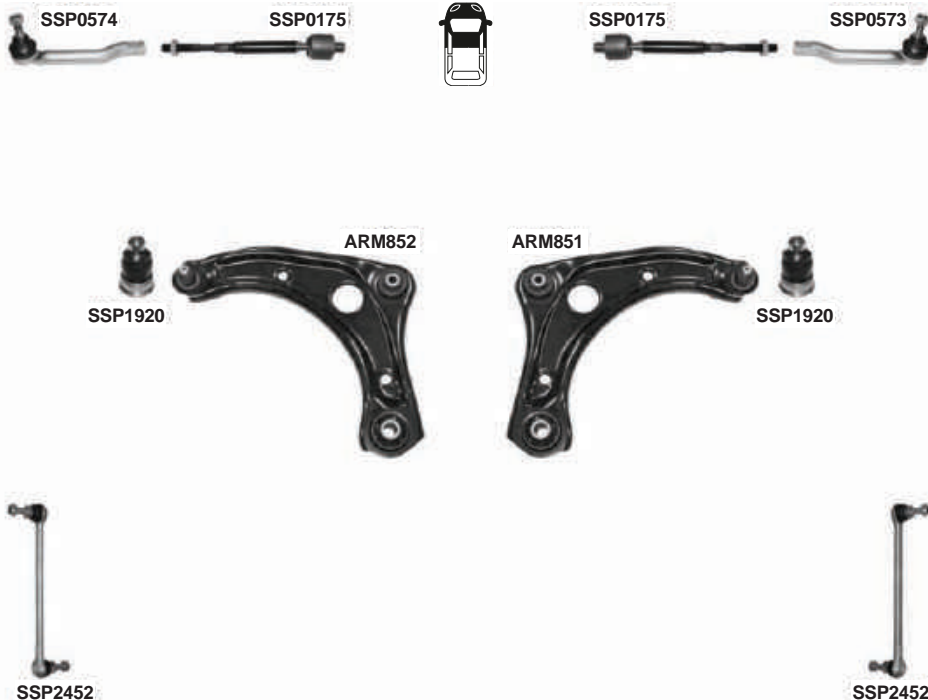

PART NO.	DESCRIPTION	NOTES	O.E.
ARM851 301181385100	Suspension Control Arm and Ball Joint Assembly - Front Right Lower		545001HA0C; 545003VU0A
ARM852 301181385200	Suspension Control Arm and Ball Joint Assembly - Front Left Lower		545011HA0C; 545013VU0A
SSP0175 301191601750	Steering Tie Rod - Front	M12X1,25 - L=227 mm	D85211HA0A
SSP0573 301191605730	Steering Tie Rod End - Front Right	M12X1,25	D85201HA0A
SSP0574 301191605740	Steering Tie Rod End - Front Left	M12X1,25	D86401HA0A
SSP1920 301191619200	Suspension Ball Joint - Front		Part of 545001HA0C/545011HA0C; Part of 545003VU0A/545013VU0A
SSP2452 301191624520	Suspension Stabilizer Bar Link - Front	ALM. L=255 mm	54618JX00A; 54618JX30A



NISSAN MURANO (Z50)



03/2003-10/2007



SSP0575

SSP0176



SSP0176

SSP0575



ARM854



ARM853



SSP2454



SSP2453



SSP2456



SSP2455

	PART NO.	DESCRIPTION	NOTES	O.E.
ARM853	301181385300	Suspension Control Arm and Ball Joint Assembly - Front Right		54500CC40A
ARM854	301181385400	Suspension Control Arm and Ball Joint Assembly - Front Left		54501CC40A
SSP0176	301191601760	Steering Tie Rod - Front	M14X13,5 - L=264mm	48520CB025; 48521CB027
SSP0575	301191605750	Steering Tie Rod End - Front	M14X1,5	D8520CB025
SSP2453	301191624530	Suspension Stabilizer Bar Link - Front Right	L=308mm	54618CK000
SSP2454	301191624540	Suspension Stabilizer Bar Link - Front Left	L=308mm	54668CA000
SSP2455	301191624550	Suspension Stabilizer Bar Link - Rear Right	L=85mm	54618CA010
SSP2456	301191624560	Suspension Stabilizer Bar Link - Rear Left	L=85mm	54668CC010



NISSAN MURANO (Z51)



11/2007-



SSP0577



SSP0576



SSP2473



SSP2472



SSP2458



SSP2457

PART NO.	DESCRIPTION	NOTES	O.E.
SSP0177 301191601770	Steering Tie Rod - Front	M14X1,5 - L=240mm	D85211AA0A; D8E211AA0A
SSP0576 301191605760	Steering Tie Rod End - Front Right	M14X1,5	D85201AA0A; D8520JA00A
SSP0577 301191605770	Steering Tie Rod End - Front Left	M14X1,5	D86401AA0A; D8640JA00A
SSP2457 301191624570	Suspension Stabilizer Bar Link - Rear Right	L=105 mm	562611AA0A
SSP2458 301191624580	Suspension Stabilizer Bar Link - Rear Left	L=105 mm	562611AA0B
SSP2472 301191624720	Suspension Stabilizer Bar Link - Front Right	L=299,5mm	546181AA0A; 54618JD00A; 546181AA0E; 54618JA000
SSP2473 301191624730	Suspension Stabilizer Bar Link - Front Left	L=299,5mm	546681AA0A; 54668JD00A; 546681AA0E; 54668JA000



NISSAN NAVARA (D40)



07/2005-

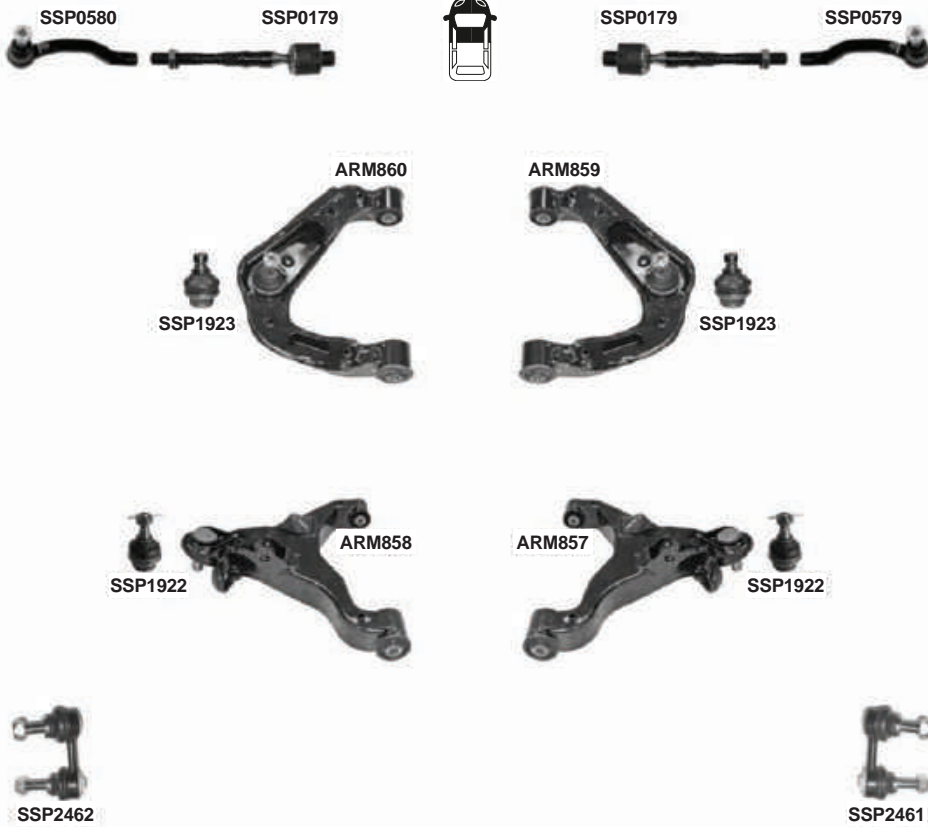

	PART NO.	DESCRIPTION	NOTES	O.E.
ARM857	301181385700	Suspension Control Arm and Ball Joint Assembly - Right Lower		54500EB300
ARM858	301181385800	Suspension Control Arm and Ball Joint Assembly - Left Lower		54501EB300
ARM859	301181385900	Suspension Control Arm and Ball Joint Assembly - Front Right Upper		54524EB30A
ARM860	301181386000	Suspension Control Arm and Ball Joint Assembly - Front Left Upper		54525EB30A
SSP0179	301191601790	Steering Tie Rod - Front	M16X1,5 - L=202.5mm	48521EA000
SSP0579	301191605790	Steering Tie Rod End - Front Right	M16x1,5	48640EA01J
SSP0580	301191605800	Steering Tie Rod End - Front Left	M16x1,5	48520EA01J
SSP1922	301191619220	Suspension Ball Joint - Front Lower	D=Ø22mm	40160EA00A Part of; 40160EB310
SSP1923	301191619230	Suspension Ball Joint - Front		40110EA000; 54524EA000
SSP2461	301191624610	Suspension Stabilizer Bar Link - Front Right	L=65mm	54618EA010; 7L1Z5K483B
SSP2462	301191624620	Suspension Stabilizer Bar Link - Front Left	L=65mm	54668EA010

NISSAN NOTE (E11)



03/2006-05/2013

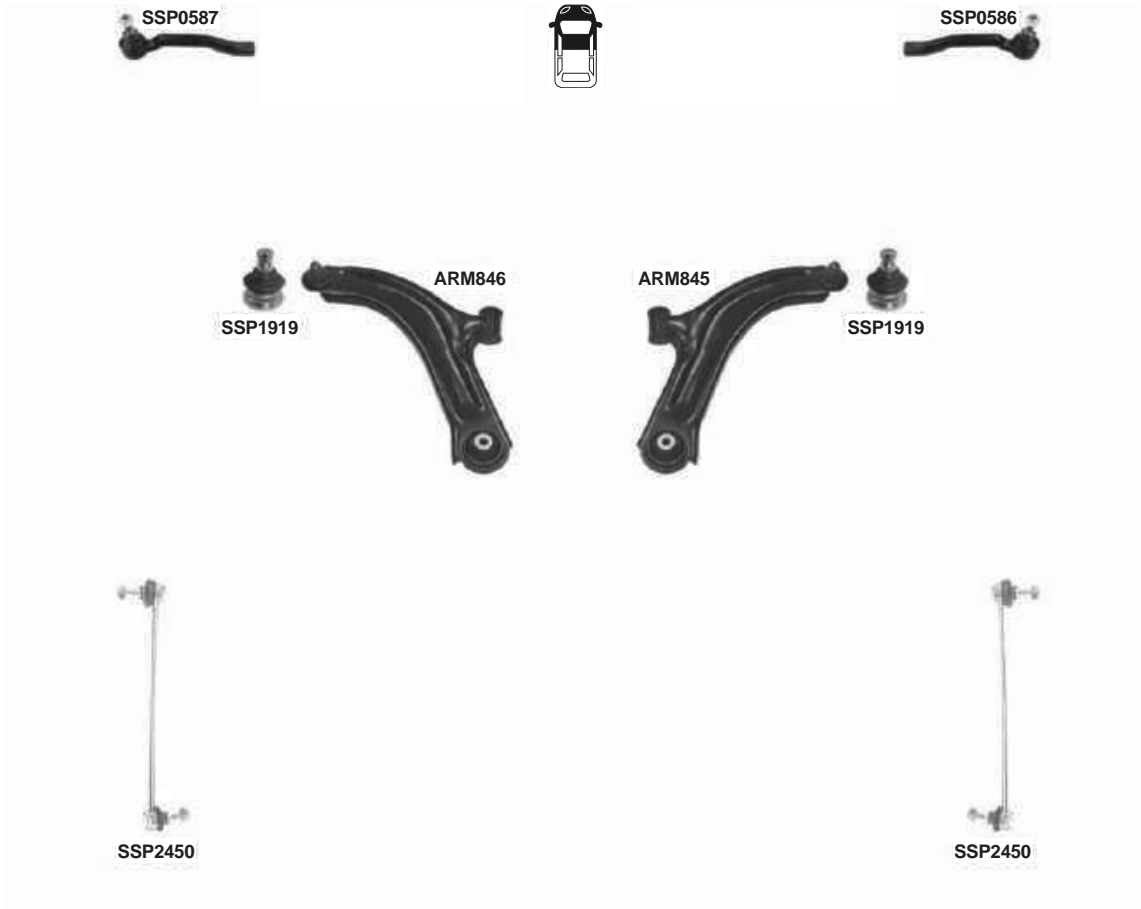

PART NO.	DESCRIPTION	NOTES	O.E.
ARM845 301181384500	Suspension Control Arm and Ball Joint Assembly - Front Right Lower	Ball Joint D=Ø16mm	54500AX600; 54500BC41A
ARM846 301181384600	Suspension Control Arm and Ball Joint Assembly - Front Left Lower	Ball Joint D=Ø16mm	54501AX600; 54501BC41A
SSP0586 301191605860	Steering Tie Rod End - Front Right	M12X1,25	486571U61A; D8520EW00A
SSP0587 301191605870	Steering Tie Rod End - Front Left	M12X1,25	486471U61A; D8640EW00A
SSP1919 301191619190	Suspension Ball Joint - Front	D=Ø16mm	40160AX000
SSP2450 301191624500	Suspension Stabilizer Bar Link - Front	L=255mm	546189U00A; 54618BC40A



NISSAN NX 100 (B13)



1990-1994

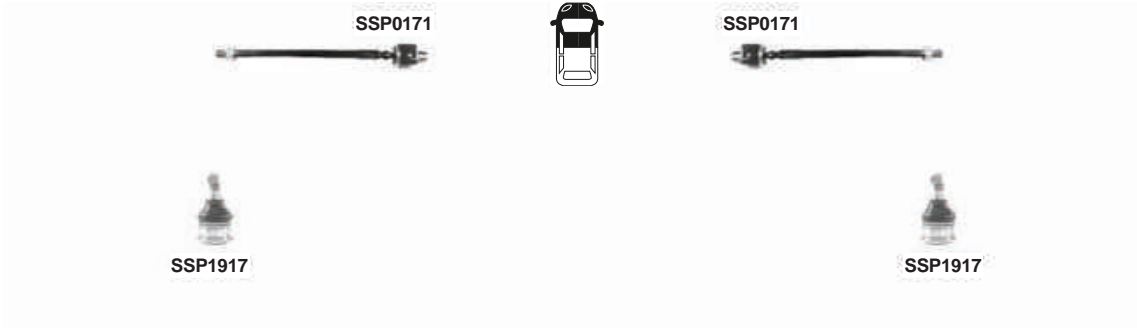

PART NO.	DESCRIPTION	NOTES	O.E.
SSP0171 301191601710	Steering Tie Rod - Front	Mx12x1,25 - L=274mm	4852150Y00; 4852160Y05
SSP1917 301191619170	Suspension Ball Joint - Front Lower		4016050Y00; 4016052Y00; 4016060Y20

NISSAN PATHFINDER (R50)



1997-2004

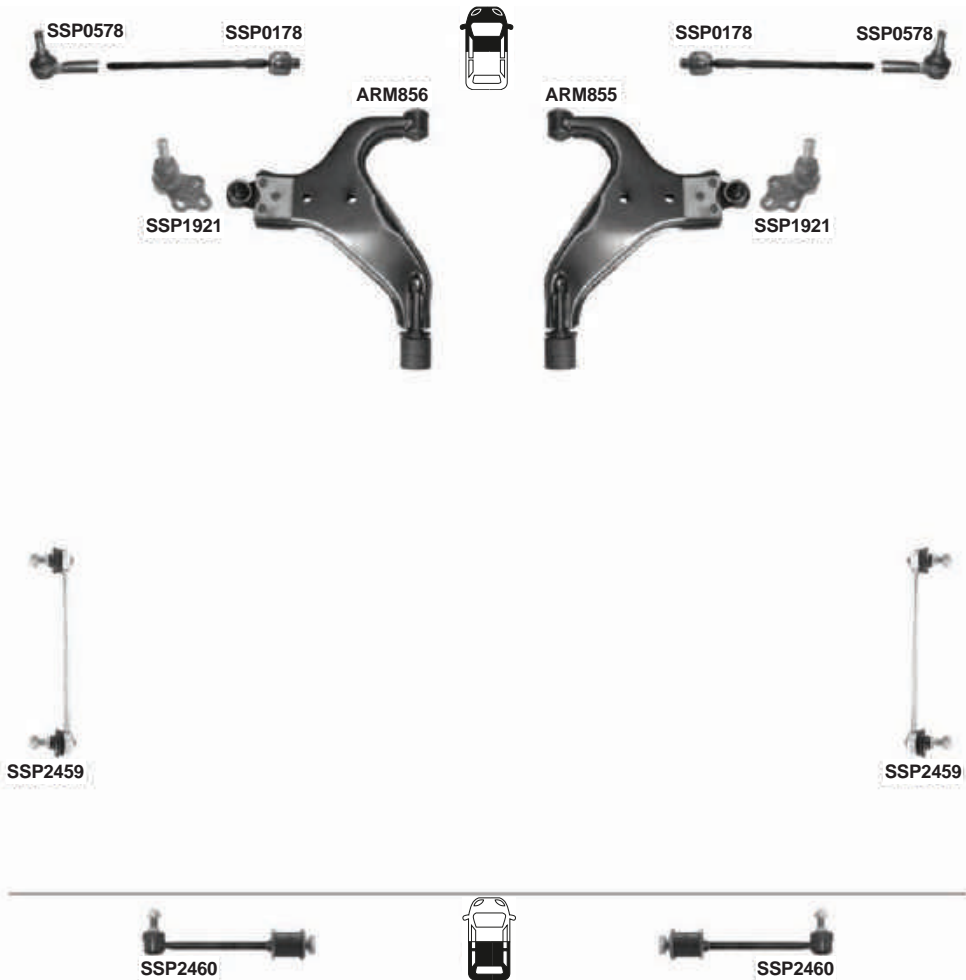

PART NO.	DESCRIPTION	NOTES	O.E.
ARM855 301181385500	Suspension Control Arm and Ball Joint Assembly - Front Right Lower		545000W000*
ARM856 301181385600	Suspension Control Arm and Ball Joint Assembly - Front Left Lower		545010W000*
SSP0178 301191601780	Steering Tie Rod - Front	M16x1,5	485210W025
SSP0578 301191605780	Steering Tie Rod End - Front Outer	M14x1.5Rht	485200P725; 485203S525; 485200W025; 485203S500
SSP1921 301191619210	Suspension Ball Joint - Front Lower		401600W000; 401600W025
SSP2459 301191624590	Suspension Stabilizer Bar Link - Front	L=190mm	5461801F00; 546180W001
SSP2460 301191624600	Suspension Stabilizer Bar Link - Rear	L=160mm	1954821; 562600F001; 562600W001



NISSAN PATHFINDER (R51)



03/2005-05/2014

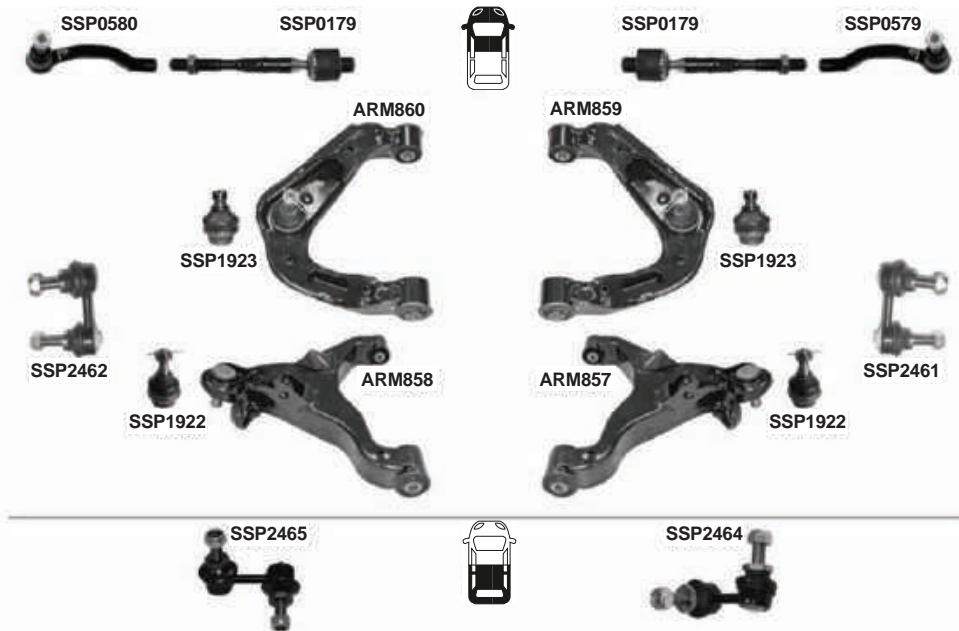

PART NO.	DESCRIPTION	NOTES	O.E.
ARM857	301181385700 Suspension Control Arm and Ball Joint Assembly - Right Lower		54500EB300
ARM858	301181385800 Suspension Control Arm and Ball Joint Assembly - Left Lower		54501EB300
ARM859	301181385900 Suspension Control Arm and Ball Joint Assembly - Front Right Upper		54524EB30A
ARM860	301181386000 Suspension Control Arm and Ball Joint Assembly - Front Left Upper		54525EB30A
SSP0179	301191601790 Steering Tie Rod - Front	M16X1,5 - L=202.5mm	48521EA000
SSP0579	301191605790 Steering Tie Rod End - Front Right	M16x1,5	48640EA01J
SSP0580	301191605800 Steering Tie Rod End - Front Left	M16x1,5	48520EA01J
SSP1922	301191619220 Suspension Ball Joint - Front Lower	D=Ø22mm	40160EA00A Part of; 40160EB310
SSP1923	301191619230 Suspension Ball Joint - Front		40110EA000; 54524EA000
SSP2461	301191624610 Suspension Stabilizer Bar Link - Front Right	L=65mm	54618EA010; 7L1Z5K483B
SSP2462	301191624620 Suspension Stabilizer Bar Link - Front Left	L=65mm	54668EA010
SSP2464	301191624640 Suspension Stabilizer Bar Link - Rear Right	L=64mm	56261EA500; 9L3Z5K483D
SSP2465	301191624650 Suspension Stabilizer Bar Link - Rear Left	L=64mm	56261EA510



NISSAN PATHFINDER (R52)



2014-

SSP2475



SSP2474



PART NO.	DESCRIPTION	NOTES	O.E.
SSP2474 301191624740	Suspension Stabilizer Bar Link - Front Right		546183JA0C*
SSP2475 301191624750	Suspension Stabilizer Bar Link - Front Left		546683JA0B*



MAGNETI
MARELLI

NISSAN Pickup (D22) (4WD)



03/1998-07/2012



SSP0578



SSP0578

PART NO.	DESCRIPTION	NOTES	O.E.
SSP0578 301191605780	Steering Tie Rod End - Front Outer	M14x1.5Rht	485200P725; 485203S525; 485200W025; 485203S500



NISSAN PRIMASTAR (X83)



08/2002-06/2014



PART NO.	DESCRIPTION	NOTES	O.E.
ARM956	301181395600 Suspension Control Arm and Ball Joint Assembly - Front Right Lower		4421646; 8200247900; 91166641; 8200054006; 5450200QAB
ARM957	301181395700 Suspension Control Arm and Ball Joint Assembly - Front Left Lower		4421647; 8200247898; 91166642; 8200054003; 5450300QA3
ARM958	301181395800 Suspension Control Arm and Ball Joint Assembly - Front Right Lower		4417178; 93853465; 8200565079; 5450200QOC
ARM959	301181395900 Suspension Control Arm and Ball Joint Assembly - Front Left Lower		4417177; 93853464; 8200565072; 5450300QOC
SSP0225	301191602250 Steering Tie Rod - Front	M14x1,5 - L=263mm	4408474; 7701473333; 4852000QAM
SSP0641	301191606410 Steering Tie Rod End - Front Right	M14x1,5Rht	4408511; 91160044; 7701049283; 4852000QAL
SSP0642	301191606420 Steering Tie Rod End - Front Left	M14x1,5Rht	4408510; 91160043; 7701049282; 4852000QAK
SSP1954	301191619540 Suspension Ball Joint - Front Lower		4016000Q0A; 91166461*; 7701476576; 4412936
SSP2522	301191625220 Suspension Stabilizer Bar Link - Front	L=279mm	4408904; 8200002870; 546181944R; 5461600QAC
SSP2523	301191625230 Suspension Stabilizer Bar Link - Front	(Clip-on patented design) L=279mm	4408904; 8200002870; 5461600QAC



NISSAN PRIMERA (P10-W10-W11) 06/1990-06/1996

**SSP1916****SSP1916****SSP2446****SSP2446****SSP2445****SSP2445**

PART NO.	DESCRIPTION	NOTES	O. E.
ARM837 301181383700	Suspension Control Arm - Front Right Upper		545242F010; 5452486J10; 545242J001; 5452450J00
ARM838 301181383800	Suspension Control Arm - Front Left Upper		545252F010; 5452586J10; 545252J001; 5452550J00
SSP0170 301191601700	Steering Tie Rod - Front	M12x1.25 - L = 274 mm	4852106R05; 4852170000000; 4852171; 4852172
SSP0585 301191605850	Steering Tie Rod End - Front	M12x1,25Rht	4852073J23; 485209C025; 4852073J25; 485209C000
SSP1916 301191619160	Suspension Ball Joint - Front Lower		4016050A00; 4016070J00; 4016050J25; 4016060Y60
SSP2445 301191624450	Suspension Stabilizer Bar Link - Rear	L=115mm	4526190J01; 5626186J25
SSP2446 301191624460	Suspension Stabilizer Bar Link - Front	L=114mm	5461850J20



NISSAN PRIMERA (P11)



06/1996-12/2001

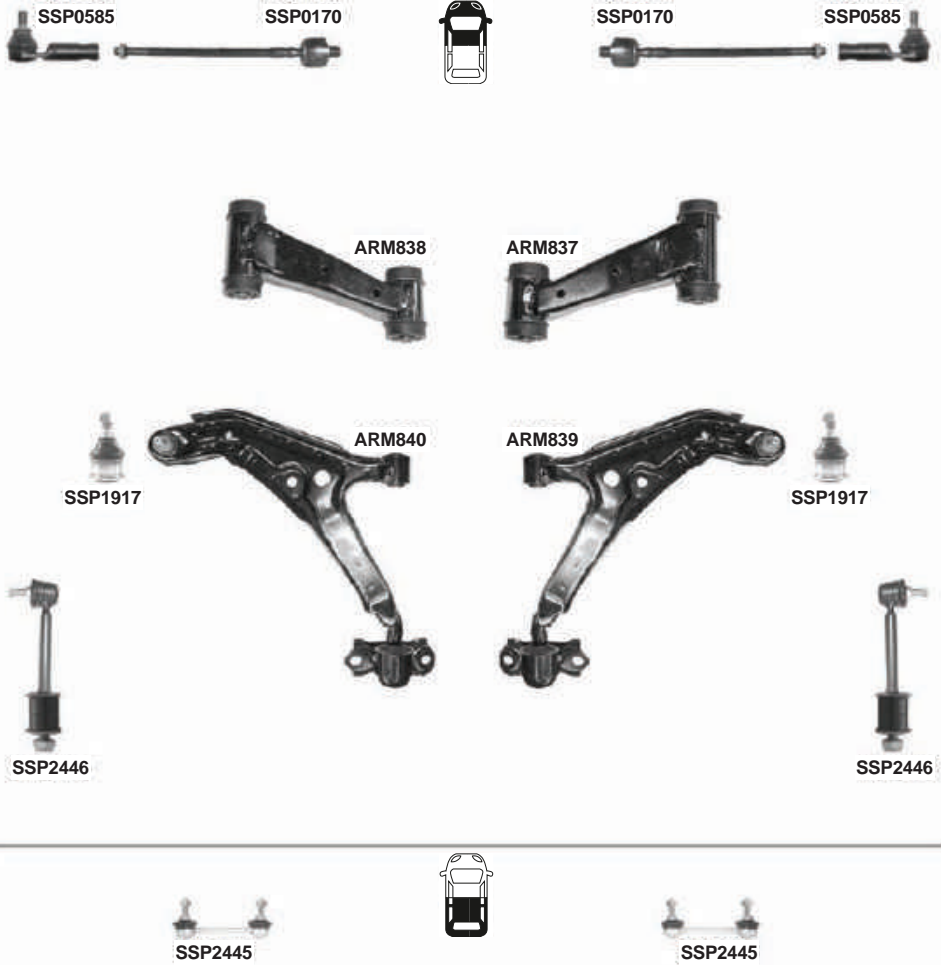

	PART NO.	DESCRIPTION	NOTES	O.E.
ARM837	301181383700	Suspension Control Arm - Front Right Upper		545242F010; 5452486J10; 545242J001; 5452450J00
ARM838	301181383800	Suspension Control Arm - Front Left Upper		545252F010; 5452586J10; 545252J001; 5452550J00
ARM839	301181383900	Suspension Control Arm and Ball Joint Assembly - Right Lower		545002F500; 545009F000
ARM840	301181384000	Suspension Control Arm and Ball Joint Assembly - Left Lower		545012F500; 545019F000
SSP0170	301191601700	Steering Tie Rod - Front	M12x1.25 - L = 274 mm	4852106R05; 4852170000000; 4852171; 4852172
SSP0585	301191605850	Steering Tie Rod End - Front	M12x1,25Rht	4852073J23; 485209C025; 4852073J25; 485209C000
SSP1917	301191619170	Suspension Ball Joint - Front Lower		4016050Y00; 4016052Y00; 4016060Y20
SSP2445	301191624450	Suspension Stabilizer Bar Link - Rear	L=115mm	4526190J01; 5626186J25
SSP2446	301191624460	Suspension Stabilizer Bar Link - Front	L=114mm	5461850J20



NISSAN PRIMERA (P12)



01/2002-05/2008

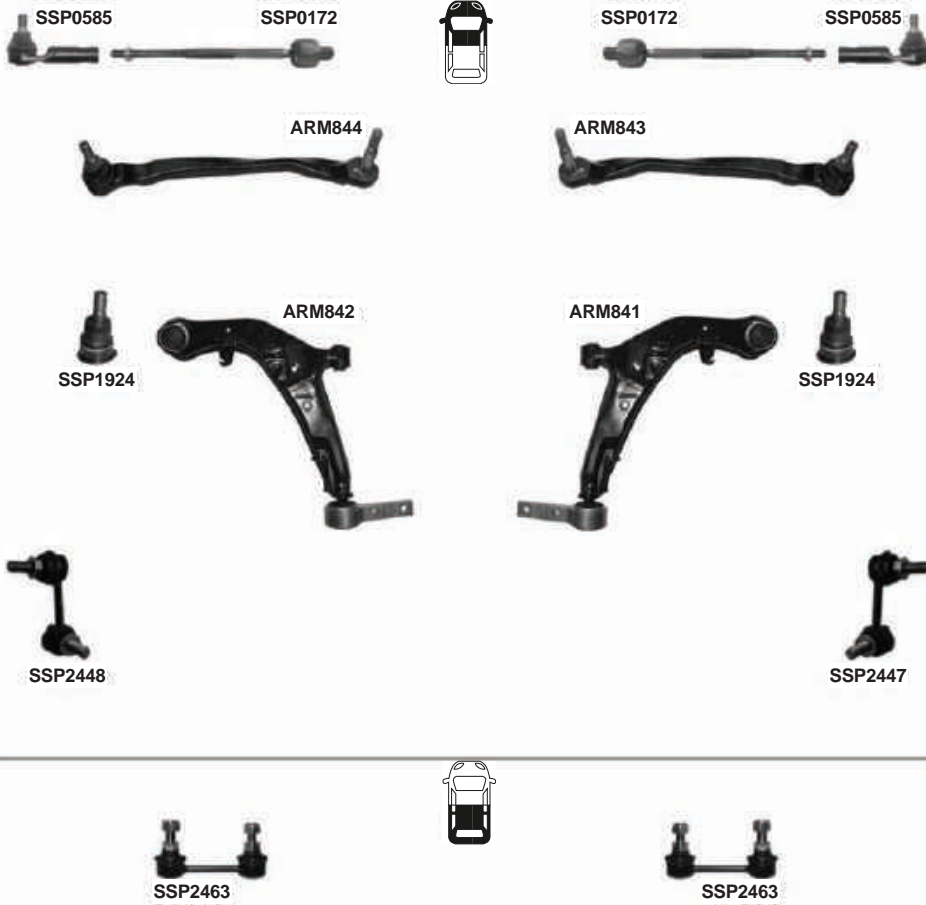

PART NO.	DESCRIPTION	NOTES	O. E.
ARM841 301181384100	Suspension Control Arm and Ball Joint Assembly - Right Lower		54500AV600; 54500AV606; 54500AV60A
ARM842 301181384200	Suspension Control Arm and Ball Joint Assembly - Left Lower		54501AV600; 54501AV606; 54501AV60A
ARM843 301181384300	Suspension Control Arm and Ball Joint Assembly - Front Right Upper		54524AV600
ARM844 301181384400	Suspension Control Arm and Ball Joint Assembly - Front Left Upper		54525AV600
SSP0172 301191601720	Steering Tie Rod - Front	M12X1,25 - L=280mm	Part of. 49001BA210SK*
SSP0585 301191605850	Steering Tie Rod End - Front	M12x1,25Rht	4852073J23; 485209C025; 4852073J25; 485209C000
SSP1924 301191619240	Suspension Ball Joint - Front Lower		36160100045; 54501AV600*; 401602Y000; 54500AV600*
SSP2447 301191624470	Suspension Stabilizer Bar Link - Front Right	L=65mm	54618AU000
SSP2448 301191624480	Suspension Stabilizer Bar Link - Front Left	L=65mm	54668AU000
SSP2463 301191624630	Suspension Stabilizer Bar Link - Rear	L=90,5mm	56261-0E000; 56261AV611; 56261AW000

NISSAN PULSAR (N14)



1990-1995

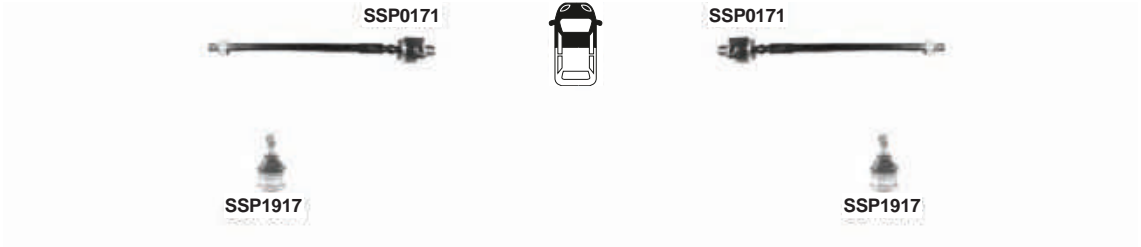

PART NO.	DESCRIPTION	NOTES	O.E.
SSP0171 301191601710	Steering Tie Rod - Front	Mx12x1,25 - L=274mm	4852150Y00; 4852160Y05
SSP1917 301191619170	Suspension Ball Joint - Front Lower		4016050Y00; 4016052Y00; 4016060Y20



NISSAN QASHQAI (J10, JJ10)



02/2007-01/2014

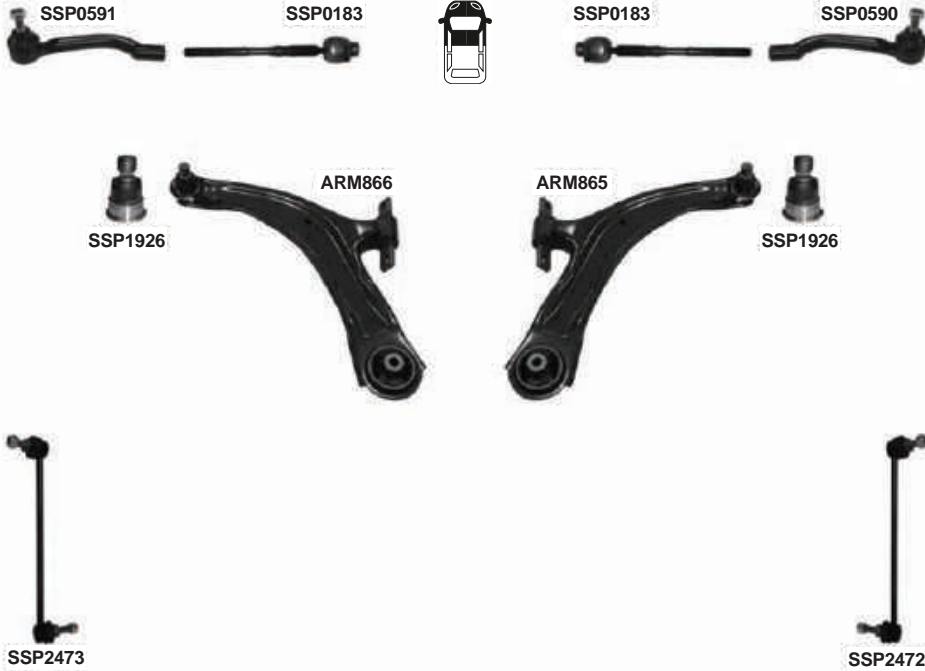

PART NO.	DESCRIPTION	NOTES	O.E.
ARM865 301181386500	Suspension Control Arm and Ball Joint Assembly - Right Lower		54500BB00A; 54500JG00B; 54500JD00D; 54500JD000
ARM866 301181386600	Suspension Control Arm and Ball Joint Assembly - Left Lower		54501JD000; 54501JY00A; 54501JD00D
SSP0183 301191601830	Steering Tie Rod - Front	M14x1,5 - L=232mm	D8521JG00A
SSP0590 301191605900	Steering Tie Rod End - Front Right	M14x1,5	48527JD01A; 48547JDA01; D8520JG00A
SSP0591 301191605910	Steering Tie Rod End - Front Left	M14x1,5	48527JDA01; 48647JD01A; D8640JG00A
SSP1926 301191619260	Suspension Ball Joint - Front Lower		Part of 54500JD000; Part of 54501JD000; Part of 545004CA0A; Part of 545014CUA0; Part of 545004CUA0; Part of 545014BA0A; Part of 545004BA0A
SSP2470 301191624700	Suspension Stabilizer Bar Link - Rear Right	L=143,5mm	55618 JE20A; 55618JD00A; 55618JY00B
SSP2471 301191624710	Suspension Stabilizer Bar Link - Rear Left	L=143,5mm	55619JD00A; 55619JE20A; 55619JY00B
SSP2472 301191624720	Suspension Stabilizer Bar Link - Front Right	L=299,5mm	546181AA0A; 54618JD00A; 546181AA0E; 54618JA000
SSP2473 301191624730	Suspension Stabilizer Bar Link - Front Left	L=299,5mm	546681AA0A; 54668JD00A; 546681AA0E; 54668JA000



NISSAN QASHQAI II (J11)



02/2014-

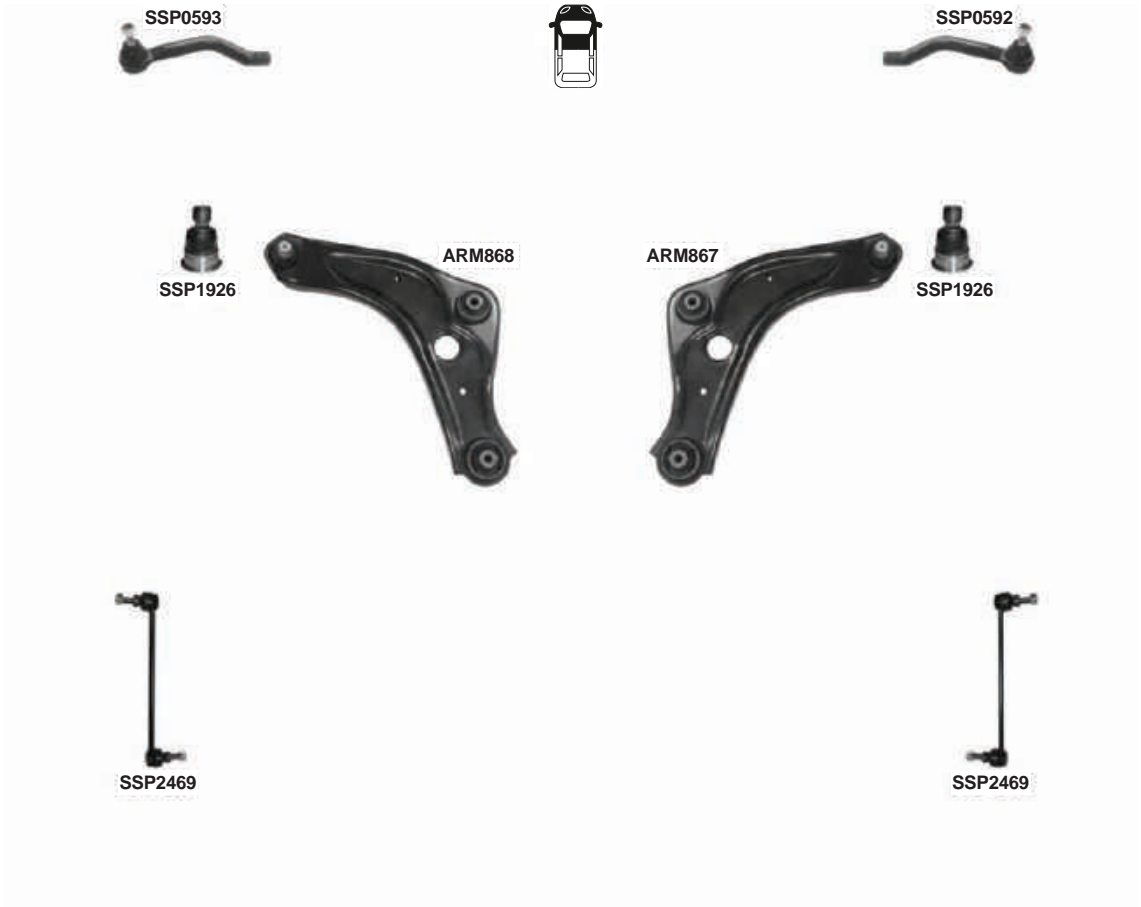

PART NO.	DESCRIPTION	NOTES	O.E.
ARM867	301181386700 Suspension Control Arm and Ball Joint Assembly - Front Right		545004EA0A; 545004EA0B
ARM868	301181386800 Suspension Control Arm and Ball Joint Assembly - Front Left		545014EA0A; 545014EA0B
SSP0218	301191602180 Steering Tie Rod - Front		485212518R
SSP0592	301191605920 Steering Tie Rod End - Front Right	M10x1.25	D85204EA0A
SSP0593	301191605930 Steering Tie Rod End - Front Left	M10x1.25	D86404EA0A
SSP1926	301191619260 Suspension Ball Joint - Front Lower		Part of 54500JD000; Part of 54501JD000; Part of 545004CA0A; Part of 545014CA0A; Part of 545014CUA0; Part of 545004CUA0; Part of 545014BA0A; Part of 545004BA0A
SSP2469	301191624690 Suspension Stabilizer Bar Link - Front	L=284mm	54618CY00A



NISSAN ROGUE 1st Gen



2008-2014

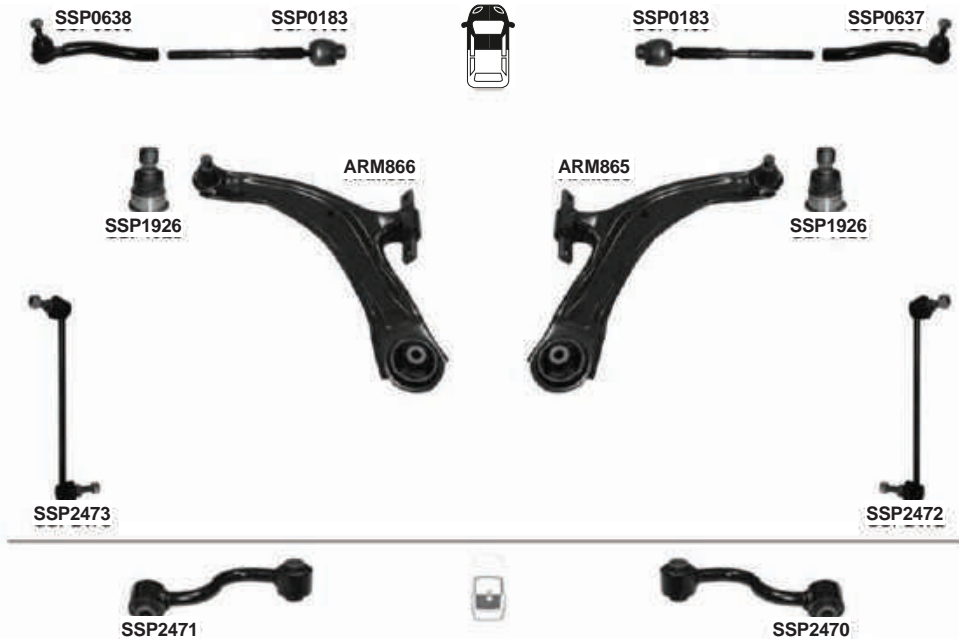

PART NO.	DESCRIPTION	NOTES	O.E.
ARM865	301181386500 Suspension Control Arm and Ball Joint Assembly - Right Lower		54500BB00A; 54500JG00B; 54500JD00D; 54500JD000
ARM866	301181386600 Suspension Control Arm and Ball Joint Assembly - Left Lower		54501JD000; 54501JY00A; 54501JD00D
SSP0183	301191601830 Steering Tie Rod - Front	M14x1,5 - L=232mm	D8521JG00A
SSP0637	301191606370 Steering Tie Rod End - Front Right		D8520JY00A
SSP0638	301191606380 Steering Tie Rod End - Front Left		D8640JY00A
SSP1926	301191619260 Suspension Ball Joint - Front Lower		Part of 54500JD000; Part of 54501JD000; Part of 545004CA0A; Part of 545014CA0A; Part of 545014CUA0; Part of 545004CUA0; Part of 545014BA0A; Part of 545004BA0A
SSP2470	301191624700 Suspension Stabilizer Bar Link - Rear Right	L=143,5mm	55618 JE20A; 55618JD00A; 55618JY00B
SSP2471	301191624710 Suspension Stabilizer Bar Link - Rear Left	L=143,5mm	55619JD00A; 55619JE20A; 55619JY00B
SSP2472	301191624720 Suspension Stabilizer Bar Link - Front Right	L=299,5mm	546181AA0A; 54618JD00A; 546181AA0E; 54618JA000
SSP2473	301191624730 Suspension Stabilizer Bar Link - Front Left	L=299,5mm	546681AA0A; 54668JD00A; 546681AA0E; 54668JA000



PART NO.	DESCRIPTION	NOTES	O.E.
SSP1926 301191619260	Suspension Ball Joint - Front Lower		Part of 54500JD000; Part of 54501JD000; Part of 545004CA0A; Part of 545014CA0A; Part of 545014CUA0; Part of 545004CUA0; Part of 545014BA0A; Part of 545004BA0A
SSP2470 301191624700	Suspension Stabilizer Bar Link - Rear Right	L=143,5mm	55618 JE20A; 55618JD00A; 55618JY00B
SSP2471 301191624710	Suspension Stabilizer Bar Link - Rear Left	L=143,5mm	55619JD00A; 55619JE20A; 55619JY00B



NISSAN SENTRA (B12-N13)



1985-1990



SSP1916



SSP1916



SSP2444



SSP2444

PART NO.	DESCRIPTION	NOTES	O.E.
SSP1916 301191619160	Suspension Ball Joint - Front Lower		4016050A00; 4016070J00; 4016050J25; 4016060Y60
SSP2444 301191624440	Suspension Stabilizer Bar Link - Front	L=36mm	5461850Y00; 54618D5010

NISSAN SENTRA (B13-N14)



1990-1995

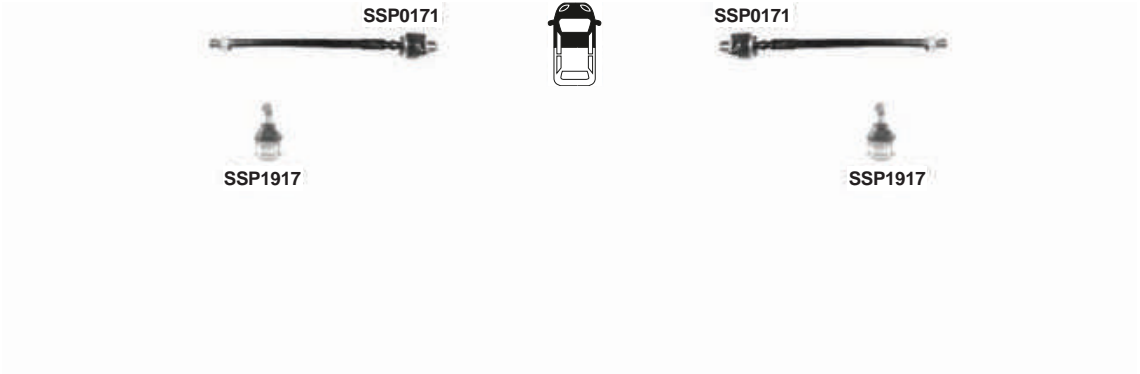

PART NO.	DESCRIPTION	NOTES	O.E.
SSP0171 301191601710	Steering Tie Rod - Front	Mx12x1,25 - L=274mm	4852150Y00; 4852160Y05
SSP1917 301191619170	Suspension Ball Joint - Front Lower		4016050Y00; 4016052Y00; 4016060Y20

**NISSAN SENTRA (B14)**

1995-1999



	PART NO.	DESCRIPTION	NOTES	O.E.
ARM835	301181383500	Suspension Control Arm and Ball Joint Assembly - Front Right Lower		545000M010; 545004B000; 545000M020; 545000M060
ARM836	301181383600	Suspension Control Arm and Ball Joint Assembly - Front Left Lower		545010M010; 545010M020; 545010M060
SSP1917	301191619170	Suspension Ball Joint - Front Lower		4016050Y00; 4016052Y00; 4016060Y20



NISSAN SENTRA (B16)



2007-2012



PART NO.	DESCRIPTION	NOTES	O.E.
SSP1925 301191619250	Suspension Ball Joint - Front Lower		Part of 545011KA0B/545001KA0B



MAGNETI
MARELLI

NISSAN SERENA MK I C23



07/1992-09/2001

SSP0585



SSP0585



PART NO.	DESCRIPTION	NOTES	O.E.
SSP0585 301191605850	Steering Tie Rod End - Front	M12x1,25Rht	4852073J23; 485209C025; 4852073J25; 485209C000



NISSAN SUNNY (B12-N13)



1985-1990



SSP1916



SSP1916



SSP2444



SSP2444

PART NO.	DESCRIPTION	NOTES	O.E.
SSP1916 301191619160	Suspension Ball Joint - Front Lower		4016050A00; 4016070J00; 4016050J25; 4016060Y60
SSP2444 301191624440	Suspension Stabilizer Bar Link - Front	L=36mm	5461850Y00; 54618D5010



NISSAN SUNNY (B13-N14)



1990-1995

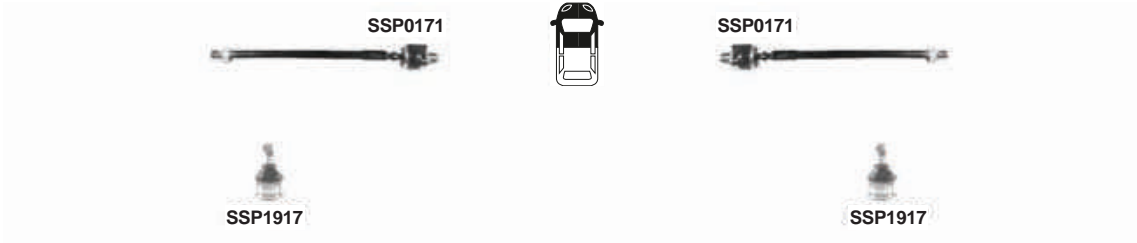

PART NO.	DESCRIPTION	NOTES	O.E.
SSP0171 301191601710	Steering Tie Rod - Front	Mx12x1,25 - L=274mm	4852150Y00; 4852160Y05
SSP1917 301191619170	Suspension Ball Joint - Front Lower		4016050Y00; 4016052Y00; 4016060Y20



NISSAN SUNNY (B14)



1995-1999



	PART NO.	DESCRIPTION	NOTES	O.E.
ARM835	301181383500	Suspension Control Arm and Ball Joint Assembly - Front Right Lower		545000M010; 545004B000; 545000M020; 545000M060
ARM836	301181383600	Suspension Control Arm and Ball Joint Assembly - Front Left Lower		545010M010; 545010M020; 545010M060
SSP1917	301191619170	Suspension Ball Joint - Front Lower		4016050Y00; 4016052Y00; 4016060Y20



NISSAN TEANA (J32) 2009-2013

**SSP2473****SSP2472**

PART NO.	DESCRIPTION	NOTES	O.E.
SSP0177 301191601770	Steering Tie Rod - Front	M14X1,5 - L=240mm	D85211AA0A; D8E211AA0A
SSP0576 301191605760	Steering Tie Rod End - Front Right	M14X1,5	D85201AA0A; D8520JA00A
SSP0577 301191605770	Steering Tie Rod End - Front Left	M14X1,5	D86401AA0A; D8640JA00A
SSP2472 301191624720	Suspension Stabilizer Bar Link - Front Right	L=299,5mm	546181AA0A; 54618JD00A; 546181AA0E; 54618JA000
SSP2473 301191624730	Suspension Stabilizer Bar Link - Front Left	L=299,5mm	546681AA0A; 54668JD00A; 546681AA0E; 54668JA000



NISSAN TIIDA (C11)



07/2004-08/2012



PART NO.	DESCRIPTION	NOTES	O.E.
SSP0586 301191605860	Steering Tie Rod End - Front Right	M12X1,25	486571U61A; D8520EW00A
SSP0587 301191605870	Steering Tie Rod End - Front Left	M12X1,25	486471U61A; D8640EW00A
SSP1925 301191619250	Suspension Ball Joint - Front Lower		Part of 545011KA0B/545001KA0B
SSP2450 301191624500	Suspension Stabilizer Bar Link - Front	L=255mm	546189U00A; 54618BC40A



NISSAN VANETTE (HC 23) CARGO 09/1994-08/1999



SSP0585



SSP0585

PART NO.	DESCRIPTION	NOTES	O.E.
SSP0585 301191605850	Steering Tie Rod End - Front	M12x1,25Rht	4852073J23; 485209C025; 4852073J25; 485209C000



SSP0587



SSP0586



SSP1925



SSP1925



SSP2450



SSP2450

PART NO.	DESCRIPTION	NOTES	O.E.
SSP0586 301191605860	Steering Tie Rod End - Front Right	M12X1,25	486571U61A; D8520EW00A
SSP0587 301191605870	Steering Tie Rod End - Front Left	M12X1,25	486471U61A; D8640EW00A
SSP1925 301191619250	Suspension Ball Joint - Front Lower		Part of 545011KA0B/545001KA0B
SSP2450 301191624500	Suspension Stabilizer Bar Link - Front	L=255mm	546189U00A; 54618BC40A



NISSAN VERSA NOTE (E12)



06/2013-



	PART NO.	DESCRIPTION	NOTES	O.E.
ARM851	301181385100	Suspension Control Arm and Ball Joint Assembly - Front Right Lower		545001HA0C; 545003VU0A
ARM852	301181385200	Suspension Control Arm and Ball Joint Assembly - Front Left Lower		545011HA0C; 545013VU0A
SSP1920	301191619200	Suspension Ball Joint - Front		Part of 545001HA0C/545011HA0C; Part of 545003VU0A/545013VU0A
SSP2452	301191624520	Suspension Stabilizer Bar Link - Front	ALM. L=255 mm	54618JX00A; 54618JX30A



NISSAN XTERRA 2nd Gen, (N50)



2005-2015



SSP2462



SSP2461

PART NO.	DESCRIPTION	NOTES	O.E.
SSP2461 301191624610	Suspension Stabilizer Bar Link - Front Right		54618EA010; 7L1Z5K483B
SSP2462 301191624620	Suspension Stabilizer Bar Link - Front Left		54668EA010



MAGNETI
MARELLI

NISSAN X-TRAIL 1st Gen (T30)



06/2001-05/2007



PART NO.	DESCRIPTION	NOTES	O.E.
SSP0578 301191605780	Steering Tie Rod End - Front Outer	M14x1.5Rht	485200P725; 485203S525; 485200W025; 485203S500



NISSAN X-TRAIL 2nd Gen (T31)



06/2007-09/2013

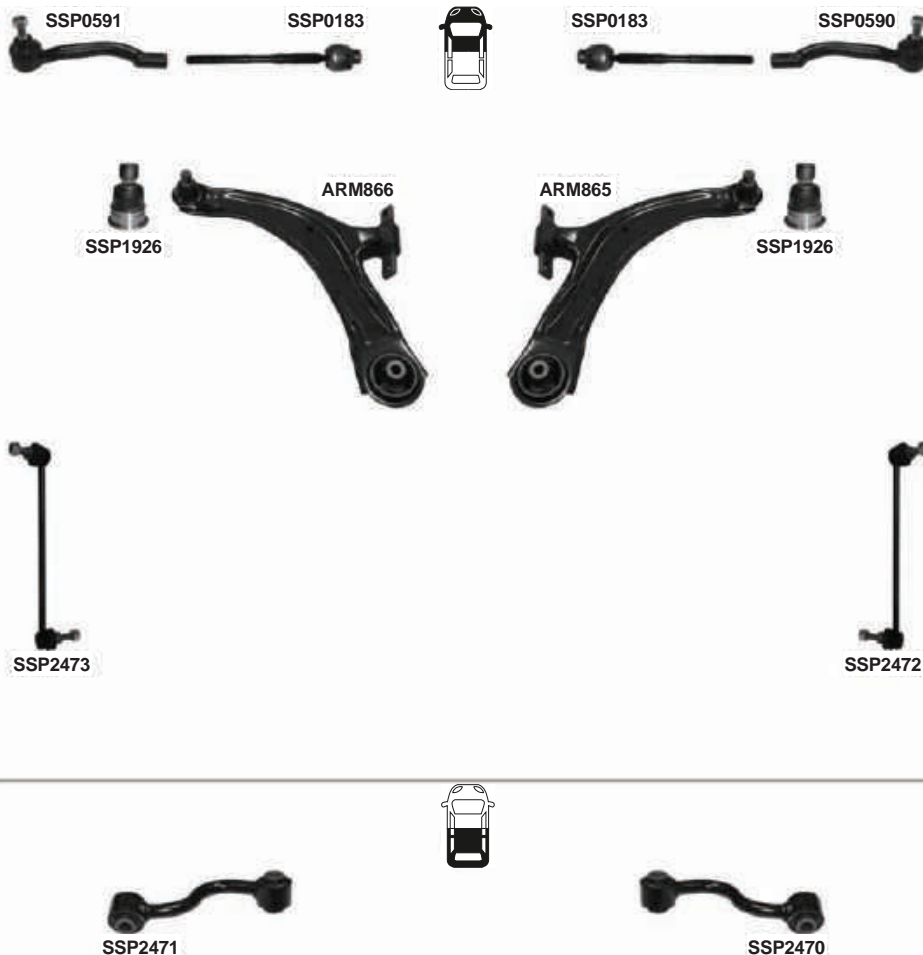

PART NO.	DESCRIPTION	NOTES	O.E.
ARM865	301181386500 Suspension Control Arm and Ball Joint Assembly - Right Lower		54500BB00A; 54500JG00B; 54500JD00D; 54500JD000
ARM866	301181386600 Suspension Control Arm and Ball Joint Assembly - Left Lower		54501JD000; 54501JY00A; 54501JD00D
SSP0183	301191601830 Steering Tie Rod - Front	M14x1,5 - L=232mm	D8521JG00A
SSP0590	301191605900 Steering Tie Rod End - Front Right	M14x1,5	48527JD01A; 48547JDA01; D8520JG00A
SSP0591	301191605910 Steering Tie Rod End - Front Left	M14x1,5	48527JDA01; 48647JD01A; D8640JG00A
SSP1926	301191619260 Suspension Ball Joint - Front Lower		Part of 54500JD000; Part of 54501JD000; Part of 545004CA0A; Part of 545014CA0A; Part of 545004CUA0; Part of 545014CUA0; Part of 545004BA0A; Part of 545004BA0A
SSP2470	301191624700 Suspension Stabilizer Bar Link - Rear Right	L=143,5mm	55618 JE20A; 55618JD00A; 55618JY00B
SSP2471	301191624710 Suspension Stabilizer Bar Link - Rear Left	L=143,5mm	55619JD00A; 55619JE20A; 55619JY00B
SSP2472	301191624720 Suspension Stabilizer Bar Link - Front Right	L=299,5mm	546181AA0A; 54618JD00A; 546181AA0E; 54618JA000
SSP2473	301191624730 Suspension Stabilizer Bar Link - Front Left	L=299,5mm	546681AA0A; 54668JD00A; 546681AA0E; 54668JA000

**NISSAN X-TRAIL 3rd Gen (T32)**

2013-

**SSP2471****SSP2470**

PART NO.	DESCRIPTION	NOTES	O.E.
SSP1926 301191619260	Suspension Ball Joint - Front Lower		Part of 54500JD000; Part of 54501JD000; Part of 545004CA0A; Part of 545014CA0A; Part of 545014CUA0; Part of 545004CUA0; Part of 545014BA0A; Part of 545004BA0A
SSP2470 301191624700	Suspension Stabilizer Bar Link - Rear Right	L=143,5mm	55618 JE20A; 55618JD00A; 55618JY00B
SSP2471 301191624710	Suspension Stabilizer Bar Link - Rear Left	L=143,5mm	55619JD00A; 55619JE20A; 55619JY00B



PART NO.	DESCRIPTION	NOTES	O.E.
SSP2121 301191621210	Suspension Stabilizer Bar Link - Rear		15697702



OLDSMOBILE BRAVADA 3rd Gen

2002-2003



ARM401

ARM400



PART NO.	DESCRIPTION	NOTES	O.E.
ARM400 301181340000	Suspension Control Arm - Front Right		25786775
ARM401 301181340100	Suspension Control Arm - Front Left		25786774



OPEL ADAM



10/2012-

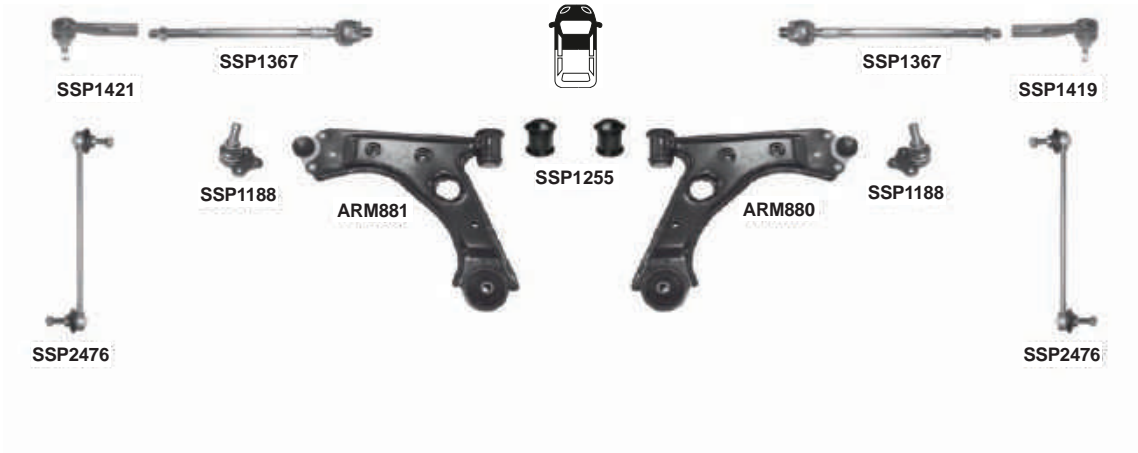

PART NO.	DESCRIPTION	NOTES	O.E.
ARM880 301181388000	Suspension Control Arm and Ball Joint Assembly - Front Right Lower		352543; 55703231; 5352038
ARM881 301181388100	Suspension Control Arm and Ball Joint Assembly - Front Left Lower		352542; 55703230; 5352039
SSP1188 301181311880	Suspension Ball Joint - Front		3520.87; 93190907; 51783057; 51783056; 3520.W3
SSP1255 301181312550	Bush / Silent block - Track control arm	ARM058 / ARM059 / ARM115 / ARM116	0352380, 55703232
SSP1367 301181313670	Steering Tie Rod - Front	M14x1,5Rht - L=295mm	1609211; 9950452; 9944452; 93196540
SSP1419 301181314190	Steering Tie Rod End - Front Right	M14x1,5Rht	1603545; 77363830; 1609458
SSP1421 301181314210	Steering Tie Rod End - Front Left	M14x1,5Rht	1603544; 77363829; 1609457
SSP2476 301191624760	Suspension Stabilizer Bar Link - Front	L=310mm	13391512; 350233

**OPEL AGILA (A)**

09/2000-08/2007



SSP0597

SSP0191



SSP0191

SSP0597



ARM037



ARM037



ARM877



ARM877



ARM879



ARM878

	PART NO.	DESCRIPTION	NOTES	O.E.
ARM037	301181303700	Suspension Control Arm and Ball Joint Assembly - Front Lower	Ch. 1 G075422-> L=294,6mm	4520084; 9210270; 4706665; 9214826; 4707280; 4705742; 4520085
ARM877	301181387700	Suspension Control Arm and Ball Joint Assembly - Front Lower	Ch. -> G075421 L=284mm	4705172; 96316765
ARM878	301181387800	Lateral Arm - Rear Right		9214829
ARM879	301181387900	Lateral Arm - Rear Left		9214832
SSP0191	301191601910	Steering Tie Rod - Front	M12x1,25 - L=239,8mm	4701745; 4883086G00; 4883083
SSP0597	301191605970	Steering Tie Rod End - Front	M12x1,25	4701744; 9204751; 48810830; 9210168; 488108300; 4705716; 4705655

OPEL AGILA (B)



09/2007-12/2014



	PART NO.	DESCRIPTION	NOTES	O.E.
ARM993	301181399300	Suspension Control Arm and Ball Joint Assembly - Front Right Lower		4520162J00; 4708299; 4520163J00
ARM994	301181399400	Suspension Control Arm and Ball Joint Assembly - Front Left Lower		4520262J00; 4708300; 4520263J00
SSP0249	301191602490	Steering Tie Rod - Front	M12x1,25 - L=305mm	4709161; 4883063J00
SSP0665	301191606650	Steering Tie Rod End - Front	M12x1,25	4709195; 48810M68K00; 4881063J00
SSP2539	301191625390	Suspension Stabilizer Bar Link - Front	L=300mm	4242062J00; 4709702



OPEL ANTARA



05/2006-

**SSP0354****SSP0354****SSP1808****ARM391****ARM390****SSP1808****SSP2126****SSP2125****SSP2123****SSP2124****SSP2123****SSP2124**

	PART NO.	DESCRIPTION	NOTES	O.E.
ARM390	301181339000	Suspension Control Arm and Ball Joint Assembly - Front Right Lower		C96819162
ARM391	301181339100	Suspension Control Arm and Ball Joint Assembly - Front Left Lower		C96819161
SSP0354	301191603540	Steering Tie Rod End - Front	M14x1,5	4803429; C96626667; 96626667
SSP1808	301191618080	Suspension Ball Joint - Front Lower		C96852964; 96852964; 13258056
SSP2123	301191621230	Suspension Stabilizer Bar Link - Rear	L=167mm	4804642; 96996460; 96626150; 4817539
SSP2124	301191621240	Suspension Stabilizer Bar Link - Rear	(Clip-on patented design) L=167mm	96626150; 96996460
SSP2125	301191621250	Suspension Stabilizer Bar Link - Front Right	L=286mm	C96626248
SSP2126	301191621260	Suspension Stabilizer Bar Link - Front Left	L=286mm	C96626247

OPEL ASTRA (G)



1998-2004

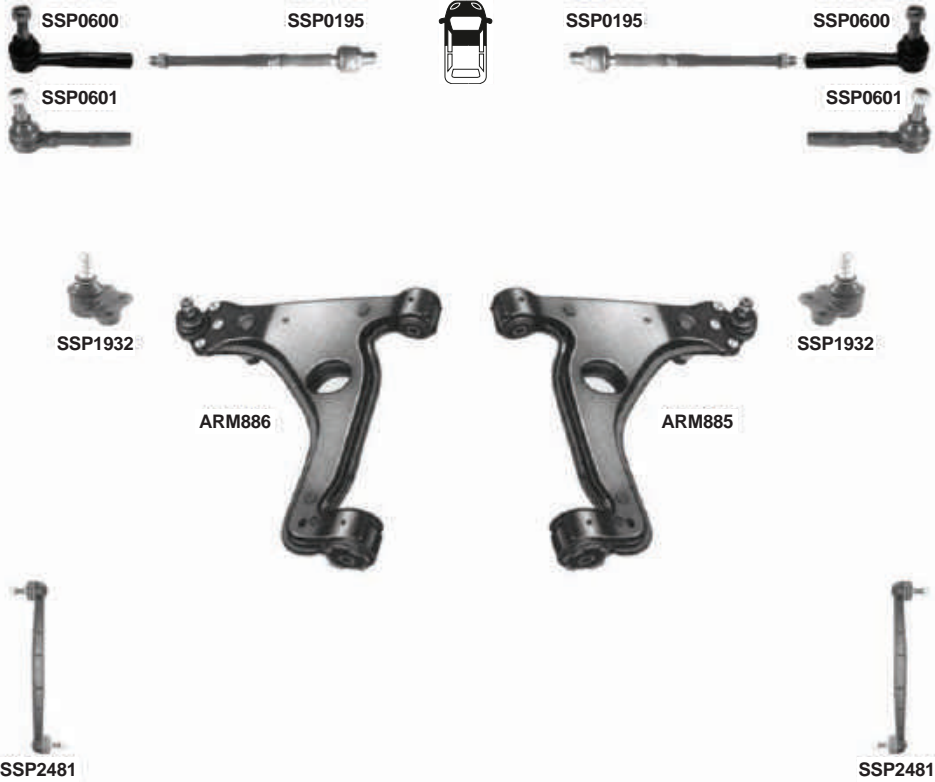

PART NO.	DESCRIPTION	NOTES	O.E.
ARM885	301181388500 Suspension Control Arm and Ball Joint Assembly - Front Right Lower		352004; 90496040; 5352017
ARM886	301181388600 Suspension Control Arm and Ball Joint Assembly - Front Left Lower		352005; 90496039; 5352016
SSP0195	301191601950 Steering Tie Rod - Front	Trw Steering M14x1,5 - L=280mm	1603213; 9118128; 1603216
SSP0600	301191606000 Steering Tie Rod End - Front	Only: Delphi Steering M14x1,5Rht	1603214
SSP0601	301191606010 Steering Tie Rod End - Front	Only: Trw Steering M14x1,5Rht	1603215
SSP1932	301191619320 Suspension Ball Joint - Front	D=Ø18mm	352800; 5231683; 90512982; 352830; 352829
SSP2481	301191624810 Suspension Stabilizer Bar Link - Front	Plastic L=300mm	350611; 90498745; 350614



OPEL ASTRA (H)



03/2004-11/2009

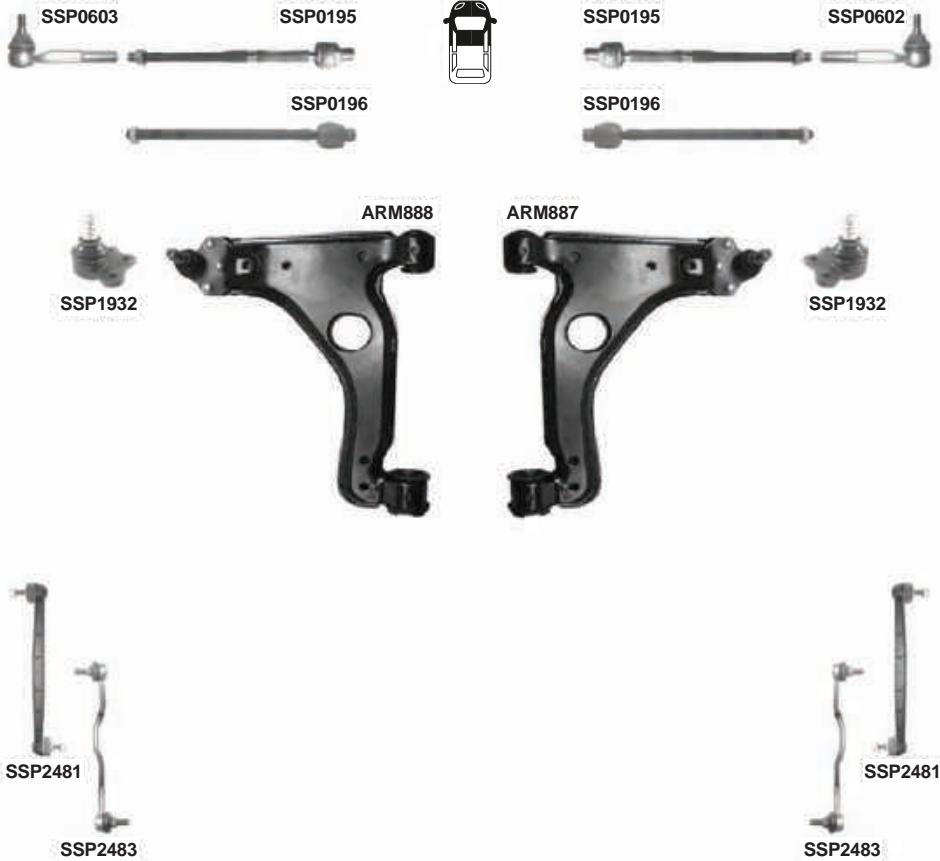

PART NO.	DESCRIPTION	NOTES	O.E.
ARM887	301181388700 Suspension Control Arm and Ball Joint Assembly - Front Right Lower		24454478; 352030
ARM888	301181388800 Suspension Control Arm and Ball Joint Assembly - Front Left Lower		24454477; 352029
SSP0195	301191601950 Steering Tie Rod - Front	Trw Steering M14x1,5 - L=280mm	1603213; 9118128; 1603216
SSP0196	301191601960 Steering Tie Rod - Front	Only :ZF-Steering Sport Susp. 18 ,19 inc Wheel M14x1,5 - L=276mm	1603264; 93189669; 93181230; 1603358
SSP0602	301191606020 Steering Tie Rod End - Front Right	Only: ZF - TRW Steering M14x1,5Rht	1603257; 93181233; 93186332; 1609012; 93179558; 1603288; 1603267
SSP0603	301191606030 Steering Tie Rod End - Front Left	Only: ZF - TRW Steering M14x1,5Rht	1603258; 93181232; 93186333; 1609013; 93179559; 1603289; 1603266
SSP1932	301191619320 Suspension Ball Joint - Front	D=Ø18mm	352800; 5231683; 90512982; 352830; 352829
SSP2481	301191624810 Suspension Stabilizer Bar Link - Front	Plastic L=300mm	350611; 90498745; 350614
SSP2483	301191624830 Suspension Stabilizer Bar Link - Front	Only: IDS Suspension Sist. L=300mm	24461353; 350613



OPEL ASTRA (J)



12/2009-05/2015



SSP2490



SSP2490

PART NO.	DESCRIPTION	NOTES	O.E.
ARM890 301181389000	Suspension Control Arm and Ball Joint Assembly - Front Right Lower		13272606; 352115; 352493; 13334023; 13321339
ARM891 301181389100	Suspension Control Arm and Ball Joint Assembly - Front Left Lower		13272605; 352110; 352492; 352106; 13321338
SSP0199 301191601990	Steering Tie Rod - Front	Type : POC NJ1 M16X1,5 - L=291mm	13286687; 1609027
SSP0200 301191602000	Steering Tie Rod - Front	Type : POC NJ0 M16X1,5 - L=288mm	13314465; 1609029
SSP0604 301191606040	Steering Tie Rod End - Front	M16x1,5	13272000; 1609026; 6606031; 13286686; 13278359
SSP2489 301191624890	Suspension Stabilizer Bar Link - Front	Metal Ch. Type: FLEXRIDE L=304mm	13258052; 350618
SSP2490 301191624900	Suspension Stabilizer Bar Link - Front	Plastic L=304mm	13219141; 350617; C13219141



OPEL ASTRA GTC (J)



2011-



PART NO.	DESCRIPTION	NOTES	O.E.
SSP0204 301191602040	Steering Tie Rod - Front	For vehicles with power steering	1609187
SSP0607 301191606070	Steering Tie Rod End - Front Right		13354540
SSP0608 301191606080	Steering Tie Rod End - Front Left		13354538
SSP1792 301191617920	Suspension Ball Joint - Front Upper		13258056
SSP2493 301191624930	Suspension Stabilizer Bar Link - Front Right	Only : GTC L-290MM	13285628; 350193
SSP2494 301191624940	Suspension Stabilizer Bar Link - Front Left	Only : GTC L-290MM	13282834; 350192



OPEL ASTRA (K)



06/2015-

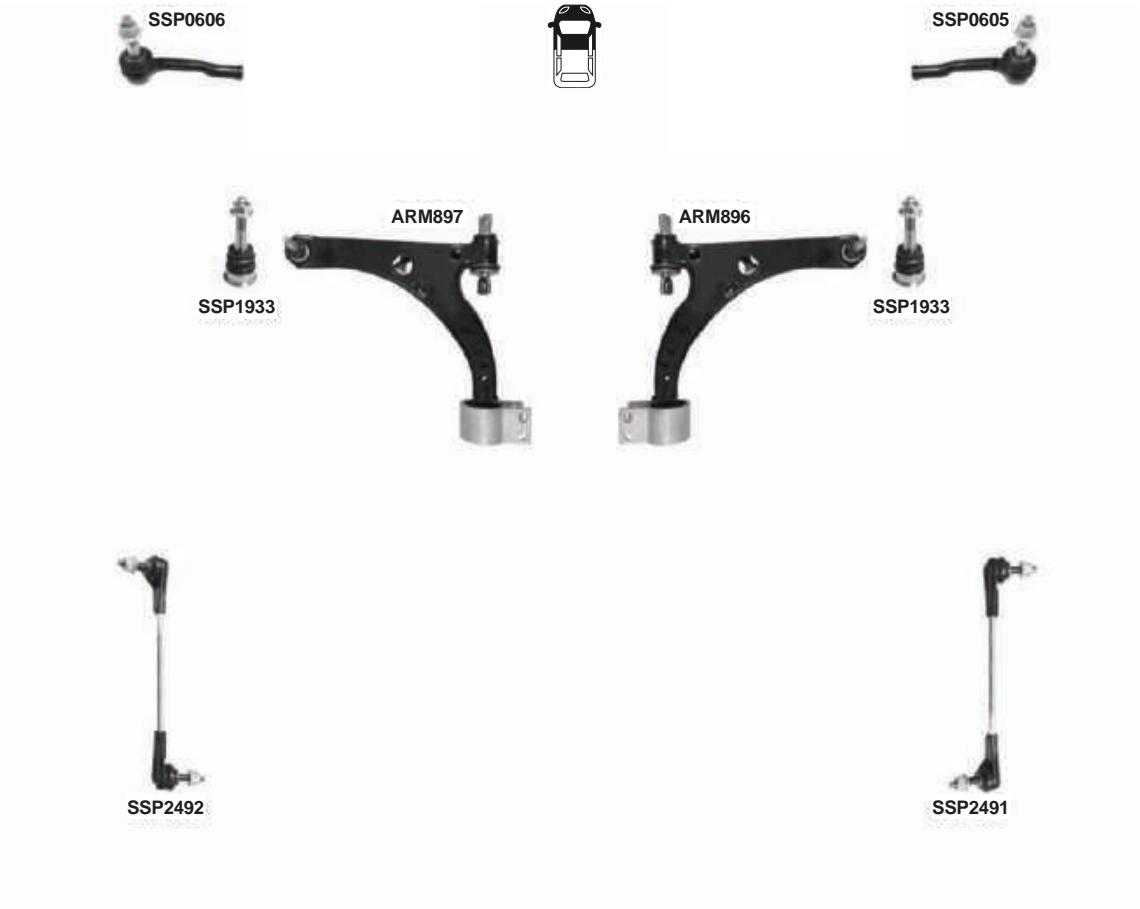

PART NO.	DESCRIPTION	NOTES	O.E.
ARM896	301181389600 Suspension Control Arm and Ball Joint Assembly - Front Right		39021473
ARM897	301181389700 Suspension Control Arm and Ball Joint Assembly - Front Left		39021472
SSP0203	301191602030 Steering Tie Rod - Front		13464344
SSP0605	301191606050 Steering Tie Rod End - Front Right		39008083
SSP0606	301191606060 Steering Tie Rod End - Front Left		39008084
SSP1933	301191619330 Suspension Ball Joint - Front Lower		Part of 39021472/3
SSP2491	301191624910 Suspension Stabilizer Bar Link - Front Right	A = 307 MM	39001004
SSP2492	301191624920 Suspension Stabilizer Bar Link - Front Left	A = 307 MM	39001003



OPEL COMBO (B)



03/1993-08/2000



PART NO.	DESCRIPTION	NOTES	O.E.
ARM871 301181387100	Suspension Control Arm and Ball Joint Assembly - Front Right Lower		5352012
ARM872 301181387200	Suspension Control Arm and Ball Joint Assembly - Front Left Lower		5352011
SSP0185 301191601850	Steering Tie Rod - Front	Power Steering M12x1,25 - L=278mm	322158
SSP0186 301191601860	Steering Tie Rod - Front	Manual Steering M12x1,5 - L=322mm	26030411; 322155
SSP0595 301191605950	Steering Tie Rod End - Front	M12x1,5	324066
SSP1928 301191619280	Suspension Ball Joint - Front	D=Ø15mm	1603202; 90539896
SSP2477 301191624770	Suspension Stabilizer Bar Link - Front	Only: Africa Type L=243mm	350610; 90496116; 5236823; 4886606

OPEL COMBO (C)



09/2000-07/2006



	PART NO.	DESCRIPTION	NOTES	O.E.
ARM873	301181387300	Suspension Control Arm and Ball Joint Assembly - Front Right Lower	Only: Africa Type	352063; 352042; 24428978
ARM874	301181387400	Suspension Control Arm and Ball Joint Assembly - Front Left Lower	Only: Africa Type	352061; 352041; 24428977
SSP0184	301191601840	Steering Tie Rod - Front	Only: Corsa C 1.7 TD M12X1,5 - L=310 mm	1603018; 1603843
SSP0188	301191601880	Steering Tie Rod - Front	CH:-> 33999999 / 34999999 M12x1,5 - L=316mm	1603008; 93192421; 26087867; 1603845
SSP0594	301191605940	Steering Tie Rod End - Front	M12x1,5Rht	1603009; 324050; 7840452; 324042; 26087868
SSP1929	301191619290	Suspension Ball Joint - Front	Only: Africa Type D=Ø16mm	352803; 9196394
SSP2477	301191624770	Suspension Stabilizer Bar Link - Front	Only: Africa Type L=243mm	350610; 90496116; 5236823; 4886606



MAGNETI
MARELLI

OPEL CORSA (A)



09/1982-02/1993



SSP0594



SSP0594



SSP1927



SSP1927

PART NO.	DESCRIPTION	NOTES	O.E.
SSP0594 301191605940	Steering Tie Rod End - Front	M12x1,5Rht	1603009; 324050; 7840452; 324042; 26087868
SSP1927 301191619270	Suspension Ball Joint - Front	D=Ø15mm	1603128; 90166394; 1603187; 1603161

OPEL CORSA (B)



03/1993-08/2000

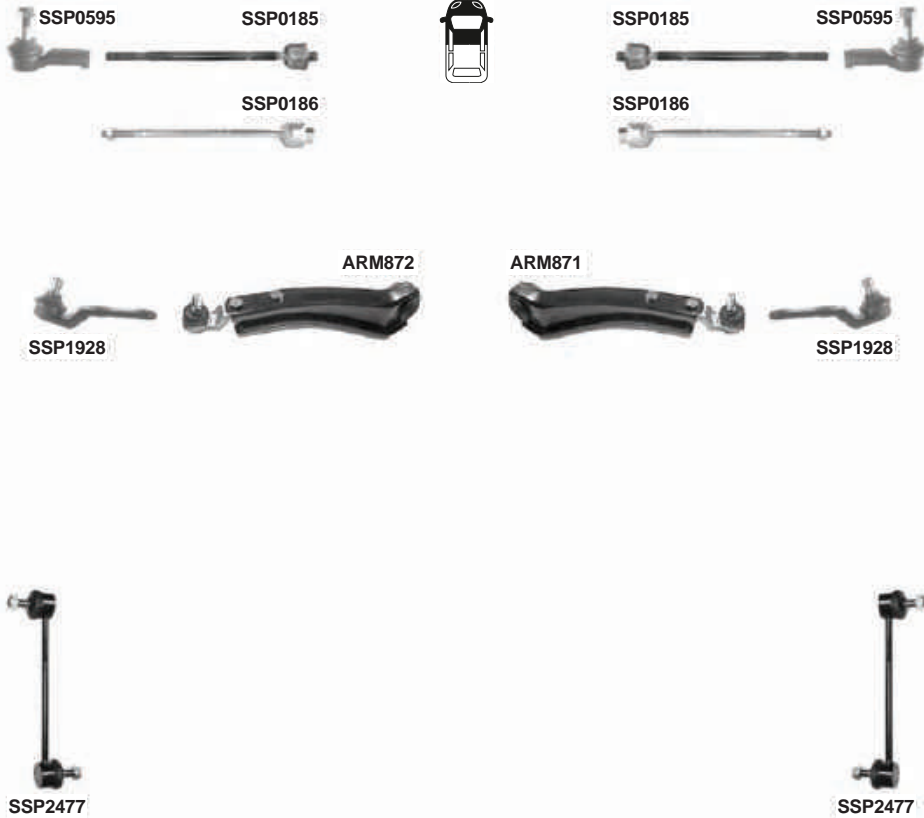

PART NO.	DESCRIPTION	NOTES	O.E.
ARM871 301181387100	Suspension Control Arm and Ball Joint Assembly - Front Right Lower		5352012
ARM872 301181387200	Suspension Control Arm and Ball Joint Assembly - Front Left Lower		5352011
SSP0185 301191601850	Steering Tie Rod - Front	Power Steering M12x1,25 - L=278mm	322158
SSP0186 301191601860	Steering Tie Rod - Front	Manual Steering M12x1,5 - L=322mm	26030411; 322155
SSP0595 301191605950	Steering Tie Rod End - Front	M12x1,5	324066
SSP1928 301191619280	Suspension Ball Joint - Front	D=Ø15mm	1603202; 90539896
SSP2477 301191624770	Suspension Stabilizer Bar Link - Front	Only: Africa Type L=243mm	350610; 90496116; 5236823; 4886606

**OPEL CORSA (B) 73,78,79**

08/1999-08/2000

**SSP0594****SSP0594****SSP1927****ARM870****ARM869****SSP1927**

	PART NO.	DESCRIPTION	NOTES	O.E.
ARM869	301181386900	Suspension Control Arm and Ball Joint Assembly - Front Right Lower		352002
ARM870	301181387000	Suspension Control Arm and Ball Joint Assembly - Front Left Lower		352003
SSP0594	301191605940	Steering Tie Rod End - Front	M12x1,5Rht	1603009; 324050; 7840452; 324042; 26087868
SSP1927	301191619270	Suspension Ball Joint - Front	D=Ø15mm	1603128; 90166394; 1603187; 1603161



PART NO.	DESCRIPTION	NOTES	O.E.
SSP2478 301191624780	Suspension Stabilizer Bar Link - Front	(Clip-on patented design) L=243mm	350610*; 5236823*; 4886606*



OPEL CORSA (C)



09/2000-07/2006

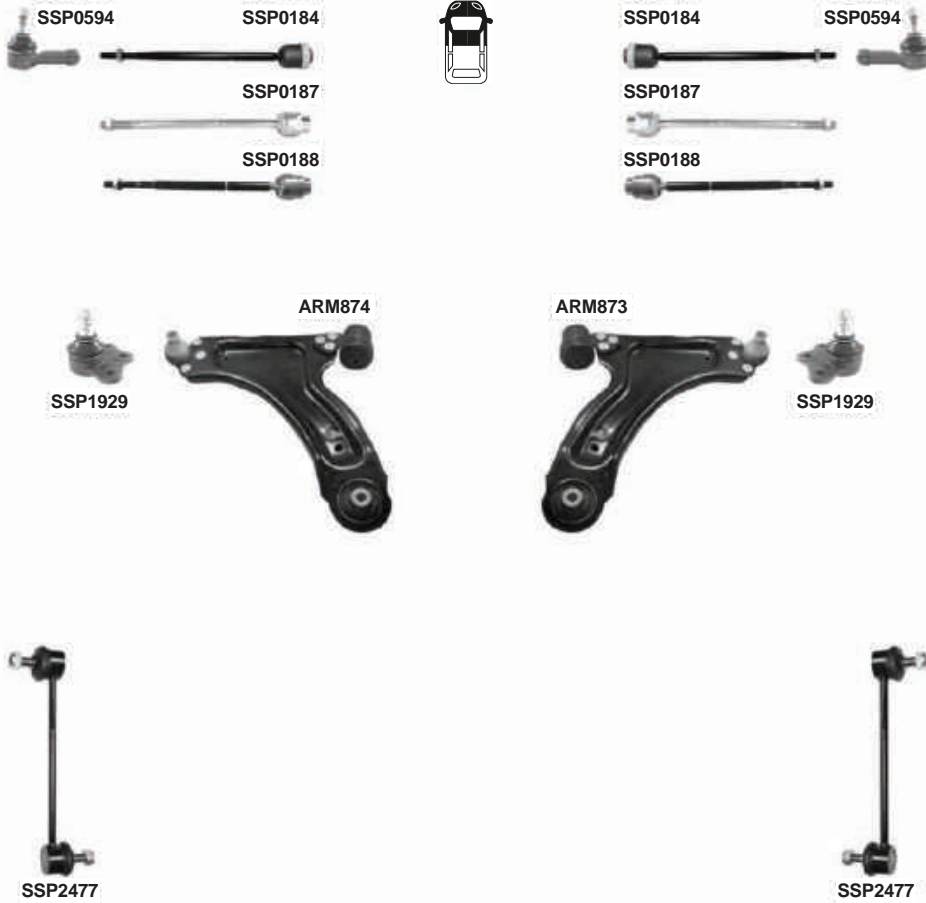

PART NO.	DESCRIPTION	NOTES	O.E.
ARM873	301181387300 Suspension Control Arm and Ball Joint Assembly - Front Right Lower	Only: Africa Type	352063; 352042; 24428978
ARM874	301181387400 Suspension Control Arm and Ball Joint Assembly - Front Left Lower	Only: Africa Type	352061; 352041; 24428977
SSP0184	301191601840 Steering Tie Rod - Front	Only: Corsa C 1.7 TDÌ M12X1,5 - L=310 mm	1603018; 1603843
SSP0187	301191601870 Steering Tie Rod - Front	CH: 43000001 / 44000001 - > C = M14X1,5	1603844; 93192420
SSP0188	301191601880 Steering Tie Rod - Front	CH:-> 33999999 / 34999999 M12x1,5 - L=316mm	1603008; 93192421; 26087867; 1603845
SSP0594	301191605940 Steering Tie Rod End - Front	M12x1,5Rht	1603009; 324050; 7840452; 324042; 26087868
SSP0611	301191606110 Steering Tie Rod End - Front	South America Market	93296756
SSP1929	301191619290 Suspension Ball Joint - Front	Only: Africa Typel D=Ø16mm	352803; 9196394
SSP2477	301191624770 Suspension Stabilizer Bar Link - Front	Only: Africa Type L=243mm	350610; 90496116; 5236823; 4886606



PART NO.	DESCRIPTION	NOTES	O.E.
SSP2478 301191624780	Suspension Stabilizer Bar Link - Front	(Clip-on patented design) L=243mm	350610*; 5236823*; 4886606*



OPEL CORSA (D)



08/2006-08/2014

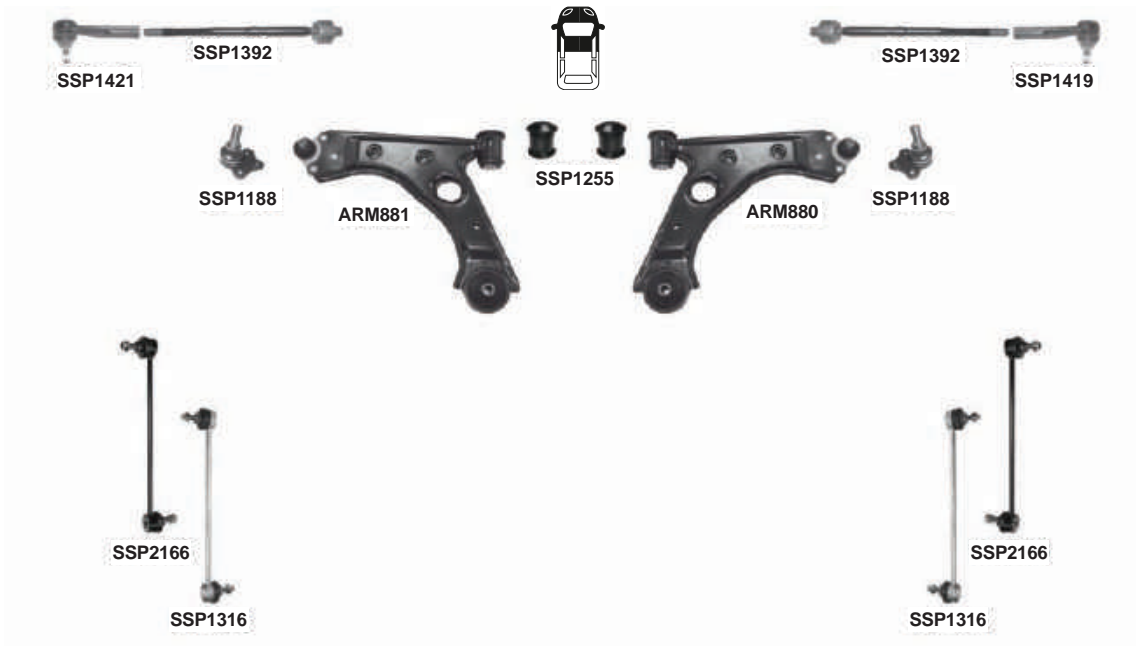

PART NO.	DESCRIPTION	NOTES	O.E.
ARM880	301181388000 Suspension Control Arm and Ball Joint Assembly - Front Right Lower		352543; 55703231; 5352038
ARM881	301181388100 Suspension Control Arm and Ball Joint Assembly - Front Left Lower		352542; 55703230; 5352039
SSP1188	301181311880 Suspension Ball Joint - Front		3520.87; 93190907; 51783057; 51783056; 3520.W3
SSP1255	301181312550 Bush / Silent block - Track control arm	ARM058 / ARM059 / ARM115 / ARM116	352380, 55703232
SSP1316	301181313160 Suspension Stabilizer Bar Link - Front	L=300mm	350616; 55700753; 50515276
SSP1392	301181313920 Steering Tie Rod - Front	M14x1,5 - L=289mm	1603543; 93189022
SSP1419	301181314190 Steering Tie Rod End - Front Right	M14x1,5Rht	1603545; 77363830; 1609458
SSP1421	301181314210 Steering Tie Rod End - Front Left	M14x1,5Rht	1603544; 77363829; 1609457
SSP2166	301191621660 Suspension Stabilizer Bar Link - Front	(Clip-on patented design) L=300mm	55700753



OPEL CORSA (E)



09/2014-

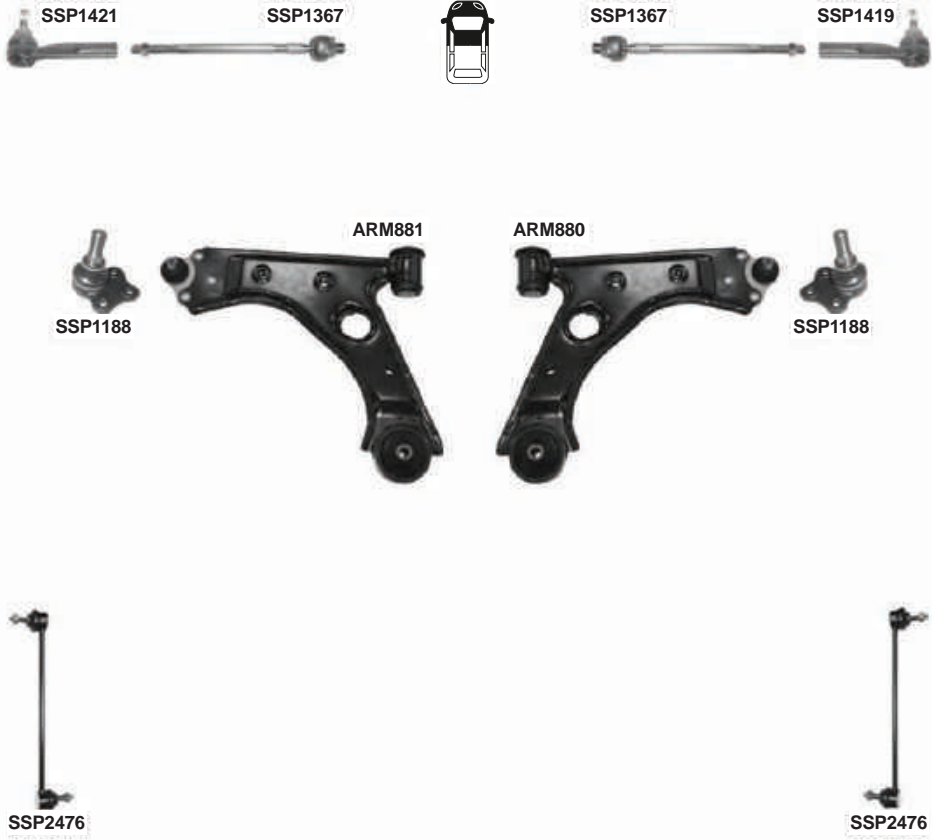

PART NO.	DESCRIPTION	NOTES	O.E.
ARM880 301181388000	Suspension Control Arm and Ball Joint Assembly - Front Right Lower		352543; 55703231; 5352038
ARM881 301181388100	Suspension Control Arm and Ball Joint Assembly - Front Left Lower		352542; 55703230; 5352039
SSP1188 301181311880	Suspension Ball Joint - Front		3520.87; 93190907; 51783057; 51783056; 3520.W3
SSP1367 301181313670	Steering Tie Rod - Front	M14x1,5Rht - L=295mm	1609211; 9950452; 9944452; 93196540
SSP1419 301181314190	Steering Tie Rod End - Front Right	M14x1,5Rht	1603545; 77363830; 1609458
SSP1421 301181314210	Steering Tie Rod End - Front Left	M14x1,5Rht	1603544; 77363829; 1609457
SSP2476 301191624760	Suspension Stabilizer Bar Link - Front	L=310mm	13391512; 350233

**OPEL CORSA (Utility)**

2003-2010



	PART NO.	DESCRIPTION	NOTES	O.E.
ARM873	301181387300	Suspension Control Arm and Ball Joint Assembly - Front Right Lower	Only: Africa Type	352063; 352042; 24428978
ARM874	301181387400	Suspension Control Arm and Ball Joint Assembly - Front Left Lower	Only: Africa Type	352061; 352041; 24428977
SSP0043	301191600430	Steering Tie Rod - Front	M14X1,5 - L=275mm	93388624
SSP1929	301191619290	Suspension Ball Joint - Front	Only: Africa Type L=Ø16mm	352803; 9196394
SSP2477	301191624770	Suspension Stabilizer Bar Link - Front	Only: Africa Type L=243mm	350610; 90496116; 5236823; 4886606
SSP2478	301191624780	Suspension Stabilizer Bar Link - Front	Only: Africa Type (Clip-on patented design) L=243mm	350610*; 5236823*; 4886606*



	PART NO.	DESCRIPTION	NOTES	O.E.
ARM894	301181389400	Suspension Control Arm and Ball Joint Assembly - Front Right Lower		352071; 352870
ARM895	301181389500	Suspension Control Arm and Ball Joint Assembly - Front Left		352050; 352869
SSP0035	301191600350	Steering Tie Rod - Front	(Chance Rate,Electric Tops Reduced Rac) M16x1.5 / L=313mm	13332651; 1609181
SSP0036	301191600360	Steering Tie Rod - Front	(Chance Rate,Standart Rac Movement) M16x1.5 / L=313mm	13332653; 1609183
SSP0202	301191602020	Steering Tie Rod - Front Inner	M16x1,5 - L=309 mm	13271996; 6606030
SSP0604	301191606040	Steering Tie Rod End - Front	M16x1,5	13272000; 1609026; 6606031; 13286686; 13278359
SSP0609	301191606090	Steering Tie Rod End - Front Right	(OPC Type)	13272002
SSP0610	301191606100	Steering Tie Rod End - Front Left	(OPC Type)	13272001
SSP1792	301191617920	Suspension Ball Joint - Front Upper		13258056
SSP2486	301191624860	Suspension Stabilizer Bar Link - Front		13282833
SSP2487	301191624870	Suspension Stabilizer Bar Link - Rear	L=71,5mm	13281792; 444081
SSP2488	301191624880	Suspension Stabilizer Bar Link - Rear	Only:4x4 L=133mm	444087
SSP2489	301191624890	Suspension Stabilizer Bar Link - Front	Metal Only : IDS L=304mm	13258052; 350618
SSP2490	301191624900	Suspension Stabilizer Bar Link - Front	Plastic Only: IDS L=304mm	13219141; 350617; C13219141



OPEL MERIVA (A)



05/2003-05/2010



PART NO.	DESCRIPTION	NOTES	O.E.
ARM875 301181387500	Suspension Control Arm and Ball Joint Assembly - Front Right Lower		5352028; 93388569
ARM876 301181387600	Suspension Control Arm and Ball Joint Assembly - Front Left Lower		5352027; 93388568
SSP0189 301191601890	Steering Tie Rod - Front	Manual Steering M14X1,5 - L=312 mm	1603239; 1603428
SSP0190 301191601900	Steering Tie Rod - Front Inner	M14x1,5 - L=316mm	1603016; 26110429
SSP0596 301191605960	Steering Tie Rod End - Front	M14x1,5	16032240; 93192417; 16032440
SSP1930 301191619300	Suspension Ball Joint - Front Right	O-167 D=Ø16mm	5352026
SSP1931 301191619310	Suspension Ball Joint - Front Left	O-168 D=Ø16mm	5352025
SSP2477 301191624770	Suspension Stabilizer Bar Link - Front	L=243mm	350610; 90496116; 5236823; 4886606
SSP2478 301191624780	Suspension Stabilizer Bar Link - Front	(Clip-on patented design) L=243mm	350610*; 5236823*; 4886606*



OPEL MERIVA (B)



06/2010-



PART NO.	DESCRIPTION	NOTES	O.E.
ARM887 301181388700	Suspension Control Arm and Ball Joint Assembly - Front Right Lower		24454478; 352030
ARM888 301181388800	Suspension Control Arm and Ball Joint Assembly - Front Left Lower		24454477; 352029
SSP0192 301191601920	Steering Tie Rod - Front	(PR Except) M14X1,5 - L=233mm	93196777
SSP0193 301191601930	Steering Tie Rod - Front	(PR including) M14X1,5 - L=233mm	1609011; 93196778
SSP0602 301191606020	Steering Tie Rod End - Front Right	M14x1,5Rht	1603257; 93181233; 93186332; 1609012; 93179558; 1603288; 1603267
SSP0603 301191606030	Steering Tie Rod End - Front Left	M14x1,5Rht	1603258; 93181232; 93186333; 1609013; 93179559; 1603289; 1603266
SSP1932 301191619320	Suspension Ball Joint - Front	D=Ø18mm	352800; 5231683; 90512982; 352830; 352829
SSP2477 301191624770	Suspension Stabilizer Bar Link - Front	L=243mm	350610; 90496116; 5236823; 4886606



OPEL MOKKA



06/2012-

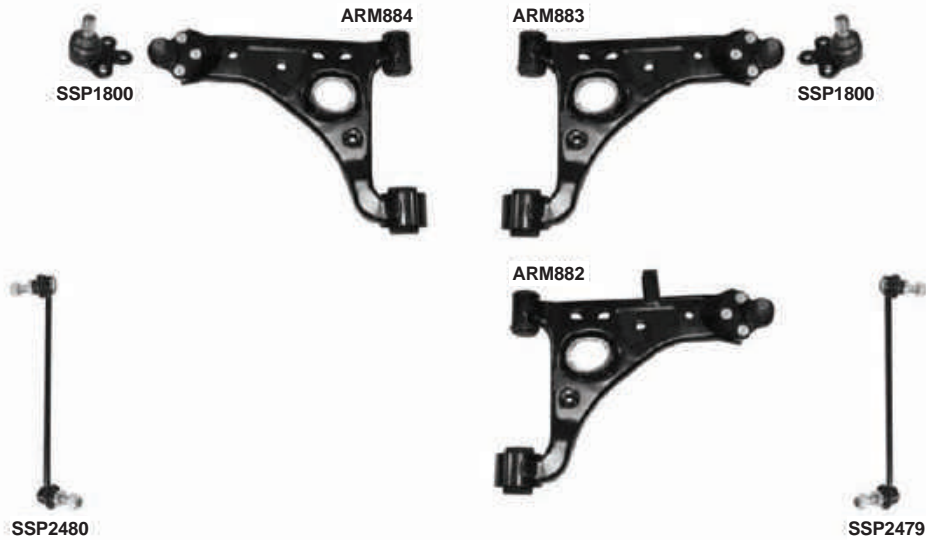

PART NO.	DESCRIPTION	NOTES	O.E.
ARM882	Suspension Control Arm and Ball Joint Assembly - Front Right	Only : Xenon ,adapatif Type	352522; 95025704
ARM883	Suspension Control Arm and Ball Joint Assembly - Front Right Lower	SDT.Type	352523; 95025705
ARM884	Suspension Control Arm and Ball Joint Assembly - Front Left Lower	SDT.Type	352524; 95025706
SSP0033	Steering Tie Rod - Front	Elektrik Type. M14X1,5 - L=333mm	1609213; 95952929
SSP0194	Steering Tie Rod - Front	Hidrolik Type. M14x1.5 -L=349mm	1609205; 95932789
SSP0598	Steering Tie Rod End - Front	Elektrikal Type M14X1,5	1609203; 95914910; 95932779
SSP0599	Steering Tie Rod End - Front	Hidrolik Type. M14x1.5	1609206
SSP1800	Suspension Ball Joint - Front Lower		352532; 95916024
SSP2479	Suspension Stabilizer Bar Link - Front Right	Metal L=286mm	15779960; 95942520; 350232*
SSP2480	Suspension Stabilizer Bar Link - Front Left	Metal L=286mm	15779961; 350231*

OPEL MOVANO (A)



07/1998-04/2010

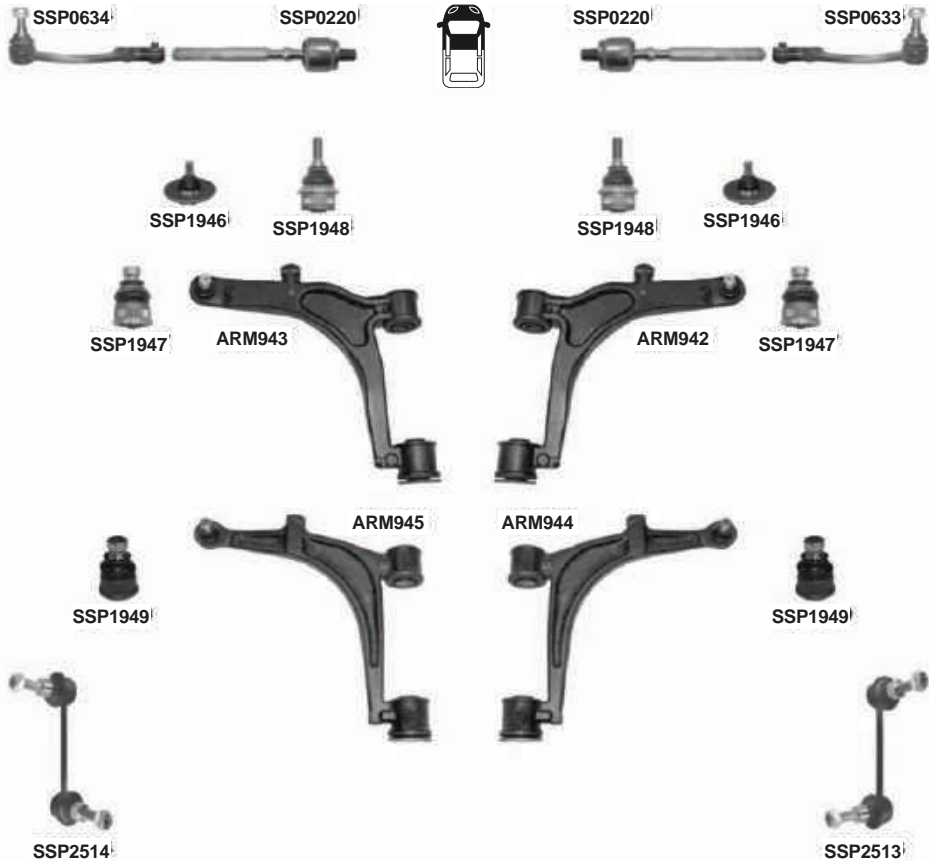

PART NO.	DESCRIPTION	NOTES	O.E.
ARM942	Suspension Control Arm and Ball Joint Assembly - Front Right Lower	Ball Joint D=Ø 22mm	4400048; 7700309190; 8200767825; 7700302119; 5450000QAD
ARM943	Suspension Control Arm and Ball Joint Assembly - Front Left Lower	Ball Joint D=Ø 22mm	4404047; 7700309189; 8200767822; 7700302118; 5450100QAD
ARM944	Suspension Control Arm and Ball Joint Assembly - Front Right	D=Ø24mm	4418630; 93194855; 8200750274
ARM945	Suspension Control Arm and Ball Joint Assembly - Front Left	D=Ø24mm	4418629; 93194853; 8200750273
SSP0220	Steering Tie Rod - Front	M16x1,5 - L=176mm	4501261; 7701470362; 4852100QAF
SSP0633	Steering Tie Rod End - Front Right	M16x1,5Rht	4501263; 9161563; 7701470364; 4852000QAH
SSP0634	Steering Tie Rod End - Front Left	M16x1,5Rht	4501262; 9161562; 7701470363; 4852000QAJ
SSP1946	Suspension Ball Joint - Front Upper		4011000QAA; 7701056970; 4500090; 7700302114; 4401910; 4011000QAB
SSP1947	Suspension Ball Joint - Front Lower	D=Ø22mm	4016000QAD; 9160555; 7700312852; 4500255
SSP1948	Suspension Ball Joint - Front		4016000QAB; 7700312851; 9161561; 4501261; 4500254
SSP1949	Suspension Ball Joint - Front Lower	D=Ø24mm	4016000QOB; 7701070154; 4418631
SSP2513	Suspension Stabilizer Bar Link - Front Right	L=127mm	4500199; 8200713523; 9160499; 7700309071; 5461800QAA
SSP2514	Suspension Stabilizer Bar Link - Front Left	L=127mm	4500198; 8200713522; 9160498; 7700309070; 5461800QAB

**OPEL MOVANO (B)**

05/2010-

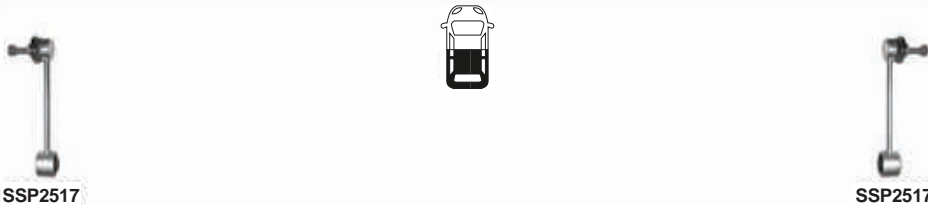

PART NO.	DESCRIPTION	NOTES	O.E.
ARM946 301181394600	Suspension Control Arm - Front Right Lower		4419216; 8200688875
ARM947 301181394700	Suspension Control Arm - Front Left Lower		4419215; 93197214; 8200688871
SSP0221 301191602210	Steering Tie Rod - Front	M18X1,5 - L=253mm	485212373R
SSP0635 301191606350	Steering Tie Rod End - Front Right	M18X1,5	4420098; 485200780R
SSP0636 301191606360	Steering Tie Rod End - Front Left	M18X1,5	4420097; 485206730R
SSP1950 301191619500	Suspension Ball Joint - Front Left Lower	D=Ø17,9mm	4419219; 93197233; 8200688877
SSP1951 301191619510	Suspension Ball Joint - Front Right Lower	D=Ø17,9mm	401608374R
SSP2515 301191625150	Suspension Stabilizer Bar Link - Front	L=330mm	4419291; 93197325; 546180004R
SSP2517 301191625170	Suspension Stabilizer Bar Link - Rear	L=166mm	4420954; 93168675; 551100020R



OPEL OMEGA (B)



04/1994-07/2003



PART NO.	DESCRIPTION	NOTES	O.E.
SSP1932 301191619320	Suspension Ball Joint - Front	D=Ø18mm	352800; 5231683; 90512982; 352830; 352829



OPEL SIGNUM



03/2003-08/2008

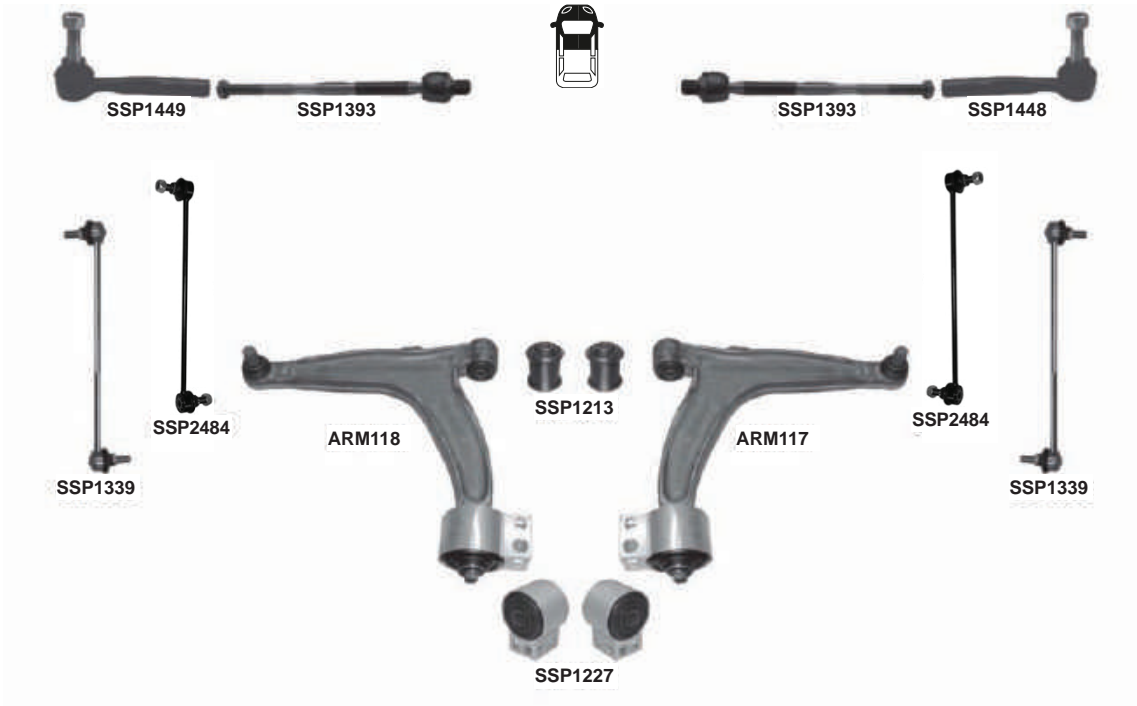

PART NO.	DESCRIPTION	NOTES	O.E.
ARM117 301181311700	Suspension Control Arm and Ball Joint Assembly - Front Right Lower		352052; 51748652; 12799200; 12796014
ARM118 301181311800	Suspension Control Arm and Ball Joint Assembly - Front Left Lower		352051; 51748653; 12799200; 12796013
SSP1213 301181312130	Bush / Silent block - Track control arm	ARM117 / ARM118	"352357, 352364, 4566899, 6140350007, 90468636"
SSP1227 301181312270	Bush / Silent block - Track control arm	ARM117 / ARM118	352319, 93171448
SSP1339 301181313390	Suspension Stabilizer Bar Link - Front	L=352,5mm	24417251; 51741130; 350603
SSP1393 301181313930	Steering Tie Rod - Front Inner	M14x1,5 - L=284mm	1603229; 93172256
SSP1448 301181314480	Steering Tie Rod End - Front Right	M14x1,5Rht	1603228; 5239322; 5235668
SSP1449 301181314490	Steering Tie Rod End - Front Left	M14x1,5Rht	1603227; 5239314; 5235650
SSP2484 301191624840	Suspension Stabilizer Bar Link - Front	(Clip-on patented design) L=352,5mm	350603; 24417251; 350615



OPEL VECTRA (B)



1996-07/2002

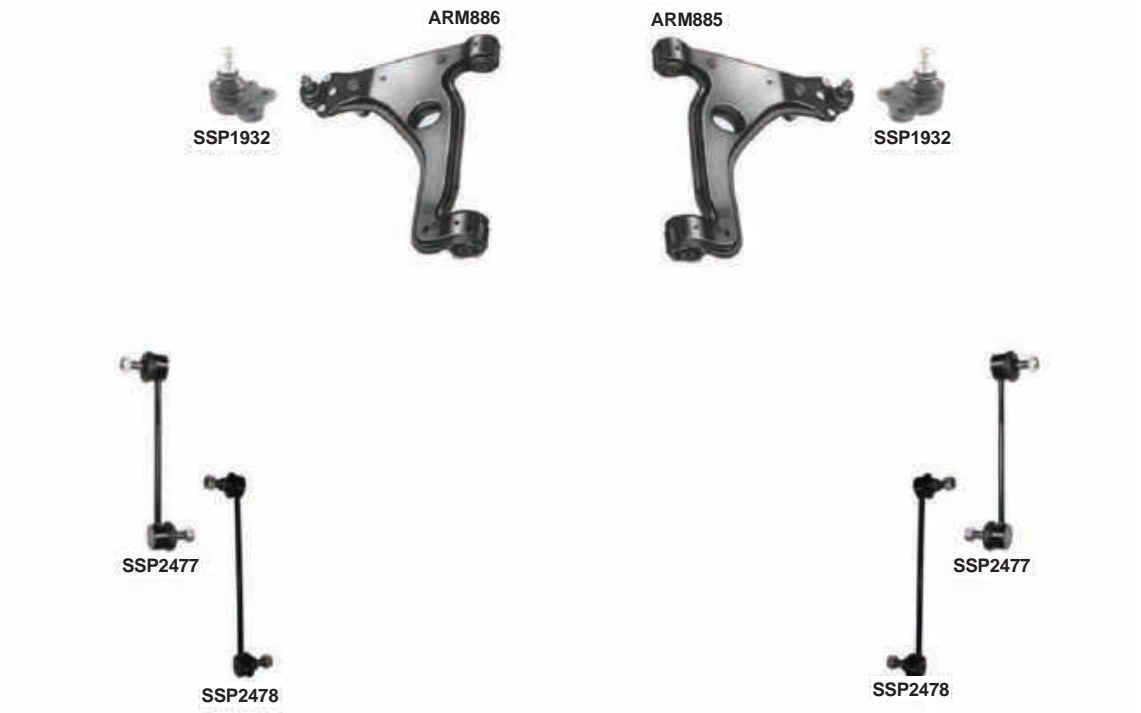

	PART NO.	DESCRIPTION	NOTES	O.E.
ARM885	301181388500	Suspension Control Arm and Ball Joint Assembly - Front Right Lower		352004; 90496040; 5352017
ARM886	301181388600	Suspension Control Arm and Ball Joint Assembly - Front Left Lower		352005; 90496039; 5352016
SSP1932	301191619320	Suspension Ball Joint - Front	D=Ø18mm	352800; 5231683; 90512982; 352830; 352829
SSP2477	301191624770	Suspension Stabilizer Bar Link - Front	L=243mm	350610; 90496116; 5236823; 4886606
SSP2478	301191624780	Suspension Stabilizer Bar Link - Front	(Clip-on patented design) L=243mm	350610*; 5236823*; 4886606*



OPEL VECTRA (C)



08/2002-09/2008

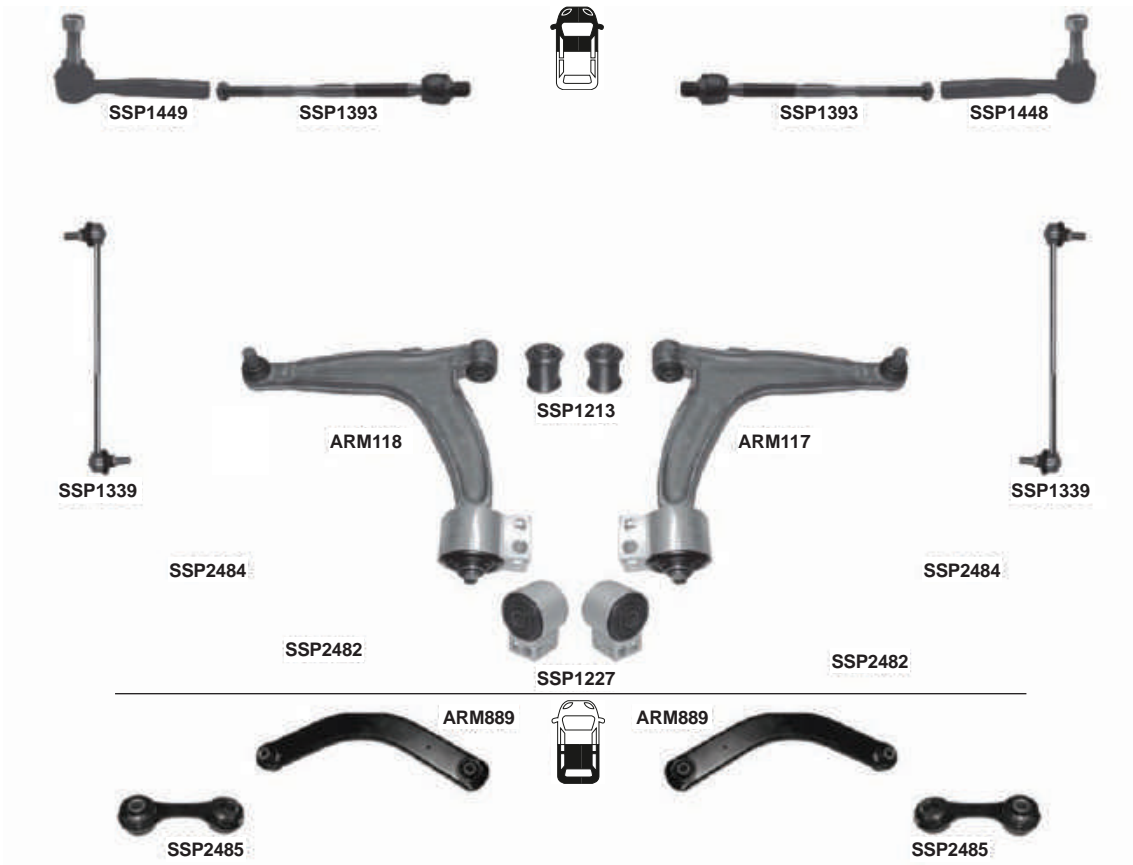

PART NO.	DESCRIPTION	NOTES	O.E.
ARM117	301181311700	Suspension Control Arm and Ball Joint Assembly - Front Right Lower	352052; 51748652; 12799200; 12796014
ARM118	301181311800	Suspension Control Arm and Ball Joint Assembly - Front Left Lower	352051; 51748653; 12799200; 12796013
ARM889	301181388900	Lateral Arm - Rear Upper	13105744; 423008
SSP0198	301191601980	Steering Tie Rod - Front	Only:16,17 Wheel M14x1,5 - L=285mm 12804238; 1603416; 46989683; 1603384; 1603244
SSP1213	301181312130	Bush / Silent block - Track control arm	ARM117 / ARM118 "352357, 352364, 4566899, 6140350007, 90468636"
SSP1227	301181312270	Bush / Silent block - Track control arm	ARM117 / ARM118 352319, 93171448
SSP1339	301181313390	Suspension Stabilizer Bar Link - Front	L=352,5mm 24417251; 51741130; 350603
SSP1393	301181313930	Steering Tie Rod - Front Inner	M14x1,5 - L=284mm 1603229; 93172256
SSP1448	301181314480	Steering Tie Rod End - Front Right	M14x1,5Rht 1603228; 5239322; 5235668
SSP1449	301181314490	Steering Tie Rod End - Front Left	M14x1,5Rht 1603227; 5239314; 5235650
SSP2482	301191624820	Suspension Stabilizer Bar Link - Front	(IDS) L=353mm 13116332; 350612
SSP2484	301191624840	Suspension Stabilizer Bar Link - Front	(Clip-on patented design) L=352,5mm 350603; 24417251; 350615
SSP2485	301191624850	Suspension Stabilizer Bar Link - Rear	L=86mm 25816039; 444275

OPEL VIVARO I



08/2001-06/2014

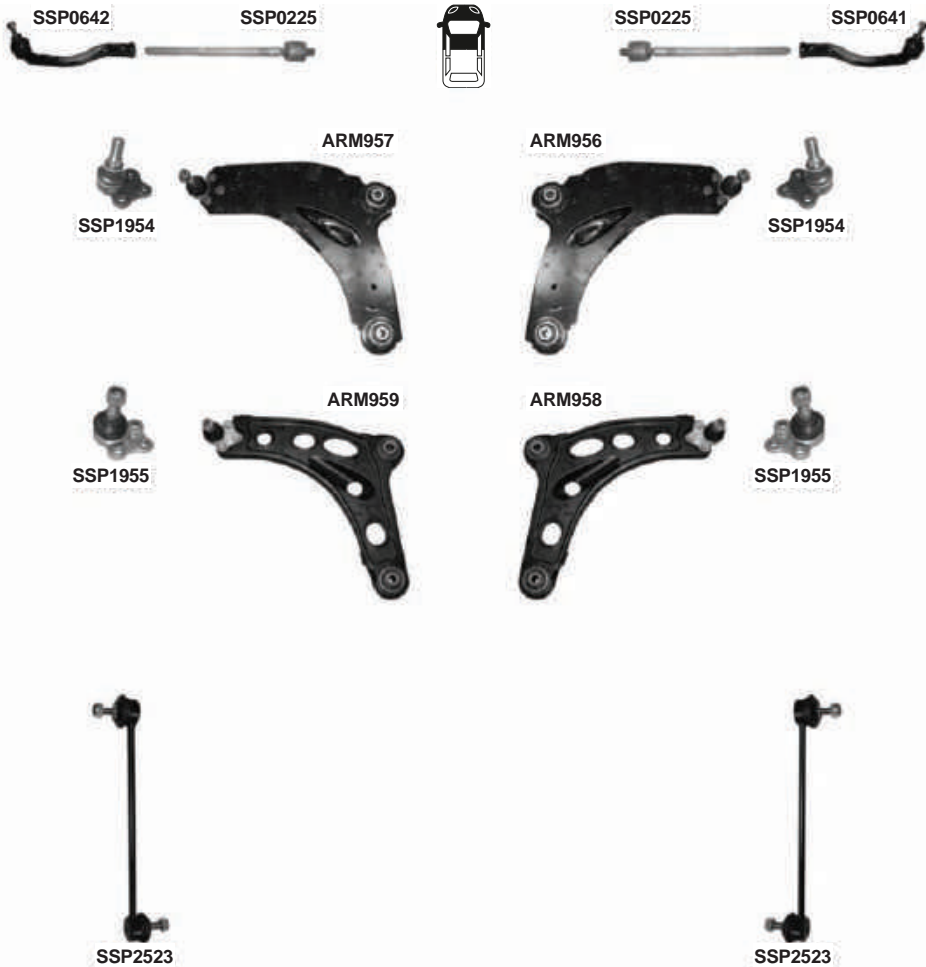

	PART NO.	DESCRIPTION	NOTES	O.E.
ARM956	301181395600	Suspension Control Arm and Ball Joint Assembly - Front Right Lower		4421646; 8200247900; 91166641; 8200054006; 5450200QAB
ARM957	301181395700	Suspension Control Arm and Ball Joint Assembly - Front Left Lower		4421647; 8200247898; 91166642; 8200054003; 5450300QA3
ARM958	301181395800	Suspension Control Arm and Ball Joint Assembly - Front Right Lower		4417178; 93853465; 8200565079; 5450200QOC
ARM959	301181395900	Suspension Control Arm and Ball Joint Assembly - Front Left Lower		4417177; 93853464; 8200565072; 5450300QOC
SSP0225	301191602250	Steering Tie Rod - Front	M14x1,5 - L=263mm	4408474; 7701473333; 4852000QAM
SSP0641	301191606410	Steering Tie Rod End - Front Right	M14x1,5Rht	4408511; 91160044; 7701049283; 4852000QAL
SSP0642	301191606420	Steering Tie Rod End - Front Left	M14x1,5Rht	4408510; 91160043; 7701049282; 4852000QAK
SSP1954	301191619540	Suspension Ball Joint - Front Lower		4016000QQA; 91166461*; 7701476576; 4412936
SSP1955	301191619550	Suspension Ball Joint - Front Lower	Ø12mm	7701477385
SSP2523	301191625230	Suspension Stabilizer Bar Link - Front	(Clip-on patented design) L=279mm	4408904; 8200002870; 5461600QAC

**OPEL VIVARO II**

10/2014-



PART NO.	DESCRIPTION	NOTES	O.E.
ARM938 301181393800	Suspension Control Arm and Ball Joint Assembly - Front Right		545006069R
ARM939 301181393900	Suspension Control Arm and Ball Joint Assembly - Front Left		545019956R
SSP0225 301191602250	Steering Tie Rod - Front	M14x1,5 - L=263mm	4408474; 7701473333; 4852000QAM
SSP0641 301191606410	Steering Tie Rod End - Front Right	M14x1,5Rht	4408511; 91160044; 7701049283; 4852000QAL
SSP0642 301191606420	Steering Tie Rod End - Front Left	M14x1,5Rht	4408510; 91160043; 7701049282; 4852000QAK
SSP1943 301191619430	Suspension Ball Joint - Front		Part of 545006069R; Part of 545019956R
SSP2522 301191625220	Suspension Stabilizer Bar Link - Front	L=279mm	4408904; 8200002870; 546181944R; 5461600QAC



OPEL ZAFIRA (A)



1998-2004

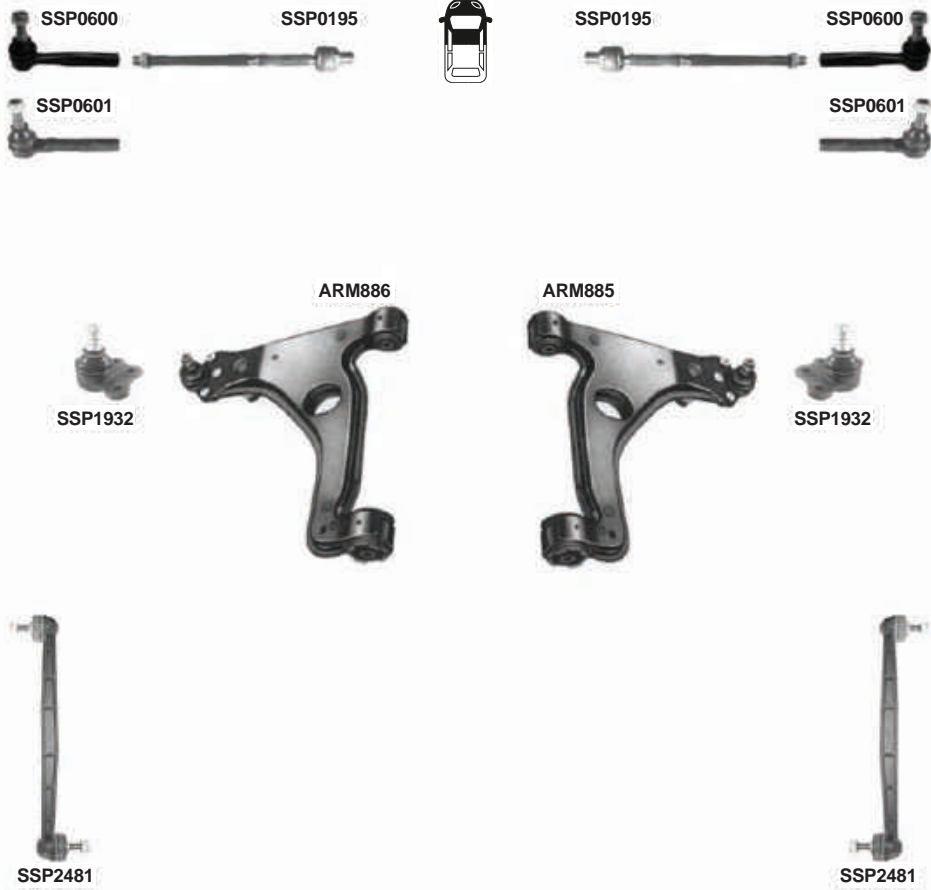

PART NO.	DESCRIPTION	NOTES	O.E.
ARM885 301181388500	Suspension Control Arm and Ball Joint Assembly - Front Right Lower		352004; 90496040; 5352017
ARM886 301181388600	Suspension Control Arm and Ball Joint Assembly - Front Left Lower		352005; 90496039; 5352016
SSP0195 301191601950	Steering Tie Rod - Front	Trw Steering M14x1,5 - L=280mm	1603213; 9118128; 1603216
SSP0600 301191606000	Steering Tie Rod End - Front	Only: Delphi Steering M14x1,5Rht	1603214
SSP0601 301191606010	Steering Tie Rod End - Front	Only: Trw Steering M14x1,5Rht	1603215
SSP1932 301191619320	Suspension Ball Joint - Front	D=Ø18mm	352800; 5231683; 90512982; 352830; 352829
SSP2481 301191624810	Suspension Stabilizer Bar Link - Front	Plastic L=300mm	350611; 90498745; 350614

**OPEL ZAFIRA (B) (A05)**

07/2005-09/2011

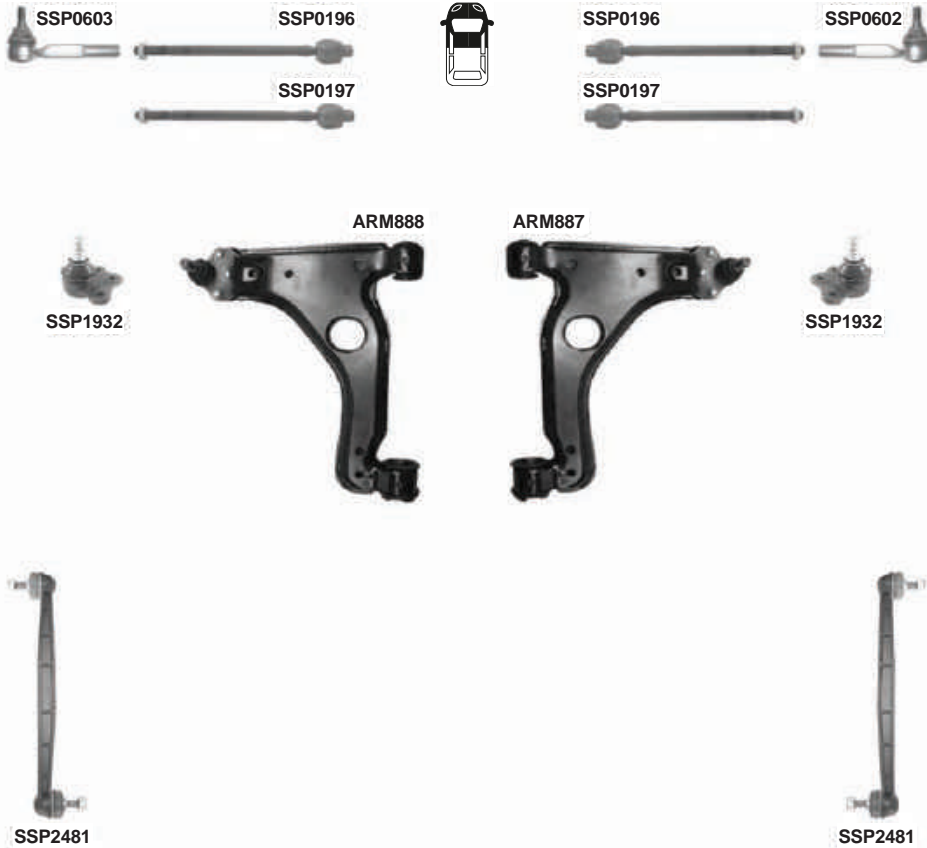

PART NO.	DESCRIPTION	NOTES	O.E.
ARM887	301181388700 Suspension Control Arm and Ball Joint Assembly - Front Right Lower		24454478; 352030
ARM888	301181388800 Suspension Control Arm and Ball Joint Assembly - Front Left Lower		24454477; 352029
SSP0196	301191601960 Steering Tie Rod - Front	Only :ZF-Steering Sport Süsp. 18 ,19 inc Wheel M14x1,5 - L=276mm	1603264; 93189669; 93181230; 1603358
SSP0197	301191601970 Steering Tie Rod - Front	Only : TRW Steering 1.6 -1.8 Lt. M14x1,5 - L=272mm	1603287; 93186330; 1603642
SSP0602	301191606020 Steering Tie Rod End - Front Right	Only: ZF - TRW Steering M14x1,5Rht	1603257; 93181233; 93186332; 1609012; 93179558; 1603288; 1603267
SSP0603	301191606030 Steering Tie Rod End - Front Left	Only: ZF - TRW Steering M14x1,5Rht	1603258; 93181232; 93186333; 1609013; 93179559; 1603289; 1603266
SSP1932	301191619320 Suspension Ball Joint - Front	D=Ø18mm	352800; 5231683; 90512982; 352830; 352829
SSP2481	301191624810 Suspension Stabilizer Bar Link - Front	Plastic L=300mm	350611; 90498745; 350614

OPEL ZAFIRA (C) (P12)



10/2011-

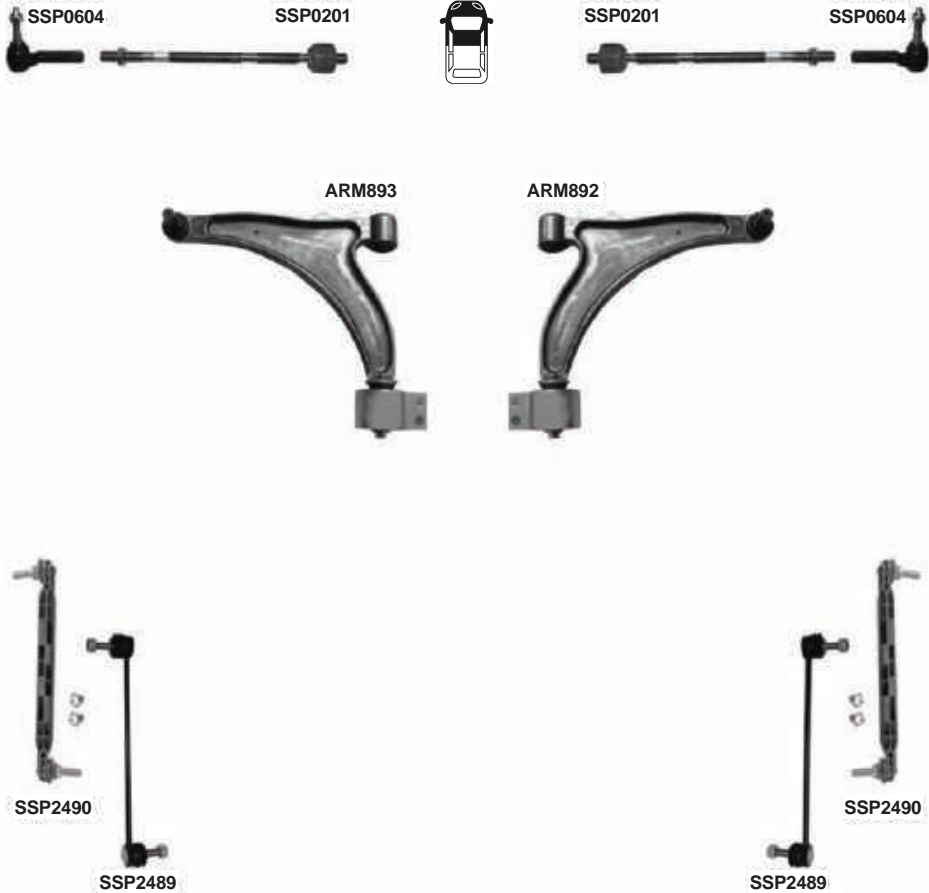

PART NO.	DESCRIPTION	NOTES	O.E.
ARM892 301181389200	Suspension Control Arm and Ball Joint Assembly - Front Right Lower		352510; 352550
ARM893 301181389300	Suspension Control Arm and Ball Joint Assembly - Front Left		352509; 352549
SSP0201 301191602010	Steering Tie Rod - Front	M16X1,5 - L=310 mm	1609184
SSP0604 301191606040	Steering Tie Rod End - Front	M16x1,5	13272000; 1609026; 6606031; 13286686; 13278359
SSP2489 301191624890	Suspension Stabilizer Bar Link - Front	Metal L=304mm	13258052; 350618
SSP2490 301191624900	Suspension Stabilizer Bar Link - Front	Plastic L=304mm	13219141; 350617; C13219141

**PEUGEOT 104**

1972-1988



PART NO.	DESCRIPTION	NOTES	O.E.
SSP0612 301191606120	Steering Tie Rod End - Front	M14x1,5Rht	3817.10; 95493208; 9471000965; 9471003465; 3817.18; 3817.50



PEUGEOT 106



08/1991-03/2004



**PEUGEOT 106**

08/1991-03/2004

	PART NO.	DESCRIPTION	NOTES	O.E.
ARM898	301181389800	Suspension Control Arm and Ball Joint Assembly - Front Right Lower	D=Ø16mm	3520.79; 95658979
ARM899	301181389900	Suspension Control Arm and Ball Joint Assembly - Front Left Lower	D=Ø16mm	3520.78; 95658978
ARM900	301181390000	Suspension Control Arm and Ball Joint Assembly - Front Right Lower	Only: GTI	3520.81; 3520.93
ARM901	301181390100	Suspension Control Arm and Ball Joint Assembly - Front Left	Only: GTI	3520.80; 3520.92
SSP0051	301191600510	Steering Tie Rod - Front	M14x1,5Rht / Lht - L=380mm	3812.A0; 95069129
SSP0368	301191603680	Steering Tie Rod End - Front Right	M14x1,5Rht	3817.16; 9471007565; 9471000665; 3817.42; 3817.31
SSP0369	301191603690	Steering Tie Rod End - Front Left	M14x1,5Rht	3817.14; 9471000565; 9471007465; 9458084180; 3817.41; 3817.30
SSP1817	301191618170	Suspension Ball Joint - Front Lower	D=Ø16mm	3640.36; 96093233
SSP2138	301191621380	Suspension Stabilizer Bar Link - Front	L=322,5mm M10 Thread	96145457
SSP2139	301191621390	Suspension Stabilizer Bar Link - Front	L=322,5mm M12 Thread	5087.40; 96177836; 93802209
SSP2140	301191621400	Suspension Stabilizer Bar Link - Front	(Clip-on patented design) L=322,5mm M12 Thread	500310933; 96145457; 5087.40
SSP2142	301191621420	Suspension Stabilizer Bar Link - Front	Only : GTI L=300mm	5087.33; 96147514



PEUGEOT 107



06/2005-

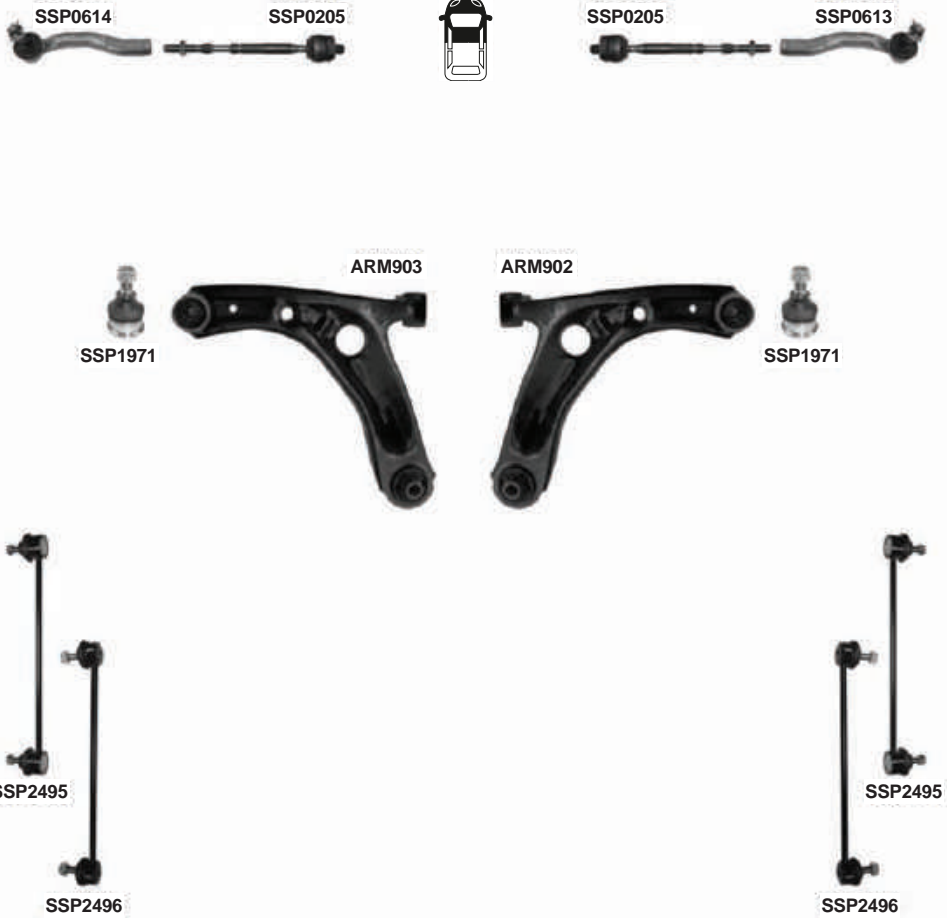

PART NO.	DESCRIPTION	NOTES	O.E.
ARM902 301181390200	Suspension Control Arm and Ball Joint Assembly - Front Right Lower		3521.L3; 480680H010; 3521.N7
ARM903 301181390300	Suspension Control Arm and Ball Joint Assembly - Front Left Lower		3520.Q2; 480690H010; 3520.R6
SSP0205 301191602050	Steering Tie Rod - Front	M12X1,25 - L=224mm	4001.33; 455000H010
SSP0613 301191606130	Steering Tie Rod End - Front Right Outer	M12x1,25	3817.64
SSP0614 301191606140	Steering Tie Rod End - Front Left Outer	M12x1,25	3817.63
SSP1971 301191619710	Suspension Ball Joint - Front Lower		4330859035; 4330859095
SSP2495 301191624950	Suspension Stabilizer Bar Link - Front	L=335mm	5087.45; 96288787
SSP2496 301191624960	Suspension Stabilizer Bar Link - Front	(Clip-on patented design) L=335mm	5087.45; 96288787



PEUGEOT 205



1983-1998



PART NO.	DESCRIPTION	NOTES	O.E.
SSP0049 301191600490	Steering Tie Rod - Front	M14x1,5 - L=312 mm	3812.95*
SSP0206 301191602060	Steering Tie Rod - Front Inner	M14x1,5 - L=314mm	3812.25; 96136394; 3812.95
SSP0612 301191606120	Steering Tie Rod End - Front	M14x1,5Rht	3817.10; 95493208; 9471000965; 9471003465; 3817.18; 3817.50



PEUGEOT 206



08/1998-12/2008



ARM905



ARM904



ARM908



ARM906



ARM911



ARM910



ARM909



ARM907



SSP2495

SSP2496



SSP2495

SSP2496

**PEUGEOT 206**

08/1998-12/2008

	PART NO.	DESCRIPTION	NOTES	O.E.
ARM904	301181390400	Suspension Control Arm and Ball Joint Assembly - Front Right Lower		3521.C8; 3521.P8
ARM905	301181390500	Suspension Control Arm and Ball Joint Assembly - Front Left Lower		3520.G8; 3520.W0; 3520.S8; 3520.L7
ARM906	301181390600	Suspension Control Arm and Ball Joint Assembly - Front Right Lower	Only:GTI	3521.E7
ARM907	301181390700	Suspension Control Arm and Ball Joint Assembly - Front Right Lower	Ch.No: RP 4441->	3521.H9
ARM908	301181390800	Suspension Control Arm and Ball Joint Assembly - Front Left	Only:GTI	3520.H7
ARM909	301181390900	Suspension Control Arm and Ball Joint Assembly - Front Left	Ch.No: RP 4441->	3520.L7
ARM910	301181391000	Suspension Control Arm and Ball Joint Assembly - Front Right Lower	Ch.No: -> 16V PR9505 -	3521.J0
ARM911	301181391100	Suspension Control Arm and Ball Joint Assembly - Front Left	Ch.No: -> 16V PR9505 -	3520.L8
SSP0207	301191602070	Steering Tie Rod - Front	M14X1,5 - L=300mm	3812.C5
SSP0368	301191603680	Steering Tie Rod End - Front Right	M14x1,5Rht	3817.16; 9471007565; 9471000665; 3817.42; 3817.31
SSP0369	301191603690	Steering Tie Rod End - Front Left	M14x1,5Rht	3817.14; 9471000565; 9471007465; 9458084180; 3817.41; 3817.30
SSP2495	301191624950	Suspension Stabilizer Bar Link - Front	L=335mm	5087.45; 96288787
SSP2496	301191624960	Suspension Stabilizer Bar Link - Front	(Clip-on patented design) L=335mm	5087.45; 96288787



PEUGEOT 206+



01/2009-12/2012



PART NO.	DESCRIPTION	NOTES	O.E.
ARM904 301181390400	Suspension Control Arm and Ball Joint Assembly - Front Right Lower		3521.C8; 3521.P8
ARM905 301181390500	Suspension Control Arm and Ball Joint Assembly - Front Left Lower		3520.G8; 3520.W0; 3520.S8; 3520.L7
SSP0207 301191602070	Steering Tie Rod - Front	M14X1,5 - L=300mm	3812.C5
SSP0368 301191603680	Steering Tie Rod End - Front Right	M14x1,5Rht	3817.16; 9471007565; 9471000665; 3817.42; 3817.31
SSP0369 301191603690	Steering Tie Rod End - Front Left	M14x1,5Rht	3817.14; 9471000565; 9471007465; 9458084180; 3817.41; 3817.30
SSP2495 301191624950	Suspension Stabilizer Bar Link - Front	L=335mm	5087.45; 96288787
SSP2496 301191624960	Suspension Stabilizer Bar Link - Front	(Clip-on patented design) L=335mm	5087.45; 96288787



PEUGEOT 207



02/2006-11/2012

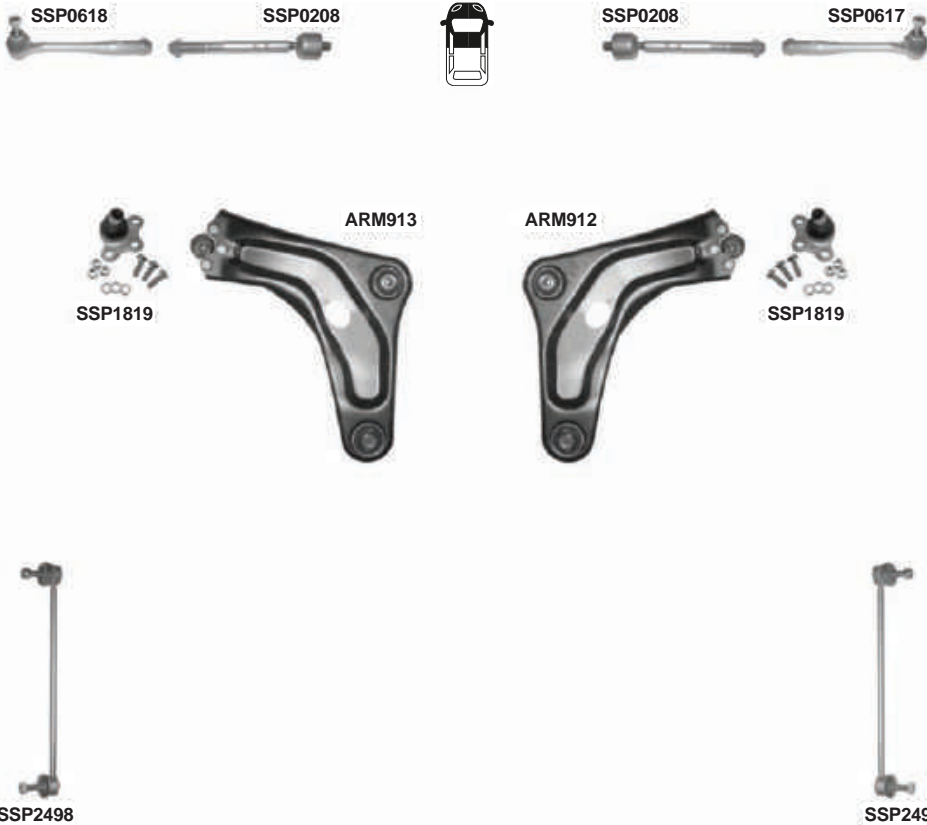

PART NO.	DESCRIPTION	NOTES	O. E.
ARM912 301181391200	Suspension Control Arm and Ball Joint Assembly - Front Right Lower		3521.N0; 3521.N8
ARM913 301181391300	Suspension Control Arm and Ball Joint Assembly - Front Left Lower		3520.Q9; 3520.R7
SSP0208 301191602080	Steering Tie Rod - Front	M16x1,5 - L=213mm	3812.E8
SSP0617 301191606170	Steering Tie Rod End - Front Right	M16x1,5	1608652380; 3817.68
SSP0618 301191606180	Steering Tie Rod End - Front Left	M16x1,5	1608652280; 3817.67
SSP1819 301191618190	Suspension Ball Joint - Front Lower	D=Ø 18mm	3640.56; 3640.66; 3640.65; 3640.62; 3640.61
SSP2497 301191624970	Suspension Stabilizer Bar Link - Front Right	L=330mm	5087.55; 5087.68
SSP2498 301191624980	Suspension Stabilizer Bar Link - Front Left	L=330mm	5087.54; 5087.69



PEUGEOT 208



03/2012-



	PART NO.	DESCRIPTION	NOTES	O.E.
ARM922	301181392200	Suspension Control Arm and Ball Joint Assembly - Front Right Lower		9670771480
ARM923	301181392300	Suspension Control Arm and Ball Joint Assembly - Front Left Lower		9670772080
SSP0211	301191602110	Steering Tie Rod - Front	M14x1.5 - L=225mm	1608025380
SSP0623	301191606230	Steering Tie Rod End - Front Right	M14x1.5 - L=200mm	1608025280
SSP0624	301191606240	Steering Tie Rod End - Front Left	M14x1.5 - L=200mm	1608025180
SSP1937	301191619370	Suspension Ball Joint - Front Lower		3640.78
SSP2497	301191624970	Suspension Stabilizer Bar Link - Front Right	L=330mm	5087.55; 5087.68
SSP2498	301191624980	Suspension Stabilizer Bar Link - Front Left	L=330mm	5087.54; 5087.69



PEUGEOT 208 GTI



03/2012-



PART NO.	DESCRIPTION	NOTES	O. E.
ARM922 301181392200	Suspension Control Arm and Ball Joint Assembly - Front Right Lower		9670771480
ARM923 301181392300	Suspension Control Arm and Ball Joint Assembly - Front Left Lower		9670772080
SSP0211 301191602110	Steering Tie Rod - Front	M14x1.5 - L=225mm	1608025380
SSP0617 301191606170	Steering Tie Rod End - Front Right	Only: GTI Type M16X1,5	1608652380; 3817.68
SSP0618 301191606180	Steering Tie Rod End - Front Left	Only: GTI Type M16X1,5	1608652280; 3817.67
SSP1937 301191619370	Suspension Ball Joint - Front Lower		3640.78
SSP2497 301191624970	Suspension Stabilizer Bar Link - Front Right	L=330mm	5087.55; 5087.68
SSP2498 301191624980	Suspension Stabilizer Bar Link - Front Left	L=330mm	5087.54; 5087.69



PEUGEOT 301



11/2012-

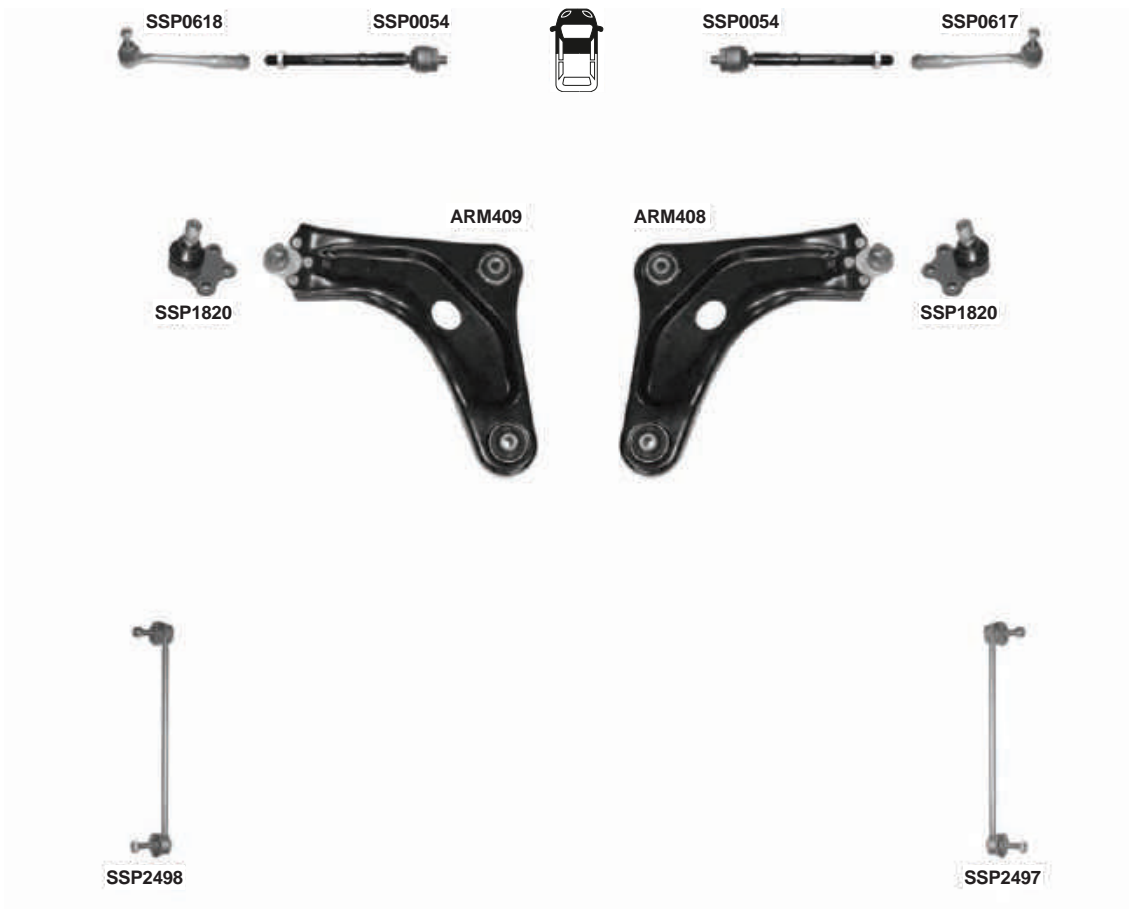

PART NO.	DESCRIPTION	NOTES	O.E.
ARM408 301181340800	Suspension Control Arm and Ball Joint Assembly - Front Right		9675028880
ARM409 301181340900	Suspension Control Arm and Ball Joint Assembly - Front Left		9675031880
SSP0054 301191600540	Steering Tie Rod - Front	M16X1,5 - L=230mm	1608652180
SSP0617 301191606170	Steering Tie Rod End - Front Right	M16X1,5	1608652380; 3817.68
SSP0618 301191606180	Steering Tie Rod End - Front Left	M16X1,5	1608652280; 3817.67
SSP1820 301191618200	Suspension Ball Joint - Front Lower		3640.77
SSP2497 301191624970	Suspension Stabilizer Bar Link - Front Right	L=330mm	5087.55; 5087.68
SSP2498 301191624980	Suspension Stabilizer Bar Link - Front Left	L=330mm	5087.54; 5087.69



PEUGEOT 305



1977-1984



PART NO.	DESCRIPTION	NOTES	O.E.
SSP0612 301191606120	Steering Tie Rod End - Front	M14x1,5Rht	3817.10; 95493208; 9471000965; 9471003465; 3817.18; 3817.50



PEUGEOT 306



1993-2001

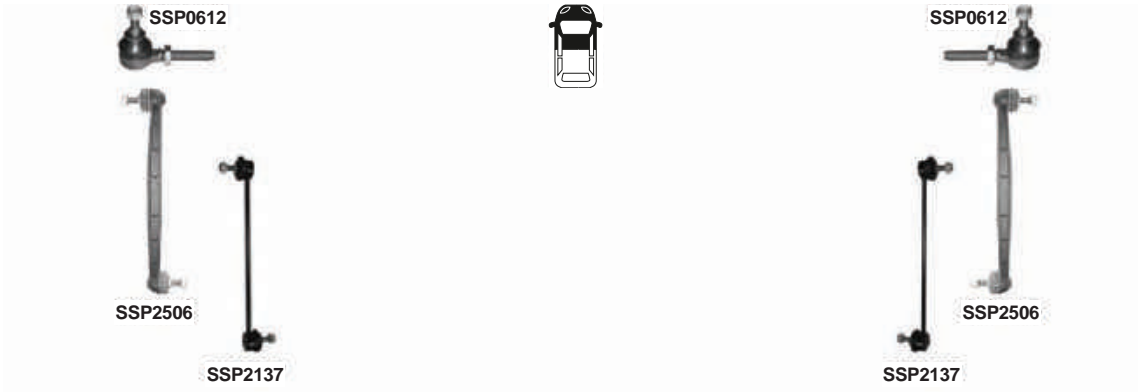

PART NO.	DESCRIPTION	NOTES	O.E.
SSP0612 301191606120	Steering Tie Rod End - Front	M14x1,5Rht	3817.10; 95493208; 9471000965; 9471003465; 3817.18; 3817.50
SSP2137 301191621370	Suspension Stabilizer Bar Link - Front	Metal L=300mm	5087.34; 5087.61; 5087.46; 5087.39
SSP2506 301191625060	Suspension Stabilizer Bar Link - Front	Plastic Type L=300mm	5087.42; 96152213



PEUGEOT 307



08/2000-12/2008



	PART NO.	DESCRIPTION	NOTES	O.E.
ARM926	301181392600	Suspension Control Arm - Front Right Lower		3521.G8; 3521.P3; 3521.K3
ARM927	301181392700	Suspension Control Arm - Front Left		3520.K8; 3520.S2; 3520.P3
SSP0212	301191602120	Steering Tie Rod - Front	Ch.No:->10310 M14x1,5 - L=322mm	3812.E0
SSP0213	301191602130	Steering Tie Rod - Front	Ch.No:10311-> M14x1,5 - L=340mm	3812.E5
SSP0368	301191603680	Steering Tie Rod End - Front Right	M14x1,5Rht	3817.16; 9471007565; 9471000665; 3817.42; 3817.31
SSP0369	301191603690	Steering Tie Rod End - Front Left	M14x1,5Rht	3817.14; 9471000565; 9471007465; 9458084180; 3817.41; 3817.30
SSP1939	301191619390	Suspension Ball Joint - Front Lower		3640.53; 3640.68; 3640.60
SSP2509	301191625090	Suspension Stabilizer Bar Link - Front	L=335mm	5087.50; 96347856; 9804947480; 5087.64; 5087.62
SSP2511	301191625110	Suspension Stabilizer Bar Link - Front	(Clip-on patented design) L=335mm	5087.50*

PEUGEOT 308



09/2007-10/2013



PART NO.	DESCRIPTION	NOTES	O.E.
ARM928 301181392800	Suspension Control Arm - Front Right Lower		3521.R3
ARM929 301181392900	Suspension Control Arm - Front Left		3520.V2
SSP0214 301191602140	Steering Tie Rod - Front	M14x1,5 - L=272mm	3812.F2
SSP0625 301191606250	Steering Tie Rod End - Front Right	M14x1,5	3817.75; 3817.88
SSP0626 301191606260	Steering Tie Rod End - Front Left	M14x1,5	3817.76; 3817.89
SSP1940 301191619400	Suspension Ball Joint - Front		3640.73
SSP2509 301191625090	Suspension Stabilizer Bar Link - Front	L=335mm	5087.50; 96347856; 9804947480; 5087.64; 5087.62
SSP2511 301191625110	Suspension Stabilizer Bar Link - Front	(Clip-on patented design) L=335mm	5087.50*

**PEUGEOT 308 II**

09/2013-

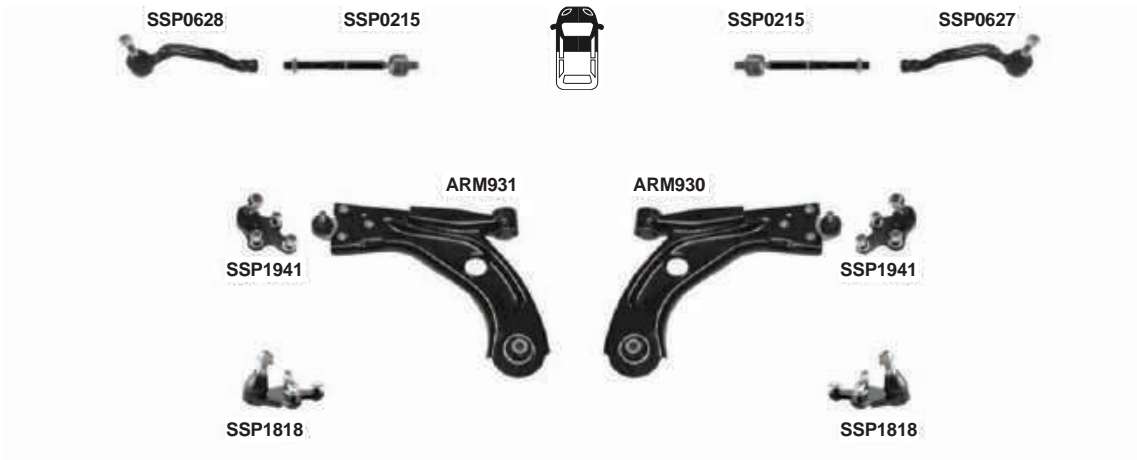

PART NO.	DESCRIPTION	NOTES	O.E.
ARM930	301181393000 Suspension Control Arm and Ball Joint Assembly - Front Left Lower		9678311380
ARM931	301181393100 Suspension Control Arm and Ball Joint Assembly - Front Right Lower		9678311280
ARM932	301181393200 Suspension Control Arm and Ball Joint Assembly - Front Right	Aluminium	9800596580
ARM933	301181393300 Suspension Control Arm and Ball Joint Assembly - Front Left	Aluminium	9800596680
SSP0215	301191602150 Steering Tie Rod - Front	M14X1,5	1611242380
SSP0627	301191606270 Steering Tie Rod End - Front Right	M14X1,5	1610817880
SSP0628	301191606280 Steering Tie Rod End - Front Left	M14X1,5	1610817780
SSP1818	301191618180 Suspension Ball Joint - Front Lower	fit aluminium control arm	9803434080
SSP1941	301191619410 Suspension Ball Joint - Front Lower		9672192480
SSP2510	301191625100 Suspension Stabilizer Bar Link - Front	L=335mm	9804947480; 9809045780



PEUGEOT 309



1985-1993



PART NO.	DESCRIPTION	NOTES	O.E.
SSP0612 301191606120	Steering Tie Rod End - Front	M14x1,5Rht	3817.10; 95493208; 9471000965; 9471003465; 3817.18; 3817.50



PEUGEOT 406



10/1995-10/2004

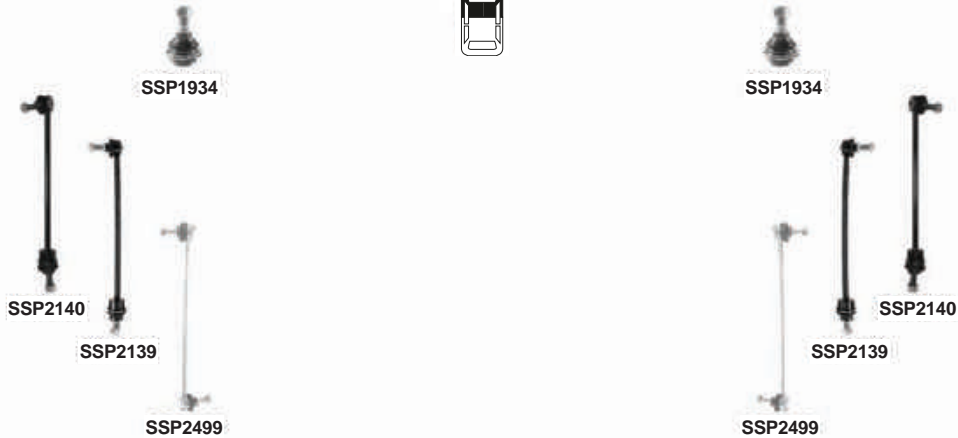

PART NO.	DESCRIPTION	NOTES	O.E.
SSP1934 301191619340	Suspension Ball Joint - Front Lower		3640.28; 95028039; 96233739; 3640.71; 3640.34
SSP2139 301191621390	Suspension Stabilizer Bar Link - Front	L=322,5mm M12 Thread	5087.40; 96177836; 93802209
SSP2140 301191621400	Suspension Stabilizer Bar Link - Front	(Clip-on patented design) L=322,5mm M12 Thread	500310933; 96145457; 5087.40
SSP2499 301191624990	Suspension Stabilizer Bar Link - Front	L=320mm	5087.43; 96177836; 96324274; 5087.60; 5087.48



PEUGEOT 407



05/2004-12/2011

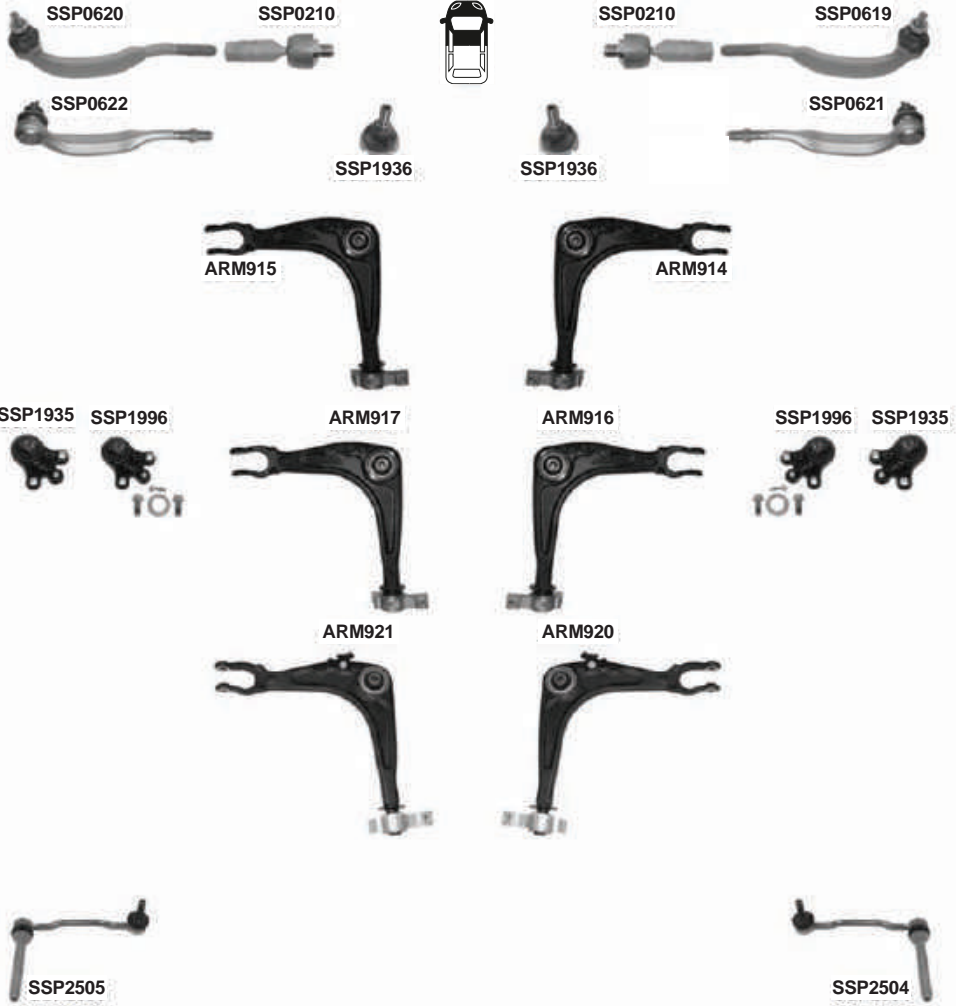



PEUGEOT 407



05/2004-12/2011

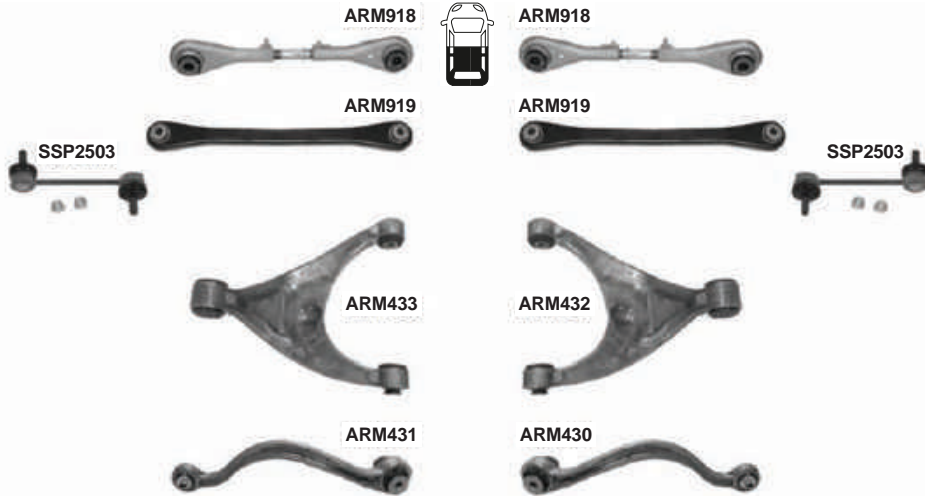

	PART NO.	DESCRIPTION	NOTES	O. E.
ARM430	301181343000	Lateral Arm - Rear Right Lower	Aluminium	5175.CE
ARM431	301181343100	Lateral Arm - Rear Left		5175.CC
ARM432	301181343200	Lateral Arm - Rear Right Upper	Federal	5175CP; 5175CH
ARM433	301181343300	Lateral Arm - Rear Left Upper	Federal	5175CN; 5175CG
ARM914	301181391400	Suspension Control Arm - Front Right Lower		3521.J6; 3521.L2
ARM915	301181391500	Suspension Control Arm - Front Left Lower		3520.N6; 3520.Q1
ARM916	301181391600	Suspension Control Arm - Front Right Lower	Ch: opr.12407->	3521.T8
ARM917	301181391700	Suspension Control Arm - Front Left	Ch: opr.12407->	3520.X7
ARM918	301181391800	Lateral Arm - Rear Forward		5178.47
ARM919	301181391900	Lateral Arm - Rear Upper Rearward		5175.CF
ARM920	301181392000	Suspension Control Arm - Front Right Lower	(With bracket) Variable Suspension	3521.J7
ARM921	301181392100	Suspension Control Arm - Front Left Lower	(With bracket) Variable Suspension	3520.N7
SSP0210	301191602100	Steering Tie Rod - Front	M14x1,5 - L=103mm	3817.B3; 3817.E3
SSP0619	301191606190	Steering Tie Rod End - Front Right Outer	M14x1,5Rht D=Ø10mm	3817.57
SSP0620	301191606200	Steering Tie Rod End - Front Left Outer	M14x1,5Rht D=Ø10mm	3817.58
SSP0621	301191606210	Steering Tie Rod End - Front Right	M14x1,5 D=Ø12mm	3817.66
SSP0622	301191606220	Steering Tie Rod End - Front Left Outer	M14x1,5 D=Ø12mm	3817.65
SSP1935	301191619350	Suspension Ball Joint - Front Lower		3640.58; 3640.72
SSP1936	301191619360	Suspension Ball Joint - Front Upper		3640.57; 3640.74
SSP1996	301191619960	Suspension Ball Joint Kit - Front Lower		3640.58; 3640.72
SSP2503	301191625030	Suspension Stabilizer Bar Link - Rear	L=141 mm	5178.46; 9651565180; 5178.52
SSP2504	301191625040	Suspension Stabilizer Bar Link - Front Right	L=200mm	5087.53
SSP2505	301191625050	Suspension Stabilizer Bar Link - Front Left	L=200mm	5087.52



PEUGEOT 504



1968-1993



PART NO.	DESCRIPTION	NOTES	O.E.
SSP0612 301191606120	Steering Tie Rod End - Front	M14x1,5Rht	3817.10; 95493208; 9471000965; 9471003465; 3817.18; 3817.50



PEUGEOT 505



1968-1993



SSP0612



SSP0612

PART NO.	DESCRIPTION	NOTES	O.E.
SSP0612 301191606120	Steering Tie Rod End - Front	M14x1,5Rht	3817.10; 95493208; 9471000965; 9471003465; 3817.18; 3817.50



PEUGEOT 508



11/2010-

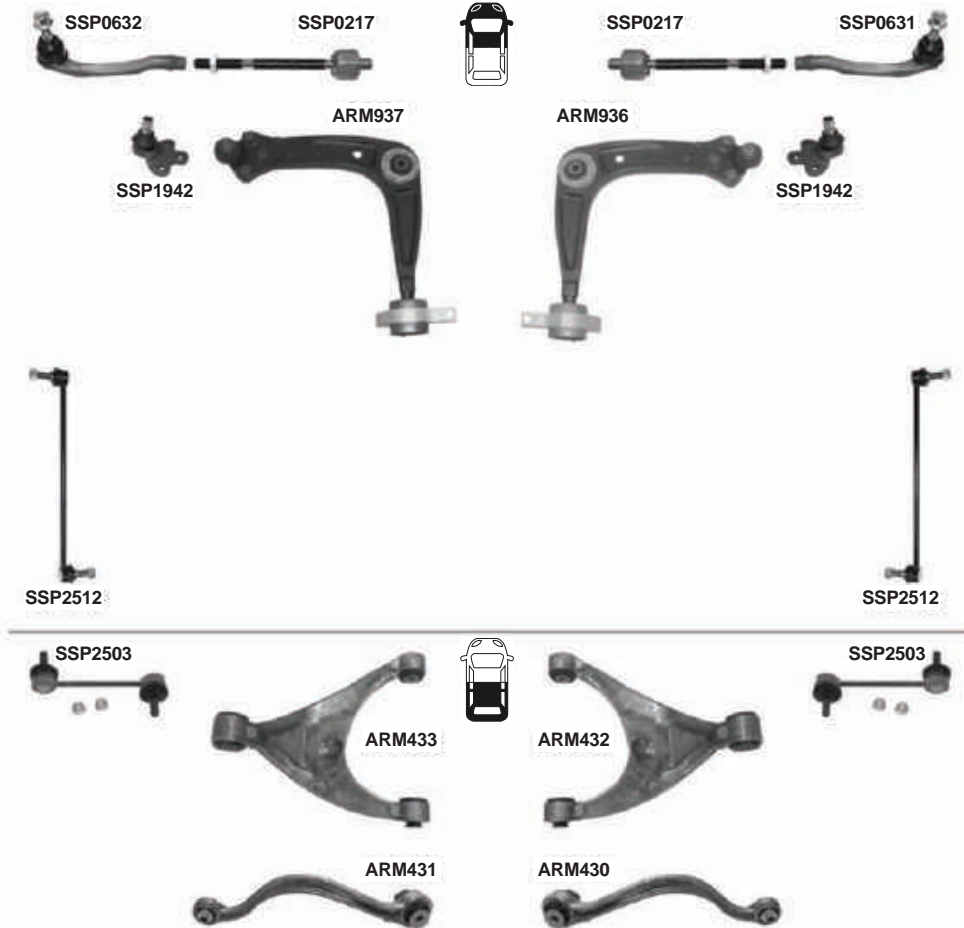

PART NO.	DESCRIPTION	NOTES	O.E.
ARM430	301181343000 Lateral Arm - Rear Right Lower	Aluminium	5175.CE
ARM431	301181343100 Lateral Arm - Rear Left		5175.CC
ARM432	301181343200 Lateral Arm - Rear Right Upper	Federal	5175CP; 5175CH
ARM433	301181343300 Lateral Arm - Rear Left Upper	Federal	5175CN; 5175CG
ARM936	301181393600 Suspension Control Arm and Ball Joint Assembly - Front Right		3521.V1; 3521.Y0
ARM937	301181393700 Suspension Control Arm and Ball Joint Assembly - Front Left		3520.Y0
SSP0217	301191602170 Steering Tie Rod - Front	M14X1,5 - L=209mm	3812.G3
SSP0631	301191606310 Steering Tie Rod End - Front Right	M14X1,5	3817.A2
SSP0632	301191606320 Steering Tie Rod End - Front Left	M14X1,5	3817.A1
SSP1942	301191619420 Suspension Ball Joint - Front		3640.83
SSP2503	301191625030 Suspension Stabilizer Bar Link - Rear	L=141 mm	5178.46; 9651565180; 5178.52
SSP2512	301191625120 Suspension Stabilizer Bar Link - Front	L=345mm	5087.76

**PEUGEOT 605**

1989-1999

**SSP0369****SSP0056****SSP0056****SSP0368****SSP1934****SSP1934****SSP2141****SSP2141****SSP2508****SSP2507**

PART NO.	DESCRIPTION	NOTES	O.E.
SSP0056 301191600560	Steering Tie Rod - Front	M14x1,5Rht - L=295mm	3812.99; 96032460
SSP0368 301191603680	Steering Tie Rod End - Front Right	M14x1,5Rht	3817.16; 9471007565; 9471000665; 3817.42; 3817.31
SSP0369 301191603690	Steering Tie Rod End - Front Left	M14x1,5Rht	3817.14; 9471000565; 9471007465; 9458084180; 3817.41; 3817.30
SSP1934 301191619340	Suspension Ball Joint - Front Lower		3640.28; 95028039; 96233739; 3640.71; 3640.34
SSP2141 301191621410	Suspension Stabilizer Bar Link - Front	L=346mm	5087.30; 96080894; 5087.41
SSP2507 301191625070	Suspension Stabilizer Bar Link - Rear Right	L=86mm	5178.18; 5178.44; 5178.31; 5178.22
SSP2508 301191625080	Suspension Stabilizer Bar Link - Rear Left	L=86mm	5178.17; 5178.43; 5178.30; 5178.21



PEUGEOT 607



01/2000-11/2010



PART NO.	DESCRIPTION	NOTES	O.E.
SSP0216 301191602160	Steering Tie Rod - Front	M16x1,5Rht - L=295mm	3812.C7
SSP0629 301191606290	Steering Tie Rod End - Front Right	M16x1,5Rht	3817.38; 3817.44
SSP0630 301191606300	Steering Tie Rod End - Front Left	M16x1,5Rht	3817.37; 3817.43
SSP1934 301191619340	Suspension Ball Joint - Front Lower		3640.28; 95028039; 96233739; 3640.71; 3640.34
SSP2499 301191624990	Suspension Stabilizer Bar Link - Front	L=320mm	5087.43; 96177836; 96324274; 5087.60; 5087.48
SSP2507 301191625070	Suspension Stabilizer Bar Link - Rear Right	L=86mm	5178.18; 5178.44; 5178.31; 5178.22
SSP2508 301191625080	Suspension Stabilizer Bar Link - Rear Left	L=86mm	5178.17; 5178.43; 5178.30; 5178.21



PEUGEOT 806



06/1994-08/2002

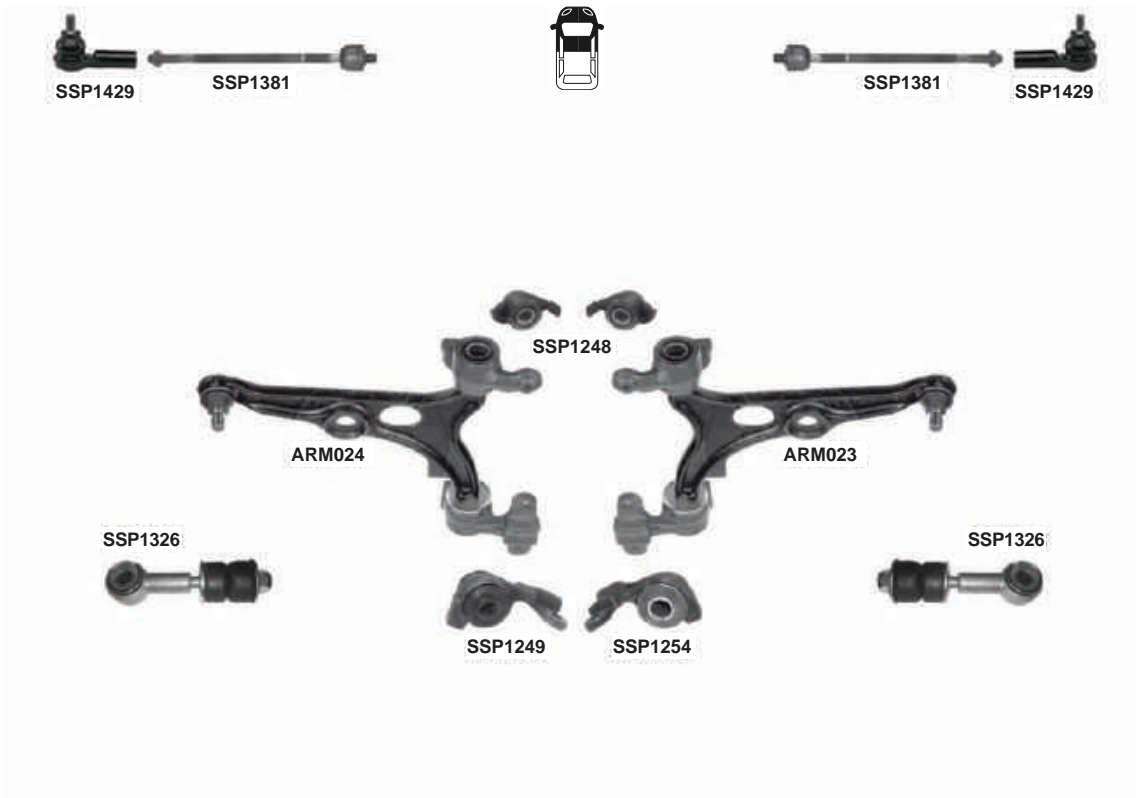

	PART NO.	DESCRIPTION	NOTES	O.E.
ARM023	301181302300	Suspension Control Arm and Ball Joint Assembly - Front Right Lower		1313084080; 3521.K4; 3521.83; 3521.C9; 1322664080; 1317390080; 1316736080
ARM024	301181302400	Suspension Control Arm and Ball Joint Assembly - Front Left		1313083080; 3520.G9; 3520.94; 3520.C3; 1322663080; 1317389080; 1316735080
SSP1248	301181312480	Bush / Silent block - Track control arm	ARM023 / ARM024 / ARM035 / ARM036	1312317080
SSP1249	301181312490	Bush / Silent block - Track control arm - Lh	ARM024	1305551080
SSP1254	301181312540	Bush / Silent block - Track control arm - Rh	ARM023	1305552080
SSP1326	301181313260	Suspension Stabilizer Bar Link - Front	L=122mm	1308664080; 5087.35; 1317425080
SSP1381	301181313810	Steering Tie Rod - Front Inner	M14x1,5 - L=309mm	3812.A4; 9566950880
SSP1429	301181314290	Steering Tie Rod End - Front Outer	M14x1,5Rht - D=Ø14,4mm	1306003080; 9404059580; 4059.09



PEUGEOT 807



06/2002-08/2014

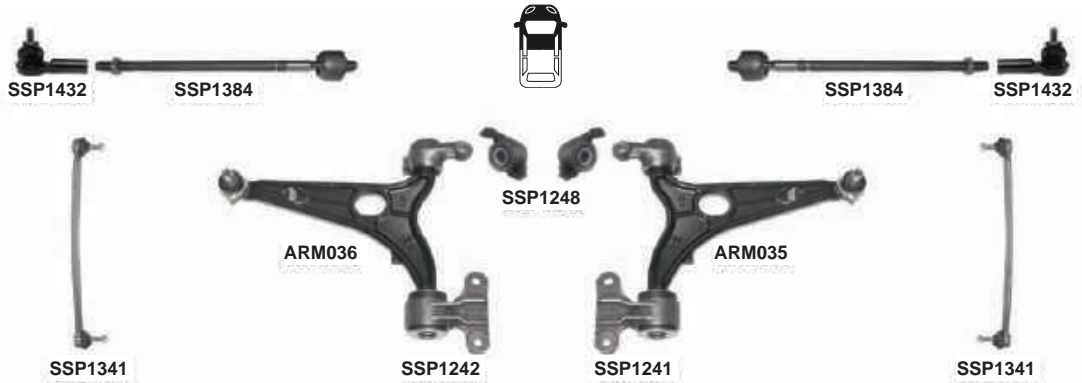

PART NO.	DESCRIPTION	NOTES	O.E.
ARM035 301181303500	Suspension Control Arm and Ball Joint Assembly - Front Right Lower		1346385080; 93501488; 3521.H1
ARM036 301181303600	Suspension Control Arm and Ball Joint Assembly - Front Left		1346384080; 93501487; 3521.H0
SSP1241 301181312410	Bush / Silent block - Track control arm - Rh	ARM035 / ARM073	3521.H0, 3521.H1
SSP1242 301181312420	Bush / Silent block - Track control arm - Lh	ARM036 / ARM074	3521.H0, 3521.H1
SSP1248 301181312480	Bush / Silent block - Track control arm	ARM023 / ARM024 / ARM035 / ARM036	1312317080
SSP1341 301181313410	Suspension Stabilizer Bar Link - Front	L=262,5mm	1331209080; 5087.51
SSP1384 301181313840	Steering Tie Rod - Front	M14x1,5 - L=308mm	3812.E2; 77362280
SSP1432 301181314320	Steering Tie Rod End - Front Outer	M14x1,5Rht - D=Ø15,45mm	4059.12; 77362279

**PEUGEOT 1007 (KM)**

04/2005-2010

SSP0614



SSP0616



SSP0613



SSP0615



SSP1971

ARM903



ARM902



SSP1971



SSP2495

SSP2496



SSP2495

SSP2496

PART NO.	DESCRIPTION	NOTES	O.E.
ARM902	301181390200 Suspension Control Arm and Ball Joint Assembly - Front Right Lower		3521.L3; 480680H010; 3521.N7
ARM903	301181390300 Suspension Control Arm and Ball Joint Assembly - Front Left Lower		3520.Q2; 480690H010; 3520.R6
SSP0613	301191606130 Steering Tie Rod End - Front Right Outer	M12x1,25	3817.64
SSP0614	301191606140 Steering Tie Rod End - Front Left Outer	M12x1,25	3817.63
SSP0615	301191606150 Steering Tie Rod End - Front Right	(Only 1.6 16v GTI/HDI)	3817.61
SSP0616	301191606160 Steering Tie Rod End - Front Left	(Only 1.6 16v GTI/HDI)	3817.62
SSP1971	301191619710 Suspension Ball Joint - Front Lower		4330859035; 4330859095
SSP2495	301191624950 Suspension Stabilizer Bar Link - Front	L=335mm	5087.45; 96288787
SSP2496	301191624960 Suspension Stabilizer Bar Link - Front	(Clip-on patented design) L=335mm	5087.45; 96288787



PART NO.	DESCRIPTION	NOTES	O.E.
ARM422 301181342200	Suspension Control Arm and Ball Joint Assembly - Front Right Lower		3521.S9
ARM423 301181342300	Suspension Control Arm and Ball Joint Assembly - Front Left Lower		3520.W7
SSP0211 301191602110	Steering Tie Rod - Front	M14x1.5 - L=225mm	1608025380
SSP0623 301191606230	Steering Tie Rod End - Front Right		1608025280
SSP0624 301191606240	Steering Tie Rod End - Front Left	M14x1.5 - L=200mm	1608025180
SSP1820 301191618200	Suspension Ball Joint - Front Lower		3640.77
SSP2144 301191621440	Suspension Stabilizer Bar Link - Front	Alm.Desing	5087.71; 5087.74



PEUGEOT 3008



09/2009-2016



PART NO.	DESCRIPTION	NOTES	O.E.
ARM928	Suspension Control Arm - Front Right Lower		3521.R3
ARM929	Suspension Control Arm - Front Left		3520.V2
SSP0214	Steering Tie Rod - Front	M14x1,5 - L=272mm	3812.F2
SSP0625	Steering Tie Rod End - Front Right	M14x1,5	3817.75; 3817.88
SSP0626	Steering Tie Rod End - Front Left	M14x1,5	3817.76; 3817.89
SSP1940	Suspension Ball Joint - Front		3640.73
SSP2509	Suspension Stabilizer Bar Link - Front	L=335mm	5087.50; 96347856; 9804947480; 5087.64; 5087.62
SSP2511	Suspension Stabilizer Bar Link - Front	(Clip-on patented design) L=335mm	5087.50*



PEUGEOT 3008 II



2016-



	PART NO.	DESCRIPTION	NOTES	O.E.
ARM934	301181393400	Suspension Control Arm and Ball Joint Assembly - Front Right Lower		9816865480
ARM935	301181393500	Suspension Control Arm and Ball Joint Assembly - Front Left Lower		9816865580
SSP0053	301191600530	Steering Tie Rod - Front		1610817680
SSP0627	301191606270	Steering Tie Rod End - Front Right	M14X1,5	1610817880
SSP0628	301191606280	Steering Tie Rod End - Front Left	M14X1,5	1610817780
SSP1818	301191618180	Suspension Ball Joint - Front Lower		9803434080
SSP2509	301191625090	Suspension Stabilizer Bar Link - Front	L=335mm	5087.50; 96347856; 9804947480; 5087.64; 5087.62

**PEUGEOT 4007**

02/2007-



PART NO.	DESCRIPTION	NOTES	O.E.
ARM821	301181382100 Suspension Control Arm and Ball Joint Assembly - Front Right Lower		4013A010; 4013A282; 4013A428
ARM822	301181382200 Suspension Control Arm and Ball Joint Assembly - Front Left Lower		4013A009; 4013A281; 4013A427
SSP0160	301191601600 Steering Tie Rod - Front	M14x1,5 - L=322mm	3812.F1; 4422A012; 4422A057
SSP0553	301191605530 Steering Tie Rod End - Front	M14X1,5	4422A002; 4422A052; 1607502480
SSP1903	301191619030 Suspension Ball Joint - Front Lower		Part of 352V0/3521R1/4013A009/4013A0010
SSP2420	301191624200 Suspension Stabilizer Bar Link - Front	L=265mm	5087.58; MN101368
SSP2421	301191624210 Suspension Stabilizer Bar Link - Rear Right	L=80mm	5178.49; MN184194
SSP2422	301191624220 Suspension Stabilizer Bar Link - Rear Left	L=80mm	4156A014; 5178.48



PEUGEOT 5008



09/2009-



PART NO.	DESCRIPTION	NOTES	O.E.
ARM418 301181341800	Suspension Control Arm - Front Right Lower		9805607380
ARM419 301181341900	Suspension Control Arm - Front Left Lower		9805607380
ARM928 301181392800	Suspension Control Arm - Front Right Lower		3521.R3
ARM929 301181392900	Suspension Control Arm - Front Left		3520.V2
SSP0214 301191602140	Steering Tie Rod - Front	M14x1,5 - L=272mm	3812.F2
SSP0625 301191606250	Steering Tie Rod End - Front Right	M14x1,5	3817.75; 3817.88
SSP0626 301191606260	Steering Tie Rod End - Front Left	M14x1,5	3817.76; 3817.89
SSP1940 301191619400	Suspension Ball Joint - Front		3640.73
SSP2509 301191625090	Suspension Stabilizer Bar Link - Front	L=335mm	5087.50; 96347856; 9804947480; 5087.64; 5087.62
SSP2511 301191625110	Suspension Stabilizer Bar Link - Front	(Clip-on patented design) L=335mm	5087.50*



PEUGEOT BIPPER



02/2008-

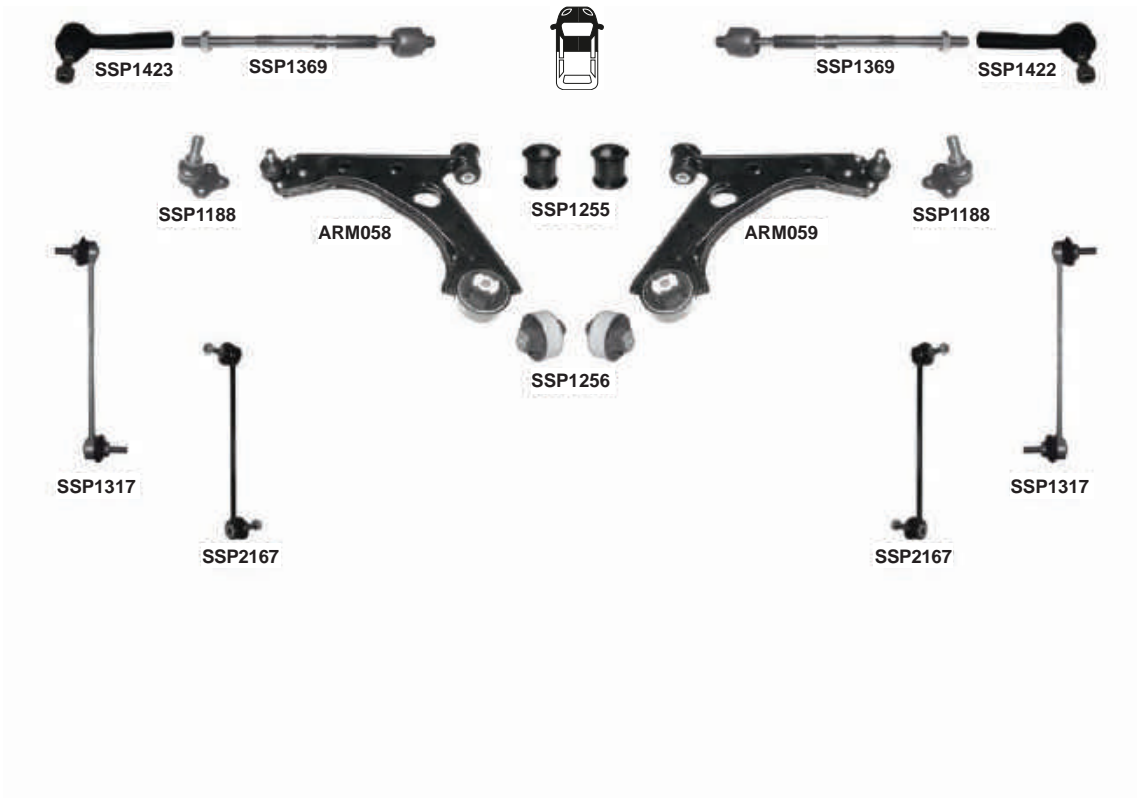

	PART NO.	DESCRIPTION	NOTES	O.E.
ARM058	301181305800	Suspension Control Arm and Ball Joint Assembly - Front Left Lower		3520.W3; 55703629; 51895367; 51783057; 3520.Y4
ARM059	301181305900	Suspension Control Arm and Ball Joint Assembly - Front Right Lower		3521.S6; 55703627; 51895366; 51783056; 3521.V5
SSP1188	301181311880	Suspension Ball Joint - Front		3520.87; 93190907; 51783057; 51783056; 3520.W3
SSP1255	301181312550	Bush / Silent block - Track control arm	ARM058 / ARM059 / ARM115 / ARM116	0352380, 55703232
SSP1256	301181312560	Bush / Silent block - Track control arm - Rear	ARM058 / ARM059	55700751
SSP1317	301181313170	Suspension Stabilizer Bar Link - Front	L=290mm	5080.70; 51815479; 5087.65
SSP1369	301181313690	Steering Tie Rod - Front	M14X1,5 - L=274mm	55172401
SSP1422	301181314220	Steering Tie Rod End - Front Right	M14x1,5	3817.87; 77364569
SSP1423	301181314230	Steering Tie Rod End - Front Left	M14x1,5	3817.86; 77364568
SSP2167	301191621670	Suspension Stabilizer Bar Link - Front	(Clip-on patented design) L=290mm	5087.65; 51815479; 5087.70

PEUGEOT BOXER (1.4Q-1.8Q)



04/1994-04/2002



PART NO.	DESCRIPTION	NOTES	O.E.
ARM025	301181302500 Suspension Control Arm - Front Right Lower	Only:1,4Q	1308601080; 3521.65; 1317241080
ARM026	301181302600 Suspension Control Arm - Front Left Lower	Only:1,4Q	1308600080; 3520.95; 1317240080
ARM027	301181302700 Suspension Control Arm - Front Right Lower	Only:1,8Q	1308760080; 3521.66; 1317239080
ARM028	301181302800 Suspension Control Arm - Front Left Lower	Only:1,8Q	1308759080; 3520.96; 1317238080
SSP1196	301181311960 Suspension Ball Joint - Front Lower	Only : 1.4Q	1302368080; 3640.32
SSP1197	301181311970 Suspension Ball Joint - Front Lower	Only : 1,8Q	1300473080; 542410095; 3640.33
SSP1257	301181312570 Bush / Silent block - Track control arm	ARM025 / ARM026 / ARM027 / ARM028	1300507080
SSP1258	301181312580 Bush / Silent block - Track control arm	ARM025 / ARM026 / ARM027 / ARM028	"1308694080, 1338373080, 3523.94"
SSP1327	301181313270 Suspension Stabilizer Bar Link - Front	L=134mm	1300716080; 5087.37
SSP1382	301181313820 Axial joint	M16x1,5Rht - L=318mm - Manual Steering	1471654080, 4018.A4, 9945385, 9945836
SSP1383	301181313830 Steering Tie Rod - Front	Power Steering M16x1,5Rht - L=318mm	4006.24; 9945836
SSP1431	301181314310 Steering Tie Rod End - Front	M16x1,5Rht	1306716080; 4018.A3; 1471655080



PEUGEOT BOXER (1.4Q-1.8Q)



05/2002-05/2005

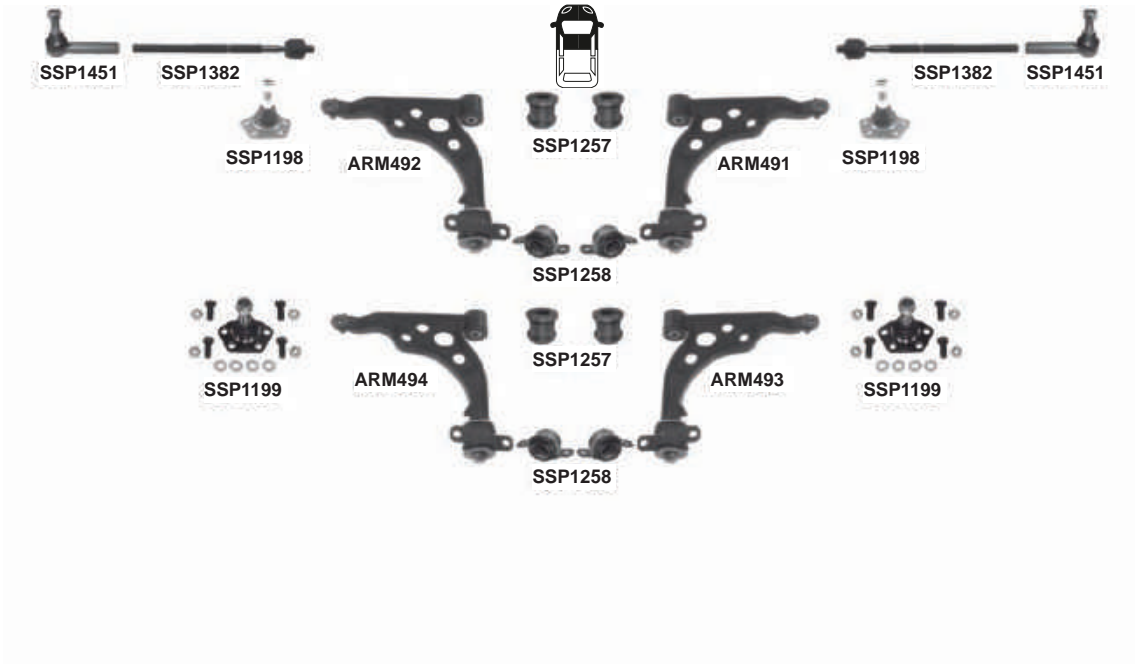

PART NO.	DESCRIPTION	NOTES	O.E.
ARM491	301181349100 Suspension Control Arm - Front Right Lower	Only:1,4Q	1331940080; 3521.J3; 3521.H2
ARM492	301181349200 Suspension Control Arm - Front Left Lower	Only:1,4Q	1331938080; 3520.N3; 3520.L0
ARM493	301181349300 Suspension Control Arm - Front Right Lower	Only:1,8Q	1339460080; 3521.J4; 3521.H3
ARM494	301181349400 Suspension Control Arm - Front Left Lower	Only:1,8Q	1331937080; 3520.N4; 3520.L1
SSP1198	301181311980 Suspension Ball Joint - Front Lower	Only : 1.4Q	1302368080; 3640.55; 1331640080
SSP1199	301181311990 Suspension Ball Joint - Front Lower	Only : 1,8Q	1300473080; 3640.54; 1331641080
SSP1257	301181312570 Bush / Silent block - Track control arm	ARM025 / ARM026 / ARM027 / ARM028	1300507080
SSP1258	301181312580 Bush / Silent block - Track control arm	ARM025 / ARM026 / ARM027 / ARM028	"1308694080, 1338373080, 3523.94"
SSP1382	301181313820 Steering Tie Rod - Front	Manual Steering M16x1,5Rht - L=318mm	1471654080; 9945836; 9945385; 4018.A4
SSP1451	301181314510 Steering Tie Rod End - Front	M16x1,5Rht	4018.E0; 77362278

PEUGEOT BOXER (1.1Q-1.5Q-1.7Q,H-2.0Q) 06/2006-

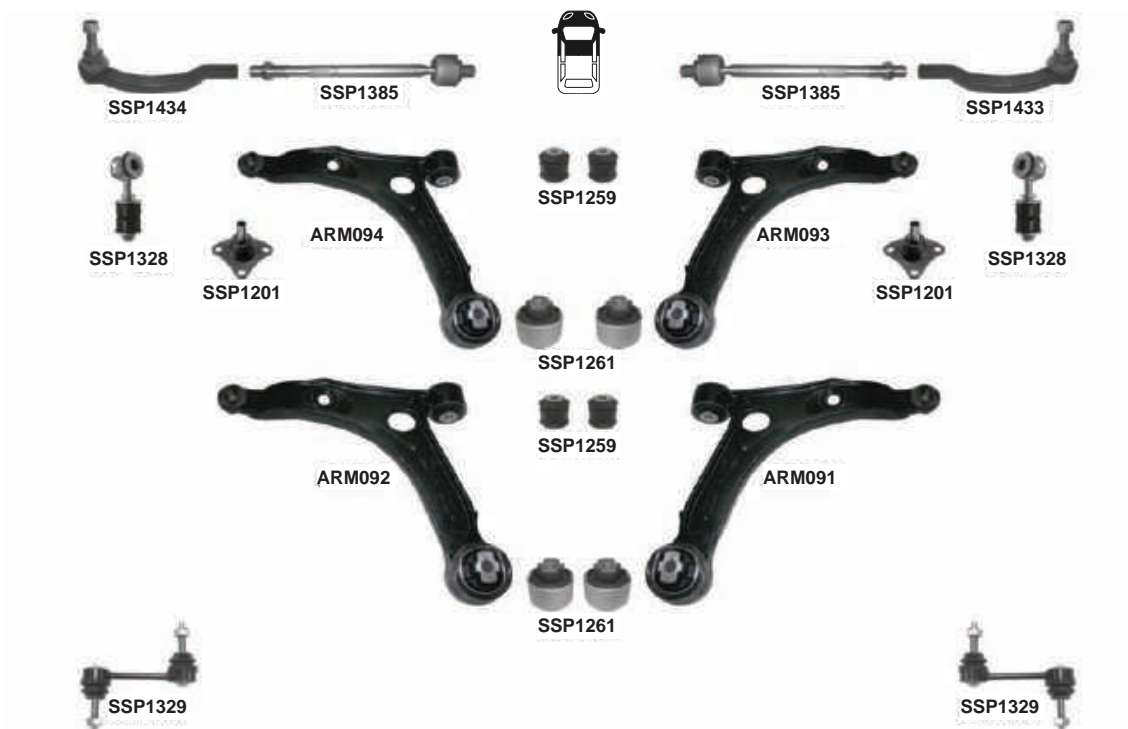

PART NO.	DESCRIPTION	NOTES	O.E.
ARM091 301181309100	Suspension Control Arm - Front Right Lower	Only :1.1Q-1.5Q-1.7Q	1352225080; 3521.P1
ARM092 301181309200	Suspension Control Arm - Front Left	Only :1.1Q-1.5Q-1.7Q	1352227080; 3520.S0
ARM093 301181309300	Suspension Control Arm - Front Right Lower	Only :1.7H - 2.0Q	1352226080; 3521.P2
ARM094 301181309400	Suspension Control Arm - Front Left	Only :1.7H - 2.0Q	1352228080; 3520.S1
SSP1201 301181312010	Suspension Ball Joint - Front Lower		3640.67; 9351837; 50705629; 3640.76
SSP1259 301181312590	Bush / Silent block - Track control arm	ARM091 /ARM092 /ARM093 /ARM094	3520.S1, 3521.P2
SSP1261 301181312610	Bush / Silent block - Track control arm	ARM091 /ARM092 /ARM093 /ARM094	3520.S1, 3521.P2
SSP1328 301181313280	Suspension Stabilizer Bar Link - Front	L=112mm	1357572080*
SSP1329 301181313290	Suspension Stabilizer Bar Link - Rear	L=100mm	1355440080; 5170.F5; 1355449080
SSP1385 301181313850	Steering Tie Rod - Front	M16x1,5 - L=260 mm	1341 021 080; 4001.E4; 4001.E5; 16 077 445 80; 1359 226 080; 1345 854 080
SSP1433 301181314330	Steering Tie Rod End - Front Right	M16x1,5	3817.70; 77364009
SSP1434 301181314340	Steering Tie Rod End - Front Left	M16x1,5	3817.77; 77364253



PEUGEOT EXPERT 224



07/1995-12/2006

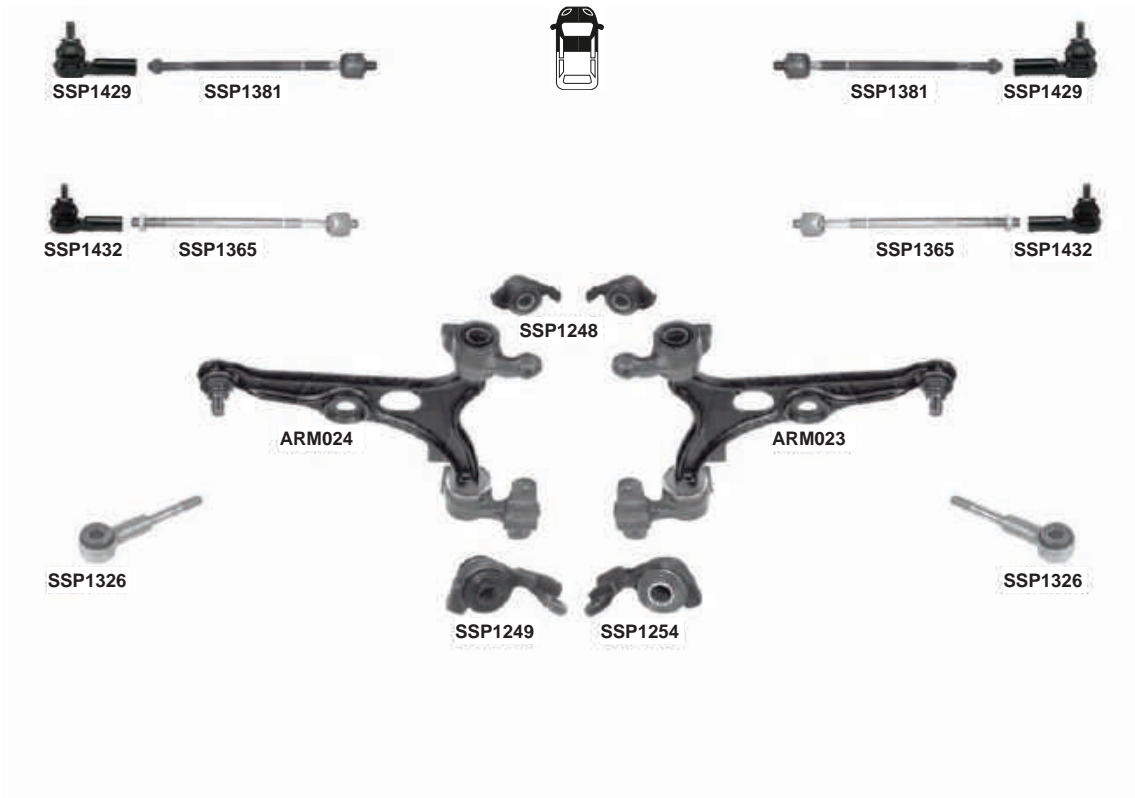

PART NO.	DESCRIPTION	NOTES	O.E.
ARM023	301181302300 Suspension Control Arm and Ball Joint Assembly - Front Right Lower		1313084080; 3521.K4; 3521.83; 3521.C9; 1322664080; 1317390080; 1316736080
ARM024	301181302400 Suspension Control Arm and Ball Joint Assembly - Front Left		1313083080; 3520.G9; 3520.94; 3520.C3; 1322663080; 1317389080; 1316735080
ARM406	301181340600 Suspension Control Arm and Ball Joint Assembly - Front Right	REINFORCED TYPE BASED ON OE PART REVISION IN 2014, 27Ø	3521P4
ARM407	301181340700 Suspension Control Arm and Ball Joint Assembly - Front Right	REINFORCED TYPE BASED ON OE PART REVISION IN 2014, 27Ø	3520P4
SSP1248	301181312480 Bush / Silent block - Track control arm	ARM023 / ARM024 / ARM035 / ARM036	1312317080
SSP1249	301181312490 Bush / Silent block - Track control arm - Lh	ARM024	1305551080
SSP1254	301181312540 Bush / Silent block - Track control arm - Rh	ARM023	1305552080
SSP1326	301181313260 Suspension Stabilizer Bar Link - Front	L=122mm	1308664080; 5087.35; 1317425080
SSP1365	301181313650 Steering Tie Rod - Front Inner	M14x1,5Rht - L=309.3mm	9947713
SSP1381	301181313810 Steering Tie Rod - Front Inner	M14x1,5 - L=309mm	3812.A4; 9566950880
SSP1429	301181314290 Steering Tie Rod End - Front Outer	M14x1,5Rht - D=Ø14,4mm	1306003080; 9404059580; 4059.09
SSP1432	301181314320 Steering Tie Rod End - Front Outer	M14x1,5Rht - D=Ø15,45mm	4059.12; 77362279



PEUGEOT EXPERT



01/2007-

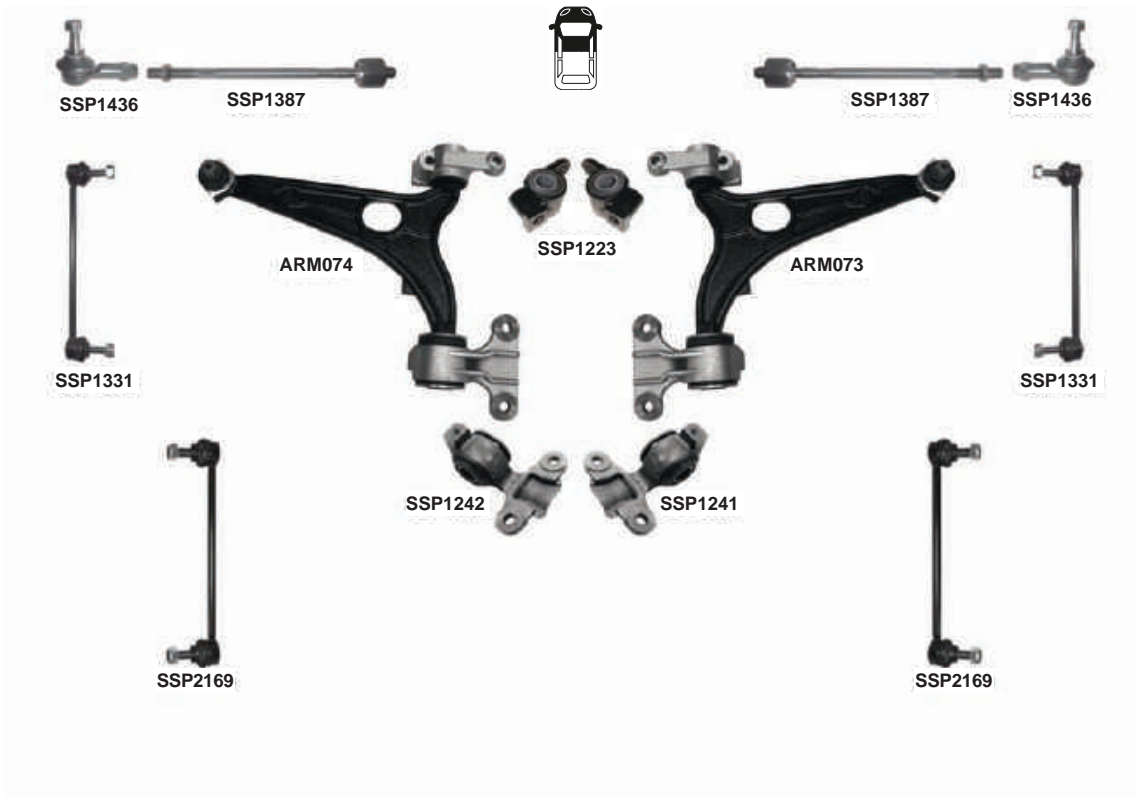

PART NO.	DESCRIPTION	NOTES	O.E.
ARM073 301181307300	Suspension Control Arm and Ball Joint Assembly - Front Right		1497407080; 50711395; 3521.N9
ARM074 301181307400	Suspension Control Arm and Ball Joint Assembly - Front Left		1497408080; 50711394; 3520.R8
ARM495 301181349500	Suspension Control Arm and Ball Joint Assembly - Front Right		1497407080*
ARM496 301181349600	Suspension Control Arm and Ball Joint Assembly - Front Left		1497408080*
SSP1223 301181312230	Bush / Silent block - Track control arm	ARM073 / ARM074	
SSP1241 301181312410	Bush / Silent block - Track control arm - Rh	ARM035 / ARM073	3521.H0, 3521.H1
SSP1242 301181312420	Bush / Silent block - Track control arm - Lh	ARM036 / ARM074	3521.H0, 3521.H1
SSP1331 301181313310	Suspension Stabilizer Bar Link - Front	L=263mm	1400099680; 5087.56
SSP1387 301181313870	Steering Tie Rod - Front	M14x1,5 - L=304.7mm	1401381380; 3812.F0; 1497550080
SSP1436 301181314360	Steering Tie Rod End - Front	M14x1,5	3817.73; 9403817738
SSP2169 301191621690	Suspension Stabilizer Bar Link - Front	(Clip-on patented design) L=263mm	1400099680*



MAGNETI
MARELLI

PEUGEOT PARTNER I



05/1996-

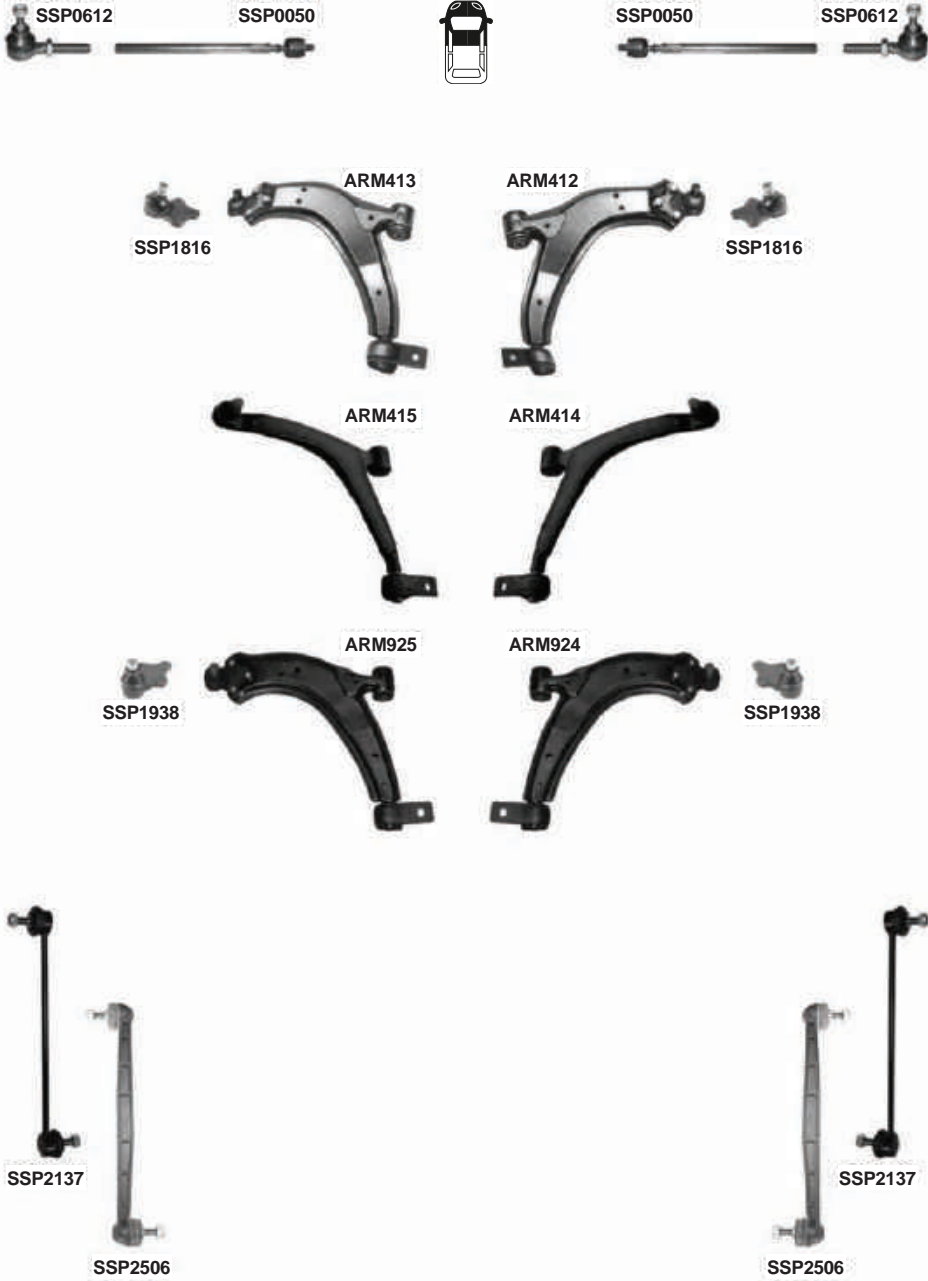



PEUGEOT PARTNER I



05/1996-

PART NO.	DESCRIPTION	NOTES	O.E.	
ARM412	301181341200	Suspension Control Arm and Ball Joint Assembly - Front Right Lower	Ch.->7972 Ball Joint Power D=Ø16mm	3521.C4; 95668511; 95658883
ARM413	301181341300	Suspension Control Arm and Ball Joint Assembly - Front Left Lower	Ch.->7972 Ball Joint Power D=Ø16mm	3520.A2; 95658882; 3520.F5
ARM414	301181341400	Suspension Control Arm and Ball Joint Assembly - Front Right Lower	Only : Combi Van Pr-8365->	3521.F3; 3521.R4; 3521.L4
ARM415	301181341500	Suspension Control Arm and Ball Joint Assembly - Front Left	Only : Combi Van Pr-8365->	3520.Q4; 3520.Q3; 3520.J3
ARM924	301181392400	Suspension Control Arm and Ball Joint Assembly - Front Right Lower	Power steering Ch.No:7973-> Ball Joint D=Ø18mm	3521.69; 3521.E5
ARM925	301181392500	Suspension Control Arm and Ball Joint Assembly - Front Left Lower	Power steering Ch.No:7973-> Ball Joint D=Ø18mm	3520.H3; 3520.H5
SSP0050	301191600500	Steering Tie Rod - Front	M14x1,5Rht - L=335.5mm	3812.C0; 96048214; 3812.E4
SSP0612	301191606120	Steering Tie Rod End - Front	M14x1,5Rht	3817.10; 95493208; 9471000965; 9471003465; 3817.18; 3817.50
SSP1816	301191618160	Suspension Ball Joint - Front Lower	Ch.No.-> 7972 Power Steering D=Ø16mm	3640.39; 96025445; 3640.43
SSP1938	301191619380	Suspension Ball Joint - Front	Ch.No:7973-> Power Steering D=Ø18mm	3640.50; 96087507; 3640.51
SSP2137	301191621370	Suspension Stabilizer Bar Link - Front	Metal L=300mm	5087.34; 5087.61; 5087.46; 5087.39
SSP2506	301191625060	Suspension Stabilizer Bar Link - Front	Plastic Type L=300mm	5087.42; 96152213

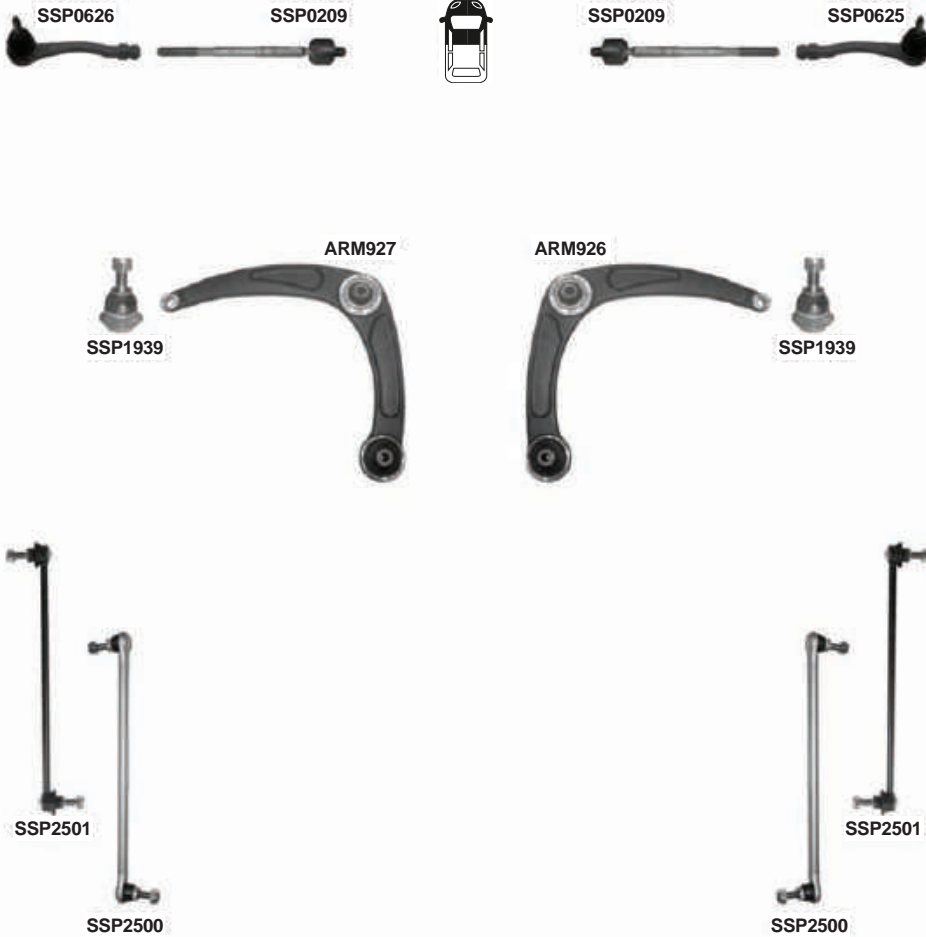
**PEUGEOT PARTNER II, Tepee****04/2008-**

	PART NO.	DESCRIPTION	NOTES	O.E.
ARM926	301181392600	Suspension Control Arm - Front Right Lower		3521.G8; 3521.P3; 3521.K3
ARM927	301181392700	Suspension Control Arm - Front Left		3520.K8; 3520.S2; 3520.P3
SSP0209	301191602090	Steering Tie Rod - Front	M14x1,5 - L=254.7mm	3812.F4
SSP0625	301191606250	Steering Tie Rod End - Front Right	M14x1,5	3817.75; 3817.88
SSP0626	301191606260	Steering Tie Rod End - Front Left	M14x1,5	3817.76; 3817.89
SSP1939	301191619390	Suspension Ball Joint - Front Lower		3640.53; 3640.68; 3640.60
SSP2500	301191625000	Suspension Stabilizer Bar Link - Front	Alm.Design L=334mm	5087.57
SSP2501	301191625010	Suspension Stabilizer Bar Link - Front	Metal Design L=334mm	5087.57



PLYMOUTH BREEZE 1st Gen



1996-2000



PART NO.	DESCRIPTION	NOTES	O.E.
SSP0383 301191603830	Steering Tie Rod End - Front Right Outer		5094006AA
SSP0384 301191603840	Steering Tie Rod End - Front Left Outer		5093857AA



MAGNETI
MARELLI

PLYMOUTH COLT V, VI, VII



1984-1994



SSP0551



SSP0551

PART NO.	DESCRIPTION	NOTES	O.E.
SSP0551 301191605510	Steering Tie Rod End - Front		5682036000; MB912519; MB192430; MB616286



PLYMOUTH GRAND VOYAGER 3rd Gen 1995-2001



PART NO.	DESCRIPTION	NOTES	O.E.
ARM139 301181313900	Suspension Control Arm and Ball Joint Assembly - Front Right		4694760
ARM140 301181314000	Suspension Control Arm and Ball Joint Assembly - Front Left		4694761
SSP1184 301181311840	Suspension Ball Joint - Front Lower	D=Ø19.9mm	4443405; 4449553
SSP1301 301181313010	Suspension Stabilizer Bar Link - Front	L=310mm	4743021AA; K04694855; 4743669AB; 4743669AC; 4743454AC; 4743454AB; 4743454AA
SSP1302 301181313020	Suspension Stabilizer Bar Link - Rear	L=119mm	5272190
SSP1405 301181314050	Steering Tie Rod End - Front	M14x1,5	4797706; K04797706



PLYMOUTH VOYAGER 3rd Gen



1995-2001



PART NO.	DESCRIPTION	NOTES	O.E.
ARM139 301181313900	Suspension Control Arm and Ball Joint Assembly - Front Right		4694760
ARM140 301181314000	Suspension Control Arm and Ball Joint Assembly - Front Left		4694761
SSP1184 301181311840	Suspension Ball Joint - Front Lower	D=Ø19,9mm	4443405; 4449553
SSP1301 301181313010	Suspension Stabilizer Bar Link - Front	L=310mm	4743021AA; K04694855; 4743669AB; 4743669AC; 4743454AC; 4743454AB; 4743454AA
SSP1302 301181313020	Suspension Stabilizer Bar Link - Rear	L=119mm	5272190
SSP1405 301181314050	Steering Tie Rod End - Front	M14x1,5	4797706; K04797706



PONTIAC G3



2007-2009

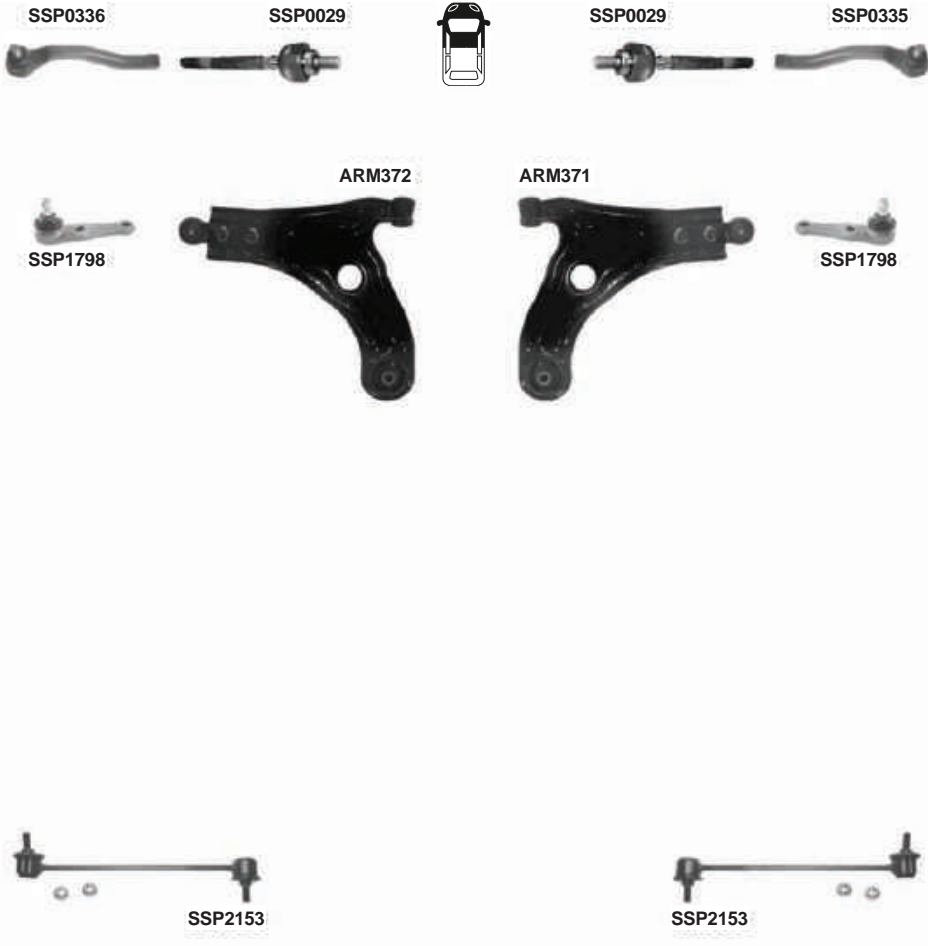

PART NO.	DESCRIPTION	NOTES	O.E.
ARM371 301181337100	Suspension Control Arm and Ball Joint Assembly - Front Right Lower		96535082; 96870466
ARM372 301181337200	Suspension Control Arm and Ball Joint Assembly - Front Left Lower		96535081; 96870465
SSP0029 301191600290	Steering Tie Rod - Front	M12x1,5Rht -L=201mm	96535300
SSP0335 301191603350	Steering Tie Rod End - Front Right	M12x1,5Rht	93740723
SSP0336 301191603360	Steering Tie Rod End - Front Left	M12x1,5Rht	93740722
SSP1798 301191617980	Suspension Ball Joint - Front Lower		96535089
SSP2153 301191621530	Suspension Stabilizer Bar Link - Front	L=262mm	96391875



PONTIAC G6



2005-2010



SSP2485



SSP2485

	PART NO.	DESCRIPTION	NOTES	O.E.
ARM387	301181338700	Suspension Control Arm and Ball Joint Assembly - Front Left Lower		22730775; 15292911
ARM386	301181338600	Suspension Control Arm and Ball Joint Assembly - Front Right Lower		22730776; 15292910
SSP2485	301191624850	Suspension Stabilizer Bar Link - Rear		25816039; 444275



PONTIAC SUNFIRE 1st Gen



1995-2005



PART NO.	DESCRIPTION	NOTES	O.E.
SSP2131 301191621310	Suspension Stabilizer Bar Link - Front		22710259



PONTIAC TORRENT



2006-2009

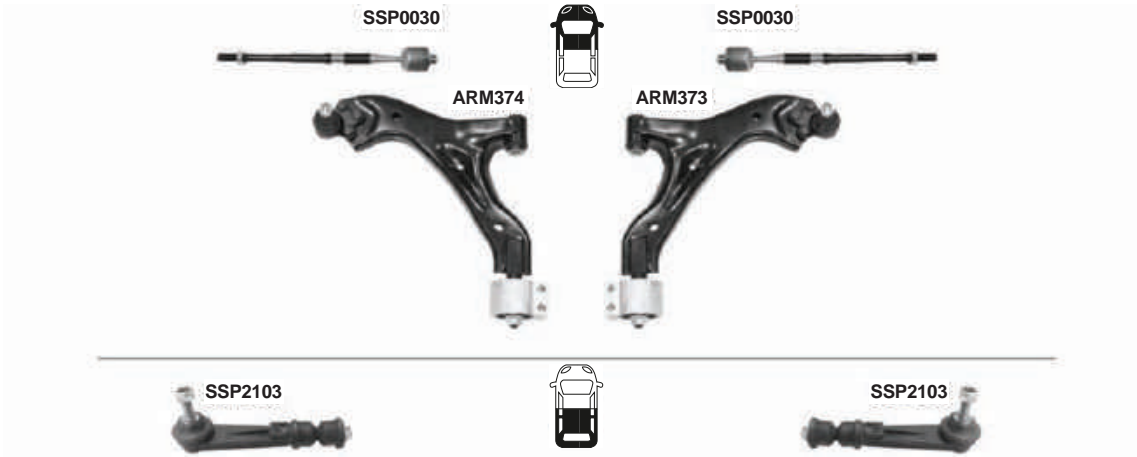

PART NO.	DESCRIPTION	NOTES	O.E.
ARM373 301181337300	Suspension Control Arm and Ball Joint Assembly - Front Right		25878028
ARM374 301181337400	Suspension Control Arm and Ball Joint Assembly - Front Left		25878029
SSP0030 301191600300	Steering Tie Rod - Front	POWER/ELECTRIC	19149839
SSP2103 301191621030	Suspension Stabilizer Bar Link - Rear		15146379



PONTIAC VIBE



2003-2010



SSP2559



SSP2559

PART NO.	DESCRIPTION	NOTES	O.E.
SSP2559 301191625590	Suspension Stabilizer Bar Link - Front		4882032010



PORSCHE CAYENNE 955



09/2002-08/2010



PART NO.	DESCRIPTION	NOTES	O.E.
ARM239	301181323900 Lateral Arm - Rear Lower		7L8501529A
ARM1033	301181310330 Suspension Control Arm and Ball Joint Assembly - Front Upper	Alum.	7L0407021A; 95534102702; 95534102701; 7L0407021B
ARM1035	301181310350 Suspension Control Arm and Ball Joint Assembly - Front Right		7L0407152C; 95534101832; 7L0407152D
ARM1036	301181310360 Suspension Control Arm and Ball Joint Assembly - Front Left		7L0407151C; 95534101731; 7L0407151D
SSP0267	301191602670 Steering Tie Rod - Front	M16x1,5Rht - L=287,5mm	1160310016; 7L0422821
SSP0696	301191606960 Steering Tie Rod End - Front Right	M16x1,5Rht	7L0422818B; 95534713220; 7L0422818D; 7L0422818C
SSP0697	301191606970 Steering Tie Rod End - Front Left	M16x1,5Rht	7L0422817B; 95534713221; 7L0422817D; 7L0422817C
SSP2566	301191625660 Suspension Stabilizer Bar Link - Front	L=197mm	7L0411317
SSP2567	301191625670 Suspension Stabilizer Bar Link - Rear Right	L=201mm	7L0505466A; 95533307010
SSP2568	301191625680 Suspension Stabilizer Bar Link - Rear Left	L=201mm	7L0505466A; 95533307011



PART NO.	DESCRIPTION	NOTES	O.E.
ARM237	301181323700 Lateral Arm - Rear Right	(ALM)	7L0505398
ARM238	301181323800 Lateral Arm - Rear Left	(ALM)	7L0505397
ARM239	301181323900 Lateral Arm - Rear Lower		7L8501529A
ARM240	301181324000 Suspension Control Arm and Ball Joint Assembly - Front Right Lower		7L8407152E
ARM241	301181324100 Suspension Control Arm and Ball Joint Assembly - Front Left Lower		7L8407151E
ARM1033	301181310330 Suspension Control Arm and Ball Joint Assembly - Front Upper	Alum.	7L0407021A; 95534102702; 95534102701; 7L0407021B
SSP0267	301191602670 Steering Tie Rod - Front	M16x1,5Rht - L=287,5mm	1160310016; 7L0422821
SSP0696	301191606960 Steering Tie Rod End - Front Right	M16x1,5Rht	7L0422818B; 95534713220; 7L0422818D; 7L0422818C
SSP2566	301191625660 Suspension Stabilizer Bar Link - Front	L=197mm	7L0411317



PORSCHE MACAN



02/2014-



ARM200



ARM200

PART NO.	DESCRIPTION	NOTES	O.E.
ARM200 301181320000	Lateral Arm - Rear Lower Forward		8K0501529L



PROTON PERSONA



02/1994-11/2000



PART NO.	DESCRIPTION	NOTES	O.E.
SSP0708 301191607080	Steering Tie Rod End - Front	M12x1,25Rht	30870695; MB598023; MB912076; MB241982; 30875012



RENAULT 19



1991-2001



SSP1944



SSP1944



SSP1944



SSP1944

PART NO.	DESCRIPTION	NOTES	O.E.
SSP1944 301191619440	Suspension Ball Joint - Front Lower	D=Ø16mm - Hole: Ø10,5mm - Ø12,6mm	6001538603; 7701468883; 7701462182



RENAULT 21 MANAGER



1986-1994



SSP1944



SSP1944

PART NO.	DESCRIPTION	NOTES	O.E.
SSP1944 301191619440	Suspension Ball Joint - Front Lower	D=Ø16mm - (Hole: Ø10,5mm - Ø12,6mm)	6001538603; 7701468883; 7701462182

**RENAULT 9_11**

1981-2000

**SSP1944****SSP1944****SSP1945****SSP1945**

PART NO.	DESCRIPTION	NOTES	O.E.
SSP1944 301191619440	Suspension Ball Joint - Front Lower	D=Ø16mm - (Hole: Ø10,5mm - Ø12,6mm)	6001538603; 7701468883; 7701462182
SSP1945 301191619450	Suspension Ball Joint - Front Lower	Only:Flash D=Ø16mm - Hole: Ø12,5mm	7702127160



RENAULT CAPTUR



03/2013-

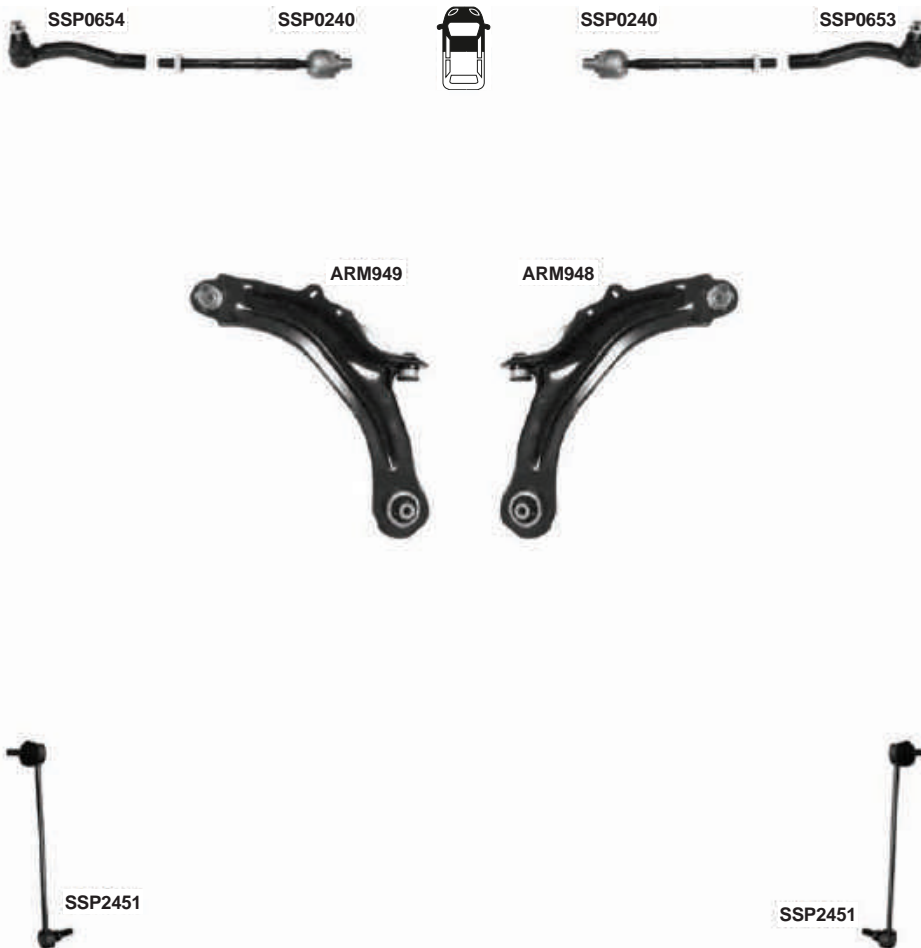

PART NO.	DESCRIPTION	NOTES	O.E.
ARM948 301181394800	Suspension Control Arm and Ball Joint Assembly - Right Lower		545041327R
ARM949 301181394900	Suspension Control Arm and Ball Joint Assembly - Left Lower		545055708R
SSP0240 301191602400	Steering Tie Rod - Front	M14X1,5 - L=232mm	485211071R
SSP0653 301191606530	Steering Tie Rod End - Front Right	M14X1,5	485208355R
SSP0654 301191606540	Steering Tie Rod End - Front Left	M14X1,5	485200368R
SSP2451 301191624510	Suspension Stabilizer Bar Link - Front	L=248mm	54618AX600; 551107916R; 8200127308



RENAULT CLIO I



05/1990-09/1998

**SSP0646****SSP0645****SSP1944****SSP1944**

PART NO.	DESCRIPTION	NOTES	O.E.
SSP0645 301191606450	Steering Tie Rod End - Front Right	SMI Steering M14x1,5Rht	6000022721; 7701471127
SSP0646 301191606460	Steering Tie Rod End - Front Left	SMI Steering M14x1,5Rht	6000022720; 7701471126
SSP1944 301191619440	Suspension Ball Joint - Front Lower	D=Ø16mm - Hole: Ø10,5mm - Ø12,6mm	6001538603; 7701468883; 7701462182



PART NO.	DESCRIPTION	NOTES	O.E.
SSP0231 301191602310	Steering Tie Rod - Front	without power steering	7701471124



MAGNETI
MARELLI

RENAULT CLIO II-SYMBOL



10/1998-2012





RENAULT CLIO II-SYMBOL



10/1998-2012

PART NO.	DESCRIPTION	NOTES	O.E.
ARM962	301181396200 Suspension Control Arm and Ball Joint Assembly - Front Right Lower	Hole:Ø10,5mm	7700313945; 8200197187; 7700425228
ARM963	301181396300 Suspension Control Arm and Ball Joint Assembly - Front Left Lower	Hole:Ø10,5mm	7700313944; 8200197179; 7700425227
ARM964	301181396400 Suspension Control Arm and Ball Joint Assembly - Front Right Lower	Hole:Ø12,5mm	5450000QAH; 8200254166
ARM965	301181396500 Suspension Control Arm and Ball Joint Assembly - Front Left Lower	Hole:Ø12,5mm	5450100QAH; 8200254163
ARM968	301181396800 Suspension Control Arm and Ball Joint Assembly - Front Right Lower	SYMBOL	8200942408
ARM969	301181396900 Suspension Control Arm and Ball Joint Assembly - Front Left Lower	SYMBOL	8200942407
SSP0227	301191602270 Steering Tie Rod - Front Inner	M14x1,5Rht - L=242mm	7701471125
SSP0228	301191602280 Steering Tie Rod - Front	SMI Steering M14x1,5Rht - L=301mm	7701472734
SSP0229	301191602290 Steering Tie Rod - Front	Only:Clio 2.0 16v M14x1,5Rht - L=318mm	7701473656
SSP0230	301191602300 Steering Tie Rod - Front	Only:Clio 2.0 16V M14x1,5Rht - L=318mm	7701473656*
SSP0232	301191602320 Steering Tie Rod - Front	TRW Steering M14x1,5Rht - L=244mm	7701471144; 7701473655
SSP0235	301191602350 Steering Tie Rod - Front	TRW Steering M14x1,5Rht - L=304mm	4852100QAA; 7701472113
SSP0236	301191602360 Steering Tie Rod - Front	SMI Steering M14x1,5Rht - L=302,5mm	4852100QAG; 7701473655; 7701472120
SSP0237	301191602370 Steering Tie Rod - Front Inner	1.5 TD SMI Steering M14x1,5Rht - L=303mm	7701472120*; 7701473655*
SSP0238	301191602380 Steering Tie Rod - Front	TRW Steering M14x1,5 - L=293mm	7701472735
SSP0645	301191606450 Steering Tie Rod End - Front Right	SMI Steering M14x1,5Rht	6000022721; 7701471127
SSP0646	301191606460 Steering Tie Rod End - Front Left	SMI Steering M14x1,5Rht	6000022720; 7701471126
SSP0647	301191606470 Steering Tie Rod End - Front Right	TRW Steering M14x1,5Rht	7701471146
SSP0648	301191606480 Steering Tie Rod End - Front Left	TRW Steering M14x1,5Rht	7701471145
SSP0649	301191606490 Steering Tie Rod End - Front Right Outer	M14x1,5Rht.	48520AX602; 7701474493; 7701475843; 7701047813; 7701047416
SSP0650	301191606500 Steering Tie Rod End - Front Left Outer	M14x1,5Rht.	48640AX602; 7701475842; 7701474492; 7701474641; 7701047812; 7701047415
SSP1944	301191619440 Suspension Ball Joint - Front Lower	D=Ø16mm - Hole: Ø10,5mm - Ø12,6mm	6001538603; 7701468883; 7701462182
SSP1945	301191619450 Suspension Ball Joint - Front Lower	SYMBOL D=Ø16mm - Hole: Ø12,5mm	7702127160

**RENAULT CLIO III-HB**

06/2005-09/2012



PART NO.	DESCRIPTION	NOTES	O.E.
ARM940 301181394000	Suspension Control Arm and Ball Joint Assembly - Front Right Lower	Ball Joint D=Ø18mm	8200346942; 8200744092; 8200615058
ARM941 301181394100	Suspension Control Arm and Ball Joint Assembly - Front Left Lower	Ball Joint D=Ø18mm	8200346941; 8200744091; 8200615057
SSP0219 301191602190	Steering Tie Rod - Front	M14x1,5Rht - L=305.5mm	7701475841
SSP0649 301191606490	Steering Tie Rod End - Front Right Outer	M14x1,5Rht.	48520AX602; 7701474493; 7701475843; 7701047813; 7701047416
SSP0650 301191606500	Steering Tie Rod End - Front Left Outer	M14x1,5Rht.	48640AX602; 7701475842; 7701474492; 7701474641; 7701047812; 7701047415
SSP1952 301191619520	Suspension Ball Joint - Front	D=Ø18mm	8200298455/S
SSP2451 301191624510	Suspension Stabilizer Bar Link - Front	L=248mm	54618AX600; 551107916R; 8200127308
SSP2528 301191625280	Suspension Stabilizer Bar Link - Front	2.0 16v Sport	543175784R; 8200686016; 8200265217



RENAULT CLIO III-SYMBOL



2013-



	PART NO.	DESCRIPTION	NOTES	O.E.
ARM972	301181397200	Suspension Control Arm and Ball Joint Assembly - Front Right Lower		545004529R; 545007106R
ARM973	301181397300	Suspension Control Arm and Ball Joint Assembly - Front Left Lower		545010294R; 545011727R
SSP0241	301191602410	Steering Tie Rod - Front	M14X1,5 - L=193mm	485213172R
SSP0386	301191603860	Steering Tie Rod End - Front Right	M14X1,5Rht	485200410R; 6001550443; 6001547611
SSP0387	301191603870	Steering Tie Rod End - Front Left	M14X1,5Rht	485202867R; 6001550442; 6001547610



RENAULT CLIO IV-HB



10/2012-

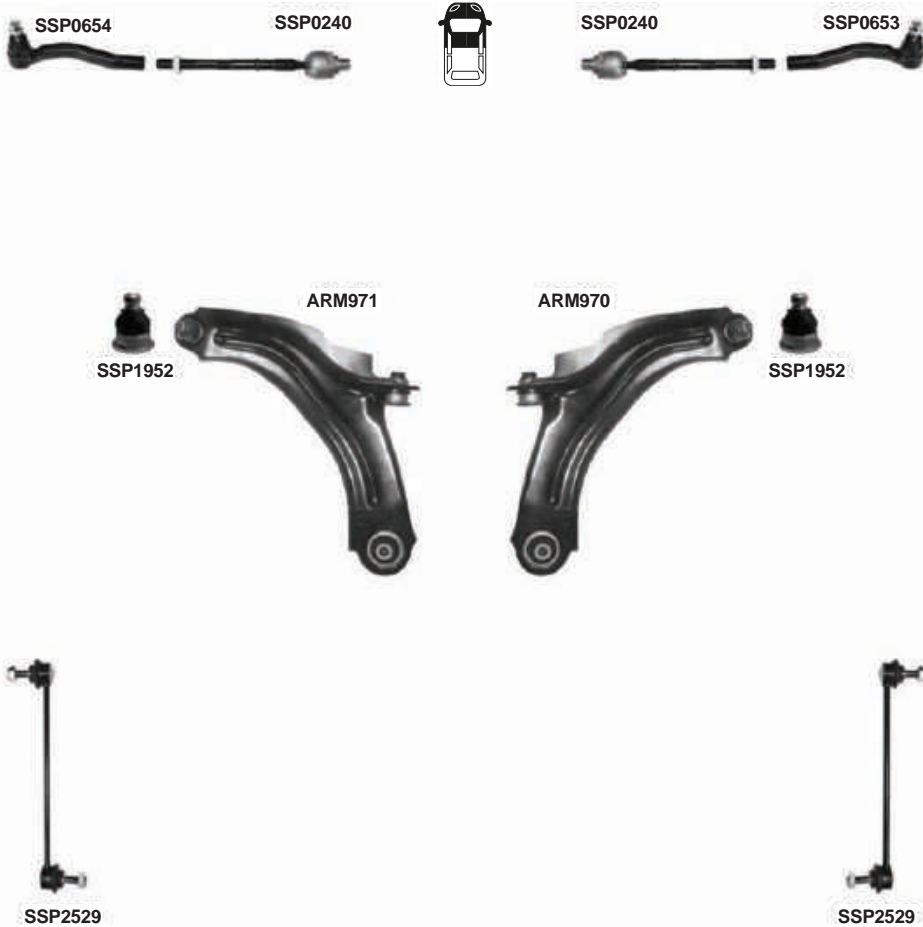

	PART NO.	DESCRIPTION	NOTES	O. E.
ARM970	301181397000	Suspension Control Arm and Ball Joint Assembly - Front Right Lower		545046817R; 545048506R
ARM971	301181397100	Suspension Control Arm and Ball Joint Assembly - Front Left Lower		545050510R; 545055711R
SSP0240	301191602400	Steering Tie Rod - Front	M14X1,5 - L=232mm	485211071R
SSP0653	301191606530	Steering Tie Rod End - Front Right	M14X1,5	485208355R
SSP0654	301191606540	Steering Tie Rod End - Front Left	M14X1,5	485200368R
SSP1952	301191619520	Suspension Ball Joint - Front	D=Ø18mm	8200298455/S
SSP2529	301191625290	Suspension Stabilizer Bar Link - Front	L=248mm	8201079463



RENAULT ESPACE IV



11/2002-09/2014



PART NO.	DESCRIPTION	NOTES	O.E.
SSP0226 301191602260	Steering Tie Rod - Front	M14x1,5 - L=248,5mm	7701474076; 7701478552
SSP0641 301191606410	Steering Tie Rod End - Front Right	M14x1,5Rht	4408511; 91160044; 7701049283; 4852000QAL
SSP0642 301191606420	Steering Tie Rod End - Front Left	M14x1,5Rht	4408510; 91160043; 7701049282; 4852000QAK
SSP2522 301191625220	Suspension Stabilizer Bar Link - Front	L=279mm	4408904; 8200002870; 546181944R; 5461600QAC
SSP2523 301191625230	Suspension Stabilizer Bar Link - Front	(Clip-on patented design) L=279mm	4408904; 8200002870; 5461600QAC



PART NO.	DESCRIPTION	NOTES	O.E.
SSP1960 301191619600	Suspension Ball Joint - Front		Part of 545047275R; Part of 545050303R



RENAULT EXPRESS EXTRA (VAN)  07/1985-03/1998



SSP1944



SSP1944

PART NO.	DESCRIPTION	NOTES	O.E.
SSP1944 301191619440	Suspension Ball Joint - Front Lower	D=Ø16mm - Hole: Ø10,5mm - Ø12,6mm	6001538603; 7701468883; 7701462182



RENAULT FLUENCE



02/2010-



PART NO.	DESCRIPTION	NOTES	O.E.
ARM960 301181396000	Suspension Control Arm and Ball Joint Assembly - Front Right Lower		545004055R; 545009207R
ARM961 301181396100	Suspension Control Arm and Ball Joint Assembly - Front Left Lower		545014055R; 545016838R
SSP0239 301191602390	Steering Tie Rod - Front	M14x1,5 - L=210mm	4154600000; A4154600000; 7701478406; 485215612R
SSP0643 301191606430	Steering Tie Rod End - Front Right	M14x1,5	485204680R
SSP0644 301191606440	Steering Tie Rod End - Front Left	M14x1,5	485202710R
SSP1956 301191619560	Suspension Ball Joint - Front Lower		401600005R; 401609060R



RENAULT KADJAR



2015-



PART NO.	DESCRIPTION	NOTES	O.E.
ARM867 301181386700	Suspension Control Arm and Ball Joint Assembly - Front Right		545004EA0A; 545004EA0B
ARM868 301181386800	Suspension Control Arm and Ball Joint Assembly - Front Left		545014EA0A; 545014EA0B
SSP0218 301191602180	Steering Tie Rod - Front		485212518R
SSP0592 301191605920	Steering Tie Rod End - Front Right		D85204EA0A
SSP0593 301191605930	Steering Tie Rod End - Front Left		D86404EA0A
SSP1926 301191619260	Suspension Ball Joint - Front Lower		Part of 54500JD000; Part of 54501JD000; Part of 545004CA0A; Part of 545014CA0A; Part of 545014CUA0; Part of 545004CUA0; Part of 545014BA0A; Part of 545004BA0A
SSP2469 301191624690	Suspension Stabilizer Bar Link - Front		54618CY00A



RENAULT KANGOO I



03/1998-01/2008

SSP0648



SSP0235



SSP0235



SSP0647



SSP0650



SSP0236



SSP0236



SSP0649



SSP0229



SSP0229



SSP0230



SSP0230



SSP0233



SSP0233



SSP0234



SSP0234



SSP0237



SSP0237



ARM963



ARM962



SSP1944



SSP1944



ARM965



ARM964



SSP1945



SSP1945





RENAULT KANGOO I



03/1998-01/2008

PART NO.	DESCRIPTION	NOTES	O.E.
ARM962	301181396200 Suspension Control Arm and Ball Joint Assembly - Front Right Lower	Hole:Ø10,5mm	7700313945; 8200197187; 7700425228
ARM963	301181396300 Suspension Control Arm and Ball Joint Assembly - Front Left Lower	Hole:Ø10,5mm	7700313944; 8200197179; 7700425227
ARM964	301181396400 Suspension Control Arm and Ball Joint Assembly - Front Right Lower	Hole:Ø12,5mm	5450000QAH; 8200254166
ARM965	301181396500 Suspension Control Arm and Ball Joint Assembly - Front Left Lower	Hole:Ø12,5mm	5450100QAH; 8200254163
SSP0229	301191602290 Steering Tie Rod - Front	Only:Kangoo 1.9 4x4 M14x1,5Rht - L=318mm	7701473656
SSP0230	301191602300 Steering Tie Rod - Front	Only:Kangoo 1.9 4x4 M14x1,5Rht - L=318mm	7701473656*
SSP0233	301191602330 Steering Tie Rod - Front	Manual Steering M14x1,5Rht - L=264mm	7701470764
SSP0234	301191602340 Steering Tie Rod - Front	Power Steering M14x1,5Rht - L=265mm	7701470763
SSP0235	301191602350 Steering Tie Rod - Front	TRW Steering M14x1,5Rht - L=304mm	4852100QAA; 7701472113
SSP0236	301191602360 Steering Tie Rod - Front	1.5 TD SMI Steering M14x1,5Rht - L=302.5mm	4852100QAG; 7701473655; 7701472120
SSP0237	301191602370 Steering Tie Rod - Front Inner	1.5 TD SMI Steering M14x1,5Rht - L=303mm	7701472120*; 7701473655*
SSP0647	301191606470 Steering Tie Rod End - Front Right	TRW Steering M14x1,5Rht	7701471146
SSP0648	301191606480 Steering Tie Rod End - Front Left	TRW Steering M14x1,5Rht	7701471145
SSP0649	301191606490 Steering Tie Rod End - Front Right Outer	1.5 TD SMI Steering M14x1,5Rht	48520AX602; 7701474493; 7701475843; 7701047813; 7701047416
SSP0650	301191606500 Steering Tie Rod End - Front Left Outer	1.5 TD SMI Steering M14x1,5Rht	48640AX602; 7701475842; 7701474492; 7701474641; 7701047812; 7701047415
SSP1944	301191619440 Suspension Ball Joint - Front Lower	D=Ø16mm - Hole: Ø10,5mm - Ø12,6mm	6001538603; 7701468883; 7701462182
SSP1945	301191619450 Suspension Ball Joint - Front Lower	D=Ø16mm - Hole: Ø12,5mm	7702127160



RENAULT KANGOO II



02/2008-



PART NO.	DESCRIPTION	NOTES	O.E.
ARM966 301181396600	Suspension Control Arm and Ball Joint Assembly - Front Right Lower		8200586567
ARM967 301181396700	Suspension Control Arm and Ball Joint Assembly - Front Left Lower		8200586561
SSP0239 301191602390	Steering Tie Rod - Front	M14x1,5 - L=210mm	4154600000; A4154600000; 7701478406; 485215612R
SSP0651 301191606510	Steering Tie Rod End - Front Right	M14x1,5	4154600105; A4154600105; 7701478408
SSP0652 301191606520	Steering Tie Rod End - Front Left	M14x1,5	4154600005; A4154600005; 7701478407
SSP2519 301191625190	Suspension Stabilizer Bar Link - Front	L=283mm	4153200189; A4153200189; 8200669065; 8200166159



RENAULT KOLEOS



09/2008-

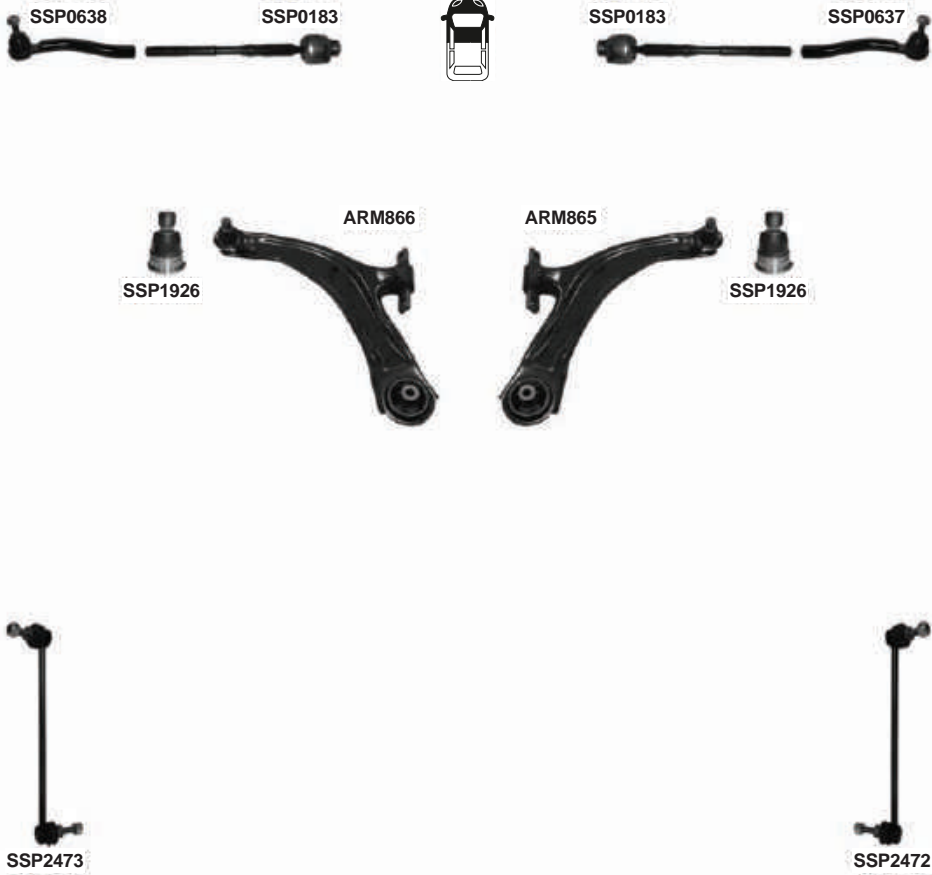

PART NO.	DESCRIPTION	NOTES	O.E.
ARM865	301181386500 Suspension Control Arm and Ball Joint Assembly - Right Lower		54500BB00A; 54500JG00B; 54500JD00D; 54500JD000
ARM866	301181386600 Suspension Control Arm and Ball Joint Assembly - Left Lower		54501JD000; 54501JY00A; 54501JD00D
SSP0183	301191601830 Steering Tie Rod - Front	M14x1,5 - L=232mm	D8521JG00A
SSP0637	301191606370 Steering Tie Rod End - Front Right	M14x1,5	D8520JY00A
SSP0638	301191606380 Steering Tie Rod End - Front Left	M14x1,5	D8640JY00A
SSP1926	301191619260 Suspension Ball Joint - Front Lower		Part of 54500JD000; Part of 54501JD000; Part of 545004CA0A; Part of 545014CA0A; Part of 545014CUA0; Part of 545004CUA0; Part of 545014BA0A; Part of 545004BA0A
SSP2472	301191624720 Suspension Stabilizer Bar Link - Front Right	L=299,5mm	546181AA0A; 54618JD00A; 546181AA0E; 54618JA000
SSP2473	301191624730 Suspension Stabilizer Bar Link - Front Left	L=299,5mm	546681AA0A; 54668JD00A; 546681AA0E; 54668JA000



RENAULT LAGUNA II



04/2001-09/2007

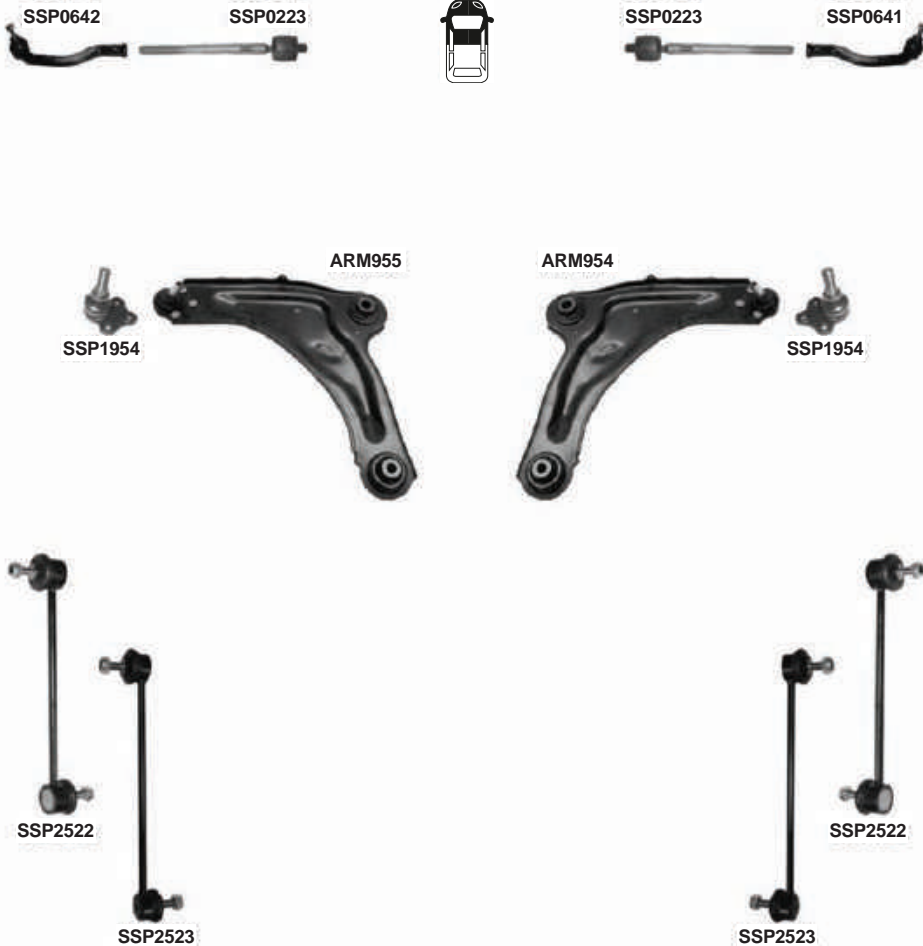

PART NO.	DESCRIPTION	NOTES	O.E.
ARM954	301181395400 Suspension Control Arm and Ball Joint Assembly - Front Right Lower		8200026655; 8200389135; 8200273729
ARM955	301181395500 Suspension Control Arm and Ball Joint Assembly - Front Left Lower		8200026654; 8200389134; 8200273728
SSP0223	301191602230 Steering Tie Rod - Front	M14x1,5 - L=218mm	7701472766
SSP0224	301191602240 Steering Tie Rod - Front		7701472766; 7701478551
SSP0641	301191606410 Steering Tie Rod End - Front Right	M14x1,5Rht	4408511; 91160044; 7701049283; 485200QAL
SSP0642	301191606420 Steering Tie Rod End - Front Left	M14x1,5Rht	4408510; 91160043; 7701049282; 485200QAK
SSP1954	301191619540 Suspension Ball Joint - Front Lower		4016000Q0A; 91166461*; 7701476576; 4412936
SSP2522	301191625220 Suspension Stabilizer Bar Link - Front	L=279mm	4408904; 8200002870; 546181944R; 5461600QAC
SSP2523	301191625230 Suspension Stabilizer Bar Link - Front	(Clip-on patented design) L=279mm	4408904; 8200002870; 5461600QAC



RENAULT LAGUNA III



10/2007-

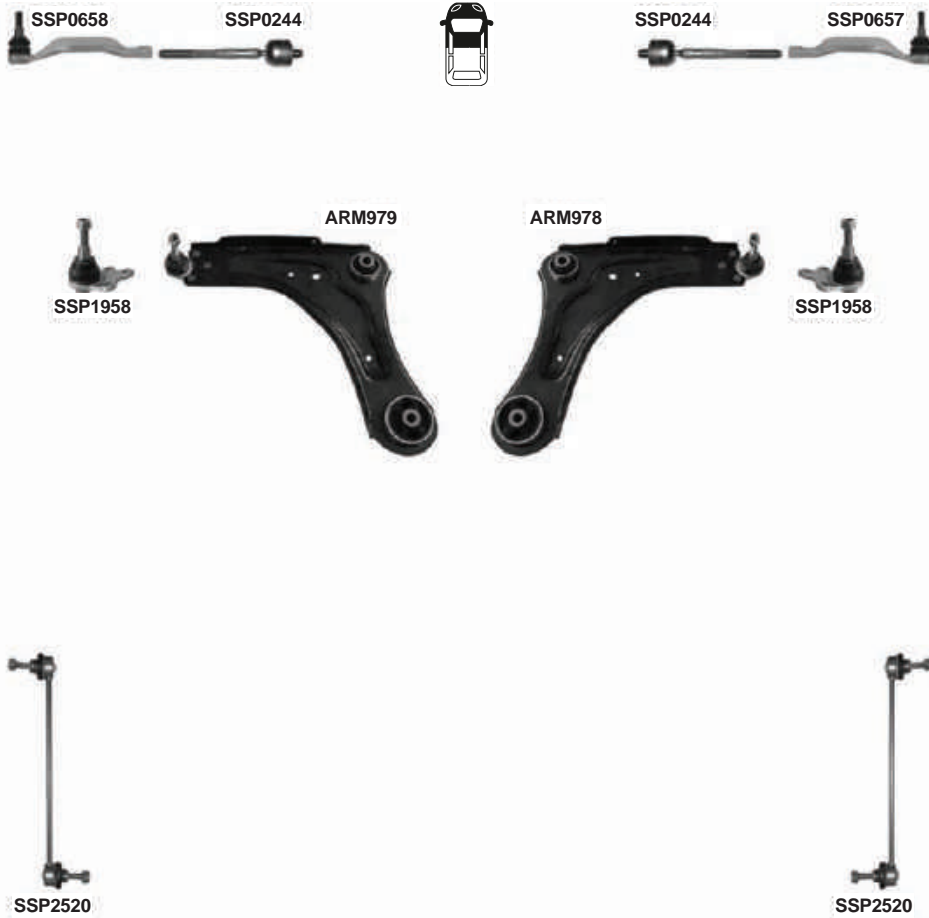

PART NO.	DESCRIPTION	NOTES	O.E.
ARM978 301181397800	Suspension Control Arm and Ball Joint Assembly - Front Right Lower		545000002R
ARM979 301181397900	Suspension Control Arm and Ball Joint Assembly - Front Left Lower		545010009R; 545010012R
SSP0244 301191602440	Steering Tie Rod - Front	M14x1.5 - L=188mm	485210001R
SSP0657 301191606570	Steering Tie Rod End - Front Right	M14x1.5	485200002R
SSP0658 301191606580	Steering Tie Rod End - Front Left	M14x1.5	485200001R
SSP1958 301191619580	Suspension Ball Joint - Front Lower		401600004R
SSP2520 301191625200	Suspension Stabilizer Bar Link - Front	L=294mm	546180001R



RENAULT MASTER I



07/1998-09/2003

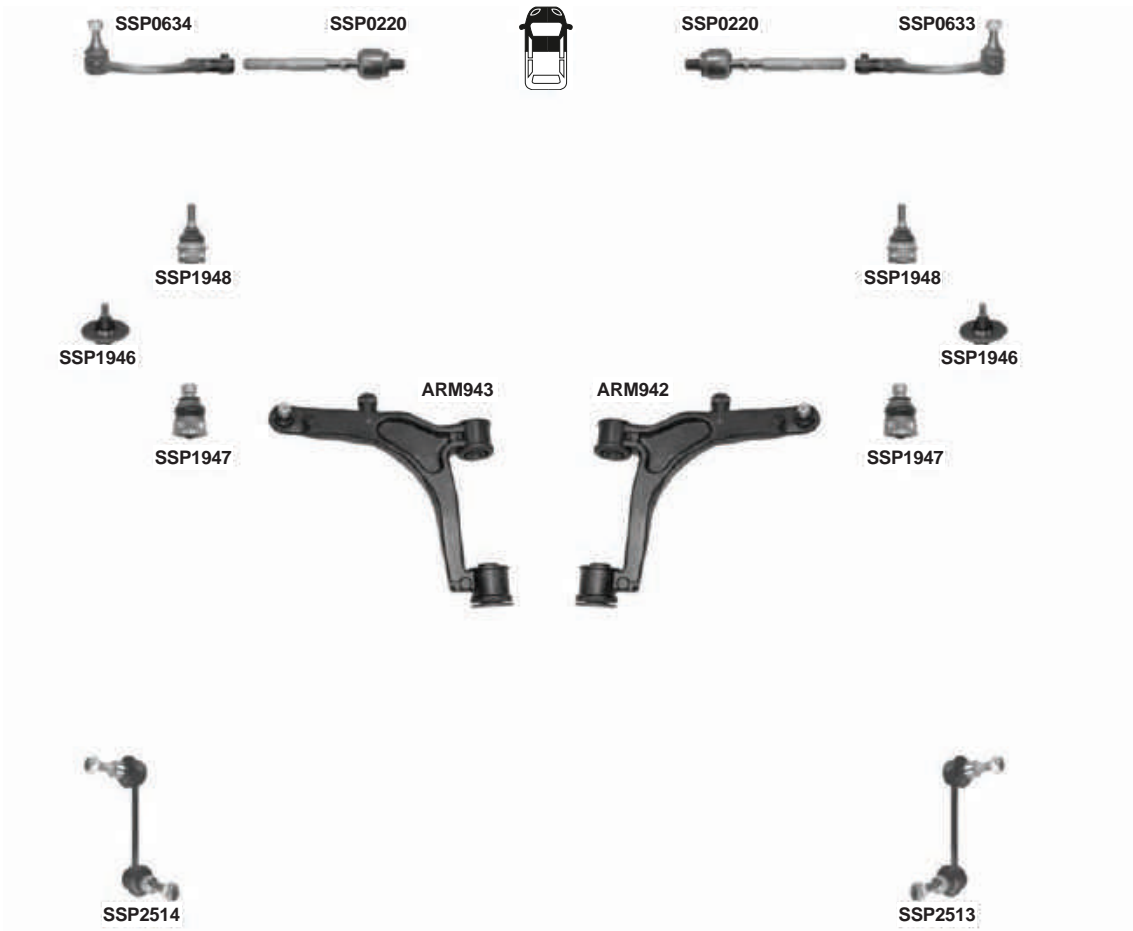

	PART NO.	DESCRIPTION	NOTES	O.E.
ARM942	301181394200	Suspension Control Arm and Ball Joint Assembly - Front Right Lower	Ball Joint D=Ø 22mm	4400048; 7700309190; 8200767825; 7700302119; 5450000QAD
ARM943	301181394300	Suspension Control Arm and Ball Joint Assembly - Front Left Lower	Ball Joint D=Ø 22mm	4404047; 7700309189; 8200767822; 7700302118; 5450100QAD
SSP0220	301191602200	Steering Tie Rod - Front	M16x1,5 - L=176mm	4501261; 7701470362; 4852100QAF
SSP0633	301191606330	Steering Tie Rod End - Front Right	M16x1,5Rht	4501263; 9161563; 7701470364; 4852000QAH
SSP0634	301191606340	Steering Tie Rod End - Front Left	M16x1,5Rht	4501262; 9161562; 7701470363; 4852000QAJ
SSP1946	301191619460	Suspension Ball Joint - Front Upper		4011000QAA; 7701056970; 4500090; 7700302114; 4401910; 4011000QAB
SSP1947	301191619470	Suspension Ball Joint - Front Lower	D=Ø22mm	4016000QAD; 9160555; 7700312852; 4500255
SSP1948	301191619480	Suspension Ball Joint - Front		4016000QAB; 7700312851; 9161561; 4501261; 4500254
SSP2513	301191625130	Suspension Stabilizer Bar Link - Front Right	L=127mm	4500199; 8200713523; 9160499; 7700309071; 5461800QAA
SSP2514	301191625140	Suspension Stabilizer Bar Link - Front Left	L=127mm	4500198; 8200713522; 9160498; 7700309070; 5461800QAB

RENAULT MASTER II



10/2003-01/2010

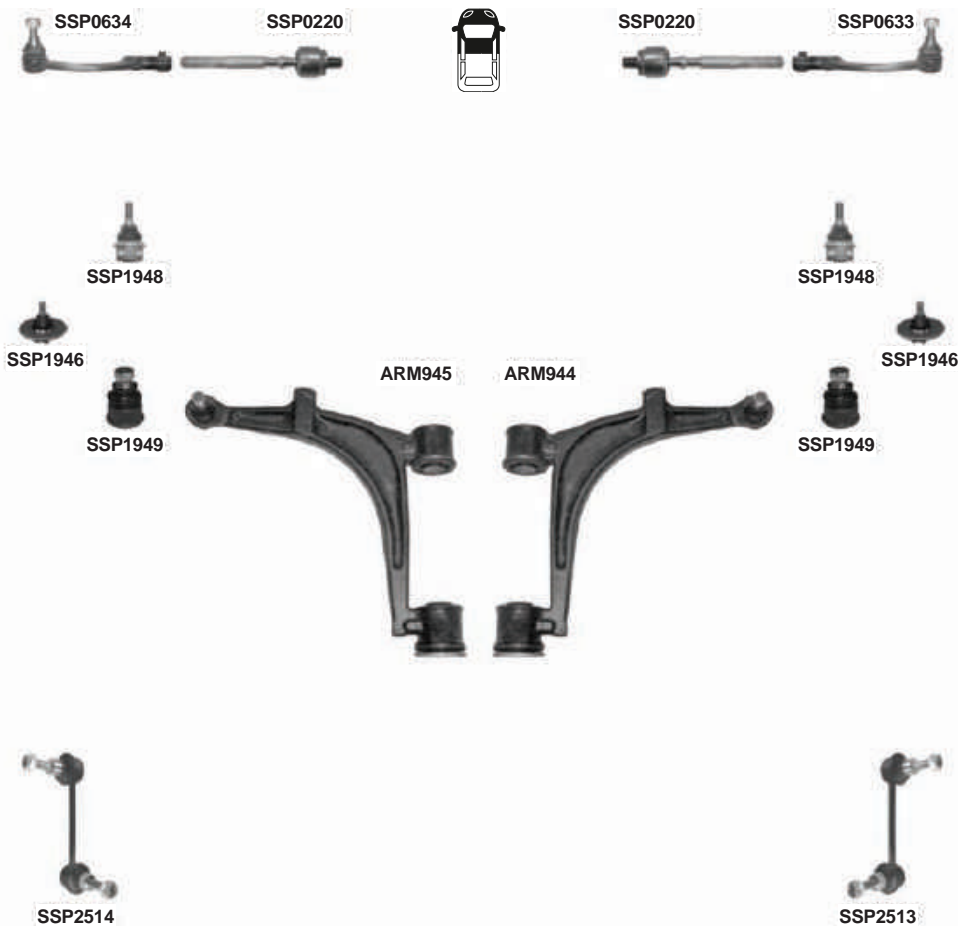

PART NO.	DESCRIPTION	NOTES	O.E.
ARM944 301181394400	Suspension Control Arm and Ball Joint Assembly - Front Right	D=Ø24mm	4418630; 93194855; 8200750274
ARM945 301181394500	Suspension Control Arm and Ball Joint Assembly - Front Left	D=Ø24mm	4418629; 93194853; 8200750273
SSP0220 301191602200	Steering Tie Rod - Front	M16x1,5 - L=176mm	4501261; 7701470362; 4852100QAF
SSP0633 301191606330	Steering Tie Rod End - Front Right	M16x1,5Rht	4501263; 9161563; 7701470364; 4852000QAH
SSP0634 301191606340	Steering Tie Rod End - Front Left	M16x1,5Rht	4501262; 9161562; 7701470363; 4852000QAJ
SSP1946 301191619460	Suspension Ball Joint - Front Upper		4011000QAA; 7701056970; 4500090; 7700302114; 4401910; 4011000QAB
SSP1948 301191619480	Suspension Ball Joint - Front		4016000QAB; 7700312851; 9161561; 4501261; 4500254
SSP1949 301191619490	Suspension Ball Joint - Front Lower	D=Ø24mm	4016000QOB; 7701070154; 4418631
SSP2513 301191625130	Suspension Stabilizer Bar Link - Front Right	L=127mm	4500199; 8200713523; 9160499; 7700309071; 5461800QAA
SSP2514 301191625140	Suspension Stabilizer Bar Link - Front Left	L=127mm	4500198; 8200713522; 9160498; 7700309070; 5461800QAB



RENAULT MASTER III



02/2010-

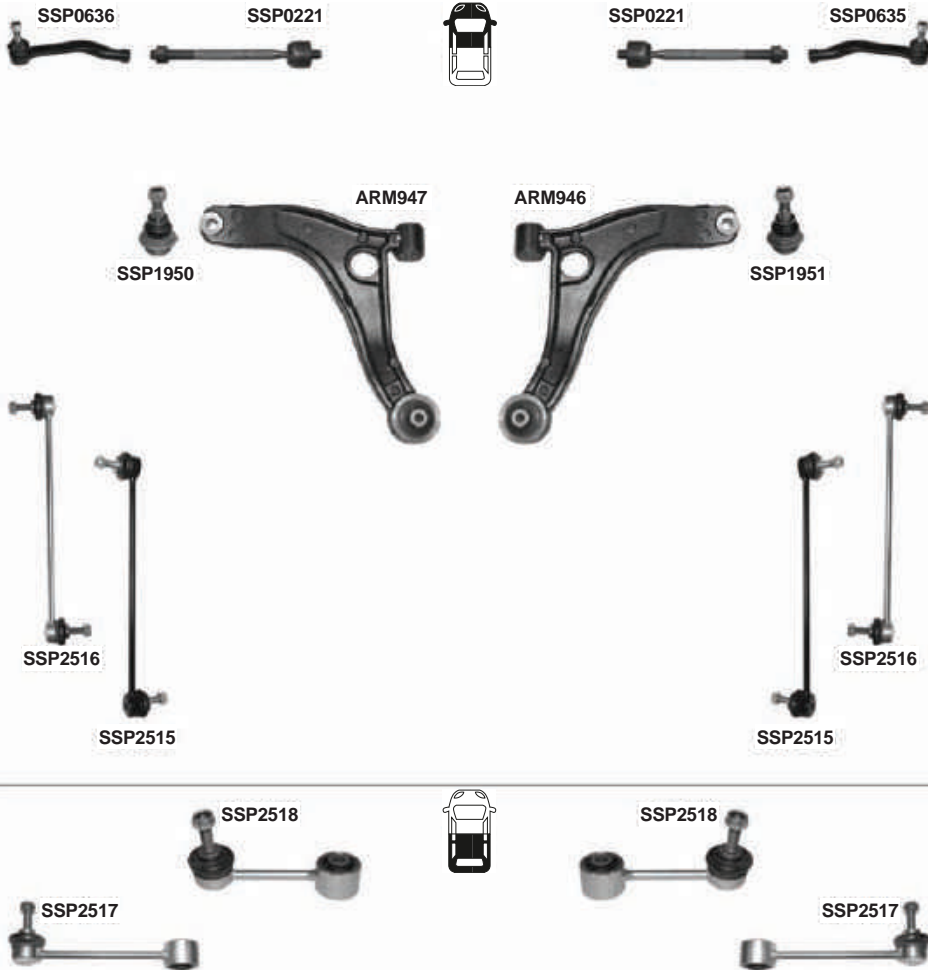

PART NO.	DESCRIPTION	NOTES	O.E.
ARM946 301181394600	Suspension Control Arm - Front Right Lower		4419216; 8200688875
ARM947 301181394700	Suspension Control Arm - Front Left Lower		4419215; 93197214; 8200688871
SSP0221 301191602210	Steering Tie Rod - Front	M18X1,5 - L=253mm	485212373R
SSP0635 301191606350	Steering Tie Rod End - Front Right	M18X1,5	4420098; 485200780R
SSP0636 301191606360	Steering Tie Rod End - Front Left	M18X1,5	4420097; 485206730R
SSP1950 301191619500	Suspension Ball Joint - Front Left Lower	D=Ø17,9mm	4419219; 93197233; 8200688877
SSP1951 301191619510	Suspension Ball Joint - Front Right Lower	D=Ø17,9mm	401608374R
SSP2515 301191625150	Suspension Stabilizer Bar Link - Front	L=330mm	4419291; 93197325; 546180004R
SSP2516 301191625160	Suspension Stabilizer Bar Link - Front	(Clip-on patented design) L=330mm	546180004R*
SSP2517 301191625170	Suspension Stabilizer Bar Link - Rear	Only: Pick-Up L=166mm	4420954; 93168675; 551100020R
SSP2518 301191625180	Suspension Stabilizer Bar Link - Rear	Only: Van Type L=106mm	551100019R



RENAULT MEGANE I



01/1995-08/2003



SSP1944



SSP1944

PART NO.	DESCRIPTION	NOTES	O.E.
SSP1944 301191619440	Suspension Ball Joint - Front Lower	D=Ø16mm - Hole: Ø10,5mm - Ø12,6mm	6001538603; 7701468883; 7701462182



RENAULT MEGANE II



09/2003-04/2009





RENAULT MEGANE II



09/2003-04/2009

	PART NO.	DESCRIPTION	NOTES	O.E.
ARM950	301181395000	Suspension Control Arm and Ball Joint Assembly - Front Right Lower	D=Ø18mm	8200298455; 8200679067
ARM951	301181395100	Suspension Control Arm and Ball Joint Assembly - Front Left Lower	D=Ø18mm	8200298454; 8200679063
ARM952	301181395200	Suspension Control Arm and Ball Joint Assembly - Front Right Lower	Ball Joint D=Ø16mm	8200255761
ARM953	301181395300	Suspension Control Arm and Ball Joint Assembly - Front Left Lower	Ball Joint D=Ø16mm	8200255760
SSP0222	301191602220	Steering Tie Rod - Front	M14x1,5 - L=216mm	7701474448
SSP0639	301191606390	Steering Tie Rod End - Front Right	M14x1,5Rht	7701474796
SSP0640	301191606400	Steering Tie Rod End - Front Left	M14x1,5Rht	7701474795
SSP1952	301191619520	Suspension Ball Joint - Front	D=Ø18mm	8200298455/S
SSP1953	301191619530	Suspension Ball Joint - Front Lower	D=Ø16mm	16160100006; 8200255761S
SSP2519	301191625190	Suspension Stabilizer Bar Link - Front	Only: Megane Sedan L=283mm	4153200189; A4153200189; 8200669065; 8200166159
SSP2521	301191625210	Suspension Stabilizer Bar Link - Front	Only:HB L=266,5mm	8200166160; 8200669066



RENAULT MEGANE III



05/2009-10/2015

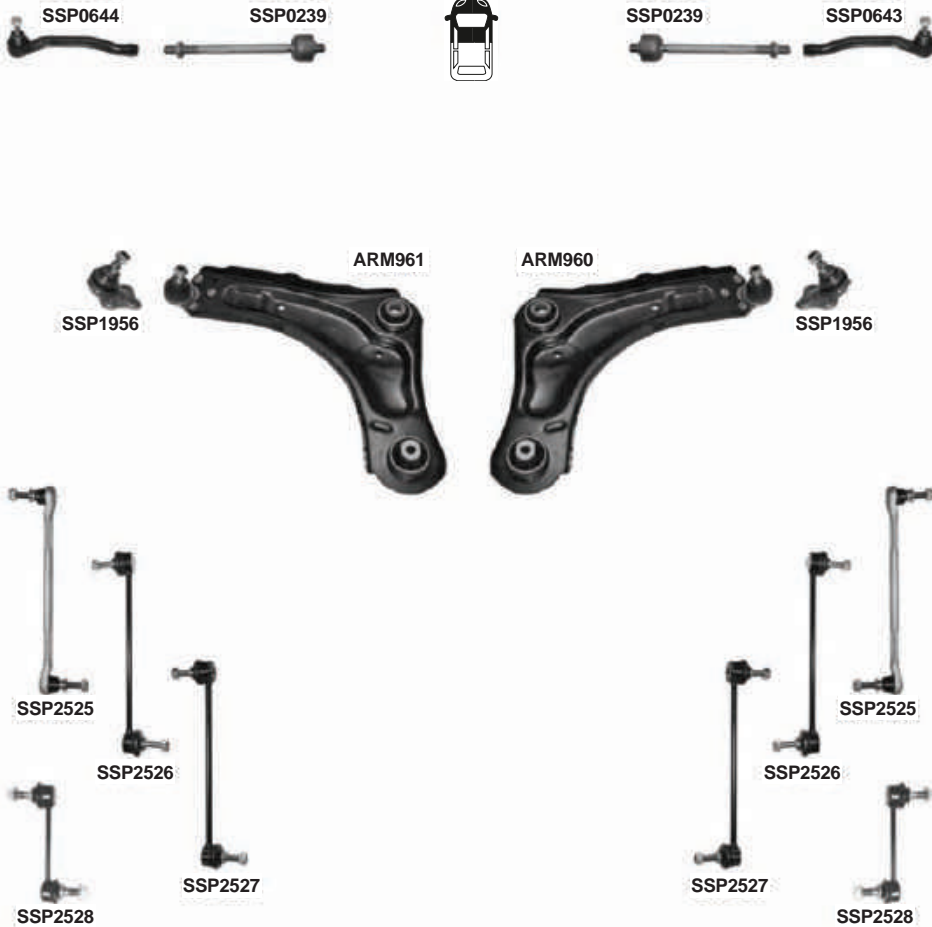

PART NO.	DESCRIPTION	NOTES	O.E.
ARM960	301181396000 Suspension Control Arm and Ball Joint Assembly - Front Right Lower		545004055R; 545009207R
ARM961	301181396100 Suspension Control Arm and Ball Joint Assembly - Front Left Lower		545014055R; 545016838R
SSP0239	301191602390 Steering Tie Rod - Front	M14x1,5 - L=210mm	4154600000; A4154600000; 7701478406; 485215612R
SSP0643	301191606430 Steering Tie Rod End - Front Right	M14x1,5	485204680R
SSP0644	301191606440 Steering Tie Rod End - Front Left	M14x1,5	485202710R
SSP1956	301191619560 Suspension Ball Joint - Front Lower		401600005R; 401609060R
SSP2525	301191625250 Suspension Stabilizer Bar Link - Front	(Alm. Design) L=274,5mm	546180002R
SSP2526	301191625260 Suspension Stabilizer Bar Link - Front	(Metal Design) L=274,5mm	546180002R*
SSP2527	301191625270 Suspension Stabilizer Bar Link - Front	(Metal Design) (Clip-on patented design) L=274,5mm	546180002R*
SSP2528	301191625280 Suspension Stabilizer Bar Link - Front	RS Type	543175784R; 8200686016; 8200265217

RENAULT MEGANE IV



2016-



PART NO.	DESCRIPTION	NOTES	O.E.
ARM980	301181398000 Suspension Control Arm and Ball Joint Assembly - Front Right	Sheet Metal	545045297R
ARM981	301181398100 Suspension Control Arm and Ball Joint Assembly - Front Left	Sheet Metal	545057449R
SSP0245	301191602450 Steering Tie Rod - Front		485216564R
SSP0659	301191606590 Steering Tie Rod End - Front Right		485201340R
SSP0660	301191606600 Steering Tie Rod End - Front Left		485206481R
SSP1959	301191619590 Suspension Ball Joint - Front		Part of 545057449R; Part of 545045297R
SSP2532	301191625320 Suspension Stabilizer Bar Link - Front	Aluminium	546187005R
SSP2533	301191625330 Suspension Stabilizer Bar Link - Front	Aluminium version	546187005R



RENAULT MODUS



12/2004-07/2014

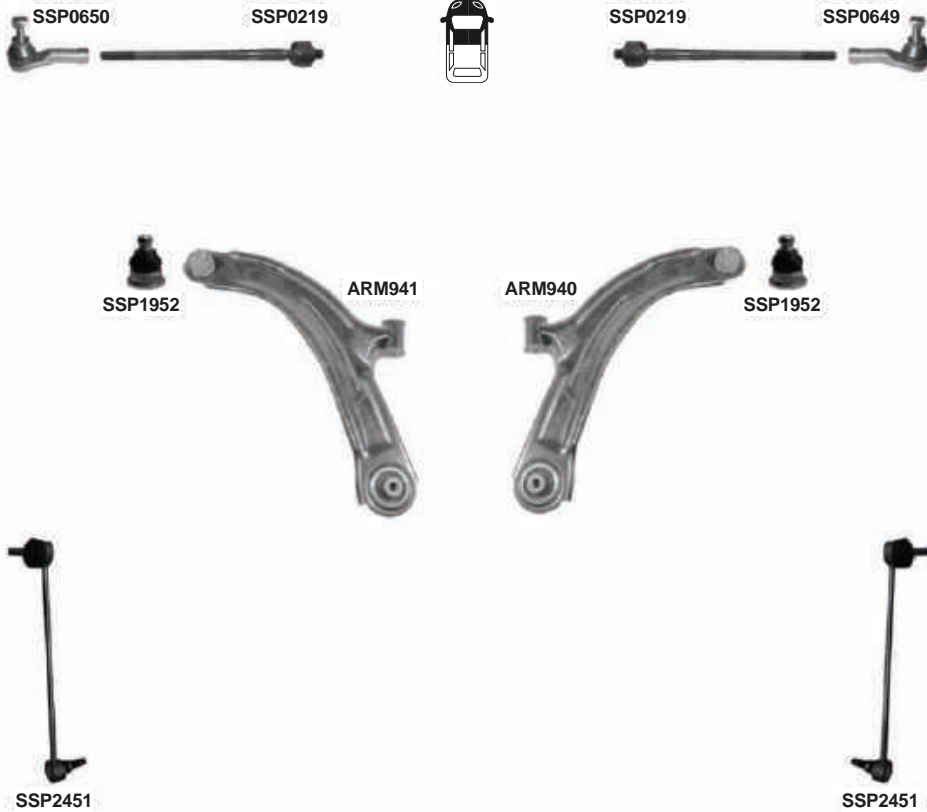

PART NO.	DESCRIPTION	NOTES	O.E.
ARM940 301181394000	Suspension Control Arm and Ball Joint Assembly - Front Right Lower	Ball Joint D=Ø18mm	8200346942; 8200744092; 8200615058
ARM941 301181394100	Suspension Control Arm and Ball Joint Assembly - Front Left Lower	Ball Joint D=Ø18mm	8200346941; 8200744091; 8200615057
SSP0219 301191602190	Steering Tie Rod - Front	M14x1,5Rht - L=305.5mm	7701475841
SSP0649 301191606490	Steering Tie Rod End - Front Right Outer	M14x1,5Rht.	48520AX602; 7701474493; 7701475843; 7701047813; 7701047416
SSP0650 301191606500	Steering Tie Rod End - Front Left Outer	M14x1,5Rht.	48640AX602; 7701475842; 7701474492; 7701474641; 7701047812; 7701047415
SSP1952 301191619520	Suspension Ball Joint - Front	D=Ø18mm	8200298455/S
SSP2451 301191624510	Suspension Stabilizer Bar Link - Front	L=248mm	54618AX600; 551107916R; 8200127308



RENAULT SCENIC I



1997-2002



SSP0650



SSP1944



SSP1944



SSP0649



SSP1944



SSP1944

PART NO.	DESCRIPTION	NOTES	O.E.
SSP0649 301191606490	Steering Tie Rod End - Front Right Outer	SMI Steering Scenic M14x1,5Rht.	48520AX602; 7701474493; 7701475843; 7701047813; 7701047416
SSP0650 301191606500	Steering Tie Rod End - Front Left Outer	SMI Steering Scenic M14x1,5Rht.	48640AX602; 7701475842; 7701474492; 7701474641; 7701047812; 7701047415
SSP1944 301191619440	Suspension Ball Joint - Front Lower	D=Ø16mm - Hole: Ø10,5mm - Ø12,6mm	6001538603; 7701468883; 7701462182



RENAULT SCENIC II



06/2003-01/2009



PART NO.	DESCRIPTION	NOTES	O.E.
ARM950 301181395000	Suspension Control Arm and Ball Joint Assembly - Front Right Lower	Ball Joint D=Ø18mm	8200298455; 8200679067
ARM951 301181395100	Suspension Control Arm and Ball Joint Assembly - Front Left Lower	Ball Joint D=Ø18mm	8200298454; 8200679063
SSP0222 301191602220	Steering Tie Rod - Front	M14x1,5 - L=216mm	7701474448
SSP0639 301191606390	Steering Tie Rod End - Front Right	M14x1,5Rht	7701474796
SSP0640 301191606400	Steering Tie Rod End - Front Left	M14x1,5Rht	7701474795
SSP1952 301191619520	Suspension Ball Joint - Front	D=Ø18mm	8200298455/S
SSP2519 301191625190	Suspension Stabilizer Bar Link - Front	L=283mm	4153200189; A4153200189; 8200669065; 8200166159

RENAULT SCENIC III



02/2009-

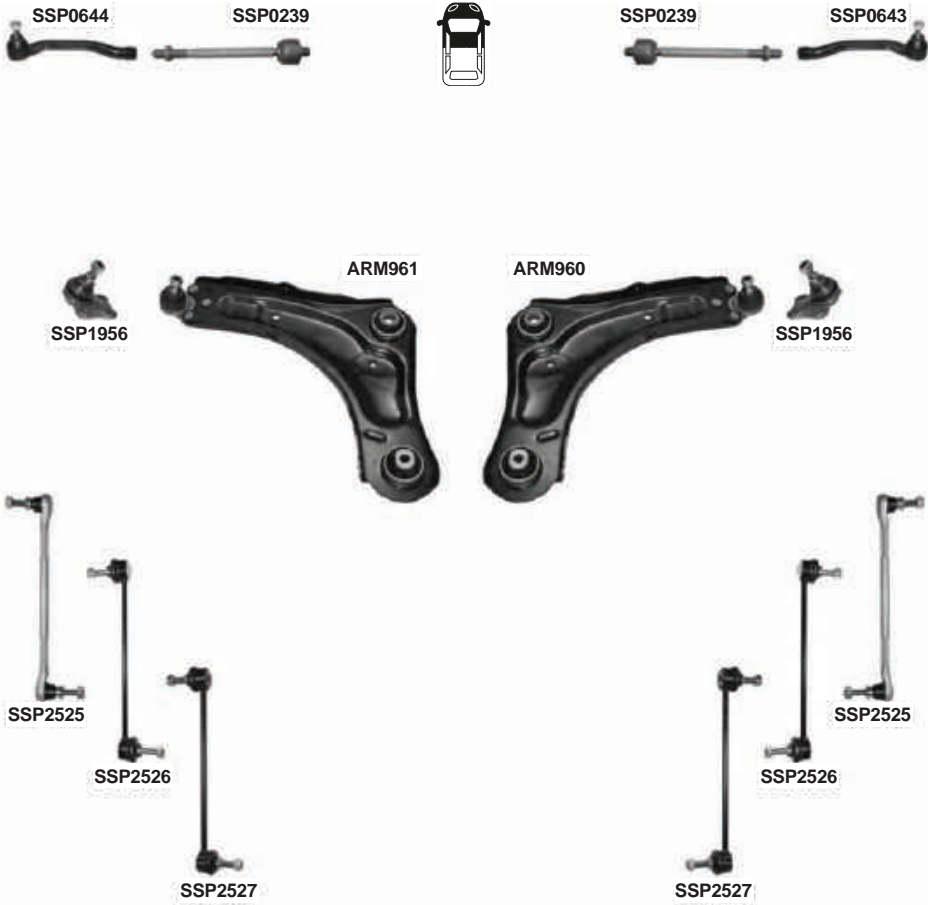

PART NO.	DESCRIPTION	NOTES	O.E.
ARM960 301181396000	Suspension Control Arm and Ball Joint Assembly - Front Right Lower		545004055R; 545019207R
ARM961 301181396100	Suspension Control Arm and Ball Joint Assembly - Front Left Lower		545014055R; 545016838R
SSP0239 301191602390	Steering Tie Rod - Front	M14x1,5 - L=210mm	4154600000; A4154600000; 7701478406; 485215612R
SSP0643 301191606430	Steering Tie Rod End - Front Right	M14x1,5	485204680R
SSP0644 301191606440	Steering Tie Rod End - Front Left	M14x1,5	485202710R
SSP1956 301191619560	Suspension Ball Joint - Front Lower		401600005R; 401609060R
SSP2525 301191625250	Suspension Stabilizer Bar Link - Front	(Alm. Design) L=274,5mm	546180002R
SSP2526 301191625260	Suspension Stabilizer Bar Link - Front	(Metal Design) L=274,5mm	546180002R*
SSP2527 301191625270	Suspension Stabilizer Bar Link - Front	(Metal Design) (Clip-on patented design) L=274,5mm	546180002R*

**RENAULT TALISMAN 1st Gen**

2015-

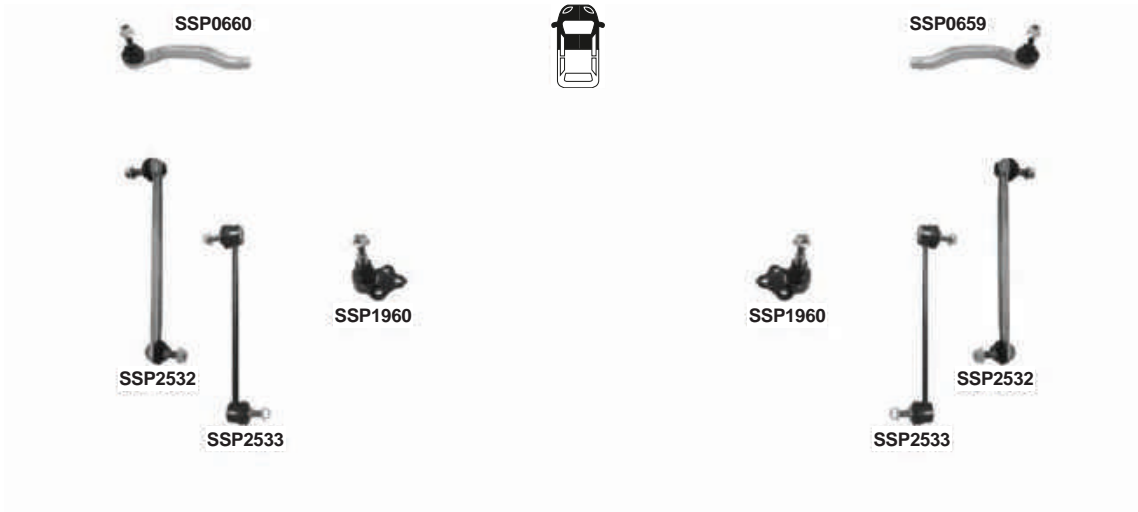

PART NO.	DESCRIPTION	NOTES	O.E.
SSP0246 301191602460	Steering Tie Rod - Front		485212309R
SSP0659 301191606590	Steering Tie Rod End - Front Right		485201340R
SSP0660 301191606600	Steering Tie Rod End - Front Left		485206481R
SSP1960 301191619600	Suspension Ball Joint - Front		Part of 545047275R; Part of 545050303R
SSP2532 301191625320	Suspension Stabilizer Bar Link - Front	Aluminium	546187005R
SSP2533 301191625330	Suspension Stabilizer Bar Link - Front	Metal version	546187005R

RENAULT TRAFIC II



03/2001-09/2014

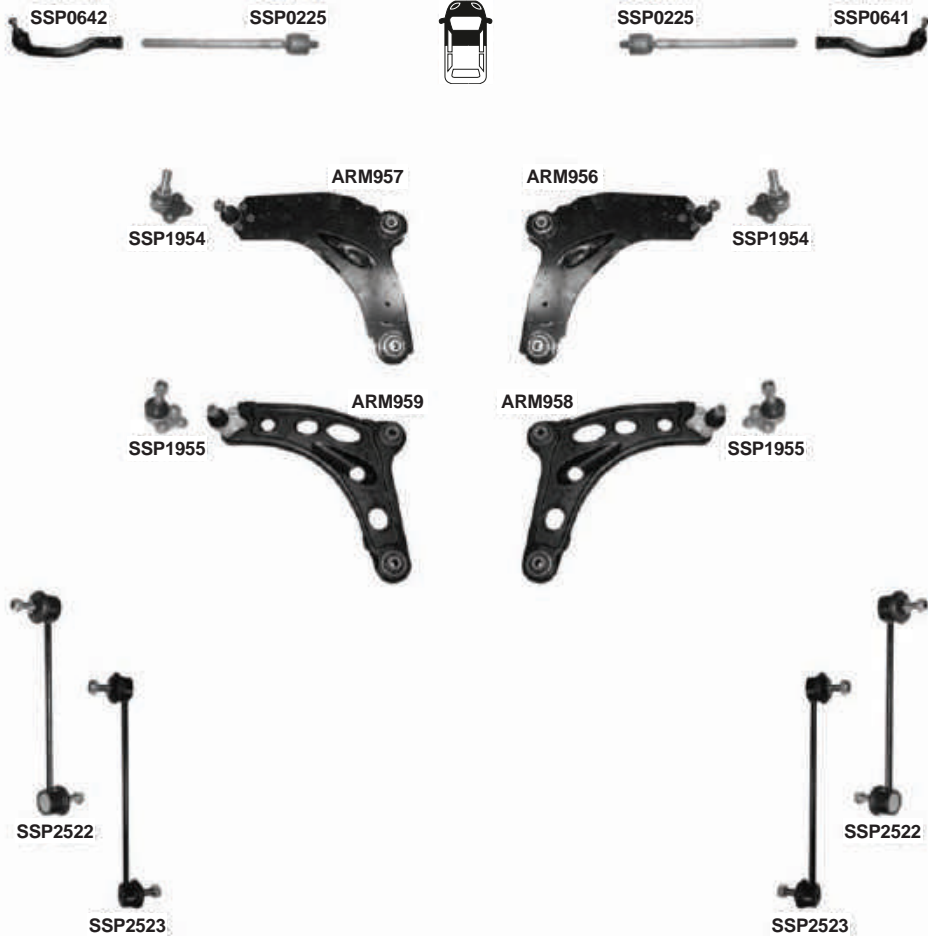

PART NO.	DESCRIPTION	NOTES	O.E.
ARM956	301181395600 Suspension Control Arm and Ball Joint Assembly - Front Right Lower		4421646; 8200247900; 91166641; 8200054006; 5450200QAB
ARM957	301181395700 Suspension Control Arm and Ball Joint Assembly - Front Left Lower		4421647; 8200247898; 91166642; 8200054003; 5450300QA3
ARM958	301181395800 Suspension Control Arm and Ball Joint Assembly - Front Right Lower		4417178; 93853465; 8200565079; 5450200QOC
ARM959	301181395900 Suspension Control Arm and Ball Joint Assembly - Front Left Lower		4417177; 93853464; 8200565072; 5450300QOC
SSP0225	301191602250 Steering Tie Rod - Front	M14x1,5 - L=263mm	4408474; 7701473333; 4852000QAM
SSP0641	301191606410 Steering Tie Rod End - Front Right	M14x1,5Rht	4408511; 91160044; 7701049283; 4852000QAL
SSP0642	301191606420 Steering Tie Rod End - Front Left	M14x1,5Rht	4408510; 91160043; 7701049282; 4852000QAK
SSP1954	301191619540 Suspension Ball Joint - Front Lower		4016000QQA; 91166461*; 7701476576; 4412936
SSP1955	301191619550 Suspension Ball Joint - Front Lower	Ø12mm	7701477385
SSP2522	301191625220 Suspension Stabilizer Bar Link - Front	L=279mm	4408904; 8200002870; 546181944R; 5461600QAC
SSP2523	301191625230 Suspension Stabilizer Bar Link - Front	(Clip-on patented design) L=279mm	4408904; 8200002870; 5461600QAC



RENAULT TRAFIC III



10/2014-



	PART NO.	DESCRIPTION	NOTES	O.E.
ARM938	301181393800	Suspension Control Arm and Ball Joint Assembly - Front Right		545006069R
ARM939	301181393900	Suspension Control Arm and Ball Joint Assembly - Front Left		545019956R
SSP0225	301191602250	Steering Tie Rod - Front	M14x1,5 - L=263mm	4408474; 7701473333; 4852000QAM
SSP0641	301191606410	Steering Tie Rod End - Front Right	M14x1,5Rht	4408511; 91160044; 7701049283; 4852000QAL
SSP0642	301191606420	Steering Tie Rod End - Front Left	M14x1,5Rht	4408510; 91160043; 7701049282; 4852000QAK
SSP1943	301191619430	Suspension Ball Joint - Front		Part of 545006069R; Part of 545019956R



RENAULT TWINGO (C06)



03/1993-02/2007

SSP0656



SSP0242



SSP0242



SSP0655



ARM975

ARM974

SSP1944



SSP1944



SSP2531



SSP2530

PART NO.	DESCRIPTION	NOTES	O.E.
ARM974 301181397400	Suspension Control Arm and Ball Joint Assembly - Front Right Lower		7700820029; 8200737126
ARM975 301181397500	Suspension Control Arm and Ball Joint Assembly - Front Left Lower		7700820028; 8200737126
SSP0242 301191602420	Steering Tie Rod - Front	M14x1,5 - L=295.2mm	7701469517; 7701467218
SSP0243 301191602430	Steering Tie Rod - Front		7701469517; 7701467218
SSP0655 301191606550	Steering Tie Rod End - Front Right	M14x1,5Rht	6000022731
SSP0656 301191606560	Steering Tie Rod End - Front Left	M14x1,5Rht	6000022730
SSP1944 301191619440	Suspension Ball Joint - Front Lower	D=Ø16mm - Hole: Ø10,5mm - Ø12,6mm	6001538603; 7701468883; 7701462182
SSP2530 301191625300	Suspension Stabilizer Bar Link - Front Right	L=256mm	8200050191; 8200714448
SSP2531 301191625310	Suspension Stabilizer Bar Link - Front Left	L=256mm	8200040618; 8200714446



RENAULT TWINGO II (CNO)



03/2007-

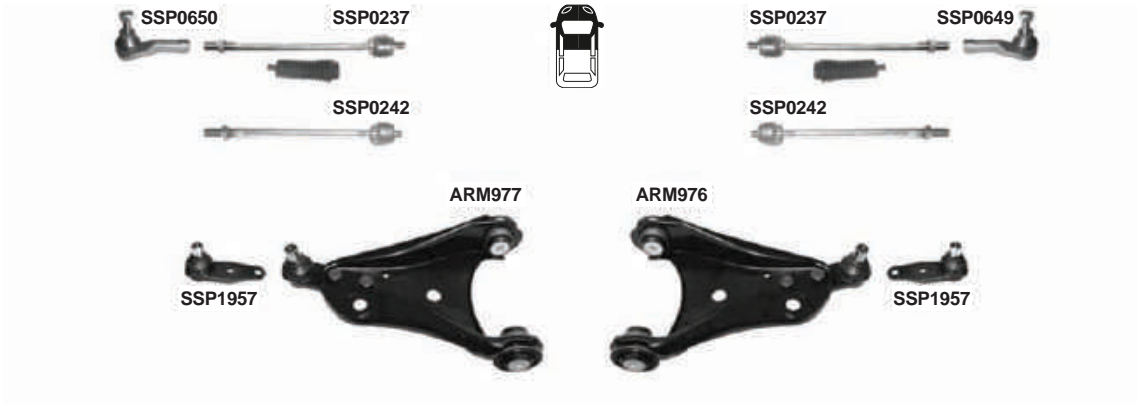

	PART NO.	DESCRIPTION	NOTES	O.E.
ARM976	301181397600	Suspension Control Arm and Ball Joint Assembly - Front Right Lower		8200942396
ARM977	301181397700	Suspension Control Arm and Ball Joint Assembly - Front Left Lower		8200942392
SSP0237	301191602370	Steering Tie Rod - Front Inner	M14x1,5Rht - L=303mm	7701472120*; 7701473655*
SSP0242	301191602420	Steering Tie Rod - Front	M14x1,5 - L=295.2mm	7701469517; 7701467218
SSP0649	301191606490	Steering Tie Rod End - Front Right Outer	M14x1,5Rht.	48520AX602; 7701474493; 7701475843; 7701047813; 7701047416
SSP0650	301191606500	Steering Tie Rod End - Front Left Outer	M14x1,5Rht.	48640AX602; 7701475842; 7701474492; 7701474641; 7701047812; 7701047415
SSP1957	301191619570	Suspension Ball Joint - Front Lower		8200763296

RENAULT VEL SATIS



06/2002-07/2009



PART NO.	DESCRIPTION	NOTES	O.E.
SSP0226 301191602260	Steering Tie Rod - Front	M14x1,5 - L=248,5mm	7701474076; 7701478552
SSP0641 301191606410	Steering Tie Rod End - Front Right	M14x1,5Rht	4408511; 91160044; 7701049283; 4852000QAL
SSP0642 301191606420	Steering Tie Rod End - Front Left	M14x1,5Rht	4408510; 91160043; 7701049282; 4852000QAK
SSP2522 301191625220	Suspension Stabilizer Bar Link - Front	L=279mm	4408904; 8200002870; 546181944R; 5461600QAC
SSP2524 301191625240	Suspension Stabilizer Bar Link - Rear	L=154mm	8200001857; 8200619922



SAAB 9_3 2nd Gen



10/2002-01/2009

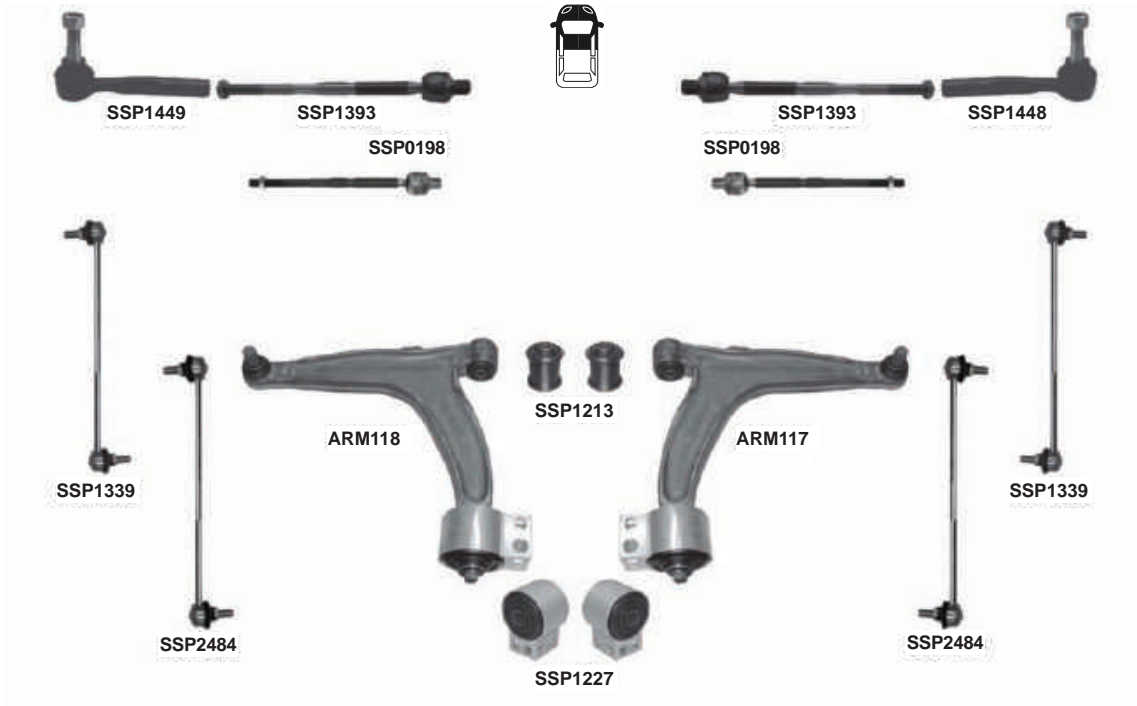

PART NO.	DESCRIPTION	NOTES	O.E.
ARM117 301181311700	Suspension Control Arm and Ball Joint Assembly - Front Right Lower		352052; 51748652; 12799200; 12796014
ARM118 301181311800	Suspension Control Arm and Ball Joint Assembly - Front Left Lower		352051; 51748653; 12799200; 12796013
SSP0198 301191601980	Steering Tie Rod - Front	Only:16,17 Wheel M14x1,5 - L=285mm	12804238; 1603416; 46989683; 1603384; 1603244
SSP1213 301181312130	Bush / Silent block - Track control arm	ARM117 / ARM118 - 1.8i - 1.9 TiD	"352357, 352364, 4566899, 6140350007, 90468636"
SSP1227 301181312270	Bush / Silent block - Track control arm	ARM117 / ARM118 - 1.8i - 1.9 TiD	352319, 93171448
SSP1339 301181313390	Suspension Stabilizer Bar Link - Front	1.8i-1.9 TiD L=352,5mm	24417251; 51741130; 350603
SSP1393 301181313930	Steering Tie Rod - Front Inner	M14x1,5 - L=284mm	1603229; 93172256
SSP1448 301181314480	Steering Tie Rod End - Front Right	M14x1,5Rht	1603228; 5239322; 5235668
SSP1449 301181314490	Steering Tie Rod End - Front Left	M14x1,5Rht	1603227; 5239314; 5235650
SSP2484 301191624840	Suspension Stabilizer Bar Link - Front	1.8i - 1.9 TDI (Clip-on patented design) L=352,5mm	350603; 24417251; 350615



SAAB 9_5 1st Gen YS3E



04/1997-06/2002



SSP1932



SSP1932



SSP2477



SSP2478



SSP2477

SSP2478

PART NO.	DESCRIPTION	NOTES	O.E.
SSP1932 301191619320	Suspension Ball Joint - Front	D=Ø18mm	352800; 5231683; 90512982; 352830; 352829
SSP2477 301191624770	Suspension Stabilizer Bar Link - Front	L=243mm	350610; 90496116; 5236823; 4886606
SSP2478 301191624780	Suspension Stabilizer Bar Link - Front	(Clip-on patented design) L=243mm	350610*; 5236823*; 4886606*



SAAB 9_5 1st Gen YS3E



07/2002-04/2010



PART NO.	DESCRIPTION	NOTES	O.E.
SSP1448 301181314480	Steering Tie Rod End - Front Right	M14x1,5Rht	1603228; 5239322; 5235668
SSP1449 301181314490	Steering Tie Rod End - Front Left	M14x1,5Rht	1603227; 5239314; 5235650



PART NO.	DESCRIPTION	NOTES	O.E.
ARM400 301181340000	Suspension Control Arm - Front Right		25786775
ARM401 301181340100	Suspension Control Arm - Front Left		25786774
SSP1796 301191617960	Suspension Ball Joint - Front Lower	4X4	19133670; 8191336700
SSP2099 301191620990	Suspension Stabilizer Bar Link - Front Right	steel type	15918822
SSP2100 301191621000	Suspension Stabilizer Bar Link - Front Left	steel type	15918823



SATURN ASTRA (H)



2008-2009



PART NO.	DESCRIPTION	NOTES	O.E.
ARM887	301181388700 Suspension Control Arm and Ball Joint Assembly - Front Right Lower		24454478; 352030
ARM888	301181388800 Suspension Control Arm and Ball Joint Assembly - Front Left Lower		24454477; 352029
SSP0195	301191601950 Steering Tie Rod - Front	Trw Steering M14x1,5 - L=280mm	1603213; 9118128; 1603216
SSP0196	301191601960 Steering Tie Rod - Front	Only :ZF-Steering Sport Süsp. 18 ,19 inc Wheel M14x1,5 - L=276mm	1603264; 93189669; 93181230; 1603358
SSP0602	301191606020 Steering Tie Rod End - Front Right	Only: ZF - TRW Steering M14x1,5Rht	1603257; 93181233; 93186332; 1609012; 93179558; 1603288; 1603267
SSP0603	301191606030 Steering Tie Rod End - Front Left	Only: ZF - TRW Steering M14x1,5Rht	1603258; 93181232; 93186333; 1609013; 93179559; 1603289; 1603266
SSP1932	301191619320 Suspension Ball Joint - Front	D=Ø18mm	352800; 5231683; 90512982; 352830; 352829
SSP2481	301191624810 Suspension Stabilizer Bar Link - Front	Plastic L=300mm	350611; 90498745; 350614
SSP2483	301191624830 Suspension Stabilizer Bar Link - Front	Only: IDS Süspansion Sist. L=300mm	24461353; 350613



SATURN VUE



2002-2007



	PART NO.	DESCRIPTION	NOTES	O.E.
ARM373	301181337300	Suspension Control Arm and Ball Joint Assembly - Front Right		25878028
ARM374	301181337400	Suspension Control Arm and Ball Joint Assembly - Front Left		25878029



SCION TC 1st Gen ANT10



2005-2010



SSP2557



SSP2556

PART NO.	DESCRIPTION	NOTES	O.E.
SSP2556 301191625560	Suspension Stabilizer Bar Link - Rear Right		4883021020
SSP2557 301191625570	Suspension Stabilizer Bar Link - Rear Left		4884021010



PART NO.	DESCRIPTION	NOTES	O.E.
ARM997 301181399700	Suspension Control Arm and Ball Joint Assembly - Front Right Lower		4806802130*; 4806812300*
ARM998 301181399800	Suspension Control Arm and Ball Joint Assembly - Front Left Lower		4806902130*; 4806912300*



SCION XB 2nd Gen



2008-2013

**SSP0686****SSP0685****SSP1974****ARM998****ARM997****SSP1974**

	PART NO.	DESCRIPTION	NOTES	O.E.
ARM997	301181399700	Suspension Control Arm and Ball Joint Assembly - Front Right Lower		4806802130*; 4806812300*
ARM998	301181399800	Suspension Control Arm and Ball Joint Assembly - Front Left Lower		4806902130*; 4806912300*
SSP0685	301191606850	Steering Tie Rod End - Front Right		4504609570; 4504619415
SSP0686	301191606860	Steering Tie Rod End - Front Left		4504709570; 4504719215
SSP1974	301191619740	Suspension Ball Joint - Front		4333009630; 4333049095; 4333019245



SEAT ALHAMBRA (7V8,7V9)



04/1996-03/2010

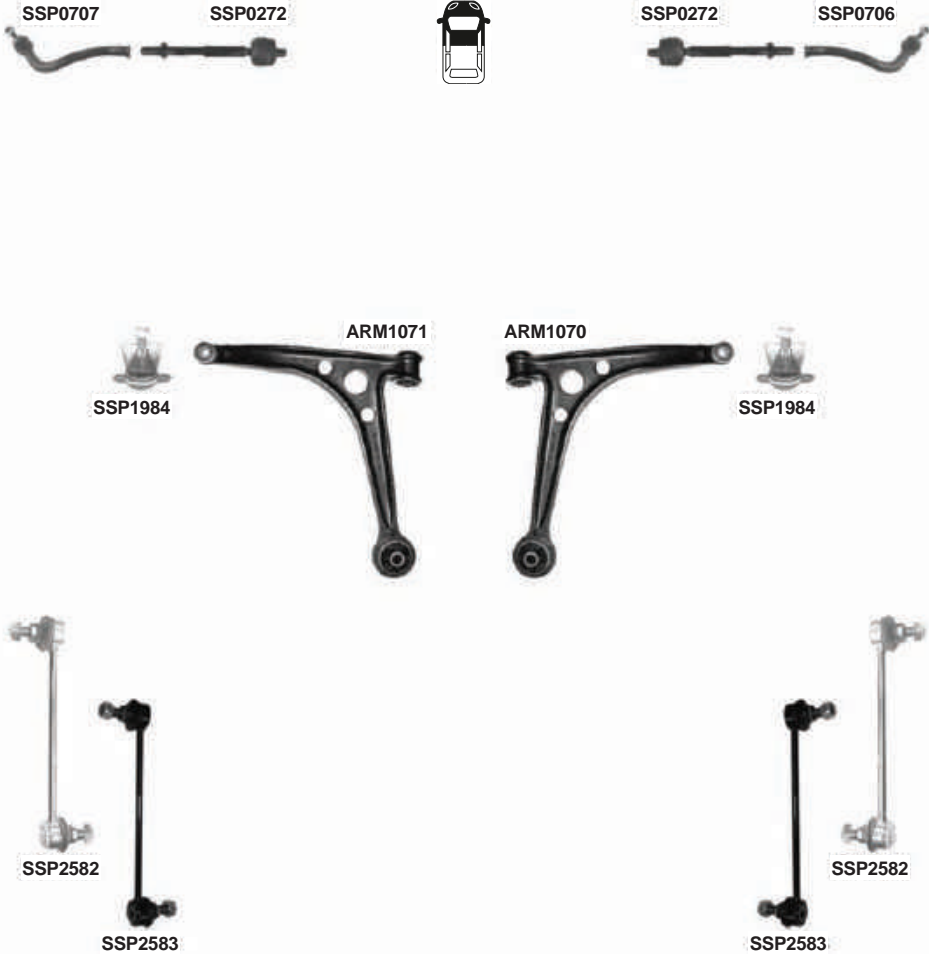

PART NO.	DESCRIPTION	NOTES	O.E.
ARM1070	301181310700 Suspension Control Arm - Front Right Lower		1012632; 95VW3078AC; 7M0407152B
ARM1071	301181310710 Suspension Control Arm - Front Left		1007602; 95VW3079AC; 7M0407151B
SSP0272	301191602720 Steering Tie Rod - Front Inner	M14x1,5 - L=182,5mm	7M0422803/4EF
SSP0706	301191607060 Steering Tie Rod End - Front Right	M14x1,5Rht	1092378; 7M0422818B; 7M0422818
SSP0707	301191607070 Steering Tie Rod End - Front Left	M14x1,5Rht	1092380; 7M0422817B; 7M0422817
SSP1984	301191619840 Suspension Ball Joint - Front		7200946 7M0407365A; YM213395BA; 7M3407365A
SSP2582	301191625820 Suspension Stabilizer Bar Link - Front	L=205mm	1009591; 95VW5489AC; 7M0411317D
SSP2583	301191625830 Suspension Stabilizer Bar Link - Front	Clip-on patented design) L=205mm	1009591*; 95VW5489AC*



SEAT ALTEA V



03/2004-

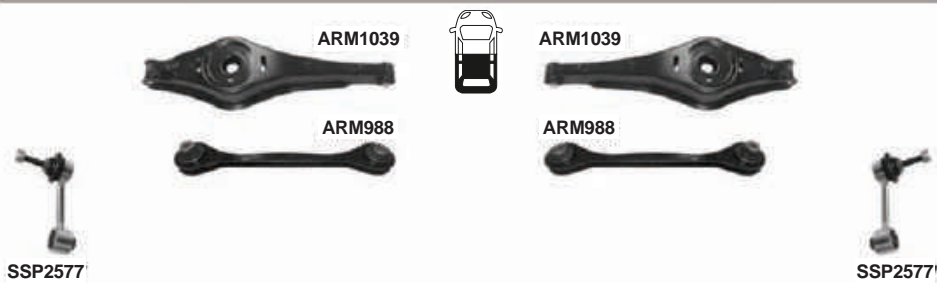



SEAT ALTEA V



03/2004-

PART NO.	DESCRIPTION	NOTES	O.E.
ARM988 301181398800	Lateral Arm - Rear Lower	L=298mm	1K0501529J
ARM1039 301181310390	Lateral Arm - Rear Lower		1K0505311AA; 1K0505311S; 1K0505311AB
ARM1048 301181310480	Suspension Control Arm and Ball Joint Assembly - Front Right Lower	Only: Petrol	1K0407152P*; 1K0407152Q*
ARM1049 301181310490	Suspension Control Arm and Ball Joint Assembly - Front Left Lower	Only: Petrol	1K0407151P*; 1K0407151Q*
ARM1050 301181310500	Suspension Control Arm and Ball Joint Assembly - Front Right Lower	Only: Diesel	1K0407152AC
ARM1051 301181310510	Suspension Control Arm and Ball Joint Assembly - Front Left Lower	Only: Diesel	1K0407151AC
SSP0269 301191602690	Steering Tie Rod - Front Inner	M16x1,5 - L=310mm	1K0423810A
SSP0700 301191607000	Steering Tie Rod End - Front Right	M16x1,5Rht	1K0423812A; 1K0423812J; 1K0423812K; 1K0423812G; 1K0423812E
SSP0701 301191607010	Steering Tie Rod End - Front Left	M16x1,5Rht	1K0423811A; 1K0423811J; 1K0423811K; 1K0423811G; 1K0423811E
SSP1976 301191619760	Suspension Ball Joint - Front Right Lower		1K0407366B; 5Q0407366A; 1K0407366E; 1K0407366C
SSP1977 301191619770	Suspension Ball Joint - Front Left Lower		1K0407365B; 5Q0407365A; 1K0407365E; 1K0407365C
SSP2576 301191625760	Suspension Stabilizer Bar Link - Front	L=335mm	1K0411315B; 1K0411315D; 1K0411315J
SSP2577 301191625770	Suspension Stabilizer Bar Link - Rear	L=95,5 mm	1K0505465C; 1K0505465J; 1K0505465K; 1K0505465H; 1K0505465D



SEAT AROSA



05/1997-06/2004

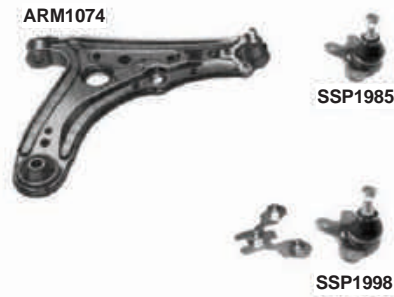
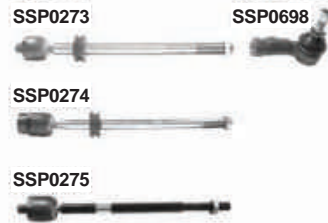



SEAT AROSA



05/1997-06/2004

PART NO.	DESCRIPTION	NOTES	O.E.
ARM1074	301181310740	Suspension Control Arm and Ball Joint Assembly - Front Right Lower	6N0407151*; 6N0407365A*
ARM1075	301181310750	Suspension Control Arm and Ball Joint Assembly - Front Left Lower	6N0407151*; 6N0407365*
SSP0273	301191602730	Steering Tie Rod - Front	Power Steering M14x1,5Rht - L=312,5mm 6N0422803A
SSP0274	301191602740	Steering Tie Rod - Front	Manual Steering M14x1,5Rht - L=306mm 6N0419803
SSP0275	301191602750	Steering Tie Rod - Front	(with PS, Hydro) M14x1,5Rht 6N0422803C/804C
SSP0698	301191606980	Steering Tie Rod End - Front Right	M14x1,5Rht 171419812; 3A0422812; 191419812
SSP0699	301191606990	Steering Tie Rod End - Front Left Outer	M14x1,5Rht 191419811; 3A0422811
SSP1985	301191619850	Suspension Ball Joint - Right	6N0407366
SSP1986	301191619860	Suspension Ball Joint - Front Left Lower	6N0407365
SSP1998	301191619980	Suspension Ball Joint Kit - Front Right	6N0407366*
SSP1999	301191619990	Suspension Ball Joint Kit - Front Left	6N0407365*
SSP2584	301191625840	Suspension Stabilizer Bar Link - Front	L=30 mm - D=Ø18,5mm 6N0411315D
SSP2587	301191625870	Suspension Stabilizer Bar Link - Front	L=30 mm - D=Ø16,5mm 6N0411315



SEAT CORDOBA III



1993-1999

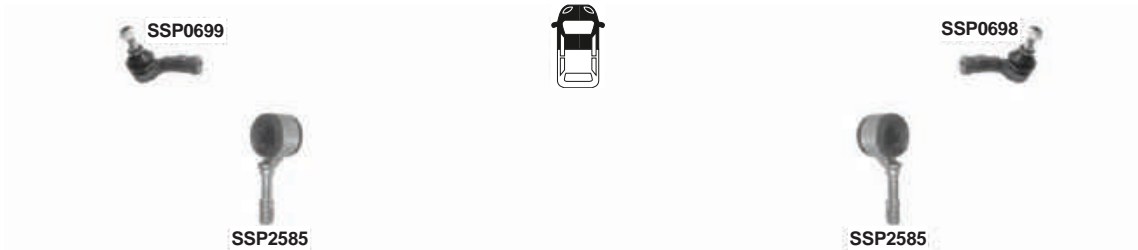

PART NO.	DESCRIPTION	NOTES	O.E.
SSP0698 301191606980	Steering Tie Rod End - Front Right	M14x1,5Rht	171419812; 3A0422812; 191419812
SSP0699 301191606990	Steering Tie Rod End - Front Left Outer	M14x1,5Rht	191419811; 3A0422811
SSP2585 301191625850	Suspension Stabilizer Bar Link - Front	L=78mm - D=Ø18mm	191411315A; 191411327

SEAT CORDOBA (6L2)



09/2002-11/2009

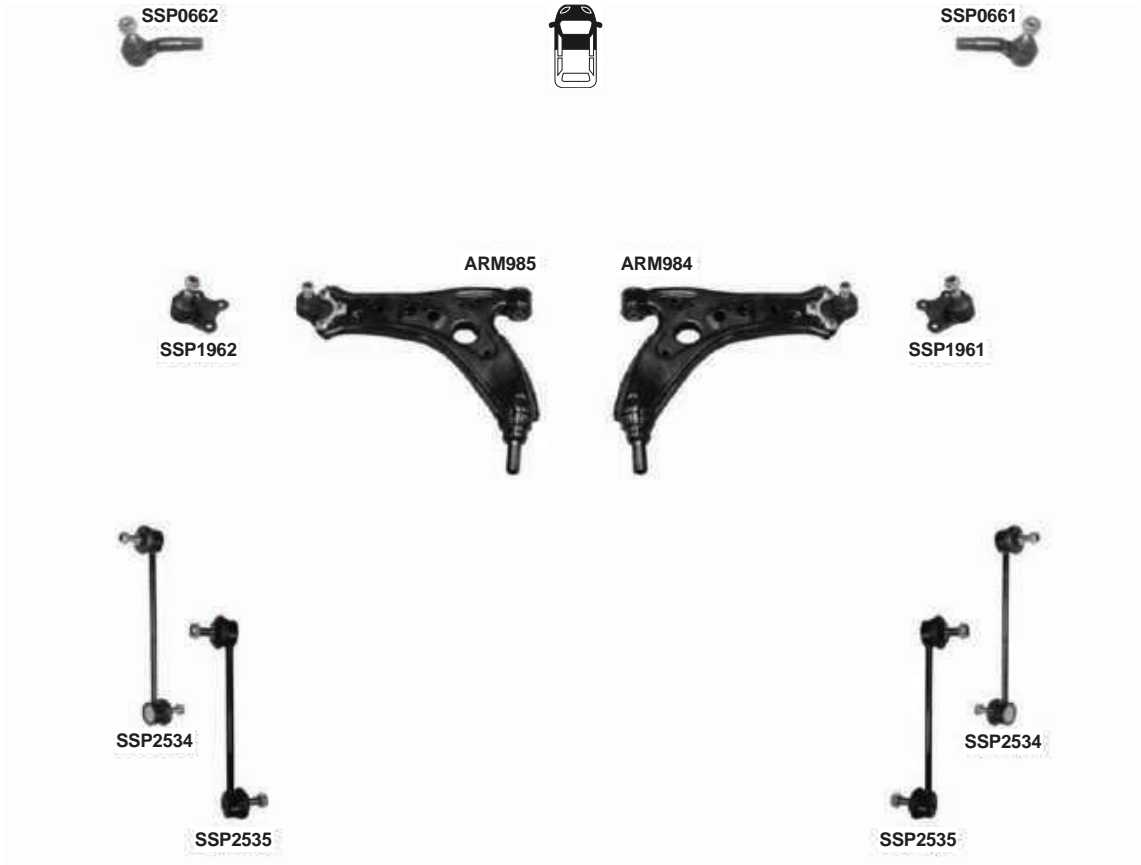

PART NO.	DESCRIPTION	NOTES	O.E.
ARM984	301181398400 Suspension Control Arm and Ball Joint Assembly - Front Right Lower		6Q0407151D*; 6Q0407366A*
ARM985	301181398500 Suspension Control Arm and Ball Joint Assembly - Front Left Lower		6Q0407151D*; 6Q0407365A*
SSP0661	301191606610 Steering Tie Rod End - Front Right	TRW Steering M14x1,5	6RD423812A; 6RD423812B
SSP0662	301191606620 Steering Tie Rod End - Front Left	TRW Steering M14x1,5	6Q0423811A; 6Q0423811C
SSP1961	301191619610 Suspension Ball Joint - Front Right Lower		6Q0407366A; 8Z0407366A
SSP1962	301191619620 Suspension Ball Joint - Front Left Lower		6Q0407365A; 8Z0407365A
SSP2534	301191625340 Suspension Stabilizer Bar Link - Front	L=270mm	6Q0411315A; 6Q0411315F; 6Q0411315D; 6Q0411315C
SSP2535	301191625350 Suspension Stabilizer Bar Link - Front	(Clip-on patented design) L=270mm	6Q0411315A

**SEAT EXEO**

2008-2013



	PART NO.	DESCRIPTION	NOTES	O.E.
ARM186	301181318600	Lateral Arm - Rear	L=337mm	8E0501529F; 8E0501529P; 8E0501529G; 8E0501529K
ARM214	301181321400	Lateral Arm - Rear Right Upper Rearward		8E0505324M; 3R0505324
ARM215	301181321500	Lateral Arm - Rear Left Upper Rearward		8E0505323M; 3R0505323
ARM216	301181321600	Suspension Control Arm and Ball Joint Assembly - Front Right Lower Rearward		8E0407694AL; 8E0407694T
ARM217	301181321700	Suspension Control Arm and Ball Joint Assembly - Front Left Lower Rearward	(Chassis from 8H7000001>)	8E0407693AL; 8E0407693T
SSP2014	301191620140	Suspension Stabilizer Bar Link - Front Right		8E0411318
SSP2015	301191620150	Suspension Stabilizer Bar Link - Front Left		8E0411317



SEAT IBIZA I



06/1984-12/1993



PART NO.	DESCRIPTION	NOTES	O.E.
SSP1361 301181313610	Steering Tie Rod - Front Inner	Manual Steering M12x1,5 - L=276.8mm	5958244; SE022162449S; 7633721
SSP1437 301181314370	Steering Tie Rod End - Front	M12x1,5Rht	5960036; SE022162406A; 7669756; 5960056; 5960037



SEAT IBIZA II



01/1994-08/1999



PART NO.	DESCRIPTION	NOTES	O.E.
SSP0698 301191606980	Steering Tie Rod End - Front Right	M14x1,5Rht	171419812; 3A0422812; 191419812
SSP0699 301191606990	Steering Tie Rod End - Front Left Outer	M14x1,5Rht	191419811; 3A0422811
SSP1361 301181313610	Steering Tie Rod - Front Inner	Manual Steering M12x1,5 - L=276.8mm	5958244; SE022162449S; 7633721
SSP1437 301181314370	Steering Tie Rod End - Front	M12x1,5Rht	5960036; SE022162406A; 7669756; 5960056; 5960037
SSP2585 301191625850	Suspension Stabilizer Bar Link - Front	L=78mm - D=Ø18mm	191411315A; 191411327



	PART NO.	DESCRIPTION	NOTES	O.E.
ARM984	301181398400	Suspension Control Arm and Ball Joint Assembly - Front Right Lower		6Q0407151D*; 6Q0407366A*
ARM985	301181398500	Suspension Control Arm and Ball Joint Assembly - Front Left Lower		6Q0407151D*; 6Q0407365A*
SSP0661	301191606610	Steering Tie Rod End - Front Right	TRW Steering M14x1,5	6RD423812A; 6RD423812B
SSP0662	301191606620	Steering Tie Rod End - Front Left	TRW Steering M14x1,5	6Q0423811A; 6Q0423811C
SSP0663	301191606630	Steering Tie Rod End - Front Right Outer	M14x1,5Rht	6Q0423812; 8Z0423812A; 6Q0423812D
SSP0664	301191606640	Steering Tie Rod End - Front Left Outer	M14x1,5Rht	6Q0423811; 8Z0423811A; 6Q0423811D
SSP1961	301191619610	Suspension Ball Joint - Front Right Lower		6Q0407366A; 8Z0407366A
SSP1962	301191619620	Suspension Ball Joint - Front Left Lower		6Q0407365A; 8Z0407365A
SSP2585	301191625850	Suspension Stabilizer Bar Link - Front	L=78mm - D=Ø18mm	191411315A; 191411327

**SEAT IBIZA IV**

03/2008-



PART NO.	DESCRIPTION	NOTES	O.E.
ARM986	301181398600 Suspension Control Arm and Ball Joint Assembly - Front Right Lower		6R0407152**
ARM987	301181398700 Suspension Control Arm and Ball Joint Assembly - Front Left Lower		6E0407151**
SSP0276	301191602760 Steering Tie Rod - Front	M14x1,5 - L=313mm	6R0423810; 8Z0419810C
SSP0663	301191606630 Steering Tie Rod End - Front Right Outer	M14x1,5Rht	6Q0423812; 8Z0423812A; 6Q0423812D
SSP0664	301191606640 Steering Tie Rod End - Front Left Outer	M14x1,5Rht	6Q0423811; 8Z0423811A; 6Q0423811D
SSP1963	301191619630 Suspension Ball Joint - Front Right Lower		5U0407366A; 6R0407366
SSP1964	301191619640 Suspension Ball Joint - Front Left Lower		5U0407365A; 6R0407365
SSP2534	301191625340 Suspension Stabilizer Bar Link - Front	L=270mm	6Q0411315A; 6Q0411315F; 6Q0411315D; 6Q0411315C
SSP2535	301191625350 Suspension Stabilizer Bar Link - Front	(Clip-on patented design) L=270mm	6Q0411315A



SEAT LEON 1M1



03/1999-05/2006

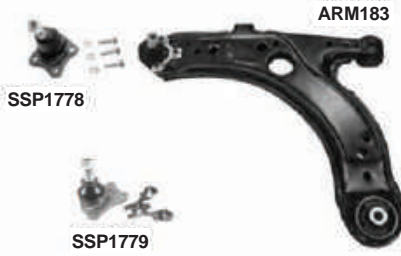

**SEAT LEON 1M1**

03/1999-05/2006

	PART NO.	DESCRIPTION	NOTES	O.E.
ARM169	301181316900	Lateral Arm - Rear		1J0505323L; 1J0505323E; 1J0505323H; 1J0505323M
ARM182	301181318200	Suspension Control Arm and Ball Joint Assembly - Front Right Lower		1J0407151B
ARM183	301181318300	Suspension Control Arm and Ball Joint Assembly - Front Left Lower		1J0407151A
SSP0003	301191600030	Steering Tie Rod - Front Inner	- Ch.8L-W-050-423 -> M14x1,5 - L=320mm	1J0422807; 1J0422807A
SSP0283	301191602830	Steering Tie Rod End - Front Right	M14x1,5 Rht	1J0422812B; 6R0423812A; 6Q0419812; 1J0422812R; 3A0422812B
SSP0284	301191602840	Steering Tie Rod End - Front Left	M14x1,5 Rht	1J0422811B; 6R0423811A; 6Q0419811; 1J0422811R; 3A0422811B
SSP1775	301191617750	Suspension Ball Joint - Front Lower	Seat Leon 1.8T Cupra	8N0407365A; 8N0407365B; 8N0407365C
SSP1776	301191617760	Suspension Ball Joint - Front Right Lower		1J0407366A; 1J0407366B; 1J0407366C
SSP1777	301191617770	Suspension Ball Joint - Front Right Lower	Kit	1J0407366A/B/C*
SSP1778	301191617780	Suspension Ball Joint - Front Left Lower		1J0407365A; 1J0407365D; 1J0407365B; 1J0407365C
SSP1779	301191617790	Suspension Ball Joint - Front Left Lower	Kit	1J0407366A/B/C*
SSP2002	301191620020	Suspension Stabilizer Bar Link - Front Left	L=336mm	1J0411315D
SSP2004	301191620040	Suspension Stabilizer Bar Link - Front Right	L=336mm	1J0411316D
SSP2571	301191625710	Suspension Stabilizer Bar Link - Front	Plastic L=105,5mm	1J0411315C



SEAT LEON 1P1



2006-2012





SEAT LEON 1P1



2006-2012

PART NO.	DESCRIPTION	NOTES	O.E.
ARM982	301181398200 Lateral Arm - Rear Right Lower	Toledo L=298mm	1K0501530C
ARM983	301181398300 Lateral Arm - Rear Left Lower	Toledo L=298mm	1K0501529F
ARM988	301181398800 Lateral Arm - Rear Lower	L=298mm	1K0501529J
ARM989	301181398900 Suspension Control Arm and Ball Joint Assembly - Front Right Lower		1K0407152BC*
ARM990	301181399000 Suspension Control Arm and Ball Joint Assembly - Front Left Lower		1K0407151BC*
ARM1039	301181310390 Lateral Arm - Rear Lower		1K0505311AA; 1K0505311S; 1K0505311AB
SSP0269	301191602690 Steering Tie Rod - Front Inner	M16x1,5 - L=310mm	1K0423810A
SSP0700	301191607000 Steering Tie Rod End - Front Right	M16x1,5Rht	1K0423812A; 1K0423812J; 1K0423812K; 1K0423812G; 1K0423812E
SSP0701	301191607010 Steering Tie Rod End - Front Left	M16x1,5Rht	1K0423811A; 1K0423811J; 1K0423811K; 1K0423811G; 1K0423811E
SSP1976	301191619760 Suspension Ball Joint - Front Right Lower		1K0407366B; 5Q0407366A; 1K0407366E; 1K0407366C
SSP1977	301191619770 Suspension Ball Joint - Front Left Lower		1K0407365B; 5Q0407365A; 1K0407365E; 1K0407365C
SSP2576	301191625760 Suspension Stabilizer Bar Link - Front	L=335mm	1K0411315B; 1K0411315D; 1K0411315J
SSP2577	301191625770 Suspension Stabilizer Bar Link - Rear	L=95,5 mm	1K0505465C; 1K0505465J; 1K0505465K; 1K0505465H; 1K0505465D



SEAT LEON (5F1)



12/2012-





SEAT LEON (5F1)



12/2012-

	PART NO.	DESCRIPTION	NOTES	O.E.
ARM989	301181398900	Suspension Control Arm and Ball Joint Assembly - Front Right Lower		1K0407152BC*
ARM990	301181399000	Suspension Control Arm and Ball Joint Assembly - Front Left Lower		1K0407151BC*
ARM1039	301181310390	Lateral Arm - Rear Lower		1K0505311AA; 1K0505311S; 1K0505311AB
ARM1056	301181310560	Lateral Arm - Rear Lower Forward		5Q0501529C
ARM1057	301181310570	Lateral Arm - Rear Upper		5Q0505323C; 5Q0505323D
SSP0269	301191602690	Steering Tie Rod - Front Inner	M16x1,5 - L=310mm	1K0423810A
SSP0700	301191607000	Steering Tie Rod End - Front Right	M16x1,5Rht	1K0423812A; 1K0423812J; 1K0423812K; 1K0423812G; 1K0423812E
SSP0701	301191607010	Steering Tie Rod End - Front Left	M16x1,5Rht	1K0423811A; 1K0423811J; 1K0423811K; 1K0423811G; 1K0423811E
SSP1976	301191619760	Suspension Ball Joint - Front Right Lower		1K0407366B; 5Q0407366A; 1K0407366E; 1K0407366C
SSP1977	301191619770	Suspension Ball Joint - Front Left Lower		1K0407365B; 5Q0407365A; 1K0407365E; 1K0407365C
SSP2576	301191625760	Suspension Stabilizer Bar Link - Front	L=335mm	1K0411315B; 1K0411315D; 1K0411315J
SSP2577	301191625770	Suspension Stabilizer Bar Link - Rear	L=95,5 mm	1K0505465C; 1K0505465J; 1K0505465K; 1K0505465H; 1K0505465D
SSP2579	301191625790	Suspension Stabilizer Bar Link - Rear	L=70mm	5Q0505465C; 5Q0505465A



SEAT MARBELLA



1986-1992



PART NO.	DESCRIPTION	NOTES	O.E.
ARM149 301181314900	Suspension Control Arm and Ball Joint Assembly - Front Upper		4408138; SE028140104A*; 5995503
SSP1379 301181313790	Steering Tie Rod - Front	M14x1 - L=142mm	4318655



SEAT MARBELLA



1992-1998

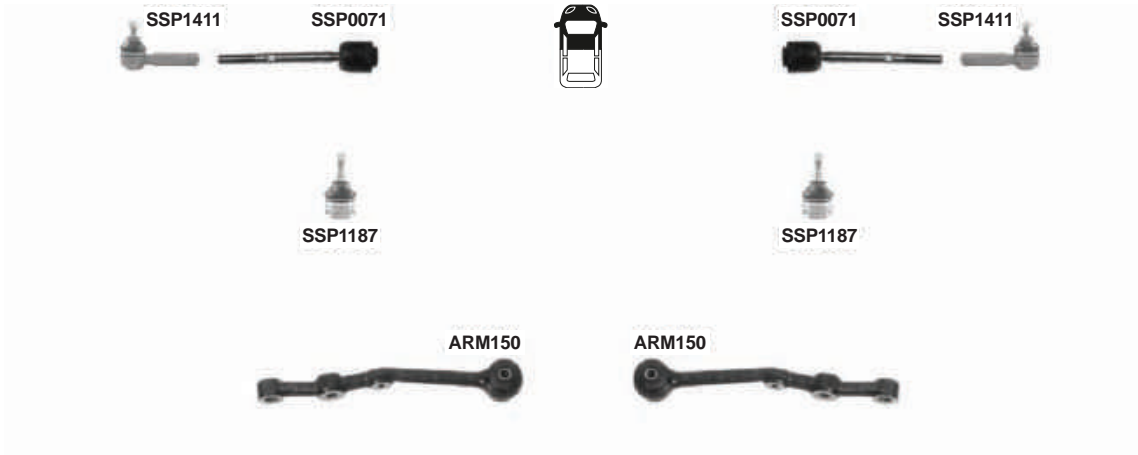

	PART NO.	DESCRIPTION	NOTES	O.E.
ARM150	301181315000	Suspension Control Arm - Front Lower		4402672; SE141156110A; 7601261
SSP0071	301191600710	Steering Tie Rod - Front	M12x1,5 - L=192mm	5960321; SE141162449A
SSP1187	301181311870	Suspension Ball Joint - Front Upper		4402644; SE141140104A; 4402649
SSP1411	301181314110	Steering Tie Rod End - Front	M12x1,5Rht	5960835; SE141162410A



SEAT Mii (KYF)



10/2011-



SSP0703

SSP0270



SSP0270

SSP0702



ARM1053

SSP1964



ARM1052

SSP1963



SSP2534



SSP2534

	PART NO.	DESCRIPTION	NOTES	O.E.
ARM1052	301181310520	Suspension Control Arm and Ball Joint Assembly - Front Right Lower		1S0407152*
ARM1053	301181310530	Suspension Control Arm and Ball Joint Assembly - Front Left Lower		1S0407151*
SSP0270	301191602700	Steering Tie Rod - Front	M14X1,5 - L=306mm	1S0423810A
SSP0702	301191607020	Steering Tie Rod End - Front Right	M16x1,5Rht	1S0423812A
SSP0703	301191607030	Steering Tie Rod End - Front Left	M16x1,5Rht	1S0423811A
SSP1963	301191619630	Suspension Ball Joint - Front Right Lower		5U0407366A; 6R0407366
SSP1964	301191619640	Suspension Ball Joint - Front Left Lower		5U0407365A; 6R0407365
SSP2534	301191625340	Suspension Stabilizer Bar Link - Front	L=270mm	6Q0411315A; 6Q0411315F; 6Q0411315D; 6Q0411315C



SEAT RONDA



1982-1988

SSP1437

SSP0071



SSP0071

SSP1437



PART NO.	DESCRIPTION	NOTES	O.E.
SSP0071 301191600710	Steering Tie Rod - Front	M12x1,5 - L=192mm	5960321; SE141162449A
SSP1437 301181314370	Steering Tie Rod End - Front	M12x1,5Rht	5960036; SE022162406A; 7669756; 5960056; 5960037



SEAT TERRA



1984-1990



SSP1437



PART NO.	DESCRIPTION	NOTES	O.E.
SSP1437 301181314370	Steering Tie Rod End - Front	M12x1,5Rht	5960036; SE022162406A; 7669756; 5960056; 5960037

**SEAT TOLEDO I (1L) - CORDOBA - IBIZA III**  **1993-1999****SSP0699****SSP2585****SSP0698****SSP2585**

	PART NO.	DESCRIPTION	NOTES	O.E.
SSP0698	301191606980	Steering Tie Rod End - Front Right	M14x1,5Rht	171419812; 3A0422812; 191419812
SSP0699	301191606990	Steering Tie Rod End - Front Left Outer	M14x1,5Rht	191419811; 3A0422811
SSP2585	301191625850	Suspension Stabilizer Bar Link - Front	L=78mm - D=Ø18mm	191411315A; 191411327

SEAT TOLEDO II (1M2)



03/1999-05/2006



PART NO.	DESCRIPTION	NOTES	O.E.
ARM182	301181318200	Suspension Control Arm and Ball Joint Assembly - Front Right Lower	1J0407151B
ARM183	301181318300	Suspension Control Arm and Ball Joint Assembly - Front Left Lower	1J0407151A
SSP0003	301191600030	Steering Tie Rod - Front Inner	- Ch.8L-W-050-423 -> M14x1,5 - L=320mm 1J0422807; 1J0422807A
SSP0283	301191602830	Steering Tie Rod End - Front Right	M14x1,5 Rht 1J0422812B; 6R0423812A; 6Q0419812; 1J0422812R; 3A0422812B
SSP0284	301191602840	Steering Tie Rod End - Front Left	M14x1,5 Rht 1J0422811B; 6R0423811A; 6Q0419811; 1J0422811R; 3A0422811B
SSP1775	301191617750	Suspension Ball Joint - Front Lower	Seat Leon 1.8T Cupra 8N0407365A; 8N0407365B; 8N0407365C
SSP1776	301191617760	Suspension Ball Joint - Front Right Lower	1J0407366A; 1J0407366B; 1J0407366C
SSP1777	301191617770	Suspension Ball Joint - Front Right Lower	Kit 1J0407366A/B/C*
SSP1778	301191617780	Suspension Ball Joint - Front Left Lower	1J0407365A; 1J0407365D; 1J0407365B; 1J0407365C
SSP1779	301191617790	Suspension Ball Joint - Front Left Lower	Kit 1J0407366A/B/C*
SSP2002	301191620020	Suspension Stabilizer Bar Link - Front Left	L=336mm 1J0411315D
SSP2003	301191620030	Suspension Stabilizer Bar Link - Front Left	(Clip-on patented design) L=336mm 1J0411315D
SSP2004	301191620040	Suspension Stabilizer Bar Link - Front Right	L=336mm 1J0411316D
SSP2571	301191625710	Suspension Stabilizer Bar Link - Front	Plastic L=105,5mm 1J0411315C

**SEAT TOLEDO III (5P2)**

07/2006-05/2009



	PART NO.	DESCRIPTION	NOTES	O.E.
ARM982	301181398200	Lateral Arm - Rear Right Lower	Toledo L=298mm	1K0501530C
ARM983	301181398300	Lateral Arm - Rear Left Lower	Toledo L=298mm	1K0501529F
ARM988	301181398800	Lateral Arm - Rear Lower	L=298mm	1K0501529J
ARM989	301181398900	Suspension Control Arm and Ball Joint Assembly - Front Right Lower		1K0407152BC*
ARM990	301181399000	Suspension Control Arm and Ball Joint Assembly - Front Left Lower		1K0407151BC*
ARM1039	301181310390	Lateral Arm - Rear Lower		1K0505311AA; 1K0505311S; 1K0505311AB
SSP0269	301191602690	Steering Tie Rod - Front Inner	M16x1,5 - L=310mm	1K0423810A
SSP0700	301191607000	Steering Tie Rod End - Front Right	M16x1,5Rht	1K0423812A; 1K0423812J; 1K0423812K; 1K0423812G; 1K0423812E
SSP0701	301191607010	Steering Tie Rod End - Front Left	M16x1,5Rht	1K0423811A; 1K0423811J; 1K0423811K; 1K0423811G; 1K0423811E
SSP1976	301191619760	Suspension Ball Joint - Front Right Lower		1K0407366B; 5Q0407366A; 1K0407366E; 1K0407366C
SSP1977	301191619770	Suspension Ball Joint - Front Left Lower		1K0407365B; 5Q0407365A; 1K0407365E; 1K0407365C
SSP2576	301191625760	Suspension Stabilizer Bar Link - Front	L=335mm	1K0411315B; 1K0411315D; 1K0411315J
SSP2577	301191625770	Suspension Stabilizer Bar Link - Rear	L=95,5 mm	1K0505465C; 1K0505465J; 1K0505465K; 1K0505465H; 1K0505465D



SKODA FABIA (6Y2)



08/1999-11/2006



SSP0664



SSP0663



SSP0247



SSP0247



SSP1962



ARM985



ARM984



SSP1961



SSP2534

SSP2535



SSP2534

SSP2535



SKODA FABIA (6Y2)



08/1999-11/2006

	PART NO.	DESCRIPTION	NOTES	O.E.
ARM984	301181398400	Suspension Control Arm and Ball Joint Assembly - Front Right Lower		6Q0407151D*; 6Q0407366A*
ARM985	301181398500	Suspension Control Arm and Ball Joint Assembly - Front Left Lower		6Q0407151D*; 6Q0407365A*
SSP0247	301191602470	Steering Tie Rod - Front	manual steering	6Q0419803B; 6Q0419804F; 6Q0419804B; 6Q0419804D; 6Q0419803F; 6Q0419803D
SSP0663	301191606630	Steering Tie Rod End - Front Right Outer	M14x1,5Rht	6Q0423812; 8Z0423812A; 6Q0423812D
SSP0664	301191606640	Steering Tie Rod End - Front Left Outer	M14x1,5Rht	6Q0423811; 8Z0423811A; 6Q0423811D
SSP1961	301191619610	Suspension Ball Joint - Front Right Lower		6Q0407366A; 8Z0407366A
SSP1962	301191619620	Suspension Ball Joint - Front Left Lower		6Q0407365A; 8Z0407365A
SSP2534	301191625340	Suspension Stabilizer Bar Link - Front	L=270mm	6Q0411315A; 6Q0411315F; 6Q0411315D; 6Q0411315C
SSP2535	301191625350	Suspension Stabilizer Bar Link - Front	(Clip-on patented design) L=270mm	6Q0411315A

SKODA FABIA (5J)



12/2006-09/2014

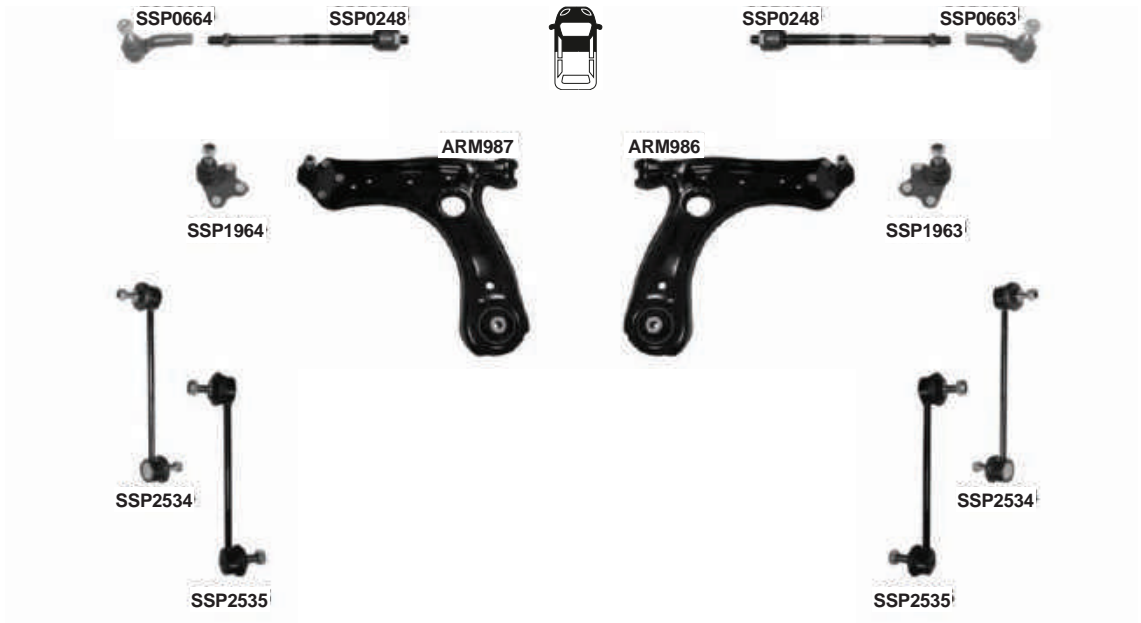

PART NO.	DESCRIPTION	NOTES	O.E.
ARM986	301181398600 Suspension Control Arm and Ball Joint Assembly - Front Right Lower		6R0407152**
ARM987	301181398700 Suspension Control Arm and Ball Joint Assembly - Front Left Lower		6E0407151**
SSP0248	301191602480 Steering Tie Rod - Front	M14x1,5 - L=297mm	6Q0423810C
SSP0663	301191606630 Steering Tie Rod End - Front Right Outer	M14x1,5Rht	6Q0423812; 8Z0423812A; 6Q0423812D
SSP0664	301191606640 Steering Tie Rod End - Front Left Outer	M14x1,5Rht	6Q0423811; 8Z0423811A; 6Q0423811D
SSP1963	301191619630 Suspension Ball Joint - Front Right Lower		5U0407366A; 6R0407366
SSP1964	301191619640 Suspension Ball Joint - Front Left Lower		5U0407365A; 6R0407365
SSP2534	301191625340 Suspension Stabilizer Bar Link - Front	L=270mm	6Q0411315A; 6Q0411315F; 6Q0411315D; 6Q0411315C
SSP2535	301191625350 Suspension Stabilizer Bar Link - Front	(Clip-on patented design) L=270mm	6Q0411315A

**SKODA KODIAQ (NS7)**

2016-



PART NO.	DESCRIPTION	NOTES	O.E.
ARM1066 301181310660	Suspension Control Arm and Ball Joint Assembly - Front Right Lower		3Q0407152E; 3Q0407152F
ARM1067 301181310670	Suspension Control Arm and Ball Joint Assembly - Front Left Lower		3Q0407151E; 3Q0407151F
SSP0268 301191602680	Steering Tie Rod - Front Inner		561423810
SSP0700 301191607000	Steering Tie Rod End - Front Right	M16x1,5Rht	1K0423812A; 1K0423812J; 1K0423812K; 1K0423812G; 1K0423812E
SSP0701 301191607010	Steering Tie Rod End - Front Left	M16x1,5Rht	1K0423811A; 1K0423811J; 1K0423811K; 1K0423811G; 1K0423811E
SSP2576 301191625760	Suspension Stabilizer Bar Link - Front	L=335mm	1K0411315B; 1K0411315D; 1K0411315J
SSP2579 301191625790	Suspension Stabilizer Bar Link - Rear	L=70mm	5Q0505465C; 5Q0505465A



SKODA OCTAVIA (1U2), (1U5)



07/1996-05/2004



**MAGNETI
MARELLI**

SKODA OCTAVIA (1U2), (1U5)



07/1996-05/2004

PART NO.	DESCRIPTION	NOTES	O.E.
ARM169	301181316900 Lateral Arm - Rear		1J0505323L; 1J0505323E; 1J0505323H; 1J0505323M
ARM182	301181318200 Suspension Control Arm and Ball Joint Assembly - Front Right Lower		1J0407151B
ARM183	301181318300 Suspension Control Arm and Ball Joint Assembly - Front Left Lower		1J0407151A
SSP0003	301191600030 Steering Tie Rod - Front Inner	- Ch.8L-W-050-423 -> M14x1,5 - L=320mm	1J0422807; 1J0422807A
SSP0005	301191600050 Steering Tie Rod - Front	L=338mm Ch.No.-> 8L-W-050-422 M14x1,5 Rht	1J0422821A
SSP0283	301191602830 Steering Tie Rod End - Front Right	Ch.8L-W-050-423 -> M14x1,5 Rht	1J0422812B; 6R0423812A; 6Q0419812; 1J0422812R; 3A0422812B
SSP0284	301191602840 Steering Tie Rod End - Front Left	Ch.8L-W-050-423 -> M14x1,5 Rht	1J0422811B; 6R0423811A; 6Q0419811; 1J0422811R; 3A0422811B
SSP0285	301191602850 Steering Tie Rod End - Front Right Outer	Ch. >>8L-W-050-422 M14x1,5 Rht	1J0422812A; 1J0422812L
SSP0286	301191602860 Steering Tie Rod End - Front Left Outer	Ch. >>8L-W-050-422 M14x1,5 Rht	1J0422811A; 1J0422811L
SSP1776	301191617760 Suspension Ball Joint - Front Right Lower		1J0407366A; 1J0407366B; 1J0407366C
SSP1777	301191617770 Suspension Ball Joint - Front Right Lower	Kit	1J0407366A/B/C*
SSP1778	301191617780 Suspension Ball Joint - Front Left Lower		1J0407365A; 1J0407365D; 1J0407365B; 1J0407365C
SSP1779	301191617790 Suspension Ball Joint - Front Left Lower	Kit	1J0407366A/B/C*
SSP2571	301191625710 Suspension Stabilizer Bar Link - Front	Plastic L=105,5mm	1J0411315C
SSP2572	301191625720 Suspension Stabilizer Bar Link - Front	Metal L=105mm	1J0411315H; 1J0422315G



SKODA OCTAVIA (1Z3), (1Z5)



06/2004-10/2012



**SKODA OCTAVIA (1Z3), (1Z5)**

06/2004-10/2012

PART NO.	DESCRIPTION	NOTES	O.E.
ARM189	301181318900 Lateral Arm - Rear Upper		1K0505323N
ARM982	301181398200 Lateral Arm - Rear Right Lower	L=298mm	1K0501530C
ARM983	301181398300 Lateral Arm - Rear Left Lower	L=298mm	1K0501529F
ARM1039	301181310390 Lateral Arm - Rear Lower		1K0505311AA; 1K0505311S; 1K0505311AB
ARM1048	301181310480 Suspension Control Arm and Ball Joint Assembly - Front Right Lower	Only: Petrol	1K0407152P*; 1K0407152Q*
ARM1049	301181310490 Suspension Control Arm and Ball Joint Assembly - Front Left Lower	Only: Petrol	1K0407151P*; 1K0407151Q*
ARM1050	301181310500 Suspension Control Arm and Ball Joint Assembly - Front Right Lower	Only: Diesel	1K0407152AC
ARM1051	301181310510 Suspension Control Arm and Ball Joint Assembly - Front Left Lower	Only: Diesel	1K0407151AC
SSP0269	301191602690 Steering Tie Rod - Front Inner	M16x1,5 - L=310mm	1K0423810A
SSP0700	301191607000 Steering Tie Rod End - Front Right	M16x1,5Rht	1K0423812A; 1K0423812J; 1K0423812K; 1K0423812G; 1K0423812E
SSP0701	301191607010 Steering Tie Rod End - Front Left	M16x1,5Rht	1K0423811A; 1K0423811J; 1K0423811K; 1K0423811G; 1K0423811E
SSP1976	301191619760 Suspension Ball Joint - Front Right Lower		1K0407366B; 5Q0407366A; 1K0407366E; 1K0407366C
SSP1977	301191619770 Suspension Ball Joint - Front Left Lower		1K0407365B; 5Q0407365A; 1K0407365E; 1K0407365C
SSP2576	301191625760 Suspension Stabilizer Bar Link - Front	L=335mm	1K0411315B; 1K0411315D; 1K0411315J
SSP2577	301191625770 Suspension Stabilizer Bar Link - Rear	L=95,5 mm	1K0505465C; 1K0505465J; 1K0505465K; 1K0505465H; 1K0505465D



SKODA OCTAVIA (5 E)



11/2012-



ARM1057



ARM1057



PART NO.	DESCRIPTION	NOTES	O.E.
ARM167	301181316700 Suspension Control Arm and Ball Joint Assembly - Front Right Lower		5Q0407152J
ARM168	301181316800 Suspension Control Arm and Ball Joint Assembly - Front Left Lower		5Q0407151J
ARM1057	301181310570 Lateral Arm - Rear Upper		5Q0505323C; 5Q0505323D
SSP0269	301191602690 Steering Tie Rod - Front Inner	M16x1,5 - L=310mm	1K0423810A
SSP0700	301191607000 Steering Tie Rod End - Front Right	M16x1,5Rht	1K0423812A; 1K0423812J; 1K0423812K; 1K0423812G; 1K0423812E
SSP0701	301191607010 Steering Tie Rod End - Front Left	M16x1,5Rht	1K0423811A; 1K0423811J; 1K0423811K; 1K0423811G; 1K0423811E
SSP1976	301191619760 Suspension Ball Joint - Front Right Lower		1K0407366B; 5Q0407366A; 1K0407366E; 1K0407366C
SSP1977	301191619770 Suspension Ball Joint - Front Left Lower		1K0407365B; 5Q0407365A; 1K0407365E; 1K0407365C
SSP2537	301191625370 Suspension Stabilizer Bar Link - Front	L-335mm	500411315B



SKODA PRAKTIK



03/2007-



	PART NO.	DESCRIPTION	NOTES	O.E.
ARM986	301181398600	Suspension Control Arm and Ball Joint Assembly - Front Right Lower		6R0407152**
ARM987	301181398700	Suspension Control Arm and Ball Joint Assembly - Front Left Lower		6E0407151**
SSP0248	301191602480	Steering Tie Rod - Front	M14x1,5 - L=297mm	6Q0423810C
SSP0663	301191606630	Steering Tie Rod End - Front Right Outer	M14x1,5Rht	6Q0423812; 8Z0423812A; 6Q0423812D
SSP0664	301191606640	Steering Tie Rod End - Front Left Outer	M14x1,5Rht	6Q0423811; 8Z0423811A; 6Q0423811D
SSP1963	301191619630	Suspension Ball Joint - Front Right Lower		5U0407366A; 6R0407366
SSP1964	301191619640	Suspension Ball Joint - Front Left Lower		5U0407365A; 6R0407365
SSP2534	301191625340	Suspension Stabilizer Bar Link - Front	L=270mm	6Q0411315A; 6Q0411315F; 6Q0411315D; 6Q0411315C

SKODA RAPID



07/2012-

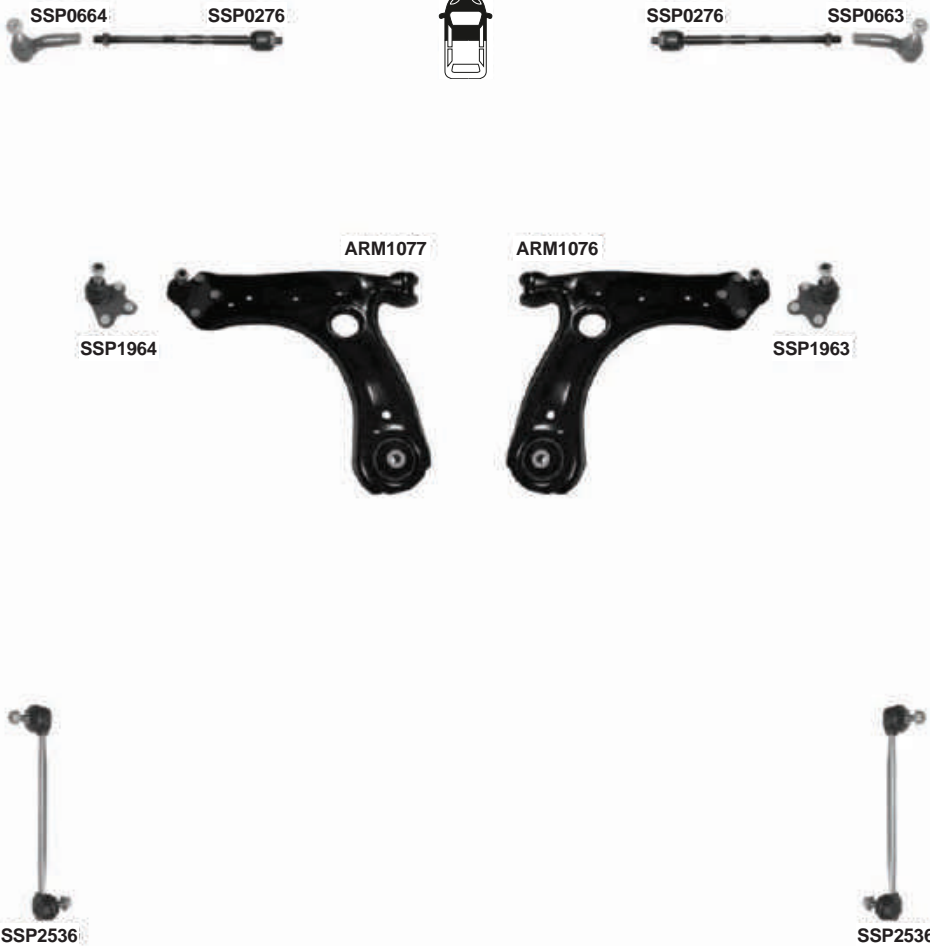

PART NO.	DESCRIPTION	NOTES	O.E.
ARM1076	301181310760 Suspension Control Arm and Ball Joint Assembly - Front Right Lower		6R0407152A**; 6R0407152F**
ARM1077	301181310770 Suspension Control Arm and Ball Joint Assembly - Front Left Lower		6R0407151A**; 6R0407151F**
SSP0276	301191602760 Steering Tie Rod - Front	M14x1,5 - L=313mm	6R0423810; 8Z0419810C
SSP0663	301191606630 Steering Tie Rod End - Front Right Outer	M14x1,5Rht	6Q0423812; 8Z0423812A; 6Q0423812D
SSP0664	301191606640 Steering Tie Rod End - Front Left Outer	M14x1,5Rht	6Q0423811; 8Z0423811A; 6Q0423811D
SSP1963	301191619630 Suspension Ball Joint - Front Right Lower		5U0407366A; 6R0407366
SSP1964	301191619640 Suspension Ball Joint - Front Left Lower		5U0407365A; 6R0407365
SSP2536	301191625360 Suspension Stabilizer Bar Link - Front	L=270mm	6R0411315



SKODA ROOMSTER (5J)



07/2006-

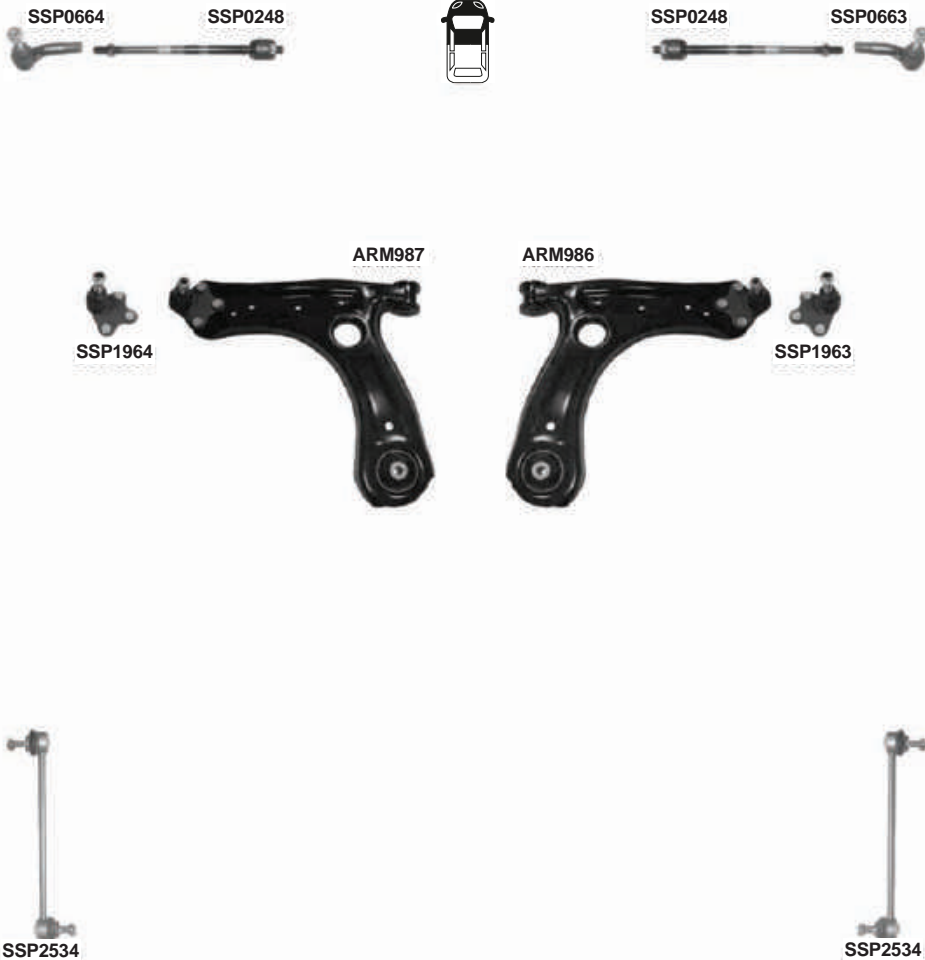

	PART NO.	DESCRIPTION	NOTES	O.E.
ARM986	301181398600	Suspension Control Arm and Ball Joint Assembly - Front Right Lower		6R0407152**
ARM987	301181398700	Suspension Control Arm and Ball Joint Assembly - Front Left Lower		6E0407151**
SSP0248	301191602480	Steering Tie Rod - Front	M14x1,5 - L=297mm	6Q0423810C
SSP0663	301191606630	Steering Tie Rod End - Front Right Outer	M14x1,5Rht	6Q0423812; 8Z0423812A; 6Q0423812D
SSP0664	301191606640	Steering Tie Rod End - Front Left Outer	M14x1,5Rht	6Q0423811; 8Z0423811A; 6Q0423811D
SSP1963	301191619630	Suspension Ball Joint - Front Right Lower		5U0407366A; 6R0407366
SSP1964	301191619640	Suspension Ball Joint - Front Left Lower		5U0407365A; 6R0407365
SSP2534	301191625340	Suspension Stabilizer Bar Link - Front	L=270mm	6Q0411315A; 6Q0411315F; 6Q0411315D; 6Q0411315C



SKODA SUPERB (3U4)



02/2002-03/2008

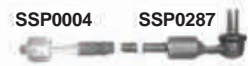

ARM173



ARM171



ARM177



ARM175



ARM179



ARM178



ARM180



ARM180



SSP2008



SSP2007

PART NO.	DESCRIPTION	NOTES	O.E.
ARM171 301181317100	Suspension Control Arm and Ball Joint Assembly - Front Right Upper Rearward		4D0407510F; 4D0407510G
ARM173 301181317300	Suspension Control Arm and Ball Joint Assembly - Front Left Upper Rearward		4D0407509F; 4D0407509G
ARM175 301181317500	Suspension Control Arm and Ball Joint Assembly - Front Right Upper Forward		8D0407506A; 8E0407506A; 8D0407506B; 8D0407506F
ARM177 301181317700	Suspension Control Arm and Ball Joint Assembly - Front Left Upper Forward		8D0407505A; 8E0407505A
ARM178 301181317800	Suspension Control Arm and Ball Joint Assembly - Front Right Lower Rearward		4D0407694M; 8E0407694; 4D0407694N; 8E0407693K
ARM179 301181317900	Suspension Control Arm and Ball Joint Assembly - Front Left Lower		4D0407693M; 8E0407693K; 4D0407693N; 8E0407693
ARM180 301181318000	Suspension Control Arm and Ball Joint Assembly - Front Lower Forward	D=∅ 20,6mm	4D0407151G; 8E0407151N; 4D0407151H; 4D0407151J
SSP0004 301191600040	Steering Tie Rod - Front	M 14x1.5 Rht - L=119,5mm	4B0422821; 4D0422821
SSP0287 301191602870	Steering Tie Rod End - Front	M14x1,5 Rht	4B0419811E; 4D0419811A; 4D0419811B; 8E0419811B
SSP2007 301191620070	Suspension Stabilizer Bar Link - Front Right	With Bolts And Nuts L=90mm	8D0407318D; 8D0411318D
SSP2008 301191620080	Suspension Stabilizer Bar Link - Front Left	With Bolts And Nuts L=90mm	8D0407317D; 8D0411317D



SKODA SUPERB (3T4)



04/2008-





SKODA SUPERB (3T4)

04/2008-

PART NO.	DESCRIPTION	NOTES	O.E.
ARM189	301181318900 Lateral Arm - Rear Upper		1K0505323N
ARM982	301181398200 Lateral Arm - Rear Right Lower	L=298mm	1K0501530C
ARM983	301181398300 Lateral Arm - Rear Left Lower	L=298mm	1K0501529F
ARM989	301181398900 Suspension Control Arm and Ball Joint Assembly - Front Right Lower		1K0407152BC*
ARM990	301181399000 Suspension Control Arm and Ball Joint Assembly - Front Left Lower		1K0407151BC*
ARM1054	301181310540 Lateral Arm - Rear Right Forward		1K0505224K
ARM1055	301181310550 Lateral Arm - Rear Left Forward		1K0505223K
SSP0269	301191602690 Steering Tie Rod - Front Inner	M16x1,5 - L=310mm	1K0423810A
SSP0700	301191607000 Steering Tie Rod End - Front Right	M16x1,5Rht	1K0423812A; 1K0423812J; 1K0423812K; 1K0423812G; 1K0423812E
SSP0701	301191607010 Steering Tie Rod End - Front Left	M16x1,5Rht	1K0423811A; 1K0423811J; 1K0423811K; 1K0423811G; 1K0423811E
SSP1977	301191619770 Suspension Ball Joint - Front Left Lower		1K0407365B; 5Q0407365A; 1K0407365E; 1K0407365C
SSP2576	301191625760 Suspension Stabilizer Bar Link - Front	L=335mm	1K0411315B; 1K0411315D; 1K0411315J
SSP2577	301191625770 Suspension Stabilizer Bar Link - Rear	L=95,5 mm	1K0505465C; 1K0505465J; 1K0505465K; 1K0505465H; 1K0505465D



MAGNETI
MARELLI

SKODA SUPERB (3V3)



2015-



PART NO.	DESCRIPTION	NOTES	O.E.
SSP0268 301191602680	Steering Tie Rod - Front Inner		561423810



SKODA YETI (5L)



05/2009-





SKODA YETI (5L)



05/2009-

PART NO.	DESCRIPTION	NOTES	O.E.
ARM988	301181398800 Lateral Arm - Rear Lower	L=298mm	1K0501529J
ARM989	301181398900 Suspension Control Arm and Ball Joint Assembly - Front Right Lower		1K0407152BC*
ARM990	301181399000 Suspension Control Arm and Ball Joint Assembly - Front Left Lower		1K0407151BC*
ARM1039	301181310390 Lateral Arm - Rear Lower		1K0505311AA; 1K0505311S; 1K0505311AB
SSP0269	301191602690 Steering Tie Rod - Front Inner	M16x1,5 - L=310mm	1K0423810A
SSP0700	301191607000 Steering Tie Rod End - Front Right	M16x1,5Rht	1K0423812A; 1K0423812J; 1K0423812K; 1K0423812G; 1K0423812E
SSP0701	301191607010 Steering Tie Rod End - Front Left	M16x1,5Rht	1K0423811A; 1K0423811J; 1K0423811K; 1K0423811G; 1K0423811E
SSP1976	301191619760 Suspension Ball Joint - Front Right Lower		1K0407366B; 5Q0407366A; 1K0407366E; 1K0407366C
SSP1977	301191619770 Suspension Ball Joint - Front Left Lower		1K0407365B; 5Q0407365A; 1K0407365E; 1K0407365C
SSP2576	301191625760 Suspension Stabilizer Bar Link - Front	L=335mm	1K0411315B; 1K0411315D; 1K0411315J
SSP2577	301191625770 Suspension Stabilizer Bar Link - Rear	L=95,5 mm	1K0505465C; 1K0505465J; 1K0505465K; 1K0505465H; 1K0505465D



SMART FORFOUR 454



06/2004-10/2012



SSP2538

SSP2538

PART NO.	DESCRIPTION	NOTES	O.E.
ARM825 301181382500	Suspension Control Arm and Ball Joint Assembly - Front Right Lower		4013A150; MN186217; 4543302607; 4543300707
ARM826 301181382600	Suspension Control Arm and Ball Joint Assembly - Front Left Lower		4013A135; MN186218; 4543301907; 4543300807
SSP0558 301191605580	Steering Tie Rod End - Front	M12X1,25	4544600205; MR977606
SSP2538 301191625380	Suspension Stabilizer Bar Link - Front	L=325,5mm	4543200010; MR961477

**SUBARU JUSTY III**

09/2003-12/2006



	PART NO.	DESCRIPTION	NOTES	O.E.
ARM037	301181303700	Suspension Control Arm and Ball Joint Assembly - Front Lower	L=294,6mm	4520084; 9210270; 4706665; 9214826; 4707280; 4705742; 4520085
SSP0191	301191601910	Steering Tie Rod - Front	M12x1,25 - L=239,8mm	4701745; 4883086G00; 4883083
SSP0597	301191605970	Steering Tie Rod End - Front	M12x1,25	4701744; 9204751; 48810830; 9210168; 488108300; 4705716; 4705655



SUZUKI ALTO IV (FF)



07/2002-12/2009



PART NO.	DESCRIPTION	NOTES	O.E.
SSP0665 301191606650	Steering Tie Rod End - Front	M12x1,25	4709195; 48810M68K00; 4881063J00



SUZUKI GRAND VITARA 4th Gen



2015-



PART NO.	DESCRIPTION	NOTES	O.E.
SSP1343 301181313430	Suspension Stabilizer Bar Link - Front		4252080J00; 71742688; 60614514



SUZUKI IGNIS I (FH)



10/2000-08/2003



PART NO.	DESCRIPTION	NOTES	O.E.
ARM877 301181387700	Suspension Control Arm and Ball Joint Assembly - Front Lower	L=284mm	4705172; 96316765



SUZUKI IGNIS II



09/2003-07/2008



	PART NO.	DESCRIPTION	NOTES	O.E.
ARM037	301181303700	Suspension Control Arm and Ball Joint Assembly - Front Lower	L=294,6mm	4520084; 9210270; 4706665; 9214826; 4707280; 4705742; 4520085
SSP0191	301191601910	Steering Tie Rod - Front	M12x1,25 - L=239,8mm	4701745; 4883086G00; 4883083
SSP0597	301191605970	Steering Tie Rod End - Front	M12x1,25	4701744; 9204751; 48810830; 9210168; 488108300; 4705716; 4705655



SUZUKI RENO 1st Gen J200



2004-2008

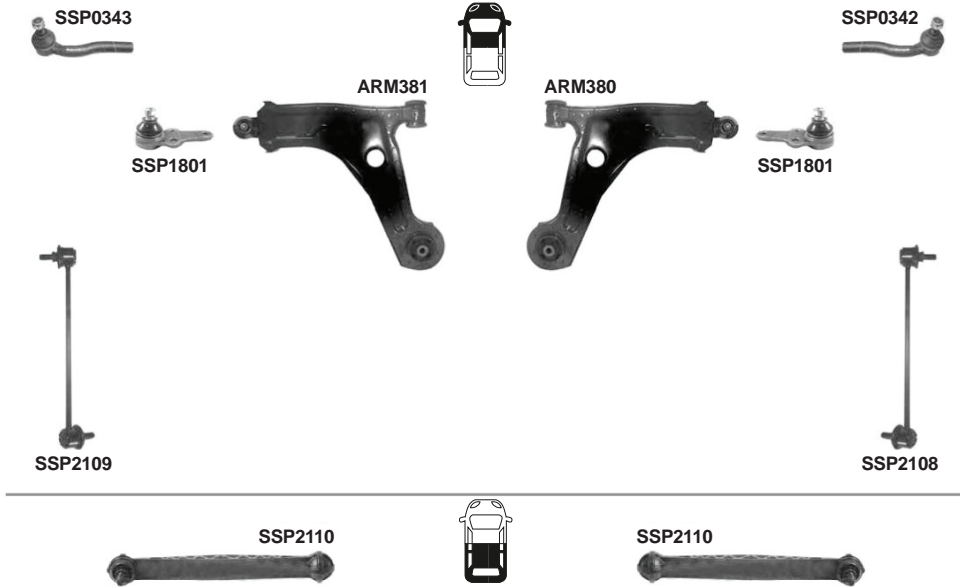

PART NO.	DESCRIPTION	NOTES	O.E.
ARM380 301181338000	Suspension Control Arm and Ball Joint Assembly - Front Right Lower		96391851; 96415064
ARM381 301181338100	Suspension Control Arm and Ball Joint Assembly - Front Left Lower		96391850; 96415063
SSP0342 301191603420	Steering Tie Rod End - Front Right	M14X1,5Rht	93740623; 96407486
SSP0343 301191603430	Steering Tie Rod End - Front Left	M14X1,5Rht	96407485
SSP1801 301191618010	Suspension Ball Joint - Front	D=Ø 18mm	96490218
SSP2108 301191621080	Suspension Stabilizer Bar Link - Front Right	L=272mm	96403100
SSP2109 301191621090	Suspension Stabilizer Bar Link - Front Left	L=272mm	96403099
SSP2110 301191621100	Suspension Stabilizer Bar Link - Rear	Plastic L=217mm	96391876; 96561754



SUZUKI S-CROSS (GY)



2013-



PART NO.	DESCRIPTION	NOTES	O.E.
SSP1452 301181314520	Steering Tie Rod End - Front	M14x1,5	4881079J01; 71742770



SUZUKI SPLASH



01/2008-

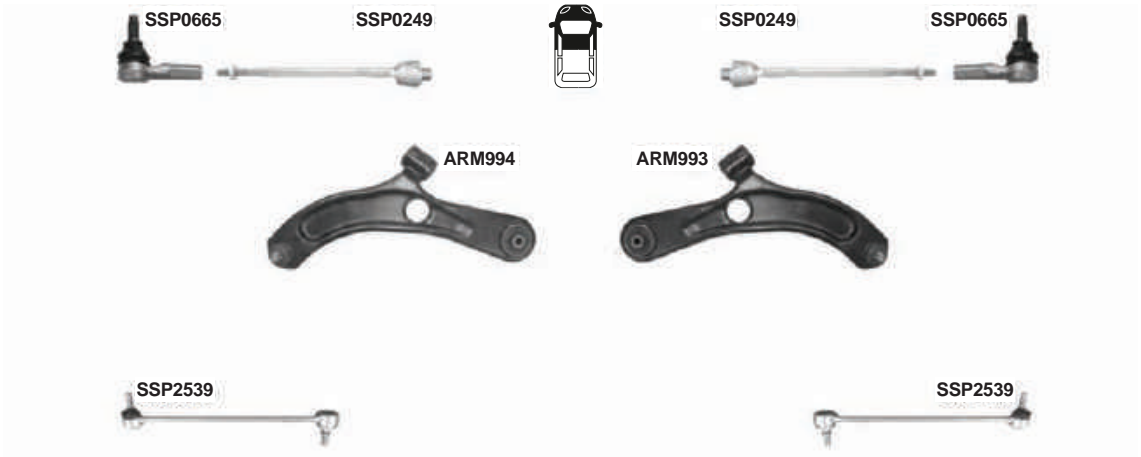

PART NO.	DESCRIPTION	NOTES	O.E.
ARM993 301181399300	Suspension Control Arm and Ball Joint Assembly - Front Right Lower		4520162J00; 4708299; 4520163J00
ARM994 301181399400	Suspension Control Arm and Ball Joint Assembly - Front Left Lower		4520262J00; 4708300; 4520263J00
SSP0249 301191602490	Steering Tie Rod - Front	M12x1,25 - L=305mm	4709161; 4883063J00
SSP0665 301191606650	Steering Tie Rod End - Front	M12x1,25	4709195; 48810M68K00; 4881063J00
SSP2461 301191624610	Suspension Stabilizer Bar Link - Front Right		54618EA010; 7L125K483B
SSP2462 301191624620	Suspension Stabilizer Bar Link - Front Left		54668EA010
SSP2539 301191625390	Suspension Stabilizer Bar Link - Front	L=300mm	4242062J00; 4709702

**SUZUKI SWIFT II (AH,AJ) (EA,MA)**  03/1989-12/2004

	PART NO.	DESCRIPTION	NOTES	O.E.
ARM991	301181399100	Suspension Control Arm and Ball Joint Assembly - Front Right		4520150G10; 4520170C00; 4520160B01
ARM992	301181399200	Suspension Control Arm and Ball Joint Assembly - Front Left		4520250G10; 4520270C00; 4520260B01
SSP1965	301191619650	Suspension Ball Joint - Front Lower		4520170C00 / 45202 Part of

SUZUKI SWIFT III (SG)



02/2005-09/2010



PART NO.	DESCRIPTION	NOTES	O.E.
ARM993 301181399300	Suspension Control Arm and Ball Joint Assembly - Front Right Lower		4520162J00; 4708299; 4520163J00
ARM994 301181399400	Suspension Control Arm and Ball Joint Assembly - Front Left Lower		4520262J00; 4708300; 4520263J00
SSP0249 301191602490	Steering Tie Rod - Front	M12x1,25 - L=305mm	4709161; 4883063J00
SSP0665 301191606650	Steering Tie Rod End - Front	M12x1,25	4709195; 48810M68K00; 4881063J00
SSP2539 301191625390	Suspension Stabilizer Bar Link - Front	L=300mm	4242062J00; 4709702



SUZUKI SWIFT (IV)



10/2010-



SSP1343



SSP1343

PART NO.	DESCRIPTION	NOTES	O.E.
SSP1343 301181313430	Suspension Stabilizer Bar Link - Front	L=271mm	4252080J00; 71742688; 60614514



SUZUKI SX4 (GY)



06/2006-07/2013

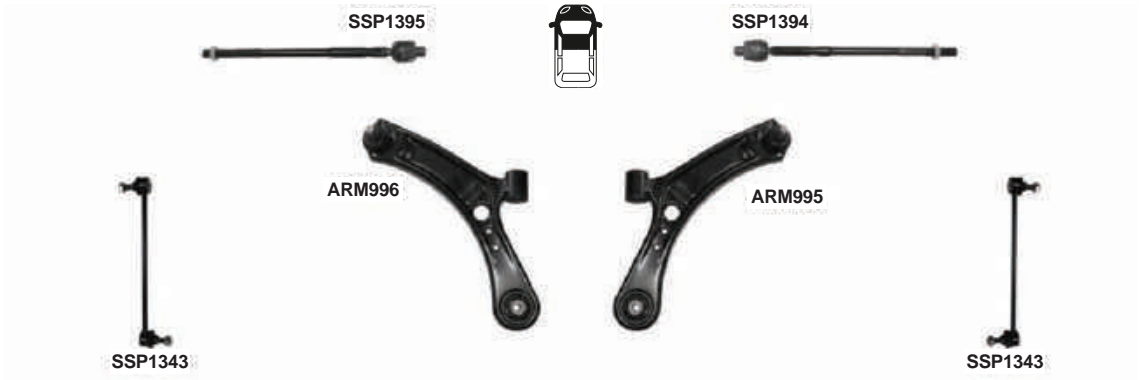

PART NO.	DESCRIPTION	NOTES	O.E.
ARM995 301181399500	Suspension Control Arm and Ball Joint Assembly - Front Right Lower		4520179J00; 71768151; 71742731
ARM996 301181399600	Suspension Control Arm and Ball Joint Assembly - Front Left Lower		4520279J00; 71768151; 71742732
SSP1343 301181313430	Suspension Stabilizer Bar Link - Front	L=271mm	4252080J00; 71742688; 60614514
SSP1394 301181313940	Steering Tie Rod - Right	M14x1,5 - L=333mm	4883079J00
SSP1395 301181313950	Steering Tie Rod - Left	M14x1,5 - L=333mm	4883079J10



SUZUKI XL-7



2007-2009

SSP0030



SSP0030



PART NO.	DESCRIPTION	NOTES	O.E.
SSP0030 301191600300	Steering Tie Rod - Front	POWER/ELECTRIC	19149839



TALBOT SAMBA TAGORA



1981-1986



PART NO.	DESCRIPTION	NOTES	O.E.
SSP0612 301191606120	Steering Tie Rod End - Front	M14x1,5Rht	3817.10; 95493208; 9471000965; 9471003465; 3817.18; 3817.50

**TOYOTA 4RUNNER N180 3rd Gen**

1996-2002

SSP0692



SSP0691



PART NO.		DESCRIPTION	NOTES	O.E.
SSP0691	301191606910	Steering Tie Rod End - Front Right Outer	M20X1,5	4504639335
SSP0692	301191606920	Steering Tie Rod End - Front Left Outer	M20X1,5	4504739215
SSP1975	301191619750	Suspension Ball Joint - Front Upper		4331039016; 4331039085



TOYOTA AURIS I



02/2007-06/2013



	PART NO.	DESCRIPTION	NOTES	O.E.
ARM997	301181399700	Suspension Control Arm and Ball Joint Assembly - Front Right Lower		4806802130*; 4806812300*
ARM998	301181399800	Suspension Control Arm and Ball Joint Assembly - Front Left Lower		4806902130*; 4806912300*
SSP0685	301191606850	Steering Tie Rod End - Front Right	M15x1.5	4504609570; 4504619415
SSP0686	301191606860	Steering Tie Rod End - Front Left	M15x1.5	4504709570; 4504719215
SSP1974	301191619740	Suspension Ball Joint - Front		4333009630; 4333049095; 4333019245
SSP2561	301191625610	Suspension Stabilizer Bar Link - Front	L=360mm	4882002070; 4882047020; 488200R010



TOYOTA AURIS II



07/2013-



	PART NO.	DESCRIPTION	NOTES	O.E.
ARM997	301181399700	Suspension Control Arm and Ball Joint Assembly - Front Right Lower		4806802130*; 4806812300*
ARM998	301181399800	Suspension Control Arm and Ball Joint Assembly - Front Left Lower		4806902130*; 4806912300*
SSP0687	301191606870	Steering Tie Rod End - Front Right	M15X1,5	4504609570
SSP0688	301191606880	Steering Tie Rod End - Front Left	M15X1,5	4504709270
SSP1974	301191619740	Suspension Ball Joint - Front		4333009630; 4333049095; 4333019245
SSP2561	301191625610	Suspension Stabilizer Bar Link - Front	L=360mm	4882002070; 4882047020; 488200R010



TOYOTA AVENTIS (T25)



04/2003-01/2009



SSP2555



SSP2555



SSP2557



SSP2556

PART NO.	DESCRIPTION	NOTES	O.E.
SSP0260 301191602600	Steering Tie Rod - Front	Type : AZT-CDT M16x1,5 - L=304mm	455030F010; 455030R010
SSP0681 301191606810	Steering Tie Rod End - Front	Only: 2.0 Lt.TD M16x1.5	4504609430; 4504629425
SSP2555 301191625550	Suspension Stabilizer Bar Link - Front	L=285mm	4882002030; 4882047010; 4882002040
SSP2556 301191625560	Suspension Stabilizer Bar Link - Rear Right	L=100 mm	4883021020
SSP2557 301191625570	Suspension Stabilizer Bar Link - Rear Left	L=100 mm	4884021010



TOYOTA AVENSIS (T27)



02/2009-



SSP2561



SSP2561

PART NO.	DESCRIPTION	NOTES	O.E.
SSP2561 301191625610	Suspension Stabilizer Bar Link - Front	L=360mm	4882002070; 4882047020; 488200R010



TOYOTA AYGO



1995-2004

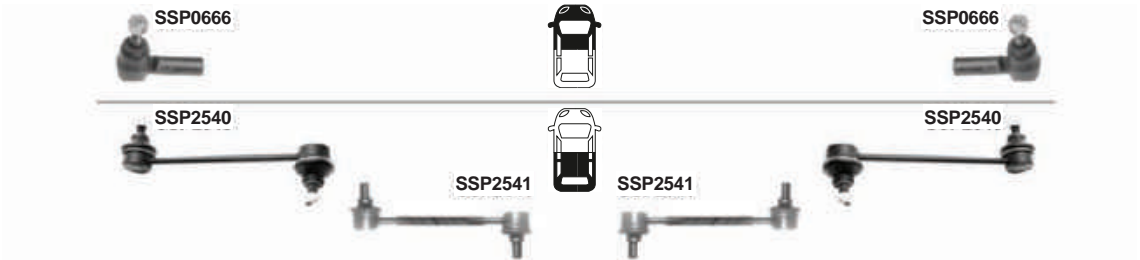

PART NO.	DESCRIPTION	NOTES	O.E.
SSP0666 301191606660	Steering Tie Rod End - Front		4504629255
SSP2540 301191625400	Suspension Stabilizer Bar Link - Front Left		4881006030; 4883033010
SSP2541 301191625410	Suspension Stabilizer Bar Link - Rear		4883006020; 4883048010; 4883006030



TOYOTA AYGO



07/2005-09/2014



PART NO.	DESCRIPTION	NOTES	O.E.
ARM902	301181390200 Suspension Control Arm and Ball Joint Assembly - Front Right Lower		3521.L3; 480680H010; 3521.N7
ARM903	301181390300 Suspension Control Arm and Ball Joint Assembly - Front Left Lower		3520.Q2; 480690H010; 3520.R6
SSP0205	301191602050 Steering Tie Rod - Front	M12X1,25 - L=224mm	4001.33; 455000H010
SSP0613	301191606130 Steering Tie Rod End - Front Right Outer	M12x1,25	3817.64
SSP0614	301191606140 Steering Tie Rod End - Front Left Outer	M12x1,25	3817.63
SSP1971	301191619710 Suspension Ball Joint - Front Lower		4330859035; 4330859095
SSP2495	301191624950 Suspension Stabilizer Bar Link - Front	L=335mm	5087.45; 96288787
SSP2496	301191624960 Suspension Stabilizer Bar Link - Front	(Clip-on patented design) L=335mm	5087.45; 96288787



TOYOTA CAMRY XV10



06/1991-08/1996

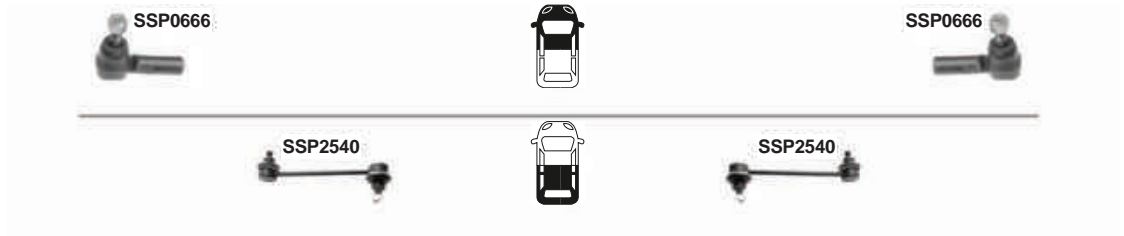

PART NO.	DESCRIPTION	NOTES	O.E.
SSP0666 301191606660	Steering Tie Rod End - Front	M15x1,5Rht	4504629255
SSP2540 301191625400	Suspension Stabilizer Bar Link - Front Left	L=195mm	4881006030; 4883033010



TOYOTA CAMRY XV20



09/1996-10/2001

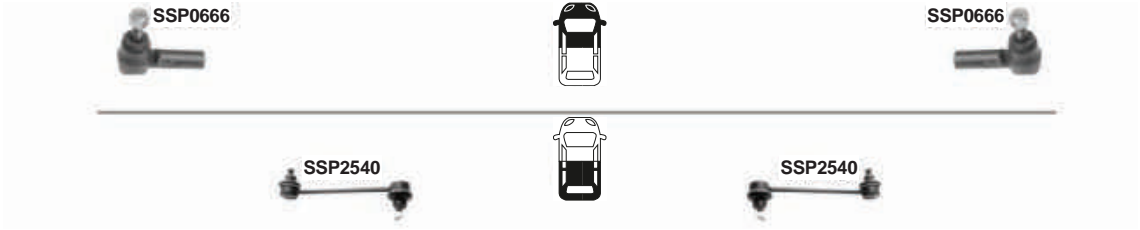

PART NO.	DESCRIPTION	NOTES	O.E.
SSP0666 301191606660	Steering Tie Rod End - Front	M15x1,5Rht	4504629255
SSP2540 301191625400	Suspension Stabilizer Bar Link - Front Left	L=195mm	4881006030; 4883033010



TOYOTA CAMRY XV30



11/2001-12/2006



PART NO.	DESCRIPTION	NOTES	O.E.
SSP2541 301191625410	Suspension Stabilizer Bar Link - Rear	L=237 mm	4883006020; 4883048010; 4883006030



TOYOTA CELICA



08/1999-09/2005



SSP1972



SSP1972



SSP2559



SSP2559

PART NO.	DESCRIPTION	NOTES	O.E.
SSP1972 301191619720	Suspension Ball Joint - Front Lower		4333009090; 4333049185; 4333009360; 4333009230
SSP2559 301191625590	Suspension Stabilizer Bar Link - Front	L=285mm	4882032010



TOYOTA COROLLA E80



05/1983-06/1987



PART NO.	DESCRIPTION	NOTES	O.E.
SSP0676 301191606760	Steering Tie Rod End - Front	M14x1,5Rht	4504619175; 4504629305



MAGNETI
MARELLI

TOYOTA COROLLA E90



07/1987-12/1992



PART NO.	DESCRIPTION	NOTES	O.E.
SSP0676 301191606760	Steering Tie Rod End - Front	M14x1,5Rht	4504619175; 4504629305



TOYOTA COROLLA E100



07/1992-03/1997



PART NO.	DESCRIPTION	NOTES	O.E.
SSP0676 301191606760	Steering Tie Rod End - Front	M14x1,5Rht	4504619175; 4504629305



MAGNETI
MARELLI

TOYOTA COROLLA E110



04/1997-01/2002



SSP0676



SSP0676

PART NO.	DESCRIPTION	NOTES	O.E.
SSP0676 301191606760	Steering Tie Rod End - Front	M14x1,5Rht	4504619175; 4504629305



TOYOTA COROLLA E120



02/2002-01/2007

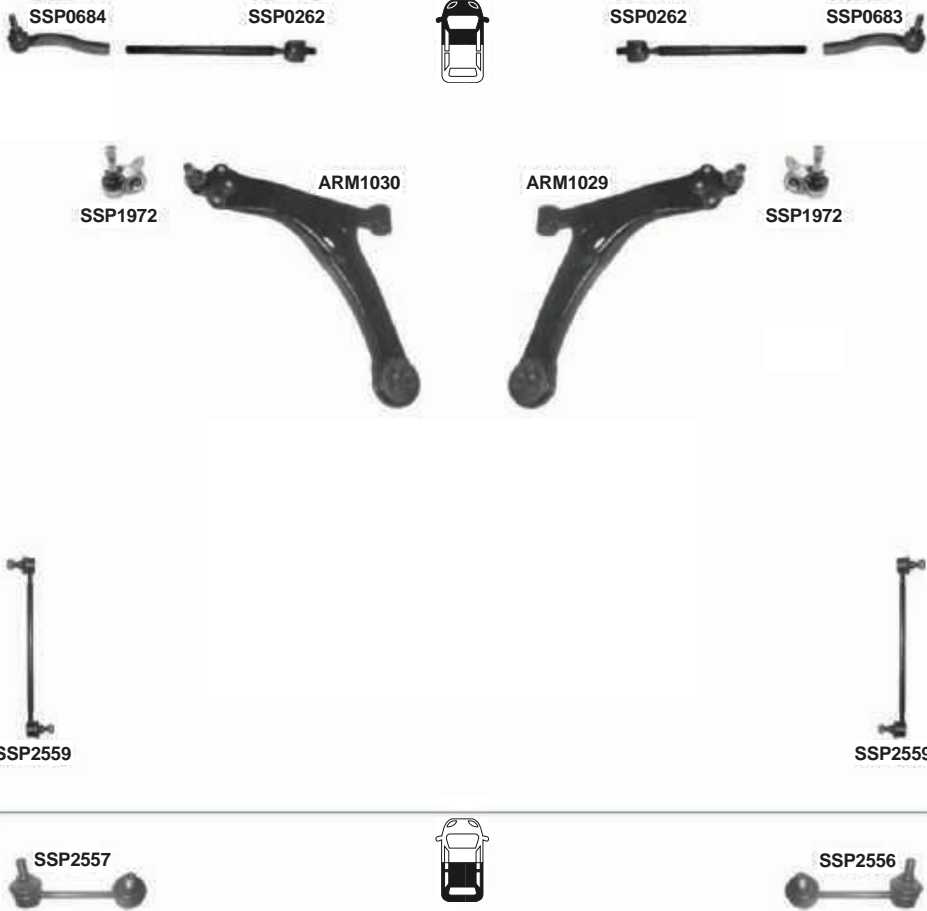

PART NO.	DESCRIPTION	NOTES	O.E.
ARM1029	Suspension Control Arm and Ball Joint Assembly - Front Right Lower		4806812260*
ARM1030	Suspension Control Arm and Ball Joint Assembly - Front Left Lower		4806912260*
SSP0262	Steering Tie Rod - Front	M14x1,5 - L=270mm	4550319130; 4550319256; 4550319255
SSP0683	Steering Tie Rod End - Front Right	M14x1,5Rht	4504609360; 4504649115; 4504619265
SSP0684	Steering Tie Rod End - Front Left	M14x1,5Rht	4504709150; 4504749045; 4504719115
SSP1972	Suspension Ball Joint - Front Lower		4333009090; 4333049185; 4333009360; 4333009230
SSP2556	Suspension Stabilizer Bar Link - Rear Right	L=100 mm	4883021020
SSP2557	Suspension Stabilizer Bar Link - Rear Left	L=100 mm	4884021010
SSP2559	Suspension Stabilizer Bar Link - Front	L=285mm	4882032010

**TOYOTA COROLLA E140**

02/2007-06/2013



	PART NO.	DESCRIPTION	NOTES	O.E.
ARM997	301181399700	Suspension Control Arm and Ball Joint Assembly - Front Right Lower		4806802130*; 4806812300*
ARM998	301181399800	Suspension Control Arm and Ball Joint Assembly - Front Left Lower		4806902130*; 4806912300*
SSP0264	301191602640	Steering Tie Rod - Front	M15x1,5 - L=233mm	4551012390
SSP0685	301191606850	Steering Tie Rod End - Front Right	M15x1.5	4504609570; 4504619415
SSP0686	301191606860	Steering Tie Rod End - Front Left	M15x1.5	4504709570; 4504719215
SSP1974	301191619740	Suspension Ball Joint - Front		4333009630; 4333049095; 4333019245
SSP2561	301191625610	Suspension Stabilizer Bar Link - Front	L=360mm	4882002070; 4882047020; 488200R010



TOYOTA COROLLA E170



07/2013-



PART NO.	DESCRIPTION	NOTES	O.E.
ARM997 301181399700	Suspension Control Arm and Ball Joint Assembly - Front Right Lower		4806802130*; 4806812300*
ARM998 301181399800	Suspension Control Arm and Ball Joint Assembly - Front Left Lower		4806902130*; 4806912300*
SSP0687 301191606870	Steering Tie Rod End - Front Right	M15X1,5	4504609570
SSP0688 301191606880	Steering Tie Rod End - Front Left	M15X1,5	4504709270
SSP1974 301191619740	Suspension Ball Joint - Front		4333009630; 4333049095; 4333019245
SSP2561 301191625610	Suspension Stabilizer Bar Link - Front		4882002070; 4882047020; 488200R010



TOYOTA COROLLA Verso



04/2004-04/2009

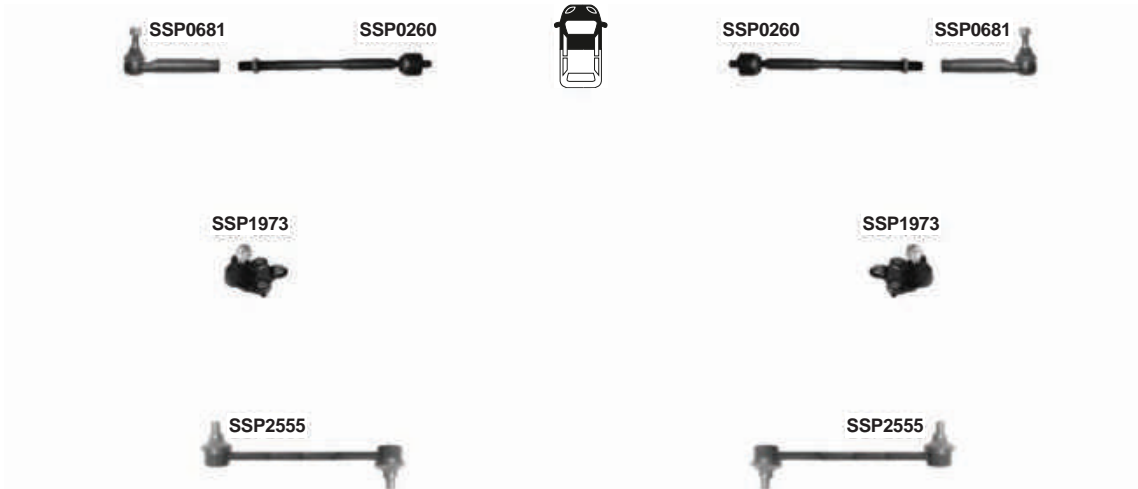

PART NO.	DESCRIPTION	NOTES	O.E.
SSP0260 301191602600	Steering Tie Rod - Front	M16x1,5 - L=304mm	455030F010; 455030R010
SSP0681 301191606810	Steering Tie Rod End - Front	M16x1.5	4504609430; 4504629425
SSP1973 301191619730	Suspension Ball Joint - Front Lower		4333009320; 4333009360
SSP2555 301191625550	Suspension Stabilizer Bar Link - Front	L=285mm	4882002030; 4882047010; 4882002040



TOYOTA ECHO XP10



1999-2005

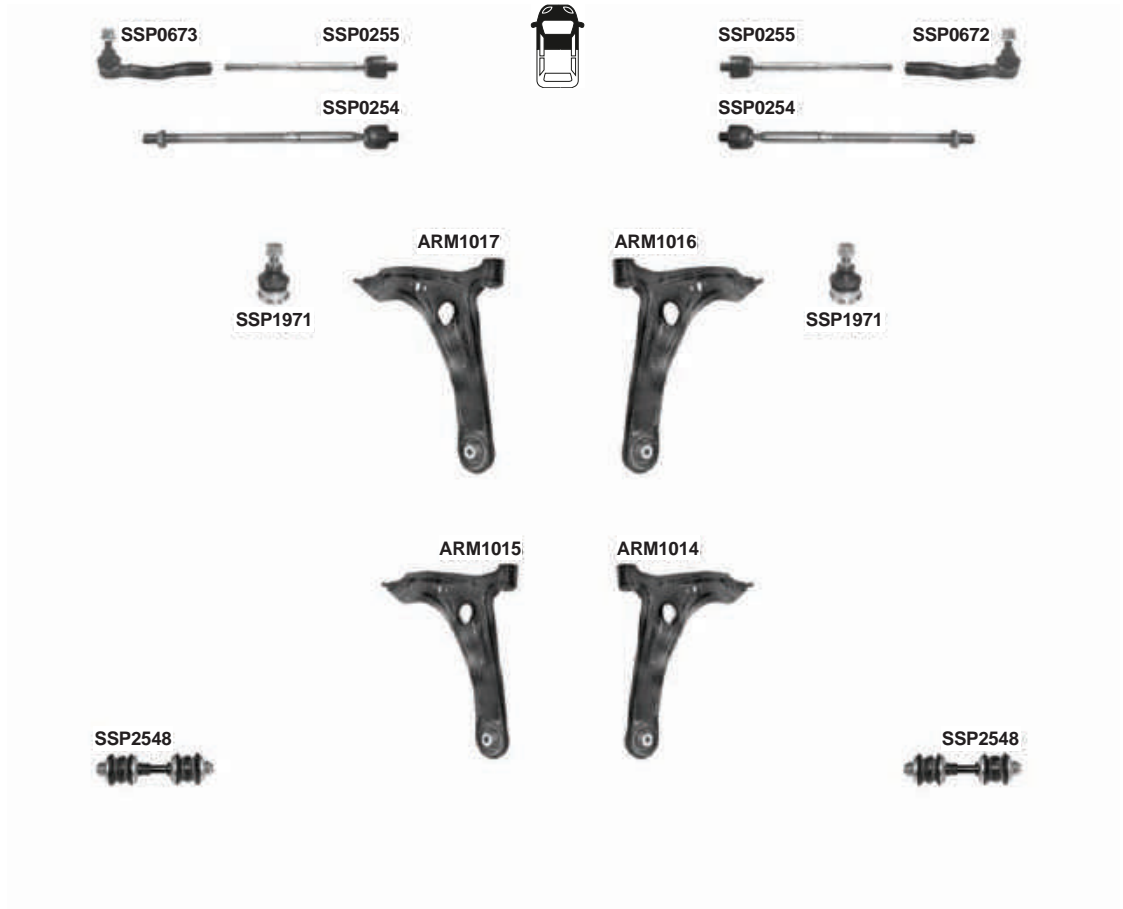

PART NO.	DESCRIPTION	NOTES	O.E.
ARM1014	301181310140 Suspension Control Arm and Ball Joint Assembly - Front Right Lower		4806859035
ARM1015	301181310150 Suspension Control Arm and Ball Joint Assembly - Front Left Lower		4806959035
ARM1016	301181310160 Suspension Control Arm and Ball Joint Assembly - Front Right Lower		4806859055
ARM1017	301181310170 Suspension Control Arm and Ball Joint Assembly - Front Left Lower		4806959055
SSP0254	301191602540 Steering Tie Rod - Front		4550352030
SSP0255	301191602550 Steering Tie Rod - Front Inner		4550352010
SSP0672	301191606720 Steering Tie Rod End - Front Right		4504659025; 4504659045; 4504659026
SSP0673	301191606730 Steering Tie Rod End - Front Left		4504759025; 4504759035; 4504759026
SSP1971	301191619710 Suspension Ball Joint - Front Lower		4330859035; 4330859095
SSP2548	301191625480 Suspension Stabilizer Bar Link - Front		488170D010 Bush; 9418210800 Nut; 9094802179 Rond smal; 9094802178 Rond Big; 4881952010 S1; 4881952010



TOYOTA HIGHLANDER XU20



2001-2007

SSP2541



SSP2541



PART NO.	DESCRIPTION	NOTES	O.E.
SSP2541 301191625410	Suspension Stabilizer Bar Link - Rear		4883006020; 4883048010; 4883006030



PART NO.	DESCRIPTION	NOTES	O.E.
ARM1006 301181310060	Suspension Control Arm and Ball Joint Assembly - Front Right Upper		486100K010
ARM1007 301181310070	Suspension Control Arm and Ball Joint Assembly - Front Left Upper		486300K010
ARM1008 301181310080	Suspension Control Arm and Ball Joint Assembly - Right Lower		480680K010
ARM1009 301181310090	Suspension Control Arm and Ball Joint Assembly - Left Lower		480690K010
SSP0253 301191602530	Steering Tie Rod - Front	M15X1,5 - L=294mm	4550309321; 4550309331
SSP0670 301191606700	Steering Tie Rod End - Front	M15x1,5	4504609261
SSP1969 301191619690	Suspension Ball Joint - Front Lower		4333009510
SSP1970 301191619700	Suspension Ball Joint - Front		4331009015
SSP2558 301191625580	Suspension Stabilizer Bar Link - Front	L=121mm	488200K010

**TOYOTA HILUX III 4WD Pick-Up**

08/2005-2015

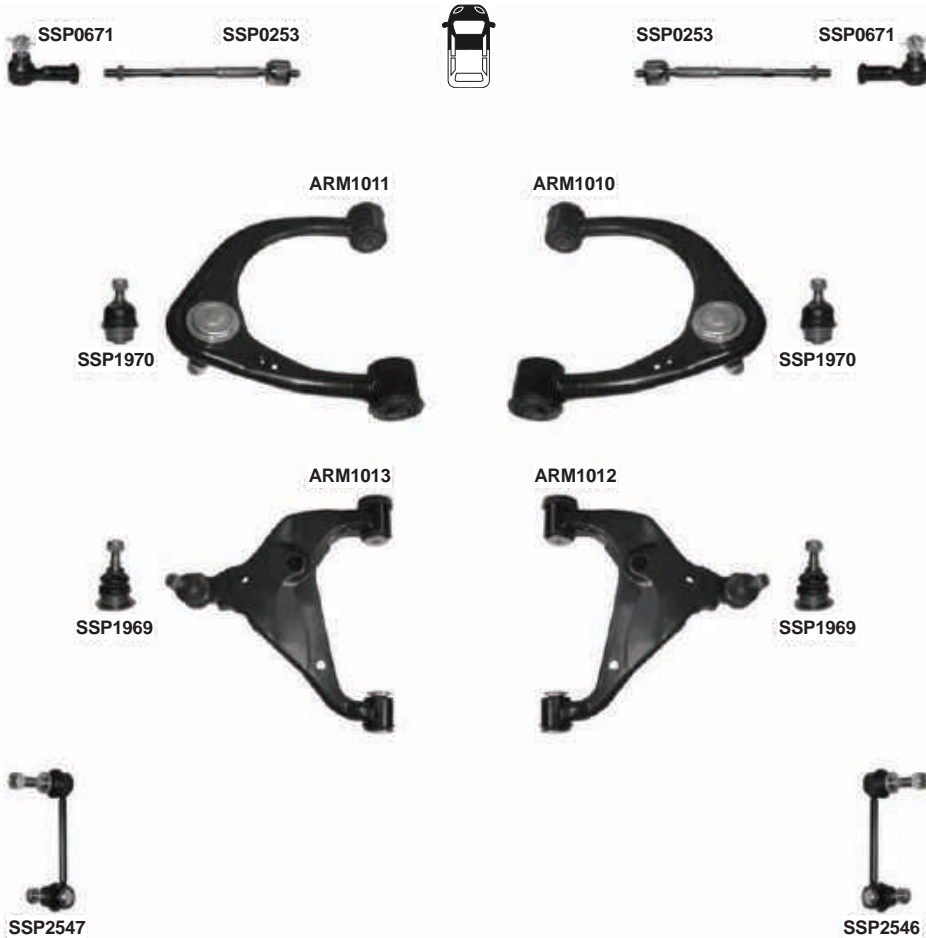

PART NO.	DESCRIPTION	NOTES	O.E.
ARM1010	301181310100 Suspension Control Arm and Ball Joint Assembly - Front Right Upper		486100K040
ARM1011	301181310110 Suspension Control Arm and Ball Joint Assembly - Front Left Upper		486300K040
ARM1012	301181310120 Suspension Control Arm and Ball Joint Assembly - Front Right Lower	4WD Pick-Up	480680K040
ARM1013	301181310130 Suspension Control Arm and Ball Joint Assembly - Front Left Lower	4WD Pick-Up	480690K040
SSP0253	301191602530 Steering Tie Rod - Front	M15X1,5 - L=294mm	4550309321; 4550309331
SSP0671	301191606710 Steering Tie Rod End - Front	M15x1,5	4504609281
SSP1969	301191619690 Suspension Ball Joint - Front Lower		4333009510
SSP1970	301191619700 Suspension Ball Joint - Front		4331009015
SSP2546	301191625460 Suspension Stabilizer Bar Link - Front Right	L=140mm	488200K030
SSP2547	301191625470 Suspension Stabilizer Bar Link - Front Left	L=140mm	488100K010



TOYOTA INNOVA AN40



2005-2015

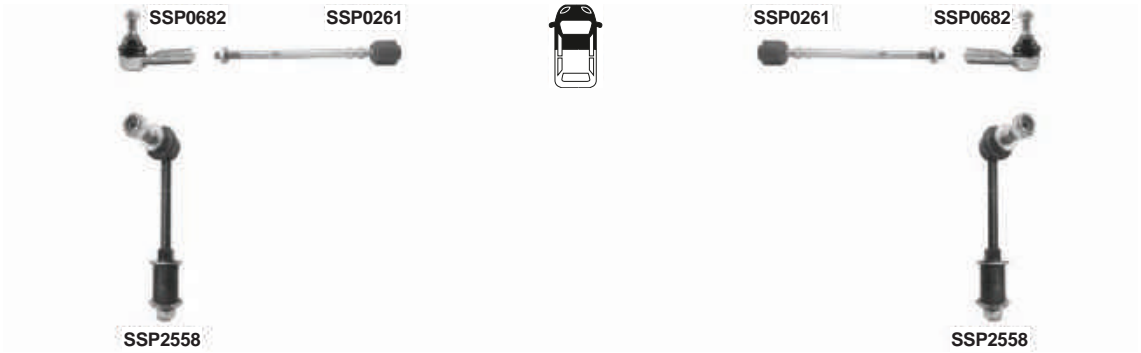

PART NO.	DESCRIPTION	NOTES	O.E.
SSP0261 301191602610	Steering Tie Rod - Front	M15x1.5 - L=295.8mm	4550309350
SSP0682 301191606820	Steering Tie Rod End - Front	M15x1.5	4504609320
SSP2558 301191625580	Suspension Stabilizer Bar Link - Front	L=121mm	488200K010



TOYOTA IQ



01/2009-2016



SSP0263



SSP0263



ARM1032

ARM1031

SSP1971

SSP1971



SSP2560



SSP2560

PART NO.	DESCRIPTION	NOTES	O.E.
ARM1031 301181310310	Suspension Control Arm and Ball Joint Assembly - Front Right Lower		4806879015
ARM1032 301181310320	Suspension Control Arm and Ball Joint Assembly - Front Left Lower		4806979015
SSP0263 301191602630	Steering Tie Rod - Front		4550374010
SSP1971 301191619710	Suspension Ball Joint - Front Lower		4330859035; 4330859095
SSP2560 301191625600	Suspension Stabilizer Bar Link - Front	Metal Design L=283mm	4882074010*



TOYOTA LAND CRUISER J80



01/1990-12/1997



PART NO.	DESCRIPTION	NOTES	O.E.
SSP0689 301191606890	Steering Tie Rod End - Front Right	M23X1,5	4504769085
SSP0690 301191606900	Steering Tie Rod End - Front Left	M23X1,5	4504669135

**TOYOTA LAND CRUISER J90**

1996-2002

SSP0692



SSP0691



SSP2562



SSP2562

PART NO.	DESCRIPTION	NOTES	O.E.
SSP0691 301191606910	Steering Tie Rod End - Front Right Outer	M20X1,5	4504639335
SSP0692 301191606920	Steering Tie Rod End - Front Left Outer	M20X1,5	4504739215
SSP1975 301191619750	Suspension Ball Joint - Front Upper		4331039016; 4331039085
SSP2562 301191625620	Suspension Stabilizer Bar Link - Front	A = L=128mm / 290 GR -B = M12x1.25	4882035030; 48820AD010



TOYOTA LAND CRUISER J100



01/1998-08/2007

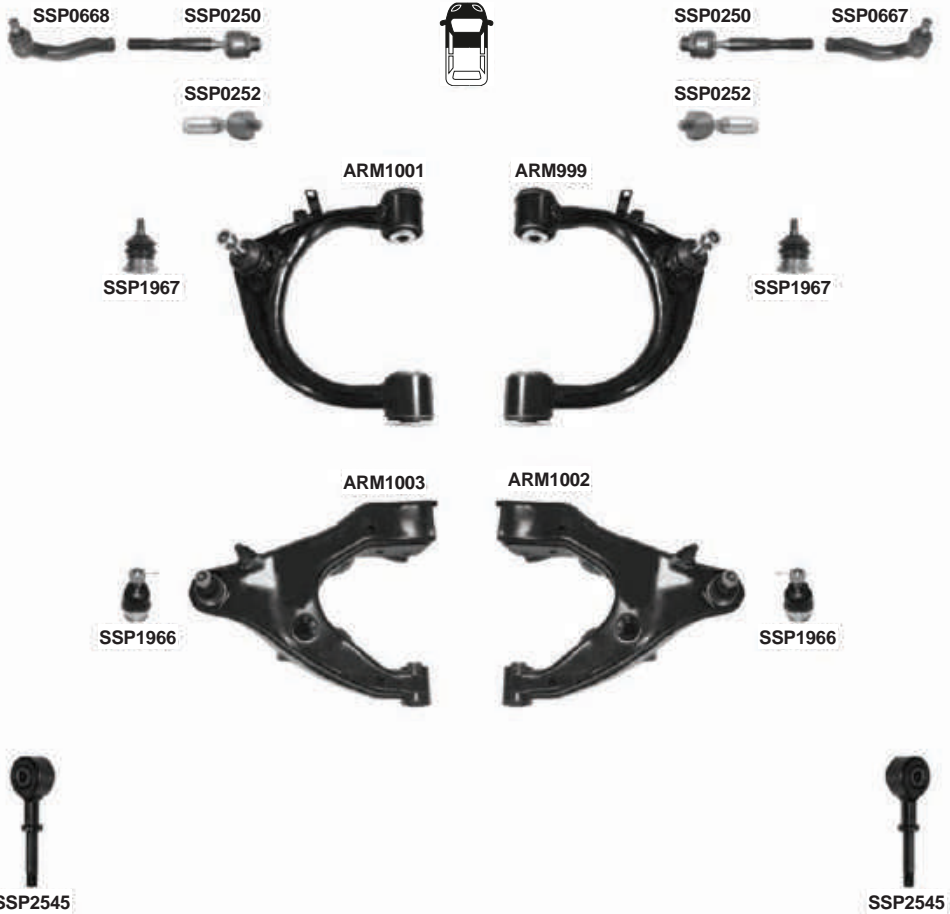

PART NO.	DESCRIPTION	NOTES	O.E.
ARM999	301181399900 Suspension Control Arm and Ball Joint Assembly - Front Right Upper		4861060030
ARM1001	301181310010 Suspension Control Arm and Ball Joint Assembly - Front Left Upper		4863060010
ARM1002	301181310020 Suspension Control Arm and Ball Joint Assembly - Front Right Lower		4862060010
ARM1003	301181310030 Suspension Control Arm and Ball Joint Assembly - Front Left Lower		4864060010
SSP0250	301191602500 Steering Tie Rod - Front Inner	M20x1,5 - L=207mm	4550369025
SSP0252	301191602520 Steering Tie Rod - Front	Cruiser 90 3.0TD M18x1,5 -L=132.6mm	4550339075
SSP0667	301191606670 Steering Tie Rod End - Front Right	M20x1,5Rht	4504669205
SSP0668	301191606680 Steering Tie Rod End - Front Left	M20x1,5Rht	4504769115
SSP1966	301191619660 Suspension Ball Joint - Front Lower		Part of 4862060010; Part of 4864060010
SSP1967	301191619670 Suspension Ball Joint - Upper		4861060030 / 4863060010 Part of
SSP2545	301191625450 Suspension Stabilizer Bar Link - Front	L=44,5mm	4882060032

**TOYOTA LAND CRUISER J120**

01/2003-02/2010

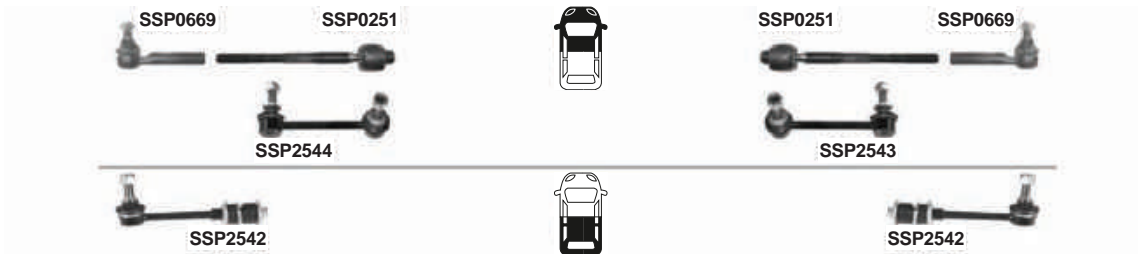

PART NO.	DESCRIPTION	NOTES	O.E.
SSP0251 301191602510	Steering Tie Rod - Front	M15x1,5 - L=259mm	4550339235
SSP0669 301191606690	Steering Tie Rod End - Front	M15x1,5Rht	4504539505
SSP2542 301191625420	Suspension Stabilizer Bar Link - Rear		4883060030
SSP2543 301191625430	Suspension Stabilizer Bar Link - Front Right	L=140mm	4882060050
SSP2544 301191625440	Suspension Stabilizer Bar Link - Front Left	L=140mm	4881060040



TOYOTA LAND CRUISER J200



01/2008-

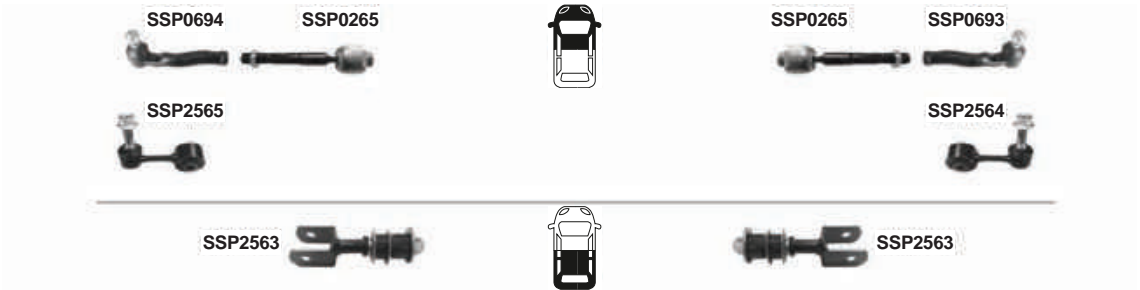

PART NO.	DESCRIPTION	NOTES	O.E.
ARM1092	301181310920 Suspension Control Arm and Ball Joint Assembly - Front Right Upper		4861060060
ARM1093	301181310930 Suspension Control Arm and Ball Joint Assembly - Front Left Upper		4863060030
SSP0265	301191602650 Steering Tie Rod - Front	M22X1,5 - L =233MM	4550360030
SSP0693	301191606930 Steering Tie Rod End - Front Right	M16X1.5	4504669236; 4504769146
SSP0694	301191606940 Steering Tie Rod End - Front Left	M16X1.5	4504669235; 4504769145
SSP2563	301191625630 Suspension Stabilizer Bar Link - Rear	L=70mm	4880260100; 90948 02202; 4881760010*
SSP2564	301191625640 Suspension Stabilizer Bar Link - Front Right		4882060080
SSP2565	301191625650 Suspension Stabilizer Bar Link - Front Left		4881060060



TOYOTA LAND CRUISER J150



03/2010-



PART NO.		DESCRIPTION	NOTES	O.E.
SSP0266	301191602660	Steering Tie Rod - Front	M16x1.5/L =261MM	4550360040
SSP0695	301191606950	Steering Tie Rod End - Front	M16x1.5	4504669245



SSP1972



SSP1972



SSP2561



SSP2561

PART NO.	DESCRIPTION	NOTES	O.E.
SSP1972 301191619720	Suspension Ball Joint - Front Lower		4333009090; 4333049185; 4333009360; 4333009230
SSP2561 301191625610	Suspension Stabilizer Bar Link - Front	L=360mm	4882002070; 4882047020; 488200R010



TOYOTA RAV4 XA10



1995-06/2000

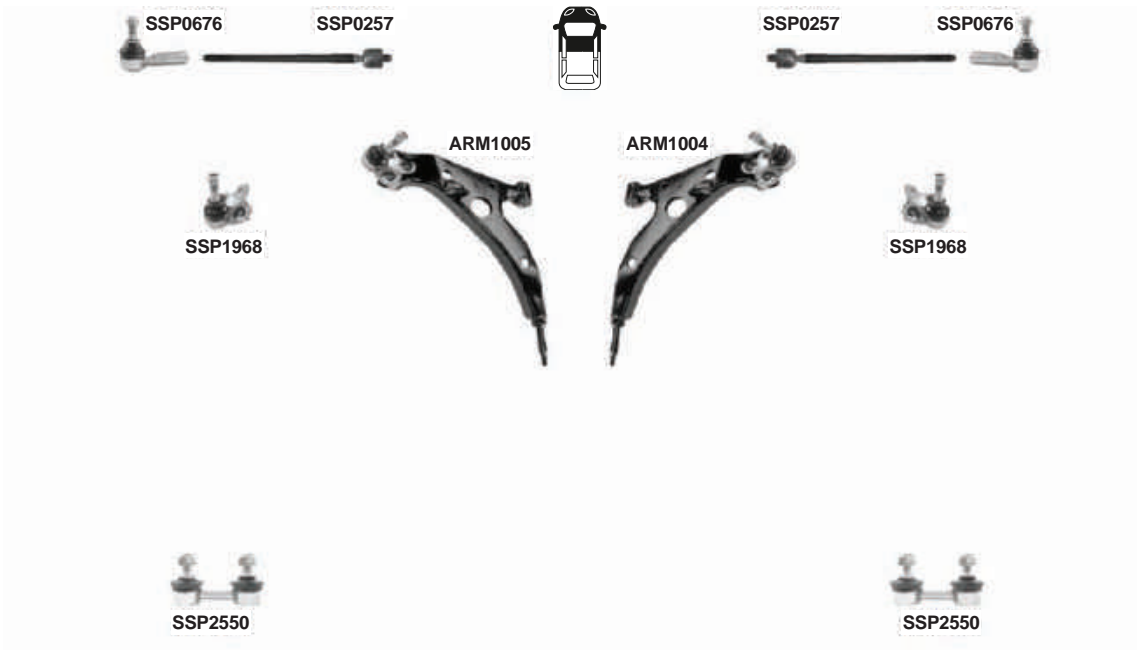

	PART NO.	DESCRIPTION	NOTES	O.E.
ARM1004	301181310040	Suspension Control Arm and Ball Joint Assembly - Front Right Lower		4806842022
ARM1005	301181310050	Suspension Control Arm and Ball Joint Assembly - Front Left Lower		4806942022*
SSP0257	301191602570	Steering Tie Rod - Front	M14x1,5Rht - L=318,1mm	4550319215
SSP0676	301191606760	Steering Tie Rod End - Front	M14x1,5Rht	4504619175; 4504629305
SSP1968	301191619680	Suspension Ball Joint - Front		4333049025
SSP2550	301191625500	Suspension Stabilizer Bar Link - Front	L=63mm	4882042010



TOYOTA RAV4 XA20



07/2000-11/2005

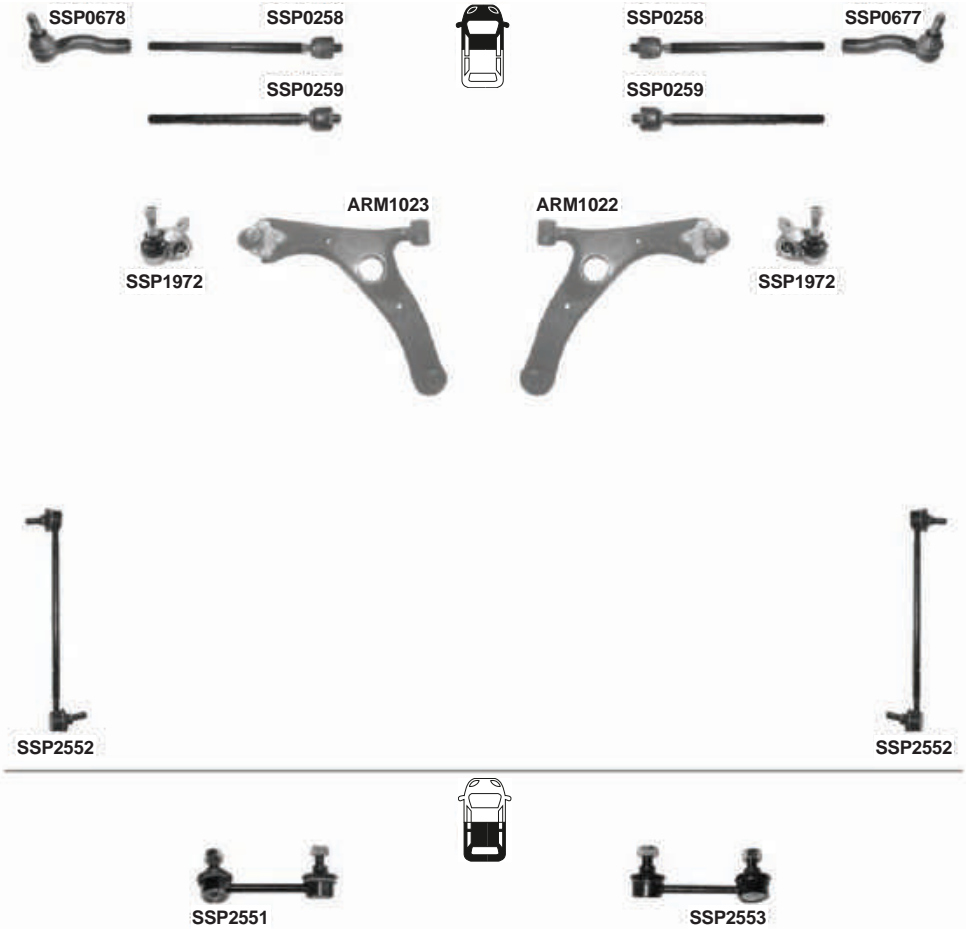

PART NO.	DESCRIPTION	NOTES	O.E.
ARM1022	301181310220 Suspension Control Arm and Ball Joint Assembly - Front Right Lower		4806842040
ARM1023	301181310230 Suspension Control Arm and Ball Joint Assembly - Front Left Lower		4806942040
SSP0258	301191602580 Steering Tie Rod - Front	M15x1,5Rht - L=298mm	4550342020; 4550349165
SSP0259	301191602590 Steering Tie Rod - Front	M15x1,5Rht - L=298mm	4550349055
SSP0677	301191606770 Steering Tie Rod End - Front Left	M15x1,5Rht	4504749025
SSP0678	301191606780 Steering Tie Rod End - Front Right	M15x1,5Rht	4504649095
SSP1972	301191619720 Suspension Ball Joint - Front Lower		4333009090; 4333049185; 4333009360; 4333009230
SSP2551	301191625510 Suspension Stabilizer Bar Link - Rear Left	Only: 4WD L=100mm	4884042010
SSP2552	301191625520 Suspension Stabilizer Bar Link - Front	L=285 mm	4882042020
SSP2553	301191625530 Suspension Stabilizer Bar Link - Rear Right	Only: 4WD L=100mm	4883042010

**TOYOTA RAV4 XA30**

12/2005-2012

**SSP0680****SSP0679****SSP1974****ARM1025****ARM1024****SSP1974****SSP2561****SSP2561****SSP2554****SSP2554**

PART NO.	DESCRIPTION	NOTES	O.E.
ARM1024 301181310240	Suspension Control Arm and Ball Joint Assembly - Front Right Lower		4806842050*; 4806842051*
ARM1025 301181310250	Suspension Control Arm and Ball Joint Assembly - Front Left Lower		4806942050*; 4806942051*
SSP0679 301191606790	Steering Tie Rod End - Front Right	M16x1,5	4504609650; 4504649195
SSP0680 301191606800	Steering Tie Rod End - Front Left	M16x1,5	4504709310; 4504749195
SSP1974 301191619740	Suspension Ball Joint - Front		4333009630; 4333049095; 4333019245
SSP2554 301191625540	Suspension Stabilizer Bar Link - Rear	L=74mm	488300R010; 4883042021; 4883042020
SSP2561 301191625610	Suspension Stabilizer Bar Link - Front	L=360mm	4882002070; 4882047020; 488200R010



TOYOTA RAV4 XA40



2013-

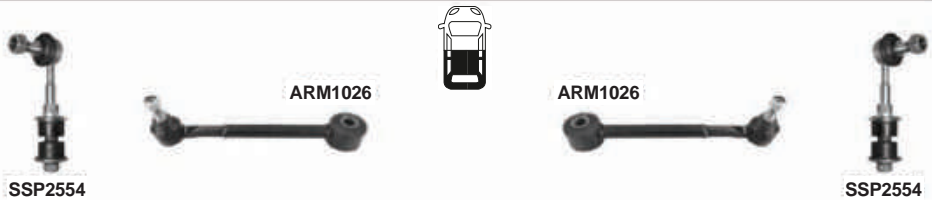

PART NO.	DESCRIPTION	NOTES	O.E.
ARM1026 301181310260	Lateral Arm - Rear		487100R030
ARM1027 301181310270	Suspension Control Arm and Ball Joint Assembly - Front Right Lower		480680R030*; 4806842060*
ARM1028 301181310280	Suspension Control Arm and Ball Joint Assembly - Front Left Lower		480690R030*; 4806942060*
SSP0679 301191606790	Steering Tie Rod End - Front Right	M16x1,5	4504609650; 4504649195
SSP0680 301191606800	Steering Tie Rod End - Front Left	M16x1,5	4504709310; 4504749195
SSP1974 301191619740	Suspension Ball Joint - Front		4333009630; 4333049095; 4333019245
SSP2554 301191625540	Suspension Stabilizer Bar Link - Rear	L=74mm	488300R010; 4883042021; 4883042020
SSP2561 301191625610	Suspension Stabilizer Bar Link - Front	L=360mm	4882002070; 4882047020; 488200R010



TOYOTA SEQUOIA 1st Gen



2000-2007



PART NO.	DESCRIPTION	NOTES	O.E.
SSP1975 301191619750	Suspension Ball Joint - Front Upper		4331039016; 4331039085



TOYOTA SIENNA XL10



1998-2003



PART NO.	DESCRIPTION	NOTES	O.E.
SSP0666 301191606660	Steering Tie Rod End - Front		4504629255



TOYOTA SOLARA XV20



1999-2003

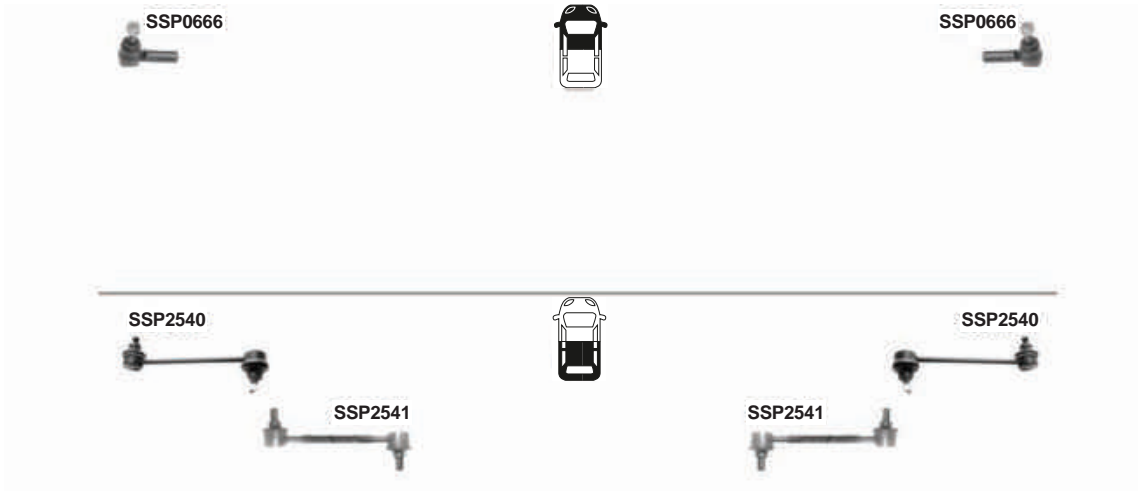

PART NO.	DESCRIPTION	NOTES	O.E.
SSP0666 301191606660	Steering Tie Rod End - Front		4504629255
SSP2540 301191625400	Suspension Stabilizer Bar Link - Front Left		4881006030; 4883033010
SSP2541 301191625410	Suspension Stabilizer Bar Link - Rear		4883006020; 4883048010; 4883006030



PART NO.	DESCRIPTION	NOTES	O.E.
SSP1975 301191619750	Suspension Ball Joint - Front Upper		4331039016; 4331039085



TOYOTA YARIS (P1)



04/1999-10/2005

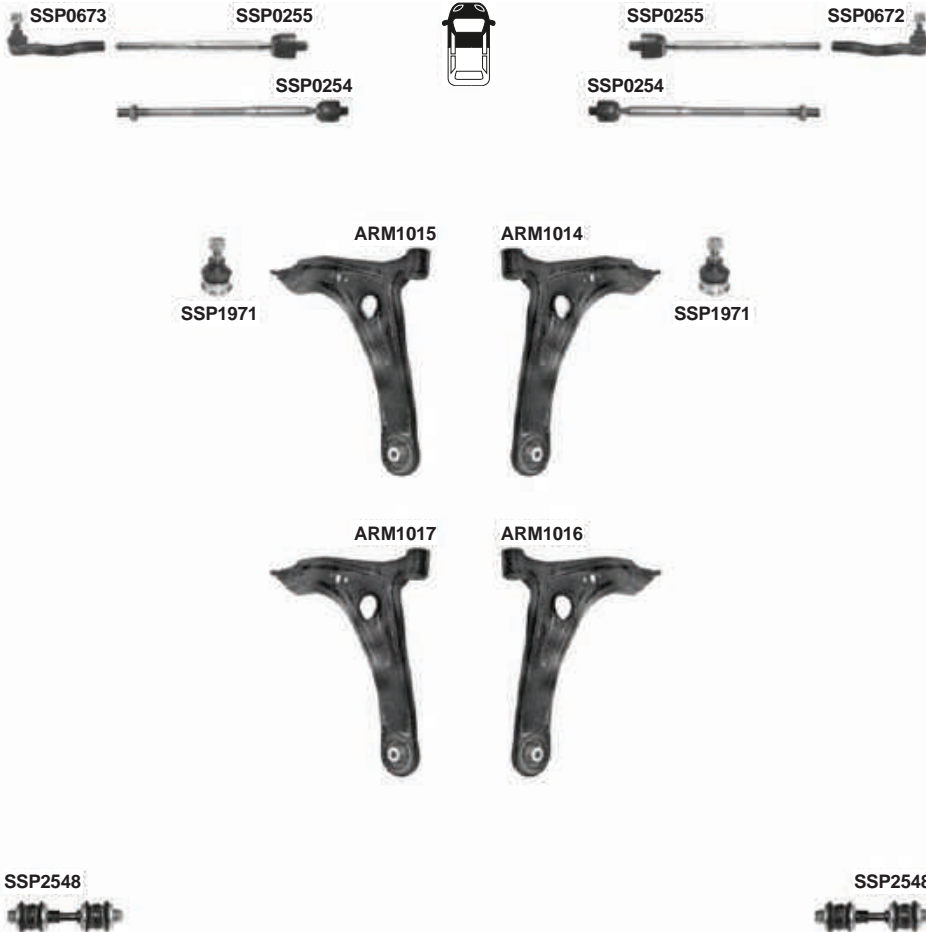

PART NO.	DESCRIPTION	NOTES	O.E.
ARM1014	301181310140	Suspension Control Arm and Ball Joint Assembly - Front Right Lower	4806859035
ARM1015	301181310150	Suspension Control Arm and Ball Joint Assembly - Front Left Lower	4806959035
ARM1016	301181310160	Suspension Control Arm and Ball Joint Assembly - Front Right Lower	4806859055
ARM1017	301181310170	Suspension Control Arm and Ball Joint Assembly - Front Left Lower	4806959055
SSP0254	301191602540	Steering Tie Rod - Front	(1.3i) M14x1,5 - L=339.5mm 4550352030
SSP0255	301191602550	Steering Tie Rod - Front Inner	M12x1,25 - L=240mm 4550352010
SSP0672	301191606720	Steering Tie Rod End - Front Right	M12x1,25Rht 4504659025; 4504659045; 4504659026
SSP0673	301191606730	Steering Tie Rod End - Front Left	M12x1,25Rht 4504759025; 4504759035; 4504759026
SSP1971	301191619710	Suspension Ball Joint - Front Lower	4330859035; 4330859095
SSP2548	301191625480	Suspension Stabilizer Bar Link - Front	Completo KS 3 L=98mm 488170D010 Bush; 9418210800 Nut; 9094802179 Rond smal; 9094802178 Rond Big; 4881952010 S1; 4881952010

TOYOTA YARIS (P9)



11/2005-09/2010



SSP2549



SSP2549

PART NO.	DESCRIPTION	NOTES	O.E.
ARM1018 301181310180	Suspension Control Arm and Ball Joint Assembly - Front Right Lower		4806809041; 4806809150
ARM1019 301181310190	Suspension Control Arm and Ball Joint Assembly - Front Left Lower		4806909040; 4806909140
SSP0256 301191602560	Steering Tie Rod - Front	M14X1,5 - L=239mm	4550352070 Part of
SSP0674 301191606740	Steering Tie Rod End - Front Right	M14x1.5	4504609480; 4504659255
SSP0675 301191606750	Steering Tie Rod End - Front Left	M14x1.5	4504709220; 4504759135; 4504709480
SSP1971 301191619710	Suspension Ball Joint - Front Lower		4330859035; 4330859095
SSP2549 301191625490	Suspension Stabilizer Bar Link - Front	L=360mm	488200D010

**TOYOTA YARIS (P13)**

10/2010-

**SSP0675****SSP0674****SSP1971****ARM1019****ARM1018****SSP1971****SSP2549****SSP2549**

	PART NO.	DESCRIPTION	NOTES	O.E.
ARM1018	301181310180	Suspension Control Arm and Ball Joint Assembly - Front Right Lower		4806809041; 4806809150
ARM1019	301181310190	Suspension Control Arm and Ball Joint Assembly - Front Left Lower		4806909040; 4806909140
SSP0674	301191606740	Steering Tie Rod End - Front Right	M14x1.5	4504609480; 4504659255
SSP0675	301191606750	Steering Tie Rod End - Front Left	M14x1.5	4504709220; 4504759135; 4504709480
SSP1971	301191619710	Suspension Ball Joint - Front Lower		4330859035; 4330859095
SSP2549	301191625490	Suspension Stabilizer Bar Link - Front	L=360mm	488200D010



VAUXHALL ASTRA



1998-

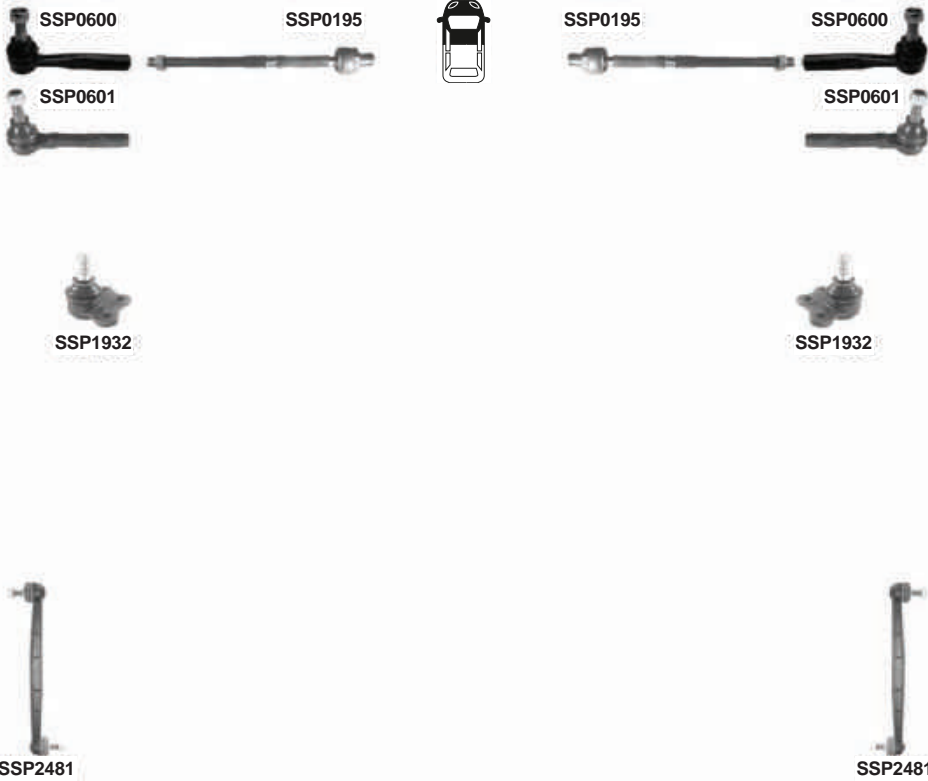

PART NO.	DESCRIPTION	NOTES	O.E.
SSP0195 301191601950	Steering Tie Rod - Front	Trw Steering M14x1,5 - L=280mm	1603213; 9118128; 1603216
SSP0600 301191606000	Steering Tie Rod End - Front	Only: Delphi Steering M14x1,5Rht	1603214
SSP0601 301191606010	Steering Tie Rod End - Front	Only: Trw Steering M14x1,5Rht	1603215
SSP1932 301191619320	Suspension Ball Joint - Front	D=Ø18mm	352800; 5231683; 90512982; 352830; 352829
SSP2481 301191624810	Suspension Stabilizer Bar Link - Front	Plastic L=300mm	350611; 90498745; 350614

**VAUXHALL ASTRA COUPE**

1998-

SSP0600**SSP0195****SSP0195****SSP0600****SSP0601****SSP0601****SSP1932****SSP1932****SSP2481****SSP2481**

PART NO.	DESCRIPTION	NOTES	O.E.
SSP0195 301191601950	Steering Tie Rod - Front	Trw Steering M14x1,5 - L=280mm	1603213; 9118128; 1603216
SSP0600 301191606000	Steering Tie Rod End - Front	Only: Delphi Steering M14x1,5Rht	1603214
SSP0601 301191606010	Steering Tie Rod End - Front	Only: Trw Steering M14x1,5Rht	1603215
SSP1932 301191619320	Suspension Ball Joint - Front	D=Ø18mm	352800; 5231683; 90512982; 352830; 352829
SSP2481 301191624810	Suspension Stabilizer Bar Link - Front	Plastic L=300mm	350611; 90498745; 350614

VAUXHALL CORSA



1993-1997



PART NO.	DESCRIPTION	NOTES	O.E.
ARM869 301181386900	Suspension Control Arm and Ball Joint Assembly - Front Right Lower		352002
ARM870 301181387000	Suspension Control Arm and Ball Joint Assembly - Front Left Lower		352003
SSP1927 301191619270	Suspension Ball Joint - Front	D=Ø15mm	1603128; 90166394; 1603187; 1603161

**VAUXHALL CORSA COMBO**

1993-1997



	PART NO.	DESCRIPTION	NOTES	O.E.
ARM869	301181386900	Suspension Control Arm and Ball Joint Assembly - Front Right Lower		352002
ARM870	301181387000	Suspension Control Arm and Ball Joint Assembly - Front Left Lower		352003
SSP1927	301191619270	Suspension Ball Joint - Front	D=Ø15mm	1603128; 90166394; 1603187; 1603161



VAUXHALL CORSA



1997-2000

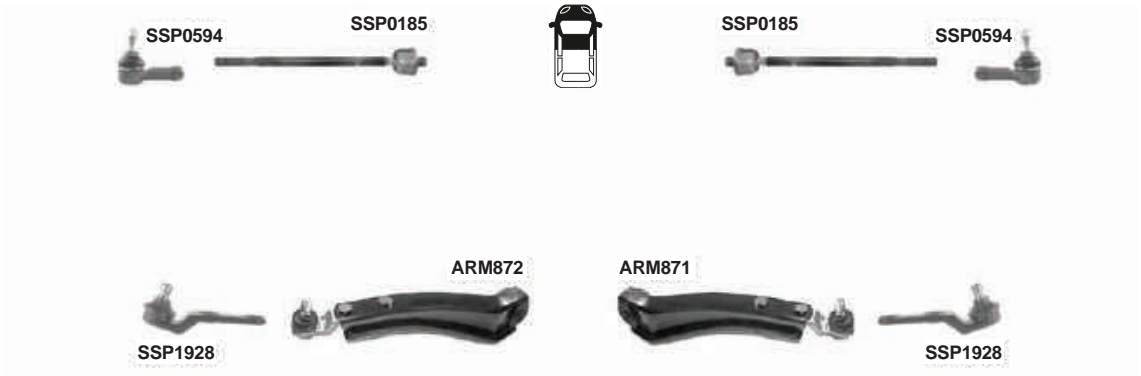

PART NO.	DESCRIPTION	NOTES	O.E.
ARM871 301181387100	Suspension Control Arm and Ball Joint Assembly - Front Right Lower		5352012
ARM872 301181387200	Suspension Control Arm and Ball Joint Assembly - Front Left Lower		5352011
SSP0185 301191601850	Steering Tie Rod - Front	Power Steering M12x1,25 - L=278mm	322158
SSP0594 301191605940	Steering Tie Rod End - Front	M12x1,5Rht	1603009; 324050; 7840452; 324042; 26087868
SSP1928 301191619280	Suspension Ball Joint - Front	D=Ø15mm	1603202; 90539896

**VAUXHALL CORSA COMBO**

1997-

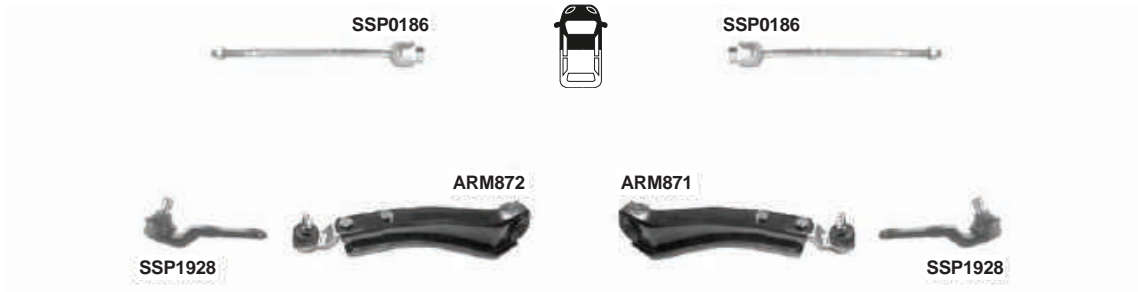

	PART NO.	DESCRIPTION	NOTES	O.E.
ARM871	301181387100	Suspension Control Arm and Ball Joint Assembly - Front Right Lower		5352012
ARM872	301181387200	Suspension Control Arm and Ball Joint Assembly - Front Left Lower		5352011
SSP0186	301191601860	Steering Tie Rod - Front	Manual Steering M12x1,5 - L=322mm	26030411; 322155
SSP1928	301191619280	Suspension Ball Joint - Front	D=Ø15mm	1603202; 90539896



VAUXHALL NOVA



1982-1993



	PART NO.	DESCRIPTION	NOTES	O.E.
SSP0594	301191605940	Steering Tie Rod End - Front	M12x1,5Rht	1603009; 324050; 7840452; 324042; 26087868
SSP1927	301191619270	Suspension Ball Joint - Front	D=Ø15mm	1603128; 90166394; 1603187; 1603161



VAUXHALL TIGRA



1994-1997



	PART NO.	DESCRIPTION	NOTES	O.E.
ARM869	301181386900	Suspension Control Arm and Ball Joint Assembly - Front Right Lower		352002
ARM870	301181387000	Suspension Control Arm and Ball Joint Assembly - Front Left Lower		352003
SSP1927	301191619270	Suspension Ball Joint - Front	D=Ø15mm	1603128; 90166394; 1603187; 1603161



VAUXHALL TIGRA



1997-

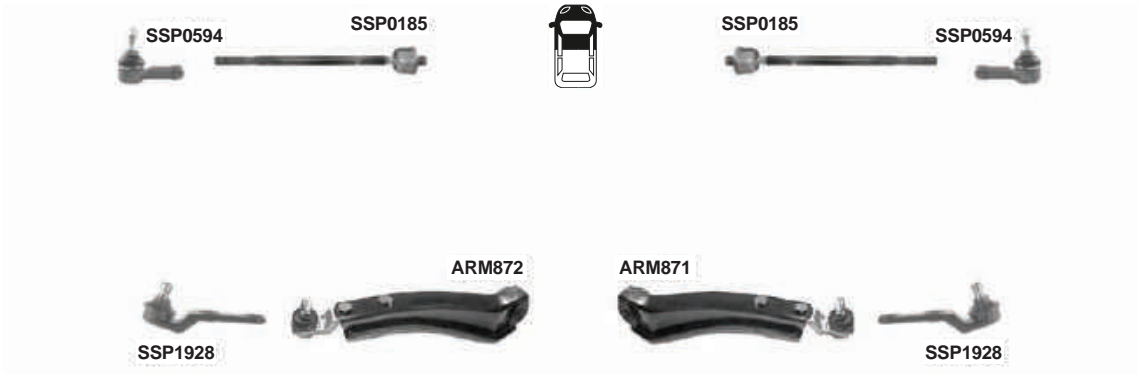

	PART NO.	DESCRIPTION	NOTES	O.E.
ARM871	301181387100	Suspension Control Arm and Ball Joint Assembly - Front Right Lower		5352012
ARM872	301181387200	Suspension Control Arm and Ball Joint Assembly - Front Left Lower		5352011
SSP0185	301191601850	Steering Tie Rod - Front	Power Steering M12x1,25 - L=278mm	322158
SSP0594	301191605940	Steering Tie Rod End - Front	M12x1,5Rht	1603009; 324050; 7840452; 324042; 26087868
SSP1928	301191619280	Suspension Ball Joint - Front	D=Ø15mm	1603202; 90539896



VAUXHALL VECTRA



1996-



	PART NO.	DESCRIPTION	NOTES	O.E.
ARM885	301181388500	Suspension Control Arm and Ball Joint Assembly - Front Right Lower		352004; 90496040; 5352017
ARM886	301181388600	Suspension Control Arm and Ball Joint Assembly - Front Left Lower		352005; 90496039; 5352016
SSP1932	301191619320	Suspension Ball Joint - Front	D=Ø18mm	352800; 5231683; 90512982; 352830; 352829



VAUXHALL VECTRA C



2002-



SSP1449



SSP1448



ARM118



ARM117

	PART NO.	DESCRIPTION	NOTES	O.E.
ARM117	301181311700	Suspension Control Arm and Ball Joint Assembly - Front Right Lower		352052; 51748652; 12799200; 12796014
ARM118	301181311800	Suspension Control Arm and Ball Joint Assembly - Front Left Lower		352051; 51748653; 12799200; 12796013
SSP1448	301181314480	Steering Tie Rod End - Front Right	M14x1,5Rht	1603228; 5239322; 5235668
SSP1449	301181314490	Steering Tie Rod End - Front Left	M14x1,5Rht	1603227; 5239314; 5235650



VAUXHALL ZAFIRA



1999-



PART NO.	DESCRIPTION	NOTES	O.E.
SSP0195 301191601950	Steering Tie Rod - Front	Trw Steering M14x1,5 - L=280mm	1603213; 9118128; 1603216
SSP0600 301191606000	Steering Tie Rod End - Front	Only: Delphi Steering M14x1,5Rht	1603214
SSP0601 301191606010	Steering Tie Rod End - Front	Only: Trw Steering M14x1,5Rht	1603215
SSP1932 301191619320	Suspension Ball Joint - Front	D=Ø18mm	352800; 5231683; 90512982; 352830; 352829
SSP2481 301191624810	Suspension Stabilizer Bar Link - Front	Plastic L=300mm	350611; 90498745; 350614



VOLKSWAGEN AMAROK



09/2010-

SSP0697

SSP0267



SSP0267

SSP0696



ARM1043



ARM1042



ARM1045



ARM1044



SSP2570



SSP2570



SSP2569



SSP2569

PART NO.	DESCRIPTION	NOTES	O.E.
ARM1042 301181310420	Suspension Control Arm and Ball Joint Assembly - Front Right Upper		2H0407022B
ARM1043 301181310430	Suspension Control Arm and Ball Joint Assembly - Front Left Upper		2H0407021B
ARM1044 301181310440	Suspension Control Arm and Ball Joint Assembly - Front Right Lower		2H0407152A
ARM1045 301181310450	Suspension Control Arm and Ball Joint Assembly - Front Left Lower		2H0407151A
SSP0267 301191602670	Steering Tie Rod - Front	M16x1,5Rht - L=287,5mm	1160310016; 7L0422821
SSP0696 301191606960	Steering Tie Rod End - Front Right	M16x1,5Rht	7L0422818B; 95534713220; 7L0422818D; 7L0422818C
SSP0697 301191606970	Steering Tie Rod End - Front Left	M16x1,5Rht	7L0422817B; 95534713221; 7L0422817D; 7L0422817C
SSP2569 301191625690	Suspension Stabilizer Bar Link - Front	L=145mm	2H0411317
SSP2570 301191625700	Suspension Stabilizer Bar Link - Front	PLASTIC TYPE	2H0411317B



MAGNETI
MARELLI

VOLKSWAGEN BEETLE



1980-1988

SSP0282



SSP0282



PART NO.	DESCRIPTION	NOTES	O.E.
SSP0282 301191602820	Steering Tie Rod End - Front	M14x1,5Rht	811419812A; 811419812B



VOLKSWAGEN BEETLE 9C1, 1C1



1998-2010

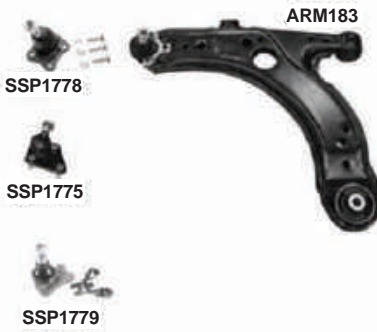

**VOLKSWAGEN BEETLE 9C1, 1C1****1998-2010**

	PART NO.	DESCRIPTION	NOTES	O.E.
ARM182	301181318200	Suspension Control Arm and Ball Joint Assembly - Front Right Lower		1J0407151B
ARM183	301181318300	Suspension Control Arm and Ball Joint Assembly - Front Left Lower		1J0407151A
SSP0003	301191600030	Steering Tie Rod - Front Inner	- Ch.8L-W-050-423 -> M14x1,5 - L=320mm	1J0422807; 1J0422807A
SSP0005	301191600050	Steering Tie Rod - Front	L=338mm Ch.No.-> 8L-W-050-422 M14x1,5 Rht	1J0422821A
SSP0283	301191602830	Steering Tie Rod End - Front Right	Ch.8L-W-050-423 -> M14x1,5 Rht	1J0422812B; 6R0423812A; 6Q0419812; 1J0422812R; 3A0422812B
SSP0284	301191602840	Steering Tie Rod End - Front Left	Ch.8L-W-050-423 -> M14x1,5 Rht	1J0422811B; 6R0423811A; 6Q0419811; 1J0422811R; 3A0422811B
SSP0285	301191602850	Steering Tie Rod End - Front Right Outer	Ch. >>8L-W-050-422 M14x1,5 Rht	1J0422812A; 1J0422812L
SSP0286	301191602860	Steering Tie Rod End - Front Left Outer	Ch. >>8L-W-050-422 M14x1,5 Rht	1J0422811A; 1J0422811L
SSP1775	301191617750	Suspension Ball Joint - Front Lower	Only: VW Golf IV R32 4Mot.- VW Nev Beetle 3.2 Rsi	8N0407365A; 8N0407365B; 8N0407365C
SSP1776	301191617760	Suspension Ball Joint - Front Right Lower		1J0407366A; 1J0407366B; 1J0407366C
SSP1777	301191617770	Suspension Ball Joint - Front Right Lower	Kit	1J0407366A/B/C*
SSP1778	301191617780	Suspension Ball Joint - Front Left Lower		1J0407365A; 1J0407365D; 1J0407365B; 1J0407365C
SSP1779	301191617790	Suspension Ball Joint - Front Left Lower	Kit	1J0407366A/B/C*
SSP2002	301191620020	Suspension Stabilizer Bar Link - Front Left	4 Motion L=336mm	1J0411315D
SSP2004	301191620040	Suspension Stabilizer Bar Link - Front Right	4 Motion L=336mm	1J0411316D
SSP2023	301191620230	Suspension Stabilizer Bar Link - Rear	VW TDI 4motion L=175mm	1J0505466B
SSP2571	301191625710	Suspension Stabilizer Bar Link - Front	Plastic L=105,5mm	1J0411315C
SSP2572	301191625720	Suspension Stabilizer Bar Link - Front	Metal L=105mm	1J0411315H; 1J0422315G
SSP2573	301191625730	Suspension Stabilizer Bar Link - Front Right	Only:Golf IV Ch.No. -> OPT858 L=340mm	68510018
SSP2574	301191625740	Suspension Stabilizer Bar Link - Front Left	Only:Golf IV Ch.No. -> OPT858 L=340mm	68510017
SSP2575	301191625750	Suspension Stabilizer Bar Link - Front	Plastic Only:GOLF IV L=105mm	1J0411315K



VOLKSWAGEN BEETLE A5



04/2011-

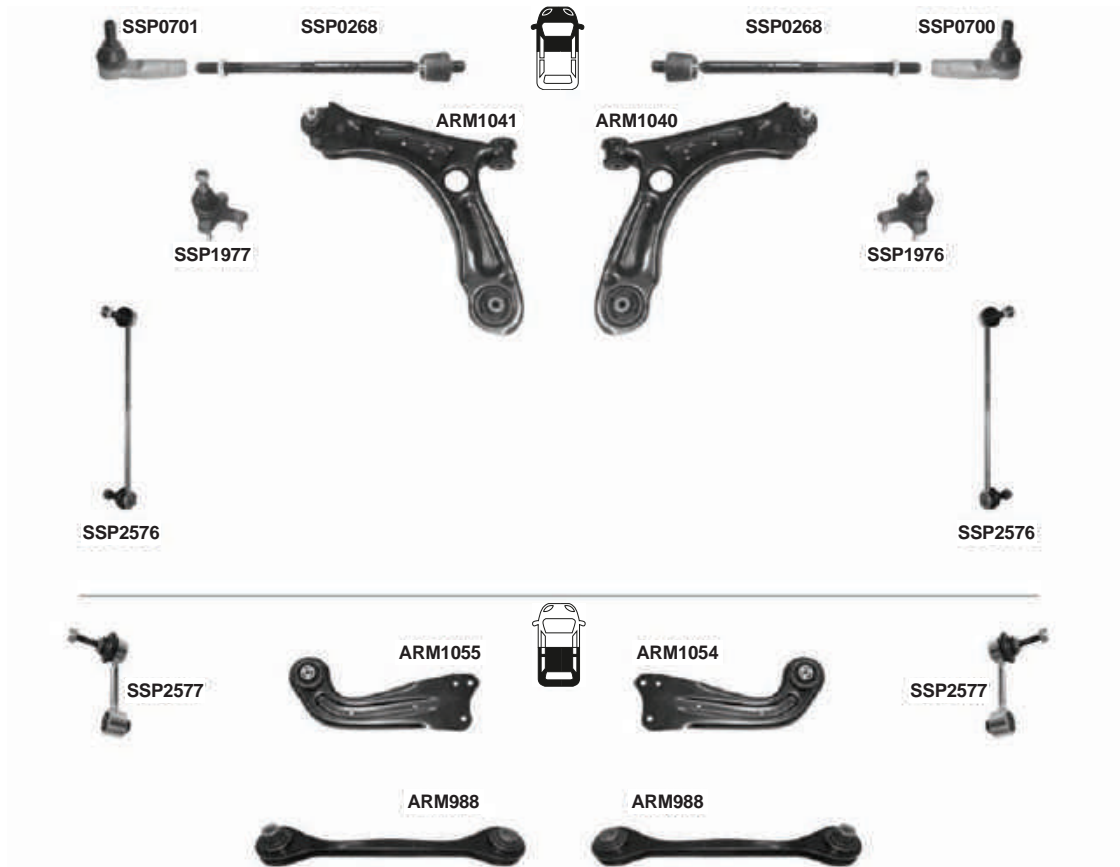

PART NO.	DESCRIPTION	NOTES	O.E.
ARM988 301181398800	Lateral Arm - Rear Lower	L=298mm	1K0501529J
ARM1040 301181310400	Suspension Control Arm and Ball Joint Assembly - Front Right Lower		561407152A*
ARM1041 301181310410	Suspension Control Arm and Ball Joint Assembly - Front Left Lower		561407151A*
ARM1054 301181310540	Lateral Arm - Rear Right Forward		1K0505224K
ARM1055 301181310550	Lateral Arm - Rear Left Forward		1K0505223K
SSP0268 301191602680	Steering Tie Rod - Front Inner		561423810
SSP0700 301191607000	Steering Tie Rod End - Front Right	M16x1,5Rht	1K0423812A; 1K0423812J; 1K0423812K; 1K0423812G; 1K0423812E
SSP0701 301191607010	Steering Tie Rod End - Front Left	M16x1,5Rht	1K0423811A; 1K0423811J; 1K0423811K; 1K0423811G; 1K0423811E
SSP1976 301191619760	Suspension Ball Joint - Front Right Lower		1K0407366B; 5Q0407366A; 1K0407366E; 1K0407366C
SSP1977 301191619770	Suspension Ball Joint - Front Left Lower		1K0407365B; 5Q0407365A; 1K0407365E; 1K0407365C
SSP2576 301191625760	Suspension Stabilizer Bar Link - Front	L=335mm	1K0411315B; 1K0411315D; 1K0411315J
SSP2577 301191625770	Suspension Stabilizer Bar Link - Rear	L=95,5 mm	1K0505465C; 1K0505465J; 1K0505465K; 1K0505465H; 1K0505465D



MAGNETI
MARELLI

VOLKSWAGEN CADDY Typ 2K



03/2004-04/2015



SSP0701



SSP0700



SSP1977



ARM1049



ARM1048



SSP1976



ARM1051



ARM1050



ARM1063



ARM1062



SSP2576



SSP2576

SSP2578



SSP2578





VOLKSWAGEN CADDY Typ 2K



03/2004-04/2015

PART NO.	DESCRIPTION	NOTES	O.E.
ARM1048 301181310480	Suspension Control Arm and Ball Joint Assembly - Front Right Lower	Only: Petrol	1K0407152P*; 1K0407152Q*
ARM1049 301181310490	Suspension Control Arm and Ball Joint Assembly - Front Left Lower	Only: Petrol	1K0407151P*; 1K0407151Q*
ARM1050 301181310500	Suspension Control Arm and Ball Joint Assembly - Front Right Lower	Only: Diesel	1K0407152AC
ARM1051 301181310510	Suspension Control Arm and Ball Joint Assembly - Front Left Lower	Only: Diesel	1K0407151AC
ARM1062 301181310620	Suspension Control Arm and Ball Joint Assembly - Front Right Lower	Mod: 03/2011-04/2015	1K0407152BG*
ARM1063 301181310630	Suspension Control Arm and Ball Joint Assembly - Front Left Lower	Mod: 03/2011-04/2015	1K0407151BG*
SSP0700 301191607000	Steering Tie Rod End - Front Right	M16x1,5Rht	1K0423812A; 1K0423812J; 1K0423812K; 1K0423812G; 1K0423812E
SSP0701 301191607010	Steering Tie Rod End - Front Left	M16x1,5Rht	1K0423811A; 1K0423811J; 1K0423811K; 1K0423811G; 1K0423811E
SSP1976 301191619760	Suspension Ball Joint - Front Right Lower		1K0407366B; 5Q0407366A; 1K0407366E; 1K0407366C
SSP1977 301191619770	Suspension Ball Joint - Front Left Lower		1K0407365B; 5Q0407365A; 1K0407365E; 1K0407365C
SSP2576 301191625760	Suspension Stabilizer Bar Link - Front	L=335mm	1K0411315B; 1K0411315D; 1K0411315J
SSP2578 301191625780	Suspension Stabilizer Bar Link - Rear	L=241mm	2K0505465B; 2K0505465C



MAGNETI
MARELLI

VOLKSWAGEN CORRADO 531



08/1987-12/1995

SSP0699



SSP0698



PART NO.	DESCRIPTION	NOTES	O.E.
SSP0698 301191606980	Steering Tie Rod End - Front Right	M14x1,5Rht	171419812; 3A0422812; 191419812
SSP0699 301191606990	Steering Tie Rod End - Front Left Outer	M14x1,5Rht	191419811; 3A0422811



VOLKSWAGEN CRAFTER



04/2006-

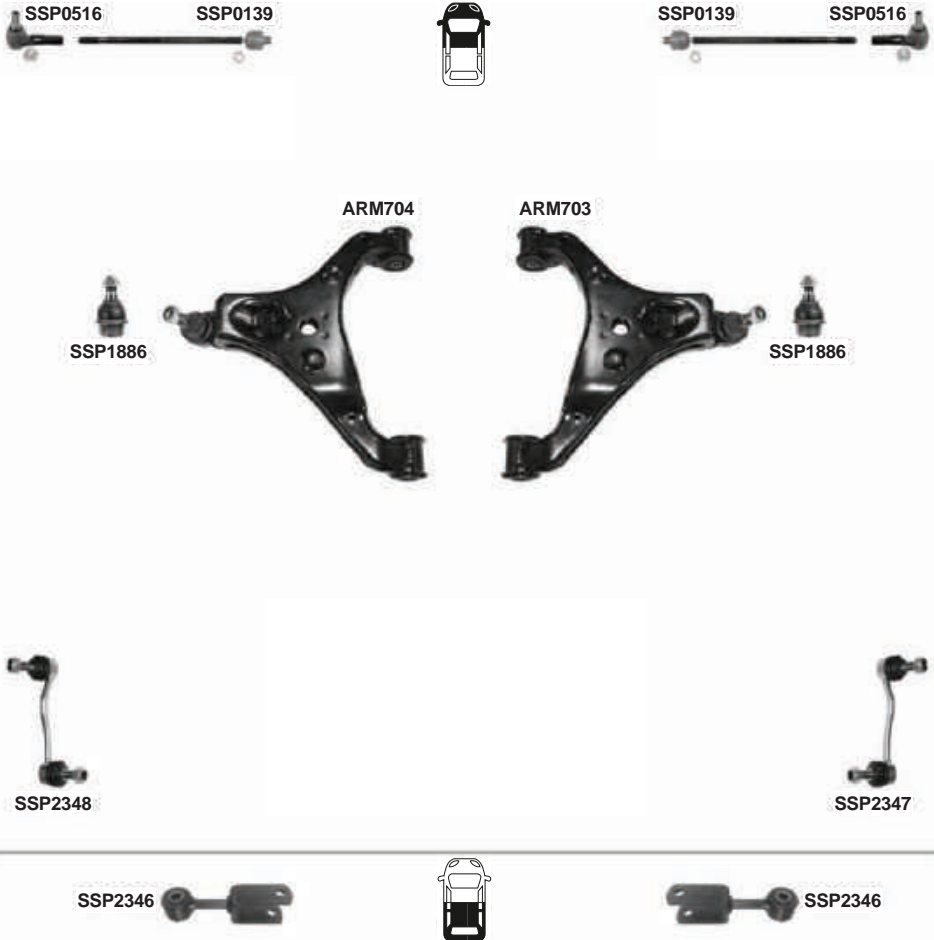

PART NO.	DESCRIPTION	NOTES	O.E.
ARM703	301181370300 Suspension Control Arm and Ball Joint Assembly - Front Right Lower		2E0407152M; 9063304107
ARM704	301181370400 Suspension Control Arm and Ball Joint Assembly - Front Left Lower		2E0407151M; 9063304007
SSP0139	301191601390 Steering Tie Rod - Front	M16x1,5 - L=394,5mm	2E0713491; 9064600055
SSP0516	301191605160 Steering Tie Rod End - Front	M16x1,5	2E0713501; 9064600048
SSP1886	301191618860 Suspension Ball Joint - Front Lower		9063304007
SSP2346	301191623460 Suspension Stabilizer Bar Link - Rear		2E0511051G; 9063201489
SSP2347	301191623470 Suspension Stabilizer Bar Link - Front Right	L=137,5mm	2E0411318C; 9063201889
SSP2348	301191623480 Suspension Stabilizer Bar Link - Front Left	L=137,5mm	2E0411317C; 9063201789



VOLKSWAGEN EOS



2006-2016

**SSP0269****SSP0269****SSP0700****SSP1977****SSP1976****SSP2576****SSP2576****SSP2577****ARM189****ARM189****SSP2577**

PART NO.	DESCRIPTION	NOTES	O.E.
ARM189 301181318900	Lateral Arm - Rear Upper		1K0505323N
SSP0269 301191602690	Steering Tie Rod - Front Inner	M16x1,5 - L=310mm	1K0423810A
SSP0700 301191607000	Steering Tie Rod End - Front Right	M16x1,5Rht	1K0423812A; 1K0423812J; 1K0423812K; 1K0423812G; 1K0423812E
SSP0701 301191607010	Steering Tie Rod End - Front Left	M16x1,5Rht	1K0423811A; 1K0423811J; 1K0423811K; 1K0423811G; 1K0423811E
SSP1976 301191619760	Suspension Ball Joint - Front Right Lower		1K0407366B; 5Q0407366A; 1K0407366E; 1K0407366C
SSP1977 301191619770	Suspension Ball Joint - Front Left Lower		1K0407365B; 5Q0407365A; 1K0407365E; 1K0407365C
SSP2576 301191625760	Suspension Stabilizer Bar Link - Front	L=335mm	1K0411315B; 1K0411315D; 1K0411315J
SSP2577 301191625770	Suspension Stabilizer Bar Link - Rear	L=95,5 mm	1K0505465C; 1K0505465J; 1K0505465K; 1K0505465H; 1K0505465D



VOLKSWAGEN GOLF MK2/A2



1983-1992

SSP0699



SSP0698



PART NO.	DESCRIPTION	NOTES	O.E.
SSP0698 301191606980	Steering Tie Rod End - Front Right	M14x1,5Rht	171419812; 3A0422812; 191419812
SSP0699 301191606990	Steering Tie Rod End - Front Left Outer	M14x1,5Rht	191419811; 3A0422811

**VOLKSWAGEN GOLF MK3/A3**

1991-1998

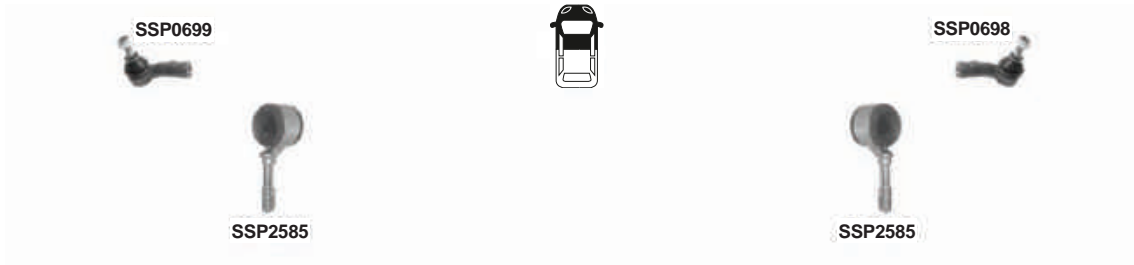

PART NO.	DESCRIPTION	NOTES	O.E.
SSP0698 301191606980	Steering Tie Rod End - Front Right	M14x1,5Rht	171419812; 3A0422812; 191419812
SSP0699 301191606990	Steering Tie Rod End - Front Left Outer	M14x1,5Rht	191419811; 3A0422811
SSP2585 301191625850	Suspension Stabilizer Bar Link - Front	L=78mm - D=Ø18mm	191411315A; 191411327



VOLKSWAGEN GOLF MK4/A4



1998-09/2003

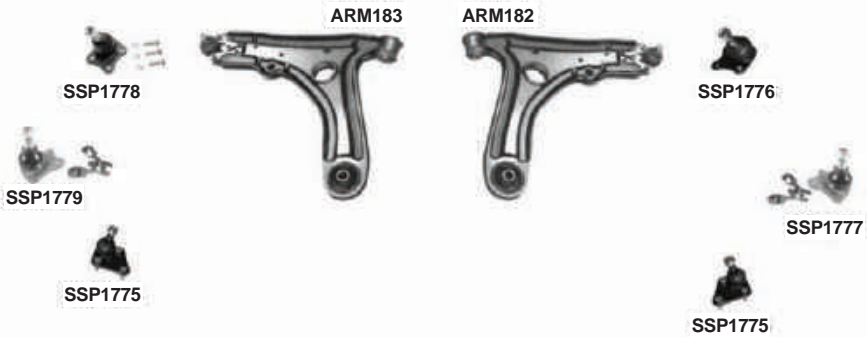

**VOLKSWAGEN GOLF MK4/A4**

1998-09/2003

PART NO.	DESCRIPTION	NOTES	O.E.
ARM169	301181316900 Lateral Arm - Rear		1J0505323L; 1J0505323E; 1J0505323H; 1J0505323M
ARM182	301181318200 Suspension Control Arm and Ball Joint Assembly - Front Right Lower		1J0407151B
ARM183	301181318300 Suspension Control Arm and Ball Joint Assembly - Front Left Lower		1J0407151A
SSP0003	301191600030 Steering Tie Rod - Front Inner	- Ch.8L-W-050-423 -> M14x1,5 - L=320mm	1J0422807; 1J0422807A
SSP0005	301191600050 Steering Tie Rod - Front	L=338mm Ch.No.-> 8L-W-050-422 M14x1,5 Rht	1J0422821A
SSP0283	301191602830 Steering Tie Rod End - Front Right	Ch.8L-W-050-423 -> M14x1,5 Rht	1J0422812B; 6R0423812A; 6Q0419812; 1J0422812R; 3A0422812B
SSP0284	301191602840 Steering Tie Rod End - Front Left	Ch.8L-W-050-423 -> M14x1,5 Rht	1J0422811B; 6R0423811A; 6Q0419811; 1J0422811R; 3A0422811B
SSP0285	301191602850 Steering Tie Rod End - Front Right Outer	Ch. >>8L-W-050-422 M14x1,5 Rht	1J0422812A; 1J0422812L
SSP0286	301191602860 Steering Tie Rod End - Front Left Outer	Ch. >>8L-W-050-422 M14x1,5 Rht	1J0422811A; 1J0422811L
SSP1775	301191617750 Suspension Ball Joint - Front Lower	Only: VW Golf IV R32 4Mot.- VW Nev Beetle 3.2 Rsi	8N0407365A; 8N0407365B; 8N0407365C
SSP1776	301191617760 Suspension Ball Joint - Front Right Lower		1J0407366A; 1J0407366B; 1J0407366C
SSP1777	301191617770 Suspension Ball Joint - Front Right Lower	Kit	1J0407366A/B/C*
SSP1778	301191617780 Suspension Ball Joint - Front Left Lower		1J0407365A; 1J0407365D; 1J0407365B; 1J0407365C
SSP1779	301191617790 Suspension Ball Joint - Front Left Lower	Kit	1J0407366A/B/C*
SSP2002	301191620020 Suspension Stabilizer Bar Link - Front Left	4 Motion L=336mm	1J0411315D
SSP2003	301191620030 Suspension Stabilizer Bar Link - Front Left	4 Motion (Clip-on patented design) L=336mm	1J0411315D
SSP2004	301191620040 Suspension Stabilizer Bar Link - Front Right	4 Motion L=336mm	1J0411316D
SSP2023	301191620230 Suspension Stabilizer Bar Link - Rear	VW TDI 4motion L=175mm	1J0505466B
SSP2571	301191625710 Suspension Stabilizer Bar Link - Front	Plastic L=105,5mm	1J0411315C
SSP2572	301191625720 Suspension Stabilizer Bar Link - Front	Metal L=105mm	1J0411315H; 1J0422315G
SSP2573	301191625730 Suspension Stabilizer Bar Link - Front Right	Only:Golf IV Ch.No: -> OPT858 L=340mm	68510018
SSP2574	301191625740 Suspension Stabilizer Bar Link - Front Left	Only:Golf IV Ch.No: -> OPT858 L=340mm	68510017
SSP2575	301191625750 Suspension Stabilizer Bar Link - Front	Plastic Only:GOLF IV L=105mm	1J0411315K



VOLKSWAGEN GOLF MK5/A5



10/2003-06/2009



SSP2578



SSP2578



**VOLKSWAGEN GOLF MK5/A5**

10/2003-06/2009

PART NO.	DESCRIPTION	NOTES	O.E.
ARM189	301181318900 Lateral Arm - Rear Upper		1K0505323N
ARM982	301181398200 Lateral Arm - Rear Right Lower	L=298mm	1K0501530C
ARM983	301181398300 Lateral Arm - Rear Left Lower	L=298mm	1K0501529F
ARM988	301181398800 Lateral Arm - Rear Lower	L=298mm	1K0501529J
ARM1048	301181310480 Suspension Control Arm and Ball Joint Assembly - Front Right Lower	Only: Petrol	1K0407152P*; 1K0407152Q*
ARM1049	301181310490 Suspension Control Arm and Ball Joint Assembly - Front Left Lower	Only: Petrol	1K0407151P*; 1K0407151Q*
ARM1050	301181310500 Suspension Control Arm and Ball Joint Assembly - Front Right Lower	Only: Diesel	1K0407152AC
ARM1051	301181310510 Suspension Control Arm and Ball Joint Assembly - Front Left Lower	Only: Diesel	1K0407151AC
SSP0269	301191602690 Steering Tie Rod - Front Inner	M16x1,5 - L=310mm	1K0423810A
SSP0700	301191607000 Steering Tie Rod End - Front Right	M16x1,5Rht	1K0423812A; 1K0423812J; 1K0423812K; 1K0423812G; 1K0423812E
SSP0701	301191607010 Steering Tie Rod End - Front Left	M16x1,5Rht	1K0423811A; 1K0423811J; 1K0423811K; 1K0423811G; 1K0423811E
SSP1976	301191619760 Suspension Ball Joint - Front Right Lower		1K0407366B; 5Q0407366A; 1K0407366E; 1K0407366C
SSP1977	301191619770 Suspension Ball Joint - Front Left Lower		1K0407365B; 5Q0407365A; 1K0407365E; 1K0407365C
SSP2576	301191625760 Suspension Stabilizer Bar Link - Front	L=335mm	1K0411315B; 1K0411315D; 1K0411315J
SSP2577	301191625770 Suspension Stabilizer Bar Link - Rear	L=95,5 mm	1K0505465C; 1K0505465J; 1K0505465K; 1K0505465H; 1K0505465D
SSP2578	301191625780 Suspension Stabilizer Bar Link - Rear	L=241mm	2K0505465B; 2K0505465C



VOLKSWAGEN GOLF MK6/A6



2010-2013

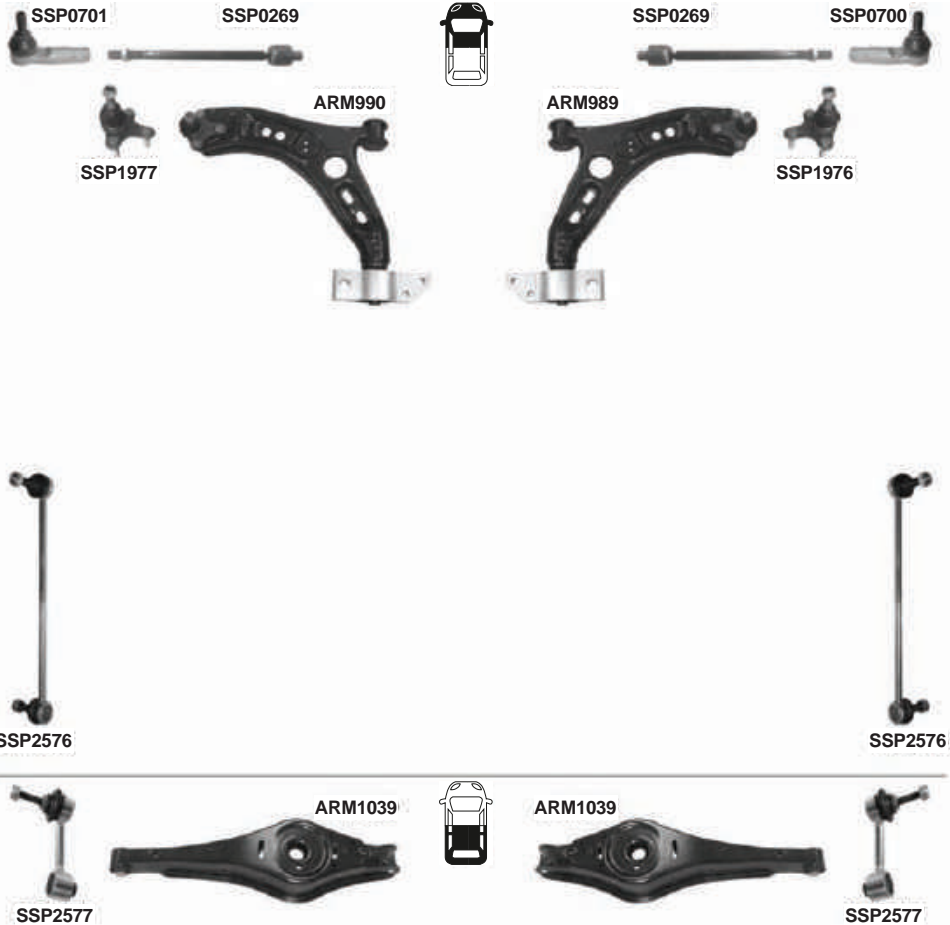

PART NO.	DESCRIPTION	NOTES	O. E.
ARM989	301181398900 Suspension Control Arm and Ball Joint Assembly - Front Right Lower		1K0407152BC*
ARM990	301181399000 Suspension Control Arm and Ball Joint Assembly - Front Left Lower		1K0407151BC*
ARM1039	301181310390 Lateral Arm - Rear Lower		1K0505311AA; 1K0505311S; 1K0505311AB
SSP0269	301191602690 Steering Tie Rod - Front Inner	M16x1,5 - L=310mm	1K0423810A
SSP0700	301191607000 Steering Tie Rod End - Front Right	M16x1,5Rht	1K0423812A; 1K0423812J; 1K0423812K; 1K0423812G; 1K0423812E
SSP0701	301191607010 Steering Tie Rod End - Front Left	M16x1,5Rht	1K0423811A; 1K0423811J; 1K0423811K; 1K0423811G; 1K0423811E
SSP1976	301191619760 Suspension Ball Joint - Front Right Lower		1K0407366B; 5Q0407366A; 1K0407366E; 1K0407366C
SSP1977	301191619770 Suspension Ball Joint - Front Left Lower		1K0407365B; 5Q0407365A; 1K0407365E; 1K0407365C
SSP2576	301191625760 Suspension Stabilizer Bar Link - Front	L=335mm	1K0411315B; 1K0411315D; 1K0411315J
SSP2577	301191625770 Suspension Stabilizer Bar Link - Rear	L=95,5 mm	1K0505465C; 1K0505465J; 1K0505465K; 1K0505465H; 1K0505465D



VOLKSWAGEN GOLF MK7/MQB 11/2012-

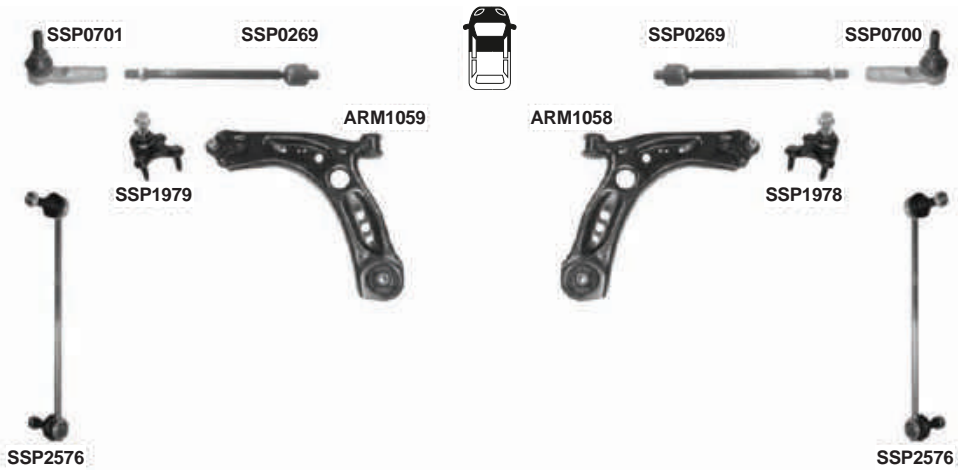



VOLKSWAGEN GOLF MK7/MQB 11/2012-

PART NO.	DESCRIPTION	NOTES	O.E.
ARM1039 301181310390	Lateral Arm - Rear Lower		1K0505311AA; 1K0505311S; 1K0505311AB
ARM1054 301181310540	Lateral Arm - Rear Right Forward		1K0505224K
ARM1055 301181310550	Lateral Arm - Rear Left Forward		1K0505223K
ARM1056 301181310560	Lateral Arm - Rear Lower Forward		5Q0501529C
ARM1057 301181310570	Lateral Arm - Rear Upper		5Q0505323C; 5Q0505323D
ARM1058 301181310580	Suspension Control Arm and Ball Joint Assembly - Front Right Lower		5Q0407152J*
ARM1059 301181310590	Suspension Control Arm and Ball Joint Assembly - Front Left Lower		5Q0407151J*
SSP0269 301191602690	Steering Tie Rod - Front Inner	M16x1,5 - L=310mm	1K0423810A
SSP0700 301191607000	Steering Tie Rod End - Front Right	M16x1,5Rht	1K0423812A; 1K0423812J; 1K0423812K; 1K0423812G; 1K0423812E
SSP0701 301191607010	Steering Tie Rod End - Front Left	M16x1,5Rht	1K0423811A; 1K0423811J; 1K0423811K; 1K0423811G; 1K0423811E
SSP1978 301191619780	Suspension Ball Joint - Front Right Lower		3C0407366B
SSP1979 301191619790	Suspension Ball Joint - Front Left Lower		3C0407365B
SSP2576 301191625760	Suspension Stabilizer Bar Link - Front	L=335mm	1K0411315B; 1K0411315D; 1K0411315J
SSP2579 301191625790	Suspension Stabilizer Bar Link - Rear	L=70mm	5Q0505465C; 5Q0505465A



PART NO.	DESCRIPTION	NOTES	O.E.
ARM239 301181323900	Lateral Arm - Rear Lower		7L8501529A
ARM1033 301181310330	Suspension Control Arm and Ball Joint Assembly - Front Upper	Alum.	7L0407021A; 95534102702; 95534102701; 7L0407021B
ARM1034 301181310340	Lateral Arm - Rear Upper Forward		7L0505323A
ARM1035 301181310350	Suspension Control Arm and Ball Joint Assembly - Front Right		7L0407152C; 95534101832; 7L0407152D
ARM1036 301181310360	Suspension Control Arm and Ball Joint Assembly - Front Left		7L0407151C; 95534101731; 7L0407151D
SSP0267 301191602670	Steering Tie Rod - Front	M16x1,5Rht - L=287,5mm	1160310016; 7L0422821
SSP0696 301191606960	Steering Tie Rod End - Front Right	M16x1,5Rht	7L0422818B; 95534713220; 7L0422818D; 7L0422818C
SSP0697 301191606970	Steering Tie Rod End - Front Left	M16x1,5Rht	7L0422817B; 95534713221; 7L0422817D; 7L0422817C
SSP2566 301191625660	Suspension Stabilizer Bar Link - Front	L=197mm	7L0411317
SSP2567 301191625670	Suspension Stabilizer Bar Link - Rear Right	L=201mm	7L0505466A; 95533307010
SSP2568 301191625680	Suspension Stabilizer Bar Link - Rear Left	L=201mm	7L0505465A; 95533307011



VOLKSWAGEN GTI MK5/A5



2006-2009

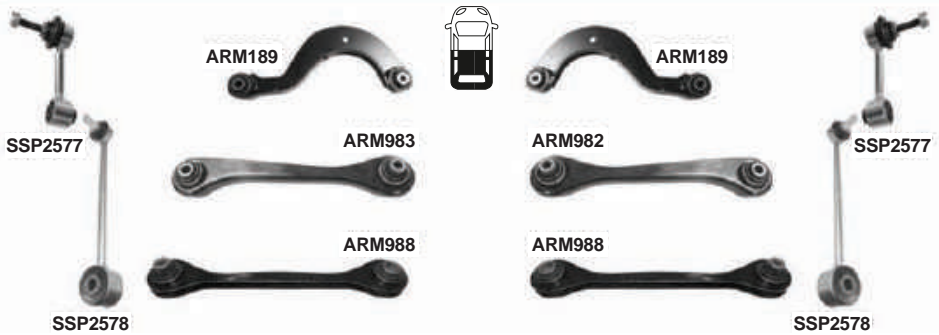
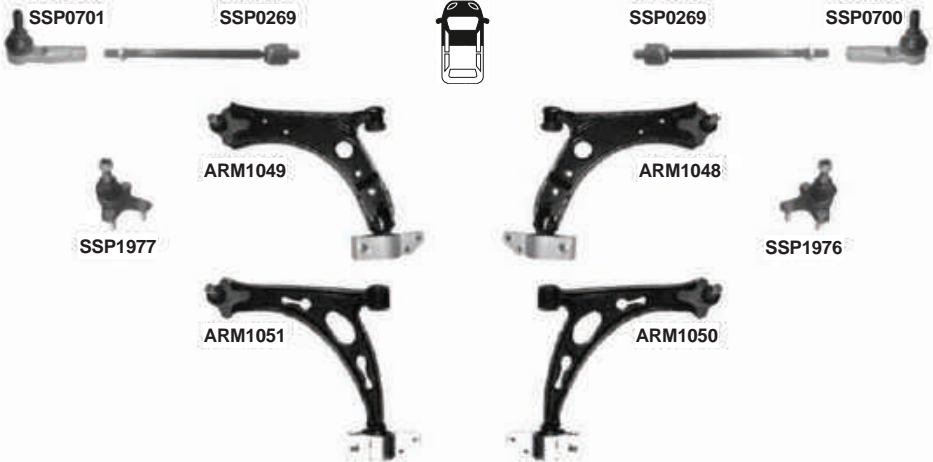

**MAGNETI
MARELLI**

VOLKSWAGEN GTI MK5/A5



2006-2009

PART NO.	DESCRIPTION	NOTES	O.E.
ARM189	301181318900 Lateral Arm - Rear Upper		1K0505323N
ARM982	301181398200 Lateral Arm - Rear Right Lower	L=298mm	1K0501530C
ARM983	301181398300 Lateral Arm - Rear Left Lower	L=298mm	1K0501529F
ARM988	301181398800 Lateral Arm - Rear Lower	L=298mm	1K0501529J
ARM1048	301181310480 Suspension Control Arm and Ball Joint Assembly - Front Right Lower	Only: Petrol	1K0407152P*; 1K0407152Q*
ARM1049	301181310490 Suspension Control Arm and Ball Joint Assembly - Front Left Lower	Only: Petrol	1K0407151P*; 1K0407151Q*
ARM1050	301181310500 Suspension Control Arm and Ball Joint Assembly - Front Right Lower	Only: Diesel	1K0407152AC
ARM1051	301181310510 Suspension Control Arm and Ball Joint Assembly - Front Left Lower	Only: Diesel	1K0407151AC
SSP0269	301191602690 Steering Tie Rod - Front Inner	M16x1,5 - L=310mm	1K0423810A
SSP0700	301191607000 Steering Tie Rod End - Front Right	M16x1,5Rht	1K0423812A; 1K0423812J; 1K0423812K; 1K0423812G; 1K0423812E
SSP0701	301191607010 Steering Tie Rod End - Front Left	M16x1,5Rht	1K0423811A; 1K0423811J; 1K0423811K; 1K0423811G; 1K0423811E
SSP1976	301191619760 Suspension Ball Joint - Front Right Lower		1K0407366B; 5Q0407366A; 1K0407366E; 1K0407366C
SSP1977	301191619770 Suspension Ball Joint - Front Left Lower		1K0407365B; 5Q0407365A; 1K0407365E; 1K0407365C
SSP2576	301191625760 Suspension Stabilizer Bar Link - Front	L=335mm	1K0411315B; 1K0411315D; 1K0411315J
SSP2577	301191625770 Suspension Stabilizer Bar Link - Rear	L=95,5 mm	1K0505465C; 1K0505465J; 1K0505465K; 1K0505465H; 1K0505465D
SSP2578	301191625780 Suspension Stabilizer Bar Link - Rear	L=241mm	2K0505465B; 2K0505465C



PART NO.	DESCRIPTION	NOTES	O.E.
SSP0698 301191606980	Steering Tie Rod End - Front Right	M14x1,5Rht	171419812; 3A0422812; 191419812
SSP0699 301191606990	Steering Tie Rod End - Front Left Outer	M14x1,5Rht	191419811; 3A0422811

**VOLKSWAGEN JETTA MK3/A3**

1991-1998



PART NO.	DESCRIPTION	NOTES	O.E.
SSP0698 301191606980	Steering Tie Rod End - Front Right	M14x1,5Rht	171419812; 3A0422812; 191419812
SSP0699 301191606990	Steering Tie Rod End - Front Left Outer	M14x1,5Rht	191419811; 3A0422811
SSP2585 301191625850	Suspension Stabilizer Bar Link - Front	L=78mm - D=Ø18mm	191411315A; 191411327



PART NO.	DESCRIPTION	NOTES	O.E.
ARM182	301181318200 Suspension Control Arm and Ball Joint Assembly - Front Right Lower		1J0407151B
ARM183	301181318300 Suspension Control Arm and Ball Joint Assembly - Front Left Lower		1J0407151A
SSP0003	301191600030 Steering Tie Rod - Front Inner	- Ch.8L-W-050-423 -> M14x1,5 - L=320mm	1J0422807; 1J0422807A
SSP0005	301191600050 Steering Tie Rod - Front	L=338mm Ch.No:-> 8L-W-050-422 M14x1,5 Rht	1J0422821A
SSP0283	301191602830 Steering Tie Rod End - Front Right	Ch.8L-W-050-423 -> M14x1,5 Rht	1J0422812B; 6R0423812A; 6Q0419812; 1J0422812R; 3A0422812B
SSP0284	301191602840 Steering Tie Rod End - Front Left	Ch.8L-W-050-423 -> M14x1,5 Rht	1J0422811B; 6R0423811A; 6Q0419811; 1J0422811R; 3A0422811B
SSP0285	301191602850 Steering Tie Rod End - Front Right Outer	Ch. >>8L-W-050-422 M14x1,5 Rht	1J0422812A; 1J0422812L
SSP0286	301191602860 Steering Tie Rod End - Front Left Outer	Ch. >>8L-W-050-422 M14x1,5 Rht	1J0422811A; 1J0422811L
SSP1775	301191617750 Suspension Ball Joint - Front Lower	Only: VW Golf IV R32 4Mot.- VW New Beetle 3.2 Rsi	8N0407365A; 8N0407365B; 8N0407365C
SSP1776	301191617760 Suspension Ball Joint - Front Right Lower		1J0407366A; 1J0407366B; 1J0407366C
SSP1777	301191617770 Suspension Ball Joint - Front Right Lower	Kit	1J0407366A/B/C*
SSP1778	301191617780 Suspension Ball Joint - Front Left Lower		1J0407365A; 1J0407365D; 1J0407365B; 1J0407365C
SSP1779	301191617790 Suspension Ball Joint - Front Left Lower	Kit	1J0407366A/B/C*
SSP2002	301191620020 Suspension Stabilizer Bar Link - Front Left	4 Motion L=336mm	1J0411315D
SSP2004	301191620040 Suspension Stabilizer Bar Link - Front Right	4 Motion L=336mm	1J0411316D
SSP2023	301191620230 Suspension Stabilizer Bar Link - Rear	VW TDI 4motion L=175mm	1J0505466B
SSP2571	301191625710 Suspension Stabilizer Bar Link - Front	Plastic L=105,5mm	1J0411315C
SSP2572	301191625720 Suspension Stabilizer Bar Link - Front	Metal L=105mm	1J0411315H; 1J0422315G
SSP2573	301191625730 Suspension Stabilizer Bar Link - Front Right	Only:Golf IV Ch.No: -> OPT858 L=340mm	68510018
SSP2574	301191625740 Suspension Stabilizer Bar Link - Front Left	Only:Golf IV Ch.No: -> OPT858 L=340mm	68510017
SSP2575	301191625750 Suspension Stabilizer Bar Link - Front	Plastic Only:GOLF IV L=105mm	1J0411315K



VOLKSWAGEN JETTA MK5/A5



08/2005-10/2010

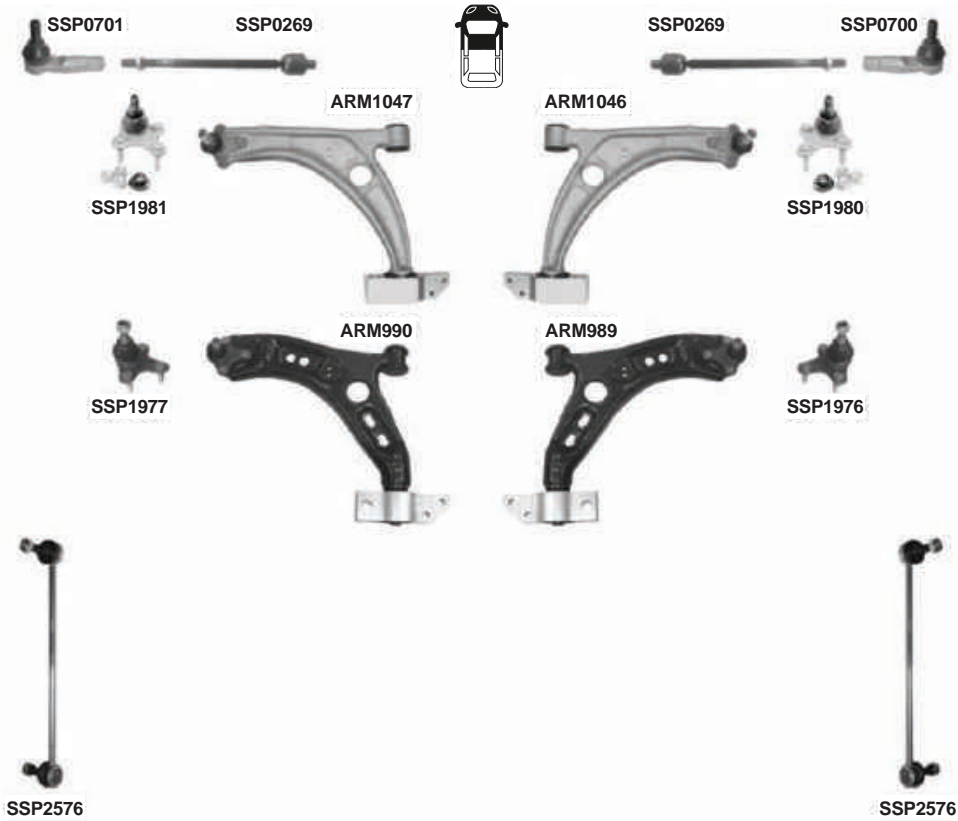



VOLKSWAGEN JETTA MK5/A5



08/2005-10/2010

PART NO.	DESCRIPTION	NOTES	O.E.
ARM989	301181398900 Suspension Control Arm and Ball Joint Assembly - Front Right Lower		1K0407152BC*
ARM990	301181399000 Suspension Control Arm and Ball Joint Assembly - Front Left Lower		1K0407151BC*
ARM1039	301181310390 Lateral Arm - Rear Lower		1K0505311AA; 1K0505311S; 1K0505311AB
ARM1046	301181310460 Suspension Control Arm and Ball Joint Assembly - Front Right		3C0407151G*
ARM1047	301181310470 Suspension Control Arm and Ball Joint Assembly - Front Left		3C0407151H*
SSP0269	301191602690 Steering Tie Rod - Front Inner	M16x1,5 - L=310mm	1K0423810A
SSP0700	301191607000 Steering Tie Rod End - Front Right	M16x1,5Rht	1K0423812A; 1K0423812J; 1K0423812K; 1K0423812G; 1K0423812E
SSP0701	301191607010 Steering Tie Rod End - Front Left	M16x1,5Rht	1K0423811A; 1K0423811J; 1K0423811K; 1K0423811G; 1K0423811E
SSP1976	301191619760 Suspension Ball Joint - Front Right Lower		1K0407366B; 5Q0407366A; 1K0407366E; 1K0407366C
SSP1977	301191619770 Suspension Ball Joint - Front Left Lower		1K0407365B; 5Q0407365A; 1K0407365E; 1K0407365C
SSP1980	301191619800 Suspension Ball Joint - Right		3C0407366A
SSP1981	301191619810 Suspension Ball Joint - Front Left		3C0407365A
SSP2576	301191625760 Suspension Stabilizer Bar Link - Front	L=335mm	1K0411315B; 1K0411315D; 1K0411315J
SSP2577	301191625770 Suspension Stabilizer Bar Link - Rear	L=95,5 mm	1K0505465C; 1K0505465J; 1K0505465K; 1K0505465H; 1K0505465D



VOLKSWAGEN JETTA IV (162)



11/2010-





VOLKSWAGEN JETTA IV (162)



11/2010-

PART NO.	DESCRIPTION	NOTES	O.E.
ARM189	301181318900 Lateral Arm - Rear Upper		1K0505323N
ARM988	301181398800 Lateral Arm - Rear Lower	L=298mm	1K0501529J
ARM1039	301181310390 Lateral Arm - Rear Lower		1K0505311AA; 1K0505311S; 1K0505311AB
ARM1060	301181310600 Suspension Control Arm and Ball Joint Assembly - Front Right Lower		5C0407152B*
ARM1061	301181310610 Suspension Control Arm and Ball Joint Assembly - Front Left Lower		1K0407151B*
SSP0269	301191602690 Steering Tie Rod - Front Inner	M16x1,5 - L=310mm	1K0423810A
SSP0700	301191607000 Steering Tie Rod End - Front Right	M16x1,5Rht	1K0423812A; 1K0423812J; 1K0423812K; 1K0423812G; 1K0423812E
SSP0701	301191607010 Steering Tie Rod End - Front Left	M16x1,5Rht	1K0423811A; 1K0423811J; 1K0423811K; 1K0423811G; 1K0423811E
SSP1976	301191619760 Suspension Ball Joint - Front Right Lower		1K0407366B; 5Q0407366A; 1K0407366E; 1K0407366C
SSP1977	301191619770 Suspension Ball Joint - Front Left Lower		1K0407365B; 5Q0407365A; 1K0407365E; 1K0407365C
SSP2576	301191625760 Suspension Stabilizer Bar Link - Front	L=335mm	1K0411315B; 1K0411315D; 1K0411315J
SSP2577	301191625770 Suspension Stabilizer Bar Link - Rear	L=95,5 mm	1K0505465C; 1K0505465J; 1K0505465K; 1K0505465H; 1K0505465D



VOLKSWAGEN LT 28-35-46, Typ 2D 04/1996-07/2006



PART NO.	DESCRIPTION	NOTES	O.E.
ARM701 301181370100	Suspension Control Arm and Ball Joint Assembly - Front Right Lower		2D0407022; 9013301907; 9013302507
ARM702 301181370200	Suspension Control Arm and Ball Joint Assembly - Front Left Lower		2D0407021; 9013301807; 9013302407
SSP0138 301191601380	Steering Tie Rod - Front	M16x1,5Rht - L=388mm	9014600155; 9014600455
SSP0515 301191605150	Steering Tie Rod End - Front	M16x1,5Rht	2D0422811; 9014600148
SSP1884 301191618840	Suspension Ball Joint - Front Lower		2D0407361A; 9013331127; 2D0407361B; 9013330727
SSP2339 301191623390	Suspension Stabilizer Bar Link - Front Right	EXC. 616 CDI L=115mm	2D0411052; 9013200389
SSP2340 301191623400	Suspension Stabilizer Bar Link - Front Left	EXC. 616 CDI L=115mm	2D0411051; 9013200289
SSP2341 301191623410	Suspension Stabilizer Bar Link - Rear	L=93mm	2D0511329; 9013200089

VOLKSWAGEN LUPO



09/1998-07/2005

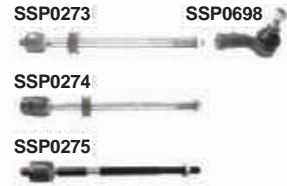



VOLKSWAGEN LUPO



09/1998-07/2005

PART NO.	DESCRIPTION	NOTES	O. E.
SSP0273	301191602730 Steering Tie Rod - Front	Power Steering M14x1,5Rht - L=312,5mm	6N0422803A
SSP0274	301191602740 Steering Tie Rod - Front	Manual Steering M14x1,5Rht - L=306mm	6N0419803
SSP0275	301191602750 Steering Tie Rod - Front	(with PS, Hydro) M14x1,5Rht	6N0422803C/804C
SSP0698	301191606980 Steering Tie Rod End - Front Right	M14x1,5Rht	171419812; 3A0422812; 191419812
SSP0699	301191606990 Steering Tie Rod End - Front Left Outer	M14x1,5Rht	191419811; 3A0422811
SSP1985	301191619850 Suspension Ball Joint - Right		6N0407366
SSP1986	301191619860 Suspension Ball Joint - Front Left Lower		6N0407365
SSP1998	301191619980 Suspension Ball Joint Kit - Front Right		6N0407366*
SSP1999	301191619990 Suspension Ball Joint Kit - Front Left		6N0407365*
SSP2584	301191625840 Suspension Stabilizer Bar Link - Front	L=30 mm - D=Ø18,5mm	6N0411315D
SSP2587	301191625870 Suspension Stabilizer Bar Link - Front	L=30 mm - D=Ø16,5mm	6N0411315
SSP2588	301191625880 Suspension Stabilizer Bar Link - Front	PLS. D=Ø18 mm	6E0411315



VOLKSWAGEN PASSAT B2



1980-1988



PART NO.	DESCRIPTION	NOTES	O.E.
SSP0282 301191602820	Steering Tie Rod End - Front	M14x1,5Rht	811419812A; 811419812B



MAGNETI
MARELLI

VOLKSWAGEN PASSAT B3, B4



1988-1997

SSP0699



SSP0698



PART NO.	DESCRIPTION	NOTES	O.E.
SSP0698 301191606980	Steering Tie Rod End - Front Right	M14x1,5Rht	171419812; 3A0422812; 191419812
SSP0699 301191606990	Steering Tie Rod End - Front Left Outer	M14x1,5Rht	191419811; 3A0422811



VOLKSWAGEN PASSAT B5, B5.5



1997-08/2005



**VOLKSWAGEN PASSAT B5, B5.5**

1997-08/2005

PART NO.	DESCRIPTION	NOTES	O.E.	
ARM170	301181317000	Suspension Control Arm and Ball Joint Assembly - Front Right Upper Rearward	4D0407510D; 4D0407510J	
ARM171	301181317100	Suspension Control Arm and Ball Joint Assembly - Front Right Upper Rearward	Ch. 8D-W-006471 >Ch. 8D-X-200001 >	4D0407510F; 4D0407510G
ARM172	301181317200	Suspension Control Arm and Ball Joint Assembly - Front Left Upper Rearward		4D0407509D; 4D0407509J
ARM173	301181317300	Suspension Control Arm and Ball Joint Assembly - Front Left Upper Rearward	Ch. 8D-W-006471 > Ch. 8D-X-200001 >	4D0407509F; 4D0407509G
ARM174	301181317400	Suspension Control Arm and Ball Joint Assembly - Front Right Upper Forward		8D0407506B; 8D0407506H
ARM175	301181317500	Suspension Control Arm and Ball Joint Assembly - Front Right Upper Forward	Ch. 8D-W-006471 > 8D-X-200001 >	8D0407506A; 8E0407506A; 8D0407506B; 8D0407506F
ARM176	301181317600	Suspension Control Arm and Ball Joint Assembly - Front Left Upper Forward		8D0407505B; 8D0407505H
ARM177	301181317700	Suspension Control Arm and Ball Joint Assembly - Front Left Upper Forward	Ch. 8D-W-006471 > 8D-X-200001 >	8D0407505A; 8E0407505A
ARM178	301181317800	Suspension Control Arm and Ball Joint Assembly - Front Right Lower Rearward		4D0407694M; 8E0407694; 4D0407694N; 8E0407693K
ARM179	301181317900	Suspension Control Arm and Ball Joint Assembly - Front Left Lower		4D0407693M; 8E0407693K; 4D0407693N; 8E0407693
ARM180	301181318000	Suspension Control Arm and Ball Joint Assembly - Front Lower Forward	D=Ø 20,6mm	4D0407151G; 8E0407151N; 4D0407151H; 4D0407151J
ARM181	301181318100	Suspension Control Arm and Ball Joint Assembly - Front Lower Forward	D=16,30mm 1/6	8E0407151M
SSP0004	301191600040	Steering Tie Rod - Front	M 14x1,5 Rht - L=119,5mm	4B0422821; 4D0422821
SSP0287	301191602870	Steering Tie Rod End - Front	M14x1,5 Rht	4B0419811E; 4D0419811A; 4D0419811B; 8E0419811B
SSP2005	301191620050	Suspension Stabilizer Bar Link - Front	L=86mm	4D0411317G; 4D0411317J; 4D0411317K
SSP2007	301191620070	Suspension Stabilizer Bar Link - Front Right	With Bolts And Nuts L=90mm	8D0407318D; 8D0411318D
SSP2008	301191620080	Suspension Stabilizer Bar Link - Front Left	With Bolts And Nuts L=90mm	8D0407317D; 8D0411317D
SSP2009	301191620090	Suspension Stabilizer Bar Link - Front	With Bolts And Nuts L=90mm	4D0411317K
SSP2018	301191620180	Suspension Stabilizer Bar Link - Rear	Passat Ch.No:->4B-W-000001 L=62,5mm	8E0505465D
SSP2577	301191625770	Suspension Stabilizer Bar Link - Rear	L=95,5 mm	1K0505465C; 1K0505465J; 1K0505465K; 1K0505465H; 1K0505465D



VOLKSWAGEN PASSAT B6



09/2005-07/2010

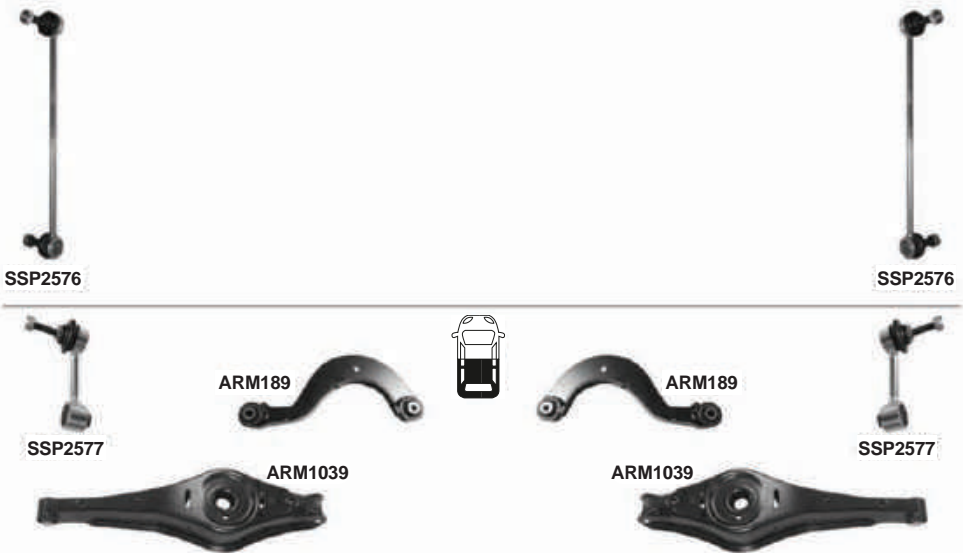
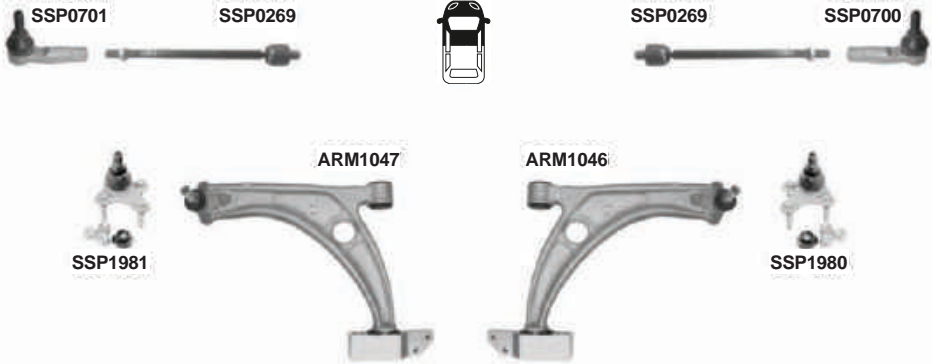

**MAGNETI
MARELLI**

VOLKSWAGEN PASSAT B6



09/2005-07/2010

PART NO.	DESCRIPTION	NOTES	O.E.
ARM189	301181318900 Lateral Arm - Rear Upper		1K0505323N
ARM1039	301181310390 Lateral Arm - Rear Lower		1K0505311AA; 1K0505311S; 1K0505311AB
ARM1046	301181310460 Suspension Control Arm and Ball Joint Assembly - Front Right		3C0407151G*
ARM1047	301181310470 Suspension Control Arm and Ball Joint Assembly - Front Left		3C0407151H*
SSP0269	301191602690 Steering Tie Rod - Front Inner	M16x1,5 - L=310mm	1K0423810A
SSP0700	301191607000 Steering Tie Rod End - Front Right	M16x1,5Rht	1K0423812A; 1K0423812J; 1K0423812K; 1K0423812G; 1K0423812E
SSP0701	301191607010 Steering Tie Rod End - Front Left	M16x1,5Rht	1K0423811A; 1K0423811J; 1K0423811K; 1K0423811G; 1K0423811E
SSP1980	301191619800 Suspension Ball Joint - Right		3C0407366A
SSP1981	301191619810 Suspension Ball Joint - Front Left		3C0407365A
SSP2576	301191625760 Suspension Stabilizer Bar Link - Front	L=335mm	1K0411315B; 1K0411315D; 1K0411315J
SSP2577	301191625770 Suspension Stabilizer Bar Link - Rear	L=95,5 mm	1K0505465C; 1K0505465J; 1K0505465K; 1K0505465H; 1K0505465D



VOLKSWAGEN PASSAT B7



08/2010-04/2015

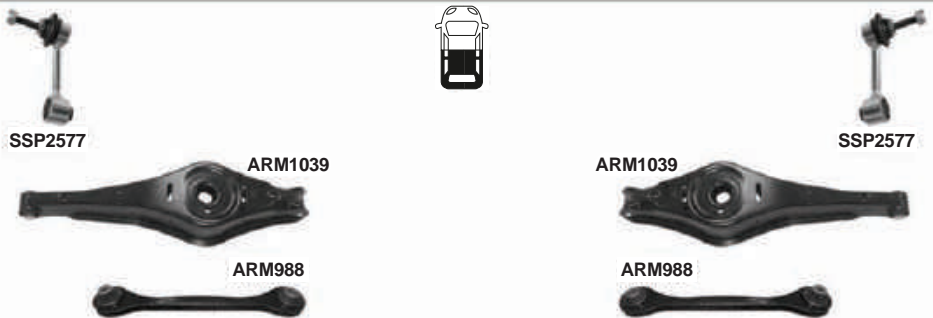

**VOLKSWAGEN PASSAT B7**

08/2010-04/2015

PART NO.	DESCRIPTION	NOTES	O.E.
ARM988	301181398800 Lateral Arm - Rear Lower	L=298mm	1K0501529J
ARM1039	301181310390 Lateral Arm - Rear Lower		1K0505311AA; 1K0505311S; 1K0505311AB
ARM1046	301181310460 Suspension Control Arm and Ball Joint Assembly - Front Right		3C0407151G*
ARM1047	301181310470 Suspension Control Arm and Ball Joint Assembly - Front Left		3C0407151H*
ARM1064	301181310640 Suspension Control Arm and Ball Joint Assembly - Front Right Lower		5N0407152*
ARM1065	301181310650 Suspension Control Arm and Ball Joint Assembly - Front Left Lower		5N0407151*
SSP0269	301191602690 Steering Tie Rod - Front Inner	M16x1,5 - L=310mm	1K0423810A
SSP0700	301191607000 Steering Tie Rod End - Front Right	M16x1,5Rht	1K0423812A; 1K0423812J; 1K0423812K; 1K0423812G; 1K0423812E
SSP0701	301191607010 Steering Tie Rod End - Front Left	M16x1,5Rht	1K0423811A; 1K0423811J; 1K0423811K; 1K0423811G; 1K0423811E
SSP1980	301191619800 Suspension Ball Joint - Right		3C0407366A
SSP1981	301191619810 Suspension Ball Joint - Front Left		3C0407365A
SSP2576	301191625760 Suspension Stabilizer Bar Link - Front	L=335mm	1K0411315B; 1K0411315D; 1K0411315J
SSP2577	301191625770 Suspension Stabilizer Bar Link - Rear	L=95,5 mm	1K0505465C; 1K0505465J; 1K0505465K; 1K0505465H; 1K0505465D



	PART NO.	DESCRIPTION	NOTES	O.E.
ARM1066	301181310660	Suspension Control Arm and Ball Joint Assembly - Front Right Lower		3Q0407152E; 3Q0407152F
ARM1067	301181310670	Suspension Control Arm and Ball Joint Assembly - Front Left Lower		3Q0407151E; 3Q0407151F
SSP0268	301191602680	Steering Tie Rod - Front Inner		561423810
SSP0700	301191607000	Steering Tie Rod End - Front Right	M16x1,5Rht	1K0423812A; 1K0423812J; 1K0423812K; 1K0423812G; 1K0423812E
SSP0701	301191607010	Steering Tie Rod End - Front Left	M16x1,5Rht	1K0423811A; 1K0423811J; 1K0423811K; 1K0423811G; 1K0423811E
SSP2576	301191625760	Suspension Stabilizer Bar Link - Front	L=335mm	1K0411315B; 1K0411315D; 1K0411315J
SSP2579	301191625790	Suspension Stabilizer Bar Link - Rear	L=70mm	5Q0505465C; 5Q0505465A



VOLKSWAGEN PHAETON



04/2002-2016



ARM208



ARM207



ARM210



ARM209



ARM244



ARM243



ARM245



ARM245



SSP2020



SSP2020



SSP2013



SSP2012



ARM242



ARM242



VOLKSWAGEN PHAETON



04/2002-2016

	PART NO.	DESCRIPTION	NOTES	O.E.
ARM207	301181320700	Suspension Control Arm and Ball Joint Assembly - Front Right Upper Rearward		4E0407510B
ARM208	301181320800	Suspension Control Arm and Ball Joint Assembly - Front Left Upper Rearward		4E0407509B
ARM209	301181320900	Suspension Control Arm and Ball Joint Assembly - Front Right Upper Forward		4E0407506B
ARM210	301181321000	Suspension Control Arm and Ball Joint Assembly - Front Left Upper Forward		4E0407505B
ARM242	301181324200	Lateral Arm - Rear Lower	Aluminium	4E0501529D; 4E0501529G
ARM243	301181324300	Suspension Control Arm and Ball Joint Assembly - Front Right Lower		4E0407694C; 4E0407694F
ARM244	301181324400	Suspension Control Arm and Ball Joint Assembly - Front Left Lower		4E0407693C; 4E0407693F
ARM245	301181324500	Suspension Control Arm and Ball Joint Assembly - Front Lower		4E0407151G; 4E0407151L
SSP0009	301191600090	Steering Tie Rod - Front	M16x1,5Rht - L=127mm	4E0419821
SSP0299	301191602990	Steering Tie Rod End - Front	M16x1,5Rht	4E0419811B; 4E0419811E; 4E0419811C; 4E0419811D
SSP2012	301191620120	Suspension Stabilizer Bar Link - Rear Right	L=61,5mm	4D0505548C; 4E0505548L
SSP2013	301191620130	Suspension Stabilizer Bar Link - Rear Left	L=61,5mm	4D0505547C; 4E0505547L
SSP2020	301191620200	Suspension Stabilizer Bar Link - Front	L=110mm	4E0411317C; 4E0411317D; 4E0411317E



VOLKSWAGEN POLO (6N1)



1994-09/2001

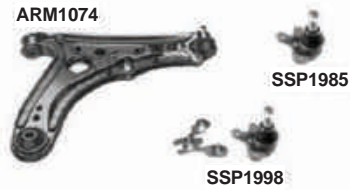



VOLKSWAGEN POLO (6N1)



1994-09/2001

PART NO.	DESCRIPTION	NOTES	O.E.
ARM1074 301181310740	Suspension Control Arm and Ball Joint Assembly - Front Right Lower		6N0407151*; 6N0407365A*
ARM1075 301181310750	Suspension Control Arm and Ball Joint Assembly - Front Left Lower		6N0407151*; 6N0407365*
SSP0273 301191602730	Steering Tie Rod - Front	Power Steering M14x1,5Rht - L=312,5mm	6N0422803A
SSP0274 301191602740	Steering Tie Rod - Front	Manual Steering M14x1,5Rht - L=306mm	6N0419803
SSP0275 301191602750	Steering Tie Rod - Front	(with PS, Hydro) M14x1,5Rht	6N0422803C/804C
SSP0698 301191606980	Steering Tie Rod End - Front Right	M14x1,5Rht	171419812; 3A0422812; 191419812
SSP0699 301191606990	Steering Tie Rod End - Front Left Outer	M14x1,5Rht	191419811; 3A0422811
SSP1985 301191619850	Suspension Ball Joint - Right		6N0407366
SSP1986 301191619860	Suspension Ball Joint - Front Left Lower		6N0407365
SSP1998 301191619980	Suspension Ball Joint Kit - Front Right		6N0407366*
SSP1999 301191619990	Suspension Ball Joint Kit - Front Left		6N0407365*
SSP2584 301191625840	Suspension Stabilizer Bar Link - Front	L=30 mm - D=Ø18,5mm	6N0411315D
SSP2587 301191625870	Suspension Stabilizer Bar Link - Front	L=30 mm - D=Ø16,5mm	6N0411315



VOLKSWAGEN POLO (9N)



10/2001-05/2009



SSP0664



SSP0663



SSP0247



SSP0247



SSP1962



ARM985



ARM984



SSP1961



SSP2534



SSP2535



SSP2586



SSP2586



SSP2535



SSP2534



VOLKSWAGEN POLO (9N)



10/2001-05/2009

	PART NO.	DESCRIPTION	NOTES	O.E.
ARM984	301181398400	Suspension Control Arm and Ball Joint Assembly - Front Right Lower		6Q0407151D*; 6Q0407366A*
ARM985	301181398500	Suspension Control Arm and Ball Joint Assembly - Front Left Lower		6Q0407151D*; 6Q0407365A*
SSP0247	301191602470	Steering Tie Rod - Front	manual steering	6Q0419803B; 6Q0419804F; 6Q0419804B; 6Q0419804D; 6Q0419803F; 6Q0419803D
SSP0663	301191606630	Steering Tie Rod End - Front Right Outer	M14x1,5Rht	6Q0423812; 8Z0423812A; 6Q0423812D
SSP0664	301191606640	Steering Tie Rod End - Front Left Outer	M14x1,5Rht	6Q0423811; 8Z0423811A; 6Q0423811D
SSP1961	301191619610	Suspension Ball Joint - Front Right Lower		6Q0407366A; 8Z0407366A
SSP1962	301191619620	Suspension Ball Joint - Front Left Lower		6Q0407365A; 8Z0407365A
SSP2534	301191625340	Suspension Stabilizer Bar Link - Front	L=270mm	6Q0411315A; 6Q0411315F; 6Q0411315D; 6Q0411315C
SSP2535	301191625350	Suspension Stabilizer Bar Link - Front	(Clip-on patented design) L=270mm	6Q0411315A
SSP2586	301191625860	Suspension Stabilizer Bar Link - Front	L=270mm	6Q0411315G



MAGNETI
MARELLI

VOLKSWAGEN POLO (6R)



06/2009-





VOLKSWAGEN POLO (6R)



06/2009-

PART NO.	DESCRIPTION	NOTES	O.E.
ARM1076 301181310760	Suspension Control Arm and Ball Joint Assembly - Front Right Lower		6R0407152A**; 6R0407152F**
ARM1077 301181310770	Suspension Control Arm and Ball Joint Assembly - Front Left Lower		6R0407151A**; 6R0407151F**
SSP0276 301191602760	Steering Tie Rod - Front	M14x1,5 - L=313mm	6R0423810; 8Z0419810C
SSP0663 301191606630	Steering Tie Rod End - Front Right Outer	M14x1,5Rht	6Q0423812; 8Z0423812A; 6Q0423812D
SSP0664 301191606640	Steering Tie Rod End - Front Left Outer	M14x1,5Rht	6Q0423811; 8Z0423811A; 6Q0423811D
SSP1963 301191619630	Suspension Ball Joint - Front Right Lower		5U0407366A; 6R0407366
SSP1964 301191619640	Suspension Ball Joint - Front Left Lower		5U0407365A; 6R0407365
SSP2534 301191625340	Suspension Stabilizer Bar Link - Front	L=270mm	6Q0411315A; 6Q0411315F; 6Q0411315D; 6Q0411315C
SSP2535 301191625350	Suspension Stabilizer Bar Link - Front	(Clip-on patented design) L=270mm	6Q0411315A

**VOLKSWAGEN POLO CLASSIC - CADDY II**  1995-2001

PART NO.	DESCRIPTION	NOTES	O.E.
SSP0698 301191606980	Steering Tie Rod End - Front Right	M14x1,5Rht	171419812; 3A0422812; 191419812
SSP0699 301191606990	Steering Tie Rod End - Front Left Outer	M14x1,5Rht	191419811; 3A0422811
SSP2587 301191625870	Suspension Stabilizer Bar Link - Front	L=30 mm - D=Ø16,5mm	6N0411315



VOLKSWAGEN Rabbit MK5/A5



10/2003-06/2009

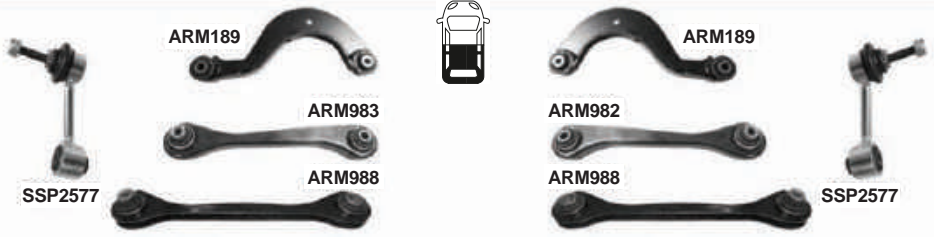
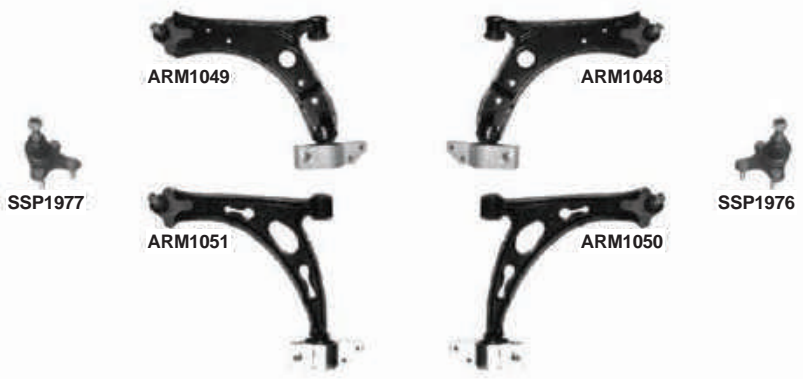

**VOLKSWAGEN Rabbit MK5/A5**

10/2003-06/2009

PART NO.	DESCRIPTION	NOTES	O.E.
ARM189	301181318900 Lateral Arm - Rear Upper		1K0505323N
ARM982	301181398200 Lateral Arm - Rear Right Lower	L=298mm	1K0501530C
ARM983	301181398300 Lateral Arm - Rear Left Lower	L=298mm	1K0501529F
ARM988	301181398800 Lateral Arm - Rear Lower	L=298mm	1K0501529J
ARM1048	301181310480 Suspension Control Arm and Ball Joint Assembly - Front Right Lower	Only: Petrol	1K0407152P*; 1K0407152Q*
ARM1049	301181310490 Suspension Control Arm and Ball Joint Assembly - Front Left Lower	Only: Petrol	1K0407151P*; 1K0407151Q*
ARM1050	301181310500 Suspension Control Arm and Ball Joint Assembly - Front Right Lower	Only: Diesel	1K0407152AC
ARM1051	301181310510 Suspension Control Arm and Ball Joint Assembly - Front Left Lower	Only: Diesel	1K0407151AC
SSP0269	301191602690 Steering Tie Rod - Front Inner	M16x1,5 - L=310mm	1K0423810A
SSP0700	301191607000 Steering Tie Rod End - Front Right	M16x1,5Rht	1K0423812A; 1K0423812J; 1K0423812K; 1K0423812G; 1K0423812E
SSP0701	301191607010 Steering Tie Rod End - Front Left	M16x1,5Rht	1K0423811A; 1K0423811J; 1K0423811K; 1K0423811G; 1K0423811E
SSP1976	301191619760 Suspension Ball Joint - Front Right Lower		1K0407366B; 5Q0407366A; 1K0407366E; 1K0407366C
SSP1977	301191619770 Suspension Ball Joint - Front Left Lower		1K0407365B; 5Q0407365A; 1K0407365E; 1K0407365C
SSP2576	301191625760 Suspension Stabilizer Bar Link - Front	L=335mm	1K0411315B; 1K0411315D; 1K0411315J
SSP2577	301191625770 Suspension Stabilizer Bar Link - Rear	L=95,5 mm	1K0505465C; 1K0505465J; 1K0505465K; 1K0505465H; 1K0505465D
SSP2578	301191625780 Suspension Stabilizer Bar Link - Rear	L=241mm	2K0505465B; 2K0505465C



VOLKSWAGEN SHARAN (7M6,7M8,7M9)



05/1995-03/2010

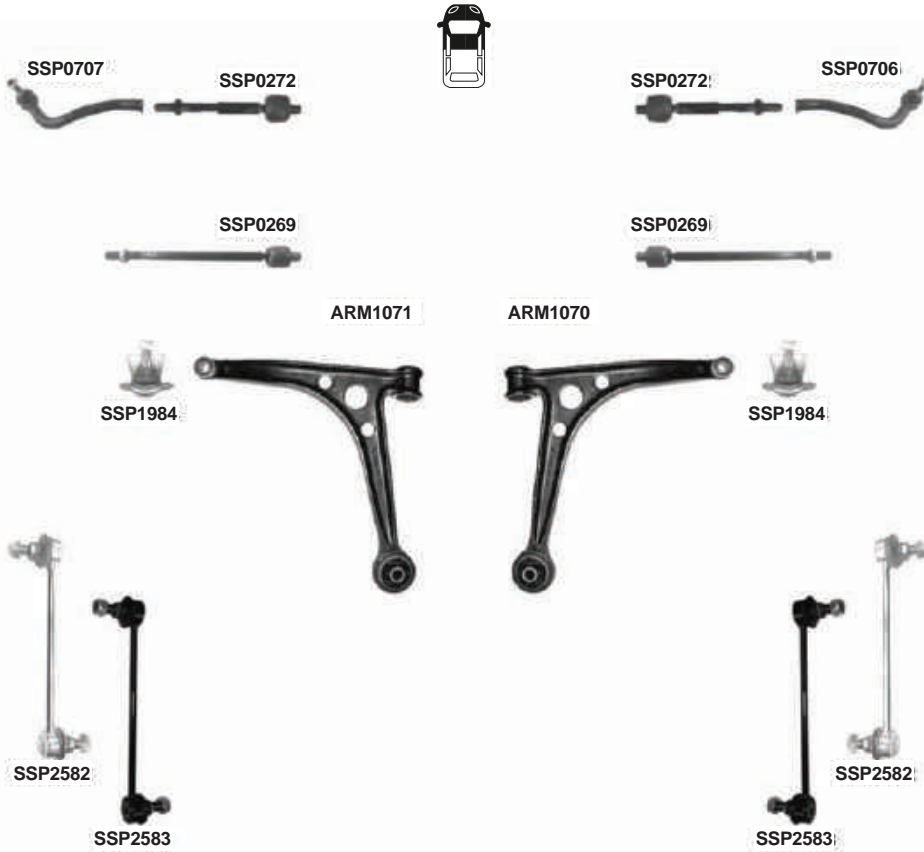

PART NO.	DESCRIPTION	NOTES	O.E.
ARM1070	301181310700 Suspension Control Arm - Front Right Lower		1012632; 95VW3078AC; 7M0407152B
ARM1071	301181310710 Suspension Control Arm - Front Left		1007602; 95VW3079AC; 7M0407151B
SSP0269	301191602690 Steering Tie Rod - Front Inner	M16x1,5 - L=310mm	1K0423810A
SSP0272	301191602720 Steering Tie Rod - Front Inner	M14x1,5 - L=182.5mm	7M0422803/4EF
SSP0706	301191607060 Steering Tie Rod End - Front Right	M14x1,5Rht	1092378; 7M0422818B; 7M0422818
SSP0707	301191607070 Steering Tie Rod End - Front Left	M14x1,5Rht	1092380; 7M0422817B; 7M0422817
SSP1984	301191619840 Suspension Ball Joint - Front		7200946 7M0407365A; YM213395BA; 7M3407365A
SSP2582	301191625820 Suspension Stabilizer Bar Link - Front	L=205mm	1009591; 95VW5489AC; 7M0411317D
SSP2583	301191625830 Suspension Stabilizer Bar Link - Front	(Clip-on patented design) L=205mm	1009591*; 95VW5489AC*

**VOLKSWAGEN SHARAN (7N)**

04/2010-



SSP0701

SSP0269



SSP0269

SSP0700



SSP2577



SSP2577

PART NO.	DESCRIPTION	NOTES	O.E.
SSP0269 301191602690	Steering Tie Rod - Front Inner	M16x1,5 - L=310mm	1K0423810A
SSP0700 301191607000	Steering Tie Rod End - Front Right	M16x1,5Rht	1K0423812A; 1K0423812J; 1K0423812K; 1K0423812G; 1K0423812E
SSP0701 301191607010	Steering Tie Rod End - Front Left	M16x1,5Rht	1K0423811A; 1K0423811J; 1K0423811K; 1K0423811G; 1K0423811E
SSP2577 301191625770	Suspension Stabilizer Bar Link - Rear	L=95,5 mm	1K0505465C; 1K0505465J; 1K0505465K; 1K0505465H; 1K0505465D



VOLKSWAGEN TIGUAN 1st Gen



09/2007-2016



PART NO.	DESCRIPTION	NOTES	O.E.
ARM187	301181318700 Lateral Arm - Rear Right Lower		3C0505224D
ARM188	301181318800 Lateral Arm - Rear Left Lower		3C0505223D
ARM189	301181318900 Lateral Arm - Rear Upper		1K0505323N
ARM988	301181398800 Lateral Arm - Rear Lower	L=298mm	1K0501529J
ARM1039	301181310390 Lateral Arm - Rear Lower		1K0505311AA; 1K0505311S; 1K0505311AB
ARM1046	301181310460 Suspension Control Arm and Ball Joint Assembly - Front Right		3C0407151G*
ARM1047	301181310470 Suspension Control Arm and Ball Joint Assembly - Front Left		3C0407151H*
SSP0269	301191602690 Steering Tie Rod - Front Inner	M16x1,5 - L=310mm	1K0423810A
SSP0700	301191607000 Steering Tie Rod End - Front Right	M16x1,5Rht	1K0423812A; 1K0423812J; 1K0423812K; 1K0423812G; 1K0423812E
SSP0701	301191607010 Steering Tie Rod End - Front Left	M16x1,5Rht	1K0423811A; 1K0423811J; 1K0423811K; 1K0423811G; 1K0423811E
SSP1980	301191619800 Suspension Ball Joint - Right		3C0407366A
SSP1981	301191619810 Suspension Ball Joint - Front Left		3C0407365A

**MAGNETI
MARELLI**

VOLKSWAGEN TOUAREG (7LA,7L6,7L7)



10/2002-05/2010

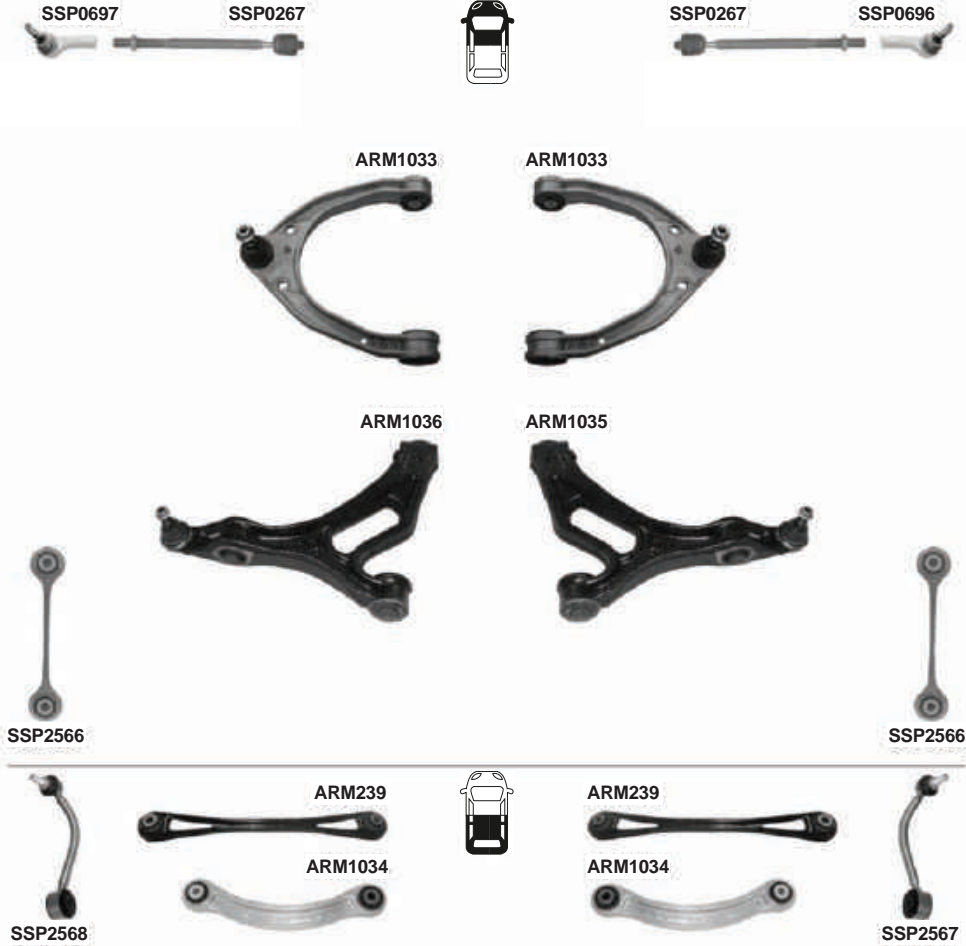

PART NO.	DESCRIPTION	NOTES	O.E.
ARM239 301181323900	Lateral Arm - Rear Lower		7L8501529A
ARM1033 301181310330	Suspension Control Arm and Ball Joint Assembly - Front Upper	Alum.	7L0407021A; 95534102702; 95534102701; 7L0407021B
ARM1034 301181310340	Lateral Arm - Rear Upper Forward		7L0505323A
ARM1035 301181310350	Suspension Control Arm and Ball Joint Assembly - Front Right		7L0407152C; 95534101832; 7L0407152D
ARM1036 301181310360	Suspension Control Arm and Ball Joint Assembly - Front Left		7L0407151C; 95534101731; 7L0407151D
SSP0267 301191602670	Steering Tie Rod - Front	M16x1,5Rht - L=287,5mm	1160310016; 7L0422821
SSP0696 301191606960	Steering Tie Rod End - Front Right	M16x1,5Rht	7L0422818B; 95534713220; 7L0422818D; 7L0422818C
SSP0697 301191606970	Steering Tie Rod End - Front Left	M16x1,5Rht	7L0422817B; 95534713221; 7L0422817D; 7L0422817C
SSP2566 301191625660	Suspension Stabilizer Bar Link - Front	L=197mm	7L0411317
SSP2567 301191625670	Suspension Stabilizer Bar Link - Rear Right	L=201mm	7L0505466A; 95533307010
SSP2568 301191625680	Suspension Stabilizer Bar Link - Rear Left	L=201mm	7L0505465A; 95533307011



VOLKSWAGEN TOURAN (1T1,1T2) 02/2003-05/2010





VOLKSWAGEN TOURAN (1T1,1T2) 02/2003-05/2010

PART NO.	DESCRIPTION	NOTES	O.E.
ARM189	301181318900 Lateral Arm - Rear Upper		1K0505323N
ARM1039	301181310390 Lateral Arm - Rear Lower		1K0505311AA; 1K0505311S; 1K0505311AB
ARM1048	301181310480 Suspension Control Arm and Ball Joint Assembly - Front Right Lower	Only: Petrol	1K0407152P*; 1K0407152Q*
ARM1049	301181310490 Suspension Control Arm and Ball Joint Assembly - Front Left Lower	Only: Petrol	1K0407151P*; 1K0407151Q*
ARM1050	301181310500 Suspension Control Arm and Ball Joint Assembly - Front Right Lower	Only: Diesel	1K0407152AC
ARM1051	301181310510 Suspension Control Arm and Ball Joint Assembly - Front Left Lower	Only: Diesel	1K0407151AC
SSP0269	301191602690 Steering Tie Rod - Front Inner	M16x1,5 - L=310mm	1K0423810A
SSP0700	301191607000 Steering Tie Rod End - Front Right	M16x1,5Rht	1K0423812A; 1K0423812J; 1K0423812K; 1K0423812G; 1K0423812E
SSP0701	301191607010 Steering Tie Rod End - Front Left	M16x1,5Rht	1K0423811A; 1K0423811J; 1K0423811K; 1K0423811G; 1K0423811E
SSP1976	301191619760 Suspension Ball Joint - Front Right Lower		1K0407366B; 5Q0407366A; 1K0407366E; 1K0407366C
SSP1977	301191619770 Suspension Ball Joint - Front Left Lower		1K0407365B; 5Q0407365A; 1K0407365E; 1K0407365C
SSP2576	301191625760 Suspension Stabilizer Bar Link - Front	L=335mm	1K0411315B; 1K0411315D; 1K0411315J
SSP2577	301191625770 Suspension Stabilizer Bar Link - Rear	L=95,5 mm	1K0505465C; 1K0505465J; 1K0505465K; 1K0505465H; 1K0505465D



VOLKSWAGEN TOURAN (1T3)



06/2010-

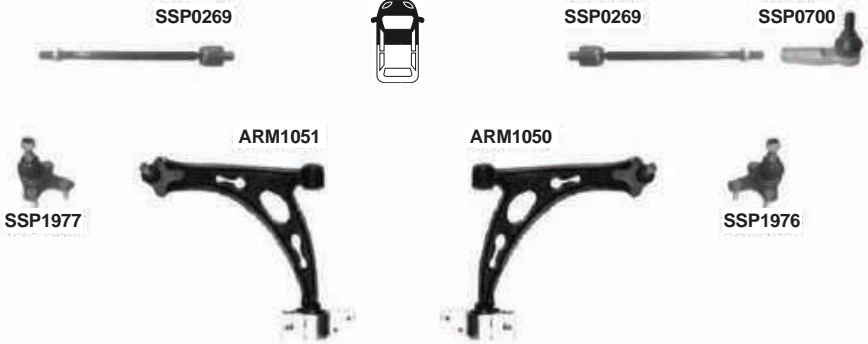

**VOLKSWAGEN TOURAN (1T3)****06/2010-**

PART NO.	DESCRIPTION	NOTES	O.E.
ARM1037	301181310370 Lateral Arm - Rear Right Forward		1T0505224F
ARM1038	301181310380 Lateral Arm - Rear Left Forward		1T0505223F
ARM1039	301181310390 Lateral Arm - Rear Lower		1K0505311AA; 1K0505311S; 1K0505311AB
ARM1050	301181310500 Suspension Control Arm and Ball Joint Assembly - Front Right Lower	Only: Diesel	1K0407152AC
ARM1051	301181310510 Suspension Control Arm and Ball Joint Assembly - Front Left Lower	Only: Diesel	1K0407151AC
ARM1057	301181310570 Lateral Arm - Rear Upper		5Q0505323C; 5Q0505323D
SSP0269	301191602690 Steering Tie Rod - Front Inner	M16x1,5 - L=310mm	1K0423810A
SSP0700	301191607000 Steering Tie Rod End - Front Right	M16x1,5Rht	1K0423812A; 1K0423812J; 1K0423812K; 1K0423812G; 1K0423812E
SSP1976	301191619760 Suspension Ball Joint - Front Right Lower		1K0407366B; 5Q0407366A; 1K0407366E; 1K0407366C
SSP1977	301191619770 Suspension Ball Joint - Front Left Lower		1K0407365B; 5Q0407365A; 1K0407365E; 1K0407365C
SSP2576	301191625760 Suspension Stabilizer Bar Link - Front	L=335mm	1K0411315B; 1K0411315D; 1K0411315J



PART NO.	DESCRIPTION	NOTES	O.E.
ARM1066 301181310660	Suspension Control Arm and Ball Joint Assembly - Front Right Lower		3Q0407152E; 3Q0407152F
ARM1067 301181310670	Suspension Control Arm and Ball Joint Assembly - Front Left Lower		3Q0407151E; 3Q0407151F



VOLKSWAGEN TRANSPORTER T5 05/2003-04/2011

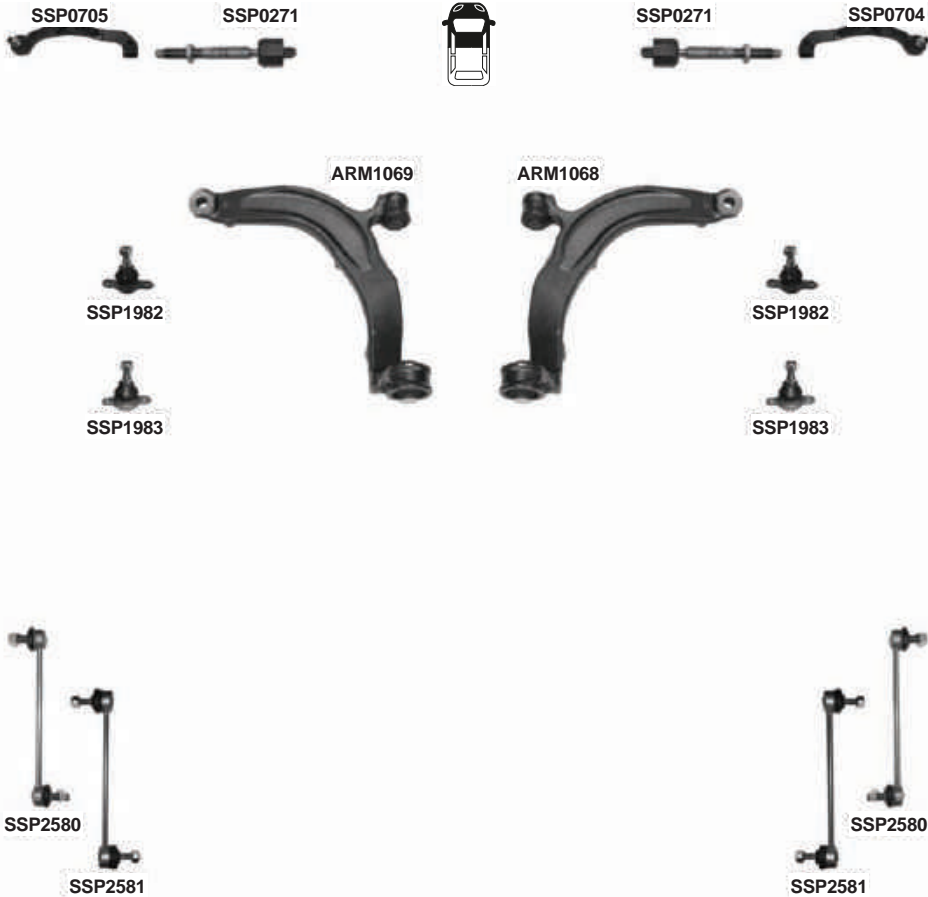

PART NO.	DESCRIPTION	NOTES	O.E.
ARM1068	301181310680 Suspension Control Arm - Front Right		7H0407152E
ARM1069	301181310690 Suspension Control Arm - Front Left		7H0407151E
SSP0271	301191602710 Steering Tie Rod - Front	M16x1,5 - L=175.5mm	7H0419803C*; 7H0419804C*
SSP0704	301191607040 Steering Tie Rod End - Front Right	M16x1,5Rht	7H0422818B; 7H0422818C
SSP0705	301191607050 Steering Tie Rod End - Front Left	M16x1,5Rht	7H0422817B; 7H0422817C
SSP1982	301191619820 Suspension Ball Joint - Front Lower	Ø 22mm	7E0407361; 7H0407361A; 7H0407361
SSP1983	301191619830 Suspension Ball Joint - Front	3200Kg	7H8407361; 7H8407361A
SSP1997	301191619970 Suspension Ball Joint Kit - Front Lower		7H8407361A
SSP2580	301191625800 Suspension Stabilizer Bar Link - Front	L=260mm	7H5411317; 7H5411317B
SSP2581	301191625810 Suspension Stabilizer Bar Link - Front	Heavy Duty L=260mm	7H0411317; 7H5411317B*

VOLKSWAGEN TRANSPORTER T5, facelift



05/2011-2016



SSP0705



SSP0271



SSP0271



SSP0704



SSP1982



SSP1982



SSP2580



SSP2580

PART NO.	DESCRIPTION	NOTES	O.E.
ARM1072	301181310720 Suspension Control Arm - Front Right Lower	for max 3,2T	7E8407152A; 7E8407152B
ARM1073	301181310730 Suspension Control Arm - Front Left Lower	for max 3,2T	7E8407151A; 7E8407151B
SSP0271	301191602710 Steering Tie Rod - Front	M16x1,5 - L=175,5mm	7H0419803C*; 7H0419804C*
SSP0704	301191607040 Steering Tie Rod End - Front Right	M16x1,5Rht	7H0422818B; 7H0422818C
SSP0705	301191607050 Steering Tie Rod End - Front Left	M16x1,5Rht	7H0422817B; 7H0422817C
SSP1982	301191619820 Suspension Ball Joint - Front Lower	Ø 22mm	7E0407361; 7H0407361A; 7H0407361
SSP1983	301191619830 Suspension Ball Joint - Front	3200Kg	7H8407361; 7H8407361A
SSP2580	301191625800 Suspension Stabilizer Bar Link - Front	L=260mm	7H5411317; 7H5411317B
SSP2581	301191625810 Suspension Stabilizer Bar Link - Front	Heavy Duty L=260mm	7H0411317; 7H5411317B*



VOLKSWAGEN TRANSPORTER T6 2016-



PART NO.	DESCRIPTION	NOTES	O.E.
ARM1072	301181310720 Suspension Control Arm - Front Right Lower	for max 3,2T	7E8407152A; 7E8407152B
ARM1073	301181310730 Suspension Control Arm - Front Left Lower	for max 3,2T	7E8407151A; 7E8407151B
SSP0271	301191602710 Steering Tie Rod - Front	M16x1,5 - L=175.5mm	7H0419803C*; 7H0419804C*
SSP0704	301191607040 Steering Tie Rod End - Front Right	M16x1,5Rht	7H0422818B; 7H0422818C
SSP0705	301191607050 Steering Tie Rod End - Front Left	M16x1,5Rht	7H0422817B; 7H0422817C
SSP1982	301191619820 Suspension Ball Joint - Front Lower	Ø 22mm	7E0407361; 7H0407361A; 7H0407361
SSP1983	301191619830 Suspension Ball Joint - Front	3200Kg	7H8407361; 7H8407361A
SSP2580	301191625800 Suspension Stabilizer Bar Link - Front	L=260mm	7H5411317; 7H5411317B
SSP2581	301191625810 Suspension Stabilizer Bar Link - Front	Heavy Duty L=260mm	7H0411317; 7H5411317B*

VOLKSWAGEN Up!



12/2011-2016

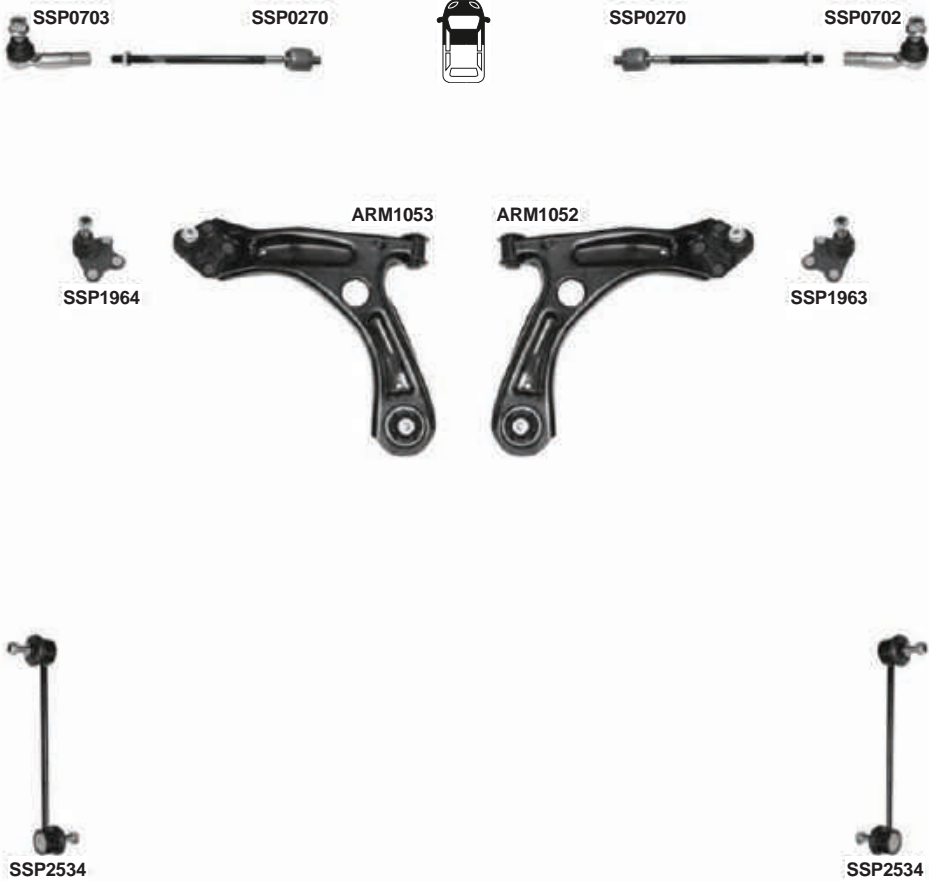

PART NO.	DESCRIPTION	NOTES	O.E.
ARM1052 301181310520	Suspension Control Arm and Ball Joint Assembly - Front Right Lower		1S0407152*
ARM1053 301181310530	Suspension Control Arm and Ball Joint Assembly - Front Left Lower		1S0407151*
SSP0270 301191602700	Steering Tie Rod - Front	M14X1,5 - L=306mm	1S0423810A
SSP0702 301191607020	Steering Tie Rod End - Front Right	M16x1,5Rht	1S0423812A
SSP0703 301191607030	Steering Tie Rod End - Front Left	M16x1,5Rht	1S0423811A
SSP1963 301191619630	Suspension Ball Joint - Front Right Lower		5U0407366A; 6R0407366
SSP1964 301191619640	Suspension Ball Joint - Front Left Lower		5U0407365A; 6R0407365
SSP2534 301191625340	Suspension Stabilizer Bar Link - Front	L=270mm	6Q0411315A; 6Q0411315F; 6Q0411315D; 6Q0411315C

**VOLKSWAGEN VENTO MK3/A3**

1991-1998

SSP0699



SSP0698



PART NO.	DESCRIPTION	NOTES	O.E.
SSP0698 301191606980	Steering Tie Rod End - Front Right	M14x1,5Rht	171419812; 3A0422812; 191419812
SSP0699 301191606990	Steering Tie Rod End - Front Left Outer	M14x1,5Rht	191419811; 3A0422811
SSP2585 301191625850	Suspension Stabilizer Bar Link - Front	L=78mm - D=Ø18mm	191411315A; 191411327



VOLVO C30



10/2006-12/2012



PART NO.	DESCRIPTION	NOTES	O.E.
ARM536 301181353600	Lateral Arm - Rear Lower		1061668; CV6Z5500L; 98AG5K743AF; BV615K743AA; 31277675; 2463500053; 1703145; 1753556
ARM540 301181354000	Suspension Control Arm and Ball Joint Assembly - Front Right Lower	Ball Joint D=Ø18mm	1254310; 1348191; 1328670; 1332074; 1309644; 1309148; 1305341
ARM541 301181354100	Suspension Control Arm and Ball Joint Assembly - Front Left Lower	Ball Joint D=Ø18mm	1254311; 1348192; 1328671; 1332075; 1309645; 1309149; 1305342
SSP0084 301191600840	Steering Tie Rod - Front Inner	M16x1,5 - L=293mm	1251937; 4M513L519AB; 3M513L519AA; 3M513L519AB; 30776283; 1377655; 1317453
SSP0421 301191604210	Steering Tie Rod End - Front Right	M16x1,5Rht	1317447; 4M513289AB; 30723104; 274501; 1328877
SSP0422 301191604220	Steering Tie Rod End - Front Left	M16x1,5Rht	1317446; 30723103; 4M513290AB; 274500; 1388549; 1328881
SSP1837 301191618370	Suspension Ball Joint - Front	D=Ø15mm	1234382; 3M513K209AA
SSP2190 301191621900	Suspension Stabilizer Bar Link - Front	L=298mm	1223792; AV613B438BAN; 8623576; AV613B438AA; 3M513B438AB; 1686594; 1230909
SSP2191 301191621910	Suspension Stabilizer Bar Link - Front	(Clip-on patented design) L=298mm	AV613B438AA*
SSP2192 301191621920	Suspension Stabilizer Bar Link - Rear	L=76mm	1310333; BP4K28170H; BP4K28170D; BP4K28170G; 30714466; 30683232; 1335548



VOLVO C70 I



11/1996-05/2000



ARM536



ARM536

PART NO.	DESCRIPTION	NOTES	O.E.
ARM536 301181353600	Lateral Arm - Rear Lower		1061668; CV6Z5500L; 98AG5K743AF; BV615K743AA; 31277675; 2463500053; 1703145; 1753556



VOLVO S40 I (VS)



07/1995-12/2003

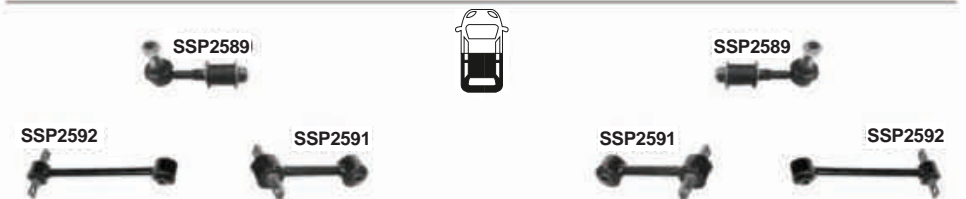
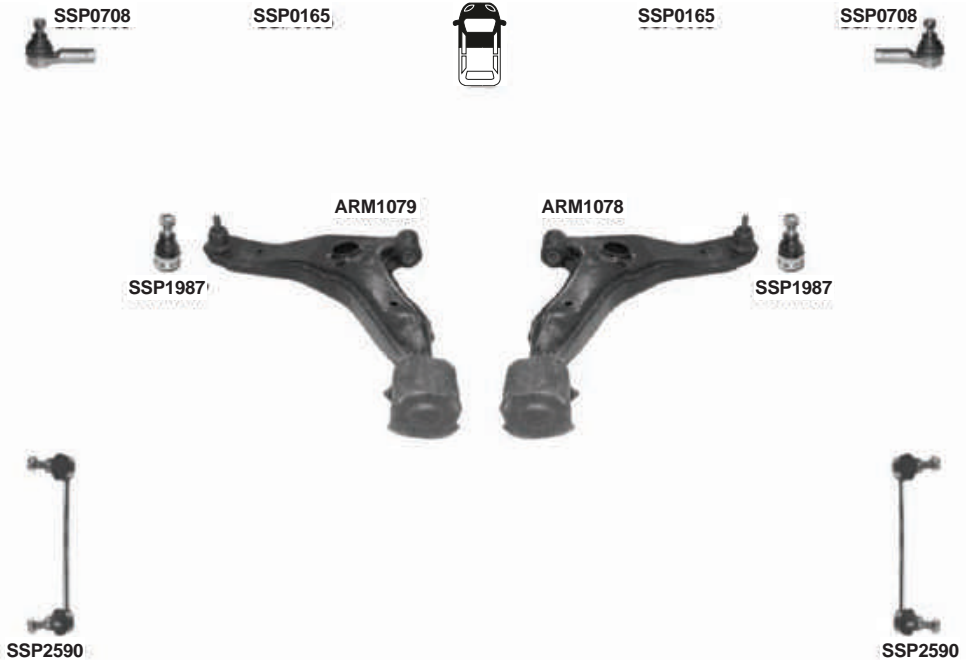

PART NO.	DESCRIPTION	NOTES	O.E.
ARM1078	301181310780 Suspension Control Arm and Ball Joint Assembly - Front Right Lower		30887654
ARM1079	301181310790 Suspension Control Arm and Ball Joint Assembly - Front Left Lower		30887653
SSP0165	301191601650 Steering Tie Rod - Front	M12x1,25 - L=310mm	3345797; MB297969; MR244901
SSP0708	301191607080 Steering Tie Rod End - Front	M12x1,25	30870695; MB598023; MB912076; MB241982; 30875012
SSP1987	301191619870 Suspension Ball Joint - Front		30821650*; MB518961; MB303374; 30821651*
SSP2589	301191625890 Suspension Stabilizer Bar Link - Rear	L=103,5 mm	30852103; MR272118; M884359; 30884359
SSP2590	301191625900 Suspension Stabilizer Bar Link - Front	L=200mm	30871770; MR131680; 30884358; 30873100
SSP2591	301191625910 Suspension Stabilizer Bar Link - Rear Center	L=143mm	30620785; 30818092; 30818091
SSP2592	301191625920 Suspension Stabilizer Bar Link - Rear	L=259mm	30620786; 30884360



VOLVO S40 II (MS)



01/2004-11/2012

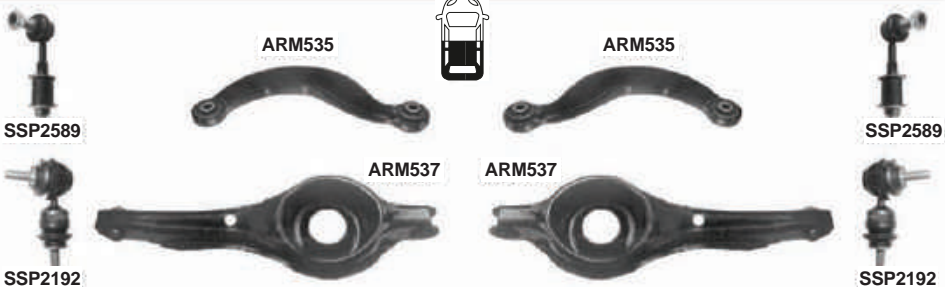
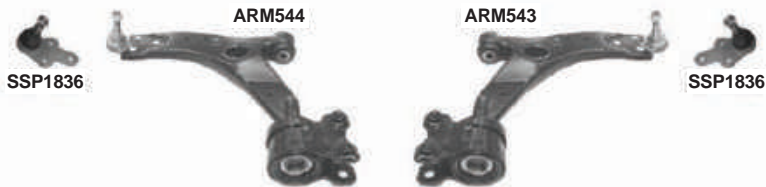



VOLVO S40 II (MS)



01/2004-11/2012

PART NO.	DESCRIPTION	NOTES	O.E.
ARM535	301181353500 Lateral Arm - Rear Upper		1061660; YS4Z5500AA; 1M515500AC; 98AG5500AG; 1M515500AB; 1329730; 1317609
ARM537	301181353700 Lateral Arm - Rear Lower Rearward		1064128; 98AG5K652AK; 4M515K652AD; 30666105; 1357017
ARM540	301181354000 Suspension Control Arm and Ball Joint Assembly - Front Right Lower	Ball Joint D=Ø18mm	1254310; 1348191; 1328670; 1332074; 1309644; 1309148; 1305341
ARM541	301181354100 Suspension Control Arm and Ball Joint Assembly - Front Left Lower	Ball Joint D=Ø18mm	1254311; 1348192; 1328671; 1332075; 1309645; 1309149; 1305342
ARM543	301181354300 Suspension Control Arm and Ball Joint Assembly - Front Right	D=Ø21mm	1420859; 4M513A423AD; 4M513A423AF; 31277462; 31262037; 31201180
ARM544	301181354400 Suspension Control Arm and Ball Joint Assembly - Front Left Lower	D=Ø21mm	1420858; 4M513A424AD; 4M513A424AF; 31277463; 31262039; 30714442
SSP0084	301191600840 Steering Tie Rod - Front Inner	M16x1,5 - L=293mm	1251937; 4M513L519AB; 3M513L519AA; 3M513L519AB; 30776283; 1377655; 1317453
SSP0421	301191604210 Steering Tie Rod End - Front Right	M16x1,5Rht	1317447; 4M513289AB; 30723104; 274501; 1328877
SSP0422	301191604220 Steering Tie Rod End - Front Left	M16x1,5Rht	1317446; 30723103; 4M513290AB; 274500; 1388549; 1328881
SSP1836	301191618360 Suspension Ball Joint - Front Lower	D=17,8mm	1470387; 3M513395BC
SSP1837	301191618370 Suspension Ball Joint - Front	D=Ø15mm	1234382; 3M513K209AA
SSP2190	301191621900 Suspension Stabilizer Bar Link - Front	L=298mm	1223792; AV613B438BAN; 8623576; AV613B438AA; 3M513B438AB; 1686594; 1230909
SSP2191	301191621910 Suspension Stabilizer Bar Link - Front	(Clip-on patented design) L=298mm	AV613B438AA*
SSP2192	301191621920 Suspension Stabilizer Bar Link - Rear	L=76mm	1310333; BP4K28170H; BP4K28170D; BP4K28170G; 30714466; 30683232; 1335548
SSP2589	301191625890 Suspension Stabilizer Bar Link - Rear	L=103,5 mm	30852103; MR272118; M884359; 30884359



VOLVO S60 I



07/2000-04/2010

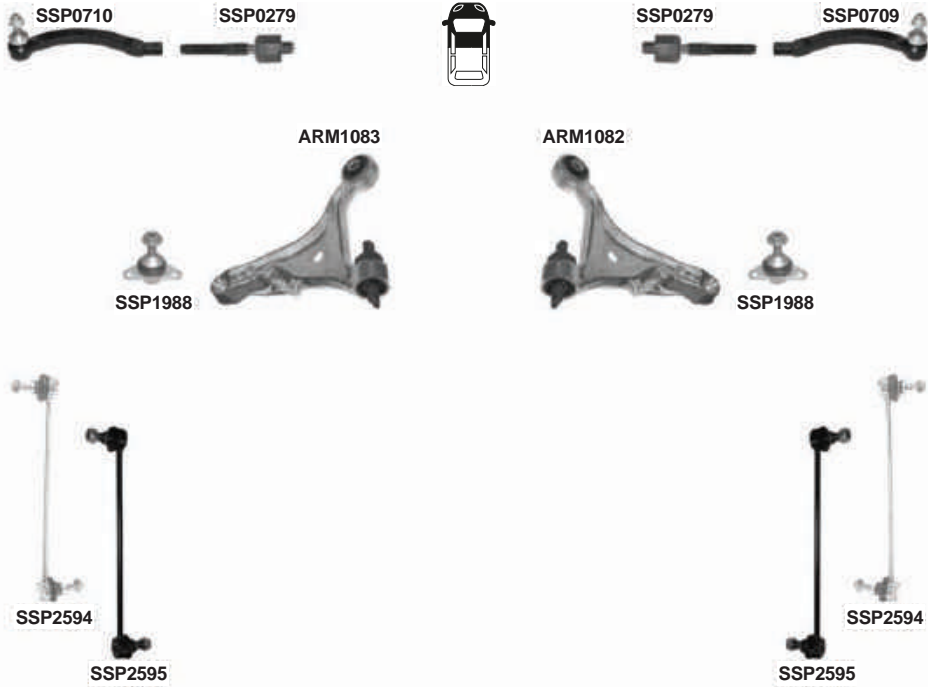

PART NO.	DESCRIPTION	NOTES	O.E.
ARM1082 301181310820	Suspension Control Arm - Front Right		30635230; 8649544; 8623958; 36012458
ARM1083 301181310830	Suspension Control Arm - Front Left		30635229; 8649543; 8623957; 36012457
SSP0279 301191602790	Steering Tie Rod - Front Inner	M14x1,5 - L=121mm	274353
SSP0709 301191607090	Steering Tie Rod End - Front Right Outer	M14x1,5Rht	274176; 30761718; 274497
SSP0710 301191607100	Steering Tie Rod End - Front Left Outer	M14x1,5Rht	274175; 30761719; 274496
SSP1988 301191619880	Suspension Ball Joint - Front Lower	Ø14.8 mm	274186; 274548; 274544; 274193
SSP2593 301191625930	Suspension Stabilizer Bar Link - Rear	L=140mm	30647920; 8672446; 31201603
SSP2594 301191625940	Suspension Stabilizer Bar Link - Front	L=332mm	274303; 31201602; 30714685; 274456
SSP2595 301191625950	Suspension Stabilizer Bar Link - Front	(Clip-on patented design) L=332mm	274303; 31201602; 30714685; 274456



VOLVO S60 II



04/2010-

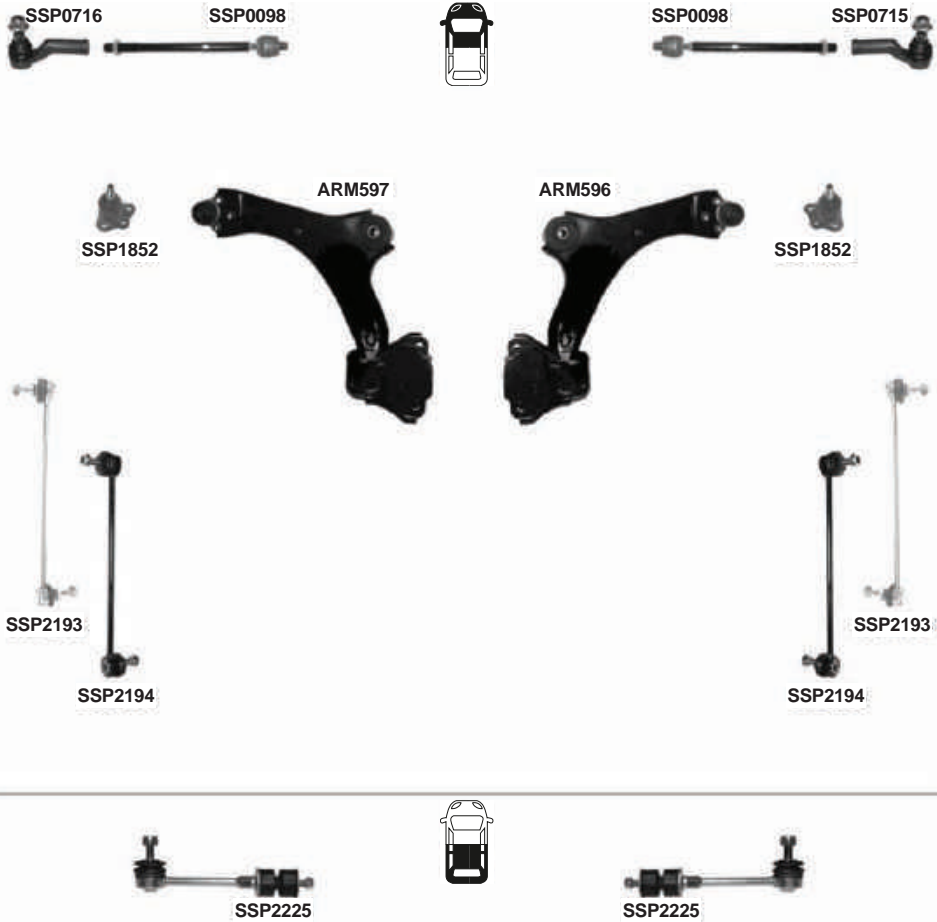

PART NO.	DESCRIPTION	NOTES	O.E.
ARM596	301181359600 Suspension Control Arm and Ball Joint Assembly - Front Right Lower		1469024; 7G9N3A052BA; 1507181; 31317662; 31277344
ARM597	301181359700 Suspension Control Arm and Ball Joint Assembly - Front Left Lower		1469026; 7G9N3A053BA; 31277343; 1507182; 31200448; 30760720
SSP0080	301191600800 Steering Tie Rod - Front	(Electric power steering)	1824228; DG9C3D032BA
SSP0098	301191600980 Steering Tie Rod - Front	M18x1,5 - L=315mm	1433271; 6G913280AB
SSP0281	301191602810 Steering Tie Rod - Front	(Servotronic steering)	31451036; 31280408
SSP0715	301191607150 Steering Tie Rod End - Front Right	M18X1,5	2601671; 31302345
SSP0716	301191607160 Steering Tie Rod End - Front Left	M18X1,5	2601672; 31302344
SSP1852	301191618520 Suspension Ball Joint - Front		1469026 Part of; 30671637 Part of; 6G9N3395AA Part of
SSP2193	301191621930 Suspension Stabilizer Bar Link - Front	L=300mm	1377849; 6G9N3B438BA; 30648461
SSP2194	301191621940 Suspension Stabilizer Bar Link - Front	(Clip-on patented design) L=300mm	6G9N3B438BA*
SSP2225	301191622250 Suspension Stabilizer Bar Link - Rear	L=116mm	1377416; 1425853; 6G91SC486XAB; 30760678



MAGNETI
MARELLI

VOLVO S70 I



11/1996-05/2000



ARM536



ARM536

PART NO.	DESCRIPTION	NOTES	O.E.
ARM536 301181353600	Lateral Arm - Rear Lower		1061668; CV6Z5500L; 98AG5K743AF; BV615K743AA; 31277675; 2463500053; 1703145; 1753556

VOLVO S80 I (TS,XY)



05/1998-07/2006

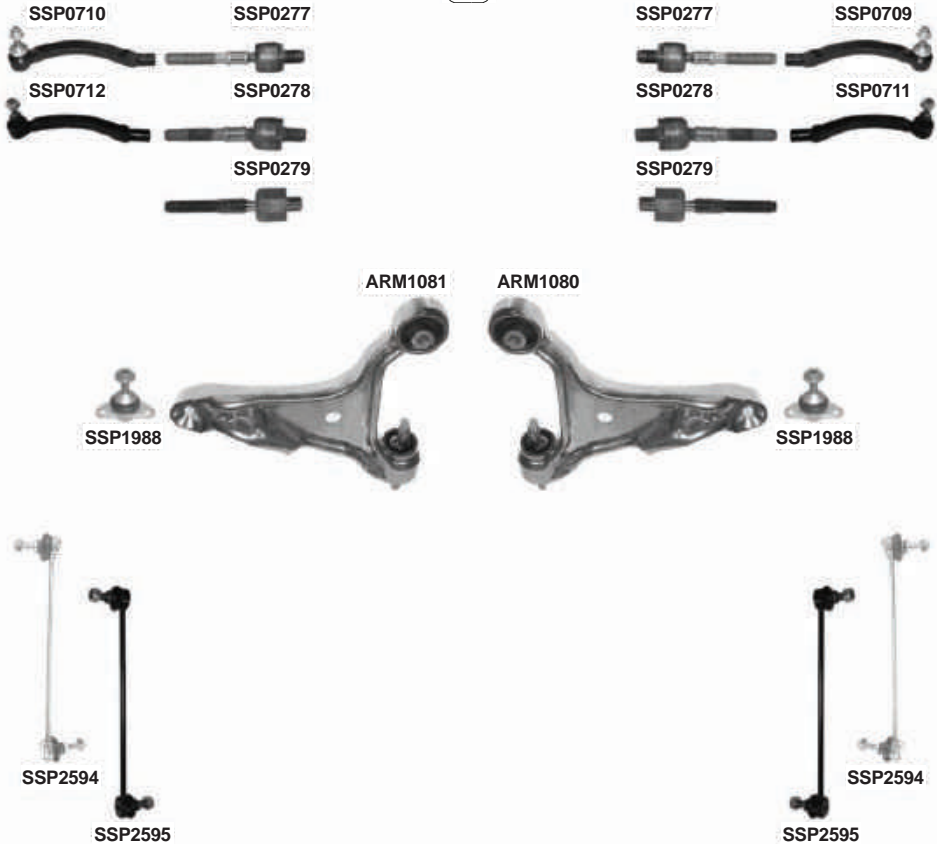

PART NO.	DESCRIPTION	NOTES	O.E.
ARM1080 301181310800	Suspension Control Arm - Front Right Lower		30635228; 9492106; 8649542
ARM1081 301181310810	Suspension Control Arm - Front Left		30635227; 9492105; 8649541; 8623955
SSP0277 301191602770	Steering Tie Rod - Front	(SMI Steering) M14x1,5 - L=123mm	274179
SSP0278 301191602780	Steering Tie Rod - Front	Only: 2.0 Lt. M14x2 - L=133mm	272428
SSP0279 301191602790	Steering Tie Rod - Front Inner	M14x1,5 - L=121mm	274353
SSP0709 301191607090	Steering Tie Rod End - Front Right Outer	M14x1,5Rht	274176; 30761718; 274497
SSP0710 301191607100	Steering Tie Rod End - Front Left Outer	M14x1,5Rht	274175; 30761719; 274496
SSP0711 301191607110	Steering Tie Rod End - Front Right	Only: 2.0 Lt. M14X2	272417
SSP0712 301191607120	Steering Tie Rod End - Front Left	Only: 2.0 Lt. M14X2	272416
SSP1988 301191619880	Suspension Ball Joint - Front Lower	Ø14.8 mm	274186; 274548; 274544; 274193
SSP2594 301191625940	Suspension Stabilizer Bar Link - Front	L=332mm	274303; 31201602; 30714685; 274456
SSP2595 301191625950	Suspension Stabilizer Bar Link - Front	(Clip-on patented design) L=332mm	274303; 31201602; 30714685; 274456



VOLVO S80 II (AS)



03/2006-2016

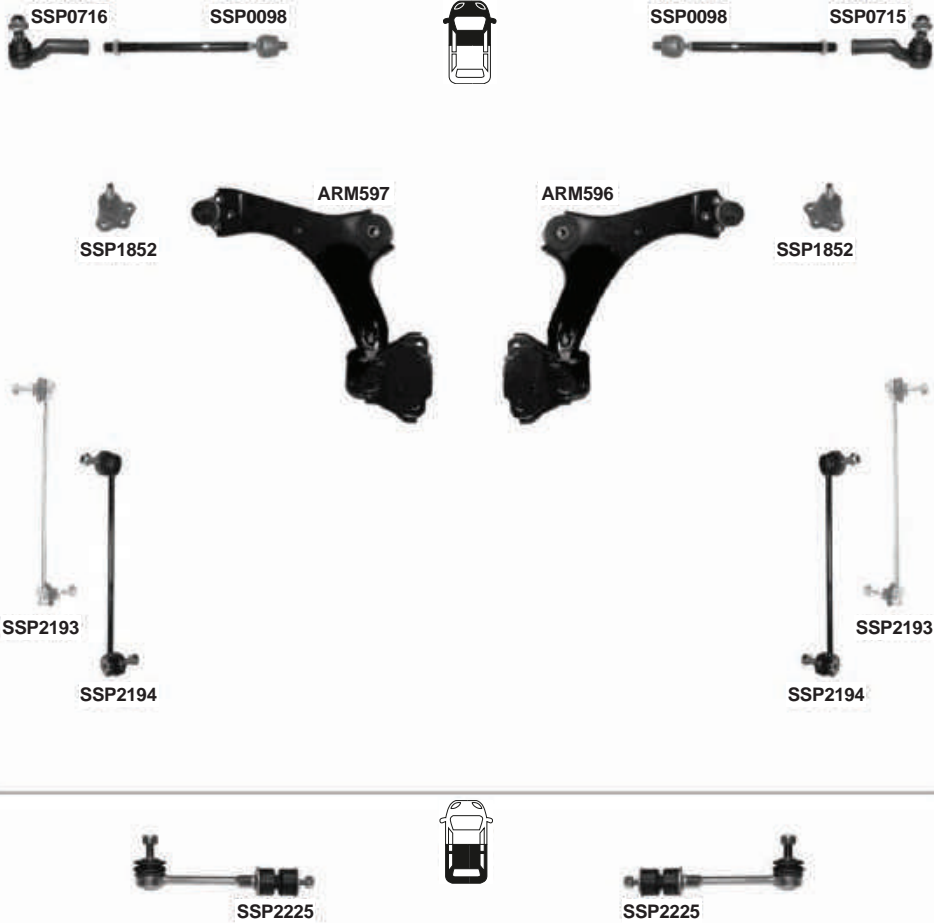

PART NO.	DESCRIPTION	NOTES	O.E.
ARM596	301181359600	Suspension Control Arm and Ball Joint Assembly - Front Right Lower	1469024; 7G9N3A052BA; 1507181; 31317662; 31277344
ARM597	301181359700	Suspension Control Arm and Ball Joint Assembly - Front Left Lower	1469026; 7G9N3A053BA; 31277343; 1507182; 31200448; 30760720
SSP0098	301191600980	Steering Tie Rod - Front	M18x1,5 - L=315mm 1433271; 6G913280AB
SSP0715	301191607150	Steering Tie Rod End - Front Right	M18X1,5 2601671; 31302345
SSP0716	301191607160	Steering Tie Rod End - Front Left	M18X1,5 2601672; 31302344
SSP1852	301191618520	Suspension Ball Joint - Front	1469026 Part of; 30671637 Part of; 6G9N3395AA Part of
SSP2193	301191621930	Suspension Stabilizer Bar Link - Front	L=300mm 1377849; 6G9N3B438BA; 30648461
SSP2194	301191621940	Suspension Stabilizer Bar Link - Front	(Clip-on patented design) L=300mm 6G9N3B438BA*
SSP2225	301191622250	Suspension Stabilizer Bar Link - Rear	L=116mm 1377416; 1425853; 6G91SC486XAB; 30760678



VOLVO V40 I (VW)



07/1995-06/2004

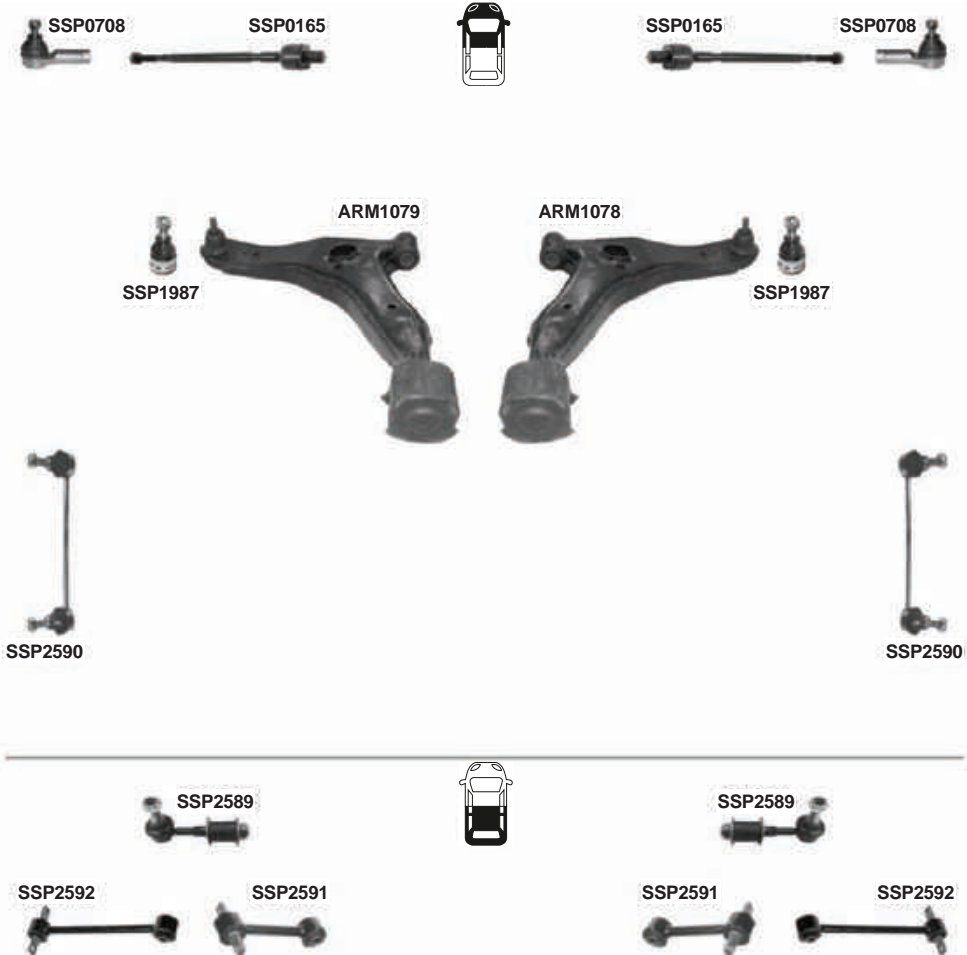

PART NO.	DESCRIPTION	NOTES	O.E.
ARM1078 301181310780	Suspension Control Arm and Ball Joint Assembly - Front Right Lower		30887654
ARM1079 301181310790	Suspension Control Arm and Ball Joint Assembly - Front Left Lower		30887653
SSP0165 301191601650	Steering Tie Rod - Front	M12x1,25 - L=310mm	3345797; MB297969; MR244901
SSP0708 301191607080	Steering Tie Rod End - Front	M12x1,25	30870695; MB598023; MB912076; MB241982; 30875012
SSP1987 301191619870	Suspension Ball Joint - Front		30821650*; MB518961; MB303374; 30821651*
SSP2589 301191625890	Suspension Stabilizer Bar Link - Rear	L=103,5 mm	30852103; MR272118; M884359; 30884359
SSP2590 301191625900	Suspension Stabilizer Bar Link - Front	L=200mm	30871770; MR131680; 30884358; 30873100
SSP2591 301191625910	Suspension Stabilizer Bar Link - Rear Center	L=143mm	30620785; 30818092; 30818091
SSP2592 301191625920	Suspension Stabilizer Bar Link - Rear	L=259mm	30620786; 30884360



VOLVO V40 II



03/2012-

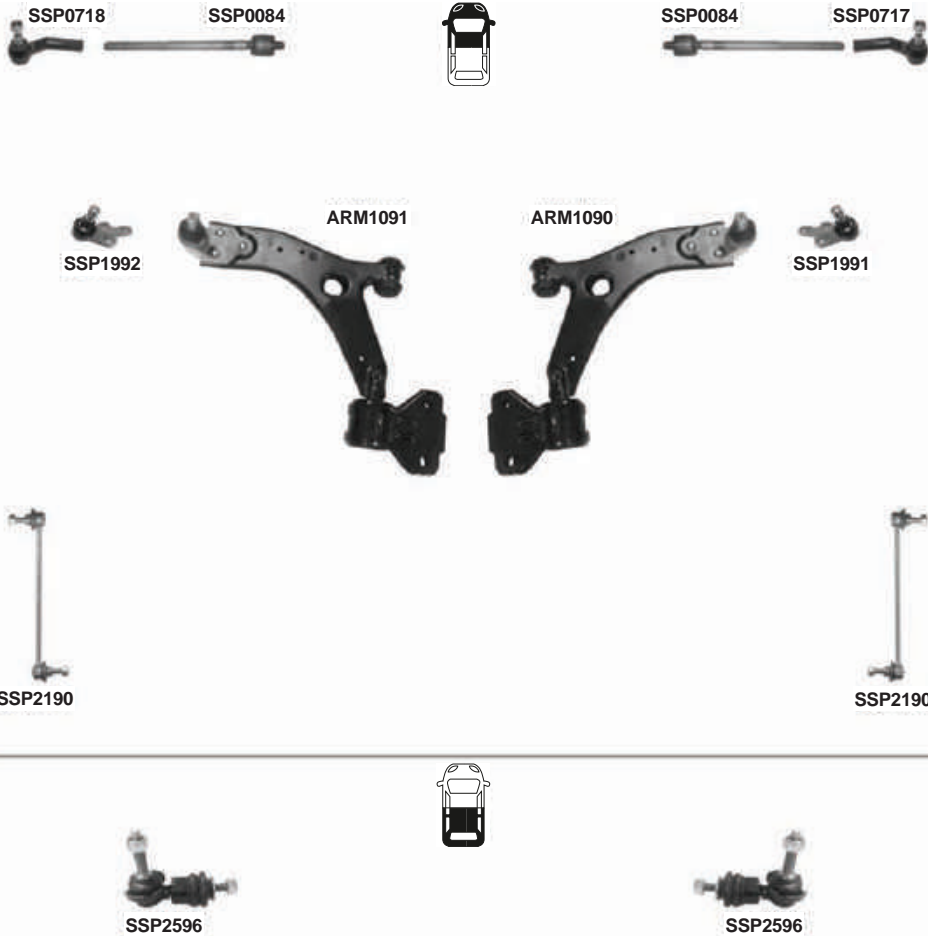

PART NO.	DESCRIPTION	NOTES	O.E.
ARM1090 301181310900	Suspension Control Arm and Ball Joint Assembly - Front Right Lower		31277621; 31340231
ARM1091 301181310910	Suspension Control Arm and Ball Joint Assembly - Front Left Lower		31277620; 31340232
SSP0084 301191600840	Steering Tie Rod - Front Inner	M16x1,5 - L=293mm	1251937; 4M513L519AB; 3M513L519AA; 3M513L519AB; 30776283; 1377655; 1317453
SSP0717 301191607170	Steering Tie Rod End - Front Right	M10x1,5	31317819
SSP0718 301191607180	Steering Tie Rod End - Front Left	M10x1,5	31317781
SSP1991 301191619910	Suspension Ball Joint - Front Right		Part of : 31340231
SSP1992 301191619920	Suspension Ball Joint - Front Left		Part of : 31340232
SSP2190 301191621900	Suspension Stabilizer Bar Link - Front	L=298mm	1223792; AV613B438BAN; 8623576; AV613B438AA; 3M513B438AB; 1686594; 1230909
SSP2596 301191625960	Suspension Stabilizer Bar Link - Rear	L=76mm	31317271; CV6Z5K484F; 31429024



VOLVO V50



04/2004-11/2012

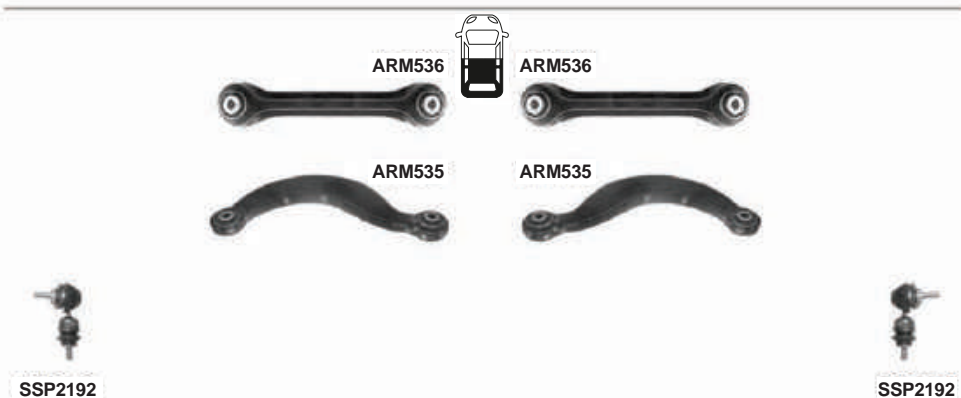

**VOLVO v50**

04/2004-11/2012

	PART NO.	DESCRIPTION	NOTES	O.E.
ARM535	301181353500	Lateral Arm - Rear Upper		1061660; YS4Z5500AA; 1M515500AC; 98AG5500AG; 1M515500AB; 1329730; 1317609
ARM536	301181353600	Lateral Arm - Rear Lower		1061668; CV6Z5500L; 98AG5K743AF; BV615K743AA; 31277675; 2463500053; 1703145; 1753556
ARM537	301181353700	Lateral Arm - Rear Lower Rearward		1064128; 98AG5K652AK; 4M515K652AD; 30666105; 1357017
ARM540	301181354000	Suspension Control Arm and Ball Joint Assembly - Front Right Lower	Ball Joint D=Ø18mm	1254310; 1348191; 1328670; 1332074; 1309644; 1309148; 1305341
ARM541	301181354100	Suspension Control Arm and Ball Joint Assembly - Front Left Lower	Ball Joint D=Ø18mm	1254311; 1348192; 1328671; 1332075; 1309645; 1309149; 1305342
SSP0084	301191600840	Steering Tie Rod - Front Inner	M16x1,5 - L=293mm	1251937; 4M513L519AB; 3M513L519AA; 3M513L519AB; 30776283; 1377655; 1317453
SSP0421	301191604210	Steering Tie Rod End - Front Right	M16x1,5Rht	1317447; 4M513289AB; 30723104; 274501; 1328877
SSP0422	301191604220	Steering Tie Rod End - Front Left	M16x1,5Rht	1317446; 30723103; 4M513290AB; 274500; 1388549; 1328881
SSP1837	301191618370	Suspension Ball Joint - Front	D=Ø15mm	1234382; 3M513K209AA
SSP2190	301191621900	Suspension Stabilizer Bar Link - Front	L=298mm	1223792; AV613B438BAN; 8623576; AV613B438AA; 3M513B438AB; 1686594; 1230909
SSP2191	301191621910	Suspension Stabilizer Bar Link - Front	(Clip-on patented design) L=298mm	AV613B438AA*
SSP2192	301191621920	Suspension Stabilizer Bar Link - Rear	L=76mm	1310333; BP4K28170H; BP4K28170D; BP4K28170G; 30714466; 30683232; 1335548



VOLVO V70 I



11/1996-05/2000

ARM536



ARM536



PART NO.	DESCRIPTION	NOTES	O.E.
ARM536 301181353600	Lateral Arm - Rear Lower		1061668; CV6Z5500L; 98AG5K743AF; BV615K743AA; 31277675; 2463500053; 1703145; 1753556



VOLVO V70 II (P80)



03/2000-08/2007

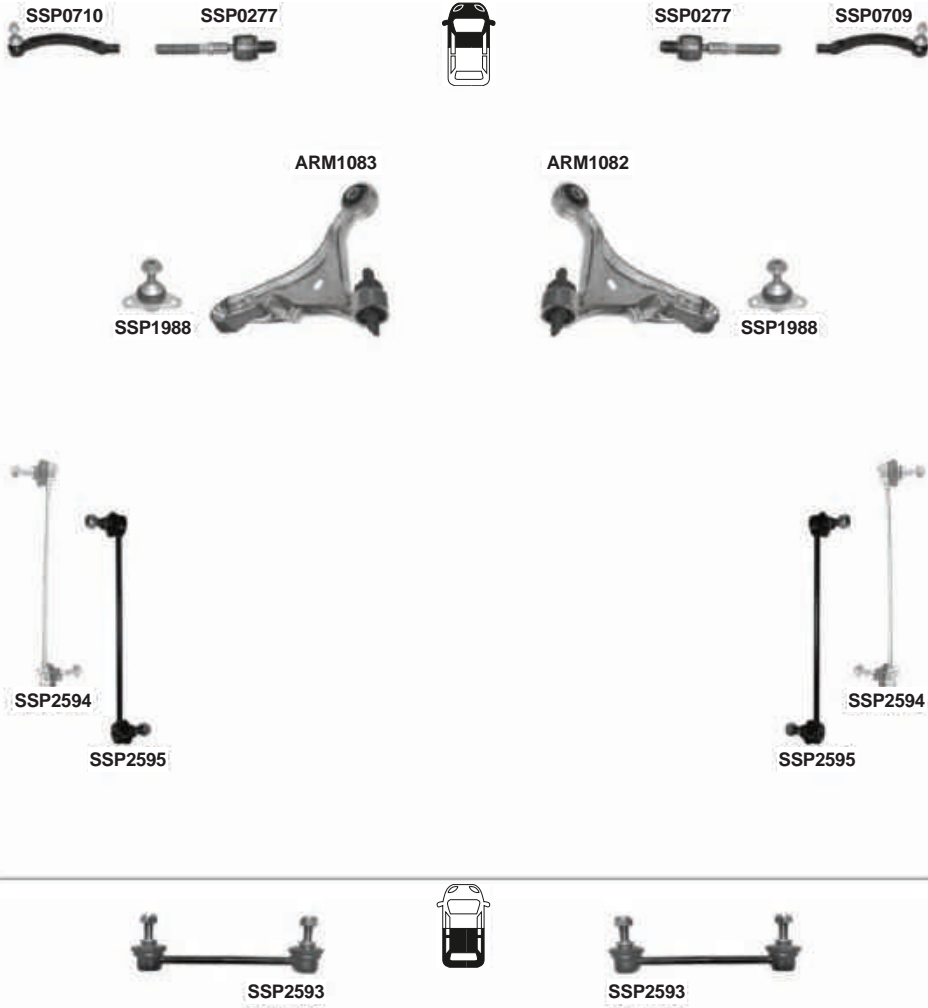

PART NO.	DESCRIPTION	NOTES	O.E.
ARM1082 301181310820	Suspension Control Arm - Front Right		30635230; 8649544; 8623958; 36012458
ARM1083 301181310830	Suspension Control Arm - Front Left		30635229; 8649543; 8623957; 36012457
SSP0277 301191602770	Steering Tie Rod - Front	(SMI Steering) M14x1,5 - L=123mm	274179
SSP0709 301191607090	Steering Tie Rod End - Front Right Outer	M14x1,5Rht	274176; 30761718; 274497
SSP0710 301191607100	Steering Tie Rod End - Front Left Outer	M14x1,5Rht	274175; 30761719; 274496
SSP1988 301191619880	Suspension Ball Joint - Front Lower	Ø14.8 mm	274186; 274548; 274544; 274193
SSP2593 301191625930	Suspension Stabilizer Bar Link - Rear	L=140mm	30647920; 8672446; 31201603
SSP2594 301191625940	Suspension Stabilizer Bar Link - Front	L=332mm	274303; 31201602; 30714685; 274456
SSP2595 301191625950	Suspension Stabilizer Bar Link - Front	(Clip-on patented design) L=332mm	274303; 31201602; 30714685; 274456



VOLVO V70 III



08/2007-2016

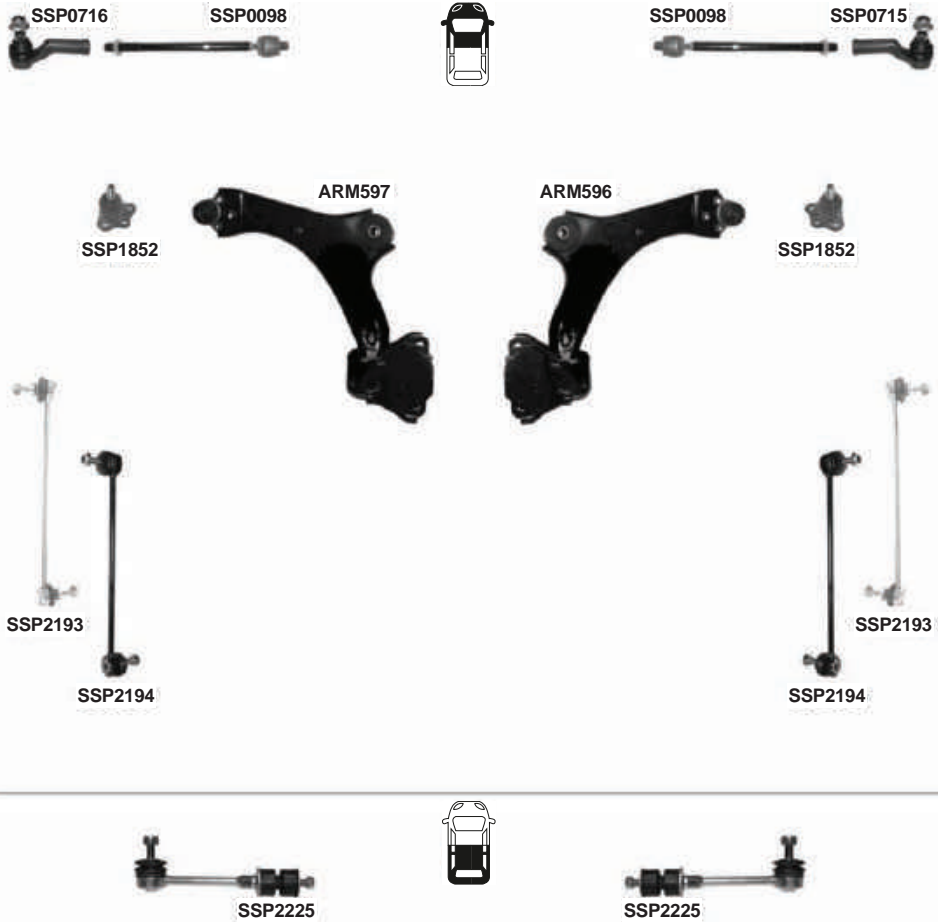

PART NO.	DESCRIPTION	NOTES	O.E.
ARM596	301181359600 Suspension Control Arm and Ball Joint Assembly - Front Right Lower		1469024; 7G9N3A052BA; 1507181; 31317662; 31277344
ARM597	301181359700 Suspension Control Arm and Ball Joint Assembly - Front Left Lower		1469026; 7G9N3A053BA; 31277343; 1507182; 31200448; 30760720
SSP0098	301191600980 Steering Tie Rod - Front	M18x1,5 - L=315mm	1433271; 6G913280AB
SSP0715	301191607150 Steering Tie Rod End - Front Right	M18X1,5	2601671; 31302345
SSP0716	301191607160 Steering Tie Rod End - Front Left	M18X1,5	2601672; 31302344
SSP1852	301191618520 Suspension Ball Joint - Front		1469026 Part of; 30671637 Part of; 6G9N3395AA Part of
SSP2193	301191621930 Suspension Stabilizer Bar Link - Front	L=300mm	1377849; 6G9N3B438BA; 30648461
SSP2194	301191621940 Suspension Stabilizer Bar Link - Front	(Clip-on patented design) L=300mm	6G9N3B438BA*
SSP2225	301191622250 Suspension Stabilizer Bar Link - Rear	L=116mm	1377416; 1425853; 6G91SC486XAB; 30760678

**VOLVO XC60**

05/2008-2016



PART NO.	DESCRIPTION	NOTES	O.E.
ARM1086 301181310860	Suspension Control Arm and Ball Joint Assembly - Front Right Lower		30881488; 31317666; 31277526
ARM1087 301181310870	Suspension Control Arm and Ball Joint Assembly - Front Left Lower		30881487; 31317665; 31277525
SSP0280 301191602800	Steering Tie Rod - Front	M18x1,5 - L=330mm	31280409
SSP0281 301191602810	Steering Tie Rod - Front	(Servotronic steering)	31451036; 31280408
SSP0438 301191604380	Steering Tie Rod End - Front Right	M18x1,5	1433273; LR002609; 30776248; 6G913290AA; 31280001
SSP0439 301191604390	Steering Tie Rod End - Front Left	M18x1,5	1433274; LR002610; 30776249; 6G913289AA; 31280001
SSP1990 301191619900	Suspension Ball Joint - Front Lower		Part of 30881488/30881487; Part of 31277526/31277525
SSP2193 301191621930	Suspension Stabilizer Bar Link - Front	L=300mm	1377849; 6G9N3B438BA; 30648461
SSP2194 301191621940	Suspension Stabilizer Bar Link - Front	(Clip-on patented design) L=300mm	6G9N3B438BA*
SSP2225 301191622250	Suspension Stabilizer Bar Link - Rear	L=116mm	1377416; 1425853; 6G91SC486XAB; 30760678



PART NO.	DESCRIPTION	NOTES	O.E.
SSP0279 301191602790	Steering Tie Rod - Front Inner	M14x1,5 - L=121mm	274353
SSP0709 301191607090	Steering Tie Rod End - Front Right Outer	M14x1,5Rht	274176; 30761718; 274497
SSP0710 301191607100	Steering Tie Rod End - Front Left Outer	M14x1,5Rht	274175; 30761719; 274496
SSP1988 301191619880	Suspension Ball Joint - Front Lower	Ø14.8 mm	274186; 274548; 274544; 274193
SSP2593 301191625930	Suspension Stabilizer Bar Link - Rear	L=140mm	30647920; 8672446; 31201603
SSP2594 301191625940	Suspension Stabilizer Bar Link - Front	L=332mm	274303; 31201602; 30714685; 274456
SSP2595 301191625950	Suspension Stabilizer Bar Link - Front	(Clip-on patented design) L=332mm	274303; 31201602; 30714685; 274456

**VOLVO XC70 III**

08/2007-



PART NO.	DESCRIPTION	NOTES	O.E.
ARM1088 301181310880	Suspension Control Arm and Ball Joint Assembly - Front Right Lower		30683248; 31317663; 31202228
ARM1089 301181310890	Suspension Control Arm and Ball Joint Assembly - Front Left Lower		30 683 248; 31 317 663; 31 277 345; 31 202 228
SSP1990 301191619900	Suspension Ball Joint - Front Lower		Part of 30881488/30881487; Part of 31277526/31277525



VOLVO XC90 I



10/2002-10/2014

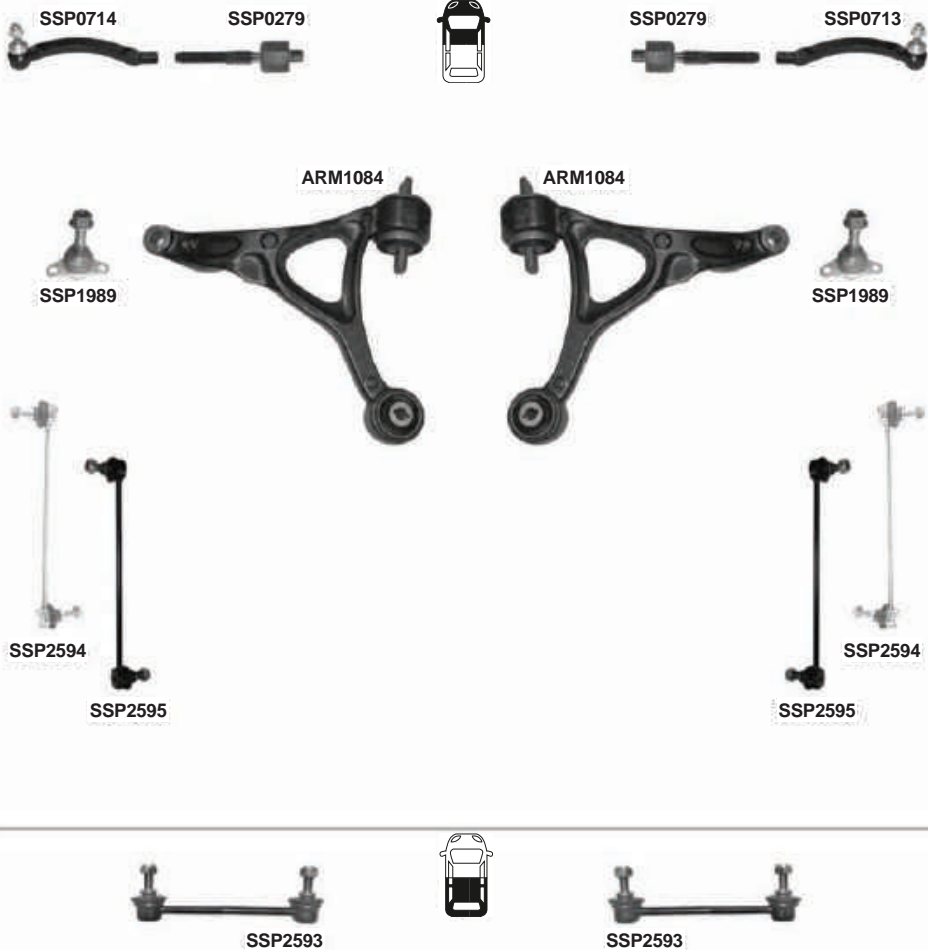

PART NO.	DESCRIPTION	NOTES	O. E.
ARM1084 301181310840	Suspension Control Arm - Front Right		30683249; 31317664; 31277346; 31202229
ARM1085 301181310850	Suspension Control Arm - Front Left		30639780; 31304045; 31201004; 30645845
SSP0279 301191602790	Steering Tie Rod - Front Inner	M14x1,5 - L=121mm	274353
SSP0713 301191607130	Steering Tie Rod End - Front Right	M14x1,5Rht.	274352; 274499
SSP0714 301191607140	Steering Tie Rod End - Front Left	M14x1,5Rht.	2741910; 274498; 274351
SSP1989 301191619890	Suspension Ball Joint - Front Lower		274377; 31202485; 274573; 274523
SSP2593 301191625930	Suspension Stabilizer Bar Link - Rear	L=140mm	30647920; 8672446; 31201603
SSP2594 301191625940	Suspension Stabilizer Bar Link - Front	L=332mm	274303; 31201602; 30714685; 274456
SSP2595 301191625950	Suspension Stabilizer Bar Link - Front	(Clip-on patented design) L=332mm	274303; 31201602; 30714685; 274456



MAGNETI
MARELLI

YUGO 101 ZASTAVA SPORT



1969-1986

SSP0071



SSP0071



PART NO.	DESCRIPTION	NOTES	O.E.
SSP0071 301191600710	Steering Tie Rod - Front	M12x1,5 - L=192mm	5960321; SE141162449A

*Tavole di comparazione
Cross reference guide
Gegenüberstellung Cross-Referenzen
Table de correspondance
Tabla de equivalencias
Tabelas de equivalências
Πίνακας αντιστοιχιών
Tabela porównawcza
Кросс-таблица
Çapraz referans tablosu*





MAGNETI MARELLI	O.E.	MAGNETI MARELLI	O.E.	MAGNETI MARELLI	O.E.
ARM001	7636996	ARM025	1317241080	ARM059	51895366
ARM002	7636995	ARM025	3521.65	ARM059	55703627
ARM003	50509339	ARM026	1308600080	ARM059	3521.S6
ARM003	60652466	ARM026	1317240080	ARM059	3521V5
ARM003	60678135	ARM026	3520.95	ARM060	51828661
ARM003	60686892	ARM027	1308760080	ARM060	51835397
ARM004	50509340	ARM027	1317239080	ARM060	50704947
ARM004	60652465	ARM027	1339460080	ARM061	51828660
ARM004	60678134	ARM027	3521.66	ARM061	51835398
ARM004	60686891	ARM027	3521.H3	ARM061	50704948
ARM007	46456050	ARM027	3521.J4	ARM062	50704306
ARM007	60586772	ARM028	1308759080	ARM062	50706858
ARM007	60809814	ARM028	1317238080	ARM062	50707316
ARM008	46456049	ARM028	3520.96	ARM062	51795447
ARM008	60586771	ARM035	93501488	ARM063	50704307
ARM008	60809813	ARM035	1346385080	ARM063	50706859
ARM017	50700779	ARM035	1346384080	ARM063	50707317
ARM017	93501486	ARM035	3521.H1	ARM063	51795446
ARM018	50700797	ARM036	93501487	ARM068	50705464
ARM018	93501485	ARM036	1346384080	ARM068	51827736
ARM019	46522147	ARM036	1346385080	ARM070	50705465
ARM019	46764747	ARM036	3521.H0	ARM070	51827737
ARM020	46525407	ARM036	3521.K6	ARM071	50709580
ARM020	46764746	ARM037	4520084	ARM071	50710621
ARM023	1313084080	ARM037	4520085	ARM072	50709579
ARM023	1316736080	ARM037	4705742	ARM072	50710620
ARM023	1317390080	ARM037	4706665	ARM073	50711395
ARM023	1322664080	ARM037	4707280	ARM073	1497407080
ARM023	3521.83	ARM037	9210270	ARM073	3521.N9
ARM023	3521.C9	ARM037	9214826	ARM074	50711394
ARM023	3521.K4	ARM037	4705172	ARM074	1497408080
ARM023	93500973	ARM041	46423823	ARM074	3520.R8
ARM024	1313083080	ARM041	82461082	ARM075	50703231
ARM024	1316735080	ARM042	46423822	ARM075	50703321
ARM024	1317389080	ARM042	82461081	ARM076	50703232
ARM024	1322663080	ARM058	51783057	ARM081	50701379
ARM024	3520.94	ARM058	51895367	ARM081	50710906
ARM024	3520.C3	ARM058	55703629	ARM081	51857136
ARM024	3520.G9	ARM058	3520.W3	ARM082	50701380
ARM024	93500972	ARM058	3520.Y4	ARM082	50710905
ARM025	1308601080	ARM059	51783056	ARM082	51857135



MAGNETI MARELLI	O.E.	MAGNETI MARELLI	O.E.	MAGNETI MARELLI	O.E.
ARM089	50703129	ARM1024	4806842050*	ARM1050	1K0407152AC
ARM089	51857134	ARM1024	4806842051*	ARM1051	1K0407151AC
ARM090	50703128	ARM1025	4806942050*	ARM1052	1S0407152*
ARM090	51857133	ARM1025	4806942051*	ARM1053	1S0407151*
ARM091	1352225080	ARM1026	487100R030	ARM1054	1K0505224K
ARM091	3521.P1	ARM1027	480680R030*	ARM1055	1K0505223K
ARM092	1352227080	ARM1027	4806842060*	ARM1056	5Q0501529C
ARM092	3520.S0	ARM1028	480690R030*	ARM1057	5Q0505323C
ARM093	1352226080	ARM1028	4806942060*	ARM1057	5Q0505323D
ARM093	3521.P2	ARM1029	4806812260*	ARM1058	5Q0407152J*
ARM094	1352228080	ARM1030	4806912260*	ARM1059	5Q0407151J*
ARM094	3520.S1	ARM1031	4806879015	ARM1060	5C0407152B*
ARM095	46545661	ARM1032	4806979015	ARM1061	1K0407151B*
ARM095	46551790	ARM1033	95534102701	ARM1062	1K0407152BG*
ARM096	46545660	ARM1033	95534102702	ARM1063	1K0407151BG*
ARM096	46551732	ARM1033	7L0407021A	ARM1064	5N0407152*
ARM098	50513444	ARM1033	7L0407021B	ARM1065	5N0407151*
ARM099	50513442	ARM1034	7L0505323A	ARM1066	3Q0407152E
ARM1001	4863060010	ARM1035	95534101832	ARM1066	3Q0407152F
ARM1002	4862060010	ARM1035	7L0407152C	ARM1067	3Q0407151E
ARM1003	4864060010	ARM1035	7L0407152D	ARM1067	3Q0407151F
ARM1004	4806842022	ARM1036	95534101731	ARM1068	7H0407152E
ARM1005	4806942022*	ARM1036	7L0407151C	ARM1069	7H0407151E
ARM1006	486100K010	ARM1036	7L0407151D	ARM1070	1012632
ARM1007	486300K010	ARM1037	1T0505224F	ARM1070	7M0407152B
ARM1008	480680K010	ARM1038	1T0505223F	ARM1070	95VW3078AC
ARM1009	480690K010	ARM1039	1K0505311AA	ARM1071	1007602
ARM1010	486100K040	ARM1039	1K0505311AB	ARM1071	7M0407151B
ARM1011	486300K040	ARM1039	1K0505311S	ARM1071	95VW3079AC
ARM1012	480680K040	ARM1040	561407152A*	ARM1072	7E8407152A
ARM1013	480690K040	ARM1041	561407151A*	ARM1072	7E8407152B
ARM1014	4806859035	ARM1042	2H0407022B	ARM1073	7E8407151A
ARM1015	4806959035	ARM1043	2H0407021B	ARM1073	7E8407151B
ARM1016	4806859055	ARM1044	2H0407152A	ARM1074	6N0407151*
ARM1017	4806959055	ARM1045	2H0407151A	ARM1074	6N0407365A*
ARM1018	4806809041	ARM1046	3C0407151G*	ARM1075	6N0407151*
ARM1018	4806809150	ARM1047	3C0407151H*	ARM1075	6N0407365*
ARM1019	4806909040	ARM1048	1K0407152P*	ARM1076	6R0407152A**
ARM1019	4806909140	ARM1048	1K0407152Q*	ARM1076	6R0407152F**
ARM1022	4806842040	ARM1049	1K0407151P*	ARM1077	6R0407151A**
ARM1023	4806942040	ARM1049	1K0407151Q*	ARM1077	6R0407151F**



MAGNETI MARELLI	O.E.	MAGNETI MARELLI	O.E.	MAGNETI MARELLI	O.E.
ARM1078	30887654	ARM1091	31340232	ARM124	51787337
ARM1079	30887653	ARM1092	4861060060	ARM124	50704481
ARM1080	8649542	ARM1093	4863060030	ARM125	60627291
ARM1080	9492106	ARM111	46777741	ARM125	60665805
ARM1080	30635228	ARM111	46794065	ARM126	60627290
ARM1081	8623955	ARM111	51712407	ARM126	60665804
ARM1081	8649541	ARM111	51769073	ARM127	60666020
ARM1081	9492105	ARM111	51866700	ARM128	60653551
ARM1081	30635227	ARM112	46777742	ARM133	46454596
ARM1082	8623958	ARM112	46794066	ARM134	46454595
ARM1082	8649544	ARM112	51712408	ARM135	51772988
ARM1082	30635230	ARM112	51769074	ARM136	51772992
ARM1082	36012458	ARM113	51727863	ARM137	K04766423AB
ARM1083	8623957	ARM113	98810139	ARM137	K04766423AD
ARM1083	8649543	ARM114	51769076	ARM137	K04766424AA
ARM1083	30635229	ARM114	98810140	ARM137	K04766424AB
ARM1083	36012457	ARM115	51810664	ARM137	K04766424AC
ARM1084	30683249	ARM116	51810665	ARM137	K04766424AD
ARM1084	31202229	ARM117	352052	ARM137	K04766424AE
ARM1084	31277346	ARM117	12796014	ARM138	K04766423AA
ARM1084	31317664	ARM117	12799200	ARM138	K04766423AB
ARM1085	30639780	ARM117	51748652	ARM138	K04766423AC
ARM1085	30645845	ARM118	352051	ARM138	K04766423AD
ARM1085	31201004	ARM118	12796013	ARM138	K04766423AE
ARM1085	31304045	ARM118	12799200	ARM138	K04766424AB
ARM1086	30881488	ARM118	51748653	ARM138	K04766424AD
ARM1086	31277526	ARM119	51834094	ARM139	4694760
ARM1086	31317666	ARM119	60651940	ARM140	4694761
ARM1087	30881487	ARM119	60657246	ARM141	4766542
ARM1087	31277525	ARM120	51834093	ARM141	4766542AA
ARM1087	31317665	ARM120	60651939	ARM142	4766543
ARM1088	30683248	ARM120	60657245	ARM142	4766543AA
ARM1088	31202228	ARM121	60622624	ARM147	46454598
ARM1088	31317663	ARM121	60651934	ARM148	46454597
ARM1089	30 683 248	ARM122	60622623	ARM149	4408138
ARM1089	31 202 228	ARM122	60651935	ARM149	5995503
ARM1089	31 277 345	ARM123	50704480	ARM149	SE028140104A
ARM1089	31 317 663	ARM123	50704948	ARM149	SE028140104A*
ARM1090	31277621	ARM123	51787336	ARM150	4402672
ARM1090	31340231	ARM124	50704947	ARM150	7601261
ARM1091	31277620	ARM124	50707481	ARM150	SE141156110A



MAGNETI MARELLI	O.E.	MAGNETI MARELLI	O.E.	MAGNETI MARELLI	O.E.
ARM151	04656730AH	ARM178	4D0407694N	ARM202	8N0407151D*
ARM152	04656731AH	ARM178	8E0407693K	ARM203	8K0407694S
ARM153	50705084	ARM178	8E0407694	ARM203	8K0407694T
ARM153	50705465	ARM179	4D0407693M	ARM204	8K0407693S
ARM154	50705083	ARM179	4D0407693N	ARM204	8K0407693T
ARM154	50705464	ARM179	8E0407693	ARM205	8K0407152F
ARM155	7601062	ARM179	8E0407693K	ARM205	8K0407152G
ARM155	93501181	ARM180	4D0407151G	ARM206	8K0407151F
ARM156	7601057	ARM180	4D0407151H	ARM206	8K0407151G
ARM156	93501180	ARM180	4D0407151J	ARM207	4E0407510B
ARM161	895407148A	ARM180	8E0407151N	ARM208	4E0407509B
ARM162	895407147A	ARM181	8E0407151M	ARM209	4E0407506B
ARM163	4Z7407694D	ARM182	1J0407151B	ARM210	4E0407505B
ARM164	4Z7407693D	ARM183	1J0407151A	ARM211	4F0407694
ARM165	4Z7407151C	ARM184	4D0407505A	ARM211	4F0407694B
ARM166	4Z7407151G	ARM184	4D0407505D	ARM211	4F0407694C
ARM167	5Q0407152J	ARM184	4D0407505F	ARM212	4F0407693
ARM168	5Q0407151J	ARM185	8D0501530	ARM212	4F0407693B
ARM169	1J0505323E	ARM186	8E0501529F	ARM212	4F0407693C
ARM169	1J0505323H	ARM186	8E0501529G	ARM213	4F0407151
ARM169	1J0505323L	ARM186	8E0501529K	ARM213	4F0407151A
ARM169	1J0505323M	ARM186	8E0501529P	ARM214	3R0505324
ARM170	4D0407510D	ARM187	3C0505224D	ARM214	8E0505324M
ARM170	4D0407510J	ARM188	3C0505223D	ARM215	3R0505323
ARM171	4D0407510F	ARM189	1K0505323N	ARM215	8E0505323M
ARM171	4D0407510G	ARM190	8K0501530N	ARM216	8E0407694AL
ARM172	4D0407509D	ARM191	8K0501529N	ARM216	8E0407694T
ARM172	4D0407509J	ARM192	8K0407152B	ARM217	8E0407693AL
ARM173	4D0407509F	ARM193	8K0407151B	ARM217	8E0407693T
ARM173	4D0407509G	ARM194	8K0407694F	ARM218	4F0501529C
ARM174	8D0407506B	ARM194	8K0407694N	ARM218	4F0501529E
ARM174	8D0407506H	ARM195	8K0407693F	ARM219	4H0407506E
ARM175	8D0407506A	ARM195	8K0407693N	ARM220	4H0407505E
ARM175	8D0407506B	ARM196	8K0407506A	ARM221	4H0407510E
ARM175	8D0407506F	ARM197	8K0407505A	ARM222	4H0407509E
ARM175	8E0407506A	ARM198	8K0407510A	ARM223	4H0407694E
ARM176	8D0407505B	ARM199	8K0407509A	ARM224	4H0407693E
ARM176	8D0407505H	ARM200	8K0501529L	ARM225	4H0407152B
ARM177	8D0407505A	ARM201	8N0407152A*	ARM226	4H0407151B
ARM177	8E0407505A	ARM201	8N0407152D*	ARM227	4G0407694D
ARM178	4D0407694M	ARM202	8N0407151A*	ARM227	4G0407694F



MAGNETI MARELLI	O.E.	MAGNETI MARELLI	O.E.	MAGNETI MARELLI	O.E.
ARM227	4G0407694H	ARM252	31124036269	ARM277	31121094465
ARM227	4G0407694J	ARM252	31126763703	ARM277	31126751317
ARM228	4G0407693D	ARM252	31126763707	ARM277	31126752717
ARM228	4G0407693F	ARM252	31126769797	ARM277	31126758519
ARM228	4G0407693H	ARM253	33326765425	ARM278	31121094465
ARM228	4G0407693J	ARM253	33326765534	ARM279	31121094465
ARM229	8K0407506M	ARM253	33326782237	ARM280	31122282122
ARM230	8K0407505M	ARM254	33326763473	ARM281	31122282122
ARM231	8K0407510M	ARM254	33326777980	ARM282	31122282121
ARM232	8K0407509M	ARM255	33326763471	ARM283	31122282121
ARM233	8K0407152D	ARM256	31126768984	ARM284	31122229454
ARM234	8K0407151D	ARM257	31126768983	ARM285	31122229453
ARM235	8K0505324H	ARM258	31126852992	ARM286	31124026453
ARM236	8K0505323H	ARM259	31126852991	ARM286	31126756101
ARM237	7L0505398	ARM260	31126855742	ARM286	31126774831
ARM238	7L0505397	ARM261	31126855741	ARM287	31126756102
ARM239	7L8501529A	ARM262	33326792540	ARM287	31126765994
ARM240	7L8407152E	ARM263	33326792539	ARM287	31126774832
ARM241	7L8407151E	ARM264	33326792525	ARM288	31126755835
ARM242	4E0501529D	ARM265	33326792533	ARM288	31126770121
ARM242	4E0501529G	ARM266	33326792544	ARM288	31126777937
ARM243	4E0407694C	ARM267	33326792543	ARM288	31126777939
ARM243	4E0407694F	ARM268	31121092024	ARM289	31126755836
ARM244	4E0407693C	ARM268	31121141718	ARM289	31126770122
ARM244	4E0407693F	ARM269	31121092023	ARM289	31126777938
ARM245	4E0407151G	ARM269	31121141717	ARM289	31126777940
ARM245	4E0407151L	ARM270	31121093450	ARM290	33306772242
ARM246	50513442	ARM270	31121094234	ARM290	33326758142
ARM247	50513444	ARM271	31121093449	ARM290	33326767760
ARM248	33326851563	ARM271	31121094233	ARM290	33326770776
ARM248	33326870773	ARM272	33321094210	ARM290	33326774794
ARM249	31126763700	ARM272	33326767832	ARM291	33306772241
ARM249	31126769794	ARM273	33321094209	ARM291	33326758141
ARM249	31126770850	ARM273	33326767831	ARM291	33326767759
ARM250	31126763699	ARM274	31121094466	ARM291	33326769971
ARM250	31126769793	ARM274	31126751318	ARM291	33326770775
ARM250	31126770849	ARM274	31126752318	ARM291	33326774793
ARM251	31124036270	ARM274	31126752718	ARM292	33321096797
ARM251	31126763704	ARM274	31126758520	ARM292	33322282065
ARM251	31126763708	ARM275	31121094466	ARM292	33326774795
ARM251	31126769798	ARM276	31121094466	ARM292	33326777424



MAGNETI MARELLI	O.E.	MAGNETI MARELLI	O.E.	MAGNETI MARELLI	O.E.
ARM293	33306773942	ARM314	33321091620	ARM329	33326770970
ARM293	33326759158	ARM314	33326770749	ARM330	33326770969
ARM293	33326767754	ARM315	31121096170	ARM331	31126773950
ARM293	33326767968	ARM315	31126769718	ARM332	31126773949
ARM293	33326768790	ARM316	31121096169	ARM333	31126771894
ARM293	33326770840	ARM316	31126769717	ARM334	31126771893
ARM293	33326774842	ARM317	31121096316	ARM335	31126776418
ARM294	33306773941	ARM317	31126760276	ARM336	31126776417
ARM294	33326759157	ARM318	31121096315	ARM337	33326786981
ARM294	33326767753	ARM318	31126760275	ARM338	33326786978
ARM294	33326767967	ARM319	33321095412	ARM339	33326788550
ARM294	33326768789	ARM319	33326768274	ARM340	33326788549
ARM294	33326770839	ARM319	33326770748	ARM341	31126787670
ARM294	33326774841	ARM319	33326770860	ARM342	31126787669
ARM295	31104026720	ARM320	33321095411	ARM343	31106787674
ARM295	31126765996	ARM320	33326768274	ARM344	31106787673
ARM295	31126774826	ARM320	33326770747	ARM345	33326792541
ARM296	31104026719	ARM320	33326770859	ARM346	31126794204
ARM296	31126765995	ARM321	33321095414	ARM346	31126850782
ARM296	31126774825	ARM321	33326774796	ARM347	31126794203
ARM297	31126760182	ARM321	33326788269	ARM347	31126850781
ARM298	31126760181	ARM322	33303411651	ARM348	31126775960
ARM299	31121141722	ARM322	33326760675	ARM349	31126775959
ARM299	31121141724	ARM322	33326770813	ARM350	31126775967
ARM300	31121141721	ARM323	31103415028	ARM351	31126775972
ARM300	31121141723	ARM323	31103426434	ARM352	31126775971
ARM301	33321090745	ARM324	31103415027	ARM353	33326775902
ARM301	33321097264	ARM324	31103426433	ARM354	31126775964
ARM302	31121142088	ARM324	31103451881	ARM354	31126798108
ARM303	31121142087	ARM325	31103412138	ARM354	31126850782
ARM304	33321090906	ARM325	31103443128	ARM355	31126775963
ARM305	33321090905	ARM326	31103412137	ARM355	31126798107
ARM306	31121141962	ARM326	31103443127	ARM355	31126850781
ARM307	31121141961	ARM327	33324046918	ARM356	33326782132
ARM308	31121092610	ARM327	33326770964	ARM357	33326782131
ARM309	31121092609	ARM327	33326779388	ARM358	33306786991
ARM310	33326775084	ARM327	33326795048	ARM359	33326774476
ARM311	33326775083	ARM328	33324046917	ARM360	31122405863
ARM312	31126864822	ARM328	33326770963	ARM360	31126768989
ARM313	31126864821	ARM328	33326779387	ARM361	31106770690
ARM314	33321090030	ARM328	33326795047	ARM361	31122347982



MAGNETI MARELLI	O.E.	MAGNETI MARELLI	O.E.	MAGNETI MARELLI	O.E.
ARM361	31126774828	ARM390	C96819162	ARM419	9805607380
ARM362	31106770689	ARM391	C96819161	ARM420	3521.H6
ARM362	31122347981	ARM392	92236898	ARM420	3521.L1
ARM362	31126774827	ARM393	92236899	ARM420	3521.N1
ARM363	96389492	ARM394	20951301	ARM420	3521.N2
ARM364	96389491	ARM395	20951300	ARM421	3520.L4
ARM365	96970076	ARM396	95319216	ARM421	3520.N1
ARM366	96970077	ARM396	95952783	ARM421	3520.P1
ARM367	13334023	ARM397	95319215	ARM421	3520.R6
ARM367	C13272606	ARM397	95952782	ARM421	3520.V1
ARM368	13334022	ARM398	25997510	ARM422	3521.S9
ARM368	C13272605	ARM399	25997509	ARM423	3520.W7
ARM369	15293664	ARM400	25786775	ARM424	3521.G3
ARM369	22947663	ARM401	25786774	ARM424	3521.K0
ARM370	15293665	ARM402	15148024	ARM425	3520.K3
ARM370	22947664	ARM403	23461856	ARM425	3520.P0
ARM371	96535082	ARM404	20774419	ARM426	3521.S5
ARM371	96870466	ARM405	25995438	ARM427	3520.W2
ARM372	96535081	ARM406	3521P4	ARM428	3521.T7
ARM372	96870465	ARM407	3520P4	ARM429	3520.X6
ARM373	25878028	ARM408	9675028880	ARM430	5175.CE
ARM374	25878029	ARM409	9675031880	ARM431	5175.CC
ARM375	22678193	ARM410	95658884	ARM432	5175.CH
ARM376	20945780	ARM410	3521.A6	ARM432	5175.CP
ARM377	20945779	ARM411	95658885	ARM433	5175.CG
ARM378	95017036	ARM411	3520.A3	ARM433	5175.CN
ARM379	95017035	ARM412	95658883	ARM434	4766542
ARM380	96391851	ARM412	95668511	ARM435	4766543
ARM380	96415064	ARM412	3521.C4	ARM436	4743834AB
ARM381	96391850	ARM413	95658882	ARM437	4743835AB
ARM381	96415063	ARM413	3520.A2	ARM438	04766910AL
ARM382	96436598	ARM413	3520.F5	ARM439	04766911AL
ARM383	96436597	ARM414	3521.F3	ARM440	5085408AK
ARM384	22854826	ARM414	3521.L4	ARM441	5085407AK
ARM385	22854825	ARM414	3521.R4	ARM442	05180606AA
ARM386	15292910	ARM415	3520.Q4	ARM442	05180606AB
ARM386	22730776	ARM415	3520.J3	ARM442	782612AC
ARM387	15292911	ARM415	3520.Q3	ARM442	DA782612AC
ARM387	22730775	ARM416	3521.81	ARM443	05180607AA
ARM388	96423324	ARM417	3520.C1	ARM443	782613AC
ARM389	96422220	ARM418	9805607380	ARM443	DA782613AC



MAGNETI MARELLI	O.E.	MAGNETI MARELLI	O.E.	MAGNETI MARELLI	O.E.
ARM444	10946	ARM463	68022600AD	ARM484	51961341
ARM444	4616922	ARM464	5168159AA	ARM485	7750978
ARM444	4764501AC	ARM464	5168159AB	ARM485	46402682
ARM444	K7427	ARM464	68022601AD	ARM485	46430003
ARM445	10945	ARM465	04782666AE	ARM486	7750977
ARM445	4616923	ARM465	68045130AE	ARM486	46402681
ARM445	4764500AC	ARM466	04782665AE	ARM486	46430002
ARM445	K7425	ARM466	68045131AE	ARM487	60813014
ARM446	6001547519	ARM467	05290828AB	ARM487	60813044
ARM446	8200216376	ARM468	05290829AB	ARM488	60813013
ARM446	545004269R	ARM469	68079723AB	ARM488	60813043
ARM447	6001547520	ARM470	51890709	ARM489	46539279
ARM447	8200216376	ARM470	51905058	ARM489	46546777
ARM447	545011362R	ARM470	51956709	ARM490	46546278
ARM448	545001535R	ARM471	51890706	ARM490	46546776
ARM448	545006542R	ARM471	51905057	ARM491	1331940080
ARM449	545016746R	ARM471	51956712	ARM491	3521.H2
ARM449	545019969R	ARM472	7543760	ARM491	3521.J3
ARM450	8200841004	ARM472	7591277	ARM492	1331938080
ARM450	551119305R	ARM472	7674825	ARM492	3520.L0
ARM451	8200839107	ARM473	51849600	ARM492	3520.N3
ARM451	551107894R	ARM473	51928537	ARM493	1339460080
ARM452	8200839124	ARM473	51957400	ARM493	3521.H3
ARM453	8200839119	ARM474	51849602	ARM493	3521.J4
ARM454	04670508AD	ARM474	51928536	ARM494	1331937080
ARM455	04670509AD	ARM474	51957401	ARM494	3520.L1
ARM456	05168652AC	ARM475	1540724	ARM494	3520.N4
ARM457	05168653AC	ARM475	50709580	ARM495	1497407080*
ARM458	05168389AA	ARM475	50710621	ARM496	1497408080*
ARM458	05168389AB	ARM475	9S513078BC	ARM497	500379802
ARM459	04782561AA	ARM476	1540725	ARM498	500379801
ARM459	04782561AB	ARM476	50709579	ARM499	6570gr
ARM459	04782561AC	ARM476	50710620	ARM501	2L5Z3083AA
ARM459	04782561AD	ARM476	9S513078AC	ARM502	AE5Z5500A
ARM459	04782561AE	ARM477	51885660	ARM502	G26A28C10
ARM459	04782561AF	ARM478	51885737	ARM503	AE5Z3084A
ARM460	52124840AB	ARM479	51939751	ARM504	AE5Z3085A
ARM461	68217808AA	ARM480	51939755	ARM505	AE5Z3078A
ARM462	68217809AA	ARM481	52011612	ARM506	8T4Z3078A
ARM463	5168158AA	ARM482	52011614	ARM507	8T4Z3079A
ARM463	5168158AB	ARM483	51959820	ARM508	7T4Z5500A



MAGNETI MARELLI	O.E.	MAGNETI MARELLI	O.E.	MAGNETI MARELLI	O.E.
ARM509	7E5Z3078L	ARM523	97KB3042BD	ARM536	31277675
ARM509	BE5Z3078B	ARM523	97KB3042DB	ARM536	2463500053
ARM509	GJ6A34J00B	ARM523	97KB3042FB	ARM536	98AG5K743AF
ARM509	GJ6A34J00C	ARM523	97KB3486GA	ARM536	BV615K743AA
ARM509	GJ6A34J00D	ARM524	1032102	ARM536	CV6Z5500L
ARM510	7E5Z3079L	ARM524	97KB3051DB	ARM537	1064128
ARM510	BE5Z3079B	ARM524	97KB3051FB	ARM537	1357017
ARM510	GJ6A34J50B	ARM525	1063987	ARM537	30666105
ARM510	GJ6A34J50C	ARM525	97KB3042BD	ARM537	4M515K652AD
ARM510	GJ6A34J50D	ARM526	1063988	ARM537	98AG5K652AK
ARM511	1737309	ARM526	97KB3051FB	ARM538	1071214
ARM511	8V513042BD	ARM527	1028438	ARM538	1090730
ARM511	8V513042BH	ARM527	1063985	ARM538	98AG3042AK
ARM511	BE8Z3078A	ARM527	97KB3042AC	ARM539	1073215
ARM511	D65134300B	ARM528	1028443	ARM539	1090738
ARM512	1737305	ARM528	1063986	ARM539	98AG3051AK
ARM512	8V513051BD	ARM528	97KB3051AC	ARM540	1254310
ARM512	8V513051BH	ARM529	9E5Z5500A	ARM540	1305341
ARM512	BE8Z3079A	ARM529	G26A28500A	ARM540	1309148
ARM512	D65134350B	ARM529	G26A28500B	ARM540	1309644
ARM513	1146130	ARM529	G26A28500D	ARM540	1328670
ARM513	1212807	ARM529	G62A28500B	ARM540	1332074
ARM513	1436097	ARM529	GJ6A28500D	ARM540	1348191
ARM513	DD3234300	ARM529	GK2A28500	ARM541	1254311
ARM514	1146131	ARM530	1639575	ARM541	1305342
ARM514	1212808	ARM530	9S513078BC	ARM541	1309149
ARM514	1436095	ARM531	1639574	ARM541	1309645
ARM514	DD3234350	ARM531	9S513078AC	ARM541	1328671
ARM515	Y125613042AH	ARM532	DG9C5500BXA	ARM541	1332075
ARM516	Y125613051AH	ARM533	8S4Z3078A	ARM541	1348192
ARM517	1058326	ARM534	8S4Z3079A	ARM542	1686184
ARM518	1058332	ARM535	1061660	ARM542	1752736
ARM519	1071690	ARM535	1317609	ARM542	AV615500CB
ARM519	98FB3042BC	ARM535	1329730	ARM542	AV6Z5500B
ARM519	98FB3042BD	ARM535	1M515500AB	ARM543	1420859
ARM520	1071702	ARM535	1M515500AC	ARM543	31201180
ARM520	98FB3051BC	ARM535	98AG5500AG	ARM543	31262037
ARM520	98FB3051BD	ARM535	YS4Z5500AA	ARM543	31277462
ARM521	1032098	ARM536	1061668	ARM543	4M513A423AD
ARM522	1032101	ARM536	1703145	ARM543	4M513A423AF
ARM523	1032100	ARM536	1753556	ARM544	1420858



MAGNETI MARELLI	O.E.	MAGNETI MARELLI	O.E.	MAGNETI MARELLI	O.E.
ARM544	30714442	ARM563	1793237	ARM583	BK213A053AE
ARM544	31262039	ARM563	CV613A424AAC	ARM584	1377449
ARM544	31277463	ARM563	CV6Z3078C	ARM584	1381843
ARM544	4M513A424AD	ARM564	1927131	ARM584	6G915K743XAD
ARM544	4M513A424AF	ARM564	FG9C3A052ANB	ARM585	1220005
ARM545	BV615K652AE	ARM564	GS7Z3079A	ARM585	1230619
ARM546	1749993	ARM565	1927132	ARM585	1S715K743CA
ARM546	AV613A423MA	ARM565	FG9C3A053ANB	ARM586	1214290
ARM546	AV613A423PA	ARM565	GS7Z3078A	ARM586	1S715K652CA
ARM547	1749992	ARM566	DG9Z5500A	ARM587	1203923
ARM547	AV613A424MA	ARM567	BV6Z3078F	ARM587	1311416
ARM547	AV613A424PA	ARM568	BV6Z3079F	ARM587	1S713042AH
ARM548	1719019	ARM569	BV6Z5500D	ARM587	1S713042AK
ARM548	BV615K652ED	ARM570	F1FZ3078A	ARM587	1S713042AM
ARM549	1702970	ARM571	F1FZ3079A	ARM587	1S713042AN
ARM549	8V613A423AAB	ARM572	DV613A423AF	ARM587	1S713042AP
ARM549	8V613A423AAC	ARM573	1933100	ARM588	1203924
ARM550	1702983	ARM573	DV613A424AF	ARM588	1311417
ARM550	BV613A424AAB	ARM574	4042022	ARM588	1S713051AH
ARM550	BV613A424AAC	ARM574	4540774	ARM588	1S713051AK
ARM551	1751952	ARM574	01YC153A052	ARM588	1S713051AM
ARM551	1834054	ARM575	4042023	ARM588	1S713051AN
ARM552	1751955	ARM575	4540775	ARM588	1S713051AP
ARM552	1834055	ARM575	01YC153A053	ARM589	1117859
ARM553	6L1Z3078AA	ARM576	6C113A052BD	ARM589	1118921
ARM554	6L1Z3079AA	ARM577	6C113A053BD	ARM589	1S715K743AB
ARM555	GB5Z3078C	ARM578	1828699	ARM589	1S715K743AC
ARM556	GB5Z3079A	ARM578	BK313A052AD	ARM590	1117857
ARM557	1502729	ARM579	1828700	ARM590	1118920
ARM557	8V415K652AA	ARM579	BK313A053AD	ARM590	1S715K652AB
ARM558	1502440	ARM580	1332454	ARM590	1S715K652AC
ARM558	8V415500AA	ARM580	4366973	ARM591	1124242
ARM559	1723323	ARM580	4371925	ARM591	1206474
ARM559	8V413A423AC	ARM580	W12T1043042BG	ARM592	1S713042AL/AM/AK
ARM560	1723324	ARM581	1332455	ARM593	1S713051AL/AM/AK
ARM560	8V413A424AC	ARM581	4366974	ARM594	1457609
ARM561	1500111	ARM581	4371926	ARM594	6G915500BAA
ARM561	8V415K743AA	ARM581	2T143051BG	ARM595	1469125
ARM562	1793236	ARM582	1831354	ARM595	6G915K652XAE
ARM562	CV613A423AAC	ARM582	BK213A052AE	ARM596	1469024
ARM562	CV6Z3079F	ARM583	1831355	ARM596	1507181



MAGNETI MARELLI	O.E.	MAGNETI MARELLI	O.E.	MAGNETI MARELLI	O.E.
ARM596	31277344	ARM625	52089980A	ARM652	2103309107
ARM596	31317662	ARM626	52089981A	ARM653	2103303407
ARM596	7G9N3A052BA	ARM627	52088636AD	ARM653	2103306107
ARM597	1469026	ARM628	52088637AD	ARM653	2103307607
ARM597	1507182	ARM629	5105040AD	ARM653	2103309007
ARM597	30760720	ARM629	5105040AH	ARM654	2023304907
ARM597	31200448	ARM630	5105041AC	ARM654	2083301407
ARM597	31277343	ARM630	5105041AH	ARM654	2103305107
ARM597	7G9N3A053BA	ARM631	5452030	ARM654	2103308807
ARM598	1782008	ARM631	54520-3E000	ARM655	2083301307
ARM598	CV615K652AAA	ARM632	5451030	ARM655	2103304807
ARM598	CV6Z5500J	ARM632	54510-3E000	ARM655	2103308707
ARM599	545012Y000	ARM633	545012P000	ARM655	2103505007
ARM599	545012Y002	ARM634	545002P000	ARM656	4153300200
ARM600	545002Y000	ARM635	OK30B34300B	ARM656	A4153300200
ARM600	545002Y002	ARM636	5450107100	ARM657	4153300300
ARM601	551002S000	ARM637	5450007100	ARM657	A4153300300
ARM601	551002S050	ARM638	545011Y000	ARM658	2123302811
ARM602	55220-2E010	ARM639	545001Y000	ARM659	2123302711
ARM603	54501-1E100	ARM640	545011F000	ARM660	2123303011
ARM604	54500-1E100	ARM640	54501-2E010	ARM661	2123302911
ARM605	545011J500	ARM640	54501-2E030	ARM662	2123301911
ARM606	545001J500	ARM641	545001F000	ARM663	2043308011
ARM607	545012H000	ARM641	54500-2E010	ARM664	2043308211
ARM608	545002H000	ARM641	54500-2E030	ARM665	2043308111
ARM609	54501A6200	ARM642	54501A2600	ARM666	2013500653
ARM610	54500A6200	ARM643	54500A2600	ARM666	2013502753
ARM611	545010X000	ARM644	545011W000	ARM666	2013503153
ARM612	545000X000	ARM645	545001W000	ARM666	2013503253
ARM613	551003Z000	ARM646	545011P100	ARM666	2103500653
ARM614	545013Z000	ARM647	545001P100	ARM667	1243507706
ARM615	545003Z000	ARM648	545012K600	ARM667	2103501706
ARM616	54501C8000	ARM649	545002K600	ARM668	1243507706*
ARM617	54500C8000	ARM650	545012K200	ARM669	1243507606
ARM618	55100A6005	ARM650	545012K500	ARM669	2103501606
ARM619	5450226000	ARM651	545002K200	ARM670	1243507606*
ARM620	5450126000	ARM651	545002K500	ARM671	2013504706
ARM621	545012B100	ARM652	2103303507	ARM671	2013505606
ARM622	545002B100	ARM652	2103304507	ARM672	1243500129
ARM623	545012W200	ARM652	2103306207	ARM672	2103500029
ARM624	545002W200	ARM652	2103307707	ARM673	1243500129*



MAGNETI MARELLI	O.E.	MAGNETI MARELLI	O.E.	MAGNETI MARELLI	O.E.
ARM674	1683300907	ARM696	6393301401	ARM715	2043500653
ARM674	1683302407	ARM697	6393300510	ARM716	2043500553
ARM675	1683300807	ARM698	6393300410	ARM717	2043500029
ARM675	1683302307	ARM699	4143300407	ARM717	2043502706
ARM676	1693300607	ARM699	4143300607	ARM717	2053506303
ARM676	1693301007	ARM700	4143300307	ARM717	A2053506303
ARM677	1693300507	ARM700	4143300507	ARM718	2043308811
ARM677	1693300907	ARM701	9013301907	ARM719	2043308711
ARM678	2043304411	ARM701	9013302507	ARM720	2053305801
ARM679	2043304311	ARM701	2D0407022	ARM721	1633330101
ARM680	2463500053	ARM702	9013301807	ARM722	1633330001
ARM680	A2463500053	ARM702	9013302407	ARM723	1633520501
ARM681	2463501006	ARM702	2D0407021	ARM724	1633520401
ARM681	A2463501006	ARM703	9063304107	ARM725	1633500153
ARM682	2463301807	ARM703	2E0407152M	ARM725	1633500453
ARM682	2463304800	ARM704	9063304007	ARM725	1633500653
ARM683	2463301707	ARM704	2E0407151M	ARM726	1633500053
ARM683	2463304700	ARM705	2033301911	ARM726	1633500353
ARM684	6383300110	ARM705	2033303311	ARM726	1633500553
ARM685	6383300010	ARM706	2033302011	ARM727	1643301807
ARM686	4473301507	ARM706	2033303411	ARM727	1643302607
ARM686	A4473301507	ARM707	2033300211	ARM727	1643303007
ARM687	4473301407	ARM707	2033301711	ARM727	1643303507
ARM687	A4473301407	ARM707	2033303611	ARM728	1643301707
ARM688	1663500306	ARM707	2033304011	ARM728	1643302507
ARM688	A1663500306	ARM707	2043304411	ARM728	1643302907
ARM689	1663301807	ARM708	2033300111	ARM728	1643303407
ARM689	A1663301807	ARM708	2033301611	ARM729	1643500053
ARM690	1663301707	ARM708	2033303511	ARM729	1663500053
ARM690	A1663301707	ARM708	2033303911	ARM730	1643501606
ARM691	1663300207	ARM708	2043304311	ARM731	1643501306
ARM691	A1663300207	ARM709	2043303211	ARM732	1643501406
ARM692	1663300107	ARM709	2043306811	ARM733	2513300807
ARM692	A1663300107	ARM710	2043303111	ARM734	2513300707
ARM693	1663500206	ARM710	2043306711	ARM735	2513302007
ARM693	A1663500206	ARM711	2043501606	ARM735	A2513302007
ARM694	1663500106	ARM711	2043503106	ARM736	2513301907
ARM694	A1663500106	ARM712	2043501506	ARM736	A2513301907
ARM695	6393301301	ARM712	2043503006	ARM737	2203500453
ARM695	6393301501	ARM713	2043502206	ARM737	2203520003
ARM696	6393301201	ARM714	2043502106	ARM738	2203502206



MAGNETI MARELLI	O.E.	MAGNETI MARELLI	O.E.	MAGNETI MARELLI	O.E.
ARM738	2203521105	ARM752	2113306707	ARM776	A2213501006
ARM739	2203502406	ARM752	2113308907	ARM777	2213500206
ARM739	A2203521005	ARM753	2303500429	ARM777	A2213500206
ARM740	2203502606	ARM754	2303500329	ARM778	2213500606
ARM740	A2203520502	ARM755	2303502006	ARM778	A2213500606
ARM741	2203301711	ARM756	2303503606	ARM779	2213500406
ARM741	2203304311	ARM757	2303503506	ARM779	2233500132
ARM741	2203305711	ARM758	2303502806	ARM779	A2213500406
ARM741	2203330405	ARM759	2303502706	ARM780	2463500506
ARM742	2203301811	ARM760	2213300241	ARM780	A2463500506
ARM742	2203304411	ARM760	2213306411	ARM781	2463500406
ARM742	2203305811	ARM761	2213302311	ARM781	A2463500406
ARM742	2203330505	ARM761	2213306311	ARM782	2213308807
ARM743	2203307707	ARM762	2213306807	ARM783	2213308707
ARM743	2203308907	ARM762	2213308207	ARM784	1563300200
ARM744	2203307807	ARM763	2213306707	ARM784	1563300600
ARM744	2203309007	ARM763	2213308107	ARM784	A1563300200
ARM745	2113301111	ARM764	2213303811	ARM785	1563300100
ARM745	2113301511	ARM764	2213306611	ARM785	1563300500
ARM745	2113302911	ARM765	2213303711	ARM785	A1563300100
ARM745	2113304311	ARM765	2213306511	ARM786	2053305601
ARM745	2303301711	ARM766	2213300407	ARM786	A2053305601
ARM746	2113301211	ARM766	2213309007	ARM787	2053305501
ARM746	2113301611	ARM767	2213300307	ARM787	A2053305501
ARM746	2113303011	ARM767	2213308907	ARM788	2053301405
ARM746	2113304411	ARM768	2213307807	ARM788	2053301605
ARM746	2303301811	ARM769	2213307707	ARM789	2053301305
ARM747	2113308107	ARM770	2213306807	ARM789	2053301505
ARM747	2113309107	ARM770	2213307207	ARM790	2053306001
ARM748	2113308207	ARM770	2213308207	ARM790	A2053306001
ARM748	2113309207	ARM771	2213306707	ARM791	2053305901
ARM749	2203301507	ARM771	2213307107	ARM791	A2053305901
ARM749	2203308407	ARM772	2213500806	ARM792	2153300307
ARM749	2203309407	ARM772	A2213500806	ARM792	2153300706
ARM750	2203301407	ARM773	2213500706	ARM792	2153300707
ARM750	2203308307	ARM773	A2213500706	ARM793	B32H34300A
ARM750	2203309307	ARM774	2213501253	ARM793	B32H34300C
ARM751	2113304407	ARM774	A2213501253	ARM793	B32H34300D
ARM751	2113306807	ARM775	2213501153	ARM793	BP4K34300B
ARM751	2113309007	ARM775	A2213501153	ARM793	BP4K34300E
ARM752	2113304307	ARM776	2213501006	ARM793	C51334300



MAGNETI MARELLI	O.E.	MAGNETI MARELLI	O.E.	MAGNETI MARELLI	O.E.
ARM794	B32H34350	ARM810	GS1D34200A	ARM825	4543302607
ARM794	B32H34350A	ARM810	GS1D34200C	ARM825	4013A150
ARM794	B32H34350C	ARM811	GS1D34250A	ARM825	MN186217
ARM794	B32H34350D	ARM811	GS1D34250C	ARM826	4543300807
ARM794	BP4K34350E	ARM812	G46C34300	ARM826	4543301907
ARM794	C51334350	ARM812	GHP934300C	ARM826	4013A135
ARM795	BBM234300	ARM812	GHP934300D	ARM826	MN186218
ARM795	BBM234300A	ARM812	KD5334300D	ARM827	MR911569
ARM796	BBM234350	ARM812	KD5334300E	ARM827	MR916134
ARM796	BBM234350A	ARM812	KD5334300F	ARM828	MR911570
ARM797	BJS728C10	ARM812	KD5334300G	ARM828	MR916133
ARM798	B45A28200	ARM813	G46C34350	ARM829	31126761410***
ARM799	B45A28250	ARM813	GHP934350C	ARM830	31126761409
ARM800	B45A34300	ARM813	GHP934350D	ARM831	31126772302*
ARM800	B60P34300	ARM813	KD3534350D	ARM832	31126772301*
ARM800	B60S34300	ARM813	KD3534350F	ARM833	31129806520
ARM800	BPN734300A	ARM813	KD3534350G	ARM834	31129806519
ARM801	B45A34350	ARM814	TD1134300E	ARM835	545000M010
ARM801	B60P34350	ARM815	TE6934350C	ARM835	545000M020
ARM801	B60S34350	ARM816	MR403420	ARM835	545000M060
ARM801	BPN734300A	ARM817	MR403419	ARM835	545004B000
ARM802	EH4434300	ARM818	4117A007	ARM836	545010M010
ARM803	EH4434350	ARM818	MR491911	ARM836	545010M020
ARM804	G6JA34J00C	ARM819	4110A085	ARM836	545010M060
ARM804	GJ6A34200B	ARM820	1606293080	ARM837	545242F010
ARM804	GP9A34200C	ARM820	4113A011	ARM837	545242J001
ARM805	6J6A34250B	ARM821	4013A010	ARM837	5452450J00
ARM805	G6JA34J050	ARM821	4013A282	ARM837	5452486J10
ARM805	GP9A34250C	ARM821	4013A428	ARM838	545252F010
ARM806	GJ6A34300B	ARM822	4013A009	ARM838	545252J001
ARM806	GJ6A34300C	ARM822	4013A281	ARM838	5452550J00
ARM806	GJ6A34300D	ARM822	4013A427	ARM838	5452586J10
ARM807	G26A28C10	ARM823	4010A038	ARM839	545002F500
ARM808	GS1D34300G	ARM823	4010A042	ARM839	545009F000
ARM808	GS1D34300H	ARM823	4010A140	ARM840	545012F500
ARM808	GS1D34300J	ARM823	MR496794	ARM840	545019F000
ARM808	GS1D34300L	ARM824	4010A037	ARM841	54500AV600
ARM809	GS1D34350G	ARM824	4010A041	ARM841	54500AV606
ARM809	GS1D34350H	ARM824	4010A139	ARM841	54500AV60A
ARM809	GS1D34350J	ARM824	MR496793	ARM842	54501AV600
ARM809	GS1D34350L	ARM825	4543300707	ARM842	54501AV606



MAGNETI MARELLI	O.E.	MAGNETI MARELLI	O.E.	MAGNETI MARELLI	O.E.
ARM842	54501AV60A	ARM870	352003	ARM890	352115
ARM843	54524AV600	ARM871	5352012	ARM890	352493
ARM844	54525AV600	ARM872	5352011	ARM890	13272606
ARM845	54500AX600	ARM873	352042	ARM890	13321339
ARM845	54500BC41A	ARM873	352063	ARM890	13334023
ARM846	54501AX600	ARM873	24428978	ARM891	352106
ARM846	54501BC41A	ARM874	352041	ARM891	352110
ARM847	545004F105	ARM874	352061	ARM891	352492
ARM848	545014F105	ARM874	24428977	ARM891	13272605
ARM849	545002U711	ARM875	5352028	ARM891	13321338
ARM849	545006F600	ARM875	93388569	ARM892	352510
ARM850	545012U711	ARM876	5352027	ARM892	352550
ARM850	545016F600	ARM876	93388568	ARM893	352509
ARM851	545001HA0C	ARM877	4705172	ARM893	352549
ARM851	545003VU0A	ARM877	96316765	ARM894	352071
ARM852	545011HA0C	ARM878	9214829	ARM894	352870
ARM852	545013VU0A	ARM879	9214832	ARM895	352050
ARM853	54500CC40A	ARM880	352543	ARM895	352869
ARM854	54501CC40A	ARM880	5352038	ARM896	39021473
ARM855	545000W000*	ARM880	55703231	ARM897	39021472
ARM856	545010W000*	ARM881	352542	ARM898	95658979
ARM857	54500EB300	ARM881	5352039	ARM898	3520.79
ARM858	54501EB300	ARM881	55703230	ARM899	95658978
ARM859	54524EB30A	ARM882	352522	ARM899	3520.78
ARM860	54525EB30A	ARM882	95025704	ARM900	3520.81
ARM861	545004M410	ARM883	352523	ARM900	3520.93
ARM862	545014M410	ARM883	95025705	ARM901	3520.80
ARM863	545001KA0B	ARM884	352524	ARM901	3520.92
ARM864	545011KA0B	ARM884	95025706	ARM902	3521.L3
ARM865	54500BB00A	ARM885	352004	ARM902	3521.N7
ARM865	54500JD000	ARM885	5352017	ARM902	480680H010
ARM865	54500JD00D	ARM885	90496040	ARM903	3520.Q2
ARM865	54500JG00B	ARM886	352005	ARM903	3520.R6
ARM866	54501JD000	ARM886	5352016	ARM903	480690H010
ARM866	54501JD00D	ARM886	90496039	ARM904	3521.C8
ARM866	54501JY00A	ARM887	352030	ARM904	3521.P8
ARM867	545004EA0A	ARM887	24454478	ARM905	3520.G8
ARM867	545004EA0B	ARM888	352029	ARM905	3520.L7
ARM868	545014EA0A	ARM888	24454477	ARM905	3520.S8
ARM868	545014EA0B	ARM889	423008	ARM905	3520.W0
ARM869	352002	ARM889	13105744	ARM906	3521.E7



MAGNETI MARELLI	O.E.	MAGNETI MARELLI	O.E.	MAGNETI MARELLI	O.E.
ARM907	3521.H9	ARM937	3520.Y0	ARM955	8200026654
ARM908	3520.H7	ARM938	545006069R	ARM955	8200273728
ARM909	3520.L7	ARM939	545019956R	ARM955	8200389134
ARM910	3521.J0	ARM940	8200346942	ARM956	4421646
ARM911	3520.L8	ARM940	8200615058	ARM956	91166641
ARM912	3521.N0	ARM940	8200744092	ARM956	8200054006
ARM912	3521.N8	ARM941	8200346941	ARM956	8200247900
ARM913	3520.Q9	ARM941	8200615057	ARM956	5450200QAB
ARM913	3520.R7	ARM941	8200744091	ARM957	4421647
ARM914	3521.J6	ARM942	4400048	ARM957	91166642
ARM914	3521.L2	ARM942	7700302119	ARM957	8200054003
ARM915	3520.N6	ARM942	7700309190	ARM957	8200247898
ARM915	3520.Q1	ARM942	8200767825	ARM957	5450300QA3
ARM916	3521.T8	ARM942	5450000QAD	ARM958	4417178
ARM917	3520.X7	ARM943	4404047	ARM958	93853465
ARM918	5178.47	ARM943	7700302118	ARM958	8200565079
ARM919	5175.CF	ARM943	7700309189	ARM958	5450200Q0C
ARM920	3521.J7	ARM943	8200767822	ARM959	4417177
ARM921	3520.N7	ARM943	5450100QAD	ARM959	93853464
ARM922	9670771480	ARM944	4418630	ARM959	8200565072
ARM923	9670772080	ARM944	93194855	ARM959	5450300Q0C
ARM924	3521.69	ARM944	8200750274	ARM960	545004055R
ARM924	3521.E5	ARM945	4418629	ARM960	545009207R
ARM925	3520.H3	ARM945	93194853	ARM961	545014055R
ARM925	3520.H5	ARM945	8200750273	ARM961	545016838R
ARM926	3521.G8	ARM946	4419216	ARM962	7700313945
ARM926	3521.K3	ARM946	8200688875	ARM962	7700425228
ARM926	3521.P3	ARM947	4419215	ARM962	8200197187
ARM927	3520.K8	ARM947	93197214	ARM963	7700313944
ARM927	3520.P3	ARM947	8200688871	ARM963	7700425227
ARM927	3520.S2	ARM948	545041327R	ARM963	8200197179
ARM928	3521.R3	ARM949	545055708R	ARM964	8200254166
ARM929	3520.V2	ARM950	8200298455	ARM964	5450000QAH
ARM930	9678311380	ARM950	8200679067	ARM965	8200254163
ARM931	9678311280	ARM951	8200298454	ARM965	5450100QAH
ARM932	9800596580	ARM951	8200679063	ARM966	8200586567
ARM933	9800596680	ARM952	8200255761	ARM967	8200586561
ARM934	9816865480	ARM953	8200255760	ARM968	8200942408
ARM935	9816865580	ARM954	8200026655	ARM969	8200942407
ARM936	3521.V1	ARM954	8200273729	ARM970	545046817R
ARM936	3521Y.0	ARM954	8200389135	ARM970	545048506R



MAGNETI MARELLI	O.E.	MAGNETI MARELLI	O.E.	MAGNETI MARELLI	O.E.
ARM971	545050510R	ARM995	71768151	SSP0019	32111093669/770 part of
ARM971	545055711R	ARM995	4520179J00		
ARM972	545004529R	ARM996	71742732	SSP0020	32211095950
ARM972	545007106R	ARM996	71768151	SSP0021	32216756368 part of
ARM973	545010294R	ARM996	4520279J00	SSP0022	32216762403*
ARM973	545011727R	ARM997	4806802130*	SSP0023	32106793496*
ARM974	7700820029	ARM997	4806812300*	SSP0023	32303418204*
ARM974	8200737126	ARM998	4806902130*	SSP0024	32106858735/737 part of
ARM975	7700820028	ARM998	4806912300*		
ARM975	8200737126	ARM999	4861060030	SSP0025	32106787472 part of
ARM976	8200942396	SSP0001	32211091913	SSP0026	32106784716
ARM977	8200942392	SSP0001	32211093433	SSP0027	93740701
ARM978	545000002R	SSP0001	32211096057	SSP0028	13278358*
ARM979	545010009R	SSP0002	1704630015	SSP0029	96535300
ARM979	545010012R	SSP0003	1J0422807	SSP0030	19149839
ARM980	545045297R	SSP0003	1J0422807A	SSP0031	19207056
ARM981	545057449R	SSP0004	4B0422821	SSP0032	19210063
ARM982	1K0501530C	SSP0004	4D0422821	SSP0033	1609213
ARM983	1K0501529F	SSP0005	1J0422821A	SSP0033	95952929
ARM984	6Q0407151D*	SSP0006	8J0423810	SSP0034	96061907
ARM984	6Q0407366A*	SSP0007	8N0422807A	SSP0035	1609181
ARM985	6Q0407151D*	SSP0008	4F0422821	SSP0035	13332651
ARM985	6Q0407365A*	SSP0009	4E0419821	SSP0036	1609183
ARM986	6R0407152**	SSP0010	4G0423810A	SSP0036	13332653
ARM987	6E0407151**	SSP0011	4H0422810	SSP0037	13354600
ARM988	1K0501529J	SSP0011	4H0422810A	SSP0038	93740621
ARM989	1K0407152BC*	SSP0012	8Z0423803/804F part of	SSP0038	C521564
ARM990	1K0407151BC*			SSP0039	88955489
ARM991	4520150G10	SSP0013	6C0423810A	SSP0040	22913277
ARM991	4520160B01	SSP0013	6C0423810B	SSP0041	4808602
ARM991	4520170C00	SSP0013	6C0423810C	SSP0041	4808603
ARM992	4520250G10	SSP0014	32106867404 part of	SSP0041	96626521
ARM992	4520260B01	SSP0014	32106867405 part of	SSP0041	96626525
ARM992	4520270C00	SSP0015	32216762243*	SSP0042	92227430
ARM993	4708299	SSP0015	32216762244*	SSP0043	93388624
ARM993	4520162J00	SSP0016	32106765235/236 part of	SSP0044	23868906
ARM993	4520163J00			SSP0045	95967294
ARM994	4708300	SSP0017	32106793621/622 part of	SSP0046	19178561
ARM994	4520262J00			SSP0047	20817752
ARM994	4520263J00	SSP0018	32106799965 part of	SSP0048	91175548
ARM995	71742731			SSP0049	3812.95*



MAGNETI MARELLI	O.E.	MAGNETI MARELLI	O.E.	MAGNETI MARELLI	O.E.
SSP0050	96048214	SSP0077	4048739	SSP0092	AV6C3L519BA
SSP0050	3812.C0	SSP0077	6790700	SSP0092	AV6C3L519BAN
SSP0050	3812.E4	SSP0077	XS5C3L519AA	SSP0093	DG9Z3280A
SSP0051	95069129	SSP0078	1250339	SSP0094	1370709
SSP0051	3812.A0	SSP0079	BB5Z3280A	SSP0094	4059923
SSP0052	3812.E9	SSP0080	1824228	SSP0094	4602028
SSP0053	1610817680	SSP0080	DG9C3D032BA	SSP0094	6C113L519AA
SSP0054	1608652180	SSP0081	9S4Z3280A	SSP0094	YC153L519AA
SSP0055	3812.C6	SSP0082	9S4Z3280B	SSP0094	YC153L519AB
SSP0055	3812.E4	SSP0083	1085520	SSP0095	1370710
SSP0056	96032460	SSP0083	3707333	SSP0095	4059924
SSP0056	3812.99	SSP0083	98AG3L519AA	SSP0095	4577976
SSP0057	3812.E1	SSP0083	YS4Z3280AA	SSP0095	6C113L519BA
SSP0058	3812.F6	SSP0084	1251937	SSP0095	YC153L519BA
SSP0059	3812.C8	SSP0084	1317453	SSP0095	YC153L519BB
SSP0060	3812.F3	SSP0084	1377655	SSP0096	1763991
SSP0061	68157856AA	SSP0084	30776283	SSP0096	BK213L519AA
SSP0062	68040225AA	SSP0084	3M513L519AA	SSP0097	3903147
SSP0063	68040223AE	SSP0084	3M513L519AB	SSP0097	7294416
SSP0064	68158379AA	SSP0084	4M513L519AB	SSP0097	1S713B438BB
SSP0065	6001547606	SSP0085	1754076	SSP0097	1S7C3280BB
SSP0066	8201108350	SSP0085	1836649	SSP0098	1433271
SSP0067	68105872AA	SSP0085	1899978	SSP0098	6G913280AB
SSP0067	68105872AB	SSP0085	BV613L519AA	SSP0099	577242S000
SSP0068	68158377AA	SSP0085	BV613L519AB	SSP0099	577242S100
SSP0069	68164072AB	SSP0085	BV613L519AC	SSP0100	577243J000
SSP0070	52014014 part of	SSP0086	1377655	SSP0101	545400U500
SSP0071	5960321	SSP0086	4M513L519AB	SSP0101	565400U500
SSP0071	SE141162449A	SSP0087	2L1Z3280GA	SSP0102	577244H100
SSP0072	1044014	SSP0088	9L3Z3280A	SSP0103	57724-2E000
SSP0072	1E0032240	SSP0089	FL3Z3280A	SSP0104	577241J000
SSP0072	B196FB3L519BA	SSP0089	FR3Z3280A	SSP0105	565402K000
SSP0073	7T4Z3280A	SSP0089	GR3Z3280C	SSP0105	565403J000*
SSP0074	AV6Z3280E	SSP0090	9R3Z3280B	SSP0106	565402H000
SSP0075	1545457	SSP0091	BR3Z3280A	SSP0107	56540A6000
SSP0075	8V513L519AA	SSP0091	BR3Z3280B	SSP0108	577240X000
SSP0076	4342539	SSP0092	1714484	SSP0109	577243Z000
SSP0076	4472940	SSP0092	1715414	SSP0110	56540C8000
SSP0076	2S6J3289AC	SSP0092	1780104	SSP0111	5771634000
SSP0076	DE9032240	SSP0092	31317779	SSP0111	5775517000
SSP0076	Y12S6C3280KB	SSP0092	AV6C3L519AA	SSP0111	5778526200



MAGNETI MARELLI	O.E.	MAGNETI MARELLI	O.E.	MAGNETI MARELLI	O.E.
SSP0112	577242B000	SSP0142	A2054600805	SSP0169	32106854736 part of
SSP0113	577242W000	SSP0143	1633380205	SSP0170	4852171
SSP0114	68066486AA	SSP0143	1633380215	SSP0170	4852172
SSP0115	57731-3E010	SSP0144	1644600005	SSP0170	4852106R05
SSP0116	57732-3E010	SSP0145	2203380715	SSP0170	48521-72E00
SSP0117	577242P100	SSP0145	2303380015	SSP0171	4852150Y00
SSP0118	577242P000	SSP0146	2213301603	SSP0171	4852160Y05
SSP0119	57724C5000	SSP0147	2043380515	SSP0172	49001BA210SK* part of
SSP0120	KDX5332240	SSP0148	2113302903	SSP0173	4852101B25
SSP0121	577241G100	SSP0148	2113380015	SSP0173	4852117B00
SSP0122	577241G000	SSP0148	A2113302903	SSP0174	48001AX602*
SSP0123	5772407100	SSP0149	D65132240	SSP0175	D85211HA0A
SSP0124	577241Y500	SSP0150	BP4L32240	SSP0176	48520CB025
SSP0125	2103380415	SSP0151	GHT232240A	SSP0176	48521CB027
SSP0126	1713380015	SSP0152	4550329795	SSP0177	D85211AA0A
SSP0127	2123302103	SSP0152	EG2132240	SSP0177	D8E211AA0A
SSP0128	2073300500	SSP0153	6E5Z3332B	SSP0178	485210W025
SSP0129	2123302803	SSP0153	GJ6E32240	SSP0179	48521EA000
SSP0129	A2123302803	SSP0154	GS1D32240	SSP0180	485214M527
SSP0130	1683301335	SSP0155	KD3132240	SSP0180	485214M528
SSP0131	1693300403	SSP0156	TD1132240A	SSP0180	485214M587
SSP0131	1693300703	SSP0157	4410A172	SSP0180	485214M588
SSP0132	2463380000	SSP0158	4422A056	SSP0181	485214U110
SSP0132	A2463380000	SSP0158	MR491358	SSP0182	D85211KA0A
SSP0133	6384600055	SSP0159	4422A058	SSP0183	D8521JG00A
SSP0134	4474600055	SSP0159	4422A076	SSP0184	1603018
SSP0134	A4474600055	SSP0160	3812.F1	SSP0184	1603843
SSP0135	1663380315	SSP0160	4422A012	SSP0185	322158
SSP0135	A1663380315	SSP0160	4422A057	SSP0186	322155
SSP0136	4143300035	SSP0161	MR510267	SSP0186	26030411
SSP0136	4144600205	SSP0162	4422A036	SSP0187	1603844
SSP0137	6394600055	SSP0163	MR448255	SSP0187	93192420
SSP0137	6394600255	SSP0164	4410A173	SSP0188	1603008
SSP0138	9014600155	SSP0165	3345797	SSP0188	1603845
SSP0138	9014600455	SSP0165	MB297969	SSP0188	26087867
SSP0139	9064600055	SSP0165	MR244901	SSP0188	93192421
SSP0139	2E0713491	SSP0166	MR403027	SSP0189	1603239
SSP0140	2043380015	SSP0167	32116754563*	SSP0189	1603428
SSP0141	2054600405	SSP0167	32116754564*	SSP0190	1603016
SSP0141	A2054600405	SSP0168	32106778548 part of	SSP0190	26110429
SSP0142	2054600805	SSP0169	32106854733 part of		



MAGNETI MARELLI	O.E.	MAGNETI MARELLI	O.E.	MAGNETI MARELLI	O.E.
SSP0191	4701745	SSP0210	3817.E3	SSP0239	7701478406
SSP0191	4883083	SSP0211	1608025380	SSP0239	485215612R
SSP0191	4883086G00	SSP0212	3812.E0	SSP0239	A4154600000
SSP0192	93196777	SSP0213	3812.E5	SSP0240	485211071R
SSP0193	1609011	SSP0214	3812.F2	SSP0241	485213172R
SSP0193	93196778	SSP0215	1611242380	SSP0242	7701467218
SSP0194	1609205	SSP0216	3812.C7	SSP0242	7701469517
SSP0194	95932789	SSP0217	3812.G3	SSP0243	7701467218
SSP0195	1603213	SSP0218	485212518R	SSP0243	7701469517
SSP0195	1603216	SSP0219	7701475841	SSP0244	485210001R
SSP0195	9118128	SSP0220	4501261	SSP0245	485216564R
SSP0196	1603264	SSP0220	7701470362	SSP0246	485212309R
SSP0196	1603358	SSP0220	4852100QAF	SSP0247	6Q0419803B
SSP0196	93181230	SSP0221	485212373R	SSP0247	6Q0419803D
SSP0196	93189669	SSP0222	7701474448	SSP0247	6Q0419803F
SSP0197	1603287	SSP0223	7701472766	SSP0247	6Q0419804B
SSP0197	1603642	SSP0224	7701472766	SSP0247	6Q0419804D
SSP0197	93186330	SSP0224	7701478551	SSP0247	6Q0419804F
SSP0198	1603244	SSP0225	4408474	SSP0248	6Q0423810C
SSP0198	1603384	SSP0225	7701473333	SSP0249	4709161
SSP0198	1603416	SSP0225	4852000QAM	SSP0249	4883063J00
SSP0198	12804238	SSP0226	7701474076	SSP0250	4550369025
SSP0198	46989683	SSP0226	7701478552	SSP0251	4550339235
SSP0199	1609027	SSP0227	7701471125	SSP0252	4550339075
SSP0199	13286687	SSP0228	7701472734	SSP0253	4550309321
SSP0200	1609029	SSP0229	7701473656	SSP0253	4550309331
SSP0200	13314465	SSP0230	7701473656*	SSP0254	4550352030
SSP0201	1609184	SSP0231	7701471124	SSP0255	4550352010
SSP0202	6606030	SSP0232	7701471144	SSP0256	4550352070 part of
SSP0202	13271996	SSP0232	7701473655	SSP0257	4550319215
SSP0203	13464344	SSP0233	7701470764	SSP0258	4550342020
SSP0204	1609187	SSP0234	7701470763	SSP0258	4550349165
SSP0205	4001.33	SSP0235	7701472113	SSP0259	4550349055
SSP0205	455000H010	SSP0235	4852100QAA	SSP0260	455030F010
SSP0206	96136394	SSP0236	7701472120	SSP0260	455030R010
SSP0206	3812.25	SSP0236	7701473655	SSP0261	4550309350
SSP0206	3812.95	SSP0236	4852100QAG	SSP0262	4550319130
SSP0207	3812.C5	SSP0237	7701472120*	SSP0262	4550319255
SSP0208	3812.E8	SSP0237	7701473655*	SSP0262	4550319256
SSP0209	3812.F4	SSP0238	7701472735	SSP0263	4550374010
SSP0210	3817.B3	SSP0239	4154600000	SSP0264	4551012390



MAGNETI MARELLI	O.E.	MAGNETI MARELLI	O.E.	MAGNETI MARELLI	O.E.
SSP0265	4550360030	SSP0288	8K0422818A	SSP0314	32211095958
SSP0266	4550360040	SSP0288	8K0422818B	SSP0315	32211095957
SSP0267	1160310016	SSP0289	8K0422817A	SSP0316	32106774361
SSP0267	7L0422821	SSP0289	8K0422817B	SSP0316	32106776946
SSP0268	561423810	SSP0290	8N0422812A	SSP0316	32216756369
SSP0269	1K0423810A	SSP0291	8N0422811A	SSP0317	32211141346
SSP0270	1S0423810A	SSP0292	4F0419811C	SSP0318	32211141345
SSP0271	7H0419803C*	SSP0292	4F0419811D	SSP0319	32106858738
SSP0271	7H0419804C*	SSP0292	4F0419811G	SSP0319	32106863860
SSP0272	7M0422803/4EF	SSP0292	8E0419811	SSP0320	32106858736
SSP0273	6N0422803A	SSP0293	4G0423812A	SSP0320	32106863858
SSP0274	6N0419803	SSP0294	4G0423811A	SSP0321	32211096327
SSP0275	6N0422803C/804C	SSP0295	8J0423812	SSP0322	32106774335
SSP0276	6R0423810	SSP0296	8J0423811	SSP0322	32216760354
SSP0276	8Z0419810C	SSP0297	8S0423812A	SSP0323	32106780984
SSP0277	274179	SSP0298	8S0423811A	SSP0323	32106793497
SSP0278	272428	SSP0299	4E0419811B	SSP0323	32216773739
SSP0279	274353	SSP0299	4E0419811C	SSP0324	32106792674
SSP0280	31280409	SSP0299	4E0419811D	SSP0325	32106784796
SSP0281	31280408	SSP0299	4E0419811E	SSP0326	32106784790
SSP0281	31451036	SSP0300	4H0422818A	SSP0327	32216767860
SSP0282	811419812A	SSP0301	4H0422817A	SSP0328	93740710
SSP0282	811419812B	SSP0302	32106854734	SSP0329	93740710
SSP0283	1J0422812B	SSP0302	32106867405	SSP0330	26086579
SSP0283	1J0422812R	SSP0303	32106854737	SSP0331	26086580
SSP0283	3A0422812B	SSP0303	32106867404	SSP0332	22776539
SSP0283	6Q0419812	SSP0304	32106765090	SSP0333	4011887
SSP0283	6R0423812A	SSP0304	32106767782	SSP0333	26100287
SSP0284	1J0422811B	SSP0305	32106765089	SSP0334	4011886
SSP0284	1J0422811R	SSP0305	32106767781	SSP0334	26100286
SSP0284	3A0422811B	SSP0306	32106769074	SSP0335	93740723
SSP0284	6Q0419811	SSP0306	32106793624	SSP0336	93740722
SSP0284	6R0423811A	SSP0307	32106769073	SSP0337	19149840
SSP0285	1J0422812A	SSP0307	32106793623	SSP0338	19210064
SSP0285	1J0422812L	SSP0308	32106799967	SSP0339	19207057
SSP0286	1J0422811A	SSP0309	32106799966	SSP0340	95952930
SSP0286	1J0422811L	SSP0310	32111091770	SSP0341	95218373
SSP0287	4B0419811E	SSP0311	32111091769	SSP0342	93740623
SSP0287	4D0419811A	SSP0312	32211091724	SSP0342	96407486
SSP0287	4D0419811B	SSP0313	32111093771	SSP0343	96407485
SSP0287	8E0419811B	SSP0313	32211091723	SSP0344	15944090



MAGNETI MARELLI	O.E.	MAGNETI MARELLI	O.E.	MAGNETI MARELLI	O.E.
SSP0345	13354598	SSP0374	3817.91	SSP0409	8V518C367AA
SSP0346	13354596	SSP0375	3817.92	SSP0409	BE8Z3A130
SSP0347	89047756	SSP0376	3817.54	SSP0410	1545339
SSP0348	96261379	SSP0377	3817.53	SSP0410	8V513C437AA
SSP0349	96261378	SSP0378	3817.81	SSP0410	BE823A131A
SSP0350	26095475	SSP0379	3817.80	SSP0411	1202548
SSP0350	ES80311	SSP0380	3817.97	SSP0411	DE9032280
SSP0351	88955488	SSP0381	68156146AA	SSP0411	Y1256J3289AC
SSP0352	22913275	SSP0382	68033171AB	SSP0412	1202549
SSP0353	22913276	SSP0383	5094006AA	SSP0412	DE9032290
SSP0354	4803429	SSP0384	5093857AA	SSP0412	Y1256J3290AC
SSP0354	96626667	SSP0385	5003930AA	SSP0413	1032689
SSP0354	C96626667	SSP0385	5086282AA	SSP0413	1034417
SSP0355	19208276	SSP0386	6001547611	SSP0414	BB5Z3A130B
SSP0356	92241266	SSP0386	6001550443	SSP0415	1802974
SSP0357	21011027	SSP0386	485200410R	SSP0415	DG9C3289CA
SSP0358	24510351	SSP0387	6001547610	SSP0416	1802977
SSP0359	24510351	SSP0387	6001550442	SSP0416	DG9C3290CA
SSP0360	95967285	SSP0387	485202867R	SSP0417	8S4Z3A130B
SSP0361	25956921	SSP0388	8201108332	SSP0418	8S4Z3A130A
SSP0362	26095458	SSP0389	8201108339	SSP0419	1074305
SSP0363	26057931	SSP0390	52125366AA	SSP0419	1107013
SSP0364	15254061	SSP0391	52125367AA	SSP0419	98AG3289AA
SSP0365	15869897	SSP0392	68069646AB	SSP0419	98AX3270AA
SSP0366	91174753	SSP0393	68069647AB	SSP0420	1074306
SSP0367	91174754	SSP0394	68156906AA	SSP0420	1107015
SSP0368	9471000665	SSP0395	68156905AA	SSP0420	98AG3290AA
SSP0368	9471007565	SSP0396	68156902AA	SSP0420	98AX3270BA
SSP0368	3817.16	SSP0397	68185502AB	SSP0420	YS4Z3A130AA
SSP0368	3817.31	SSP0398	68185503AB	SSP0421	274501
SSP0368	3817.42	SSP0399	77365815	SSP0421	1317447
SSP0369	9458084180	SSP0400	77366166	SSP0421	1328877
SSP0369	9471000565	SSP0401	77366165	SSP0421	30723104
SSP0369	9471007465	SSP0402	77366699	SSP0421	4M513289AB
SSP0369	3817.14	SSP0403	77366698	SSP0422	274500
SSP0369	3817.30	SSP0404	77367379	SSP0422	1317446
SSP0369	3817.41	SSP0405	AE5Z3A130B	SSP0422	1328881
SSP0370	3817.72	SSP0406	AE5Z3A130A	SSP0422	1388549
SSP0371	3817.71	SSP0407	7T4Z3A130A	SSP0422	30723103
SSP0372	3817.56	SSP0408	7T4Z3A130B	SSP0422	4M513290AB
SSP0373	3817.55	SSP0409	1545338	SSP0423	1714576

MAGNETI MARELLI	O.E.	MAGNETI MARELLI	O.E.	MAGNETI MARELLI	O.E.
SSP0423	1748237	SSP0439	30776249	SSP0466	52088466
SSP0423	1780102	SSP0439	31280001	SSP0466	52088870AA
SSP0423	1826501	SSP0439	6G913289AA	SSP0467	52088467
SSP0424	1714700	SSP0439	LR002610	SSP0467	52088869AA
SSP0424	1748239	SSP0440	568202S050	SSP0468	568203E900
SSP0424	1780103	SSP0440	568203Q500	SSP0469	56820-3E000
SSP0424	1826505	SSP0441	568202S000	SSP0470	56825C1090
SSP0424	BV6C3C437BA	SSP0441	568203Q000	SSP0471	56820C1000
SSP0424	BV6C3C437BB	SSP0442	5682028000	SSP0472	5682007000
SSP0424	BV6Z3A130E	SSP0442	MB912076	SSP0472	5682007200
SSP0425	2L3Z3A130CA	SSP0443	5682025000	SSP0472	MDX5032280
SSP0426	7L1Z3A130R	SSP0444	568204H100	SSP0473	568201G000
SSP0427	7L1Z3A130L	SSP0445	568204H000	SSP0474	568201G900
SSP0428	1541485	SSP0446	568200U590	SSP0475	5682007200
SSP0428	8V413C367AA	SSP0446	568201W090	SSP0476	568201Y550
SSP0429	1541488	SSP0447	568200U500	SSP0477	568201Y500
SSP0429	8V413C437AA	SSP0447	568201W000	SSP0478	568201Y551
SSP0430	DG9Z3A130A	SSP0448	568202E900	SSP0479	568201Y501
SSP0431	DG9Z3A130B	SSP0449	56820-2E000	SSP0480	13307435
SSP0432	FR3Z3A130A	SSP0450	568202K050	SSP0480	13307735
SSP0433	2T1Z3A130A	SSP0451	568202K000	SSP0481	2103380615
SSP0434	1370741	SSP0452	568202H090	SSP0482	2103380515
SSP0434	4047091	SSP0453	568202H000	SSP0483	2043303403
SSP0434	6C113289AA	SSP0454	568203X090	SSP0484	2043303303
SSP0434	YC153289AA	SSP0454	56820A6090	SSP0485	2043301003
SSP0435	4381840	SSP0455	568203X000	SSP0485	A2043301003
SSP0435	2T1Z3A130A	SSP0455	56820A6000	SSP0486	2043300903
SSP0435	W12T143289AA	SSP0456	568200X000	SSP0486	A2043300903
SSP0436	1763989	SSP0456	568200X900	SSP0487	2103381015
SSP0436	BK213289AA	SSP0457	568203V100	SSP0488	2103380915
SSP0437	1138314	SSP0458	568203V190	SSP0489	2123302203
SSP0437	1S713290AB	SSP0459	56820C8900	SSP0490	2123302303
SSP0437	1S713290BB	SSP0459	56820C9000	SSP0491	2123301403
SSP0437	1X433289AB	SSP0460	56820C8000	SSP0492	2123301303
SSP0437	C2S12013	SSP0461	568203B000	SSP0493	2043302003
SSP0438	1433273	SSP0462	568202B900	SSP0494	2043301903
SSP0438	30776248	SSP0462	568202P900	SSP0495	1683301235
SSP0438	31280001	SSP0463	568202B000	SSP0495	1683301635
SSP0438	6G913290AA	SSP0463	568202P000	SSP0496	1683301135
SSP0438	LR002609	SSP0464	568202W050	SSP0496	1683301535
SSP0439	1433274	SSP0465	568202W000	SSP0497	1693300603



MAGNETI MARELLI	O.E.	MAGNETI MARELLI	O.E.	MAGNETI MARELLI	O.E.
SSP0498	1693300503	SSP0524	1633300103	SSP0550	MB166426
SSP0499	2223300203	SSP0525	1643301203	SSP0550	MB527650
SSP0500	2223300103	SSP0526	1643301103	SSP0551	5682036000
SSP0501	2463301800	SSP0527	2513300803	SSP0551	MB192430
SSP0502	2463301700	SSP0528	2513300703	SSP0551	MB616286
SSP0503	2033303403	SSP0529	2203380115	SSP0551	MB912519
SSP0504	2033303303	SSP0529	2203380515	SSP0552	30870695
SSP0505	6384600048	SSP0529	2303300203	SSP0552	30875012
SSP0506	4474600148	SSP0529	2303300403	SSP0552	MB241982
SSP0506	A4474600148	SSP0529	2303380115	SSP0552	MB527169
SSP0507	4474600048	SSP0530	2113300203	SSP0552	MR535996
SSP0507	A4474600048	SSP0530	2113302403	SSP0553	1607502480
SSP0508	1663300403	SSP0531	2113300103	SSP0553	4422A002
SSP0508	A1663300403	SSP0531	2113302303	SSP0553	4422A052
SSP0509	4143330135	SSP0532	2213303903	SSP0554	4422A010
SSP0509	4144600105	SSP0533	2213302003	SSP0554	MR508136
SSP0510	4143330235	SSP0533	2213303403	SSP0555	4422A009
SSP0510	4144600005	SSP0534	2213301903	SSP0555	MR508135
SSP0511	6394600348	SSP0534	2213303303	SSP0556	4422A038
SSP0512	6394600048	SSP0535	D65132280	SSP0557	4422A037
SSP0513	2123302703	SSP0536	D65132290	SSP0558	4544600205
SSP0513	2124600205	SSP0537	BP4L32280	SSP0558	MR977606
SSP0514	2123302403	SSP0538	BP4L32290	SSP0559	MR485672
SSP0514	2124600105	SSP0539	GHT232280	SSP0560	32216754566
SSP0515	9014600148	SSP0540	GHT232290	SSP0561	32216754565
SSP0515	2D0422811	SSP0541	EG2132280	SSP0562	32116761560
SSP0516	9064600048	SSP0541	EG2132280A	SSP0563	32136761559
SSP0516	2E0713501	SSP0541	EG2132280B	SSP0564	32106778438
SSP0517	2033302003	SSP0542	EG2132290	SSP0565	32106778437
SSP0517	2033302403	SSP0542	EG2132290A	SSP0566	32109805552
SSP0518	2033301903	SSP0542	EG2132290B	SSP0567	32109805551
SSP0518	2033302303	SSP0543	GJ6E32280	SSP0568	32109808840
SSP0519	2054600105	SSP0543	GJ6E32280A	SSP0569	32109808839
SSP0519	A2054600105	SSP0544	GJ6E32290	SSP0570	485204F125
SSP0520	2054600005	SSP0544	GJ6E32290A	SSP0571	48520AX600
SSP0520	A2054600005	SSP0545	GS1D32280	SSP0572	48640AX600
SSP0521	2054600705	SSP0546	GS1D32290	SSP0573	D85201HA0A
SSP0521	A2054600705	SSP0547	KD3132280	SSP0574	D86401HA0A
SSP0522	2054600605	SSP0548	MR241032	SSP0575	D8520CB025
SSP0522	A2054600605	SSP0549	MR241031	SSP0576	D85201AA0A
SSP0523	1633300403	SSP0550	5687243010	SSP0576	D8520JA00A



	O.E.		O.E.		O.E.
SSP0577	D86401AA0A	SSP0597	4705716	SSP0612	3817.18
SSP0577	D8640JA00A	SSP0597	9204751	SSP0612	3817.50
SSP0578	485200P725	SSP0597	9210168	SSP0613	3817.64
SSP0578	485200W025	SSP0597	48810830	SSP0614	3817.63
SSP0578	485203S500	SSP0597	488108300	SSP0615	3817.61
SSP0578	485203S525	SSP0598	1609203	SSP0616	3817.62
SSP0579	48640EA01J	SSP0598	95914910	SSP0617	1608652380
SSP0580	48520EA01J	SSP0598	95932779	SSP0617	3817.68
SSP0581	482500M025	SSP0599	1609206	SSP0618	1608652280
SSP0582	48520BM425	SSP0600	1603214	SSP0618	3817.67
SSP0583	48520 95F0A	SSP0601	1603215	SSP0619	3817.57
SSP0584	4852015U26	SSP0602	1603257	SSP0620	3817.58
SSP0585	4852073J23	SSP0602	1603267	SSP0621	3817.66
SSP0585	4852073J25	SSP0602	1603288	SSP0622	3817.65
SSP0585	485209C000	SSP0602	1609012	SSP0623	1608025280
SSP0585	485209C025	SSP0602	93179558	SSP0624	1608025180
SSP0586	486571U61A	SSP0602	93181233	SSP0625	3817.75
SSP0586	D8520EW00A	SSP0602	93186332	SSP0625	3817.88
SSP0587	486471U61A	SSP0603	1603258	SSP0626	3817.76
SSP0587	D8640EW00A	SSP0603	1603266	SSP0626	3817.89
SSP0588	D85201KA0A	SSP0603	1603289	SSP0627	1610817880
SSP0589	D85401KA0A	SSP0603	1609013	SSP0628	1610817780
SSP0590	48527JD01A	SSP0603	93179559	SSP0629	3817.38
SSP0590	48547JDA01	SSP0603	93181232	SSP0629	3817.44
SSP0590	D8520JG00A	SSP0603	93186333	SSP0630	3817.37
SSP0591	48527JDA01	SSP0604	1609026	SSP0630	3817.43
SSP0591	48647JD01A	SSP0604	6606031	SSP0631	3817.A2
SSP0591	D8640JG00A	SSP0604	13272000	SSP0632	3817.A1
SSP0592	D85204EA0A	SSP0604	13278359	SSP0633	4501263
SSP0593	D86404EA0A	SSP0604	13286686	SSP0633	9161563
SSP0594	324042	SSP0605	39008083	SSP0633	7701470364
SSP0594	324050	SSP0606	39008084	SSP0633	4852000QAH
SSP0594	1603009	SSP0607	13354540	SSP0634	4501262
SSP0594	7840452	SSP0608	13354538	SSP0634	9161562
SSP0594	26087868	SSP0609	13272002	SSP0634	7701470363
SSP0595	324066	SSP0610	13272001	SSP0634	4852000QAJ
SSP0596	16032240	SSP0611	93296756	SSP0635	4420098
SSP0596	16032440	SSP0612	95493208	SSP0635	485200780R
SSP0596	93192417	SSP0612	9471000965	SSP0636	4420097
SSP0597	4701744	SSP0612	9471003465	SSP0636	485206730R
SSP0597	4705655	SSP0612	3817.10	SSP0637	D8520JY00A



MAGNETI MARELLI	O.E.	MAGNETI MARELLI	O.E.	MAGNETI MARELLI	O.E.
SSP0638	D8640JY00A	SSP0658	485200001R	SSP0681	4504609430
SSP0639	7701474796	SSP0659	485201340R	SSP0681	4504629425
SSP0640	7701474795	SSP0660	485206481R	SSP0682	4504609320
SSP0641	4408511	SSP0661	6RD423812A	SSP0683	4504609360
SSP0641	91160044	SSP0661	6RD423812B	SSP0683	4504619265
SSP0641	7701049283	SSP0662	6Q0423811A	SSP0683	4504649115
SSP0641	4852000QAL	SSP0662	6Q0423811C	SSP0684	4504709150
SSP0642	4408510	SSP0663	6Q0423812	SSP0684	4504719115
SSP0642	91160043	SSP0663	6Q0423812D	SSP0684	4504749045
SSP0642	7701049282	SSP0663	8Z0423812A	SSP0685	4504609570
SSP0642	4852000QAK	SSP0664	6Q0423811	SSP0685	4504619415
SSP0643	485204680R	SSP0664	6Q0423811D	SSP0686	4504709570
SSP0644	485202710R	SSP0664	8Z0423811A	SSP0686	4504719215
SSP0645	6000022721	SSP0665	4709195	SSP0687	4504609570
SSP0645	7701471127	SSP0665	4881063J00	SSP0688	4504709270
SSP0646	6000022720	SSP0665	48810M68K00	SSP0689	4504769085
SSP0646	7701471126	SSP0666	4504629255	SSP0690	4504669135
SSP0647	7701471146	SSP0667	4504669205	SSP0691	4504639335
SSP0648	7701471145	SSP0668	4504769115	SSP0692	4504739215
SSP0649	7701047416	SSP0669	4504539505	SSP0693	4504669236
SSP0649	7701047813	SSP0670	4504609261	SSP0693	4504769146
SSP0649	7701474493	SSP0671	4504609281	SSP0694	4504669235
SSP0649	7701475843	SSP0672	4504659025	SSP0694	4504769145
SSP0649	48520AX602	SSP0672	4504659026	SSP0695	4504669245
SSP0650	7701047415	SSP0672	4504659045	SSP0696	95534713220
SSP0650	7701047812	SSP0673	4504759025	SSP0696	7L0422818B
SSP0650	7701474492	SSP0673	4504759026	SSP0696	7L0422818C
SSP0650	7701474641	SSP0673	4504759035	SSP0696	7L0422818D
SSP0650	7701475842	SSP0674	4504609480	SSP0697	95534713221
SSP0650	48640AX602	SSP0674	4504659255	SSP0697	7L0422817B
SSP0651	4154600105	SSP0675	4504709220	SSP0697	7L0422817C
SSP0651	7701478408	SSP0675	4504709480	SSP0697	7L0422817D
SSP0651	A4154600105	SSP0675	4504759135	SSP0698	171419812
SSP0652	4154600005	SSP0676	4504619175	SSP0698	191419812
SSP0652	7701478407	SSP0676	4504629305	SSP0698	3A0422812
SSP0652	A4154600005	SSP0677	4504749025	SSP0699	191419811
SSP0653	485208355R	SSP0678	4504649095	SSP0699	3A0422811
SSP0654	485200368R	SSP0679	4504609650	SSP0700	1K0423812A
SSP0655	6000022731	SSP0679	4504649195	SSP0700	1K0423812E
SSP0656	6000022730	SSP0680	4504709310	SSP0700	1K0423812G
SSP0657	485200002R	SSP0680	4504749195	SSP0700	1K0423812J



MAGNETI MARELLI	O.E.	MAGNETI MARELLI	O.E.	MAGNETI MARELLI	O.E.
SSP0700	1K0423812K	SSP0718	31317781	SSP1201	9351837
SSP0701	1K0423811A	SSP1181	46802682	SSP1201	50705629
SSP0701	1K0423811E	SSP1181	60629903	SSP1201	3640.67
SSP0701	1K0423811G	SSP1182	46802680	SSP1201	3640.76
SSP0701	1K0423811J	SSP1182	60652167	SSP1204	3302242
SSP0701	1K0423811K	SSP1184	4443405	SSP1204	93807545
SSP0702	1S0423812A	SSP1184	4449553	SSP1205	83500202 part of
SSP0703	1S0423811A	SSP1184	K04762861AA	SSP1206	8983500202
SSP0704	7H0422818B	SSP1185	5051316	SSP1207	5135651AE
SSP0704	7H0422818C	SSP1185	505-1316	SSP1208	5069161AA
SSP0705	7H0422817B	SSP1186	5090033AB	SSP1208	5110437AA
SSP0705	7H0422817C	SSP1186	K05090033AB	SSP1208	5110437AI
SSP0706	1092378	SSP1187	4402644	SSP1208	5114037AI
SSP0706	7M0422818	SSP1187	4402649	SSP1211	7601064
SSP0706	7M0422818B	SSP1187	SE141140104A	SSP1213	352357
SSP0707	1092380	SSP1188	51783056	SSP1213	352364
SSP0707	7M0422817	SSP1188	51783057	SSP1213	4566899
SSP0707	7M0422817B	SSP1188	93190907	SSP1213	6140350007
SSP0708	30870695	SSP1188	3520.87	SSP1213	90468636
SSP0708	30875012	SSP1188	3520.W3	SSP1214	16545660
SSP0708	MB241982	SSP1189	46437951	SSP1216	7601065
SSP0708	MB598023	SSP1191	46437959	SSP1217	46748579
SSP0708	MB912076	SSP1191	46454599	SSP1218	46748578
SSP0709	274176	SSP1192	50706463	SSP1219	46802680/682
SSP0709	274497	SSP1193	7081835	SSP1221	46802680/682
SSP0709	30761718	SSP1193	46543045	SSP1222	7601068
SSP0710	274175	SSP1194	7082812	SSP1225	50704480/481
SSP0710	274496	SSP1194	46779293	SSP1226	50704480/481
SSP0710	30761719	SSP1194	46842581	SSP1227	352319
SSP0711	272417	SSP1195	51810664/665 part of	SSP1227	93171448
SSP0712	272416	SSP1196	1302368080	SSP1228	50509339/340
SSP0713	274352	SSP1196	3640.32	SSP1229	50700443
SSP0713	274499	SSP1197	542410095	SSP1231	50700778
SSP0714	274351	SSP1197	1300473080	SSP1232	1331940080/8080
SSP0714	274498	SSP1197	3640.33	SSP1233	60627290/291
SSP0714	2741910	SSP1198	1302368080	SSP1234	60627290/291
SSP0715	2601671	SSP1198	1331640080	SSP1235	60627290/291
SSP0715	31302345	SSP1198	3640.55	SSP1236	4157013
SSP0716	2601672	SSP1199	1300473080	SSP1239	50509339/340
SSP0716	31302344	SSP1199	1331641080	SSP1241	3521.H0/H1
SSP0717	31317819	SSP1199	3640.54	SSP1242	3521.H0/H1



MAGNETI MARELLI	O.E.	MAGNETI MARELLI	O.E.	MAGNETI MARELLI	O.E.
SSP1248	1312317080	SSP1287	50705712	SSP1306	4895-483AA
SSP1249	1305551080	SSP1287	51706474	SSP1306	K0489548AB
SSP1253	50509339/340	SSP1288	50704702	SSP1307	K04766962AA
SSP1254	1305552080	SSP1288	50705311	SSP1308	K04766435AA
SSP1255	352380	SSP1288	51795705	SSP1308	K68052655AA
SSP1255	55703232	SSP1289	50704361	SSP1309	50704671
SSP1256	55700751	SSP1289	50706990	SSP1311	50706957
SSP1257	1300507080	SSP1289	51795454	SSP1311	51856873
SSP1258	1308694080	SSP1289	50704362	SSP1312	50703296
SSP1258	1338373080	SSP1291	50704362	SSP1312	51856872
SSP1258	3523.94	SSP1291	50706991	SSP1313	1580517
SSP1259	3520.S1/3521.P2	SSP1291	51795455	SSP1313	51801136
SSP1261	3520.S1/3521.P2	SSP1291	50704361	SSP1313	9S515K484AB
SSP1262	4656012AC	SSP1292	60625029	SSP1314	7601642
SSP1263	4656730AH/31AH	SSP1293	60613575	SSP1314	7601643
SSP1264	4694760/61	SSP1294	60630757	SSP1314	12574521
SSP1265	4694760/61	SSP1295	60628255	SSP1314	60570627
SSP1267	60620565	SSP1296	60628284	SSP1315	46413122
SSP1268	50704306/307	SSP1297	50515276	SSP1315	51701045
SSP1269	7673581	SSP1297	51805870	SSP1316	350616
SSP1271	5927293	SSP1298	50515275	SSP1316	50515276
SSP1271	7673582	SSP1298	51806609	SSP1316	55700753
SSP1272	60682636	SSP1298	51978679	SSP1317	51815479
SSP1272	82315794	SSP1299	50515274	SSP1317	5080.7
SSP1273	50706955	SSP1299	51806608	SSP1317	5080.70
SSP1273	50708722	SSP1299	51978680	SSP1317	5087.65
SSP1274	50706954	SSP1301	4743021AA	SSP1318	46549529
SSP1274	50708721	SSP1301	4743454AA	SSP1318	46739116
SSP1275	7775344	SSP1301	4743454AB	SSP1319	46462049
SSP1276	7775343	SSP1301	4743454AC	SSP1321	46767267
SSP1277	46551376	SSP1301	4743669AB	SSP1321	51717000
SSP1278	46551377	SSP1301	4743669AC	SSP1322	46799278
SSP1279	46454061	SSP1301	K04694855	SSP1322	51717001
SSP1281	46454062	SSP1302	5272190	SSP1323	50700464
SSP1282	60620566	SSP1303	K0465693AAB	SSP1323	51801136
SSP1283	46421552	SSP1304	4766866AA	SSP1324	51810124
SSP1284	50521047	SSP1305	4895482AA	SSP1324	51810124*
SSP1284	51805863	SSP1305	4895-482AA	SSP1325	350198
SSP1285	50521045	SSP1305	4895482AC	SSP1325	51848645
SSP1285	51805862	SSP1305	K04895483AB	SSP1325	51898527
SSP1287	50705703	SSP1306	4895483AA	SSP1325	95511247



MAGNETI MARELLI	O.E.	MAGNETI MARELLI	O.E.	MAGNETI MARELLI	O.E.
SSP1326	1308664080	SSP1351	04743935AD	SSP1383	9945836
SSP1326	1317425080	SSP1351	4743935AD	SSP1383	4006.24
SSP1326	5087.35	SSP1351	680196443AB	SSP1384	77362280
SSP1327	1300716080	SSP1352	68028831AC	SSP1384	3812.E2
SSP1327	5087.37	SSP1352	680288331AR	SSP1384	381200
SSP1328	1357572080	SSP1353	59588244	SSP1385	1341021080
SSP1328	1357572080*	SSP1355	7076231	SSP1385	1345854080
SSP1329	1355440080	SSP1356	77362506	SSP1385	1359226080
SSP1329	1355449080	SSP1358	7658273	SSP1385	1607744580
SSP1329	5170.F5	SSP1359	51875886SK part of	SSP1385	4001.E4
SSP1331	1400099680	SSP1359	51965673 part of	SSP1385	4001.E5
SSP1331	5087.56	SSP1361	5958244	SSP1385	40010000
SSP1332	500383975	SSP1361	7633721	SSP1386	77362380
SSP1333	500383976	SSP1361	SE022162449S	SSP1387	1401381380
SSP1334	52089486AE	SSP1362	9941625	SSP1387	1497550080
SSP1335	52089467AB	SSP1363	7701491	SSP1387	3812.F0
SSP1336	52088662AB	SSP1363	9946948	SSP1388	2992593
SSP1337	05174245AD	SSP1364	9945562	SSP1389	77362502
SSP1338	05174185AC	SSP1365	9947713	SSP1391	68040224AA
SSP1339	350603	SSP1366	9948343	SSP1392	1603543
SSP1339	24417251	SSP1367	1609211	SSP1392	93189022
SSP1339	51741130	SSP1367	9944452	SSP1393	1603229
SSP1341	1331209080	SSP1367	9950452	SSP1393	93172256
SSP1341	5087.51	SSP1367	93196540	SSP1393	1603290
SSP1342	04782684AB	SSP1369	55172401	SSP1394	4883079J00
SSP1343	60614514	SSP1371	7079382	SSP1394	48830-79J00
SSP1343	71742688	SSP1372	7079383	SSP1395	4883079J10
SSP1343	4252080J00	SSP1373	7081851	SSP1395	48830-79J10
SSP1343	42520-80J00	SSP1374	98845024	SSP1396	77363707
SSP1344	77363706	SSP1375	98845026	SSP1397	77363706
SSP1344	77363706*	SSP1376	9949217	SSP1398	7678717
SSP1344	77363707	SSP1377	26144989	SSP1398	60565705
SSP1344	77363707*	SSP1377	98845878	SSP1399	7678718
SSP1345	9947361	SSP1378	98845878	SSP1399	9947435
SSP1346	9944452	SSP1379	4318655	SSP1399	9947437
SSP1347	9947923	SSP1381	9566950880	SSP1399	60565706
SSP1348	9948297	SSP1381	3812.A4	SSP1401	9947920
SSP1349	50519427	SSP1382	9945385	SSP1402	9947919
SSP1349	50521026	SSP1382	9945836	SSP1403	50520353
SSP1349	50521639	SSP1382	1471654080	SSP1404	50520352
SSP1349	50526421	SSP1382	4018.A4	SSP1405	4797706



MAGNETI MARELLI	O.E.	MAGNETI MARELLI	O.E.	MAGNETI MARELLI	O.E.
SSP1405	K04797706	SSP1419	77363830	SSP1443	K52125484AA
SSP1406	05066373AB	SSP1421	1603544	SSP1444	5143556AC
SSP1406	05183761AD	SSP1421	1609457	SSP1445	5143555AC
SSP1406	5183761AA	SSP1421	77363829	SSP1446	5072444AA
SSP1406	ES3008RL	SSP1422	77364569	SSP1446	5072445AA
SSP1406	K05183761AA	SSP1422	3817.87	SSP1446	52128520AA
SSP1407	4762861	SSP1423	77364568	SSP1447	5072444AA
SSP1407	4762861AA	SSP1423	3817.86	SSP1447	5072445AA
SSP1408	52013468AB	SSP1424	46456660	SSP1447	52128521AA
SSP1408	5201-3468AB	SSP1424	98845031	SSP1448	1603228
SSP1408	52013468AC	SSP1425	46456189	SSP1448	5235668
SSP1408	5201-3468AC	SSP1425	98845032	SSP1448	5239322
SSP1408	68141049AA	SSP1426	9949218	SSP1449	1603227
SSP1409	5958246	SSP1427	77365224	SSP1449	5235650
SSP1409	5983404	SSP1428	77365223	SSP1449	5239314
SSP1409	5983406	SSP1429	1306003080	SSP1451	77362278
SSP1411	5960835	SSP1429	9404059580	SSP1451	4018.E0
SSP1411	SE141162410A	SSP1429	4059.09	SSP1452	71742770
SSP1412	1546260	SSP1431	1306716080	SSP1452	4881079J01
SSP1412	77362508	SSP1431	1471655080	SSP1452	48810-79J01
SSP1412	9S513270BA	SSP1431	4018.A3	SSP1773	894407365E
SSP1413	1546259	SSP1432	77362279	SSP1773	8A0407365
SSP1413	77362507	SSP1432	4059.12	SSP1774	894407366E
SSP1413	9S513270AA	SSP1433	77364009	SSP1774	8A0407366
SSP1414	9947436	SSP1433	3817.7	SSP1775	8N0407365A
SSP1414	9947438	SSP1433	3817.70	SSP1775	8N0407365B
SSP1414	60806355	SSP1434	77364253	SSP1775	8N0407365C
SSP1415	9947438	SSP1434	3817.77	SSP1776	1J0407366A
SSP1415	9947439	SSP1435	77362381	SSP1776	1J0407366B
SSP1415	60806356	SSP1436	9403817738	SSP1776	1J0407366C
SSP1416	7752285	SSP1436	3817.73	SSP1777	1J0407366A/B/C*
SSP1416	9946949	SSP1437	5960036	SSP1778	1J0407365A
SSP1417	9947714	SSP1437	5960037	SSP1778	1J0407365B
SSP1417	9947719	SSP1437	5960056	SSP1778	1J0407365C
SSP1417	46527567	SSP1437	7669756	SSP1778	1J0407365D
SSP1417	98845030	SSP1437	SE022162406A	SSP1779	1J0407366A/B/C*
SSP1418	9947719	SSP1438	42534911	SSP1780	8K0407689E
SSP1418	9947926	SSP1439	7362503	SSP1780	8K0407689F
SSP1418	46527567	SSP1439	77362503	SSP1781	8J0407366
SSP1419	1603545	SSP1441	52005739	SSP1782	8J0407365
SSP1419	1609458	SSP1442	K52125483AA	SSP1783	4G0407689C



MAGNETI MARELLI	O.E.	MAGNETI MARELLI	O.E.	MAGNETI MARELLI	O.E.
SSP1784	4H0407689	SSP1808	13258056	SSP1828	504212586
SSP1785	31126768988	SSP1808	96852964	SSP1829	6L2Z3084AA
SSP1786	31121096425	SSP1808	C96852964	SSP1829	6L2Z3085AA
SSP1786	31126756491	SSP1809	95952782/83	SSP1830	BL5Z3050A
SSP1787	31103412726	SSP1810	25997509 part of	SSP1831	1030025
SSP1787	31103418341	SSP1810	25997510 part of	SSP1831	1047797
SSP1788	31100363476	SSP1811	12380415	SSP1831	94FB3395A2B
SSP1788	31103438623	SSP1811	12383410	SSP1832	1540724 part of
SSP1789	31106787665	SSP1812	88967431	SSP1832	1751952 part of
SSP1790	31126777753	SSP1813	19209396	SSP1832	1751955 part of
SSP1791	31126779840	SSP1814	19207521	SSP1832	BE8Z3078A part of
SSP1792	13258056	SSP1815	9613696	SSP1832	BE8Z3079A part of
SSP1793	12475485	SSP1815	96035445	SSP1833	1679382
SSP1793	12475486	SSP1815	3640.38	SSP1833	2S613395AB
SSP1793	K6540	SSP1815	3640.42	SSP1834	8S4Z3078A/8S4Z3079A part of
SSP1794	92119830	SSP1816	96025445	SSP1835	1207974
SSP1794	96328437	SSP1816	3640.39	SSP1835	1212809
SSP1794	C96639918	SSP1816	3640.43	SSP1835	94FB3395B2A
SSP1795	96328437	SSP1817	96093233	SSP1836	1470387
SSP1795	96445783	SSP1817	3640.36	SSP1836	3M513395BC
SSP1796	19133670	SSP1818	9803434080	SSP1837	1234382
SSP1796	8191336700	SSP1819	3640.56	SSP1837	3M513K209AA
SSP1797	19133638	SSP1819	3640.61	SSP1838	9L3Z3050A
SSP1797	22157320	SSP1819	3640.62	SSP1839	4R3Z3078B part of
SSP1797	8191336380	SSP1819	3640.65	SSP1839	4R3Z3079B part of
SSP1798	96535089	SSP1819	3640.66	SSP1840	CR3Z3078D
SSP1799	19258791	SSP1820	3640.77	SSP1841	1723323 part of
SSP1799	20945779/20945780**	SSP1821	4782740AA	SSP1842	1723324 part of
SSP1800	352532	SSP1821	4782740AB	SSP1843	104230 part of
SSP1800	95916024	SSP1821	4782741AB	SSP1843	F5TZ3082A part of
SSP1801	96490218	SSP1821	68159271AA	SSP1844	DV613A424AF part of
SSP1802	96436597 part of	SSP1822	04766911AL part of	SSP1845	DV613A423AF part of
SSP1802	96436598 part of	SSP1823	401602308R	SSP1846	4120734
SSP1803	89040241	SSP1824	68217808AA	SSP1846	4173761
SSP1804	96261108	SSP1824	68217809AA	SSP1846	4616978
SSP1805	19210782	SSP1825	68069648AB	SSP1846	2T1Z3468A
SSP1806	19122185	SSP1826	51945321	SSP1846	YC153395AB
SSP1806	22113159	SSP1826	51961341/59820* part of	SSP1846	YC1A3395BA
SSP1806	22145460	SSP1827	52026562	SSP1847	1417351
SSP1806	22156500	SSP1828	504212584	SSP1847	KT6C113K209AA
SSP1807	19133669				



MAGNETI MARELLI	O.E.	MAGNETI MARELLI	O.E.	MAGNETI MARELLI	O.E.
SSP1848	1817754	SSP1870	51760-2E010	SSP1891	2113300435
SSP1848	KTBK313K209AA	SSP1870	51770-2E000	SSP1891	2203300727
SSP1849	1817752	SSP1870	51770-2E010	SSP1891	2203330127
SSP1849	KTBK213K209AB	SSP1871	545012E030 /	SSP1891	2203330427
SSP1850	1S713395AF		545002E030 part of	SSP1892	2113230068
SSP1851	1679376	SSP1872	517602R000	SSP1892	2203230368
SSP1851	1X43395AB	SSP1873	545302K000	SSP1893	2113300427
SSP1851	C2S19367	SSP1874	2023330027	SSP1893	2113309907
SSP1851	C2S37075	SSP1874	2103300035	SSP1893	2113310008
SSP1851	C2S8390	SSP1874	2103300435	SSP1893	2113330227
SSP1852	1469026 part of	SSP1874	2113300335	SSP1894	A0003301007
SSP1852	30671637 part of	SSP1875	2023304907 part of	SSP1895	2L8Z3079AA
SSP1852	6G9N3395AA part of	SSP1876	2123300035	SSP1896	BBM234300/350 part of
SSP1853	545303S000	SSP1876	2123300135		of
SSP1854	5450322000	SSP1877	1683330127	SSP1897	EH4434350/300 part of
SSP1854	5450331600	SSP1877	1683330227	SSP1898	GJ6A34540
SSP1854	5453025000	SSP1878	1693330127	SSP1899	5441744000
SSP1854	5450322A00	SSP1879	6383300027	SSP1899	MB109585
SSP1855	545303J000	SSP1880	4473330127	SSP1900	5452443301
SSP1856	545300U000	SSP1881	1663300235	SSP1900	545244330A
SSP1856	545303X000	SSP1881	A1663300235	SSP1900	MB176309
SSP1857	517601G000	SSP1882	6393330227	SSP1900	MB349475
SSP1858	517602G000	SSP1883	4143330127	SSP1900	MB527383
SSP1859	545303S100	SSP1883	4143330227	SSP1901	544174AA00
SSP1860	545033BA00	SSP1884	9013330727	SSP1901	MB241623
SSP1860	545303B000	SSP1884	9013331127	SSP1901	MB527349
SSP1861	83500202	SSP1884	2D0407361A	SSP1901	MB527350
SSP1862	52090206AF	SSP1884	2D0407361B	SSP1901	MR241623
SSP1863	68004085AA	SSP1885	9013330727	SSP1902	MB518206
SSP1864	5012432AA	SSP1885	9013331127	SSP1903	352V0/3521R1/4013A0
SSP1865	5105040AC/5105040AH part of	SSP1885	9013331327		09/4013A0010 part of
		SSP1885	2D0407361B		
SSP1865	5105041AC/5105041AH part of	SSP1886	9063304007	SSP1904	MB860829
		SSP1887	1633300035	SSP1904	MB860830
SSP1866	54570-3E000	SSP1887	1633300135	SSP1905	MB296269
SSP1866	54570-3E001	SSP1888	1633500013	SSP1905	MB831037
SSP1867	545203E000 part of	SSP1888	1633500113	SSP1906	MB831038
SSP1868	54530C5100	SSP1889	1643300935	SSP1906	MR296270
SSP1869	5435007000	SSP1890	1643520127	SSP1907	14013040
SSP1869	5453007000	SSP1890	1643530327	SSP1907	4013A090
SSP1870	51760-2E000	SSP1891	2113300235	SSP1907	MR496799
				SSP1908	4010A015



MAGNETI MARELLI	O.E.	MAGNETI MARELLI	O.E.	MAGNETI MARELLI	O.E.
SSP1908	MR496792	SSP1926	545014BA0A part of	SSP1944	6001538603
SSP1909	31126783443	SSP1926	545014CA0A part of	SSP1944	7701462182
SSP1909	32126756309	SSP1926	545014CUA0 part of	SSP1944	7701468883
SSP1910	31106779438	SSP1926	545014JD000 part of	SSP1945	7702127160
SSP1910	31126753992	SSP1927	1603128	SSP1946	4401910
SSP1911	31106779437	SSP1927	1603161	SSP1946	4500090
SSP1911	31126753991	SSP1927	1603187	SSP1946	7700302114
SSP1912	31126772305	SSP1927	90166394	SSP1946	7701056970
SSP1913	31126772304	SSP1928	1603202	SSP1946	4011000QAA
SSP1914	31126772303	SSP1928	90539896	SSP1946	4011000QAB
SSP1915	31109803662	SSP1929	352803	SSP1947	4500255
SSP1916	4016050A00	SSP1929	9196394	SSP1947	9160555
SSP1916	4016050J25	SSP1930	5352026	SSP1947	7700312852
SSP1916	4016060Y60	SSP1931	5352025	SSP1947	4016000QAD
SSP1916	4016070J00	SSP1932	352800	SSP1948	4500254
SSP1917	4016050Y00	SSP1932	352829	SSP1948	4501261
SSP1917	4016052Y00	SSP1932	352830	SSP1948	9161561
SSP1917	4016060Y20	SSP1932	5231683	SSP1948	7700312851
SSP1918	401604F100	SSP1932	90512982	SSP1948	4016000QAB
SSP1918	401604F105	SSP1933	39021472/3 part of	SSP1949	4418631
SSP1919	40160AX000	SSP1934	95028039	SSP1949	7701070154
SSP1920	545001HA0C/545011HA0C part of	SSP1934	96233739	SSP1949	4016000Q0B
		SSP1934	3640.28	SSP1950	4419219
SSP1920	545003VU0A/545013VU0A part of	SSP1934	3640.34	SSP1950	93197233
		SSP1934	3640.71	SSP1950	8200688877
SSP1921	401600W000	SSP1935	3640.58	SSP1951	401608374R
SSP1921	401600W025	SSP1935	3640.72	SSP1952	8200298455/S
SSP1922	40160EA00A part of	SSP1936	3640.57	SSP1953	16160100006
SSP1922	40160EB310	SSP1936	3640.74	SSP1953	8200255761S
SSP1923	40110EA000	SSP1937	3640.78	SSP1954	4412936
SSP1923	54524EA000	SSP1938	96087507	SSP1954	7701476576
SSP1924	36160100045	SSP1938	3640.50	SSP1954	4016000Q0A
SSP1924	401602Y000	SSP1938	3640.51	SSP1954	91166461*
SSP1924	54500AV600*	SSP1939	3640.53	SSP1955	7701477385
SSP1924	54501AV600*	SSP1939	3640.60	SSP1956	401600005R
SSP1925	545011KA0B/545001KA0B part of	SSP1939	3640.68	SSP1956	401609060R
		SSP1940	3640.73	SSP1957	8200763296
SSP1926	545004BA0A part of	SSP1941	9672192480	SSP1958	401600004R
SSP1926	545004CA0A part of	SSP1942	3640.83	SSP1959	545045297R part of
SSP1926	545004CUA0 part of	SSP1943	545006069R part of	SSP1959	545057449R part of
SSP1926	54500JD000 part of	SSP1943	545019956R part of	SSP1960	545047275R part of



MAGNETI MARELLI	O.E.	MAGNETI MARELLI	O.E.	MAGNETI MARELLI	O.E.
SSP1960	545050303R part of	SSP1980	3C0407366A	SSP2001	8D0505465
SSP1961	6Q0407366A	SSP1981	3C0407365A	SSP2002	1J0411315D
SSP1961	8Z0407366A	SSP1982	7E0407361	SSP2003	1J0411315D
SSP1962	6Q0407365A	SSP1982	7H0407361	SSP2004	1J0411316D
SSP1962	8Z0407365A	SSP1982	7H0407361A	SSP2005	4D0411317G
SSP1963	5U0407366A	SSP1983	7H8407361	SSP2005	4D0411317J
SSP1963	6R0407366	SSP1983	7H8407361A	SSP2005	4D0411317K
SSP1964	5U0407365A	SSP1984	7200946 7M0407365A	SSP2006	8Z0411315C
SSP1964	6R0407365	SSP1984	7M3407365A	SSP2006	8Z0411315D
SSP1965	4520170C00/45202 part of	SSP1984	YM213395BA	SSP2007	8D0407318D
SSP1966	4862060010 part of	SSP1985	6N0407366	SSP2007	8D0411318D
SSP1966	4864060010 part of	SSP1986	6N0407365	SSP2008	8D0407317D
SSP1967	4861060030/4863060010 part of	SSP1987	30821650*	SSP2008	8D0411317D
SSP1968	4333049025	SSP1987	30821651*	SSP2009	4D0411317K
SSP1969	4333009510	SSP1987	MB303374	SSP2010	4D0505465D
SSP1970	4331009015	SSP1987	MB518961	SSP2011	4D0505465D
SSP1971	4330859035	SSP1988	274186	SSP2012	4D0505548C
SSP1971	4330859095	SSP1988	274193	SSP2012	4E0505548L
SSP1972	4333009090	SSP1988	274544	SSP2013	4D0505547C
SSP1972	4333009230	SSP1988	274548	SSP2013	4E0505547L
SSP1972	4333009360	SSP1989	274377	SSP2014	8E0411318
SSP1972	4333049185	SSP1989	274523	SSP2015	8E0411317
SSP1973	4333009320	SSP1989	274573	SSP2016	8E0505465A
SSP1973	4333009360	SSP1989	31202485	SSP2016	8E0505465F
SSP1974	4333009630	SSP1990	30881488/30881487 part of	SSP2016	8E0505465K
SSP1974	4333019245	SSP1990	31277526/31277525 part of	SSP2016	8E0505465T
SSP1974	4333049095	SSP1991	31340231 part of	SSP2017	8E0505465AFK
SSP1975	4331039016	SSP1991	31340232 part of	SSP2018	8E0505465D
SSP1975	4331039085	SSP1992	8J0407366	SSP2019	4F0505465N
SSP1976	1K0407366B	SSP1993	8J0407366	SSP2020	4E0411317C
SSP1976	1K0407366C	SSP1994	8J0407365	SSP2020	4E0411317D
SSP1976	1K0407366E	SSP1995	MR496799	SSP2020	4E0411317E
SSP1976	5Q0407366A	SSP1996	3640.58	SSP2021	4F0505465P
SSP1977	1K0407365B	SSP1996	3640.72	SSP2022	8K0411317C
SSP1977	1K0407365C	SSP1997	7H8407361A	SSP2022	8K0411317E
SSP1977	1K0407365E	SSP1997	7H8407361A	SSP2023	1J0505466B
SSP1977	5Q0407365A	SSP1998	6N0407366*	SSP2024	8K0411317B
SSP1978	3C0407366B	SSP1999	6N0407365*	SSP2025	8K0411317D
SSP1979	3C0407365B	SSP2000	8A0505466C	SSP2025	8K0411317E
		SSP2000	8D0505466	SSP2027	4G0411317A
		SSP2001	8A0505465C	SSP2027	4G0411317C



MAGNETI MARELLI	O.E.	MAGNETI MARELLI	O.E.	MAGNETI MARELLI	O.E.
SSP2028	6Q0411315N	SSP2057	31306781547	SSP2085	33326775683
SSP2029	50705703	SSP2057	31354014531	SSP2086	31306781550
SSP2030	50705702	SSP2057	31356760985	SSP2087	31306781549
SSP2031	46843389	SSP2057	31356769499	SSP2088	33556857626
SSP2031	60625029	SSP2058	33506781540	SSP2089	31356859652
SSP2032	31306862864	SSP2058	33556761000	SSP2090	31356859651
SSP2033	31356765934	SSP2059	31356769664	SSP2091	12542993
SSP2034	31356765933	SSP2060	31356769663	SSP2092	22810912
SSP2035	33556764428	SSP2061	31306781546	SSP2093	96225859
SSP2036	31356768772	SSP2061	31356753768	SSP2094	96225858
SSP2037	31356768771	SSP2062	31306781545	SSP2095	96639910
SSP2038	31306792212	SSP2062	31356753767	SSP2096	96639910
SSP2039	31306792211	SSP2063	33506781538	SSP2097	10403402
SSP2040	33506785608	SSP2063	33556757460	SSP2098	20985982
SSP2041	33506785607	SSP2064	33506781539	SSP2099	15918822
SSP2042	31351092304	SSP2064	33556753770	SSP2100	15918823
SSP2042	31351095664	SSP2065	33556786429	SSP2101	88965470
SSP2043	31351091855	SSP2066	31351091496	SSP2101	88982342
SSP2043	31351095661	SSP2066	31351095695	SSP2102	88965471
SSP2044	31351091855	SSP2067	33551091497	SSP2102	88982343
SSP2044	31351095661	SSP2067	33551095696	SSP2103	15146379
SSP2045	31351091856	SSP2068	31356750704	SSP2104	15218267
SSP2045	31351095662	SSP2069	31356750703	SSP2105	15218268
SSP2046	31351091856	SSP2070	33551096735	SSP2106	15926031
SSP2046	31351095662	SSP2071	31303413202	SSP2107	95465758
SSP2047	33551092292	SSP2071	31303413300	SSP2108	96403100
SSP2048	33551092292	SSP2072	31303413201	SSP2109	96403099
SSP2048	33551095532	SSP2072	31303413299	SSP2110	96391876
SSP2049	33551095532	SSP2073	33503413197	SSP2110	96561754
SSP2050	33551094619	SSP2073	33503414297	SSP2111	22670300
SSP2051	31351095694	SSP2074	33556771937	SSP2112	20961222
SSP2052	3135095694*	SSP2075	31356773024	SSP2113	15851956
SSP2053	31356751080	SSP2076	31356773023	SSP2114	15232855
SSP2054	31356751079	SSP2077	37116771930	SSP2115	15196858
SSP2055	33506768492	SSP2078	37116771929	SSP2116	15167957
SSP2055	33506768493	SSP2079	33556790324	SSP2117	15167956
SSP2055	33506781537	SSP2080	31306787164	SSP2118	15963924
SSP2056	31306781548	SSP2081	31306787163	SSP2118	25747956
SSP2056	31354014532	SSP2082	37106775189	SSP2118	4656260AA
SSP2056	31356760986	SSP2083	31356777319	SSP2118	6W1Z5664AA
SSP2056	31356769500	SSP2084	33556777635	SSP2119	15089907



MAGNETI MARELLI	O.E.	MAGNETI MARELLI	O.E.	MAGNETI MARELLI	O.E.
SSP2120	20822934	SSP2145	96288787*	SSP2174	8V513B438AB
SSP2121	15697702	SSP2146	68186554AA	SSP2174	8V513B438BA
SSP2122	15991383	SSP2146	68186554AB	SSP2174	8V5Z5K484B
SSP2123	4804642	SSP2147	K05272324AC	SSP2174	D65134170
SSP2123	4817539	SSP2148	04656934AA	SSP2175	1513343*
SSP2123	96626150	SSP2148	04656934AB	SSP2175	8V513B438AB*
SSP2123	96996460	SSP2148	K04656934AA	SSP2175	8V5Z5K484B
SSP2124	96626150	SSP2148	K0465693AAB	SSP2175	D65134170*
SSP2124	96996460	SSP2149	4782952AD	SSP2176	1146150
SSP2125	C96626248	SSP2150	MR333763	SSP2176	DD3234170
SSP2126	C96626247	SSP2151	MR297333	SSP2176	Y125613B438AC
SSP2127	22900200	SSP2152	04782254AB	SSP2177	Y125613B438AC*
SSP2128	92243928	SSP2153	96391875	SSP2178	1061631
SSP2129	92243929	SSP2154	8200814411	SSP2178	1130273
SSP2130	95947829	SSP2155	68029024AA	SSP2178	1661237
SSP2131	22710259	SSP2156	68091836AA	SSP2178	1E0034170
SSP2132	15961007	SSP2157	68091837AA	SSP2178	1S613B438AA
SSP2133	25918049	SSP2158	68069654AB	SSP2178	98AG3B438AB
SSP2134	15257472	SSP2159	68069655AB	SSP2179	AA8Z5K484A
SSP2135	20905104	SSP2160	68069682AA	SSP2179	DG1Z5K484A
SSP2136	15129234	SSP2161	68091853AA	SSP2180	AA8Z5K484B
SSP2137	5087.34	SSP2162	50703296	SSP2180	DG1Z5K484B
SSP2137	5087.39	SSP2162	51856872	SSP2181	BB5Z5K484A
SSP2137	5087.46	SSP2163	51939949	SSP2182	BB5Z5K483A
SSP2137	5087.61	SSP2164	51942168	SSP2183	5182780
SSP2138	96145457	SSP2164	53403319	SSP2183	DG9C3B438ANC
SSP2139	93802209	SSP2165	46413122*	SSP2183	DG9Z5C486A
SSP2139	96177836	SSP2166	55700753	SSP2183	DG9Z5K484A
SSP2139	5087.40	SSP2167	51815479	SSP2184	5182818
SSP2140	96145457	SSP2167	5087.65	SSP2184	DG9C5C486AXC
SSP2140	500310933	SSP2167	5087.70	SSP2185	AS4Z5K484A
SSP2140	5087.40	SSP2168	50700464	SSP2186	1061702
SSP2141	96080894	SSP2168	51795269	SSP2187	1203093
SSP2141	5087.30	SSP2168	51801136	SSP2187	2M515E594AA
SSP2141	5087.41	SSP2169	1400099680*	SSP2188	1111769
SSP2142	96147514	SSP2170	3W1Z5K484AA	SSP2188	1209035
SSP2142	5087.33	SSP2171	AE5Z5K483A	SSP2188	98AG3B438AD
SSP2143	9808868280	SSP2172	7T4Z5K483A	SSP2188	YS413B438AB
SSP2144	5087.71	SSP2173	7T4Z5A486AA	SSP2189	1106269
SSP2144	5087.74	SSP2174	1513343	SSP2189	YS713B438AA
SSP2145	5087.71*	SSP2174	1745924	SSP2190	1223792



MAGNETI MARELLI	O.E.	MAGNETI MARELLI	O.E.	MAGNETI MARELLI	O.E.
SSP2190	1230909	SSP2208	4C155495AA	SSP2224	1219698
SSP2190	1686594	SSP2208	YL155495AA	SSP2224	1S13B438BA
SSP2190	8623576	SSP2209	3736028 S1	SSP2224	5X433B438AA
SSP2190	3M513B438AB	SSP2210	FR3Z5K483A	SSP2224	C2S26883
SSP2190	AV613B438AA	SSP2211	4042068	SSP2225	1377416
SSP2190	AV613B438BAN	SSP2211	YC155C486AE	SSP2225	1425853
SSP2191	AV613B438AA*	SSP2212	1332463	SSP2225	30760678
SSP2192	1310333	SSP2212	4436609	SSP2225	6G91SC486XAB
SSP2192	1335548	SSP2212	W12T145C486AD	SSP2226	548302S200
SSP2192	30683232	SSP2213	1332453	SSP2227	555302S200
SSP2192	30714466	SSP2213	4367012	SSP2228	5483017020
SSP2192	BP4K28170D	SSP2213	2T143B438BA	SSP2228	5483025020
SSP2192	BP4K28170G	SSP2213	2T143B438BB	SSP2229	5483017010
SSP2192	BP4K28170H	SSP2214	1332453	SSP2229	5483025010
SSP2193	1377849	SSP2214	4367012	SSP2230	555304A001
SSP2193	30648461	SSP2214	2T143B438BA	SSP2230	MR267875
SSP2193	6G9N3B438BA	SSP2214	W12T143B438BA	SSP2231	548404H000
SSP2194	6G9N3B438BA*	SSP2215	4519467	SSP2232	548304H000
SSP2195	1714891	SSP2215	3C113B438AC	SSP2233	555404H000
SSP2195	BV615C486BAA	SSP2216	1763714	SSP2234	555304H000
SSP2196	1500682	SSP2216	BK213B438AA	SSP2235	548300U000
SSP2196	1719542	SSP2217	6960036	SSP2235	548304L000
SSP2196	8M515E494AA	SSP2217	1S713B438AC	SSP2236	55530-2E000
SSP2196	8M515E494AB	SSP2217	2T1Z5K484AA	SSP2237	54830-2E000
SSP2197	AV613B438BA	SSP2217	7T1Z5K484A	SSP2238	54840-1E000
SSP2197	AV6Z5K484B	SSP2217	93BB3B438CA	SSP2238	548401G500
SSP2198	7L1Z5K483B	SSP2218	6960036*	SSP2238	548402C000
SSP2199	AL3Z5K483A	SSP2219	1127648	SSP2239	548301G000
SSP2200	9L3Z5K483D	SSP2219	1S715C486AD	SSP2239	548301G500
SSP2201	5R3Z5C488AA	SSP2220	1103452	SSP2239	548302C000
SSP2202	5R3Z5C488BA	SSP2220	1127648	SSP2240	548401J000
SSP2203	8R3Z5K483A	SSP2220	1S715C486AD	SSP2241	548301J000
SSP2203	8R3Z5K483B	SSP2221	1130452	SSP2242	548302H000
SSP2204	CR3Z5C488Q	SSP2221	1S715C486BE	SSP2242	548302H100
SSP2205	CR3Z5C488R	SSP2222	1127646	SSP2243	548302H000*
SSP2206	1502681	SSP2222	1S713B438AC	SSP2244	555301H000
SSP2206	8V415C486AA	SSP2222	C2S26883	SSP2244	555302H000
SSP2206	CV615C486AAB	SSP2222	SX433B438AA	SSP2245	555303R000
SSP2207	3933468	SSP2223	1117698	SSP2245	555403R000
SSP2207	F75A5C491BA	SSP2223	1127646	SSP2246	548400X000
SSP2208	4041494	SSP2223	C2S26883	SSP2246	54840B4000



MAGNETI MARELLI	O.E.	MAGNETI MARELLI	O.E.	MAGNETI MARELLI	O.E.
SSP2247	548300X000	SSP2277	K01134160A	SSP2308	1693201389*
SSP2247	54830B4000	SSP2278	0K033C3415A	SSP2309	1693200589
SSP2248	545303Z000	SSP2278	OK33C34150A	SSP2310	2043203889
SSP2248	555403Z000	SSP2279	0K33C34160A	SSP2311	2043203889*
SSP2249	548303Z000	SSP2279	OK33C34160A	SSP2312	2043203789
SSP2250	54830C8000	SSP2280	54830FD000	SSP2313	2043203789*
SSP2251	5484026000	SSP2281	54820FD000	SSP2314	2043201889
SSP2251	5484026100	SSP2282	5484007000	SSP2315	2043201789
SSP2252	5483026000	SSP2283	5483007000	SSP2316	2043200489
SSP2252	5483026100	SSP2284	543803U000	SSP2317	2043200589
SSP2253	5553026600	SSP2284	548303U000	SSP2318	2463200489
SSP2254	5554026600	SSP2285	548304L000	SSP2319	2463200089*
SSP2255	548402B000	SSP2286	548402K000	SSP2320	4473200489
SSP2255	548402B200	SSP2287	548302K000	SSP2320	A4473200489
SSP2256	548402B000*	SSP2288	2L1Z5K483AD	SSP2321	4473200389
SSP2257	548302B000	SSP2289	2103202289	SSP2321	A4473200389
SSP2257	548302B200	SSP2289	2103203789	SSP2322	4473200089
SSP2258	548302B000*	SSP2290	2103202189	SSP2322	A4473200089
SSP2259	555302B000	SSP2290	2103203689	SSP2323	4473200289
SSP2259	555302B200	SSP2291	1713230017	SSP2323	A4473200289
SSP2260	548302W000	SSP2292	2123201289*	SSP2324	4473200189
SSP2261	555402W110	SSP2293	2123201189*	SSP2324	A4473200189
SSP2262	555302W100	SSP2294	2123202689	SSP2325	1663200889
SSP2263	52087846	SSP2295	2123202589	SSP2325	A1663200889
SSP2263	52088437	SSP2296	2043202289**	SSP2326	1663200789
SSP2264	52088283	SSP2297	2043200789**	SSP2326	A1663200789
SSP2265	52088319	SSP2298	2463200689	SSP2327	6383230368
SSP2265	52088319AB	SSP2298	A2463200689	SSP2328	6383230268
SSP2266	52087771	SSP2299	2463200789	SSP2329	6383260016
SSP2266	52087771AB	SSP2299	A2463200789	SSP2330	6383260116
SSP2267	52059975AC	SSP2300	1723230217	SSP2331	6383230568
SSP2268	52060011AB	SSP2301	1723230117	SSP2332	6383230468
SSP2269	5151803AA	SSP2302	1723200089	SSP2333	6393201089
SSP2270	54811-3E060	SSP2302	A1723200089	SSP2334	6393200989
SSP2271	54811-3E010	SSP2303	1243200489	SSP2335	6393260216
SSP2272	55580-3E000	SSP2304	1403200889	SSP2335	6393260616
SSP2273	55580-3E050	SSP2304	1403203589	SSP2336	4143200189
SSP2274	54810-3E000	SSP2305	1683200589	SSP2336	4143200289
SSP2275	54830C5000	SSP2305	1683201089	SSP2336	4143200389
SSP2276	55530C5000	SSP2306	1683200389	SSP2337	6393200389
SSP2276	55540C5000	SSP2307	1693200989	SSP2338	6393200289



MAGNETI MARELLI	O.E.	MAGNETI MARELLI	O.E.	MAGNETI MARELLI	O.E.
SSP2339	9013200389	SSP2361	A1633200032	SSP2391	L20634150A
SSP2339	2D0411052	SSP2362	1633200190	SSP2392	BP4K34170C
SSP2340	9013200289	SSP2363	1633200090	SSP2393	BBM234170A
SSP2340	2D0411051	SSP2364	1643201332	SSP2394	B45A34150
SSP2341	9013200089	SSP2365	1643201232	SSP2395	B45A34170
SSP2341	2D0511329	SSP2366	1643202132	SSP2396	KD3128170
SSP2342	9013200589	SSP2367	2203203489	SSP2397	KD3128190
SSP2342	5118696AA	SSP2368	2203203389	SSP2398	L20634150A
SSP2343	9053200589	SSP2369	2203203689	SSP2399	L20634170A
SSP2344	9053200489	SSP2370	2113200889	SSP2400	GJ6A34150A
SSP2345	9063201389	SSP2370	2113203389	SSP2401	GJ6A34170A
SSP2345	2E0511051F	SSP2371	2203201689	SSP2401	GK2A34170
SSP2346	9063201489	SSP2371	A2203201689	SSP2402	5M8Z5A486A
SSP2346	2E0511051G	SSP2372	2203201589	SSP2402	GJ6A28170A
SSP2347	9063201889	SSP2372	A2203201589	SSP2403	GS1D28170
SSP2347	2E0411318C	SSP2373	2113201089	SSP2404	GS1D34150
SSP2348	9063201789	SSP2374	2113200989	SSP2405	GS1D34170
SSP2348	2E0411317C	SSP2375	2213200289	SSP2406	KD3534170
SSP2349	2033202689	SSP2375	2213300289	SSP2407	L20628170A
SSP2349	2033202989	SSP2376	2213200189	SSP2408	TD1134150A
SSP2350	2033201889	SSP2376	2213300189	SSP2409	TD1134170A
SSP2350	2033203089	SSP2377	2213202289	SSP2410	DA5A34170
SSP2351	2033200889	SSP2378	2213201989	SSP2411	MR992310
SSP2352	2033200789	SSP2379	2213201689	SSP2412	MR992309
SSP2353	2033202489	SSP2380	2213201589	SSP2413	MB527385
SSP2353	2033202589	SSP2381	2113204889	SSP2414	4056A014
SSP2353	2033202889	SSP2382	2113204789	SSP2414	MB518982
SSP2354	2033202489	SSP2383	2223201689	SSP2414	MB573043
SSP2355	2053231017	SSP2383	A2223201689	SSP2414	MB892982
SSP2355	A2053231017	SSP2384	2223201789	SSP2415	MB808076
SSP2356	2053230917	SSP2384	A2223201789	SSP2416	MB672370
SSP2356	A2053230917	SSP2385	2223200489	SSP2417	4056A191
SSP2357	2053230817	SSP2386	2223200389	SSP2418	MR954887
SSP2357	A2053230817	SSP2387	2223201089	SSP2419	4056A037
SSP2358	2053230717	SSP2387	A2223201089	SSP2420	5087.58
SSP2358	A2053230717	SSP2388	2223201189	SSP2420	MN101368
SSP2359	2053260417	SSP2388	A2223201189	SSP2421	5178.49
SSP2359	A2053260417	SSP2389	F15128170	SSP2421	MN184194
SSP2360	2053260317	SSP2390	F15134150	SSP2422	4156A014
SSP2360	A2053260317	SSP2390	L20634150A	SSP2422	5178.48
SSP2361	1633200032	SSP2391	F15134170	SSP2423	4056A105



MAGNETI MARELLI	O.E.	MAGNETI MARELLI	O.E.	MAGNETI MARELLI	O.E.
SSP2423	MB267876	SSP2451	54618AX600	SSP2473	54668JD00A
SSP2423	MR374522	SSP2451	551107916R	SSP2474	546183JA0C*
SSP2424	4056A106	SSP2452	54618JX00A	SSP2475	546683JA0B*
SSP2424	MB267877	SSP2452	54618JX30A	SSP2476	350233
SSP2424	MR374521	SSP2453	54618CK000	SSP2476	13391512
SSP2425	4056A37	SSP2454	54668CA000	SSP2477	350610
SSP2425	MR418053	SSP2455	54618CA010	SSP2477	4886606
SSP2426	MR418052	SSP2456	54668CC010	SSP2477	5236823
SSP2427	4056A134	SSP2457	562611AA0A	SSP2477	90496116
SSP2427	MR992192	SSP2458	562611AA0B	SSP2478	350610*
SSP2428	4056A133	SSP2459	5461801F00	SSP2478	4886606*
SSP2428	MR992191	SSP2459	546180W001	SSP2478	5236823*
SSP2429	4056A112	SSP2460	1954821	SSP2479	15779960
SSP2429	MR418053	SSP2460	562600F001	SSP2479	95942520
SSP2430	4056A111	SSP2460	562600W001	SSP2479	350232*
SSP2430	MR418052	SSP2461	54618EA010	SSP2480	15779961
SSP2431	MR272116	SSP2461	7L1Z5K483B	SSP2480	350231*
SSP2432	33551507999	SSP2462	54668EA010	SSP2481	350611
SSP2433	31351507989	SSP2463	56261-0E000	SSP2481	350614
SSP2434	31356759537	SSP2463	56261AV611	SSP2481	90498745
SSP2435	31356759537*	SSP2463	56261AW000	SSP2482	350612
SSP2436	33506772789	SSP2464	56261EA500	SSP2482	13116332
SSP2437	31356778831	SSP2464	9L3Z5K483D	SSP2483	350613
SSP2438	31359806352	SSP2465	56261EA510	SSP2483	24461353
SSP2439	31359806351	SSP2466	546184M400	SSP2484	350603
SSP2440	33509803516	SSP2467	546684U000	SSP2484	350615
SSP2441	33509803515	SSP2468	546184U000	SSP2484	24417251
SSP2442	31306862863	SSP2469	54618CY00A	SSP2485	444275
SSP2443	33506862865	SSP2470	55618 JE20A	SSP2485	25816039
SSP2444	5461850Y00	SSP2470	55618JD00A	SSP2486	13282833
SSP2444	54618D5010	SSP2470	55618JY00B	SSP2487	444081
SSP2445	4526190J01	SSP2471	55619JD00A	SSP2487	13281792
SSP2445	5626186J25	SSP2471	55619JE20A	SSP2488	444087
SSP2446	5461850J20	SSP2471	55619JY00B	SSP2489	350618
SSP2447	54618AU000	SSP2472	546181AA0A	SSP2489	13258052
SSP2448	54668AU000	SSP2472	546181AA0E	SSP2490	350617
SSP2449	562614F702	SSP2472	54618JA000	SSP2490	13219141
SSP2449	562614F725	SSP2472	54618JD00A	SSP2490	C13219141
SSP2450	546189U00A	SSP2473	546681AA0A	SSP2491	39001004
SSP2450	54618BC40A	SSP2473	546681AA0E	SSP2492	39001003
SSP2451	8200127308	SSP2473	54668JA000	SSP2493	350193



MAGNETI MARELLI	O.E.	MAGNETI MARELLI	O.E.	MAGNETI MARELLI	O.E.
SSP2493	13285628	SSP2511	5087.50*	SSP2528	543175784R
SSP2494	350192	SSP2512	5087.76	SSP2529	8201079463
SSP2494	13282834	SSP2513	4500199	SSP2530	8200050191
SSP2495	96288787	SSP2513	9160499	SSP2530	8200714448
SSP2495	5087.45	SSP2513	7700309071	SSP2531	8200040618
SSP2496	96288787	SSP2513	8200713523	SSP2531	8200714446
SSP2496	5087.45	SSP2513	5461800QAA	SSP2532	546187005R
SSP2497	5087.55	SSP2514	4500198	SSP2533	546187005R
SSP2497	5087.68	SSP2514	9160498	SSP2534	6Q0411315A
SSP2498	5087.54	SSP2514	7700309070	SSP2534	6Q0411315C
SSP2498	5087.69	SSP2514	8200713522	SSP2534	6Q0411315D
SSP2499	96177836	SSP2514	5461800QAB	SSP2534	6Q0411315F
SSP2499	96324274	SSP2515	4419291	SSP2535	6Q0411315A
SSP2499	5087.43	SSP2515	93197325	SSP2536	6R0411315
SSP2499	5087.48	SSP2515	546180004R	SSP2537	500411315B
SSP2499	5087.60	SSP2516	546180004R*	SSP2538	4543200010
SSP2500	5087.57	SSP2517	4420954	SSP2538	MR961477
SSP2501	5087.57	SSP2517	93168675	SSP2539	4709702
SSP2502	5087.57	SSP2517	551100020R	SSP2539	4242062J00
SSP2503	9651565180	SSP2518	551100019R	SSP2540	4881006030
SSP2503	5178.46	SSP2519	4153200189	SSP2540	4883033010
SSP2503	5178.52	SSP2519	8200166159	SSP2541	4883006020
SSP2504	5087.53	SSP2519	8200669065	SSP2541	4883006030
SSP2505	5087.52	SSP2519	A4153200189	SSP2541	4883048010
SSP2506	96152213	SSP2520	546180001R	SSP2542	4883060030
SSP2506	5087.42	SSP2521	8200166160	SSP2543	4882060050
SSP2507	5178.18	SSP2521	8200669066	SSP2544	4881060040
SSP2507	5178.22	SSP2522	4408904	SSP2545	4882060032
SSP2507	5178.31	SSP2522	8200002870	SSP2546	488200K030
SSP2507	5178.44	SSP2522	5461600QAC	SSP2547	488100K010
SSP2508	5178.17	SSP2522	546181944R	SSP2548	4881952010
SSP2508	5178.21	SSP2523	4408904	SSP2549	488200D010
SSP2508	5178.30	SSP2523	8200002870	SSP2550	4882042010
SSP2508	5178.43	SSP2523	5461600QAC	SSP2551	4884042010
SSP2509	96347856	SSP2524	8200001857	SSP2552	4882042020
SSP2509	9804947480	SSP2524	8200619922	SSP2553	4883042010
SSP2509	5087.50	SSP2525	546180002R	SSP2554	4883042020
SSP2509	5087.62	SSP2526	546180002R*	SSP2554	4883042021
SSP2509	5087.64	SSP2527	546180002R*	SSP2554	488300R010
SSP2510	9804947480	SSP2528	8200265217	SSP2555	4882002030
SSP2510	9809045780	SSP2528	8200686016	SSP2555	4882002040



MAGNETI MARELLI	O.E.	MAGNETI MARELLI	O.E.	MAGNETI MARELLI	O.E.
SSP2555	4882047010	SSP2580	7H5411317	SSP2596	CV6Z5K484F
SSP2556	4883021020	SSP2580	7H5411317B		
SSP2557	4884021010	SSP2581	7H0411317		
SSP2558	488200K010	SSP2581	7H5411317B*		
SSP2559	4882032010	SSP2582	1009591		
SSP2560	4882074010*	SSP2582	7M0411317D		
SSP2561	4882002070	SSP2582	95VW5489AC		
SSP2561	4882047020	SSP2583	1009591*		
SSP2561	488200R010	SSP2583	95VW5489AC*		
SSP2562	4882035030	SSP2584	6N0411315D		
SSP2562	48820AD010	SSP2585	191411327		
SSP2563	4880260100	SSP2585	191411315A		
SSP2563	4881760010*	SSP2586	6Q0411315G		
SSP2563	90948 02202	SSP2587	6N0411315		
SSP2564	4882060080	SSP2588	6E0411315		
SSP2565	4881060060	SSP2589	30852103		
SSP2566	7L0411317	SSP2589	30884359		
SSP2567	95533307010	SSP2589	M884359		
SSP2567	7L0505466A	SSP2589	MR272118		
SSP2568	95533307011	SSP2590	30871770		
SSP2568	7L0505465A	SSP2590	30873100		
SSP2569	2H0411317	SSP2590	30884358		
SSP2570	2H0411317B	SSP2590	MR131680		
SSP2571	1J0411315C	SSP2591	30620785		
SSP2572	1J0411315H	SSP2591	30818091		
SSP2572	1J0422315G	SSP2591	30818092		
SSP2573	68510018	SSP2592	30620786		
SSP2574	68510017	SSP2592	30884360		
SSP2575	1J0411315K	SSP2593	8672446		
SSP2576	1K0411315B	SSP2593	30647920		
SSP2576	1K0411315D	SSP2593	31201603		
SSP2576	1K0411315J	SSP2594	274303		
SSP2577	1K0505465C	SSP2594	274456		
SSP2577	1K0505465D	SSP2594	30714685		
SSP2577	1K0505465H	SSP2594	31201602		
SSP2577	1K0505465J	SSP2595	274303		
SSP2577	1K0505465K	SSP2595	274456		
SSP2578	2K0505465B	SSP2595	30714685		
SSP2578	2K0505465C	SSP2595	31201602		
SSP2579	5Q0505465A	SSP2596	31317271		
SSP2579	5Q0505465C	SSP2596	31429024		

Tavole di comparazione
Cross reference guide
Gegenüberstellung Cross-Referenzen
Table de correspondance
Tabla de equivalencias
Tabelas de equivalências
Πίνακας αντιστοιχιών
Tabela porównawcza
Кросс-таблица
Çapraz referans tablosu



O.E.	MAGNETI MARELLI	O.E.	MAGNETI MARELLI	O.E.	MAGNETI MARELLI
10945	ARM445	350612	SSP2482	352870	ARM894
10946	ARM444	350613	SSP2483	423008	ARM889
272416	SSP0712	350614	SSP2481	444081	SSP2487
272417	SSP0711	350615	SSP2484	444087	SSP2488
272428	SSP0278	350616	SSP1316	444275	SSP2485
274175	SSP0710	350617	SSP2490	1007602	ARM1071
274176	SSP0709	350618	SSP2489	1009591	SSP2582
274179	SSP0277	352002	ARM869	1012632	ARM1070
274186	SSP1988	352003	ARM870	1028438	ARM527
274193	SSP1988	352004	ARM885	1028443	ARM528
274303	SSP2594	352005	ARM886	1030025	SSP1831
274303	SSP2595	352029	ARM888	1032098	ARM521
274351	SSP0714	352030	ARM887	1032100	ARM523
274352	SSP0713	352041	ARM874	1032101	ARM522
274353	SSP0279	352042	ARM873	1032102	ARM524
274377	SSP1989	352050	ARM895	1032689	SSP0413
274456	SSP2594	352051	ARM118	1034417	SSP0413
274456	SSP2595	352052	ARM117	1044014	SSP0072
274496	SSP0710	352061	ARM874	1047797	SSP1831
274497	SSP0709	352063	ARM873	1058326	ARM517
274498	SSP0714	352071	ARM894	1058332	ARM518
274499	SSP0713	352106	ARM891	1061631	SSP2178
274500	SSP0422	352110	ARM891	1061660	ARM535
274501	SSP0421	352115	ARM890	1061668	ARM536
274523	SSP1989	352492	ARM891	1061702	SSP2186
274544	SSP1988	352493	ARM890	1063985	ARM527
274548	SSP1988	352509	ARM893	1063986	ARM528
274573	SSP1989	352510	ARM892	1063987	ARM525
322155	SSP0186	352522	ARM882	1063988	ARM526
322158	SSP0185	352523	ARM883	1064128	ARM537
324042	SSP0594	352524	ARM884	1071214	ARM538
324050	SSP0594	352532	SSP1800	1071690	ARM519
324066	SSP0595	352542	ARM881	1071702	ARM520
350192	SSP2494	352543	ARM880	1073215	ARM539
350193	SSP2493	352549	ARM893	1074305	SSP0419
350198	SSP1325	352550	ARM892	1074306	SSP0420
350233	SSP2476	352800	SSP1932	1085520	SSP0083
350603	SSP1339	352803	SSP1929	1090730	ARM538
350603	SSP2484	352829	SSP1932	1090738	ARM539
350610	SSP2477	352830	SSP1932	1092378	SSP0706
350611	SSP2481	352869	ARM895	1092380	SSP0707



O.E.	MAGNETI MARELLI	O.E.	MAGNETI MARELLI	O.E.	MAGNETI MARELLI
1103452	SSP2220	1254310	ARM540	1417351	SSP1847
1106269	SSP2189	1254311	ARM541	1420858	ARM544
1107013	SSP0419	1305341	ARM540	1420859	ARM543
1107015	SSP0420	1305342	ARM541	1425853	SSP2225
1111769	SSP2188	1309148	ARM540	1433271	SSP0098
1117698	SSP2223	1309149	ARM541	1433273	SSP0438
1117857	ARM590	1309644	ARM540	1433274	SSP0439
1117859	ARM589	1309645	ARM541	1436095	ARM514
1118920	ARM590	1310333	SSP2192	1436097	ARM513
1118921	ARM589	1311416	ARM587	1457609	ARM594
1124242	ARM591	1311417	ARM588	1469024	ARM596
1127646	SSP2222	1317446	SSP0422	1469026	ARM597
1127646	SSP2223	1317447	SSP0421	1469125	ARM595
1127648	SSP2219	1317453	SSP0084	1470387	SSP1836
1127648	SSP2220	1317609	ARM535	1500111	ARM561
1130273	SSP2178	1328670	ARM540	1500682	SSP2196
1130452	SSP2221	1328671	ARM541	1502440	ARM558
1138314	SSP0437	1328877	SSP0421	1502681	SSP2206
1146130	ARM513	1328881	SSP0422	1502729	ARM557
1146131	ARM514	1329730	ARM535	1507181	ARM596
1146150	SSP2176	1332074	ARM540	1507182	ARM597
1202548	SSP0411	1332075	ARM541	1513343	SSP2174
1202549	SSP0412	1332453	SSP2213	1540724	ARM475
1203093	SSP2187	1332453	SSP2214	1540725	ARM476
1203923	ARM587	1332454	ARM580	1541485	SSP0428
1203924	ARM588	1332455	ARM581	1541488	SSP0429
1206474	ARM591	1332463	SSP2212	1545338	SSP0409
1207974	SSP1835	1335548	SSP2192	1545339	SSP0410
1209035	SSP2188	1348191	ARM540	1545457	SSP0075
1212807	ARM513	1348192	ARM541	1546259	SSP1413
1212808	ARM514	1357017	ARM537	1546260	SSP1412
1212809	SSP1835	1370709	SSP0094	1580517	SSP1313
1214290	ARM586	1370710	SSP0095	1603008	SSP0188
1219698	SSP2224	1370741	SSP0434	1603009	SSP0594
1220005	ARM585	1377416	SSP2225	1603016	SSP0190
1223792	SSP2190	1377449	ARM584	1603018	SSP0184
1230619	ARM585	1377655	SSP0084	1603128	SSP1927
1230909	SSP2190	1377655	SSP0086	1603161	SSP1927
1234382	SSP1837	1377849	SSP2193	1603187	SSP1927
1250339	SSP0078	1381843	ARM584	1603202	SSP1928
1251937	SSP0084	1388549	SSP0422	1603213	SSP0195

O.E.	MAGNETI MARELLI	O.E.	MAGNETI MARELLI	O.E.	MAGNETI MARELLI
1603214	SSP0600	1609213	SSP0033	1793236	ARM562
1603215	SSP0601	1609457	SSP1421	1793237	ARM563
1603216	SSP0195	1609458	SSP1419	1802974	SSP0415
1603227	SSP1449	1639574	ARM531	1802977	SSP0416
1603228	SSP1448	1639575	ARM530	1817752	SSP1849
1603229	SSP1393	1661237	SSP2178	1817754	SSP1848
1603239	SSP0189	1679376	SSP1851	1824228	SSP0080
1603244	SSP0198	1679382	SSP1833	1826501	SSP0423
1603257	SSP0602	1686184	ARM542	1826505	SSP0424
1603258	SSP0603	1686594	SSP2190	1828699	ARM578
1603264	SSP0196	1702970	ARM549	1828700	ARM579
1603266	SSP0603	1702983	ARM550	1831354	ARM582
1603267	SSP0602	1703145	ARM536	1831355	ARM583
1603287	SSP0197	1714484	SSP0092	1834054	ARM551
1603288	SSP0602	1714576	SSP0423	1834055	ARM552
1603289	SSP0603	1714700	SSP0424	1836649	SSP0085
1603358	SSP0196	1714891	SSP2195	1899978	SSP0085
1603384	SSP0198	1715414	SSP0092	1927131	ARM564
1603416	SSP0198	1719019	ARM548	1927132	ARM565
1603428	SSP0189	1719542	SSP2196	1933100	ARM573
1603543	SSP1392	1723323	ARM559	1954821	SSP2460
1603544	SSP1421	1723324	ARM560	2601671	SSP0715
1603545	SSP1419	1737305	ARM512	2601672	SSP0716
1603642	SSP0197	1737309	ARM511	2741910	SSP0714
1603843	SSP0184	1745924	SSP2174	2992593	SSP1388
1603844	SSP0187	1748237	SSP0423	3302242	SSP1204
1603845	SSP0188	1748239	SSP0424	3345797	SSP0165
1609011	SSP0193	1749992	ARM547	3707333	SSP0083
1609012	SSP0602	1749993	ARM546	3903147	SSP0097
1609013	SSP0603	1751952	ARM551	3933468	SSP2207
1609026	SSP0604	1751955	ARM552	4011886	SSP0334
1609027	SSP0199	1752736	ARM542	4011887	SSP0333
1609029	SSP0200	1753556	ARM536	4041494	SSP2208
1609181	SSP0035	1754076	SSP0085	4042022	ARM574
1609183	SSP0036	1763714	SSP2216	4042023	ARM575
1609184	SSP0201	1763989	SSP0436	4042068	SSP2211
1609187	SSP0204	1763991	SSP0096	4047091	SSP0434
1609203	SSP0598	1780102	SSP0423	4048739	SSP0077
1609205	SSP0194	1780103	SSP0424	4059923	SSP0094
1609206	SSP0599	1780104	SSP0092	4059924	SSP0095
1609211	SSP1367	1782008	ARM598	4120734	SSP1846



O.E.	MAGNETI MARELLI	O.E.	MAGNETI MARELLI	O.E.	MAGNETI MARELLI
4173761	SSP1846	4500090	SSP1946	4808603	SSP0041
4318655	SSP1379	4500198	SSP2514	4817539	SSP2123
4342539	SSP0076	4500199	SSP2513	4852171	SSP0170
4366973	ARM580	4500254	SSP1948	4852172	SSP0170
4366974	ARM581	4500255	SSP1947	4883083	SSP0191
4367012	SSP2213	4501261	SSP0220	4886606	SSP2477
4367012	SSP2214	4501261	SSP1948	5051316	SSP1185
4371925	ARM580	4501262	SSP0634	5182780	SSP2183
4371926	ARM581	4501263	SSP0633	5182818	SSP2184
4381840	SSP0435	4519467	SSP2215	5231683	SSP1932
4400048	ARM942	4520084	ARM037	5235650	SSP1449
4401910	SSP1946	4520085	ARM037	5235668	SSP1448
4402644	SSP1187	4540774	ARM574	5236823	SSP2477
4402649	SSP1187	4540775	ARM575	5239314	SSP1449
4402672	ARM150	4577976	SSP0095	5239322	SSP1448
4404047	ARM943	4602028	SSP0094	5272190	SSP1302
4408138	ARM149	4616922	ARM444	5352011	ARM872
4408474	SSP0225	4616923	ARM445	5352012	ARM871
4408510	SSP0642	4616978	SSP1846	5352016	ARM886
4408511	SSP0641	4694760	ARM139	5352017	ARM885
4408904	SSP2522	4694761	ARM140	5352025	SSP1931
4408904	SSP2523	4701744	SSP0597	5352026	SSP1930
4412936	SSP1954	4701745	SSP0191	5352027	ARM876
4417177	ARM959	4705172	ARM877	5352028	ARM875
4417178	ARM958	4705655	SSP0597	5352038	ARM880
4418629	ARM945	4705716	SSP0597	5352039	ARM881
4418630	ARM944	4705742	ARM037	5451030	ARM632
4418631	SSP1949	4706665	ARM037	5452030	ARM631
4419215	ARM947	4707280	ARM037	5958244	SSP1361
4419216	ARM946	4708299	ARM993	5958246	SSP1409
4419219	SSP1950	4708300	ARM994	5960036	SSP1437
4419291	SSP2515	4709161	SSP0249	5960037	SSP1437
4420097	SSP0636	4709195	SSP0665	5960056	SSP1437
4420098	SSP0635	4709702	SSP2539	5960321	SSP0071
4420954	SSP2517	4762861	SSP1407	5960835	SSP1411
4421646	ARM956	4766542	ARM434	5983404	SSP1409
4421647	ARM957	4766543	ARM435	5983406	SSP1409
4436609	SSP2212	4797706	SSP1405	5995503	ARM149
4443405	SSP1184	4803429	SSP0354	6606030	SSP0202
4449553	SSP1184	4804642	SSP2123	6606031	SSP0604
4472940	SSP0076	4808602	SSP0041	6790700	SSP0077

O.E.	MAGNETI MARELLI	O.E.	MAGNETI MARELLI	O.E.	MAGNETI MARELLI
6960036	SSP2217	9160555	SSP1947	9949217	SSP1376
7076231	SSP1355	9161561	SSP1948	9949218	SSP1426
7079382	SSP1371	9161562	SSP0634	9950452	SSP1367
7079383	SSP1372	9161563	SSP0633	10403402	SSP2097
7081835	SSP1193	9196394	SSP1929	12380415	SSP1811
7081851	SSP1373	9204751	SSP0597	12383410	SSP1811
7082812	SSP1194	9210168	SSP0597	12475485	SSP1793
7294416	SSP0097	9210270	ARM037	12475486	SSP1793
7362503	SSP1439	9214826	ARM037	12542993	SSP2091
7543760	ARM472	9214829	ARM878	12574521	SSP1314
7591277	ARM472	9214832	ARM879	12796013	ARM118
7601057	ARM156	9351837	SSP1201	12796014	ARM117
7601062	ARM155	9492105	ARM1081	12799200	ARM117
7601261	ARM150	9492106	ARM1080	12799200	ARM118
7601642	SSP1314	9613696	SSP1815	12804238	SSP0198
7601643	SSP1314	9941625	SSP1362	13105744	ARM889
7633721	SSP1361	9944452	SSP1346	13116332	SSP2482
7636995	ARM002	9944452	SSP1367	13219141	SSP2490
7636996	ARM001	9945385	SSP1382	13258052	SSP2489
7658273	SSP1358	9945562	SSP1364	13258056	SSP1792
7669756	SSP1437	9945836	SSP1382	13258056	SSP1808
7674825	ARM472	9945836	SSP1383	13271996	SSP0202
7678717	SSP1398	9946948	SSP1363	13272000	SSP0604
7678718	SSP1399	9946949	SSP1416	13272001	SSP0610
7701491	SSP1363	9947361	SSP1345	13272002	SSP0609
7750977	ARM486	9947435	SSP1399	13272605	ARM891
7750978	ARM485	9947436	SSP1414	13272606	ARM890
7752285	SSP1416	9947437	SSP1399	13278359	SSP0604
7840452	SSP0594	9947438	SSP1414	13281792	SSP2487
8623576	SSP2190	9947438	SSP1415	13282833	SSP2486
8623955	ARM1081	9947439	SSP1415	13282834	SSP2494
8623957	ARM1083	9947713	SSP1365	13285628	SSP2493
8623958	ARM1082	9947714	SSP1417	13286686	SSP0604
8649541	ARM1081	9947719	SSP1417	13286687	SSP0199
8649542	ARM1080	9947719	SSP1418	13307435	SSP0480
8649543	ARM1083	9947919	SSP1402	13307735	SSP0480
8649544	ARM1082	9947920	SSP1401	13314465	SSP0200
8672446	SSP2593	9947923	SSP1347	13321338	ARM891
9118128	SSP0195	9947926	SSP1418	13321339	ARM890
9160498	SSP2514	9948297	SSP1348	13332651	SSP0035
9160499	SSP2513	9948343	SSP1366	13332653	SSP0036



O.E.	MAGNETI MARELLI	O.E.	MAGNETI MARELLI	O.E.	MAGNETI MARELLI
13334022	ARM368	19122185	SSP1806	22913275	SSP0352
13334023	ARM367	19133638	SSP1797	22913276	SSP0353
13334023	ARM890	19133669	SSP1807	22913277	SSP0040
13354538	SSP0608	19133670	SSP1796	22947663	ARM369
13354540	SSP0607	19149839	SSP0030	22947664	ARM370
13354596	SSP0346	19149840	SSP0337	23461856	ARM403
13354598	SSP0345	19178561	SSP0046	23868906	SSP0044
13354600	SSP0037	19207056	SSP0031	24417251	SSP1339
13391512	SSP2476	19207057	SSP0339	24417251	SSP2484
13464344	SSP0203	19207521	SSP1814	24428977	ARM874
14013040	SSP1907	19208276	SSP0355	24428978	ARM873
15089907	SSP2119	19209396	SSP1813	24454477	ARM888
15129234	SSP2136	19210063	SSP0032	24454478	ARM887
15146379	SSP2103	19210064	SSP0338	24461353	SSP2483
15148024	ARM402	19210782	SSP1805	24510351	SSP0358
15167956	SSP2117	19258791	SSP1799	24510351	SSP0359
15167957	SSP2116	20774419	ARM404	25747956	SSP2118
15196858	SSP2115	20817752	SSP0047	25786774	ARM401
15218267	SSP2104	20822934	SSP2120	25786775	ARM400
15218268	SSP2105	20905104	SSP2135	25816039	SSP2485
15232855	SSP2114	20945779	ARM377	25878028	ARM373
15254061	SSP0364	20945780	ARM376	25878029	ARM374
15257472	SSP2134	20951300	ARM395	25918049	SSP2133
15292910	ARM386	20951301	ARM394	25956921	SSP0361
15292911	ARM387	20961222	SSP2112	25995438	ARM405
15293664	ARM369	20985982	SSP2098	25997509	ARM399
15293665	ARM370	21011027	SSP0357	25997510	ARM398
15697702	SSP2121	22113159	SSP1806	26030411	SSP0186
15779960	SSP2479	22145460	SSP1806	26057931	SSP0363
15779961	SSP2480	22156500	SSP1806	26086579	SSP0330
15851956	SSP2113	22157320	SSP1797	26086580	SSP0331
15869897	SSP0365	22670300	SSP2111	26087867	SSP0188
15918822	SSP2099	22678193	ARM375	26087868	SSP0594
15918823	SSP2100	22710259	SSP2131	26095458	SSP0362
15926031	SSP2106	22730775	ARM387	26095475	SSP0350
15944090	SSP0344	22730776	ARM386	26100286	SSP0334
15961007	SSP2132	22776539	SSP0332	26100287	SSP0333
15963924	SSP2118	22810912	SSP2092	26110429	SSP0190
15991383	SSP2122	22854825	ARM385	26144989	SSP1377
16032240	SSP0596	22854826	ARM384	30620785	SSP2591
16032440	SSP0596	22900200	SSP2127	30620786	SSP2592

O.E.	MAGNETI MARELLI	O.E.	MAGNETI MARELLI	O.E.	MAGNETI MARELLI
30635227	ARM1081	31200448	ARM597	36012457	ARM1083
30635228	ARM1080	31201004	ARM1085	36012458	ARM1082
30635229	ARM1083	31201180	ARM543	39001003	SSP2492
30635230	ARM1082	31201602	SSP2594	39001004	SSP2491
30639780	ARM1085	31201602	SSP2595	39008083	SSP0605
30645845	ARM1085	31201603	SSP2593	39008084	SSP0606
30647920	SSP2593	31202228	ARM1088	39021472	ARM897
30648461	SSP2193	31202229	ARM1084	39021473	ARM896
30666105	ARM537	31202485	SSP1989	42534911	SSP1438
30683232	SSP2192	31262037	ARM543	46402681	ARM486
30683248	ARM1088	31262039	ARM544	46402682	ARM485
30683249	ARM1084	31277343	ARM597	46413122	SSP1315
30714442	ARM544	31277344	ARM596	46423822	ARM042
30714466	SSP2192	31277346	ARM1084	46423823	ARM041
30714685	SSP2594	31277462	ARM543	46430002	ARM486
30714685	SSP2595	31277463	ARM544	46430003	ARM485
30723103	SSP0422	31277525	ARM1087	46437951	SSP1189
30723104	SSP0421	31277526	ARM1086	46437959	SSP1191
30760678	SSP2225	31277620	ARM1091	46454595	ARM134
30760720	ARM597	31277621	ARM1090	46454596	ARM133
30761718	SSP0709	31277675	ARM536	46454597	ARM148
30761719	SSP0710	31280001	SSP0438	46454598	ARM147
30776248	SSP0438	31280001	SSP0439	46454599	SSP1191
30776249	SSP0439	31280408	SSP0281	46456049	ARM008
30776283	SSP0084	31280409	SSP0280	46456050	ARM007
30818091	SSP2591	31302344	SSP0716	46456189	SSP1425
30818092	SSP2591	31302345	SSP0715	46456660	SSP1424
30852103	SSP2589	31304045	ARM1085	46462049	SSP1319
30870695	SSP0552	31317271	SSP2596	46522147	ARM019
30870695	SSP0708	31317662	ARM596	46525407	ARM020
30871770	SSP2590	31317663	ARM1088	46527567	SSP1417
30873100	SSP2590	31317664	ARM1084	46527567	SSP1418
30875012	SSP0552	31317665	ARM1087	46539279	ARM489
30875012	SSP0708	31317666	ARM1086	46543045	SSP1193
30881487	ARM1087	31317779	SSP0092	46545660	ARM096
30881488	ARM1086	31317781	SSP0718	46545661	ARM095
30884358	SSP2590	31317819	SSP0717	46546278	ARM490
30884359	SSP2589	31340231	ARM1090	46546776	ARM490
30884360	SSP2592	31340232	ARM1091	46546777	ARM489
30887653	ARM1079	31429024	SSP2596	46549529	SSP1318
30887654	ARM1078	31451036	SSP0281	46551732	ARM096



O.E.	MAGNETI MARELLI	O.E.	MAGNETI MARELLI	O.E.	MAGNETI MARELLI
46551790	ARM095	50703296	SSP1312	51717001	SSP1322
46739116	SSP1318	50703296	SSP2162	51727863	ARM113
46764746	ARM020	50704306	ARM062	51741130	SSP1339
46764747	ARM019	50704307	ARM063	51748652	ARM117
46767267	SSP1321	50704361	SSP1289	51748653	ARM118
46777741	ARM111	50704362	SSP1291	51769073	ARM111
46777742	ARM112	50704480	ARM123	51769074	ARM112
46779293	SSP1194	50704671	SSP1309	51769076	ARM114
46794065	ARM111	50704702	SSP1288	51772988	ARM135
46794066	ARM112	50704947	ARM124	51772992	ARM136
46799278	SSP1322	50704948	ARM123	51783056	ARM059
46802680	SSP1182	50705083	ARM154	51783056	SSP1188
46802682	SSP1181	50705084	ARM153	51783057	ARM058
46842581	SSP1194	50705311	SSP1288	51783057	SSP1188
46843389	SSP2031	50705464	ARM068	51787336	ARM123
46989683	SSP0198	50705465	ARM070	51787337	ARM124
48810830	SSP0597	50705629	SSP1201	51795269	SSP2168
50509339	ARM003	50705702	SSP2030	51795446	ARM063
50509340	ARM004	50705703	SSP1287	51795447	ARM062
50513442	ARM246	50705703	SSP2029	51795454	SSP1289
50513444	ARM247	50705712	SSP1287	51795455	SSP1291
50515274	SSP1299	50706463	SSP1192	51795705	SSP1288
50515275	SSP1298	50706858	ARM062	51801136	SSP1313
50515276	SSP1297	50706859	ARM063	51801136	SSP1323
50515276	SSP1316	50706957	SSP1311	51801136	SSP2168
50519427	SSP1349	50706990	SSP1289	51805870	SSP1297
50520352	SSP1404	50706991	SSP1291	51806608	SSP1299
50520353	SSP1403	50707316	ARM062	51806609	SSP1298
50521026	SSP1349	50707317	ARM063	51810664	ARM115
50521639	SSP1349	50707481	ARM124	51810665	ARM116
50526421	SSP1349	50709579	ARM476	51815479	SSP1317
50700464	SSP1323	50709580	ARM475	51815479	SSP2167
50700464	SSP2168	50710620	ARM476	51827736	ARM068
50700779	ARM017	50710621	ARM475	51827737	ARM070
50700797	ARM018	50711394	ARM074	51828660	ARM061
50701379	ARM081	50711395	ARM073	51828661	ARM060
50701380	ARM082	51701045	SSP1315	51834093	ARM120
50703128	ARM090	51706474	SSP1287	51834094	ARM119
50703129	ARM089	51712407	ARM111	51835397	ARM060
50703231	ARM075	51712408	ARM112	51835398	ARM061
50703232	ARM076	51717000	SSP1321	51848645	SSP1325

O.E.	MAGNETI MARELLI	O.E.	MAGNETI MARELLI	O.E.	MAGNETI MARELLI
51849600	ARM473	52088466	SSP0466	60678134	ARM004
51849602	ARM474	52088467	SSP0467	60678135	ARM003
51856872	SSP1312	53403319	SSP2164	60686891	ARM004
51856872	SSP2162	55172401	SSP1369	60686892	ARM003
51856873	SSP1311	55700753	SSP1316	60806355	SSP1414
51857133	ARM090	55700753	SSP2166	60806356	SSP1415
51857134	ARM089	55703230	ARM881	60809813	ARM008
51866700	ARM111	55703231	ARM880	60809814	ARM007
51885660	ARM477	55703627	ARM059	60813013	ARM488
51885737	ARM478	55703629	ARM058	60813014	ARM487
51890706	ARM471	59588244	SSP1353	60813043	ARM488
51890709	ARM470	60565705	SSP1398	60813044	ARM487
51895366	ARM059	60565706	SSP1399	68510017	SSP2574
51895367	ARM058	60570627	SSP1314	68510018	SSP2573
51898527	SSP1325	60586771	ARM008	71742688	SSP1343
51905057	ARM471	60586772	ARM007	71742731	ARM995
51905058	ARM470	60613575	SSP1293	71742732	ARM996
51928536	ARM474	60614514	SSP1343	71742770	SSP1452
51928537	ARM473	60622623	ARM122	71768151	ARM995
51939751	ARM479	60622624	ARM121	71768151	ARM996
51939755	ARM480	60625029	SSP1292	77362278	SSP1451
51939949	SSP2163	60625029	SSP2031	77362279	SSP1432
51942168	SSP2164	60627290	ARM126	77362280	SSP1384
51945321	SSP1826	60627291	ARM125	77362380	SSP1386
51956709	ARM470	60628255	SSP1295	77362381	SSP1435
51956712	ARM471	60628284	SSP1296	77362502	SSP1389
51957400	ARM473	60629903	SSP1181	77362503	SSP1439
51957401	ARM474	60630757	SSP1294	77362506	SSP1356
51959820	ARM483	60651934	ARM121	77362507	SSP1413
51961341	ARM484	60651935	ARM122	77362508	SSP1412
51978679	SSP1298	60651939	ARM120	77363706	SSP1397
51978680	SSP1299	60651940	ARM119	77363707	SSP1396
52005739	SSP1441	60652167	SSP1182	77363829	SSP1421
52011612	ARM481	60652465	ARM004	77363830	SSP1419
52011614	ARM482	60652466	ARM003	77364009	SSP1433
52026562	SSP1827	60653551	ARM128	77364253	SSP1434
52087771	SSP2266	60657245	ARM120	77364568	SSP1423
52087846	SSP2263	60657246	ARM119	77364569	SSP1422
52088283	SSP2264	60665804	ARM126	77365223	SSP1428
52088319	SSP2265	60665805	ARM125	77365224	SSP1427
52088437	SSP2263	60666020	ARM127	77365815	SSP0399



O.E.	MAGNETI MARELLI	O.E.	MAGNETI MARELLI	O.E.	MAGNETI MARELLI
77366165	SSP0401	93181230	SSP0196	95017035	ARM379
77366166	SSP0400	93181232	SSP0603	95017036	ARM378
77366698	SSP0403	93181233	SSP0602	95025704	ARM882
77366699	SSP0402	93186330	SSP0197	95025705	ARM883
77367379	SSP0404	93186332	SSP0602	95025706	ARM884
82461081	ARM042	93186333	SSP0603	95028039	SSP1934
82461082	ARM041	93189022	SSP1392	95069129	SSP0051
83500202	SSP1861	93189669	SSP0196	95218373	SSP0341
88955488	SSP0351	93190907	SSP1188	95319215	ARM397
88965470	SSP2101	93192417	SSP0596	95319216	ARM396
88965471	SSP2102	93192420	SSP0187	95465758	SSP2107
88967431	SSP1812	93192421	SSP0188	95493208	SSP0612
88982342	SSP2101	93194853	ARM945	95511247	SSP1325
88982343	SSP2102	93194855	ARM944	95658882	ARM413
89040241	SSP1803	93196540	SSP1367	95658883	ARM412
89047756	SSP0347	93196777	SSP0192	95658884	ARM410
90166394	SSP1927	93196778	SSP0193	95658885	ARM411
90496039	ARM886	93197214	ARM947	95658978	ARM899
90496040	ARM885	93197233	SSP1950	95658979	ARM898
90496116	SSP2477	93197325	SSP2515	95668511	ARM412
90498745	SSP2481	93296756	SSP0611	95914910	SSP0598
90512982	SSP1932	93388568	ARM876	95916024	SSP1800
90539896	SSP1928	93388569	ARM875	95932779	SSP0598
91160043	SSP0642	93388624	SSP0043	95932789	SSP0194
91160044	SSP0641	93501180	ARM156	95942520	SSP2479
91166641	ARM956	93501181	ARM155	95947829	SSP2130
91166642	ARM957	93501485	ARM018	95952782	ARM397
91174753	SSP0366	93501486	ARM017	95952783	ARM396
91174754	SSP0367	93501487	ARM036	95952929	SSP0033
91175548	SSP0048	93501488	ARM035	95952930	SSP0340
92119830	SSP1794	93740621	SSP0038	95967285	SSP0360
92227430	SSP0042	93740623	SSP0342	95967294	SSP0045
92236898	ARM392	93740701	SSP0027	96025445	SSP1816
92236899	ARM393	93740710	SSP0328	96032460	SSP0056
92241266	SSP0356	93740710	SSP0329	96035445	SSP1815
92243928	SSP2128	93740722	SSP0336	96048214	SSP0050
92243929	SSP2129	93740723	SSP0335	96061907	SSP0034
93168675	SSP2517	93802209	SSP2139	96080894	SSP2141
93172256	SSP1393	93807545	SSP1204	96087507	SSP1938
93179558	SSP0602	93853464	ARM959	96093233	SSP1817
93179559	SSP0603	93853465	ARM958	96136394	SSP0206

O.E.	MAGNETI MARELLI	O.E.	MAGNETI MARELLI	O.E.	MAGNETI MARELLI
96145457	SSP2138	96561754	SSP2110	1243507706	ARM667
96145457	SSP2140	96626150	SSP2123	1300473080	SSP1197
96147514	SSP2142	96626150	SSP2124	1300473080	SSP1199
96152213	SSP2506	96626521	SSP0041	1300716080	SSP1327
96177836	SSP2139	96626525	SSP0041	1302368080	SSP1196
96177836	SSP2499	96626667	SSP0354	1302368080	SSP1198
96225858	SSP2094	96639910	SSP2095	1306003080	SSP1429
96225859	SSP2093	96639910	SSP2096	1306716080	SSP1431
96233739	SSP1934	96852964	SSP1808	1308600080	ARM026
96261108	SSP1804	96870465	ARM372	1308601080	ARM025
96261378	SSP0349	96870466	ARM371	1308664080	SSP1326
96261379	SSP0348	96970076	ARM365	1308759080	ARM028
96288787	SSP2495	96970077	ARM366	1308760080	ARM027
96288787	SSP2496	96996460	SSP2123	1313083080	ARM024
96316765	ARM877	96996460	SSP2124	1313084080	ARM023
96324274	SSP2499	98810139	ARM113	1316735080	ARM024
96328437	SSP1794	98810140	ARM114	1316736080	ARM023
96328437	SSP1795	98845024	SSP1374	1317238080	ARM028
96347856	SSP2509	98845026	SSP1375	1317239080	ARM027
96389491	ARM364	98845030	SSP1417	1317240080	ARM026
96389492	ARM363	98845031	SSP1424	1317241080	ARM025
96391850	ARM381	98845032	SSP1425	1317389080	ARM024
96391851	ARM380	98845878	SSP1378	1317390080	ARM023
96391875	SSP2153	171419812	SSP0698	1317425080	SSP1326
96391876	SSP2110	191411327	SSP2585	1322663080	ARM024
96403099	SSP2109	191419811	SSP0699	1322664080	ARM023
96403100	SSP2108	191419812	SSP0698	1331209080	SSP1341
96407485	SSP0343	488108300	SSP0597	1331640080	SSP1198
96407486	SSP0342	500310933	SSP2140	1331641080	SSP1199
96415063	ARM381	500379801	ARM498	1331937080	ARM494
96415064	ARM380	500379802	ARM497	1331938080	ARM492
96422220	ARM389	500383975	SSP1332	1331940080	ARM491
96423324	ARM388	500383976	SSP1333	1339460080	ARM493
96436597	ARM383	504212584	SSP1828	1346384080	ARM036
96436598	ARM382	504212586	SSP1828	1346385080	ARM035
96445783	SSP1795	542410095	SSP1197	1352225080	ARM091
96490218	SSP1801	561423810	SSP0268	1352226080	ARM093
96535081	ARM372	1160310016	SSP0267	1352227080	ARM092
96535082	ARM371	1243200489	SSP2303	1352228080	ARM094
96535089	SSP1798	1243500129	ARM672	1355440080	SSP1329
96535300	SSP0029	1243507606	ARM669	1355449080	SSP1329



O.E.	MAGNETI MARELLI	O.E.	MAGNETI MARELLI	O.E.	MAGNETI MARELLI
1400099680	SSP1331	1633500453	ARM725	1683201089	SSP2305
1401381380	SSP1387	1633500553	ARM726	1683300807	ARM675
1403200889	SSP2304	1633500653	ARM725	1683300907	ARM674
1403203589	SSP2304	1633520401	ARM724	1683301135	SSP0496
1471654080	SSP1382	1633520501	ARM723	1683301235	SSP0495
1471655080	SSP1431	1643201232	SSP2365	1683301335	SSP0130
1497407080	ARM073	1643201332	SSP2364	1683301535	SSP0496
1497408080	ARM074	1643202132	SSP2366	1683301635	SSP0495
1497550080	SSP1387	1643300935	SSP1889	1683302307	ARM675
1563300100	ARM785	1643301103	SSP0526	1683302407	ARM674
1563300200	ARM784	1643301203	SSP0525	1683330127	SSP1877
1563300500	ARM785	1643301707	ARM728	1683330227	SSP1877
1563300600	ARM784	1643301807	ARM727	1693200589	SSP2309
1606293080	ARM820	1643302507	ARM728	1693200989	SSP2307
1607502480	SSP0553	1643302607	ARM727	1693300403	SSP0131
1608025180	SSP0624	1643302907	ARM728	1693300503	SSP0498
1608025280	SSP0623	1643303007	ARM727	1693300507	ARM677
1608025380	SSP0211	1643303407	ARM728	1693300603	SSP0497
1608652180	SSP0054	1643303507	ARM727	1693300607	ARM676
1608652280	SSP0618	1643500053	ARM729	1693300703	SSP0131
1608652380	SSP0617	1643501306	ARM731	1693300907	ARM677
1610817680	SSP0053	1643501406	ARM732	1693301007	ARM676
1610817780	SSP0628	1643501606	ARM730	1693330127	SSP1878
1610817880	SSP0627	1643520127	SSP1890	1704630015	SSP0002
1611242380	SSP0215	1643530327	SSP1890	1713230017	SSP2291
1633200032	SSP2361	1644600005	SSP0144	1713380015	SSP0126
1633200090	SSP2363	1663200789	SSP2326	1723200089	SSP2302
1633200190	SSP2362	1663200889	SSP2325	1723230117	SSP2301
1633300035	SSP1887	1663300107	ARM692	1723230217	SSP2300
1633300103	SSP0524	1663300207	ARM691	2013500653	ARM666
1633300135	SSP1887	1663300235	SSP1881	2013502753	ARM666
1633300403	SSP0523	1663300403	SSP0508	2013503153	ARM666
1633330001	ARM722	1663301707	ARM690	2013503253	ARM666
1633330101	ARM721	1663301807	ARM689	2013504706	ARM671
1633380205	SSP0143	1663380315	SSP0135	2013505606	ARM671
1633380215	SSP0143	1663500053	ARM729	2023304907	ARM654
1633500013	SSP1888	1663500106	ARM694	2023330027	SSP1874
1633500053	ARM726	1663500206	ARM693	2033200789	SSP2352
1633500113	SSP1888	1663500306	ARM688	2033200889	SSP2351
1633500153	ARM725	1683200389	SSP2306	2033201889	SSP2350
1633500353	ARM726	1683200589	SSP2305	2033202489	SSP2353

O.E.	MAGNETI MARELLI	O.E.	MAGNETI MARELLI	O.E.	MAGNETI MARELLI
2033202489	SSP2354	2043304411	ARM707	2054600805	SSP0142
2033202589	SSP2353	2043306711	ARM710	2073300500	SSP0128
2033202689	SSP2349	2043306811	ARM709	2083301307	ARM655
2033202889	SSP2353	2043308011	ARM663	2083301407	ARM654
2033202989	SSP2349	2043308111	ARM665	2103202189	SSP2290
2033203089	SSP2350	2043308211	ARM664	2103202289	SSP2289
2033300111	ARM708	2043308711	ARM719	2103203689	SSP2290
2033300211	ARM707	2043308811	ARM718	2103203789	SSP2289
2033301611	ARM708	2043380015	SSP0140	2103300035	SSP1874
2033301711	ARM707	2043380515	SSP0147	2103300435	SSP1874
2033301903	SSP0518	2043500029	ARM717	2103303407	ARM653
2033301911	ARM705	2043500553	ARM716	2103303507	ARM652
2033302003	SSP0517	2043500653	ARM715	2103304507	ARM652
2033302011	ARM706	2043501506	ARM712	2103304807	ARM655
2033302303	SSP0518	2043501606	ARM711	2103305107	ARM654
2033302403	SSP0517	2043502106	ARM714	2103306107	ARM653
2033303303	SSP0504	2043502206	ARM713	2103306207	ARM652
2033303311	ARM705	2043502706	ARM717	2103307607	ARM653
2033303403	SSP0503	2043503006	ARM712	2103307707	ARM652
2033303411	ARM706	2043503106	ARM711	2103308707	ARM655
2033303511	ARM708	2053230717	SSP2358	2103308807	ARM654
2033303611	ARM707	2053230817	SSP2357	2103309007	ARM653
2033303911	ARM708	2053230917	SSP2356	2103309107	ARM652
2033304011	ARM707	2053231017	SSP2355	2103380415	SSP0125
2043200489	SSP2316	2053260317	SSP2360	2103380515	SSP0482
2043200589	SSP2317	2053260417	SSP2359	2103380615	SSP0481
2043201789	SSP2315	2053301305	ARM789	2103380915	SSP0488
2043201889	SSP2314	2053301405	ARM788	2103381015	SSP0487
2043203789	SSP2312	2053301505	ARM789	2103500029	ARM672
2043203889	SSP2310	2053301605	ARM788	2103500653	ARM666
2043300903	SSP0486	2053305501	ARM787	2103501606	ARM669
2043301003	SSP0485	2053305601	ARM786	2103501706	ARM667
2043301903	SSP0494	2053305801	ARM720	2103505007	ARM655
2043302003	SSP0493	2053305901	ARM791	2113200889	SSP2370
2043303111	ARM710	2053306001	ARM790	2113200989	SSP2374
2043303211	ARM709	2053506303	ARM717	2113201089	SSP2373
2043303303	SSP0484	2054600005	SSP0520	2113203389	SSP2370
2043303403	SSP0483	2054600105	SSP0519	2113204789	SSP2382
2043304311	ARM679	2054600405	SSP0141	2113204889	SSP2381
2043304311	ARM708	2054600605	SSP0522	2113230068	SSP1892
2043304411	ARM678	2054600705	SSP0521	2113300103	SSP0531



O.E.	MAGNETI MARELLI	O.E.	MAGNETI MARELLI	O.E.	MAGNETI MARELLI
2113300203	SSP0530	2123302703	SSP0513	2203500453	ARM737
2113300235	SSP1891	2123302711	ARM659	2203502206	ARM738
2113300335	SSP1874	2123302803	SSP0129	2203502406	ARM739
2113300427	SSP1893	2123302811	ARM658	2203502606	ARM740
2113300435	SSP1891	2123302911	ARM661	2203520003	ARM737
2113301111	ARM745	2123303011	ARM660	2203521105	ARM738
2113301211	ARM746	2124600105	SSP0514	2213200189	SSP2376
2113301511	ARM745	2124600205	SSP0513	2213200289	SSP2375
2113301611	ARM746	2153300307	ARM792	2213201589	SSP2380
2113302303	SSP0531	2153300706	ARM792	2213201689	SSP2379
2113302403	SSP0530	2153300707	ARM792	2213201989	SSP2378
2113302903	SSP0148	2203201589	SSP2372	2213202289	SSP2377
2113302911	ARM745	2203201689	SSP2371	2213300189	SSP2376
2113303011	ARM746	2203203389	SSP2368	2213300241	ARM760
2113304307	ARM752	2203203489	SSP2367	2213300289	SSP2375
2113304311	ARM745	2203203689	SSP2369	2213300307	ARM767
2113304407	ARM751	2203230368	SSP1892	2213300407	ARM766
2113304411	ARM746	2203300727	SSP1891	2213301603	SSP0146
2113306707	ARM752	2203301407	ARM750	2213301903	SSP0534
2113306807	ARM751	2203301507	ARM749	2213302003	SSP0533
2113308107	ARM747	2203301711	ARM741	2213302311	ARM761
2113308207	ARM748	2203301811	ARM742	2213303303	SSP0534
2113308907	ARM752	2203304311	ARM741	2213303403	SSP0533
2113309007	ARM751	2203304411	ARM742	2213303711	ARM765
2113309107	ARM747	2203305711	ARM741	2213303811	ARM764
2113309207	ARM748	2203305811	ARM742	2213303903	SSP0532
2113309907	SSP1893	2203307707	ARM743	2213306311	ARM761
2113310008	SSP1893	2203307807	ARM744	2213306411	ARM760
2113330227	SSP1893	2203308307	ARM750	2213306511	ARM765
2113380015	SSP0148	2203308407	ARM749	2213306611	ARM764
2123202589	SSP2295	2203308907	ARM743	2213306707	ARM763
2123202689	SSP2294	2203309007	ARM744	2213306707	ARM771
2123300035	SSP1876	2203309307	ARM750	2213306807	ARM762
2123300135	SSP1876	2203309407	ARM749	2213306807	ARM770
2123301303	SSP0492	2203330127	SSP1891	2213307107	ARM771
2123301403	SSP0491	2203330405	ARM741	2213307207	ARM770
2123301911	ARM662	2203330427	SSP1891	2213307707	ARM769
2123302103	SSP0127	2203330505	ARM742	2213307807	ARM768
2123302203	SSP0489	2203380115	SSP0529	2213308107	ARM763
2123302303	SSP0490	2203380515	SSP0529	2213308207	ARM762
2123302403	SSP0514	2203380715	SSP0145	2213308207	ARM770

O.E.	MAGNETI MARELLI	O.E.	MAGNETI MARELLI	O.E.	MAGNETI MARELLI
2213308707	ARM783	2463304700	ARM683	4333009230	SSP1972
2213308807	ARM782	2463304800	ARM682	4333009320	SSP1973
2213308907	ARM767	2463380000	SSP0132	4333009360	SSP1972
2213309007	ARM766	2463500053	ARM536	4333009360	SSP1973
2213500206	ARM777	2463500053	ARM680	4333009510	SSP1969
2213500406	ARM779	2463500406	ARM781	4333009630	SSP1974
2213500606	ARM778	2463500506	ARM780	4333019245	SSP1974
2213500706	ARM773	2463501006	ARM681	4333049025	SSP1968
2213500806	ARM772	2513300703	SSP0528	4333049095	SSP1974
2213501006	ARM776	2513300707	ARM734	4333049185	SSP1972
2213501153	ARM775	2513300803	SSP0527	4473200089	SSP2322
2213501253	ARM774	2513300807	ARM733	4473200189	SSP2324
2223200389	SSP2386	2513301907	ARM736	4473200289	SSP2323
2223200489	SSP2385	2513302007	ARM735	4473200389	SSP2321
2223201089	SSP2387	4143200189	SSP2336	4473200489	SSP2320
2223201189	SSP2388	4143200289	SSP2336	4473301407	ARM687
2223201689	SSP2383	4143200389	SSP2336	4473301507	ARM686
2223201789	SSP2384	4143300035	SSP0136	4473330127	SSP1880
2223300103	SSP0500	4143300307	ARM700	4474600048	SSP0507
2223300203	SSP0499	4143300407	ARM699	4474600055	SSP0134
2233500132	ARM779	4143300507	ARM700	4474600148	SSP0506
2303300203	SSP0529	4143300607	ARM699	4504539505	SSP0669
2303300403	SSP0529	4143330127	SSP1883	4504609261	SSP0670
2303301711	ARM745	4143330135	SSP0509	4504609281	SSP0671
2303301811	ARM746	4143330227	SSP1883	4504609320	SSP0682
2303380015	SSP0145	4143330235	SSP0510	4504609360	SSP0683
2303380115	SSP0529	4144600005	SSP0510	4504609430	SSP0681
2303500329	ARM754	4144600105	SSP0509	4504609480	SSP0674
2303500429	ARM753	4144600205	SSP0136	4504609570	SSP0685
2303502006	ARM755	4153200189	SSP2519	4504609570	SSP0687
2303502706	ARM759	4153300200	ARM656	4504609650	SSP0679
2303502806	ARM758	4153300300	ARM657	4504619175	SSP0676
2303503506	ARM757	4154600000	SSP0239	4504619265	SSP0683
2303503606	ARM756	4154600005	SSP0652	4504619415	SSP0685
2463200489	SSP2318	4154600105	SSP0651	4504629255	SSP0666
2463200689	SSP2298	4330859035	SSP1971	4504629305	SSP0676
2463200789	SSP2299	4330859095	SSP1971	4504629425	SSP0681
2463301700	SSP0502	4331009015	SSP1970	4504639335	SSP0691
2463301707	ARM683	4331039016	SSP1975	4504649095	SSP0678
2463301800	SSP0501	4331039085	SSP1975	4504649115	SSP0683
2463301807	ARM682	4333009090	SSP1972	4504649195	SSP0679



O.E.	MAGNETI MARELLI	O.E.	MAGNETI MARELLI	O.E.	MAGNETI MARELLI
4504659025	SSP0672	4550319256	SSP0262	4882032010	SSP2559
4504659026	SSP0672	4550329795	SSP0152	4882035030	SSP2562
4504659045	SSP0672	4550339075	SSP0252	4882042010	SSP2550
4504659255	SSP0674	4550339235	SSP0251	4882042020	SSP2552
4504669135	SSP0690	4550342020	SSP0258	4882047010	SSP2555
4504669205	SSP0667	4550349055	SSP0259	4882047020	SSP2561
4504669235	SSP0694	4550349165	SSP0258	4882060032	SSP2545
4504669236	SSP0693	4550352010	SSP0255	4882060050	SSP2543
4504669245	SSP0695	4550352030	SSP0254	4882060080	SSP2564
4504709150	SSP0684	4550360030	SSP0265	4883006020	SSP2541
4504709220	SSP0675	4550360040	SSP0266	4883006030	SSP2541
4504709270	SSP0688	4550369025	SSP0250	4883021020	SSP2556
4504709310	SSP0680	4550374010	SSP0263	4883033010	SSP2540
4504709480	SSP0675	4551012390	SSP0264	4883042010	SSP2553
4504709570	SSP0686	4806809041	ARM1018	4883042020	SSP2554
4504719115	SSP0684	4806809150	ARM1018	4883042021	SSP2554
4504719215	SSP0686	4806842022	ARM1004	4883048010	SSP2541
4504739215	SSP0692	4806842040	ARM1022	4883060030	SSP2542
4504749025	SSP0677	4806859035	ARM1014	4884021010	SSP2557
4504749045	SSP0684	4806859055	ARM1016	4884042010	SSP2551
4504749195	SSP0680	4806879015	ARM1031	5435007000	SSP1869
4504759025	SSP0673	4806909040	ARM1019	5441744000	SSP1899
4504759026	SSP0673	4806909140	ARM1019	5450007100	ARM637
4504759035	SSP0673	4806942040	ARM1023	5450107100	ARM636
4504759135	SSP0675	4806959035	ARM1015	5450126000	ARM620
4504769085	SSP0689	4806959055	ARM1017	5450226000	ARM619
4504769115	SSP0668	4806979015	ARM1032	5450322000	SSP1854
4504769145	SSP0694	4861060030	ARM999	5450331600	SSP1854
4504769146	SSP0693	4861060060	ARM1092	5452443301	SSP1900
4543200010	SSP2538	4862060010	ARM1002	5453007000	SSP1869
4543300707	ARM825	4863060010	ARM1001	5453025000	SSP1854
4543300807	ARM826	4863060030	ARM1093	5483007000	SSP2283
4543301907	ARM826	4864060010	ARM1003	5483017010	SSP2229
4543302607	ARM825	4880260100	SSP2563	5483017020	SSP2228
4544600205	SSP0558	4881006030	SSP2540	5483025010	SSP2229
4550309321	SSP0253	4881060040	SSP2544	5483025020	SSP2228
4550309331	SSP0253	4881060060	SSP2565	5483026000	SSP2252
4550309350	SSP0261	4881952010	SSP2548	5483026100	SSP2252
4550319130	SSP0262	4882002030	SSP2555	5484007000	SSP2282
4550319215	SSP0257	4882002040	SSP2555	5484026000	SSP2251
4550319255	SSP0262	4882002070	SSP2561	5484026100	SSP2251

O.E.	MAGNETI MARELLI	O.E.	MAGNETI MARELLI	O.E.	MAGNETI MARELLI
5553026600	SSP2253	6393260616	SSP2335	7701470362	SSP0220
5554026600	SSP2254	6393300410	ARM698	7701470363	SSP0634
5682007000	SSP0472	6393300510	ARM697	7701470364	SSP0633
5682007200	SSP0472	6393301201	ARM696	7701470763	SSP0234
5682007200	SSP0475	6393301301	ARM695	7701470764	SSP0233
5682025000	SSP0443	6393301401	ARM696	7701471124	SSP0231
5682028000	SSP0442	6393301501	ARM695	7701471125	SSP0227
5682036000	SSP0551	6393330227	SSP1882	7701471126	SSP0646
5687243010	SSP0550	6394600048	SSP0512	7701471127	SSP0645
5771634000	SSP0111	6394600055	SSP0137	7701471144	SSP0232
5772407100	SSP0123	6394600255	SSP0137	7701471145	SSP0648
5775517000	SSP0111	6394600348	SSP0511	7701471146	SSP0647
5778526200	SSP0111	7700302114	SSP1946	7701472113	SSP0235
6000022720	SSP0646	7700302118	ARM943	7701472120	SSP0236
6000022721	SSP0645	7700302119	ARM942	7701472734	SSP0228
6000022730	SSP0656	7700309070	SSP2514	7701472735	SSP0238
6000022731	SSP0655	7700309071	SSP2513	7701472766	SSP0223
6001538603	SSP1944	7700309189	ARM943	7701472766	SSP0224
6001547519	ARM446	7700309190	ARM942	7701473333	SSP0225
6001547520	ARM447	7700312851	SSP1948	7701473655	SSP0232
6001547606	SSP0065	7700312852	SSP1947	7701473655	SSP0236
6001547610	SSP0387	7700313944	ARM963	7701473656	SSP0229
6001547611	SSP0386	7700313945	ARM962	7701474076	SSP0226
6001550442	SSP0387	7700425227	ARM963	7701474448	SSP0222
6001550443	SSP0386	7700425228	ARM962	7701474492	SSP0650
6383230268	SSP2328	7700820028	ARM975	7701474493	SSP0649
6383230368	SSP2327	7700820029	ARM974	7701474641	SSP0650
6383230468	SSP2332	7701047415	SSP0650	7701474795	SSP0640
6383230568	SSP2331	7701047416	SSP0649	7701474796	SSP0639
6383260016	SSP2329	7701047812	SSP0650	7701475841	SSP0219
6383260116	SSP2330	7701047813	SSP0649	7701475842	SSP0650
6383300010	ARM685	7701049282	SSP0642	7701475843	SSP0649
6383300027	SSP1879	7701049283	SSP0641	7701476576	SSP1954
6383300110	ARM684	7701056970	SSP1946	7701477385	SSP1955
6384600048	SSP0505	7701070154	SSP1949	7701478406	SSP0239
6384600055	SSP0133	7701462182	SSP1944	7701478407	SSP0652
6393200289	SSP2338	7701467218	SSP0242	7701478408	SSP0651
6393200389	SSP2337	7701467218	SSP0243	7701478551	SSP0224
6393200989	SSP2334	7701468883	SSP1944	7701478552	SSP0226
6393201089	SSP2333	7701469517	SSP0242	7702127160	SSP1945
6393260216	SSP2335	7701469517	SSP0243	8191336380	SSP1797



O.E.	MAGNETI MARELLI	O.E.	MAGNETI MARELLI	O.E.	MAGNETI MARELLI
8191336700	SSP1796	8200679063	ARM951	9013330727	SSP1884
8200001857	SSP2524	8200679067	ARM950	9013330727	SSP1885
8200002870	SSP2522	8200686016	SSP2528	9013331127	SSP1884
8200002870	SSP2523	8200688871	ARM947	9013331127	SSP1885
8200026654	ARM955	8200688875	ARM946	9013331327	SSP1885
8200026655	ARM954	8200688877	SSP1950	9014600148	SSP0515
8200040618	SSP2531	8200713522	SSP2514	9014600155	SSP0138
8200050191	SSP2530	8200713523	SSP2513	9014600455	SSP0138
8200054003	ARM957	8200714446	SSP2531	9053200489	SSP2344
8200054006	ARM956	8200714448	SSP2530	9053200589	SSP2343
8200127308	SSP2451	8200737126	ARM974	9063201389	SSP2345
8200166159	SSP2519	8200737126	ARM975	9063201489	SSP2346
8200166160	SSP2521	8200744091	ARM941	9063201789	SSP2348
8200197179	ARM963	8200744092	ARM940	9063201889	SSP2347
8200197187	ARM962	8200750273	ARM945	9063304007	ARM704
8200216376	ARM446	8200750274	ARM944	9063304007	SSP1886
8200216376	ARM447	8200763296	SSP1957	9063304107	ARM703
8200247898	ARM957	8200767822	ARM943	9064600048	SSP0516
8200247900	ARM956	8200767825	ARM942	9064600055	SSP0139
8200254163	ARM965	8200814411	SSP2154	9403817738	SSP1436
8200254166	ARM964	8200839107	ARM451	9404059580	SSP1429
8200255760	ARM953	8200839119	ARM453	9458084180	SSP0369
8200255761	ARM952	8200839124	ARM452	9471000565	SSP0369
8200265217	SSP2528	8200841004	ARM450	9471000665	SSP0368
8200273728	ARM955	8200942392	ARM977	9471000965	SSP0612
8200273729	ARM954	8200942396	ARM976	9471003465	SSP0612
8200298454	ARM951	8200942407	ARM969	9471007465	SSP0369
8200298455	ARM950	8200942408	ARM968	9471007565	SSP0368
8200346941	ARM941	8201079463	SSP2529	9566950880	SSP1381
8200346942	ARM940	8201108332	SSP0388	9651565180	SSP2503
8200389134	ARM955	8201108339	SSP0389	9670771480	ARM922
8200389135	ARM954	8201108350	SSP0066	9670772080	ARM923
8200565072	ARM959	8983500202	SSP1206	9672192480	SSP1941
8200565079	ARM958	9013200089	SSP2341	9675028880	ARM408
8200586561	ARM967	9013200289	SSP2340	9675031880	ARM409
8200586567	ARM966	9013200389	SSP2339	9678311280	ARM931
8200615057	ARM941	9013200589	SSP2342	9678311380	ARM930
8200615058	ARM940	9013301807	ARM702	9800596580	ARM932
8200619922	SSP2524	9013301907	ARM701	9800596680	ARM933
8200669065	SSP2519	9013302407	ARM702	9803434080	SSP1818
8200669066	SSP2521	9013302507	ARM701	9804947480	SSP2509

O.E.	MAGNETI MARELLI	O.E.	MAGNETI MARELLI	O.E.	MAGNETI MARELLI
9804947480	SSP2510	31121094465	ARM279	31126756102	ARM287
9805607380	ARM418	31121094466	ARM274	31126756491	SSP1786
9805607380	ARM419	31121094466	ARM275	31126758519	ARM277
9808868280	SSP2143	31121094466	ARM276	31126758520	ARM274
9809045780	SSP2510	31121096169	ARM316	31126760181	ARM298
9816865480	ARM934	31121096170	ARM315	31126760182	ARM297
9816865580	ARM935	31121096315	ARM318	31126760275	ARM318
16160100006	SSP1953	31121096316	ARM317	31126760276	ARM317
31100363476	SSP1788	31121096425	SSP1786	31126761409	ARM830
31103412137	ARM326	31121141717	ARM269	31126763699	ARM250
31103412138	ARM325	31121141718	ARM268	31126763700	ARM249
31103412726	SSP1787	31121141721	ARM300	31126763703	ARM252
31103415027	ARM324	31121141722	ARM299	31126763704	ARM251
31103415028	ARM323	31121141723	ARM300	31126763707	ARM252
31103418341	SSP1787	31121141724	ARM299	31126763708	ARM251
31103426433	ARM324	31121141961	ARM307	31126765994	ARM287
31103426434	ARM323	31121141962	ARM306	31126765995	ARM296
31103438623	SSP1788	31121142087	ARM303	31126765996	ARM295
31103443127	ARM326	31121142088	ARM302	31126768983	ARM257
31103443128	ARM325	31122229453	ARM285	31126768984	ARM256
31103451881	ARM324	31122229454	ARM284	31126768988	SSP1785
31104026719	ARM296	31122282121	ARM282	31126768989	ARM360
31104026720	ARM295	31122282121	ARM283	31126769717	ARM316
31106770689	ARM362	31122282122	ARM280	31126769718	ARM315
31106770690	ARM361	31122282122	ARM281	31126769793	ARM250
31106779437	SSP1911	31122347981	ARM362	31126769794	ARM249
31106779438	SSP1910	31122347982	ARM361	31126769797	ARM252
31106787665	SSP1789	31122405863	ARM360	31126769798	ARM251
31106787673	ARM344	31124026453	ARM286	31126770121	ARM288
31106787674	ARM343	31124036269	ARM252	31126770122	ARM289
31109803662	SSP1915	31124036270	ARM251	31126770849	ARM250
31121092023	ARM269	31126751317	ARM277	31126770850	ARM249
31121092024	ARM268	31126751318	ARM274	31126771893	ARM334
31121092609	ARM309	31126752318	ARM274	31126771894	ARM333
31121092610	ARM308	31126752717	ARM277	31126772303	SSP1914
31121093449	ARM271	31126752718	ARM274	31126772304	SSP1913
31121093450	ARM270	31126753991	SSP1911	31126772305	SSP1912
31121094233	ARM271	31126753992	SSP1910	31126773949	ARM332
31121094234	ARM270	31126755835	ARM288	31126773950	ARM331
31121094465	ARM277	31126755836	ARM289	31126774825	ARM296
31121094465	ARM278	31126756101	ARM286	31126774826	ARM295



O.E.	MAGNETI MARELLI	O.E.	MAGNETI MARELLI	O.E.	MAGNETI MARELLI
31126774827	ARM362	31303413300	SSP2071	31356768772	SSP2036
31126774828	ARM361	31306781545	SSP2062	31356769499	SSP2057
31126774831	ARM286	31306781546	SSP2061	31356769500	SSP2056
31126774832	ARM287	31306781547	SSP2057	31356769663	SSP2060
31126775959	ARM349	31306781548	SSP2056	31356769664	SSP2059
31126775960	ARM348	31306781549	SSP2087	31356773023	SSP2076
31126775963	ARM355	31306781550	SSP2086	31356773024	SSP2075
31126775964	ARM354	31306787163	SSP2081	31356777319	SSP2083
31126775967	ARM350	31306787164	SSP2080	31356778831	SSP2437
31126775971	ARM352	31306792211	SSP2039	31356859651	SSP2090
31126775972	ARM351	31306792212	SSP2038	31356859652	SSP2089
31126776417	ARM336	31306862863	SSP2442	31359806351	SSP2439
31126776418	ARM335	31306862864	SSP2032	31359806352	SSP2438
31126777753	SSP1790	31351091496	SSP2066	32106765089	SSP0305
31126777937	ARM288	31351091855	SSP2043	32106765090	SSP0304
31126777938	ARM289	31351091855	SSP2044	32106767781	SSP0305
31126777939	ARM288	31351091856	SSP2045	32106767782	SSP0304
31126777940	ARM289	31351091856	SSP2046	32106769073	SSP0307
31126779840	SSP1791	31351092304	SSP2042	32106769074	SSP0306
31126783443	SSP1909	31351095661	SSP2043	32106774335	SSP0322
31126787669	ARM342	31351095661	SSP2044	32106774361	SSP0316
31126787670	ARM341	31351095662	SSP2045	32106776946	SSP0316
31126794203	ARM347	31351095662	SSP2046	32106778437	SSP0565
31126794204	ARM346	31351095664	SSP2042	32106778438	SSP0564
31126798107	ARM355	31351095694	SSP2051	32106780984	SSP0323
31126798108	ARM354	31351095695	SSP2066	32106784716	SSP0026
31126850781	ARM347	31351507989	SSP2433	32106784790	SSP0326
31126850781	ARM355	31354014531	SSP2057	32106784796	SSP0325
31126850782	ARM346	31354014532	SSP2056	32106792674	SSP0324
31126850782	ARM354	31356750703	SSP2069	32106793497	SSP0323
31126852991	ARM259	31356750704	SSP2068	32106793623	SSP0307
31126852992	ARM258	31356751079	SSP2054	32106793624	SSP0306
31126855741	ARM261	31356751080	SSP2053	32106799966	SSP0309
31126855742	ARM260	31356753767	SSP2062	32106799967	SSP0308
31126864821	ARM313	31356753768	SSP2061	32106854734	SSP0302
31126864822	ARM312	31356759537	SSP2434	32106854737	SSP0303
31129806519	ARM834	31356760985	SSP2057	32106858736	SSP0320
31129806520	ARM833	31356760986	SSP2056	32106858738	SSP0319
31303413201	SSP2072	31356765933	SSP2034	32106863858	SSP0320
31303413202	SSP2071	31356765934	SSP2033	32106863860	SSP0319
31303413299	SSP2072	31356768771	SSP2037	32106867404	SSP0303

O.E.	MAGNETI MARELLI	O.E.	MAGNETI MARELLI	O.E.	MAGNETI MARELLI
32106867405	SSP0302	33321095411	ARM320	33326770964	ARM327
32109805551	SSP0567	33321095412	ARM319	33326770969	ARM330
32109805552	SSP0566	33321095414	ARM321	33326770970	ARM329
32109808839	SSP0569	33321096797	ARM292	33326774476	ARM359
32109808840	SSP0568	33321097264	ARM301	33326774793	ARM291
32111091769	SSP0311	33322282065	ARM292	33326774794	ARM290
32111091770	SSP0310	33324046917	ARM328	33326774795	ARM292
32111093771	SSP0313	33324046918	ARM327	33326774796	ARM321
32116761560	SSP0562	33326758141	ARM291	33326774841	ARM294
32126756309	SSP1909	33326758142	ARM290	33326774842	ARM293
32136761559	SSP0563	33326759157	ARM294	33326775083	ARM311
32211091723	SSP0313	33326759158	ARM293	33326775084	ARM310
32211091724	SSP0312	33326760675	ARM322	33326775683	SSP2085
32211091913	SSP0001	33326763471	ARM255	33326775902	ARM353
32211093433	SSP0001	33326763473	ARM254	33326777424	ARM292
32211095950	SSP0020	33326765425	ARM253	33326777980	ARM254
32211095957	SSP0315	33326765534	ARM253	33326779387	ARM328
32211095958	SSP0314	33326767753	ARM294	33326779388	ARM327
32211096057	SSP0001	33326767754	ARM293	33326782131	ARM357
32211096327	SSP0321	33326767759	ARM291	33326782132	ARM356
32211141345	SSP0318	33326767760	ARM290	33326782237	ARM253
32211141346	SSP0317	33326767831	ARM273	33326786978	ARM338
32216754565	SSP0561	33326767832	ARM272	33326786981	ARM337
32216754566	SSP0560	33326767967	ARM294	33326788269	ARM321
32216756369	SSP0316	33326767968	ARM293	33326788549	ARM340
32216760354	SSP0322	33326768274	ARM319	33326788550	ARM339
32216767860	SSP0327	33326768274	ARM320	33326792525	ARM264
32216773739	SSP0323	33326768789	ARM294	33326792533	ARM265
33303411651	ARM322	33326768790	ARM293	33326792539	ARM263
33306772241	ARM291	33326769971	ARM291	33326792540	ARM262
33306772242	ARM290	33326770747	ARM320	33326792541	ARM345
33306773941	ARM294	33326770748	ARM319	33326792543	ARM267
33306773942	ARM293	33326770749	ARM314	33326792544	ARM266
33306786991	ARM358	33326770775	ARM291	33326795047	ARM328
33321090030	ARM314	33326770776	ARM290	33326795048	ARM327
33321090745	ARM301	33326770813	ARM322	33326851563	ARM248
33321090905	ARM305	33326770839	ARM294	33326870773	ARM248
33321090906	ARM304	33326770840	ARM293	33503413197	SSP2073
33321091620	ARM314	33326770859	ARM320	33503414297	SSP2073
33321094209	ARM273	33326770860	ARM319	33506768492	SSP2055
33321094210	ARM272	33326770963	ARM328	33506768493	SSP2055



O.E.	MAGNETI MARELLI	O.E.	MAGNETI MARELLI	O.E.	MAGNETI MARELLI
33506772789	SSP2436	01YC153A053	ARM575	1300507080	SSP1257
33506781537	SSP2055	04656730AH	ARM151	1305551080	SSP1249
33506781538	SSP2063	04656731AH	ARM152	1305552080	SSP1254
33506781539	SSP2064	04656934AA	SSP2148	1308694080	SSP1258
33506781540	SSP2058	04656934AB	SSP2148	1312317080	SSP1248
33506785607	SSP2041	04670508AD	ARM454	13278358*	SSP0028
33506785608	SSP2040	04670509AD	ARM455	1331940080/8080	SSP1232
33506862865	SSP2443	04743935AD	SSP1351	1338373080	SSP1258
33509803515	SSP2441	04766910AL	ARM438	1339460080	ARM027
33509803516	SSP2440	04766911AL	ARM439	1341021080	SSP1385
33551091497	SSP2067	04766911AL part of	SSP1822	1345854080	SSP1385
33551092292	SSP2047	04782254AB	SSP2152	1346384080	ARM035
33551092292	SSP2048	04782561AA	ARM459	1346385080	ARM036
33551094619	SSP2050	04782561AB	ARM459	1357572080	SSP1328
33551095532	SSP2048	04782561AC	ARM459	1357572080*	SSP1328
33551095532	SSP2049	04782561AD	ARM459	1359226080	SSP1385
33551095696	SSP2067	04782561AE	ARM459	1400099680*	SSP2169
33551096735	SSP2070	04782561AF	ARM459	1469026 part of	SSP1852
33551507999	SSP2432	04782665AE	ARM466	1497407080*	ARM495
33556753770	SSP2064	04782666AE	ARM465	1497408080*	ARM496
33556757460	SSP2063	04782684AB	SSP1342	1513343*	SSP2175
33556761000	SSP2058	05066373AB	SSP1406	1540724 part of	SSP1832
33556764428	SSP2035	05168389AA	ARM458	1603290	SSP1393
33556771937	SSP2074	05168389AB	ARM458	1607744580	SSP1385
33556777635	SSP2084	05168652AC	ARM456	16545660	SSP1214
33556786429	SSP2065	05168653AC	ARM457	1693201389*	SSP2308
33556790324	SSP2079	05174185AC	SSP1338	1723323 part of	SSP1841
33556857626	SSP2088	05174245AD	SSP1337	1723324 part of	SSP1842
36160100045	SSP1924	05180606AA	ARM442	1751952 part of	SSP1832
37106775189	SSP2082	05180606AB	ARM442	1751955 part of	SSP1832
37116771929	SSP2078	05180607AA	ARM443	191411315A	SSP2585
37116771930	SSP2077	05183761AD	SSP1406	1E0032240	SSP0072
95533307010	SSP2567	05290828AB	ARM467	1E0034170	SSP2178
95533307011	SSP2568	05290829AB	ARM468	1J0407151A	ARM183
95534101731	ARM1036	0K033C3415A	SSP2278	1J0407151B	ARM182
95534101832	ARM1035	0K33C34160A	SSP2279	1J0407365A	SSP1778
95534102701	ARM1033	1009591*	SSP2583	1J0407365B	SSP1778
95534102702	ARM1033	104230 part of	SSP1843	1J0407365C	SSP1778
95534713220	SSP0696	1243500129*	ARM673	1J0407365D	SSP1778
95534713221	SSP0697	1243507606*	ARM670	1J0407366A	SSP1776
01YC153A052	ARM574	1243507706*	ARM668	1J0407366A/B/C*	SSP1777

O.E.	MAGNETI MARELLI	O.E.	MAGNETI MARELLI	O.E.	MAGNETI MARELLI
1J0407366A/B/C*	SSP1779	1K0407366C	SSP1976	1S713042AL/AM/AK	ARM592
1J0407366B	SSP1776	1K0407366E	SSP1976	1S713042AM	ARM587
1J0407366C	SSP1776	1K0411315B	SSP2576	1S713042AN	ARM587
1J0411315C	SSP2571	1K0411315D	SSP2576	1S713042AP	ARM587
1J0411315D	SSP2002	1K0411315J	SSP2576	1S713051AH	ARM588
1J0411315D	SSP2003	1K0423810A	SSP0269	1S713051AK	ARM588
1J0411315H	SSP2572	1K0423811A	SSP0701	1S713051AL/AM/AK	ARM593
1J0411315K	SSP2575	1K0423811E	SSP0701	1S713051AM	ARM588
1J0411316D	SSP2004	1K0423811G	SSP0701	1S713051AN	ARM588
1J0422315G	SSP2572	1K0423811J	SSP0701	1S713051AP	ARM588
1J0422807	SSP0003	1K0423811K	SSP0701	1S713290AB	SSP0437
1J0422807A	SSP0003	1K0423812A	SSP0700	1S713290BB	SSP0437
1J0422811A	SSP0286	1K0423812E	SSP0700	1S713395AF	SSP1850
1J0422811B	SSP0284	1K0423812G	SSP0700	1S713B438AC	SSP2217
1J0422811L	SSP0286	1K0423812J	SSP0700	1S713B438AC	SSP2222
1J0422811R	SSP0284	1K0423812K	SSP0700	1S713B438BB	SSP0097
1J0422812A	SSP0285	1K0501529F	ARM983	1S715C486AD	SSP2219
1J0422812B	SSP0283	1K0501529J	ARM988	1S715C486AD	SSP2220
1J0422812L	SSP0285	1K0501530C	ARM982	1S715C486BE	SSP2221
1J0422812R	SSP0283	1K0505223K	ARM1055	1S715K652AB	ARM590
1J0422821A	SSP0005	1K0505224K	ARM1054	1S715K652AC	ARM590
1J0505323E	ARM169	1K0505311AA	ARM1039	1S715K652CA	ARM586
1J0505323H	ARM169	1K0505311AB	ARM1039	1S715K743AB	ARM589
1J0505323L	ARM169	1K0505311S	ARM1039	1S715K743AC	ARM589
1J0505323M	ARM169	1K0505323N	ARM189	1S715K743CA	ARM585
1J0505466B	SSP2023	1K0505465C	SSP2577	1S7C3280BB	SSP0097
1K0407151AC	ARM1051	1K0505465D	SSP2577	1T0505223F	ARM1038
1K0407151B*	ARM1061	1K0505465H	SSP2577	1T0505224F	ARM1037
1K0407151BC*	ARM990	1K0505465J	SSP2577	1X433289AB	SSP0437
1K0407151BG*	ARM1063	1K0505465K	SSP2577	1X43395AB	SSP1851
1K0407151P*	ARM1049	1M515500AB	ARM535	2023304907 part of	SSP1875
1K0407151Q*	ARM1049	1M515500AC	ARM535	2043200789**	SSP2297
1K0407152AC	ARM1050	1S0407151*	ARM1053	2043202289**	SSP2296
1K0407152BC*	ARM989	1S0407152*	ARM1052	2043203789*	SSP2313
1K0407152BG*	ARM1062	1S0423810A	SSP0270	2043203889*	SSP2311
1K0407152P*	ARM1048	1S0423811A	SSP0703	20945779/20945780**	SSP1799
1K0407152Q*	ARM1048	1S0423812A	SSP0702	2123201189*	SSP2293
1K0407365B	SSP1977	1S13B438BA	SSP2224	2123201289*	SSP2292
1K0407365C	SSP1977	1S613B438AA	SSP2178	2463200089*	SSP2319
1K0407365E	SSP1977	1S713042AH	ARM587	25997509 part of	SSP1810
1K0407366B	SSP1976	1S713042AK	ARM587	25997510 part of	SSP1810



O.E.	MAGNETI MARELLI	O.E.	MAGNETI MARELLI	O.E.	MAGNETI MARELLI
2D0407021	ARM702	30 683 248	ARM1089	350231*	SSP2480
2D0407022	ARM701	30671637 part of	SSP1852	350232*	SSP2479
2D0407361A	SSP1884	30821650*	SSP1987	350610*	SSP2478
2D0407361B	SSP1884	30821651*	SSP1987	3520 Q4	ARM415
2D0407361B	SSP1885	30881488/30881487	SSP1990	3520.78	ARM899
2D0411051	SSP2340	part of		3520.79	ARM898
2D0411052	SSP2339	31 202 228	ARM1089	3520.80	ARM901
2D0422811	SSP0515	31 277 345	ARM1089	3520.81	ARM900
2D0511329	SSP2341	31 317 663	ARM1089	3520.87	SSP1188
2E0407151M	ARM704	31126761410***	ARM829	3520.92	ARM901
2E0407152M	ARM703	31126772301*	ARM832	3520.93	ARM900
2E0411317C	SSP2348	31126772302*	ARM831	3520.94	ARM024
2E0411318C	SSP2347	31277526/31277525	SSP1990	3520.95	ARM026
2E0511051F	SSP2345	part of		3520.96	ARM028
2E0511051G	SSP2346	31340231 part of	SSP1991	3520.A2	ARM413
2E0713491	SSP0139	31340232 part of	SSP1992	3520.A3	ARM411
2E0713501	SSP0516	3135095694*	SSP2052	3520.C1	ARM417
2H0407021B	ARM1043	31356759537*	SSP2435	3520.C3	ARM024
2H0407022B	ARM1042	32106765235/236 part of	SSP0016	3520.F5	ARM413
2H0407151A	ARM1045	of		3520.G8	ARM905
2H0407152A	ARM1044	32106778548 part of	SSP0168	3520.G9	ARM024
2H0411317	SSP2569	32106787472 part of	SSP0025	3520.H3	ARM925
2H0411317B	SSP2570	32106793496*	SSP0023	3520.H5	ARM925
2K0505465B	SSP2578	32106793621/622 part of	SSP0017	3520.H7	ARM908
2K0505465C	SSP2578	of		3520.J3	ARM415
2L1Z3280GA	SSP0087	32106799965 part of	SSP0018	3520.K3	ARM425
2L1Z5K483AD	SSP2288	32106854733 part of	SSP0169	3520.K8	ARM927
2L3Z3A130CA	SSP0425	32106854736 part of	SSP0169	3520.L0	ARM492
2L5Z3083AA	ARM501	32106858735/737 part of	SSP0024	3520.L1	ARM494
2L8Z3079AA	SSP1895	of		3520.L4	ARM421
2M515E594AA	SSP2187	32106867404 part of	SSP0014	3520.L7	ARM905
2S613395AB	SSP1833	32106867405 part of	SSP0014	3520.L7	ARM909
2S6J3289AC	SSP0076	32111093669/770 part of	SSP0019	3520.L8	ARM911
2T143051BG	ARM581	of		3520.N1	ARM421
2T143B438BA	SSP2213	32116754563*	SSP0167	3520.N3	ARM492
2T143B438BA	SSP2214	32116754564*	SSP0167	3520.N4	ARM494
2T143B438BB	SSP2213	32216756368 part of	SSP0021	3520.N6	ARM915
2T1Z3468A	SSP1846	32216762243*	SSP0015	3520.N7	ARM921
2T1Z3A130A	SSP0433	32216762244*	SSP0015	3520.P0	ARM425
2T1Z3A130A	SSP0435	32216762403*	SSP0022	3520.P1	ARM421
2T1Z5K484AA	SSP2217	32303418204*	SSP0023	3520.P3	ARM927

O.E.	MAGNETI MARELLI	O.E.	MAGNETI MARELLI	O.E.	MAGNETI MARELLI
3520.Q1	ARM915	3521.H0/H1	SSP1241	3521V5	ARM059
3520.Q2	ARM903	3521.H0/H1	SSP1242	3521Y.0	ARM936
3520.Q3	ARM415	3521.H1	ARM035	3523.94	SSP1258
3520.Q9	ARM913	3521.H2	ARM491	352319	SSP1227
3520.R6	ARM421	3521.H3	ARM027	352357	SSP1213
3520.R6	ARM903	3521.H3	ARM493	352364	SSP1213
3520.R7	ARM913	3521.H6	ARM420	352380	SSP1255
3520.R8	ARM074	3521.H9	ARM907	352V0/3521R1/4013A0	SSP1903
3520.S0	ARM092	3521.J0	ARM910	09/4013A0010 part of	
3520.S1	ARM094	3521.J3	ARM491	3640.28	SSP1934
3520.S1/3521.P2	SSP1259	3521.J4	ARM027	3640.32	SSP1196
3520.S1/3521.P2	SSP1261	3521.J4	ARM493	3640.33	SSP1197
3520.S2	ARM927	3521.J6	ARM914	3640.34	SSP1934
3520.S8	ARM905	3521.J7	ARM920	3640.36	SSP1817
3520.V1	ARM421	3521.K0	ARM424	3640.38	SSP1815
3520.V2	ARM929	3521.K3	ARM926	3640.39	SSP1816
3520.W0	ARM905	3521.K4	ARM023	3640.42	SSP1815
3520.W2	ARM427	3521.K6	ARM036	3640.43	SSP1816
3520.W3	ARM058	3521.L1	ARM420	3640.50	SSP1938
3520.W3	SSP1188	3521.L2	ARM914	3640.51	SSP1938
3520.W7	ARM423	3521.L3	ARM902	3640.53	SSP1939
3520.X6	ARM429	3521.L4	ARM414	3640.54	SSP1199
3520.X7	ARM917	3521.N0	ARM912	3640.55	SSP1198
3520.Y0	ARM937	3521.N1	ARM420	3640.56	SSP1819
3520.Y4	ARM058	3521.N2	ARM420	3640.57	SSP1936
3520P4	ARM407	3521.N7	ARM902	3640.58	SSP1935
3521.65	ARM025	3521.N8	ARM912	3640.58	SSP1996
3521.66	ARM027	3521.N9	ARM073	3640.60	SSP1939
3521.69	ARM924	3521.P1	ARM091	3640.61	SSP1819
3521.81	ARM416	3521.P2	ARM093	3640.62	SSP1819
3521.83	ARM023	3521.P3	ARM926	3640.65	SSP1819
3521.A6	ARM410	3521.P8	ARM904	3640.66	SSP1819
3521.C4	ARM412	3521.R3	ARM928	3640.67	SSP1201
3521.C8	ARM904	3521.R4	ARM414	3640.68	SSP1939
3521.C9	ARM023	3521.S5	ARM426	3640.71	SSP1934
3521.E5	ARM924	3521.S6	ARM059	3640.72	SSP1935
3521.E7	ARM906	3521.S9	ARM422	3640.72	SSP1996
3521.F3	ARM414	3521.T7	ARM428	3640.73	SSP1940
3521.G3	ARM424	3521.T8	ARM916	3640.74	SSP1936
3521.G8	ARM926	3521.V1	ARM936	3640.76	SSP1201
3521.H0	ARM036	3521P4	ARM406	3640.77	SSP1820



O.E.	MAGNETI MARELLI	O.E.	MAGNETI MARELLI	O.E.	MAGNETI MARELLI
3640.78	SSP1937	3817.44	SSP0629	3A0422812B	SSP0283
3640.83	SSP1942	3817.50	SSP0612	3C0407151G*	ARM1046
3736028 S1	SSP2209	3817.53	SSP0377	3C0407151H*	ARM1047
3812.25	SSP0206	3817.54	SSP0376	3C0407365A	SSP1981
3812.95	SSP0206	3817.55	SSP0373	3C0407365B	SSP1979
3812.95*	SSP0049	3817.56	SSP0372	3C0407366A	SSP1980
3812.99	SSP0056	3817.57	SSP0619	3C0407366B	SSP1978
3812.A0	SSP0051	3817.58	SSP0620	3C0505223D	ARM188
3812.A4	SSP1381	3817.61	SSP0615	3C0505224D	ARM187
3812.C0	SSP0050	3817.62	SSP0616	3C113B438AC	SSP2215
3812.C5	SSP0207	3817.63	SSP0614	3M513395BC	SSP1836
3812.C6	SSP0055	3817.64	SSP0613	3M513B438AB	SSP2190
3812.C7	SSP0216	3817.65	SSP0622	3M513K209AA	SSP1837
3812.C8	SSP0059	3817.66	SSP0621	3M513L519AA	SSP0084
3812.E0	SSP0212	3817.67	SSP0618	3M513L519AB	SSP0084
3812.E1	SSP0057	3817.68	SSP0617	3Q0407151E	ARM1067
3812.E2	SSP1384	3817.7	SSP1433	3Q0407151F	ARM1067
3812.E4	SSP0050	3817.70	SSP1433	3Q0407152E	ARM1066
3812.E4	SSP0055	3817.71	SSP0371	3Q0407152F	ARM1066
3812.E5	SSP0213	3817.72	SSP0370	3R0505323	ARM215
3812.E8	SSP0208	3817.73	SSP1436	3R0505324	ARM214
3812.E9	SSP0052	3817.75	SSP0625	3W1Z5K484AA	SSP2170
3812.F0	SSP1387	3817.76	SSP0626	4001.33	SSP0205
3812.F1	SSP0160	3817.77	SSP1434	4001.E4	SSP1385
3812.F2	SSP0214	3817.80	SSP0379	4001.E5	SSP1385
3812.F3	SSP0060	3817.81	SSP0378	40010000	SSP1385
3812.F4	SSP0209	3817.86	SSP1423	4006.24	SSP1383
3812.F6	SSP0058	3817.87	SSP1422	4010A015	SSP1908
3812.G3	SSP0217	3817.88	SSP0625	4010A037	ARM824
381200	SSP1384	3817.89	SSP0626	4010A038	ARM823
3817.10	SSP0612	3817.91	SSP0374	4010A041	ARM824
3817.14	SSP0369	3817.92	SSP0375	4010A042	ARM823
3817.16	SSP0368	3817.97	SSP0380	4010A139	ARM824
3817.18	SSP0612	3817.A1	SSP0632	4010A140	ARM823
3817.30	SSP0369	3817.A2	SSP0631	4011000QAA	SSP1946
3817.31	SSP0368	3817.B3	SSP0210	4011000QAB	SSP1946
3817.37	SSP0630	3817.E3	SSP0210	40110EA000	SSP1923
3817.38	SSP0629	39021472/3 part of	SSP1933	4013A009	ARM822
3817.41	SSP0369	3A0422811	SSP0699	4013A010	ARM821
3817.42	SSP0368	3A0422811B	SSP0284	4013A090	SSP1907
3817.43	SSP0630	3A0422812	SSP0698	4013A135	ARM826

O.E.	MAGNETI MARELLI	O.E.	MAGNETI MARELLI	O.E.	MAGNETI MARELLI
4013A150	ARM825	4056A37	SSP2425	455030F010	SSP0260
4013A281	ARM822	4059.09	SSP1429	455030R010	SSP0260
4013A282	ARM821	4059.12	SSP1432	4550352070 part of	SSP0256
4013A427	ARM822	4110A085	ARM819	4566899	SSP1213
4013A428	ARM821	4113A011	ARM820	46413122*	SSP2165
401600004R	SSP1958	4117A007	ARM818	46421552	SSP1283
401600005R	SSP1956	4156A014	SSP2422	46454061	SSP1279
4016000Q0A	SSP1954	4157013	SSP1236	46454062	SSP1281
4016000Q0B	SSP1949	4242062J00	SSP2539	46551376	SSP1277
4016000QAB	SSP1948	4252080J00	SSP1343	46551377	SSP1278
4016000QAD	SSP1947	42520-80J00	SSP1343	4656012AC	SSP1262
401600W000	SSP1921	4410A172	SSP0157	4656260AA	SSP2118
401600W025	SSP1921	4410A173	SSP0164	4656730AH/31AH	SSP1263
401602308R	SSP1823	4422A002	SSP0553	46748578	SSP1218
401602Y000	SSP1924	4422A009	SSP0555	46748579	SSP1217
401604F100	SSP1918	4422A010	SSP0554	46802680/682	SSP1219
401604F105	SSP1918	4422A012	SSP0160	46802680/682	SSP1221
4016050A00	SSP1916	4422A036	SSP0162	4694760/61	SSP1264
4016050J25	SSP1916	4422A037	SSP0557	4694760/61	SSP1265
4016050Y00	SSP1917	4422A038	SSP0556	4705172	ARM037
4016052Y00	SSP1917	4422A052	SSP0553	4743021AA	SSP1301
4016060Y20	SSP1917	4422A056	SSP0158	4743454AA	SSP1301
4016060Y60	SSP1916	4422A057	SSP0160	4743454AB	SSP1301
4016070J00	SSP1916	4422A058	SSP0159	4743454AC	SSP1301
401608374R	SSP1951	4422A076	SSP0159	4743669AB	SSP1301
401609060R	SSP1956	4520150G10	ARM991	4743669AC	SSP1301
40160AX000	SSP1919	4520160B01	ARM991	4743834AB	ARM436
40160EA00A part of	SSP1922	4520162J00	ARM993	4743835AB	ARM437
40160EB310	SSP1922	4520163J00	ARM993	4743935AD	SSP1351
4018.A3	SSP1431	4520170C00	ARM991	4762861AA	SSP1407
4018.A4	SSP1382	4520170C00/45202	SSP1965	4764500AC	ARM445
4018.E0	SSP1451	part of		4764501AC	ARM444
4056A014	SSP2414	4520179J00	ARM995	4766542	ARM141
4056A037	SSP2419	4520250G10	ARM992	4766542AA	ARM141
4056A105	SSP2423	4520260B01	ARM992	4766543	ARM142
4056A106	SSP2424	4520262J00	ARM994	4766543AA	ARM142
4056A111	SSP2430	4520263J00	ARM994	4766866AA	SSP1304
4056A112	SSP2429	4520270C00	ARM992	4782740AA	SSP1821
4056A133	SSP2428	4520279J00	ARM996	4782740AB	SSP1821
4056A134	SSP2427	4526190J01	SSP2445	4782741AB	SSP1821
4056A191	SSP2417	455000H010	SSP0205	4782952AD	SSP2149



O.E.	MAGNETI MARELLI	O.E.	MAGNETI MARELLI	O.E.	MAGNETI MARELLI
48001AX602*	SSP0174	485203S525	SSP0578	48527JDA01	SSP0591
4806802130*	ARM997	485204680R	SSP0643	48547JDA01	SSP0590
480680H010	ARM902	485204F125	SSP0570	486100K010	ARM1006
480680K010	ARM1008	485206481R	SSP0660	486100K040	ARM1010
480680K040	ARM1012	485206730R	SSP0636	4861060030/4863060010	SSP1967
480680R030*	ARM1027	4852073J23	SSP0585	part of	
4806812260*	ARM1029	4852073J25	SSP0585	4862060010 part of	SSP1966
4806812300*	ARM997	485208355R	SSP0653	486300K010	ARM1007
4806842050*	ARM1024	485209C000	SSP0585	486300K040	ARM1011
4806842051*	ARM1024	485209C025	SSP0585	4864060010 part of	SSP1966
4806842060*	ARM1027	48520AX600	SSP0571	48640AX600	SSP0572
4806902130*	ARM998	48520AX602	SSP0649	48640AX602	SSP0650
480690H010	ARM903	48520BM425	SSP0582	48640EA01J	SSP0579
480690K010	ARM1009	48520CB025	SSP0176	486471U61A	SSP0587
480690K040	ARM1013	48520EA01J	SSP0580	48647JD01A	SSP0591
480690R030*	ARM1028	485210001R	SSP0244	486571U61A	SSP0586
4806912260*	ARM1030	4852100QAA	SSP0235	487100R030	ARM1026
4806912300*	ARM998	4852100QAF	SSP0220	488100K010	SSP2547
4806942022*	ARM1005	4852100QAG	SSP0236	4881063J00	SSP0665
4806942050*	ARM1025	4852101B25	SSP0173	4881079J01	SSP1452
4806942051*	ARM1025	4852106R05	SSP0170	48810-79J01	SSP1452
4806942060*	ARM1028	485210W025	SSP0178	48810M68K00	SSP0665
482500M025	SSP0581	485211071R	SSP0240	4881760010*	SSP2563
48520 95F0A	SSP0583	4852117B00	SSP0173	488200D010	SSP2549
485200001R	SSP0658	485212309R	SSP0246	488200K010	SSP2558
485200002R	SSP0657	485212373R	SSP0221	488200K030	SSP2546
4852000QAH	SSP0633	485212518R	SSP0218	488200R010	SSP2561
4852000QAJ	SSP0634	485213172R	SSP0241	4882074010*	SSP2560
4852000QAK	SSP0642	485214M527	SSP0180	48820AD010	SSP2562
4852000QAL	SSP0641	485214M528	SSP0180	488300R010	SSP2554
4852000QAM	SSP0225	485214M587	SSP0180	4883063J00	SSP0249
485200368R	SSP0654	485214M588	SSP0180	4883079J00	SSP1394
485200410R	SSP0386	485214U110	SSP0181	48830-79J00	SSP1394
485200780R	SSP0635	4852150Y00	SSP0171	4883079J10	SSP1395
485200P725	SSP0578	485215612R	SSP0239	48830-79J10	SSP1395
485200W025	SSP0578	4852160Y05	SSP0171	4883086G00	SSP0191
485201340R	SSP0659	485216564R	SSP0245	4886606*	SSP2478
4852015U26	SSP0584	48521-72E00	SSP0170	4895482AA	SSP1305
485202710R	SSP0644	48521CB027	SSP0176	4895-482AA	SSP1305
485202867R	SSP0387	48521EA000	SSP0179	4895482AC	SSP1305
485203S500	SSP0578	48527JD01A	SSP0590	4895483AA	SSP1306

O.E.	MAGNETI MARELLI	O.E.	MAGNETI MARELLI	O.E.	MAGNETI MARELLI
4895-483AA	SSP1306	4E0407693F	ARM244	4G0411317C	SSP2027
49001BA210SK* part of	SSP0172	4E0407694C	ARM243	4G0423810A	SSP0010
4B0419811E	SSP0287	4E0407694F	ARM243	4G0423811A	SSP0294
4B0422821	SSP0004	4E0411317C	SSP2020	4G0423812A	SSP0293
4C155495AA	SSP2208	4E0411317D	SSP2020	4H0407151B	ARM226
4D0407151G	ARM180	4E0411317E	SSP2020	4H0407152B	ARM225
4D0407151H	ARM180	4E0419811B	SSP0299	4H0407505E	ARM220
4D0407151J	ARM180	4E0419811C	SSP0299	4H0407506E	ARM219
4D0407505A	ARM184	4E0419811D	SSP0299	4H0407509E	ARM222
4D0407505D	ARM184	4E0419811E	SSP0299	4H0407510E	ARM221
4D0407505F	ARM184	4E0419821	SSP0009	4H0407689	SSP1784
4D0407509D	ARM172	4E0501529D	ARM242	4H0407693E	ARM224
4D0407509F	ARM173	4E0501529G	ARM242	4H0407694E	ARM223
4D0407509G	ARM173	4E0505547L	SSP2013	4H0422810	SSP0011
4D0407509J	ARM172	4E0505548L	SSP2012	4H0422810A	SSP0011
4D0407510D	ARM170	4F0407151	ARM213	4H0422817A	SSP0301
4D0407510F	ARM171	4F0407151A	ARM213	4H0422818A	SSP0300
4D0407510G	ARM171	4F0407693	ARM212	4M513289AB	SSP0421
4D0407510J	ARM170	4F0407693B	ARM212	4M513290AB	SSP0422
4D0407693M	ARM179	4F0407693C	ARM212	4M513A423AD	ARM543
4D0407693N	ARM179	4F0407694	ARM211	4M513A423AF	ARM543
4D0407694M	ARM178	4F0407694B	ARM211	4M513A424AD	ARM544
4D0407694N	ARM178	4F0407694C	ARM211	4M513A424AF	ARM544
4D0411317G	SSP2005	4F0419811C	SSP0292	4M513L519AB	SSP0084
4D0411317J	SSP2005	4F0419811D	SSP0292	4M513L519AB	SSP0086
4D0411317K	SSP2005	4F0419811G	SSP0292	4M515K652AD	ARM537
4D0411317K	SSP2009	4F0422821	SSP0008	4R3Z3078B part of	SSP1839
4D0419811A	SSP0287	4F0501529C	ARM218	4R3Z3079B part of	SSP1839
4D0419811B	SSP0287	4F0501529E	ARM218	4Z7407151C	ARM165
4D0422821	SSP0004	4F0505465N	SSP2019	4Z7407151G	ARM166
4D0505465D	SSP2010	4F0505465P	SSP2021	4Z7407693D	ARM164
4D0505465D	SSP2011	4G0407689C	SSP1783	4Z7407694D	ARM163
4D0505547C	SSP2013	4G0407693D	ARM228	5003930AA	SSP0385
4D0505548C	SSP2012	4G0407693F	ARM228	500411315B	SSP2537
4E0407151G	ARM245	4G0407693H	ARM228	5012432AA	SSP1864
4E0407151L	ARM245	4G0407693J	ARM228	50509339/340	SSP1228
4E0407505B	ARM210	4G0407694D	ARM227	50509339/340	SSP1239
4E0407506B	ARM209	4G0407694F	ARM227	50509339/340	SSP1253
4E0407509B	ARM208	4G0407694H	ARM227	505-1316	SSP1185
4E0407510B	ARM207	4G0407694J	ARM227	50513442	ARM099
4E0407693C	ARM244	4G0411317A	SSP2027	50513444	ARM098



O.E.	MAGNETI MARELLI	O.E.	MAGNETI MARELLI	O.E.	MAGNETI MARELLI
50521045	SSP1285	5087.40	SSP2139	5105041AC	ARM630
50521047	SSP1284	5087.40	SSP2140	5105041AC/5105041AH	SSP1865
5069161AA	SSP1208	5087.41	SSP2141	part of	
50700443	SSP1229	5087.42	SSP2506	5105041AH	ARM630
50700778	SSP1231	5087.43	SSP2499	5110437AA	SSP1208
50703321	ARM075	5087.45	SSP2495	5110437AI	SSP1208
50704306/307	SSP1268	5087.45	SSP2496	5114037AI	SSP1208
50704361	SSP1291	5087.46	SSP2137	5118696AA	SSP2342
50704362	SSP1289	5087.48	SSP2499	5135651AE	SSP1207
50704480/481	SSP1225	5087.50	SSP2509	5143555AC	SSP1445
50704480/481	SSP1226	5087.50*	SSP2511	5143556AC	SSP1444
50704481	ARM124	5087.51	SSP1341	5151803AA	SSP2269
50704947	ARM060	5087.52	SSP2505	5168158AA	ARM463
50704948	ARM061	5087.53	SSP2504	5168158AB	ARM463
50705464	ARM154	5087.54	SSP2498	5168159AA	ARM464
50705465	ARM153	5087.55	SSP2497	5168159AB	ARM464
50706954	SSP1274	5087.56	SSP1331	5170.F5	SSP1329
50706955	SSP1273	5087.57	SSP2500	5175.CC	ARM431
50708721	SSP1274	5087.57	SSP2501	5175.CE	ARM430
50708722	SSP1273	5087.57	SSP2502	5175.CF	ARM919
50709579	ARM072	5087.58	SSP2420	5175CG	ARM433
50709580	ARM071	5087.60	SSP2499	5175CH	ARM432
50710620	ARM072	5087.61	SSP2137	5175CN	ARM433
50710621	ARM071	5087.62	SSP2509	5175CP	ARM432
50710905	ARM082	5087.64	SSP2509	517601G000	SSP1857
50710906	ARM081	5087.65	SSP1317	51760-2E000	SSP1870
5072444AA	SSP1446	5087.65	SSP2167	51760-2E010	SSP1870
5072444AA	SSP1447	5087.68	SSP2497	517602G000	SSP1858
5072445AA	SSP1446	5087.69	SSP2498	517602R000	SSP1872
5072445AA	SSP1447	5087.70	SSP2167	51770-2E000	SSP1870
5080.7	SSP1317	5087.71	SSP2144	51770-2E010	SSP1870
5080.70	SSP1317	5087.71*	SSP2145	5178.17	SSP2508
5085407AK	ARM441	5087.74	SSP2144	5178.18	SSP2507
5085408AK	ARM440	5087.76	SSP2512	5178.21	SSP2508
5086282AA	SSP0385	5090033AB	SSP1186	5178.22	SSP2507
5087.30	SSP2141	5093857AA	SSP0384	5178.30	SSP2508
5087.33	SSP2142	5094006AA	SSP0383	5178.31	SSP2507
5087.34	SSP2137	5105040AC/5105040AH	SSP1865	5178.43	SSP2508
5087.35	SSP1326	part of		5178.44	SSP2507
5087.37	SSP1327	5105040AD	ARM629	5178.46	SSP2503
5087.39	SSP2137	5105040AH	ARM629	5178.47	ARM918

O.E.	MAGNETI MARELLI	O.E.	MAGNETI MARELLI	O.E.	MAGNETI MARELLI
5178.48	SSP2422	543803U000	SSP2284	545004B000	ARM835
5178.49	SSP2421	544174AA00	SSP1901	545004BA0A part of	SSP1926
5178.52	SSP2503	545000002R	ARM978	545004CA0A part of	SSP1926
51805862	SSP1285	5450000QAD	ARM942	545004CUA0 part of	SSP1926
51805863	SSP1284	5450000QAH	ARM964	545004EA0A	ARM867
51810124	SSP1324	545000M010	ARM835	545004EA0B	ARM867
51810124*	SSP1324	545000M020	ARM835	545004F105	ARM847
51810664/665 part of	SSP1195	545000M060	ARM835	545004M410	ARM861
5183761AA	SSP1406	545000W000*	ARM855	545006069R	ARM938
51857135	ARM082	545000X000	ARM612	545006069R part of	SSP1943
51857136	ARM081	545001535R	ARM448	545006542R	ARM448
51875886SK part of	SSP1359	54500-1E100	ARM604	545006F600	ARM849
51961341/59820* part of	SSP1826	545001F000	ARM641	545007106R	ARM972
		545001HA0C	ARM851	545009207R	ARM960
51965673 part of	SSP1359	545001HA0C/545011HA0C part of	SSP1920	545009F000	ARM839
52013468AB	SSP1408			54500A2600	ARM643
5201-3468AB	SSP1408	545001J500	ARM606	54500A6200	ARM610
52013468AC	SSP1408	545001KA0B	ARM863	54500AV600	ARM841
5201-3468AC	SSP1408	545001P100	ARM647	54500AV600*	SSP1924
52014014 part of	SSP0070	545001W000	ARM645	54500AV606	ARM841
52059975AC	SSP2267	545001Y000	ARM639	54500AV60A	ARM841
52060011AB	SSP2268	545002B100	ARM622	54500AX600	ARM845
52087771AB	SSP2266	54500-2E010	ARM641	54500BB00A	ARM865
52088319AB	SSP2265	54500-2E030	ARM641	54500BC41A	ARM845
52088636AD	ARM627	545002F500	ARM839	54500C8000	ARM617
52088637AD	ARM628	545002H000	ARM608	54500CC40A	ARM853
52088662AB	SSP1336	545002K200	ARM651	54500EB300	ARM857
52088869AA	SSP0467	545002K500	ARM651	54500JD000	ARM865
52088870AA	SSP0466	545002K600	ARM649	54500JD000 part of	SSP1926
52089467AB	SSP1335	545002P000	ARM634	54500JD00D	ARM865
52089486AE	SSP1334	545002U711	ARM849	54500JG00B	ARM865
52089980A	ARM625	545002W200	ARM624	545010009R	ARM979
52089981A	ARM626	545002Y000	ARM600	545010012R	ARM979
52090206AF	SSP1862	545002Y002	ARM600	5450100QAD	ARM943
52124840AB	ARM460	545003VU0A	ARM851	5450100QAH	ARM965
52125366AA	SSP0390	545003VU0A/545013VU0A part of	SSP1920	545010294R	ARM973
52125367AA	SSP0391			545010M010	ARM836
52128520AA	SSP1446	545003Z000	ARM615	545010M020	ARM836
52128521AA	SSP1447	545004055R	ARM960	545010M060	ARM836
5236823*	SSP2478	545004269R	ARM446	545010W000*	ARM856
543175784R	SSP2528	545004529R	ARM972	545010X000	ARM611



O.E.	MAGNETI MARELLI	O.E.	MAGNETI MARELLI	O.E.	MAGNETI MARELLI
545011362R	ARM447	545019956R part of	SSP1943	545244330A	SSP1900
545011727R	ARM973	545019969R	ARM449	5452450J00	ARM837
54501-1E100	ARM603	545019F000	ARM840	5452486J10	ARM837
545011F000	ARM640	54501A2600	ARM642	54524AV600	ARM843
545011HA0C	ARM852	54501A6200	ARM609	54524EA000	SSP1923
545011J500	ARM605	54501AV600	ARM842	54524EB30A	ARM859
545011KA0B	ARM864	54501AV600*	SSP1924	545252F010	ARM838
545011KA0B/545001KA0B part of	SSP1925	54501AV606	ARM842	545252J001	ARM838
545011P100	ARM646	54501AV60A	ARM842	5452550J00	ARM838
545011W000	ARM644	54501AX600	ARM846	5452586J10	ARM838
545011Y000	ARM638	54501BC41A	ARM846	54525AV600	ARM844
545012B100	ARM621	54501C8000	ARM616	54525EB30A	ARM860
54501-2E010	ARM640	54501CC40A	ARM854	545300U000	SSP1856
54501-2E030	ARM640	54501EB300	ARM858	545302K000	SSP1873
545012E030 / 545002E030 part of	SSP1871	54501JD000	ARM866	545303B000	SSP1860
545012F500	ARM840	54501JD000 part of	SSP1926	545303J000	SSP1855
545012H000	ARM607	54501JD00D	ARM866	545303S000	SSP1853
545012K200	ARM650	54501JY00A	ARM866	545303S100	SSP1859
545012K500	ARM650	5450200Q0C	ARM958	545303X000	SSP1856
545012K600	ARM648	5450200QAB	ARM956	545303Z000	SSP2248
545012P000	ARM633	5450300Q0C	ARM959	54530C5100	SSP1868
545012U711	ARM850	5450300QA3	ARM957	545400U500	SSP0101
545012W200	ARM623	5450322A00	SSP1854	54570-3E000	SSP1866
545012Y000	ARM599	545033BA00	SSP1860	54570-3E001	SSP1866
545012Y002	ARM599	545041327R	ARM948	5461600QAC	SSP2522
545013VU0A	ARM852	545045297R	ARM980	5461600QAC	SSP2523
545013Z000	ARM614	545045297R part of	SSP1959	546180001R	SSP2520
545014055R	ARM961	545046817R	ARM970	546180002R	SSP2525
545014BA0A part of	SSP1926	545047275R part of	SSP1960	546180002R*	SSP2526
545014CA0A part of	SSP1926	545048506R	ARM970	546180002R*	SSP2527
545014CUA0 part of	SSP1926	545050303R part of	SSP1960	546180004R	SSP2515
545014EA0A	ARM868	545050510R	ARM971	546180004R*	SSP2516
545014EA0B	ARM868	545055708R	ARM949	5461800QAA	SSP2513
545014F105	ARM848	545055711R	ARM971	5461800QAB	SSP2514
545014M410	ARM862	545057449R	ARM981	5461801F00	SSP2459
545016746R	ARM449	545057449R part of	SSP1959	546180W001	SSP2459
545016838R	ARM961	54510-3E000	ARM632	546181944R	SSP2522
545016F600	ARM850	54520-3E000	ARM631	546181AA0A	SSP2472
545019956R	ARM939	545203E000 part of	SSP1867	546181AA0E	SSP2472
		545242F010	ARM837	546183JA0C*	SSP2474
		545242J001	ARM837	546184M400	SSP2466

O.E.	MAGNETI MARELLI	O.E.	MAGNETI MARELLI	O.E.	MAGNETI MARELLI
546184U000	SSP2468	54830-2E000	SSP2237	555302H000	SSP2244
5461850J20	SSP2446	548302H000	SSP2242	555302S200	SSP2227
5461850Y00	SSP2444	548302H000*	SSP2243	555302W100	SSP2262
546187005R	SSP2532	548302H100	SSP2242	555303R000	SSP2245
546187005R	SSP2533	548302K000	SSP2287	555304A001	SSP2230
546189U00A	SSP2450	548302S200	SSP2226	555304H000	SSP2234
54618AU000	SSP2447	548302W000	SSP2260	55530C5000	SSP2276
54618AX600	SSP2451	548303U000	SSP2284	555402W110	SSP2261
54618BC40A	SSP2450	548303Z000	SSP2249	555403R000	SSP2245
54618CA010	SSP2455	548304H000	SSP2232	555403Z000	SSP2248
54618CK000	SSP2453	548304L000	SSP2235	555404H000	SSP2233
54618CY00A	SSP2469	548304L000	SSP2285	55540C5000	SSP2276
54618D5010	SSP2444	54830B4000	SSP2247	55580-3E000	SSP2272
54618EA010	SSP2461	54830C5000	SSP2275	55580-3E050	SSP2273
54618JA000	SSP2472	54830C8000	SSP2250	55618 JE20A	SSP2470
54618JD00A	SSP2472	54830FD000	SSP2280	55618JD00A	SSP2470
54618JX00A	SSP2452	548400X000	SSP2246	55618JY00B	SSP2470
54618JX30A	SSP2452	54840-1E000	SSP2238	55619JD00A	SSP2471
546681AA0A	SSP2473	548401G500	SSP2238	55619JE20A	SSP2471
546681AA0E	SSP2473	548401J000	SSP2240	55619JY00B	SSP2471
546683JA0B*	SSP2475	548402B000	SSP2255	55700751	SSP1256
546684U000	SSP2467	548402B000*	SSP2256	55703232	SSP1255
54668AU000	SSP2448	548402B200	SSP2255	561407151A*	ARM1041
54668CA000	SSP2454	548402C000	SSP2238	561407152A*	ARM1040
54668CC010	SSP2456	548402K000	SSP2286	562600F001	SSP2460
54668EA010	SSP2462	548404H000	SSP2231	562600W001	SSP2460
54668JA000	SSP2473	54840B4000	SSP2246	56261-0E000	SSP2463
54668JD00A	SSP2473	551002S000	ARM601	562611AA0A	SSP2457
54810-3E000	SSP2274	551002S050	ARM601	562611AA0B	SSP2458
54811-3E010	SSP2271	551003Z000	ARM613	562614F702	SSP2449
54811-3E060	SSP2270	55100A6005	ARM618	562614F725	SSP2449
54820FD000	SSP2281	551100019R	SSP2518	5626186J25	SSP2445
548300U000	SSP2235	551100020R	SSP2517	56261AV611	SSP2463
548300X000	SSP2247	551107894R	ARM451	56261AW000	SSP2463
548301G000	SSP2239	551107916R	SSP2451	56261EA500	SSP2464
548301G500	SSP2239	551119305R	ARM450	56261EA510	SSP2465
548301J000	SSP2241	55220-2E010	ARM602	565400U500	SSP0101
548302B000	SSP2257	555301H000	SSP2244	565402H000	SSP0106
548302B000*	SSP2258	555302B000	SSP2259	565402K000	SSP0105
548302B200	SSP2257	555302B200	SSP2259	565403J000*	SSP0105
548302C000	SSP2239	55530-2E000	SSP2236	56540A6000	SSP0107



O.E.	MAGNETI MARELLI	O.E.	MAGNETI MARELLI	O.E.	MAGNETI MARELLI
56540C8000	SSP0110	56820C8000	SSP0460	5U0407366A	SSP1963
568200U500	SSP0447	56820C8900	SSP0459	5X433B438AA	SSP2224
568200U590	SSP0446	56820C9000	SSP0459	60620565	SSP1267
568200X000	SSP0456	56825C1090	SSP0470	60620566	SSP1282
568200X900	SSP0456	577240X000	SSP0108	60627290/291	SSP1233
568201G000	SSP0473	577241G000	SSP0122	60627290/291	SSP1234
568201G900	SSP0474	577241G100	SSP0121	60627290/291	SSP1235
568201W000	SSP0447	577241J000	SSP0104	60682636	SSP1272
568201W090	SSP0446	577241Y500	SSP0124	6140350007	SSP1213
568201Y500	SSP0477	577242B000	SSP0112	6570gr	ARM499
568201Y501	SSP0479	57724-2E000	SSP0103	68004085AA	SSP1863
568201Y550	SSP0476	577242P000	SSP0118	680196443AB	SSP1351
568201Y551	SSP0478	577242P100	SSP0117	68022600AD	ARM463
568202B000	SSP0463	577242S000	SSP0099	68022601AD	ARM464
568202B900	SSP0462	577242S100	SSP0099	68028831AC	SSP1352
56820-2E000	SSP0449	577242W000	SSP0113	680288331AR	SSP1352
568202E900	SSP0448	577243J000	SSP0100	68029024AA	SSP2155
568202H000	SSP0453	577243Z000	SSP0109	68033171AB	SSP0382
568202H090	SSP0452	577244H100	SSP0102	68040223AE	SSP0063
568202K000	SSP0451	57724C5000	SSP0119	68040224AA	SSP1391
568202K050	SSP0450	57731-3E010	SSP0115	68040225AA	SSP0062
568202P000	SSP0463	57732-3E010	SSP0116	68045130AE	ARM465
568202P900	SSP0462	5927293	SSP1271	68045131AE	ARM466
568202S000	SSP0441	5C0407152B*	ARM1060	68066486AA	SSP0114
568202S050	SSP0440	5M8Z5A486A	SSP2402	68069646AB	SSP0392
568202W000	SSP0465	5N0407151*	ARM1065	68069647AB	SSP0393
568202W050	SSP0464	5N0407152*	ARM1064	68069648AB	SSP1825
568203B000	SSP0461	5Q0407151J	ARM168	68069654AB	SSP2158
56820-3E000	SSP0469	5Q0407151J*	ARM1059	68069655AB	SSP2159
568203E900	SSP0468	5Q0407152J	ARM167	68069682AA	SSP2160
568203Q000	SSP0441	5Q0407152J*	ARM1058	68079723AB	ARM469
568203Q500	SSP0440	5Q0407365A	SSP1977	68091836AA	SSP2156
568203V100	SSP0457	5Q0407366A	SSP1976	68091837AA	SSP2157
568203V190	SSP0458	5Q0501529C	ARM1056	68091853AA	SSP2161
568203X000	SSP0455	5Q0505323C	ARM1057	68105872AA	SSP0067
568203X090	SSP0454	5Q0505323D	ARM1057	68105872AB	SSP0067
568204H000	SSP0445	5Q0505465A	SSP2579	68141049AA	SSP1408
568204H100	SSP0444	5Q0505465C	SSP2579	68156146AA	SSP0381
56820A6000	SSP0455	5R3Z5C488AA	SSP2201	68156902AA	SSP0396
56820A6090	SSP0454	5R3Z5C488BA	SSP2202	68156905AA	SSP0395
56820C1000	SSP0471	5U0407365A	SSP1964	68156906AA	SSP0394

O.E.	MAGNETI MARELLI	O.E.	MAGNETI MARELLI	O.E.	MAGNETI MARELLI
68157856AA	SSP0061	6N0407151*	ARM1075	6R0407151F**	ARM1077
68158377AA	SSP0068	6N0407365	SSP1986	6R0407152**	ARM986
68158379AA	SSP0064	6N0407365*	ARM1075	6R0407152A**	ARM1076
68159271AA	SSP1821	6N0407365*	SSP1999	6R0407152F**	ARM1076
68164072AB	SSP0069	6N0407365A*	ARM1074	6R0407365	SSP1964
68185502AB	SSP0397	6N0407366	SSP1985	6R0407366	SSP1963
68185503AB	SSP0398	6N0407366*	SSP1998	6R0411315	SSP2536
68186554AA	SSP2146	6N0411315	SSP2587	6R0423810	SSP0276
68186554AB	SSP2146	6N0411315D	SSP2584	6R0423811A	SSP0284
68217808AA	ARM461	6N0419803	SSP0274	6R0423812A	SSP0283
68217808AA	SSP1824	6N0422803A	SSP0273	6RD423812A	SSP0661
68217809AA	ARM462	6N0422803C/804C	SSP0275	6RD423812B	SSP0661
68217809AA	SSP1824	6Q0407151D*	ARM984	6W1Z5664AA	SSP2118
6960036*	SSP2218	6Q0407151D*	ARM985	7200946 7M0407365A	SSP1984
6C0423810A	SSP0013	6Q0407365A	SSP1962	7601064	SSP1211
6C0423810B	SSP0013	6Q0407365A*	ARM985	7601065	SSP1216
6C0423810C	SSP0013	6Q0407366A	SSP1961	7601068	SSP1222
6C113289AA	SSP0434	6Q0407366A*	ARM984	7673581	SSP1269
6C113A052BD	ARM576	6Q0411315A	SSP2534	7673582	SSP1271
6C113A053BD	ARM577	6Q0411315A	SSP2535	7701472120*	SSP0237
6C113L519AA	SSP0094	6Q0411315C	SSP2534	7701473655*	SSP0237
6C113L519BA	SSP0095	6Q0411315D	SSP2534	7701473656*	SSP0230
6E0407151**	ARM987	6Q0411315F	SSP2534	77363706	SSP1344
6E0411315	SSP2588	6Q0411315G	SSP2586	77363706*	SSP1344
6E5Z3332B	SSP0153	6Q0411315N	SSP2028	77363707	SSP1344
6G913280AB	SSP0098	6Q0419803B	SSP0247	77363707*	SSP1344
6G913289AA	SSP0439	6Q0419803D	SSP0247	7775343	SSP1276
6G913290AA	SSP0438	6Q0419803F	SSP0247	7775344	SSP1275
6G915500BAA	ARM594	6Q0419804B	SSP0247	782612AC	ARM442
6G915K652XAE	ARM595	6Q0419804D	SSP0247	782613AC	ARM443
6G915K743XAD	ARM584	6Q0419804F	SSP0247	7E0407361	SSP1982
6G91SC486XAB	SSP2225	6Q0419811	SSP0284	7E5Z3078L	ARM509
6G9N3395AA part of	SSP1852	6Q0419812	SSP0283	7E5Z3079L	ARM510
6G9N3B438BA	SSP2193	6Q0423810C	SSP0248	7E8407151A	ARM1073
6G9N3B438BA*	SSP2194	6Q0423811	SSP0664	7E8407151B	ARM1073
6J6A34250B	ARM805	6Q0423811A	SSP0662	7E8407152A	ARM1072
6L1Z3078AA	ARM553	6Q0423811C	SSP0662	7E8407152B	ARM1072
6L1Z3079AA	ARM554	6Q0423811D	SSP0664	7G9N3A052BA	ARM596
6L2Z3084AA	SSP1829	6Q0423812	SSP0663	7G9N3A053BA	ARM597
6L2Z3085AA	SSP1829	6Q0423812D	SSP0663	7H0407151E	ARM1069
6N0407151*	ARM1074	6R0407151A**	ARM1077	7H0407152E	ARM1068



O.E.	MAGNETI MARELLI	O.E.	MAGNETI MARELLI	O.E.	MAGNETI MARELLI
7H0407361	SSP1982	7M0407151B	ARM1071	8D0411317D	SSP2008
7H0407361A	SSP1982	7M0407152B	ARM1070	8D0411318D	SSP2007
7H0411317	SSP2581	7M0411317D	SSP2582	8D0501530	ARM185
7H0419803C*	SSP0271	7M0422803/4EF	SSP0272	8D0505465	SSP2001
7H0419804C*	SSP0271	7M0422817	SSP0707	8D0505466	SSP2000
7H0422817B	SSP0705	7M0422817B	SSP0707	8E0407151M	ARM181
7H0422817C	SSP0705	7M0422818	SSP0706	8E0407151N	ARM180
7H0422818B	SSP0704	7M0422818B	SSP0706	8E0407505A	ARM177
7H0422818C	SSP0704	7M3407365A	SSP1984	8E0407506A	ARM175
7H5411317	SSP2580	7T1Z5K484A	SSP2217	8E0407693	ARM179
7H5411317B	SSP2580	7T4Z3280A	SSP0073	8E0407693AL	ARM217
7H5411317B*	SSP2581	7T4Z3A130A	SSP0407	8E0407693K	ARM178
7H8407361	SSP1983	7T4Z3A130B	SSP0408	8E0407693K	ARM179
7H8407361A	SSP1983	7T4Z5500A	ARM508	8E0407693T	ARM217
7H8407361A	SSP1997	7T4Z5A486AA	SSP2173	8E0407694	ARM178
7L0407021A	ARM1033	7T4Z5K483A	SSP2172	8E0407694AL	ARM216
7L0407021B	ARM1033	811419812A	SSP0282	8E0407694T	ARM216
7L0407151C	ARM1036	811419812B	SSP0282	8E0411317	SSP2015
7L0407151D	ARM1036	8200255761S	SSP1953	8E0411318	SSP2014
7L0407152C	ARM1035	8200298455/S	SSP1952	8E0419811	SSP0292
7L0407152D	ARM1035	82315794	SSP1272	8E0419811B	SSP0287
7L0411317	SSP2566	83500202 part of	SSP1205	8E0501529F	ARM186
7L0422817B	SSP0697	88955489	SSP0039	8E0501529G	ARM186
7L0422817C	SSP0697	894407365E	SSP1773	8E0501529K	ARM186
7L0422817D	SSP0697	894407366E	SSP1774	8E0501529P	ARM186
7L0422818B	SSP0696	895407147A	ARM162	8E0505323M	ARM215
7L0422818C	SSP0696	895407148A	ARM161	8E0505324M	ARM214
7L0422818D	SSP0696	8A0407365	SSP1773	8E0505465A	SSP2016
7L0422821	SSP0267	8A0407366	SSP1774	8E0505465AFK	SSP2017
7L0505323A	ARM1034	8A0505465C	SSP2001	8E0505465D	SSP2018
7L0505397	ARM238	8A0505466C	SSP2000	8E0505465F	SSP2016
7L0505398	ARM237	8D0407317D	SSP2008	8E0505465K	SSP2016
7L0505465A	SSP2568	8D0407318D	SSP2007	8E0505465T	SSP2016
7L0505466A	SSP2567	8D0407505A	ARM177	8J0407365	SSP1782
7L1Z3A130L	SSP0427	8D0407505B	ARM176	8J0407365	SSP1994
7L1Z3A130R	SSP0426	8D0407505H	ARM176	8J0407366	SSP1781
7L1Z5K483B	SSP2198	8D0407506A	ARM175	8J0407366	SSP1993
7L1Z5K483B	SSP2461	8D0407506B	ARM174	8J0423810	SSP0006
7L8407151E	ARM241	8D0407506B	ARM175	8J0423811	SSP0296
7L8407152E	ARM240	8D0407506F	ARM175	8J0423812	SSP0295
7L8501529A	ARM239	8D0407506H	ARM174	8K0407151B	ARM193

O.E.	MAGNETI MARELLI	O.E.	MAGNETI MARELLI	O.E.	MAGNETI MARELLI
8K0407151D	ARM234	8N0407151A*	ARM202	8V5Z5K484B	SSP2175
8K0407151F	ARM206	8N0407151D*	ARM202	8V613A423AAB	ARM549
8K0407151G	ARM206	8N0407152A*	ARM201	8V613A423AAC	ARM549
8K0407152B	ARM192	8N0407152D*	ARM201	8Z0407365A	SSP1962
8K0407152D	ARM233	8N0407365A	SSP1775	8Z0407366A	SSP1961
8K0407152F	ARM205	8N0407365B	SSP1775	8Z0411315C	SSP2006
8K0407152G	ARM205	8N0407365C	SSP1775	8Z0411315D	SSP2006
8K0407505A	ARM197	8N0422807A	SSP0007	8Z0419810C	SSP0276
8K0407505M	ARM230	8N0422811A	SSP0291	8Z0423803/804F part of	SSP0012
8K0407506A	ARM196	8N0422812A	SSP0290	8Z0423811A	SSP0664
8K0407506M	ARM229	8R3Z5K483A	SSP2203	8Z0423812A	SSP0663
8K0407509A	ARM199	8R3Z5K483B	SSP2203	90468636	SSP1213
8K0407509M	ARM232	8S0423811A	SSP0298	90948 02202	SSP2563
8K0407510A	ARM198	8S0423812A	SSP0297	91166461*	SSP1954
8K0407510M	ARM231	8S4Z3078A	ARM533	93171448	SSP1227
8K0407689E	SSP1780	8S4Z3078A/8S4Z3079A	SSP1834	93500972	ARM024
8K0407689F	SSP1780	part of		93500973	ARM023
8K0407693F	ARM195	8S4Z3079A	ARM534	93BB3B438CA	SSP2217
8K0407693N	ARM195	8S4Z3A130A	SSP0418	94FB3395A2B	SSP1831
8K0407693S	ARM204	8S4Z3A130B	SSP0417	94FB3395B2A	SSP1835
8K0407693T	ARM204	8T4Z3078A	ARM506	95952782/83	SSP1809
8K0407694F	ARM194	8T4Z3079A	ARM507	95VV3078AC	ARM1070
8K0407694N	ARM194	8V413A423AC	ARM559	95VV3079AC	ARM1071
8K0407694S	ARM203	8V413A424AC	ARM560	95VV5489AC	SSP2582
8K0407694T	ARM203	8V413C367AA	SSP0428	95VV5489AC*	SSP2583
8K0411317B	SSP2024	8V413C437AA	SSP0429	96288787*	SSP2145
8K0411317C	SSP2022	8V415500AA	ARM558	96436597 part of	SSP1802
8K0411317D	SSP2025	8V415C486AA	SSP2206	96436598 part of	SSP1802
8K0411317E	SSP2022	8V415K652AA	ARM557	97KB3042AC	ARM527
8K0411317E	SSP2025	8V415K743AA	ARM561	97KB3042BD	ARM523
8K0422817A	SSP0289	8V513042BD	ARM511	97KB3042BD	ARM525
8K0422817B	SSP0289	8V513042BH	ARM511	97KB3042DB	ARM523
8K0422818A	SSP0288	8V513051BD	ARM512	97KB3042FB	ARM523
8K0422818B	SSP0288	8V513051BH	ARM512	97KB3051AC	ARM528
8K0501529L	ARM200	8V513B438AB	SSP2174	97KB3051DB	ARM524
8K0501529N	ARM191	8V513B438AB*	SSP2175	97KB3051FB	ARM524
8K0501530N	ARM190	8V513B438BA	SSP2174	97KB3051FB	ARM526
8K0505323H	ARM236	8V513C437AA	SSP0410	97KB3486GA	ARM523
8K0505324H	ARM235	8V513L519AA	SSP0075	98845878	SSP1377
8M515E494AA	SSP2196	8V518C367AA	SSP0409	98AG3042AK	ARM538
8M515E494AB	SSP2196	8V5Z5K484B	SSP2174	98AG3051AK	ARM539



O.E.	MAGNETI MARELLI	O.E.	MAGNETI MARELLI	O.E.	MAGNETI MARELLI
98AG3289AA	SSP0419	A1663380315	SSP0135	A2223201789	SSP2384
98AG3290AA	SSP0420	A1663500106	ARM694	A2463200689	SSP2298
98AG3B438AB	SSP2178	A1663500206	ARM693	A2463200789	SSP2299
98AG3B438AD	SSP2188	A1663500306	ARM688	A2463380000	SSP0132
98AG3L519AA	SSP0083	A1723200089	SSP2302	A2463500053	ARM680
98AG5500AG	ARM535	A2043300903	SSP0486	A2463500406	ARM781
98AG5K652AK	ARM537	A2043301003	SSP0485	A2463500506	ARM780
98AG5K743AF	ARM536	A2053230717	SSP2358	A2463501006	ARM681
98AX3270AA	SSP0419	A2053230817	SSP2357	A2513301907	ARM736
98AX3270BA	SSP0420	A2053230917	SSP2356	A2513302007	ARM735
98FB3042BC	ARM519	A2053231017	SSP2355	A4153200189	SSP2519
98FB3042BD	ARM519	A2053260317	SSP2360	A4153300200	ARM656
98FB3051BC	ARM520	A2053260417	SSP2359	A4153300300	ARM657
98FB3051BD	ARM520	A2053305501	ARM787	A4154600000	SSP0239
9E5Z5500A	ARM529	A2053305601	ARM786	A4154600005	SSP0652
9L3Z3050A	SSP1838	A2053305901	ARM791	A4154600105	SSP0651
9L3Z3280A	SSP0088	A2053306001	ARM790	A4473200089	SSP2322
9L3Z5K483D	SSP2200	A2053506303	ARM717	A4473200189	SSP2324
9L3Z5K483D	SSP2464	A2054600005	SSP0520	A4473200289	SSP2323
9R3Z3280B	SSP0090	A2054600105	SSP0519	A4473200389	SSP2321
9S4Z3280A	SSP0081	A2054600405	SSP0141	A4473200489	SSP2320
9S4Z3280B	SSP0082	A2054600605	SSP0522	A4473301407	ARM687
9S513078AC	ARM476	A2054600705	SSP0521	A4473301507	ARM686
9S513078AC	ARM531	A2054600805	SSP0142	A4474600048	SSP0507
9S513078BC	ARM475	A2113302903	SSP0148	A4474600055	SSP0134
9S513078BC	ARM530	A2123302803	SSP0129	A4474600148	SSP0506
9S513270AA	SSP1413	A2203201589	SSP2372	AA8Z5K484A	SSP2179
9S513270BA	SSP1412	A2203201689	SSP2371	AA8Z5K484B	SSP2180
9S515K484AB	SSP1313	A2203520502	ARM740	AE5Z3078A	ARM505
A0003301007	SSP1894	A2203521005	ARM739	AE5Z3084A	ARM503
A1563300100	ARM785	A2213500206	ARM777	AE5Z3085A	ARM504
A1563300200	ARM784	A2213500406	ARM779	AE5Z3A130A	SSP0406
A1633200032	SSP2361	A2213500606	ARM778	AE5Z3A130B	SSP0405
A1663200789	SSP2326	A2213500706	ARM773	AE5Z5500A	ARM502
A1663200889	SSP2325	A2213500806	ARM772	AE5Z5K483A	SSP2171
A1663300107	ARM692	A2213501006	ARM776	AL3Z5K483A	SSP2199
A1663300207	ARM691	A2213501153	ARM775	AS4Z5K484A	SSP2185
A1663300235	SSP1881	A2213501253	ARM774	AV613A423MA	ARM546
A1663300403	SSP0508	A2223201089	SSP2387	AV613A423PA	ARM546
A1663301707	ARM690	A2223201189	SSP2388	AV613A424MA	ARM547
A1663301807	ARM689	A2223201689	SSP2383	AV613A424PA	ARM547

O.E.	MAGNETI MARELLI	O.E.	MAGNETI MARELLI	O.E.	MAGNETI MARELLI
AV613B438AA	SSP2190	BE823A131A	SSP0410	BV6Z3079F	ARM568
AV613B438AA*	SSP2191	BE8Z3078A	ARM511	BV6Z3A130E	SSP0424
AV613B438BA	SSP2197	BE8Z3078A part of	SSP1832	BV6Z5500D	ARM569
AV613B438BAN	SSP2190	BE8Z3079A	ARM512	C13219141	SSP2490
AV615500CB	ARM542	BE8Z3079A part of	SSP1832	C13272605	ARM368
AV6C3L519AA	SSP0092	BE8Z3A130	SSP0409	C13272606	ARM367
AV6C3L519BA	SSP0092	BJ5728C10	ARM797	C2S12013	SSP0437
AV6C3L519BAN	SSP0092	BK213289AA	SSP0436	C2S19367	SSP1851
AV6Z3280E	SSP0074	BK213A052AE	ARM582	C2S26883	SSP2222
AV6Z5500B	ARM542	BK213A053AE	ARM583	C2S26883	SSP2223
AV6Z5K484B	SSP2197	BK213B438AA	SSP2216	C2S26883	SSP2224
B196FB3L519BA	SSP0072	BK213L519AA	SSP0096	C2S37075	SSP1851
B32H34300A	ARM793	BK313A052AD	ARM578	C2S8390	SSP1851
B32H34300C	ARM793	BK313A053AD	ARM579	C51334300	ARM793
B32H34300D	ARM793	BL5Z3050A	SSP1830	C51334350	ARM794
B32H34350	ARM794	BP4K28170D	SSP2192	C521564	SSP0038
B32H34350A	ARM794	BP4K28170G	SSP2192	C96626247	SSP2126
B32H34350C	ARM794	BP4K28170H	SSP2192	C96626248	SSP2125
B32H34350D	ARM794	BP4K34170C	SSP2392	C96626667	SSP0354
B45A28200	ARM798	BP4K34300B	ARM793	C96639918	SSP1794
B45A28250	ARM799	BP4K34300E	ARM793	C96819161	ARM391
B45A34150	SSP2394	BP4K34350E	ARM794	C96819162	ARM390
B45A34170	SSP2395	BP4L32240	SSP0150	C96852964	SSP1808
B45A34300	ARM800	BP4L32280	SSP0537	CR3Z3078D	SSP1840
B45A34350	ARM801	BP4L32290	SSP0538	CR3Z5C488Q	SSP2204
B60P34300	ARM800	BPN734300A	ARM800	CR3Z5C488R	SSP2205
B60P34350	ARM801	BPN734300A	ARM801	CV613A423AAC	ARM562
B60S34300	ARM800	BR3Z3280A	SSP0091	CV613A424AAC	ARM563
B60S34350	ARM801	BR3Z3280B	SSP0091	CV615C486AAB	SSP2206
BB5Z3280A	SSP0079	BV613A424AAB	ARM550	CV615K652AAA	ARM598
BB5Z3A130B	SSP0414	BV613A424AAC	ARM550	CV6Z3078C	ARM563
BB5Z5K483A	SSP2182	BV613L519AA	SSP0085	CV6Z3079F	ARM562
BB5Z5K484A	SSP2181	BV613L519AB	SSP0085	CV6Z5500J	ARM598
BBM234170A	SSP2393	BV613L519AC	SSP0085	CV6Z5500L	ARM536
BBM234300	ARM795	BV615C486BAA	SSP2195	CV6Z5K484F	SSP2596
BBM234300/350 part of	SSP1896	BV615K652AE	ARM545	D65132240	SSP0149
BBM234300A	ARM795	BV615K652ED	ARM548	D65132280	SSP0535
BBM234350	ARM796	BV615K743AA	ARM536	D65132290	SSP0536
BBM234350A	ARM796	BV6C3C437BA	SSP0424	D65134170	SSP2174
BE5Z3078B	ARM509	BV6C3C437BB	SSP0424	D65134170*	SSP2175
BE5Z3079B	ARM510	BV6Z3078F	ARM567	D65134300B	ARM511



O.E.	MAGNETI MARELLI	O.E.	MAGNETI MARELLI	O.E.	MAGNETI MARELLI
D65134350B	ARM512	DG9Z3A130A	SSP0430	G62A28500B	ARM529
D85201AA0A	SSP0576	DG9Z3A130B	SSP0431	G6JA34J00C	ARM804
D85201HA0A	SSP0573	DG9Z5500A	ARM566	G6JA34J050	ARM805
D85201KA0A	SSP0588	DG9Z5C486A	SSP2183	GB5Z3078C	ARM555
D85204EA0A	SSP0592	DG9Z5K484A	SSP2183	GB5Z3079A	ARM556
D8520CB025	SSP0575	DV613A423AF	ARM572	GHP934300C	ARM812
D8520EW00A	SSP0586	DV613A423AF part of	SSP1845	GHP934300D	ARM812
D8520JA00A	SSP0576	DV613A424AF	ARM573	GHP934350C	ARM813
D8520JG00A	SSP0590	DV613A424AF part of	SSP1844	GHP934350D	ARM813
D8520JY00A	SSP0637	EG2132240	SSP0152	GHT232240A	SSP0151
D85211AA0A	SSP0177	EG2132280	SSP0541	GHT232280	SSP0539
D85211HA0A	SSP0175	EG2132280A	SSP0541	GHT232290	SSP0540
D85211KA0A	SSP0182	EG2132280B	SSP0541	GJ6A28170A	SSP2402
D8521JG00A	SSP0183	EG2132290	SSP0542	GJ6A28500D	ARM529
D85401KA0A	SSP0589	EG2132290A	SSP0542	GJ6A34150A	SSP2400
D86401AA0A	SSP0577	EG2132290B	SSP0542	GJ6A34170A	SSP2401
D86401HA0A	SSP0574	EH4434300	ARM802	GJ6A34200B	ARM804
D86404EA0A	SSP0593	EH4434350	ARM803	GJ6A34300B	ARM806
D8640EW00A	SSP0587	EH4434350/300 part of	SSP1897	GJ6A34300C	ARM806
D8640JA00A	SSP0577	ES3008RL	SSP1406	GJ6A34300D	ARM806
D8640JG00A	SSP0591	ES80311	SSP0350	GJ6A34540	SSP1898
D8640JY00A	SSP0638	F15128170	SSP2389	GJ6A34J00B	ARM509
D8E211AA0A	SSP0177	F15134150	SSP2390	GJ6A34J00C	ARM509
DA5A34170	SSP2410	F15134170	SSP2391	GJ6A34J00D	ARM509
DA782612AC	ARM442	F1FZ3078A	ARM570	GJ6A34J50B	ARM510
DA782613AC	ARM443	F1FZ3079A	ARM571	GJ6A34J50C	ARM510
DD3234170	SSP2176	F5TZ3082A part of	SSP1843	GJ6A34J50D	ARM510
DD3234300	ARM513	F75A5C491BA	SSP2207	GJ6E32240	SSP0153
DD3234350	ARM514	FG9C3A052ANB	ARM564	GJ6E32280	SSP0543
DE9032240	SSP0076	FG9C3A053ANB	ARM565	GJ6E32280A	SSP0543
DE9032280	SSP0411	FL3Z3280A	SSP0089	GJ6E32290	SSP0544
DE9032290	SSP0412	FR3Z3280A	SSP0089	GJ6E32290A	SSP0544
DG1Z5K484A	SSP2179	FR3Z3A130A	SSP0432	GK2A28500	ARM529
DG1Z5K484B	SSP2180	FR3Z5K483A	SSP2210	GK2A34170	SSP2401
DG9C3289CA	SSP0415	G26A28500A	ARM529	GP9A34200C	ARM804
DG9C3290CA	SSP0416	G26A28500B	ARM529	GP9A34250C	ARM805
DG9C3B438ANC	SSP2183	G26A28500D	ARM529	GR3Z3280C	SSP0089
DG9C3D032BA	SSP0080	G26A28C10	ARM502	GS1D28170	SSP2403
DG9C5500BXA	ARM532	G26A28C10	ARM807	GS1D32240	SSP0154
DG9C5C486AXC	SSP2184	G46C34300	ARM812	GS1D32280	SSP0545
DG9Z3280A	SSP0093	G46C34350	ARM813	GS1D32290	SSP0546

O.E.	MAGNETI MARELLI	O.E.	MAGNETI MARELLI	O.E.	MAGNETI MARELLI
GS1D34150	SSP2404	K05090033AB	SSP1186	MB267877	SSP2424
GS1D34170	SSP2405	K05183761AA	SSP1406	MB296269	SSP1905
GS1D34200A	ARM810	K05272324AC	SSP2147	MB297969	SSP0165
GS1D34200C	ARM810	K52125483AA	SSP1442	MB303374	SSP1987
GS1D34250A	ARM811	K52125484AA	SSP1443	MB349475	SSP1900
GS1D34250C	ARM811	K6540	SSP1793	MB518206	SSP1902
GS1D34300G	ARM808	K68052655AA	SSP1308	MB518961	SSP1987
GS1D34300H	ARM808	K7425	ARM445	MB518982	SSP2414
GS1D34300J	ARM808	K7427	ARM444	MB527169	SSP0552
GS1D34300L	ARM808	KD3128170	SSP2396	MB527349	SSP1901
GS1D34350G	ARM809	KD3128190	SSP2397	MB527350	SSP1901
GS1D34350H	ARM809	KD3132240	SSP0155	MB527383	SSP1900
GS1D34350J	ARM809	KD3132280	SSP0547	MB527385	SSP2413
GS1D34350L	ARM809	KD3534170	SSP2406	MB527650	SSP0550
GS7Z3078A	ARM565	KD3534350D	ARM813	MB573043	SSP2414
GS7Z3079A	ARM564	KD3534350F	ARM813	MB598023	SSP0708
K01134160A	SSP2277	KD3534350G	ARM813	MB616286	SSP0551
K04656934AA	SSP2148	KD5334300D	ARM812	MB672370	SSP2416
K0465693AAB	SSP1303	KD5334300E	ARM812	MB808076	SSP2415
K0465693AAB	SSP2148	KD5334300F	ARM812	MB831037	SSP1905
K04694855	SSP1301	KD5334300G	ARM812	MB831038	SSP1906
K04762861AA	SSP1184	KDX5332240	SSP0120	MB860829	SSP1904
K04766423AA	ARM138	KT6C113K209AA	SSP1847	MB860830	SSP1904
K04766423AB	ARM137	KTBK213K209AB	SSP1849	MB892982	SSP2414
K04766423AB	ARM138	KTBK313K209AA	SSP1848	MB912076	SSP0442
K04766423AC	ARM138	L20628170A	SSP2407	MB912076	SSP0708
K04766423AD	ARM137	L20634150A	SSP2390	MB912519	SSP0551
K04766423AD	ARM138	L20634150A	SSP2391	MDX5032280	SSP0472
K04766423AE	ARM138	L20634150A	SSP2398	MN101368	SSP2420
K04766424AA	ARM137	L20634170A	SSP2399	MN184194	SSP2421
K04766424AB	ARM137	LR002609	SSP0438	MN186217	ARM825
K04766424AB	ARM138	LR002610	SSP0439	MN186218	ARM826
K04766424AC	ARM137	M884359	SSP2589	MR131680	SSP2590
K04766424AD	ARM137	MB109585	SSP1899	MR241031	SSP0549
K04766424AD	ARM138	MB166426	SSP0550	MR241032	SSP0548
K04766424AE	ARM137	MB176309	SSP1900	MR241623	SSP1901
K04766435AA	SSP1308	MB192430	SSP0551	MR244901	SSP0165
K04766962AA	SSP1307	MB241623	SSP1901	MR267875	SSP2230
K04797706	SSP1405	MB241982	SSP0552	MR272116	SSP2431
K04895483AB	SSP1305	MB241982	SSP0708	MR272118	SSP2589
K0489548AB	SSP1306	MB267876	SSP2423	MR296270	SSP1906



O.E.	MAGNETI MARELLI	O.E.	MAGNETI MARELLI	O.E.	MAGNETI MARELLI
MR297333	SSP2151	SE028140104A*	ARM149		
MR333763	SSP2150	SE141140104A	SSP1187		
MR374521	SSP2424	SE141156110A	ARM150		
MR374522	SSP2423	SE141162410A	SSP1411		
MR403027	SSP0166	SE141162449A	SSP0071		
MR403419	ARM817	SX433B438AA	SSP2222		
MR403420	ARM816	TD1132240A	SSP0156		
MR418052	SSP2426	TD1134150A	SSP2408		
MR418052	SSP2430	TD1134170A	SSP2409		
MR418053	SSP2425	TD1134300E	ARM814		
MR418053	SSP2429	TE6934350C	ARM815		
MR448255	SSP0163	W12T1043042BG	ARM580		
MR485672	SSP0559	W12T143289AA	SSP0435		
MR491358	SSP0158	W12T143B438BA	SSP2214		
MR491911	ARM818	W12T145C486AD	SSP2212		
MR496792	SSP1908	XS5C3L519AA	SSP0077		
MR496793	ARM824	Y125613042AH	ARM515		
MR496794	ARM823	Y125613051AH	ARM516		
MR496799	SSP1907	Y125613B438AC	SSP2176		
MR496799	SSP1995	Y125613B438AC*	SSP2177		
MR508135	SSP0555	Y1256J3289AC	SSP0411		
MR508136	SSP0554	Y1256J3290AC	SSP0412		
MR510267	SSP0161	Y12S6C3280KB	SSP0076		
MR535996	SSP0552	YC153289AA	SSP0434		
MR911569	ARM827	YC153395AB	SSP1846		
MR911570	ARM828	YC153L519AA	SSP0094		
MR916133	ARM828	YC153L519AB	SSP0094		
MR916134	ARM827	YC153L519BA	SSP0095		
MR954887	SSP2418	YC153L519BB	SSP0095		
MR961477	SSP2538	YC155C486AE	SSP2211		
MR977606	SSP0558	YC1A3395BA	SSP1846		
MR992191	SSP2428	YL155495AA	SSP2208		
MR992192	SSP2427	YM213395BA	SSP1984		
MR992309	SSP2412	YS413B438AB	SSP2188		
MR992310	SSP2411	YS4Z3280AA	SSP0083		
OK30B34300B	ARM635	YS4Z3A130AA	SSP0420		
OK33C34150A	SSP2278	YS4Z5500AA	ARM535		
OK33C34160A	SSP2279	YS713B438AA	SSP2189		
SE022162406A	SSP1437				
SE022162449S	SSP1361				
SE028140104A	ARM149				

Tavole di comparazione
Cross reference guide
Gegenüberstellung Cross-Referenzen
Table de correspondance
Tabla de equivalencias
Tabelas de equivalências
Πίνακας αντιστοιχιών
Tabela porównawcza
Кросс-таблица
Çapraz referans tablosu



MAGNETI MARELLI	DELPHI	MAGNETI MARELLI	DELPHI	MAGNETI MARELLI	DELPHI
ARM001	TC568	ARM096	TC1057	ARM172	TC801
ARM002	TC569	ARM111	TC2012	ARM173	TC801
ARM003	TC1063	ARM112	TC2011	ARM174	TC773
ARM004	TC1062	ARM113	TC2106	ARM175	TC1178
ARM007	TC695	ARM114	TC2105	ARM176	TC772
ARM008	TC694	ARM117	TC2076	ARM177	TC1177
ARM017	TC1135	ARM118	TC2075	ARM178	TC770
ARM018	TC1134	ARM119	TC1065	ARM179	TC769
ARM019	TC1349	ARM120	TC1064	ARM180	TC768
ARM020	TC1348	ARM121	TC1746	ARM181	TC1179
ARM023	TC860	ARM122	TC1745	ARM182	TC787
ARM024	TC859	ARM123	TC2360	ARM183	TC786
ARM025	TC781	ARM124	TC2359	ARM184	TC863
ARM026	TC1284	ARM125	TC1069	ARM185	TC951
ARM026	TC780	ARM126	TC1068	ARM186	TC3195
ARM027	TC1285	ARM127	TC1269	ARM187	TC3604
ARM027	TC1288	ARM128	TC1270	ARM188	TC3603
ARM027	TC783	ARM133	TC1012	ARM189	TC2256
ARM028	TC1287	ARM134	TC1011	ARM190	TC3338
ARM028	TC782	ARM135	TC2636	ARM191	TC3337
ARM035	TC1471	ARM136	TC2635	ARM192	TC2453
ARM036	TC1470	ARM139	TC2174	ARM193	TC2452
ARM041	TC427	ARM140	TC2173	ARM194	TC2455
ARM042	TC428	ARM141	TC2219	ARM195	TC2454
ARM058	TC1829	ARM142	TC2218	ARM196	TC2451
ARM059	TC1830	ARM147	TC1014	ARM197	TC2450
ARM060	U-D2954	ARM148	TC1013	ARM198	TC2336
ARM061	U-D2955	ARM149	TC330	ARM199	TC2335
ARM071	U-D3754	ARM151	TC1975	ARM200	TC3597
ARM072	U-D3753	ARM152	TC1974	ARM201	TC1870
ARM073	TC2245	ARM153	TC1934	ARM202	TC1869
ARM074	TC2244	ARM154	TC1933	ARM203	TC3659
ARM075	TC1432	ARM155	TC429	ARM204	TC3658
ARM076	TC1431	ARM156	TC430	ARM205	TC2709
ARM089	TC1408	ARM161	TC1142	ARM206	TC2708
ARM090	TC1407	ARM162	TC1141	ARM207	TC1828
ARM091	TC1922	ARM163	TC5630	ARM208	TC1827
ARM092	TC1921	ARM164	TC5631	ARM209	TC1813
ARM093	TC1943	ARM169	TC3265	ARM210	TC1812
ARM094	TC1942	ARM170	TC802	ARM211	TC1880
ARM095	TC1058	ARM171	TC802	ARM212	TC1879



MAGNETI MARELLI	DELPHI	MAGNETI MARELLI	DELPHI	MAGNETI MARELLI	DELPHI
ARM213	TC1878	ARM263	TC3635	ARM309	TC2246
ARM214	TC3087	ARM264	TC3611	ARM312	TC3575
ARM215	TC3088	ARM265	TC3612	ARM313	TC3574
ARM216	TC1957	ARM266	TC3616	ARM314	TC1472
ARM217	TC1956	ARM267	TC3615	ARM315	TC2074
ARM218	TC2816	ARM268	TC2400	ARM316	TC2073
ARM223	TC3600	ARM269	TC2399	ARM317	TC2066
ARM224	TC3599	ARM270	TC815	ARM318	TC2065
ARM225	TC3602	ARM271	TC814	ARM319	TC1347
ARM226	TC3601	ARM272	TC958	ARM320	TC1346
ARM229	TC2973	ARM273	TC957	ARM321	TC1345
ARM230	TC2972	ARM274	TC882	ARM322	TC2232
ARM231	TC2975	ARM275	TC1728	ARM323	TC1481
ARM232	TC2974	ARM276	TC882	ARM324	TC1482
ARM235	TC3090	ARM277	TC881	ARM325	TC1484
ARM236	TC3089	ARM278	TC1727	ARM326	TC1483
ARM237	TC3010	ARM279	TC881	ARM327	TC2868
ARM238	TC3009	ARM280	TC2597	ARM328	TC2867
ARM239	TC3221	ARM282	TC2596	ARM329	TC3012
ARM240	TC2590	ARM283	TC881	ARM330	TC3011
ARM241	TC2589	ARM286	TC1320	ARM331	TC2228
ARM242	TC3086	ARM287	TC1321	ARM332	TC2227
ARM243	TC1969	ARM288	TC1322	ARM333	TC2230
ARM244	TC1968	ARM289	TC1323	ARM334	TC2229
ARM245	TC1946	ARM290	TC958	ARM335	TC2329
ARM246	TC2862	ARM291	TC957	ARM336	TC2328
ARM247	TC2861	ARM292	TC1342	ARM337	TC3488
ARM249	TC1477	ARM295	TC1390	ARM338	TC3258
ARM250	TC1476	ARM296	TC1391	ARM339	TC3260
ARM251	TC1750	ARM297	TC1393	ARM340	TC3259
ARM252	TC1749	ARM298	TC1392	ARM341	TC2952
ARM253	TC1918	ARM299	TC969	ARM342	TC2951
ARM254	TC1945	ARM300	TC968	ARM343	TC3233
ARM255	TC1917	ARM301	TC977	ARM344	TC3232
ARM256	TC3231	ARM302	TC971	ARM345	TC3605
ARM257	TC3230	ARM303	TC970	ARM346	TC2870
ARM258	TC3610	ARM304	TC2042	ARM347	TC2869
ARM259	TC3609	ARM305	TC2041	ARM348	TC2977
ARM260	TC5032	ARM306	TC1227	ARM349	TC2976
ARM261	TC5033	ARM307	TC1226	ARM351	TC2822
ARM262	TC3636	ARM308	TC2247	ARM352	TC2821

MAGNETI MARELLI	DELPHI	MAGNETI MARELLI	DELPHI	MAGNETI MARELLI	DELPHI
ARM353	TC2823	ARM422	TC2493	ARM508	TC5605
ARM354	TC2834	ARM423	TC2492	ARM509	TC1822
ARM355	TC2833	ARM424	TC1266	ARM510	TC1821
ARM356	TC3376	ARM425	TC1265	ARM511	TC2185
ARM357	TC3377	ARM428	TC3083	ARM512	TC2184
ARM358	TC3234	ARM429	TC3082	ARM513	TC1160
ARM360	TC2980	ARM442	TC3647	ARM514	TC1159
ARM361	TC3015	ARM443	TC3646	ARM519	TC1034
ARM362	TC3014	ARM446	TC1730	ARM520	TC778
ARM363	TC2696	ARM447	TC1729	ARM525	TC1036
ARM364	TC2695	ARM448	TC2445	ARM526	TC1035
ARM369	TC5021	ARM449	TC2444	ARM527	TC1038
ARM370	TC5019	ARM452	TC3740	ARM528	TC1037
ARM371	TC1504	ARM453	TC3741	ARM530	TC3434
ARM372	TC1503	ARM459	TC5546	ARM531	TC3433
ARM378	TC2837	ARM465	TC3706	ARM532	TC3480
ARM379	TC2836	ARM466	TC3705	ARM535	TC2000
ARM380	TC1510	ARM472	TC999	ARM536	TC1262
ARM381	TC1509	ARM473	TC3256	ARM537	TC2332
ARM384	TC5606	ARM474	TC3255	ARM538	TC871
ARM385	TC5610	ARM475	TC2352	ARM539	TC870
ARM388	TC1914	ARM476	TC2351	ARM540	TC2109
ARM389	TC1913	ARM477	TC2855	ARM541	TC2108
ARM390	TC2347	ARM478	TC2854	ARM542	TC3657
ARM391	TC2346	ARM481	TC3619	ARM543	TC2253
ARM396	TC2721	ARM482	TC3618	ARM544	TC2252
ARM397	TC2720	ARM485	TC562	ARM545	TC2711
ARM400	TC2302	ARM486	TC563	ARM546	TC2723
ARM401	TC2301	ARM487	TC695	ARM547	TC2722
ARM402	TC5603	ARM488	TC694	ARM548	TC2710
ARM408	TC2706	ARM489	TC1014	ARM549	TC2675
ARM409	TC2705	ARM490	TC1013	ARM550	TC2674
ARM410	TC704	ARM491	TC1285	ARM559	TC2568
ARM412	TC706	ARM492	TC1284	ARM560	TC2567
ARM413	TC705	ARM493	TC1288	ARM561	TC3439
ARM414	TC1252	ARM494	TC1287	ARM574	TC1293
ARM415	TC1251	ARM497	TC1936	ARM575	TC1292
ARM416	TC700	ARM498	TC1935	ARM576	TC3490
ARM417	TC699	ARM499	TC1938	ARM577	TC3489
ARM420	TC1248	ARM502	TC5028	ARM580	TC1166
ARM421	TC1247	ARM504	TC5025	ARM581	TC1165



MAGNETI MARELLI	DELPHI	MAGNETI MARELLI	DELPHI	MAGNETI MARELLI	DELPHI
ARM582	TC3025	ARM639	TC3417	ARM702	TC2128
ARM583	TC3024	ARM640	TC3200	ARM703	TC2449
ARM584	TC2160	ARM641	TC3199	ARM704	TC2448
ARM585	TC3028	ARM644	TC3626	ARM705	TC1281
ARM586	TC3275	ARM645	TC3625	ARM706	TC1282
ARM587	TC1018	ARM648	TC3829	ARM707	TC1280
ARM588	TC1017	ARM649	TC3828	ARM708	TC1279
ARM589	TC1944	ARM652	TC1054	ARM709	TC2358
ARM590	TC1954	ARM653	TC1053	ARM710	TC2357
ARM591	TC1955	ARM654	TC2044	ARM711	TC2566
ARM594	TC2619	ARM655	TC2043	ARM712	TC2565
ARM595	TC3257	ARM656	TC1999	ARM713	TC2564
ARM596	TC2159	ARM657	TC1998	ARM714	TC2563
ARM597	TC2158	ARM658	TC3085	ARM715	TC2844
ARM599	TC3017	ARM659	TC3084	ARM716	TC2843
ARM600	TC3016	ARM660	TC2979	ARM717	TC3217
ARM601	TC3732	ARM661	TC2978	ARM721	TC2136
ARM603	TC2866	ARM666	TC389	ARM722	TC2135
ARM604	TC2865	ARM667	TC2033	ARM723	TC2138
ARM605	TC2470	ARM668	TC2033	ARM724	TC2137
ARM606	TC2469	ARM669	TC2032	ARM727	TC2740
ARM607	TC2172	ARM671	TC2034	ARM728	TC2739
ARM608	TC2171	ARM672	TC2035	ARM730	TC3269
ARM609	TC2857	ARM673	TC2035	ARM731	TC3268
ARM610	TC2856	ARM674	TC965	ARM732	TC3281
ARM611	TC2495	ARM675	TC964	ARM733	TC2950
ARM612	TC2494	ARM676	TC1466	ARM734	TC2949
ARM614	TC3242	ARM677	TC1465	ARM735	TC3244
ARM615	TC3241	ARM681	TC3423	ARM736	TC3243
ARM616	TC3821	ARM682	TC3704	ARM737	TC1754
ARM617	TC3820	ARM683	TC3703	ARM738	TC1751
ARM619	TC2466	ARM684	TC2121	ARM739	TC1752
ARM620	TC2465	ARM685	TC2120	ARM740	TC1753
ARM621	TC3293	ARM689	TC3054	ARM741	TC1495
ARM622	TC3292	ARM690	TC3053	ARM742	TC1494
ARM631	TC1748	ARM693	TC3449	ARM743	TC1496
ARM632	TC1747	ARM694	TC3448	ARM744	TC1497
ARM635	TC2487	ARM696	TC2128	ARM745	TC1385
ARM636	TC1973	ARM697	TC2126	ARM746	TC1386
ARM637	TC1972	ARM698	TC2125	ARM747	TC1383
ARM638	TC3418	ARM701	TC2129	ARM748	TC1384

MAGNETI MARELLI	DELPHI	MAGNETI MARELLI	DELPHI	MAGNETI MARELLI	DELPHI
ARM749	TC1493	ARM825	TC2528	ARM886	TC750
ARM750	TC1492	ARM826	TC2527	ARM887	TC1377
ARM751	TC1491	ARM827	TC2447	ARM888	TC1376
ARM752	TC1490	ARM828	TC2446	ARM889	TC2143
ARM753	TC2294	ARM835	TC854	ARM890	TC2588
ARM754	TC2293	ARM836	TC853	ARM891	TC2587
ARM755	TC2226	ARM837	TC798	ARM892	TC3739
ARM756	TC1948	ARM838	TC797	ARM893	TC3738
ARM757	TC1947	ARM839	TC983	ARM894	TC2430
ARM758	TC1950	ARM840	TC982	ARM895	TC2429
ARM759	TC1949	ARM841	TC1448	ARM898	TC610
ARM760	TC2249	ARM842	TC1447	ARM899	TC611
ARM761	TC2248	ARM845	TC1308	ARM900	TC858
ARM762	TC2334	ARM846	TC1307	ARM901	TC857
ARM763	TC2333	ARM847	TC734	ARM902	TC1912
ARM766	TC2338	ARM848	TC733	ARM903	TC1911
ARM767	TC2337	ARM849	TC2263	ARM904	TC875
ARM770	TC3081	ARM850	TC2262	ARM905	TC874
ARM771	TC3080	ARM851	TC2683	ARM906	TC956
ARM774	TC2555	ARM852	TC2682	ARM907	TC1809
ARM775	TC2554	ARM857	TC3264	ARM908	TC955
ARM793	TC1450	ARM858	TC3263	ARM909	TC1808
ARM794	TC1449	ARM859	TC2876	ARM910	TC2604
ARM795	TC5542	ARM860	TC2875	ARM911	TC2603
ARM796	TC5543	ARM861	TC1298	ARM912	TC1898
ARM802	TC3630	ARM862	TC1297	ARM913	TC1897
ARM803	TC3629	ARM863	TC2497	ARM914	TC2140
ARM804	TC1756	ARM864	TC2496	ARM915	TC2139
ARM805	TC1755	ARM865	TC2468	ARM919	TC3426
ARM806	TC1411	ARM866	TC2467	ARM922	TC3708
ARM807	TC5612	ARM870	TC792	ARM923	TC3707
ARM808	TC3393	ARM871	TC795	ARM925	TC953
ARM809	TC3392	ARM872	TC794	ARM926	TC1157
ARM810	TC3628	ARM873	TC1005	ARM927	TC1156
ARM818	TC2605	ARM874	TC1004	ARM928	TC2176
ARM819	TC3272	ARM875	TC1314	ARM929	TC2175
ARM820	TC3779	ARM876	TC1313	ARM930	TC2986
ARM821	TC2345	ARM877	TC1964	ARM931	TC2985
ARM822	TC2344	ARM880	TC1811	ARM932	TC3451
ARM823	TC3622	ARM881	TC1810	ARM933	TC3450
ARM824	TC3621	ARM885	TC751	ARM940	TC1308



MAGNETI MARELLI	DELPHI	MAGNETI MARELLI	DELPHI	MAGNETI MARELLI	DELPHI
ARM941	TC1307	ARM990	TC2482	ARM1050	TC2142
ARM942	TC1332	ARM991	TC1089	ARM1051	TC2141
ARM943	TC1331	ARM992	TC1088	ARM1052	TC2729
ARM944	TC2354	ARM993	TC1928	ARM1053	TC2728
ARM945	TC2353	ARM994	TC1927	ARM1054	TC3283
ARM946	TC2472	ARM995	TC3422	ARM1055	TC3282
ARM947	TC2471	ARM996	TC3421	ARM1057	TC3425
ARM948	TC1368	ARM997	TC2283	ARM1058	TC2864
ARM949	TC1367	ARM998	TC2282	ARM1059	TC2863
ARM950	TC1368	ARM999	TC2599	ARM1060	TC2733
ARM951	TC1367	ARM1001	TC2598	ARM1061	TC2732
ARM952	TC1365	ARM1010	TC2817	ARM1062	TC2971
ARM953	TC1364	ARM1011	TC2818	ARM1063	TC2970
ARM954	TC1264	ARM1014	TC1008	ARM1064	TC2826
ARM955	TC1263	ARM1015	TC1007	ARM1065	TC2825
ARM956	TC1468	ARM1018	TC2464	ARM1068	TC1489
ARM957	TC1467	ARM1019	TC2463	ARM1069	TC1488
ARM958	TC2462	ARM1024	TC3280	ARM1070	TC862
ARM959	TC2461	ARM1025	TC3279	ARM1071	TC861
ARM962	TC884	ARM1026	TC5570	ARM1074	TC756
ARM963	TC883	ARM1027	TC3429	ARM1075	TC755
ARM964	TC2520	ARM1028	TC3428	ARM1076	TC3212
ARM965	TC2519	ARM1029	TC1446	ARM1077	TC3211
ARM966	TC2327	ARM1030	TC1445	ARM1078	TC2094
ARM967	TC2326	ARM1031	TC3262	ARM1079	TC2093
ARM970	TC3254	ARM1032	TC3261	ARM1080	TC1545
ARM971	TC3253	ARM1033	TC2529	ARM1081	TC1544
ARM974	TC989	ARM1034	TC3594	ARM1082	TC1543
ARM975	TC988	ARM1035	TC2190	ARM1083	TC1542
ARM976	TC3271	ARM1036	TC2189	ARM1084	TC1986
ARM977	TC3270	ARM1039	TC3405	ARM1085	TC1985
ARM978	TC2551	ARM1040	TC3591	ARM1086	TC3240
ARM979	TC2550	ARM1041	TC3590	ARM1087	TC3239
ARM982	TC1932	ARM1042	TC3021	ARM1090	TC3407
ARM983	TC1931	ARM1043	TC3020	ARM1091	TC3406
ARM984	TC1330	ARM1044	TC3023	SSP0001	TL451
ARM985	TC1329	ARM1045	TC3022	SSP0002	TL540
ARM986	TC2660	ARM1046	TC2161	SSP0003	TA2001
ARM987	TC2659	ARM1047	TC2161	SSP0004	TA1644
ARM988	TC2944	ARM1048	TC1335	SSP0005	TA2000
ARM989	TC2483	ARM1049	TC1334	SSP0006	TA2485

MAGNETI MARELLI	DELPHI	MAGNETI MARELLI	DELPHI	MAGNETI MARELLI	DELPHI
SSP0007	TA1980	SSP0076	TA1897	SSP0140	TA2577
SSP0008	TA2395	SSP0077	TA1615	SSP0143	TA1946
SSP0009	TA2377	SSP0079	TA5005	SSP0144	TA2697
SSP0010	TA2873	SSP0083	TA1991	SSP0145	TA2032
SSP0013	TA3217	SSP0084	TA2049	SSP0146	TA2472
SSP0015	TA2062	SSP0086	TA2093	SSP0147	TA3047
SSP0016	TA2109	SSP0094	TA1810	SSP0148	TA2345
SSP0017	TA3230	SSP0095	TA1809	SSP0149	TA2675
SSP0018	TA3170	SSP0096	TA3186	SSP0150	TA1978
SSP0019	TA1647	SSP0097	TA1813	SSP0151	TA3258
SSP0020	TA2037	SSP0098	TA2460	SSP0152	TA3063
SSP0021	TA1907	SSP0099	TA2863	SSP0153	TA1972
SSP0022	TA1964	SSP0101	TA3204	SSP0154	TA3022
SSP0023	TA2036	SSP0103	TA2371	SSP0158	TA2851
SSP0025	TA3202	SSP0104	TA2630	SSP0159	TA3164
SSP0026	TA2780	SSP0105	TA3163	SSP0160	TA2620
SSP0028	TA2665	SSP0106	TA2492	SSP0161	TA2388
SSP0029	TA2067	SSP0107	TA3255	SSP0162	TA3271
SSP0033	TA2714	SSP0108	TA2591	SSP0163	TA2347
SSP0034	TA2070	SSP0109	TA3195	SSP0164	TA3030
SSP0038	TA2073	SSP0111	TA2101	SSP0165	TA1800
SSP0041	TA2746	SSP0112	TA2617	SSP0166	TA2374
SSP0045	TA2854	SSP0113	TA3198	SSP0167	TA1775
SSP0046	TA5262	SSP0115	TA 2053	SSP0168	TA2595
SSP0049	TA1384	SSP0116	TA2052	SSP0170	TA2629
SSP0050	TA1503	SSP0120	TA2102	SSP0171	TA1734
SSP0051	TL411	SSP0121	TA2706	SSP0172	TA2713
SSP0052	TA2521	SSP0123	TA2104	SSP0175	TA2761
SSP0053	TA3246	SSP0125	TA1660	SSP0179	TA2579
SSP0054	TA2889	SSP0126	TA2583	SSP0180	TA2057
SSP0055	TA1898	SSP0127	TA2712	SSP0183	TA2486
SSP0056	TA1470	SSP0129	TA3216	SSP0184	TA2717
SSP0057	TA1829	SSP0130	TA1752	SSP0185	TA1552
SSP0058	TA2621	SSP0131	TA2056	SSP0186	TA1551
SSP0059	TA1826	SSP0132	TA2858	SSP0187	TA2687
SSP0060	TA2752	SSP0133	TA1765	SSP0188	TA2029
SSP0065	TA2331	SSP0135	TA2899	SSP0189	TA2431
SSP0066	TA2628	SSP0136	TA2107	SSP0190	TA1904
SSP0071	TA1462	SSP0137	TA2092	SSP0191	TA1992
SSP0072	TA1611	SSP0138	TA1764	SSP0192	TA2695
SSP0075	TA2504	SSP0139	TA2462	SSP0193	TA2696



MAGNETI MARELLI	DELPHI	MAGNETI MARELLI	DELPHI	MAGNETI MARELLI	DELPHI
SSP0194	TA2900	SSP0239	TA2502	SSP0290	TA1781
SSP0195	TA1677	SSP0240	TA2894	SSP0291	TA1780
SSP0196	TA2511	SSP0241	TA2890	SSP0292	TA2383
SSP0197	TA2453	SSP0242	TA2522	SSP0293	TA2916
SSP0198	TA2355	SSP0244	TA2503	SSP0294	TA2915
SSP0199	TA2698	SSP0248	TA2372	SSP0295	TA2471
SSP0200	TA2699	SSP0249	TA2457	SSP0296	TA2470
SSP0201	TA2760	SSP0250	TA2401	SSP0299	TA2376
SSP0202	TA2496	SSP0251	TA2352	SSP0300	TA3177
SSP0203	TA3263	SSP0252	TA2397	SSP0301	TA3176
SSP0204	TA3262	SSP0253	TA2839	SSP0304	TA2061
SSP0205	TA2705	SSP0255	TA1698	SSP0305	TA2060
SSP0206	TA1384	SSP0256	TA2625	SSP0306	TA2808
SSP0207	TA1679	SSP0257	TA1747	SSP0307	TA2807
SSP0208	TA2396	SSP0258	TA2660	SSP0308	TA3221
SSP0209	TA2510	SSP0259	TA1975	SSP0309	TA3220
SSP0210	TA1949	SSP0260	TA2399	SSP0310	TA1646
SSP0211	TA2806	SSP0262	TA1936	SSP0311	TA1645
SSP0212	TA1776	SSP0263	TA2856	SSP0312	TA1876
SSP0213	TA2463	SSP0267	TA2391	SSP0313	TA1875
SSP0214	TA2578	SSP0268	TA2903	SSP0314	TA1687
SSP0215	TA2936	SSP0269	TA1905	SSP0315	TA1686
SSP0216	TA1777	SSP0270	TA2862	SSP0316	TA1906
SSP0217	TA2887	SSP0271	TA2046	SSP0317	TA1649
SSP0219	TA2089	SSP0272	TA1673	SSP0318	TA1648
SSP0220	TA1805	SSP0273	TA2020	SSP0321	TA2035
SSP0221	TA2779	SSP0274	TA1883	SSP0323	TA2063
SSP0222	TA1943	SSP0276	TA2587	SSP0324	TA3201
SSP0223	TA1816	SSP0277	TA1823	SSP0325	TA2708
SSP0225	TA1998	SSP0278	TA2121	SSP0326	TA2707
SSP0226	TA 2064	SSP0279	TA2100	SSP0327	TA3175
SSP0227	TA2014	SSP0280	TA3184	SSP0328	TA2442
SSP0228	TA2013	SSP0281	TA3172	SSP0329	TA2442
SSP0229	TA2018	SSP0282	TA1069	SSP0335	TA 2066
SSP0231	TA1874	SSP0283	TA1668	SSP0336	TA 2065
SSP0232	TA1894	SSP0284	TA1667	SSP0340	TA2704
SSP0233	TA2015	SSP0285	TA1666	SSP0341	TA2921
SSP0234	TA2015	SSP0286	TA1665	SSP0342	TA 2069
SSP0235	TA2017	SSP0287	TA1583	SSP0343	TA 2068
SSP0236	TA2018	SSP0288	TA2509	SSP0348	TA 2071
SSP0238	TA2013	SSP0289	TA2508	SSP0349	TA 2072

MAGNETI MARELLI	DELPHI	MAGNETI MARELLI	DELPHI	MAGNETI MARELLI	DELPHI
SSP0354	TA2479	SSP0434	TA1808	SSP0487	TA2632
SSP0360	TA2876	SSP0435	TA1817	SSP0488	TA2631
SSP0368	TA1155	SSP0437	TA1772	SSP0489	TA3020
SSP0369	TA1154	SSP0438	TA2448	SSP0490	TA3019
SSP0370	TA2495	SSP0439	TA2447	SSP0493	TA3215
SSP0371	TA2494	SSP0440	TA2902	SSP0494	TA3214
SSP0372	TA1828	SSP0441	TA2901	SSP0495	TA1751
SSP0373	TA1827	SSP0442	TA1516	SSP0496	TA1750
SSP0374	TA2663	SSP0443	TA2005	SSP0497	TA1984
SSP0375	TA2662	SSP0446	TA2866	SSP0498	TA1983
SSP0376	TA1825	SSP0447	TA2865	SSP0501	TA2885
SSP0377	TA1824	SSP0448	TA2390	SSP0502	TA2884
SSP0378	TA2684	SSP0449	TA2389	SSP0503	TA2787
SSP0379	TA2683	SSP0450	TA2650	SSP0504	TA2786
SSP0386	TA2330	SSP0451	TA2649	SSP0505	TA1742
SSP0387	TA2329	SSP0452	TA2481	SSP0508	TA3222
SSP0388	TA2670	SSP0453	TA2480	SSP0509	TA2106
SSP0389	TA2669	SSP0454	TA2918	SSP0510	TA2105
SSP0394	TA5439	SSP0455	TA2917	SSP0511	TA2091
SSP0395	TA5440	SSP0456	TA2590	SSP0512	TA2090
SSP0399	TA2848	SSP0461	TA1965	SSP0515	TA1683
SSP0400	TA3024	SSP0462	TA2680	SSP0516	TA2461
SSP0401	TA3023	SSP0463	TA2679	SSP0517	TA2031
SSP0404	TA3265	SSP0464	TA3183	SSP0518	TA2030
SSP0407	TA5012	SSP0465	TA3182	SSP0523	TA1945
SSP0408	TA5013	SSP0466	TA2192	SSP0524	TA1944
SSP0409	TA2499	SSP0468	TA 2051	SSP0525	TA2648
SSP0410	TA2498	SSP0469	TA 2050	SSP0526	TA2647
SSP0411	TA2027	SSP0470	TA5445	SSP0527	TA2837
SSP0412	TA2026	SSP0471	TA5446	SSP0528	TA2647
SSP0413	TA1614	SSP0472	TA2085	SSP0529	TA1961
SSP0415	TA3301	SSP0473	TA2910	SSP0530	TA1960
SSP0416	TA3300	SSP0474	TA2909	SSP0531	TA1959
SSP0419	TA1675	SSP0476	TA3229	SSP0532	TA2491
SSP0420	TA1674	SSP0477	TA3228	SSP0533	TA3227
SSP0421	TA1990	SSP0479	TA3228	SSP0534	TA3226
SSP0422	TA1989	SSP0480	TA1643	SSP0535	TA2674
SSP0423	TA2998	SSP0481	TA1659	SSP0536	TA2673
SSP0424	TA2997	SSP0482	TA1658	SSP0537	TA1977
SSP0428	TA2710	SSP0485	TA2573	SSP0538	TA1976
SSP0429	TA2709	SSP0486	TA2572	SSP0539	TA3238



MAGNETI MARELLI	DELPHI	MAGNETI MARELLI	DELPHI	MAGNETI MARELLI	DELPHI
SSP0540	TA3237	SSP0589	TA2676	SSP0635	TA2682
SSP0541	TA3075	SSP0590	TA2568	SSP0636	TA2681
SSP0542	TA3074	SSP0591	TA2567	SSP0637	TA2586
SSP0543	TA1971	SSP0592	TA3240	SSP0638	TA2585
SSP0544	TA1970	SSP0593	TA3239	SSP0639	TA1942
SSP0545	TA3026	SSP0594	TA1135	SSP0640	TA1941
SSP0546	TA3025	SSP0595	TA1680	SSP0641	TA1815
SSP0549	TA2402	SSP0596	TA1903	SSP0642	TA1814
SSP0550	TA1535	SSP0597	TA1993	SSP0643	TA2643
SSP0551	TA1193	SSP0598	TA3021	SSP0644	TA2642
SSP0552	TA1535	SSP0599	TA3162	SSP0645	TA1626
SSP0553	TA2639	SSP0600	TA1676	SSP0646	TA1625
SSP0554	TA2387	SSP0601	TA1676	SSP0647	TA1689
SSP0555	TA2386	SSP0602	TA1951	SSP0648	TA1688
SSP0558	TA2645	SSP0603	TA1950	SSP0649	TA1790
SSP0559	TA1536	SSP0604	TA2592	SSP0650	TA1789
SSP0560	TA1774	SSP0605	TA3250	SSP0651	TA2501
SSP0561	TA1773	SSP0606	TA3249	SSP0652	TA2500
SSP0562	TA2363	SSP0612	TA977	SSP0653	TA2914
SSP0563	TA2362	SSP0613	TA2385	SSP0654	TA2913
SSP0564	TA2634	SSP0614	TA2384	SSP0655	TA1436
SSP0565	TA2633	SSP0615	TA3242	SSP0656	TA1439
SSP0566	TA3174	SSP0616	TA3241	SSP0657	TA2483
SSP0567	TA3173	SSP0617	TA2337	SSP0658	TA2482
SSP0568	TA3179	SSP0618	TA2336	SSP0659	TA3244
SSP0569	TA3178	SSP0619	TA1948	SSP0660	TA3243
SSP0570	TA1489	SSP0620	TA1947	SSP0661	TA 1796
SSP0571	TA1902	SSP0621	TA2490	SSP0662	TA1795
SSP0572	TA1901	SSP0622	TA2489	SSP0663	TA1668
SSP0573	TA2878	SSP0623	TA2850	SSP0664	TA1778
SSP0574	TA2877	SSP0624	TA2849	SSP0665	TA2484
SSP0575	TA2835	SSP0625	TA2466	SSP0666	TA2078
SSP0578	TA2087	SSP0626	TA2465	SSP0667	TA2369
SSP0579	TA2571	SSP0627	TA2935	SSP0668	TA2368
SSP0580	TA2570	SSP0628	TA2934	SSP0669	TA2400
SSP0582	TA1899	SSP0629	TA1682	SSP0671	TA2867
SSP0584	TA2126	SSP0630	TA1681	SSP0672	TA1697
SSP0585	TA1254	SSP0631	TA3188	SSP0673	TA1696
SSP0586	TA2451	SSP0632	TA3187	SSP0674	TA2594
SSP0587	TA2450	SSP0633	TA1804	SSP0675	TA2593
SSP0588	TA2677	SSP0634	TA1803	SSP0676	TA1225

MAGNETI MARELLI	DELPHI	MAGNETI MARELLI	DELPHI	MAGNETI MARELLI	DELPHI
SSP0677	TA1974	SSP1189	TC1010	SSP1256	TD646W
SSP0678	TA1973	SSP1193	TC2006	SSP1258	TD297W
SSP0679	TA2627	SSP1194	TC2007	SSP1262	U-D4117
SSP0680	TA2626	SSP1196	TC828	SSP1263	U-D4116
SSP0681	TA2393	SSP1197	TC829	SSP1267	TD414W
SSP0683	TA1934	SSP1198	TC1283	SSP1269	TD237W
SSP0684	TA1933	SSP1199	TC1286	SSP1271	TD238W
SSP0685	TA2469	SSP1201	TC2170	SSP1275	TD357W
SSP0686	TA2468	SSP1202	TC2361	SSP1276	TD356W
SSP0689	TA1702	SSP1203	TC2362	SSP1277	TD424W
SSP0690	TA5001	SSP1204	TC290	SSP1278	TD423W
SSP0691	TA2412	SSP1205	TC2061	SSP1279	TD422W
SSP0692	TA2411	SSP1206	TC2062	SSP1281	TD421W
SSP0693	TA3192	SSP1211	TD378W	SSP1282	TD413W
SSP0694	TA3191	SSP1213	TD312W	SSP1283	TD432W
SSP0696	TA2155	SSP1214	TD358W	SSP1287	TC1815
SSP0697	TA2154	SSP1215	TD359W	SSP1288	TC1814
SSP0698	TA1081	SSP1216	TD382W	SSP1289	TC1777
SSP0699	TA1237	SSP1217	TD434W	SSP1291	TC1778
SSP0700	TA1915	SSP1218	TD433W	SSP1292	TC1066
SSP0701	TA1914	SSP1222	TD381W	SSP1293	TC1067
SSP0702	TA3231	SSP1225	U-D3703	SSP1294	TC1195
SSP0703	TA3232	SSP1226	TD833W	SSP1295	TC1175
SSP0704	TA2045	SSP1227	TD507W	SSP1296	TC1174
SSP0705	TA2044	SSP1228	TD415W	SSP1305	TC2149
SSP0706	TA1639	SSP1229	TD365W	SSP1306	TC2148
SSP0707	TA1638	SSP1231	TD366W	SSP1309	TC2290
SSP0708	TA1536	SSP1232	TD296W	SSP1312	TC1406
SSP0709	TA1822	SSP1233	TD573W	SSP1314	TC2102
SSP0710	TA1821	SSP1234	TD571W	SSP1315	TC1125
SSP0711	TA2120	SSP1235	TD572W	SSP1316	TC1806
SSP0712	TA2119	SSP1239	TD412W	SSP1317	TC2222
SSP0713	TA2082	SSP1241	TD644W	SSP1319	TC1909
SSP0714	TA2081	SSP1242	TD643W	SSP1321	TC2021
SSP0717	TA3291	SSP1246	TD707W	SSP1323	TC1133
SSP0718	TA3290	SSP1247	TD706W	SSP1325	TC2432
SSP1181	TC1593	SSP1248	TD353W	SSP1326	TC1191
SSP1182	TC1594	SSP1249	TD354W	SSP1327	TC1059
SSP1184	TC1991	SSP1253	TD411W	SSP1328	TC1997
SSP1187	TC254	SSP1254	TD355W	SSP1339	TC2085
SSP1188	TC1807	SSP1255	TD645W	SSP1341	TC1469



MAGNETI MARELLI	DELPHI	MAGNETI MARELLI	DELPHI	MAGNETI MARELLI	DELPHI
SSP1344	TA2497	SSP1428	TA2671	SSP1826	TC3656
SSP1347	TA1892	SSP1429	TA1607	SSP1831	TC663
SSP1348	TA1855	SSP1431	TA1671	SSP1832	TC2164
SSP1352	TA2488	SSP1433	TA2475	SSP1833	TC1158
SSP1355	TA1767	SSP1434	TA2474	SSP1835	TC837
SSP1356	TA1969	SSP1435	TA1987	SSP1836	TC1971
SSP1361	TA1375	SSP1438	TA2449	SSP1837	TC1433
SSP1362	TA1597	SSP1441	TA2033	SSP1846	TC1150
SSP1363	TA1510	SSP1448	TA2042	SSP1847	TC2851
SSP1364	TA1507	SSP1449	TA2041	SSP1849	TC1150
SSP1365	TA2002	SSP1451	TA1931	SSP1850	TC1016
SSP1366	TA1818	SSP1452	TA2715	SSP1851	TC1016
SSP1367	TA2413	SSP1773	TC502	SSP1852	TC1907
SSP1373	TA2616	SSP1774	TC503	SSP1853	TC2686
SSP1375	TA1896	SSP1775	TC1042	SSP1854	TC2001
SSP1378	TA2688	SSP1776	TC825	SSP1855	TC3366
SSP1379	TA1374	SSP1777	TC825	SSP1856	TC2664
SSP1381	TA1608	SSP1778	TC824	SSP1857	TC1910
SSP1382	TA1785	SSP1779	TC824	SSP1858	TC1990
SSP1385	TA2487	SSP1780	TC2320	SSP1859	TC2850
SSP1386	TA1988	SSP1781	TC2192	SSP1860	TC1559
SSP1389	TA1986	SSP1782	TC2191	SSP1866	TC2117
SSP1392	TA2413	SSP1783	TC2684	SSP1869	TC1733
SSP1393	TA2043	SSP1786	TC2064	SSP1870	TC2378
SSP1396	TA2341	SSP1787	TC1480	SSP1873	TC3404
SSP1397	TA2340	SSP1788	TC2623	SSP1874	TC835
SSP1398	TA1852	SSP1794	TC1896	SSP1876	TC3396
SSP1399	TA1851	SSP1795	TC1895	SSP1877	TC963
SSP1401	TA1788	SSP1798	TC1501	SSP1878	TC1430
SSP1402	TA1787	SSP1800	TC2835	SSP1879	TC931
SSP1408	TA2624	SSP1801	TC1505	SSP1882	TC1564
SSP1409	TA1031	SSP1804	TC1511	SSP1883	TC1566
SSP1414	TA1249	SSP1808	TC2153	SSP1884	TC888
SSP1415	TA1250	SSP1809	TC2860	SSP1886	TC2424
SSP1416	TA1506	SSP1815	TC420	SSP1887	TC1369
SSP1417	TA1692	SSP1816	TC420	SSP1888	TC2133
SSP1419	TA2339	SSP1817	TC485	SSP1889	TC2379
SSP1421	TA2338	SSP1818	TC3430	SSP1890	TC2380
SSP1424	TA1771	SSP1819	TC1176	SSP1891	TC1382
SSP1425	TA1770	SSP1820	TC2426	SSP1892	TC2254
SSP1427	TA2672	SSP1823	TC2407	SSP1893	TC1995

MAGNETI MARELLI	DELPHI	MAGNETI MARELLI	DELPHI	MAGNETI MARELLI	DELPHI
SSP1894	TC1995	SSP1941	TC3430	SSP1988	TC1192
SSP1895	TC2260	SSP1942	TC2673	SSP1989	TC1519
SSP1897	TC3655	SSP1944	TC233	SSP1998	TC754
SSP1898	TC3717	SSP1945	TC2028	SSP1999	TC753
SSP1899	TC595	SSP1946	TC2376	SSP2000	TC993
SSP1900	TC595	SSP1947	TC1130	SSP2001	TC992
SSP1901	TC596	SSP1948	TC2008	SSP2002	TC1040
SSP1903	TC2349	SSP1949	TC2377	SSP2003	TC1040
SSP1904	TC831	SSP1950	TC2370	SSP2004	TC1041
SSP1905	TC832	SSP1951	TC2671	SSP2005	TC771
SSP1906	TC833	SSP1952	TC1366	SSP2006	TC1341
SSP1907	TC2255	SSP1953	TC1363	SSP2007	TC930
SSP1908	TC2157	SSP1954	TC1162	SSP2008	TC929
SSP1909	TC1155	SSP1955	TC2343	SSP2009	TC771
SSP1910	TC1278	SSP1956	TC2342	SSP2010	TC2030
SSP1911	TC1277	SSP1957	TC2435	SSP2012	TC1206
SSP1913	TC2234	SSP1958	TC2416	SSP2013	TC1207
SSP1914	TC2233	SSP1961	TC1085	SSP2014	TC1291
SSP1915	TC3650	SSP1962	TC1084	SSP2015	TC1290
SSP1916	TC435	SSP1963	TC2322	SSP2016	TC2100
SSP1917	TC830	SSP1964	TC2321	SSP2018	TC1295
SSP1918	TC530	SSP1968	TC1184	SSP2019	TC1781
SSP1919	TC1306	SSP1969	TC2437	SSP2020	TC1877
SSP1920	TC2672	SSP1970	TC2606	SSP2021	TC1782
SSP1922	TC2147	SSP1971	TC1006	SSP2023	TC1790
SSP1923	TC5549	SSP1972	TC1413	SSP2024	TC2311
SSP1924	TC2405	SSP1973	TC3357	SSP2025	TC2312
SSP1925	TC2431	SSP1974	TC1994	SSP2027	TC3598
SSP1926	TC1989	SSP1975	TC1792	SSP2029	TC1815
SSP1927	TC242	SSP1976	TC1317	SSP2032	TC3617
SSP1928	TC796	SSP1977	TC1316	SSP2033	TC1474
SSP1929	TC1003	SSP1978	TC1732	SSP2034	TC1473
SSP1930	TC1312	SSP1979	TC1731	SSP2035	TC1475
SSP1931	TC1311	SSP1980	TC1732	SSP2036	TC2516
SSP1932	TC687	SSP1981	TC1731	SSP2037	TC2515
SSP1934	TC368	SSP1982	TC2089	SSP2038	TC2646
SSP1935	TC1371	SSP1983	TC2186	SSP2039	TC2645
SSP1936	TC1370	SSP1984	TC757	SSP2040	TC2537
SSP1938	TC952	SSP1985	TC754	SSP2041	TC2536
SSP1939	TC1022	SSP1986	TC753	SSP2042	TC2052
SSP1940	TC1022	SSP1987	TC2518	SSP2043	TC974



MAGNETI MARELLI	DELPHI	MAGNETI MARELLI	DELPHI	MAGNETI MARELLI	DELPHI
SSP2044	TC974	SSP2085	TC2824	SSP2165	TC1125
SSP2045	TC975	SSP2086	TC2611	SSP2171	TC5590
SSP2046	TC975	SSP2087	TC2610	SSP2175	TC2562
SSP2047	TC976	SSP2093	TC1196	SSP2176	TC2047
SSP2048	TC976	SSP2094	TC1196	SSP2178	TC720
SSP2049	TC2067	SSP2099	TC5548	SSP2179	TC5012
SSP2050	TC1272	SSP2100	TC5547	SSP2180	TC5013
SSP2051	TC932	SSP2107	TC2681	SSP2184	TC3424
SSP2052	TC932	SSP2108	TC1507	SSP2186	TC1056
SSP2053	TC1801	SSP2109	TC1506	SSP2187	TC1056
SSP2054	TC1800	SSP2110	TC1193	SSP2188	TC2022
SSP2055	TC2641	SSP2116	TC5592	SSP2189	TC1557
SSP2056	TC1389	SSP2117	TC5593	SSP2190	TC1418
SSP2057	TC1388	SSP2120	TC5595	SSP2192	TC1419
SSP2058	TC1394	SSP2121	TC5604	SSP2193	TC1919
SSP2059	TC1805	SSP2123	TC2278	SSP2195	TC2688
SSP2060	TC1804	SSP2124	TC2278	SSP2196	TC3383
SSP2061	TC1319	SSP2125	TC1988	SSP2203	TC5589
SSP2062	TC1318	SSP2126	TC1987	SSP2204	TC5596
SSP2063	TC1324	SSP2130	TC2658	SSP2205	TC5597
SSP2064	TC1555	SSP2132	TC5509	SSP2206	TC2601
SSP2065	TC2410	SSP2133	TC5586	SSP2209	TC1742
SSP2066	TC972	SSP2137	TC554	SSP2211	TC2063
SSP2067	TC973	SSP2138	TC560	SSP2212	TC1164
SSP2068	TC2069	SSP2139	TC675	SSP2213	TC1163
SSP2069	TC2068	SSP2140	TC675	SSP2214	TC1163
SSP2070	TC2070	SSP2141	TC558	SSP2215	TC2319
SSP2071	TC1479	SSP2142	TC614	SSP2217	TC529
SSP2072	TC1478	SSP2144	TC2313	SSP2219	TC1171
SSP2073	TC1485	SSP2145	TC2313	SSP2220	TC1171
SSP2074	TC2146	SSP2147	TC2593	SSP2221	TC1172
SSP2075	TC2156	SSP2149	TC5591	SSP2222	TC1154
SSP2076	TC2155	SSP2150	TC5519	SSP2223	TC1154
SSP2077	TC2258	SSP2151	TC5518	SSP2224	TC1170
SSP2078	TC2257	SSP2153	TC1502	SSP2225	TC2231
SSP2079	TC3381	SSP2154	TC2373	SSP2226	TC2700
SSP2080	TC3375	SSP2156	TC5617	SSP2227	TC2665
SSP2081	TC3374	SSP2157	TC5618	SSP2228	TC2002
SSP2082	TC2409	SSP2161	TC5616	SSP2229	TC2003
SSP2083	TC2386	SSP2162	TC1406	SSP2230	TC2050
SSP2084	TC2535	SSP2163	TC3735	SSP2235	TC3427

MAGNETI MARELLI	DELPHI	MAGNETI MARELLI	DELPHI	MAGNETI MARELLI	DELPHI
SSP2236	TC1876	SSP2294	TC2652	SSP2352	TC2057
SSP2237	TC1816	SSP2295	TC2651	SSP2353	TC2055
SSP2238	TC1570	SSP2296	TC3385	SSP2361	TC2609
SSP2239	TC1569	SSP2297	TC3384	SSP2362	TC2144
SSP2240	TC2285	SSP2302	TC3460	SSP2363	TC2134
SSP2241	TC2284	SSP2303	TC2119	SSP2364	TC2220
SSP2242	TC2152	SSP2304	TC1055	SSP2365	TC2259
SSP2244	TC1981	SSP2305	TC962	SSP2367	TC3349
SSP2245	TC2704	SSP2306	TC1549	SSP2368	TC3348
SSP2246	TC1534	SSP2307	TC1429	SSP2369	TC2224
SSP2247	TC1533	SSP2308	TC3654	SSP2370	TC1387
SSP2248	TC3352	SSP2309	TC1766	SSP2371	TC1499
SSP2251	TC1530	SSP2310	TC2269	SSP2372	TC1498
SSP2252	TC1529	SSP2312	TC2268	SSP2373	TC2098
SSP2253	TC1532	SSP2313	TC2268	SSP2374	TC2097
SSP2254	TC1531	SSP2316	TC2151	SSP2375	TC1959
SSP2255	TC2292	SSP2317	TC2150	SSP2376	TC1958
SSP2257	TC2291	SSP2325	TC3409	SSP2377	TC1926
SSP2259	TC2303	SSP2326	TC3408	SSP2378	TC1925
SSP2260	TC3356	SSP2327	TC1169	SSP2389	TC1791
SSP2266	TC5588	SSP2328	TC1168	SSP2390	TC1105
SSP2270	TC1571	SSP2329	TC2122	SSP2391	TC1104
SSP2271	TC1572	SSP2330	TC1167	SSP2392	TC1417
SSP2272	TC2307	SSP2331	TC2124	SSP2393	TC5016
SSP2273	TC2308	SSP2332	TC2123	SSP2394	TC3432
SSP2274	TC2118	SSP2335	TC3397	SSP2395	TC3431
SSP2275	TC3822	SSP2336	TC1565	SSP2396	TC3412
SSP2277	TC1203	SSP2337	TC1551	SSP2397	TC3411
SSP2278	TC1563	SSP2338	TC1550	SSP2398	TC2388
SSP2279	TC1562	SSP2339	TC1129	SSP2399	TC2389
SSP2280	TC1774	SSP2340	TC1128	SSP2400	TC1410
SSP2281	TC1773	SSP2341	TC2127	SSP2401	TC1409
SSP2282	TC1534	SSP2342	TC3299	SSP2402	TC1412
SSP2283	TC1533	SSP2343	TC2130	SSP2403	TC3361
SSP2286	TC3354	SSP2344	TC2131	SSP2404	TC3351
SSP2287	TC3353	SSP2345	TC1961	SSP2405	TC3350
SSP2289	TC2054	SSP2347	TC1924	SSP2408	TC5513
SSP2290	TC2053	SSP2348	TC1923	SSP2409	TC5512
SSP2291	TC3369	SSP2349	TC2132	SSP2411	TC3302
SSP2292	TC2513	SSP2350	TC2056	SSP2412	TC3301
SSP2293	TC2512	SSP2351	TC2058	SSP2414	TC1183



MAGNETI MARELLI	DELPHI	MAGNETI MARELLI	DELPHI	MAGNETI MARELLI	DELPHI
SSP2415	TC1361	SSP2466	TC1296	SSP2513	TC1132
SSP2416	TC1360	SSP2467	TC1831	SSP2514	TC1131
SSP2418	TC2517	SSP2468	TC1832	SSP2515	TC2396
SSP2419	TC2616	SSP2469	TC2404	SSP2517	TC2415
SSP2420	TC2297	SSP2470	TC2614	SSP2518	TC2414
SSP2421	TC2289	SSP2471	TC2613	SSP2519	TC1362
SSP2422	TC2288	SSP2472	TC2166	SSP2520	TC2169
SSP2423	TC1589	SSP2473	TC2165	SSP2521	TC2626
SSP2424	TC1590	SSP2474	TC3229	SSP2522	TC1161
SSP2425	TC1776	SSP2475	TC3228	SSP2523	TC1161
SSP2426	TC1775	SSP2476	TC2657	SSP2524	TC1796
SSP2427	TC3304	SSP2477	TC686	SSP2525	TC2270
SSP2428	TC3303	SSP2478	TC686	SSP2526	TC2270
SSP2431	TC928	SSP2479	TC5533	SSP2527	TC2270
SSP2432	TC1019	SSP2480	TC5534	SSP2528	TC3364
SSP2433	TC1020	SSP2481	TC879	SSP2530	TC1353
SSP2434	TC1021	SSP2483	TC1375	SSP2531	TC1352
SSP2436	TC2154	SSP2485	TC1573	SSP2533	TC3446
SSP2437	TC1021	SSP2487	TC1979	SSP2534	TC1086
SSP2438	TC2633	SSP2488	TC2385	SSP2535	TC1086
SSP2439	TC2632	SSP2489	TC1978	SSP2537	TC1315
SSP2440	TC2656	SSP2490	TC2279	SSP2538	TC2223
SSP2441	TC2655	SSP2491	TC3414	SSP2539	TC2221
SSP2444	TC916	SSP2492	TC3413	SSP2540	TC1517
SSP2445	TC483	SSP2495	TC880	SSP2541	TC1518
SSP2446	TC937	SSP2496	TC880	SSP2542	TC1839
SSP2447	TC1355	SSP2497	TC1803	SSP2545	TC2642
SSP2448	TC1354	SSP2498	TC1802	SSP2546	TC1826
SSP2449	TC482	SSP2499	TC915	SSP2547	TC1825
SSP2450	TC1953	SSP2500	TC2168	SSP2548	TC1768
SSP2451	TC1305	SSP2501	TC2168	SSP2549	TC1939
SSP2453	TC2369	SSP2503	TC1374	SSP2550	TC1556
SSP2454	TC2368	SSP2504	TC1373	SSP2551	TC1553
SSP2455	TC2310	SSP2505	TC1372	SSP2552	TC1416
SSP2459	TC2059	SSP2506	TC618	SSP2553	TC1554
SSP2460	TC2060	SSP2507	TC1113	SSP2554	TC2628
SSP2461	TC2198	SSP2508	TC1112	SSP2555	TC1455
SSP2462	TC2197	SSP2509	TC1023	SSP2556	TC1415
SSP2463	TC2323	SSP2510	TC2981	SSP2557	TC1414
SSP2464	TC2287	SSP2511	TC2168	SSP2558	TC2707
SSP2465	TC2286	SSP2512	TC2677	SSP2559	TC1356

MAGNETI MARELLI	DELPHI	MAGNETI MARELLI	FEBI	MAGNETI MARELLI	FEBI
SSP2560	TC2699	ARM007	12558	SSP1315	12768
SSP2561	TC1920	ARM008	12559	SSP1317	32194
SSP2562	TC1764	ARM023	12045	SSP1323	19469
SSP2566	TC1783	ARM024	12044	SSP1339	22379
SSP2567	TC1799	ARM026	12385	SSP1341	19403
SSP2568	TC1798	ARM027	12384	SSP1343	28638
SSP2569	TC2667	ARM027	12386	SSP1392	28359
SSP2571	TC2026	ARM028	12383	SSP1396	29420
SSP2572	TC2051	ARM035	26646	SSP1397	29419
SSP2575	TC1454	ARM036	26645	SSP1419	28619
SSP2576	TC1315	ARM058	29144	SSP1421	28618
SSP2577	TC1325	ARM059	29145	SSP1433	32192
SSP2578	TC1962	ARM089	32444	SSP1434	32193
SSP2579	TC3410	ARM090	32443	SSP1451	28351
SSP2580	TC2088	ARM091	31298		
SSP2581	TC2088	ARM092	31297		
SSP2582	TC1901	ARM125	21260		
SSP2583	TC878	ARM126	21258		
SSP2584	TC1464	ARM134	12537		
SSP2585	TC2538	ARM147	12540		
SSP2586	TC1086	ARM148	12539		
SSP2587	TC2027	ARM155	11978		
SSP2589	TC2045	ARM156	11977		
SSP2590	TC928	SSP1196	12024		
SSP2591	TC1599	SSP1197	12023		
SSP2592	TC2295	SSP1198	22267		
SSP2593	TC2096	SSP1199	22269		
SSP2594	TC1173	SSP1201	29385		
SSP2595	TC1173	SSP1204	14605		
		SSP1289	29399		
		SSP1291	29400		
		SSP1292	18268		
		SSP1293	18216		
		SSP1294	21204		
		SSP1295	21205		
		SSP1296	21206		
		SSP1297	27414		
		SSP1298	36672		
		SSP1299	36671		
		SSP1309	34300		
		SSP1313	19469		



MAGNETI MARELLI	FIRSTLINE	MAGNETI MARELLI	FIRSTLINE	MAGNETI MARELLI	FIRSTLINE
ARM001	FCA5661	ARM111	FCA6128	SSP1206	FBJ5483
ARM002	FCA5660	ARM112	FCA6127	SSP1211	FSK6139
ARM003	FCA5989	ARM113	FCA6646	SSP1213	FSK6005
ARM004	FCA5988	ARM114	FCA6645	SSP1214	FSK6137
ARM017	FCA6126	ARM117	FCA6339	SSP1215	FSK6138
ARM018	FCA6125	ARM118	FCA6338	SSP1216	FSK6141
ARM019	FCA6079	ARM119	FCA5987	SSP1217	FSK6334
ARM020	FCA6078	ARM120	FCA5986	SSP1218	FSK6333
ARM023	FCA5865	ARM121	FDL6618	SSP1222	FSK6140
ARM024	FCA5864	ARM122	FDL6617	SSP1228	FSK6421
ARM025	FCA5959	ARM125	FCA6110	SSP1229	FSK6330
ARM026	FCA5958	ARM126	FCA6109	SSP1231	FSK6331
ARM027	FCA5961	ARM127	FCA6108	SSP1232	FSK6131
ARM027	FCA6219	ARM128	FCA6107	SSP1238	FSK6097
ARM027	FCA6221	ARM135	FCA6825	SSP1239	FSK6425
ARM028	FCA5960	ARM136	FCA6824	SSP1243	FSK6330
ARM028	FCA6220	ARM139	FCA6124	SSP1248	FSK6126
ARM035	FCA6217	ARM140	FCA6123	SSP1249	FSK6127
ARM036	FCA6216	ARM141	FCA6211	SSP1251	FSK6872
ARM041	FCA5612	ARM142	FCA6210	SSP1252	FSK6871
ARM042	FCA5611	ARM149	FBJ5076	SSP1253	FSK6424
ARM058	FCA6559	ARM150	FCA5838	SSP1254	FSK6128
ARM059	FCA6560	ARM151	FCA6206	SSP1258	FSK6132
ARM060	FCA6643	ARM152	FCA6205	SSP1259	FSK6905
ARM061	FCA6644	ARM153	FCA6744	SSP1261	FSK6906
ARM062	FCA6751	ARM155	FCA5591	SSP1262	FSK6857
ARM063	FCA6752	ARM156	FCA5589	SSP1267	FSK6423
ARM071	FCA6707	SSP1181	FDL6615	SSP1269	FSK6133
ARM072	FCA6706	SSP1182	FDL6616	SSP1275	FSK6136
ARM073	FCA6729	SSP1185	FBJ5551	SSP1276	FSK6135
ARM074	FCA6728	SSP1187	FBJ5077	SSP1282	FSK6422
ARM075	FCA6239	SSP1188	FBJ5526	SSP1283	FSK6332
ARM076	FCA6238	SSP1194	FBJ5418	SSP1287	FDL6840
ARM089	FCA6235	SSP1196	FBJ5351	SSP1288	FDL6953
ARM090	FCA6234	SSP1197	FBJ5375	SSP1289	FDL6839
ARM091	FCA6618	SSP1198	FBJ5436	SSP1291	FDL6840
ARM092	FCA6617	SSP1199	FBJ5437	SSP1292	FDL6454
ARM093	FCA6620	SSP1201	FBJ5542	SSP1293	FDL6455
ARM094	FCA6619	SSP1202	FBJ5591	SSP1294	FDL6551
ARM095	FCA6098	SSP1203	FBJ5592	SSP1295	FDL6620
ARM096	FCA6097	SSP1205	FBJ5482	SSP1296	FDL6619

	FIRSTLINE		FIRSTLINE		FIRSTLINE
SSP1301	FDL7119	SSP1384	FTR5042	SSP1449	FTR5139
SSP1302	FDL7186	SSP1387	FTR5524	SSP1451	FTR5043
SSP1304	FDL7195	SSP1388	FTR5440		
SSP1305	FDL7098	SSP1389	FTR5059		
SSP1306	FDL7097	SSP1392	FTR5405		
SSP1312	FDL6630	SSP1393	FTR5141		
SSP1313	FDL6559	SSP1394	FTR5356		
SSP1314	FDL6339	SSP1395	FTR5355		
SSP1315	FDL6458	SSP1396	FTR5367		
SSP1316	FDL6844	SSP1397	FTR5366		
SSP1317	FDL7230	SSP1398	FTR4468		
SSP1321	FDL6560	SSP1399	FTR4467		
SSP1323	FDL6559	SSP1401	FTR4859		
SSP1324	FDL7220	SSP1402	FTR4858		
SSP1325	FDL7211	SSP1405	FTR4957		
SSP1326	FDL6537	SSP1407	FTR5039		
SSP1329	FDL7172	SSP1408	FTR5529		
SSP1331	FDL7116	SSP1409	FTR4153		
SSP1334	FDL7229	SSP1411	FTR4128		
SSP1339	FDL6722	SSP1412	FTR5056		
SSP1341	FDL6625	SSP1413	FTR5055		
SSP1344	FTR5367	SSP1414	FTR4209		
SSP1345	FTR4945	SSP1415	FTR4210		
SSP1346	FTR4718	SSP1416	FTR4478		
SSP1347	FTR4860	SSP1417	FTR4807		
SSP1348	FTR4947	SSP1418	FTR5051		
SSP1351	FTR5467	SSP1419	FTR5361		
SSP1352	FTR5491	SSP1421	FTR5360		
SSP1355	FTR4799	SSP1424	FTR5053		
SSP1356	FTR5057	SSP1425	FTR5052		
SSP1358	FTR4418	SSP1426	FTR4959		
SSP1361	FTR4154	SSP1429	FTR4727		
SSP1362	FTR4253	SSP1431	FTR4728		
SSP1364	FTR4735	SSP1432	FTR5041		
SSP1366	FTR4958	SSP1433	FTR5414		
SSP1367	FTR4718	SSP1434	FTR5413		
SSP1375	FTR5054	SSP1436	FTR5523		
SSP1376	FTR4960	SSP1437	FTR4129		
SSP1379	FTR4223	SSP1438	FTR5262		
SSP1381	FTR4729	SSP1439	FTR5058		
SSP1382	FTR4730	SSP1448	FTR5140		



MAGNETI MARELLI	MOOG	MAGNETI MARELLI	MOOG	MAGNETI MARELLI	MOOG
ARM001	FI-TC-7522	ARM116	FI-WP-8475	ARM181	VO-TC-0892
ARM002	FI-TC-7523	ARM117	OP-TC-1956	ARM182	VO-WP-1552
ARM003	AL-TC-8080	ARM118	OP-TC-1955	ARM183	VO-WP-1553
ARM004	AL-TC-8079	ARM121	AL-TC-7984	ARM184	AU-TC-8239
ARM007	AL-WP-7526P	ARM122	AL-TC-7983	ARM185	AU-DS-8294
ARM008	AL-WP-7527P	ARM125	AL-WP-1436	ARM186	AU-TC-7917
ARM017	FI-TC-8874	ARM126	AL-WP-1437	ARM187	VO-TC-13962
ARM018	FI-WP-0939	ARM135	FI-WP-2110	ARM188	VO-TC-13961
ARM019	FI-WP-1462	ARM136	FI-WP-2109	ARM189	VO-TC-0586
ARM020	FI-WP-1463	ARM141	CH-WP-2450	ARM190	AU-TC-7374
ARM025	FI-WP-0108	ARM142	CH-WP-2449	ARM191	AU-TC-7373
ARM026	FI-WP-0109	ARM147	FI-WP-0240	ARM192	AU-TC-7438
ARM027	FI-WP-0110	ARM148	FI-WP-0239	ARM193	AU-TC-7437
ARM028	FI-WP-0111	ARM149	FI-TC-4673	ARM194	AU-TC-8082
ARM035	CI-WP-2465	ARM150	FI-TC-4674	ARM195	AU-TC-8081
ARM036	CI-WP-2464	ARM151	CH-WP-2459	ARM196	AU-TC-7353
ARM041	FI-WP-7503P	ARM152	CH-WP-2458	ARM197	AU-TC-7352
ARM042	FI-WP-7504P	ARM153	FI-WP-5693	ARM198	AU-TC-7356
ARM058	FI-WP-3959	ARM154	FI-WP-5692	ARM199	AU-TC-7355
ARM059	FI-WP-3958	ARM155	FI-WP-7501	ARM200	VO-TC-14990
ARM060	AL-TC-5097	ARM156	FI-WP-7502	ARM201	AU-TC-8870
ARM061	AL-TC-5098	ARM161	AU-WP-0155P	ARM202	AU-TC-8869
ARM062	AL-TC-5099	ARM162	AU-WP-0154P	ARM203	AU-TC-10800
ARM063	AL-TC-5100	ARM163	AU-TC-10836	ARM204	AU-TC-10799
ARM071	FI-TC-7413	ARM164	AU-TC-10835	ARM205	AU-TC-12624
ARM072	FI-TC-7412	ARM165	AU-TC-13693	ARM206	AU-TC-12623
ARM073	CI-TC-7299	ARM166	AU-TC-13692	ARM207	VO-TC-4936
ARM074	CI-TC-7298	ARM167	VO-WP-13842	ARM208	VO-TC-4935
ARM075	LN-TC-4835	ARM168	VO-WP-13841	ARM209	VO-TC-4933
ARM076	LN-TC-4800	ARM169	VO-TC-10911	ARM210	VO-TC-4932
ARM089	FI-TC-1963	ARM170	AU-TC-0678P	ARM211	AU-TC-4946
ARM090	FI-TC-1964	ARM171	AU-TC-6998	ARM212	AU-TC-4945
ARM091	CI-TC-5122	ARM172	AU-TC-0674P	ARM213	AU-TC-4937
ARM092	CI-TC-5121	ARM173	AU-TC-6997	ARM214	VO-TC-13242
ARM093	CI-TC-5124	ARM174	VO-TC-8236	ARM215	VO-TC-13241
ARM094	CI-TC-5123	ARM175	VO-TC-4001	ARM216	AU-TC-4697
ARM111	FI-WP-4173	ARM176	VO-TC-8235	ARM217	AU-TC-4696
ARM112	FI-WP-4172	ARM177	VO-TC-4000	ARM218	AU-TC-5479
ARM113	FI-WP-5202	ARM178	VO-TC-8230	ARM219	AU-TC-13650
ARM114	FI-WP-5201	ARM179	VO-TC-8229	ARM220	AU-TC-13649
ARM115	FI-WP-8476	ARM180	VO-TC-8228	ARM221	AU-TC-13651

MAGNETI MARELLI	MOOG	MAGNETI MARELLI	MOOG	MAGNETI MARELLI	MOOG
ARM222	AU-TC-13652	ARM264	BM-TC-10990	ARM307	BM-TC-0924
ARM223	AU-TC-13654	ARM265	BM-TC-10989	ARM308	BM-WP-2431
ARM224	AU-TC-13653	ARM266	BM-TC-10988	ARM309	BM-WP-2430
ARM225	AU-TC-14554	ARM267	BM-TC-10987	ARM312	BM-TC-14900
ARM226	AU-TC-14553	ARM268	BM-TC-0476	ARM313	BM-TC-14899
ARM227	AU-TC-13666	ARM269	BM-TC-0477	ARM314	BM-TC-0928
ARM228	AU-TC-13665	ARM270	BM-TC-4356	ARM315	BM-TC-0918
ARM229	AU-TC-7882	ARM271	BM-TC-4357	ARM316	BM-TC-0920
ARM230	AU-TC-7881	ARM272	BM-TC-0448	ARM317	BM-TC-0897
ARM231	AU-TC-15258	ARM273	BM-TC-0449	ARM318	BM-TC-0898
ARM232	AU-TC-15257	ARM274	BM-WP-0421	ARM319	BM-TC-2125
ARM233	AU-TC-7438	ARM275	BM-W-4739	ARM320	BM-TC-2122
ARM234	AU-TC-7437	ARM276	BM-WP-4739	ARM321	BM-TC-2118
ARM235	AU-TC-7372	ARM277	BM-WP-0422	ARM322	BM-TC-3936
ARM236	AU-TC-7369	ARM278	BM-W-4738	ARM323	BM-TC-3856
ARM237	AU-TC-10622	ARM279	BM-WP-4738	ARM324	BM-TC-3855
ARM238	AU-TC-8985	ARM280	BM-TC-5165	ARM325	BM-TC-16820
ARM239	AU-TC-14871	ARM281	BM-TC-5165	ARM326	BM-TC-16819
ARM240	AU-TC-8356	ARM282	BM-TC-5164	ARM327	BM-TC-10490
ARM241	AU-TC-8355	ARM283	BM-TC-5164	ARM328	BM-TC-10489
ARM242	AU-TC-5065	ARM286	BM-TC-5631	ARM329	BM-TC-10488
ARM243	AU-TC-5064	ARM287	BM-TC-5632	ARM330	BM-TC-10487
ARM244	AU-TC-5063	ARM288	BM-WP-2437	ARM331	BM-TC-7399
ARM245	AU-TC-5062	ARM289	BM-WP-2438	ARM332	BMTCT7398
ARM246	AL-WP-10780	ARM290	BM-TC-3865	ARM333	BM-TC-7390
ARM247	AL-WP-10779	ARM291	BM-TC-3864	ARM334	BM-TC-7389
ARM249	BM-TC-3739	ARM292	BM-TC-3691	ARM335	BM-TC-8844
ARM250	BM-TC-3738	ARM293	BM-TC-3693	ARM336	BM-TC-8843
ARM251	BM-TC-3733	ARM294	BM-TC-3692	ARM338	BM-TC-14635
ARM252	BM-TC-3732	ARM295	BM-TC-3687	ARM341	BM-TC-13340
ARM253	BM-TC-3740	ARM296	BM-TC-3686	ARM342	BM-TC-13339
ARM254	BM-TC-3741	ARM297	BM-TC-3685	ARM343	BM-TC-13422
ARM255	BM-TC-3742	ARM298	BM-TC-3684	ARM344	BM-TC-13421
ARM256	BM-TC-14532	ARM299	BM-TC-4363	ARM345	BM-TC-14992
ARM257	BM-TC-14531	ARM300	BM-TC-4362	ARM346	BM-TC-10918
ARM258	BM-TC-10924	ARM301	BM-TC-0486	ARM347	BM-TC-10917
ARM259	BM-TC-10923	ARM302	BM-TC-4360	ARM348	BM-TC-12650
ARM260	BM-TC-10922	ARM303	BM-TC-4361	ARM349	BM-TC-12649
ARM261	BM-TC-10921	ARM304	BM-TC-3152	ARM350	BM-TC-13427
ARM262	BM-TC-10986	ARM305	BM-TC-1752	ARM351	BM-TC-10914
ARM263	BM-TC-10985	ARM306	BM-TC-0923	ARM352	BM-TC-10913



MAGNETI MARELLI	MOOG	MAGNETI MARELLI	MOOG	MAGNETI MARELLI	MOOG
ARM353	BM-TC-10464	ARM419	CI-TC-14827	ARM476	FI-TC-7412
ARM354	BM-TC-13540	ARM420	CI-WP-12504	ARM477	FI-TC-14076
ARM355	BM-TC-13539	ARM421	CI-WP-12503	ARM478	FI-TC-14075
ARM356	BM-TC-13808	ARM422	CI-WP-8760	ARM481	FI-WP-15344
ARM357	BM-TC-13807	ARM423	CI-WP-8761	ARM482	FI-WP-15343
ARM358	BM-TC-14660	ARM424	CI-TC-2055	ARM483	FI-WP-15402
ARM359	BM-TC-10491	ARM425	CI-TC-2056	ARM484	FI-WP-15401
ARM360	BM-TC-13687	ARM426	CI-TC-15534	ARM485	FI-WP-7524
ARM361	BM-TC-14988	ARM427	CI-TC-15533	ARM486	FI-WP-7525
ARM362	BM-TC-14987	ARM428	CI-TC-12666	ARM487	AL-TC-8868P
ARM365	DE-WP-10823	ARM429	CI-TC-12665	ARM488	LN-WP-0272
ARM366	DE-WP-10824	ARM430	PE-TC-10716	ARM489	FI-WP-0240
ARM367	OP-TC-10116	ARM431	PE-TC-10715	ARM490	FI-WP-0239
ARM368	OP-TC-10115	ARM432	CI-TC-13350	ARM491	FI-WP-0118
ARM371	DE-WP-2478	ARM433	CI-TC-13349	ARM492	FI-WP-3840
ARM372	DE-WP-2477	ARM442	CH-TC-10826	ARM493	CI-WP-3877
ARM378	DE-WP-13824	ARM443	CH-TC-10825	ARM494	CI-WP-3876
ARM379	DE-WP-13823	ARM444	AM-GK-7425	ARM497	FI-WP-4967
ARM380	DE-WP-4420	ARM445	AM-GK-7427	ARM498	FI-WP-4966
ARM381	DE-WP-4419	ARM446	RE-WP-3745	ARM499	FI-WP-4969
ARM382	DE-WP-13244	ARM447	RE-WP-3744	ARM502	MD-TC-15332
ARM383	DE-WP-13243	ARM448	RE-TC-10480	ARM509	MD-WP-2357
ARM388	DE-WP-5638	ARM449	RE-TC-10479	ARM510	MD-WP-2356
ARM389	DE-WP-5637	ARM450	RE-TC-14594	ARM511	FD-WP-7998
ARM390	OP-WP-7223	ARM451	RE-TC-14593	ARM512	FD-WP-7997
ARM391	OP-WP-7222	ARM452	RE-TC-14595	ARM513	FD-WP-0738
ARM396	DE-WP-10654	ARM453	RE-TC-14596	ARM514	FD-WP-0739
ARM397	DE-WP-10653	ARM459	CH-TC-13748	ARM517	FD-WP-0495
ARM406	FI-TC-15438	ARM460	CH-TC-14940	ARM518	FD-WP-0496
ARM407	FI-TC-15437	ARM461	CH-WP-14086	ARM519	FD-WP-0843
ARM408	CI-WP-13640	ARM462	CH-WP-14085	ARM520	FD-WP-0844
ARM409	CI-WP-13639	ARM463	CH-TC-14090	ARM523	FD-WP-4139
ARM410	CI-WP-0159	ARM464	CH-TC-14089	ARM524	FD-WP-4140
ARM411	CI-WP-0381	ARM465	CH-TC-10134	ARM525	FD-WP-0721
ARM412	CI-WP-13402	ARM466	CH-TC-10135	ARM526	FD-WP-0722
ARM413	CI-WP-13401	ARM470	LN-WP-13620	ARM527	FD-WP-0163
ARM414	CI-WP-0714	ARM471	LN-WP-13619	ARM528	FD-WP-0162
ARM415	CI-WP-0713	ARM472	FI-TC-4666	ARM529	MD-TC-15730
ARM416	CI-TC-0161	ARM473	FI-WP-13612	ARM530	FD-TC-8850
ARM417	CI-TC-0160	ARM474	FI-WP-13611	ARM531	FD-TC-8849
ARM418	CI-TC-14828	ARM475	FI-TC-7413	ARM532	FD-TC-15323

MAGNETI MARELLI	MOOG	MAGNETI MARELLI	MOOG	MAGNETI MARELLI	MOOG
ARM535	FD-TC-0951	ARM594	FD-TC-5742	ARM645	KI-WP-13771
ARM536	FD-TC-0952	ARM595	FD-TC-12515	ARM646	HY-WP-15254
ARM537	FD-TC-7260P	ARM596	FD-WP-5113	ARM647	HY-WP-15253
ARM538	FD-WP-0403	ARM597	FD-WP-5112	ARM648	KI-TC-12684
ARM539	FD-WP-0404	ARM598	FD-TC-15331	ARM649	KI-TC-12683
ARM540	VV-WP-3645	ARM599	HY-WP-13302	ARM650	KI-TC-15264
ARM541	VV-WP-3640	ARM600	HY-WP-13301	ARM651	KI-TC-15263
ARM542	FD-TC-13347	ARM601	HY-TC-14820	ARM652	ME-WP-0684
ARM543	VV-WP-4872	ARM602	HY-TC-14737	ARM653	ME-WP-0685
ARM544	VV-WP-4871	ARM603	HY-WP-7084	ARM654	ME-TC-0130
ARM545	FD-TC-13762	ARM604	HY-WP-7083	ARM655	ME-TC-0129
ARM546	FD-TC-13606	ARM605	HY-WP-10434	ARM656	RE-BJ-7432
ARM547	FD-TC-13605	ARM606	HY-WP-10433	ARM657	RE-BJ-7431
ARM548	FD-TC-15226	ARM607	KI-WP-7096	ARM658	ME-TC-10474
ARM549	FD-WP-12508	ARM608	KI-WP-7095	ARM659	ME-TC-10473
ARM550	FD-WP-12507	ARM609	HY-WP-13638	ARM660	ME-TC-10806
ARM551	FD-WP-13616	ARM610	HY-WP-13637	ARM661	ME-TC-10805
ARM552	FD-WP-13615	ARM611	HY-WP-10568	ARM663	ME-TC-13773
ARM557	FD-TC-14098	ARM612	HY-WP-10567	ARM664	ME-TC-13726
ARM558	FD-TC-10175	ARM613	HY-TC-14682	ARM665	ME-TC-13725
ARM559	FD-WP-8950	ARM618	HY-TC-13757	ARM666	ME-DS-6300
ARM560	FD-WP-8949	ARM619	HY-WP-2614	ARM667	ME-DS-0793
ARM561	FD-TC-13515	ARM620	HY-WP-2612	ARM668	ME-TC-0732
ARM562	FD-WP-15312	ARM621	HY-WP-4941	ARM669	ME-TC-0732
ARM563	FD-WP-15311	ARM622	HY-WP-4940	ARM671	ME-TC-0728
ARM574	FD-WP-2524	ARM623	HY-WP-14702	ARM672	ME-TC-0731
ARM575	FD-WP-2525	ARM624	HY-WP-14701	ARM674	ME-WP-1532
ARM576	FD-WP-15250	ARM625	CH-TC-13389	ARM675	ME-WP-1533
ARM577	FD-WP-15249	ARM626	CH-TC-13390	ARM676	ME-WP-2077
ARM580	FD-WP-2047	ARM629	AMGK200254	ARM677	ME-WP-2076
ARM581	FD-WP-2048	ARM630	AMGRK620066	ARM678	ME-TC-15350
ARM582	FD-WP-15738	ARM631	MD-WP-3962	ARM679	ME-TC-15349
ARM583	FD-WP-15751	ARM632	MD-WP-3963	ARM680	ME-TC-13797
ARM584	FD-TC-5741	ARM635	KI-TC-4418	ARM681	ME-TC-13805
ARM585	FD-TC-12698	ARM636	KI-WP-5147	ARM682	ME-TC-13336
ARM586	FD-TC-15369	ARM637	KI-WP-5146	ARM683	ME-TC-13335
ARM587	FD-WP-0716	ARM638	KI-WP-13850	ARM684	ME-WP-2251
ARM588	FD-WP-0715	ARM639	KI-WP-13849	ARM685	ME-WP-2250
ARM589	FD-LS-5446	ARM640	KI-WP-8424	ARM686	ME-WP-15188
ARM590	FD-LS-5444	ARM641	KI-WP-8423	ARM687	ME-WP-15187
ARM591	FD-LS-5445	ARM644	KI-WP-13772	ARM688	ME-TC-14939



MAGNETI MARELLI	MOOG	MAGNETI MARELLI	MOOG	MAGNETI MARELLI	MOOG
ARM689	ME-TC-13980	ARM733	ME-TC-8796	ARM776	ME-TC-5186
ARM690	ME-TC-13979	ARM734	ME-TC-8797	ARM777	ME-TC-5185
ARM691	ME-TC-13982	ARM735	ME-TC-14536	ARM778	ME-TC-5184
ARM692	ME-TC-13981	ARM736	ME-TC-14535	ARM779	ME-TC-5183
ARM693	ME-TC-14938	ARM737	ME-TC-4185	ARM780	ME-TC-13804
ARM694	ME-TC-14937	ARM738	ME-TC-4182	ARM781	ME-TC-13803
ARM695	ME-WP-14046	ARM739	ME-TC-4183	ARM784	ME-TC-14918
ARM696	ME-WP-14045	ARM740	ME-TC-4184	ARM785	ME-TC-14917
ARM697	ME-WP-4391	ARM741	ME-TC-3871	ARM786	ME-TC-15116
ARM698	ME-WP-4390	ARM742	ME-TC-3870	ARM787	ME-TC-15115
ARM699	ME-WP-2748	ARM743	ME-TC-3874	ARM793	MD-WP-4427
ARM700	ME-WP-2747	ARM744	ME-TC-3875	ARM794	MD-WP-4426
ARM701	ME-WP-2333	ARM745	ME-TC-1970	ARM795	MD-WP-15756
ARM702	ME-WP-2332	ARM746	ME-TC-1971	ARM796	MD-WP-15755
ARM703	ME-WP-4951	ARM747	ME-TC-1968	ARM797	MD-TC-15090
ARM704	ME-WP-4950	ARM748	ME-TC-1969	ARM798	MD-TC-15640
ARM705	ME-TC-0987	ARM749	ME-TC-3873	ARM799	MD-TC-15639
ARM706	ME-TC-0988	ARM750	ME-TC-3872	ARM800	MD-WP-15092
ARM707	ME-TC-1960	ARM751	ME-TC-1962	ARM801	MD-WP-15091
ARM708	ME-TC-1959	ARM752	ME-TC-1961	ARM802	MD-TC-15236
ARM709	ME-TC-5676	ARM753	ME-TC-3704	ARM803	MD-TC-15235
ARM710	ME-TC-5675	ARM754	ME-TC-3699	ARM804	MD-WP-2359
ARM711	ME-TC-8818	ARM755	ME-TC-1976	ARM805	MD-WP-2358
ARM712	ME-TC-8819	ARM756	ME-TC-1975	ARM806	MD-WP-2360
ARM713	ME-TC-8822	ARM757	ME-TC-1974	ARM807	MD-TC-14078
ARM714	ME-TC-8823	ARM758	ME-TC-1973	ARM808	MD-WP-12573
ARM715	ME-TC-8816	ARM759	ME-TC-1972	ARM809	MD-WP-12573
ARM716	ME-TC-8815	ARM760	ME-TC-5181	ARM810	MD-WP-12580
ARM717	ME-TC-8814	ARM761	ME-TC-5180	ARM811	MD-WP-12579
ARM721	ME-WP-2716	ARM762	ME-TC-5178	ARM812	MD-WP-13902
ARM722	ME-WP-2715	ARM763	ME-TC-5177	ARM813	MD-WP-13901
ARM723	ME-TC-3995	ARM766	ME-TC-5175	ARM816	MI-TC-7311
ARM724	ME-TC-3994	ARM767	ME-TC-5174	ARM817	MI-TC-7310
ARM725	ME-TC-7764	ARM768	ME-TC-13810	ARM818	MI-TC-10631
ARM726	ME-TC-7763	ARM769	ME-TC-13809	ARM819	CI-TC-15563
ARM727	METC8798	ARM770	ME-TC-13440	ARM820	MI-TC-13782
ARM728	METC8799	ARM771	ME-TC-13439	ARM821	PE-WP-7428
ARM729	ME-TC-10647	ARM772	ME-TC-5188	ARM822	PE-WP-7427
ARM730	ME-TC-10644	ARM773	ME-TC-5187	ARM823	MI-WP-8432
ARM731	ME-TC-14537	ARM774	ME-TC-5190	ARM824	MI-WP-8433
ARM732	ME-TC-10643	ARM775	ME-TC-5189	ARM825	ME-WP-5152

MAGNETI MARELLI	MOOG	MAGNETI MARELLI	MOOG	MAGNETI MARELLI	MOOG
ARM826	ME-WP-5151	ARM873	OP-WP-0995	ARM917	PE-TC-14719
ARM827	MI-WP-2775	ARM874	OP-WP-0996	ARM918	PE-TC-8471
ARM828	MI-WP-2772	ARM875	OP-WP-1902	ARM919	PE-TC-8470
ARM835	NI-WP-2245	ARM876	OP-WP-1903	ARM920	PE-TC-5755
ARM836	NI-WP-2244	ARM877	DE-TC-0125	ARM921	PE-TC-5754
ARM837	NI-TC-0566	ARM878	OP-TC-13246	ARM922	PE-WP-13660
ARM838	NI-TC-0567	ARM879	OP-TC-13245	ARM923	PE-WP-13659
ARM839	NI-WP-0989	ARM880	OP-WP-3960	ARM924	CI-WP-0600P
ARM840	NI-WP-0990	ARM881	OP-WP-3961	ARM925	P-636
ARM841	NI-WP-2796	ARM883	OP-WP-14710	ARM926	CI-TC-5167
ARM842	NI-WP-2795	ARM884	OP-WP-14709	ARM927	CI-TC-5166
ARM843	NI-TC-5206	ARM885	OP-WP-0211P	ARM928	PE-TC-7381
ARM844	NI-TC-5205	ARM886	OP-WP-0210P	ARM929	PE-TC-7382
ARM845	NI-WP-2789	ARM887	OP-WP-2823P	ARM930	CI-WP-13992
ARM846	NI-WP-2788	ARM888	OP-WP-2822P	ARM931	CI-WP-13991
ARM847	NI-WP-0326	ARM889	OP-TC-4081	ARM932	CI-TC-14934
ARM848	NI-WP-0327	ARM890	OP-TC-10116	ARM933	CI-TC-14933
ARM849	NI-WP-6590	ARM891	OP-TC-10115	ARM936	PE-TC-13456
ARM850	NI-WP-6589	ARM892	OP-TC-13454	ARM937	PE-TC-13455
ARM851	NI-WP-13362	ARM893	OP-TC-13453	ARM938	RE-WP-15244
ARM852	NI-WP-13361	ARM894	OP-TC-8348	ARM939	RE-WP-15243
ARM853	NI-WP-4956	ARM895	OP-TC-8347	ARM940	RE-WP-2102
ARM854	NI-WP-4955	ARM898	PE-WP-6979	ARM941	RE-WP-2101
ARM855	NI-WP-8858	ARM899	PE-WP-6980	ARM942	RE-WP-1053
ARM856	NI-WP-8857	ARM900	PE-WP-0627	ARM943	RE-WP-1052
ARM857	NI-WP-8452	ARM901	PE-WP-0626	ARM944	OP-TC-8750
ARM858	NI-WP-8453	ARM902	PE-WP-4028	ARM945	OP-TC-8749
ARM859	NI-WP-8450	ARM903	PE-WP-4027	ARM946	RE-TC-10092
ARM860	NI-WP-8451	ARM904	PE-TC-1571	ARM947	RE-TC-10093
ARM861	NI-WP-3229	ARM905	PE-TC-1572P	ARM948	RE-WP-15644
ARM862	NI-WP-2781	ARM906	PE-TC-1034	ARM949	RE-WP-15643
ARM863	NI-WP-10630	ARM907	PE-TC-3539	ARM950	RE-WP-2090
ARM864	NI-WP-10629	ARM908	PE-TC-1033	ARM951	RE-WP-2089
ARM865	NI-WP-7230	ARM909	PE-TC-3538	ARM952	RE-WP-3490
ARM866	NI-WP-7229	ARM910	PE-TC-3883	ARM953	RE-WP-3489
ARM867	NI-WP-15274	ARM911	PE-TC-3882	ARM954	RE-WP-2300
ARM868	NI-WP-15273	ARM912	PE-WP-4742	ARM955	RE-WP-2301
ARM869	OP-TC-0084	ARM913	PE-WP-4741	ARM956	NI-WP-2226
ARM870	OP-TC-0085	ARM914	PE-TC-5755	ARM957	NI-WP-2224
ARM871	OP-TC-0488	ARM915	PE-TC-5754	ARM958	RE-WP-7760
ARM872	OP-TC-0489	ARM916	PE-TC-14720	ARM959	RE-WP-7761



MAGNETI MARELLI	MOOG	MAGNETI MARELLI	MOOG	MAGNETI MARELLI	MOOG
ARM960	RE-WP-15330	ARM1002	TO-WP-4386	ARM1052	VO-WP-13472
ARM961	RE-WP-15329	ARM1003	TO-WP-4385	ARM1053	VO-WP-13471
ARM962	RE-WP-0338	ARM1004	TO-WP-1075	ARM1054	VO-TC-10776
ARM963	RE-WP-0339	ARM1005	TO-WP-1074	ARM1055	VO-TC-10775
ARM964	RE-WP-14758	ARM1010	TO-WP-13254	ARM1056	VO-TC-14576
ARM965	RE-WP-0337	ARM1011	TO-WP-13253	ARM1058	VO-WP-13842
ARM966	RE-WP-7904	ARM1012	TO-WP-13268	ARM1059	VO-WP-13841
ARM967	RE-WP-7903	ARM1013	TO-WP-13267	ARM1060	VO-WP-10818
ARM968	RE-WP-14758	ARM1014	TO-WP-0804	ARM1061	VO-WP-10817
ARM969	RE-WP-14757	ARM1015	TO-WP-0807	ARM1062	VO-WP-13308
ARM970	RE-WP-13710	ARM1018	TO-WP-7450	ARM1063	VO-WP-13307
ARM971	RE-WP-13709	ARM1019	TO-WP-7451	ARM1064	VO-WP-13344
ARM972	RE-WP-13608	ARM1022	TO-WP-4378	ARM1065	VO-WP-13343
ARM973	RE-WP-13607	ARM1023	TO-WP-2992	ARM1068	VO-TC-13776
ARM974	RE-WP-0229	ARM1024	TO-WP-6585	ARM1069	VO-TC-13775
ARM975	RE-WP-0228	ARM1025	TO-WP-6584	ARM1070	VO-WP-0450
ARM976	RE-WP-8102	ARM1027	TO-WP-15320	ARM1071	VO-WP-0451
ARM977	RE-WP-8101	ARM1028	TO-WP-15319	ARM1074	VO-WP-0235P
ARM978	RE-WP-8330	ARM1029	TO-WP-2235	ARM1075	VO-WP-0236P
ARM979	RE-WP-8331	ARM1030	TO-WP-2234	ARM1076	VO-WP-8854
ARM980	RE-WP-15518	ARM1031	TO-WP-10770	ARM1077	VO-WP-8853
ARM981	RE-WP-15517	ARM1032	TO-WP-10769	ARM1078	VV-WP-3639
ARM982	VO-LS-2205	ARM1033	VO-TC-13465	ARM1079	VV-WP-3638
ARM983	VO-LS-0584	ARM1034	AU-TC-7888	ARM1080	VV-WP-3951
ARM984	VO-WP-1989	ARM1035	VO-WP-3061	ARM1081	VV-WP-3950
ARM985	VO-WP-1116	ARM1036	VO-WP-3060	ARM1082	VV-WP-0379
ARM986	VO-WP-8838	ARM1037	VO-TC-14580	ARM1083	VV-WP-0360
ARM987	VO-WP-8837	ARM1038	VO-TC-14579	ARM1084	VV-TC-4401
ARM988	VO-TC-15229	ARM1039	VO-TC-8737	ARM1085	VV-TC-4400
ARM989	VO-WP-14780	ARM1040	VO-WP-13658	ARM1086	VV-WP-13670
ARM990	VO-WP-14779	ARM1041	VO-WP-13657	ARM1087	VV-WP-13669
ARM991	SZ-TC-1188	ARM1042	VO-WP-13730	ARM1088	VV-BJ-8740
ARM992	SZ-TC-1238	ARM1043	VO-WP-13729	ARM1090	VV-TC-13890
ARM993	SZ-WP-5084	ARM1044	VO-WP-13727	ARM1091	VV-TC-13889
ARM994	SZ-WP-5083	ARM1045	VO-WP-13728	SSP0001	BM-DS-4349
ARM995	FI-WP-5158	ARM1046	VO-WP-5009	SSP0002	ME-DS-12601
ARM996	FI-WP-5157	ARM1047	VO-WP-5008	SSP0003	VO-AX-13741
ARM997	TO-WP-8426	ARM1048	VO-WP-1861	SSP0004	VO-AX-8291
ARM998	TO-WP-8425	ARM1049	VO-WP-1862	SSP0005	VO-AX-8286
ARM999	TO-WP-4384	ARM1050	VO-WP-1864	SSP0006	AU-AX-5193
ARM1001	TO-WP-4383	ARM1051	VO-WP-1865	SSP0007	VO-AX-2409

MAGNETI MARELLI	MOOG	MAGNETI MARELLI	MOOG	MAGNETI MARELLI	MOOG
SSP0008	AU-AX-4712	SSP0066	RE-AX-8765	SSP0128	ME-AX-15337
SSP0009	AU-AX-4428	SSP0067	CH-AX-13885	SSP0129	ME-AX-13792
SSP0010	AU-AX-12545	SSP0071	FI-AX-4080	SSP0130	ME-AX-1530
SSP0013	VO-AX-14746	SSP0072	FD-AX-4153	SSP0131	ME-AX-2073
SSP0014	BM-AX-14877	SSP0075	FD-AX-7388	SSP0132	ME-AX-13322
SSP0015	BM-AX-3730	SSP0076	FD-AX-2258	SSP0133	ME-AX-6341
SSP0016	BM-AX-3731	SSP0077	FD-AX-0270	SSP0134	ME-AX-15185
SSP0017	BM-AX-8885	SSP0083	FD-AX-1537	SSP0135	ME-AX-13817
SSP0018	BM-AX-10978	SSP0084	FD-AX-3957	SSP0136	ME-AX-2754
SSP0019	BM-AX-1843	SSP0085	FD-AX-12605	SSP0137	ME-AX-4190
SSP0020	AX-0493-F-B	SSP0086	FD-AX-4851	SSP0138	ME-AX-6343
SSP0021	BM-AX-2436	SSP0092	FD-AX-8855	SSP0139	VO-DS-15435
SSP0022	BM-AX-3683	SSP0094	FD-AX-2527	SSP0140	ME-AX-5674
SSP0023	BM-AX-3854	SSP0095	FD-AX-2526	SSP0141	ME-AX-15301
SSP0024	BM-AX-14892	SSP0096	FD-AX-13617	SSP0142	ME-AX-14590
SSP0025	BM-AX-13425	SSP0097	FD-AX-0470	SSP0143	ME-AX-0979
SSP0026	BM-AX-8789	SSP0098	FD-AX-5110	SSP0144	ME-AX-5596
SSP0027	DE-AX-8886	SSP0099	HY-AX-10810	SSP0145	ME-AX-2266
SSP0028	OP-AX-10486	SSP0101	KI-AX-13985	SSP0146	ME-AX-5173
SSP0029	DE-AX-2474	SSP0102	HY-AX-8898	SSP0147	ME-AX-7769
SSP0033	DE-AX-13822	SSP0103	HY-AX-3892	SSP0148	ME-AX-13694
SSP0034	DE-AX-1821	SSP0104	HY-AX-8894	SSP0149	MD-AX-14929
SSP0035	OP-AX-14765	SSP0105	KI-AX-10615	SSP0150	MD-AX-3888
SSP0036	OP-AX-14766	SSP0106	KI-AX-7089	SSP0151	MD-AX-15089
SSP0038	DE-AX-2470	SSP0107	HY-AX-13298	SSP0152	MD-AX-10524
SSP0041	OP-AX-7221	SSP0108	HY-AX-8358	SSP0153	MD-AX-0010
SSP0045	DE-AX-10492	SSP0109	HY-AX-13756	SSP0154	MD-AX-8887
SSP0049	PE-AX-5749	SSP0110	HY-AX-14980	SSP0155	MD-AX-13906
SSP0050	CI-AX-3361	SSP0111	HY-AX-1818	SSP0158	MI-AX-7305
SSP0051	CI-LS-1727	SSP0112	HY-AX-2432	SSP0159	PE-AX-13279
SSP0052	CI-AX-5690	SSP0113	HY-AX-14084	SSP0160	MI-AX-12636
SSP0053	CI-AX-14830	SSP0115	KI-AX-4432	SSP0161	MI-AX-4444
SSP0054	CI-AX-13643	SSP0116	KI-AX-4009	SSP0162	MI-AX-8439
SSP0055	CI-AX-1707	SSP0117	KI-AX-10697	SSP0163	MI-AX-4854
SSP0056	PE-AX-6901	SSP0118	KI-AX-10698	SSP0164	MI-AX-8352
SSP0057	PE-AX-2059	SSP0120	KI-AX-2331	SSP0165	VV-AX-0027
SSP0058	CI-AX-8851	SSP0123	KI-AX-4199	SSP0166	MI-AX-2771
SSP0059	CI-AX-0863	SSP0124	KI-AX-13861	SSP0167	BM-AX-1877
SSP0060	CI-AX-8762	SSP0125	ME-AX-6338	SSP0168	BM-AX-5603
SSP0063	FI-AX-10934	SSP0126	ME-AX-7294	SSP0170	NI-AX-1701
SSP0065	RE-AX-3760	SSP0127	ME-AX-10146	SSP0171	NI-AX-1268



MAGNETI MARELLI	MOOG	MAGNETI MARELLI	MOOG	MAGNETI MARELLI	MOOG
SSP0172	NI-AX-2797	SSP0217	PEAX12660	SSP0268	VO-AX-13381
SSP0173	NI-AX-1829	SSP0219	RE-AX-2103	SSP0269	AX-1867-BA
SSP0175	NI-AX-13359	SSP0220	RE-AX-2097	SSP0270	VO-AX-12501
SSP0176	NI-AX-4852	SSP0221	OP-AX-10118	SSP0271	VO-AX-2313
SSP0178	NI-AX-8979	SSP0222	RE-AX-2091	SSP0272	VO-AX-0358
SSP0179	NI-AX-4923	SSP0223	RE-AX-1060	SSP0273	VO-AX-8275
SSP0180	NI-AX-2782	SSP0225	NI-AX-2219	SSP0274	VO-AX-1812
SSP0182	NI-AX-13635	SSP0226	RE-AX-2831	SSP0276	VO-AX-2408
SSP0183	NI-AX-7337	SSP0227	RE-AX-1564	SSP0277	VV-AX-7868
SSP0184	OP-AX-7452	SSP0228	RE-AX-4014	SSP0278	VV-AX-3147
SSP0185	OP-AX-5577	SSP0229	RE-AX-10820	SSP0279	VV-AX-0398
SSP0186	OP-AX-5576	SSP0231	RE-AX-0854	SSP0280	VV-AX-8831
SSP0187	OP-AX-5691	SSP0232	RE-AX-0855	SSP0281	VV-AX-8832
SSP0188	OP-AX-0432	SSP0233	RE-AX-2087	SSP0282	AU-ES-3916
SSP0189	OP-AX-1893	SSP0234	RE-AX-1616	SSP0283	AU-ES-3721
SSP0190	OP-AX-1894	SSP0235	RE-AX-3851	SSP0284	AU-ES-3723
SSP0191	OP-AX-2194	SSP0236	RE-AX-0589	SSP0285	VO-ES-8285
SSP0192	OP-AX-8746	SSP0238	RE-AX-4014	SSP0286	VO-ES-8283
SSP0193	OP-AX-8747	SSP0239	RE-AX-7300	SSP0287	VO-ES-8227
SSP0194	OP-AX-14543	SSP0240	RE-AX-13416	SSP0288	AU-ES-7378
SSP0195	OP-AX-1245	SSP0241	RE-AX-13417	SSP0289	AU-ES-7377
SSP0196	OP-AX-5162	SSP0242	RE-AX-5087	SSP0290	VO-ES-2404
SSP0197	OP-AX-4162	SSP0244	RE-AX-7303	SSP0291	VO-ES-2405
SSP0198	SA-AX-7754	SSP0248	VO-AX-12550	SSP0292	AU-ES-3839
SSP0199	OP-AX-8848	SSP0249	SZ-AX-5082	SSP0293	AU-ES-10908
SSP0200	OP-AX-8847	SSP0250	TO-AX-4988	SSP0294	AUES10907
SSP0201	OP-AX-13452	SSP0251	TO-AX-3983	SSP0295	AU-ES-5192
SSP0202	OP-AX-7768	SSP0252	TO-AX-3014	SSP0296	AU-ES-5191
SSP0204	OP-AX-13623	SSP0253	TO-AX-8836	SSP0299	AU-ES-4918
SSP0205	CI-AX-5060	SSP0255	TO-AX-1740	SSP0300	AU-ES-13648
SSP0206	PE-AX-5749	SSP0256	TO-AX-7449	SSP0301	AU-ES-13647
SSP0207	E-AX-1570	SSP0257	TO-AX-1640	SSP0302	BM-ES-14880
SSP0208	PE-AX-13634	SSP0258	TO-AX-10446	SSP0303	BM-ES-14879
SSP0209	PE-AX-7969	SSP0259	TO-AX-2994	SSP0304	BM-ES-3729
SSP0210	PE-AX-3327	SSP0260	T0-AX-4972	SSP0305	BM-ES-3728
SSP0211	PE-AX-12630	SSP0262	TO-AX-2975	SSP0306	BM-ES-8884
SSP0212	PE-AX-0860	SSP0263	TO-AX-10772	SSP0307	BM-ES-8883
SSP0213	CI-AX-3991	SSP0264	TO-AX-14616	SSP0308	BM-ES-10980
SSP0214	PE-AX-7067	SSP0265	TO-AX-10851	SSP0309	BM-ES-10979
SSP0215	PE-AX-14704	SSP0266	TO-AX-15168	SSP0310	BM-ES-4279
SSP0216	E-AX-0862	SSP0267	VO-AX-3054	SSP0311	BM-ES-4270

MAGNETI MARELLI	MOOG	MAGNETI MARELLI	MOOG	MAGNETI MARELLI	MOOG
SSP0312	BM-ES-4374	SSP0382	CH-ES-10748	SSP0444	HY-ES-8900
SSP0313	BM-ES-4375	SSP0383	AMGES80360	SSP0445	HY-ES-8899
SSP0314	BM-ES-0490	SSP0384	AMGES80361	SSP0446	KI-ES-13940
SSP0315	BM-ES-0491	SSP0385	AMGES3529	SSP0447	KI-ES-13939
SSP0316	BM-ES-2439	SSP0386	RE-ES-3756	SSP0448	HY-ES-3886
SSP0317	BM-ES-4351	SSP0387	RE-ES-3755	SSP0449	HY-ES-3887
SSP0318	BM-ES-4350	SSP0388	RE-ES-8764	SSP0450	KI-ES-8766
SSP0319	BM-ES-14894	SSP0389	RE-ES-8763	SSP0451	KI-ES-8767
SSP0320	BM-ES-14893	SSP0390	AMGES800412	SSP0452	HY-ES-7093
SSP0321	BM-ES-2113	SSP0391	AMGES800413	SSP0453	HY-ES-7092
SSP0322	BM-ES-4876	SSP0392	CH-ES-13884	SSP0454	HY-ES-13304
SSP0323	BM-ES-3857	SSP0393	CH-ES-13883	SSP0455	HY-ES-13303
SSP0324	BM-ES-13420	SSP0399	FI-ES-12625	SSP0456	HY-ES-8855
SSP0325	BM-ES-10442	SSP0400	FI-ES-14640	SSP0459	HY-ES-14982
SSP0326	BM-ES-10441	SSP0401	FI-ES-14639	SSP0460	HY-ES-14981
SSP0327	BM-ES-6593	SSP0402	FI-ES-15164	SSP0461	HY-ES-1906
SSP0328	DE-ES-7242	SSP0403	FI-ES-15163	SSP0462	HY-ES-4939
SSP0329	DE-ES-7242	SSP0409	FD-ES-7387	SSP0463	HY-ES-4938
SSP0330	DE-ES-15607	SSP0410	FD-ES-7386	SSP0464	HY-ES-14566
SSP0335	DE-ES-3894	SSP0411	FD-ES-2262	SSP0465	HY-ES-14565
SSP0336	DE-ES-2475	SSP0412	FD-ES-2261	SSP0466	AMGES3472
SSP0340	DE-ES-13690	SSP0413	FD-ES-4125	SSP0467	AMGES3475
SSP0341	DE-ES-13821	SSP0415	FD-ES-14912	SSP0468	MD-ES-3926
SSP0342	DE-ES-3969	SSP0416	FD-ES-14911	SSP0469	MD-ES-3934
SSP0343	DE-ES-3968	SSP0419	FD-ES-1535	SSP0472	KI-ES-4200
SSP0348	DE-ES-2472	SSP0420	FD-ES-1536	SSP0473	ES800349
SSP0349	DE-ES-2471	SSP0421	FD-ES-3891	SSP0474	ES800350
SSP0354	OP-ES-4746	SSP0422	FD-ES-3665	SSP0476	KI-ES-13372
SSP0360	DE-ES-10621	SSP0423	FD-ES-9000	SSP0477	KI-ES-13371
SSP0368	PE-ES-5724	SSP0424	FD-ES-8999	SSP0480	ME-ES-6330
SSP0369	PE-ES-5723	SSP0428	FD-ES-8338	SSP0481	ME-ES-6340
SSP0370	CI-ES-7238	SSP0429	FD-ES-8337	SSP0482	ME-ES-6339
SSP0371	CI-ES-7237	SSP0434	FD-ES-0957	SSP0483	ME-ES-7770
SSP0372	CI-ES-0864	SSP0435	FD-ES-2050	SSP0484	ME-ES-7771
SSP0373	CI-ES-0865	SSP0437	FD-ES-0841	SSP0485	ME-ES-5649
SSP0374	CI-ES-8328	SSP0438	FD-ES-5109	SSP0486	ME-ES-5648
SSP0375	CI-ES-8329	SSP0439	FD-ES-5108	SSP0489	ME-ES-10148
SSP0376	CI-ES-0930	SSP0440	HY-ES-10812	SSP0490	ME-ES-10147
SSP0377	CI-ES-0931	SSP0441	HY-ES-10811	SSP0493	ME-ES-9092
SSP0378	CI-ES-8466	SSP0442	VV-ES-0020	SSP0494	ME-ES-9091
SSP0379	CI-ES-8465	SSP0443	HY-ES-0172	SSP0495	ES-1528-F-B



MAGNETI MARELLI	MOOG	MAGNETI MARELLI	MOOG	MAGNETI MARELLI	MOOG
SSP0496	ES-1529-F-B	SSP0541	MD-ES-10528	SSP0584	NI-ES-2780
SSP0497	ME-ES-2074	SSP0542	MD-ES-10527	SSP0585	NI-ES-0310
SSP0498	ME-ES-2072	SSP0543	MD-ES-2362	SSP0586	NI-ES-5643
SSP0501	ME-ES-13436	SSP0544	MD-ES-2361	SSP0587	NI-ES-5642
SSP0502	ME-ES-13435	SSP0545	MD-ES-10526	SSP0588	NI-ES-10626
SSP0503	ME-ES-10706	SSP0546	MD-ES-10525	SSP0589	NI-ES-10625
SSP0504	ME-ES-10705	SSP0547	MD-ES-13871	SSP0590	RE-ES-15266
SSP0505	ME-ES-6342	SSP0549	MI-ES-8961	SSP0591	RE-ES-15265
SSP0506	ME-ES-15184	SSP0550	ES3044RL	SSP0592	RE-ES-15544
SSP0507	ME-ES-15183	SSP0551	AMGES2347RL	SSP0593	RE-ES-15543
SSP0508	ME-ES-13977	SSP0552	MI-ES-2937	SSP0594	OP-ES-5569
SSP0509	ME-ES-2751	SSP0553	PE-ES-7414	SSP0595	OP-ES-0480
SSP0510	ME-ES-2750	SSP0554	MI-ES-4886	SSP0596	OP-ES-1892
SSP0511	ME-ES-4394	SSP0555	MI-ES-4885	SSP0597	SZ-ES-2292
SSP0512	ME-ES-4393	SSP0556	MI-ES-8438	SSP0598	OP-ES-13924
SSP0513	ME-ES-13914	SSP0557	MI-ES-8437	SSP0600	OP-ES-0514
SSP0514	ME-ES-13913	SSP0558	ME-ES-2079	SSP0601	OP-ES-0514
SSP0515	ME-ES-6344	SSP0559	HY-ES-1657	SSP0602	OP-ES-2819
SSP0516	ME-ES-4953	SSP0560	BM-ES-1871	SSP0603	OP-ES-2818
SSP0517	ME-ES-5649	SSP0561	BM-ES-1874	SSP0604	OP-ES-7415
SSP0518	ME-ES-5648	SSP0562	BM-ES-6986	SSP0605	OP-ES-15336
SSP0519	ME-ES-15172	SSP0563	BM-ES-6983	SSP0606	OP-ES-15335
SSP0520	ME-ES-15171	SSP0564	BM-ES-5602	SSP0607	OP-ES-13628
SSP0521	ME-ES-15112	SSP0565	BM-ES-5601	SSP0608	OP-ES-13627
SSP0522	ME-ES-15111	SSP0566	BM-ES-14906	SSP0612	PE-ES-5703
SSP0523	ME-ES-0977	SSP0567	BM-ES-14905	SSP0613	CI-ES-3964
SSP0524	ME-ES-0978	SSP0568	BM-ES-13442	SSP0614	CI-ES-3965
SSP0525	ME-ES-5600	SSP0569	BM-ES-14905	SSP0615	CI-ES-14932
SSP0526	ME-ES-5599	SSP0570	NI-ES-1258	SSP0616	CI-ES-14931
SSP0527	ME-ES-5594	SSP0571	NI-ES-2791	SSP0617	PE-ES-4164
SSP0528	ME-ES-5593	SSP0572	NI-ES-2790	SSP0618	PE-ES-4163
SSP0529	ME-ES-4181	SSP0573	NI-ES-12594	SSP0619	PE-ES-3330
SSP0530	ME-ES-2729	SSP0574	NI-ES-12593	SSP0620	PE-ES-3331
SSP0531	ME-ES-2728	SSP0575	NI-ES-4957	SSP0621	PE-ES-8474
SSP0532	ME-ES-5172	SSP0576	NI-ES-14030	SSP0622	PE-ES-8473
SSP0535	MD-ES-10686	SSP0577	NI-ES-14029	SSP0623	PE-ES-12632
SSP0536	MD-ES-10685	SSP0578	NI-ES-2801	SSP0624	PE-ES-12631
SSP0537	MD-ES-4718	SSP0579	NI-ES-4925	SSP0625	PE-ES-7066
SSP0538	MD-ES-4717	SSP0580	NI-ES-4924	SSP0626	PE-ES-7065
SSP0539	MD-ES-15088	SSP0581	NI-ES-0310	SSP0627	CI-ES-13990
SSP0540	MD-ES-15087	SSP0582	NI-ES-2777	SSP0628	CI-ES-13989

MAGNETI MARELLI	MOOG	MAGNETI MARELLI	MOOG	MAGNETI MARELLI	MOOG
SSP0629	ES-1656-BA	SSP0670	TO-ES-8980	SSP0714	VV-ES-4021
SSP0630	E-ES-1668	SSP0671	TO-ES-8835	SSP0717	VV-ES-13896
SSP0631	PE-ES-12662	SSP0672	TO-ES-0740	SSP0718	VV-ES-13895
SSP0632	PE-ES-12661	SSP0673	TO-ES-0741	SSP1181	AL-TC-3624
SSP0633	RE-ES-0810	SSP0674	TO-ES-13238	SSP1182	AL-TC-3623
SSP0634	RE-ES-0809	SSP0675	TO-ES-13239	SSP1187	FI-BJ-7510
SSP0635	OP-ES-10120	SSP0676	DI-ES-2243	SSP1189	FI-BJ-0049
SSP0636	OP-ES-10119	SSP0677	TO-ES-2990	SSP1193	FI-BJ-0936
SSP0637	RE-ES-15266	SSP0678	TO-ES-2991	SSP1194	FI-BJ-4174
SSP0638	RE-ES-15265	SSP0679	TO-ES-6583	SSP1195	FI-SB-8357
SSP0639	RE-ES-2093	SSP0680	TO-ES-6582	SSP1196	FI-BJ-7530
SSP0640	RE-ES-2092	SSP0681	TO-ES-4889	SSP1197	FI-BJ-7531
SSP0641	RE-ES-0852	SSP0683	TO-ES-2978	SSP1199	FI-BJ-0513
SSP0642	RE-ES-0853	SSP0684	TO-ES-2977	SSP1201	FI-BJ-4958
SSP0643	RE-ES-7856	SSP0685	TO-ES-5773	SSP1204	FI-BJ-4072
SSP0644	RE-ES-7861	SSP0686	TO-ES-5772	SSP1211	AL-SB-3170
SSP0645	RE-ES-7054	SSP0689	TO-ES-4977	SSP1212	FI-SB-5698
SSP0646	RE-ES-7053	SSP0690	TO-ES-4978	SSP1214	FI-SB-2207
SSP0647	RE-ES-1562	SSP0691	TO-ES-4985	SSP1219	CI-RK-3079
SSP0648	RE-ES-1563	SSP0692	TO-ES-4984	SSP1221	AL-SB-0503
SSP0649	RE-ES-0673	SSP0693	TO-ES-10850	SSP1223	CI-SB-7317
SSP0650	RE-ES-0672	SSP0694	TO-ES-10849	SSP1226	AL-SB-5101
SSP0651	RE-ES-7307	SSP0695	TO-ES-15173	SSP1228	AL-SB-1720
SSP0652	RE-ES-7306	SSP0696	VO-ES-3059	SSP1233	AL-SB-2396
SSP0653	REES13646	SSP0697	VO-ES-3058	SSP1234	AL-SB-2398
SSP0654	REES13645	SSP0698	VO-ES-7106	SSP1235	AL-SB-2397
SSP0655	RE-ES-7027	SSP0699	VO-ES-7139	SSP1245	FI-SB-5697
SSP0656	RE-ES-7026	SSP0700	VO-ES-1869	SSP1248	PE-SB-1312
SSP0657	RE-ES-7302	SSP0701	VO-ES-1868	SSP1249	CI-SB-5633
SSP0658	RE-ES-7301	SSP0702	VO-ES-13342	SSP1251	FI-SB-5204
SSP0659	RE-ES-15490	SSP0703	VO-ES-13341	SSP1252	FI-SB-5203
SSP0660	RE-ES-15489	SSP0704	VO-ES-2315	SSP1254	PE-SB-1313
SSP0661	SK-ES-0412	SSP0705	VO-ES-2314	SSP1255	PE-SB-4963
SSP0662	SK-ES-0411	SSP0706	VO-ES-8258	SSP1264	CH-SB-2448
SSP0663	VO-ES-1506	SSP0707	VO-ES-8259	SSP1266	CH-SB-2452
SSP0664	VO-ES-1507	SSP0708	MI-ES-2937	SSP1272	AL-SB-10834
SSP0665	SZ-ES-8478	SSP0709	VV-ES-1091	SSP1273	AL-SB-5105
SSP0666	TO-ES-3306	SSP0710	VV-ES-1090	SSP1274	AL-SB-5104
SSP0667	TO-ES-4990	SSP0711	VV-ES-3146	SSP1279	FI-SB-2521
SSP0668	TO-ES-4989	SSP0712	VV-ES-2858	SSP1281	FI-SB-2520
SSP0669	TO-ES-4996	SSP0713	VV-ES-4019	SSP1287	AL-LS-5096



MAGNETI MARELLI	MOOG	MAGNETI MARELLI	MOOG	MAGNETI MARELLI	MOOG
SSP1288	AL-LS-5095	SSP1358	FI-AX-7508	SSP1438	FI-ES-4970
SSP1289	AL-LS-5094	SSP1364	FI-AX-0086	SSP1441	AMGES3096L
SSP1291	AL-LS-5093	SSP1366	FI-AX-1839	SSP1448	OP-ES-2082
SSP1292	AL-LS-0052	SSP1371	FI-AX-1751	SSP1449	OP-ES-2081
SSP1295	AL-LS-3297	SSP1372	FI-AX-2518	SSP1452	FI-ES-5155
SSP1296	AL-LS-3296	SSP1373	FI-AX-4198	SSP1773	AU-BJ-7169
SSP1297	FI-LS-4548	SSP1376	FI-AX-2503	SSP1774	AU-BJ-7173
SSP1298	AL-LS-10444	SSP1378	FI-AX-10827	SSP1775	VO-BJ-2410
SSP1299	AL-LS-10443	SSP1382	FI-AX-7528	SSP1776	VO-BJ-8288
SSP1301	AMGK7258	SSP1384	CI-AX-2467	SSP1777	VO-BJ-8288
SSP1302	AMGK7301	SSP1386	LN-AX-4758	SSP1778	VO-BJ-8287
SSP1304	AMGK7470	SSP1387	CI-AX-5169	SSP1779	VO-BJ-8287
SSP1305	CH-LS-10132	SSP1389	FI-AX-5092	SSP1780	AU-BJ-7440
SSP1306	CH-LS-10133	SSP1392	OP-AX-4160	SSP1781	AU-BJ-5195
SSP1309	FI-LS-8794	SSP1393	OP-AX-5689	SSP1782	AU-BJ-5194
SSP1312	FI-LS-3830	SSP1394	FI-AX-10883	SSP1783	AU-BJ-13260
SSP1313	FI-LS-2371	SSP1395	FI-AX-5156	SSP1784	AU-BJ-13655
SSP1314	FI-LS-0441	SSP1396	AL-ES-5418	SSP1785	BM-BJ-15455
SSP1315	FI-LS-0048	SSP1397	AL-ES-5417	SSP1786	BM-BJ-0899
SSP1317	CI-LS-7297	SSP1403	AL-ES-10781	SSP1787	BM-BJ-3861
SSP1319	LN-LS-2678	SSP1404	AL-ES-10782	SSP1788	BM-BJ-8826
SSP1321	FI-LS-2111	SSP1405	AMGES3401RLNC	SSP1789	BM-BJ-13837
SSP1322	FI-LS-8783	SSP1407	AMGES3173RLNC	SSP1790	BM-BJ-12620
SSP1323	FI-LS-2371	SSP1408	CH-ES-10822	SSP1791	BM-BJ-15388
SSP1324	FI-LS-10828	SSP1409	FI-ES-4079	SSP1794	DE-BJ-8901
SSP1325	FI-LS-8086	SSP1411	FI-ES-4085	SSP1795	DE-BJ-5422
SSP1326	PE-LS-1048	SSP1414	FI-ES-4676	SSP1798	DE-BJ-2469
SSP1327	CI-LS-3267	SSP1415	FI-ES-4675	SSP1800	DE-BJ-13825
SSP1328	CI-LS-7321	SSP1416	FI-ES-4684	SSP1801	DE-BJ-3970
SSP1329	CI-LS-7322	SSP1417	FI-AX-2504	SSP1804	DE-BJ-2473
SSP1334	CH-LS-10521	SSP1418	FI-ES-3525	SSP1808	OP-BJ-4745
SSP1339	OP-LS-2080	SSP1422	CI-ES-8976	SSP1809	DE-BJ-10655
SSP1341	CI-LS-2468	SSP1423	CI-ES-8975	SSP1815	CI-BJ-3355
SSP1343	FI-LS-5159	SSP1424	FI-ES-0242	SSP1816	CI-BJ-3355
SSP1344	AL-AX-5416	SSP1425	FI-ES-0241	SSP1817	PE-BJ-3356
SSP1345	AL-AX-1699	SSP1426	FI-ES-0937	SSP1818	CI-BJ-13988
SSP1346	AL-AX-1681	SSP1433	CI-ES-5120	SSP1819	CI-BJ-0868
SSP1347	AL-AX-1223	SSP1434	CI-ES-5119	SSP1820	CI-BJ-8795
SSP1352	CH-AX-10100	SSP1435	LN-ES-4771	SSP1821	CH-BJ-10677
SSP1355	FI-AX-3853	SSP1436	CI-ES-7316	SSP1823	RE-BJ-10478
SSP1356	FI-AX-3826	SSP1437	FI-ES-4082	SSP1824	CH-BJ-14087

MAGNETI MARELLI	MOOG	MAGNETI MARELLI	MOOG	MAGNETI MARELLI	MOOG
SSP1826	FI-BJ-15404	SSP1881	ME-BJ-13818	SSP1922	NI-BJ-4926
SSP1827	FI-BJ-15342	SSP1882	ME-BJ-4392	SSP1923	NI-BJ-4927
SSP1828	IV-BJ-12615	SSP1883	ME-BJ-2749	SSP1924	NI-BJ-4841
SSP1831	FD-BJ-4134	SSP1884	ME-BJ-6345	SSP1925	NI-BJ-10627
SSP1832	FD-BJ-8090	SSP1885	ME-BJ-15457	SSP1926	NI-BJ-4954
SSP1833	FD-BJ-2260	SSP1886	ME-BJ-4952	SSP1927	OP-BJ-5393
SSP1835	FD-BJ-0425	SSP1887	ME-BJ-0980	SSP1928	OP-BJ-0312
SSP1836	VV-BJ-4873	SSP1888	ME-BJ-0981	SSP1929	OP-BJ-0812
SSP1837	VV-BJ-3653	SSP1889	ME-BJ-5597	SSP1930	OP-BJ-1895
SSP1841	FD-BJ-8340	SSP1890	ME-BJ-5598	SSP1931	OP-BJ-1899
SSP1842	FD-BJ-8341	SSP1891	M-852	SSP1932	OP-BJ-5583
SSP1844	FD-BJ-12510	SSP1892	ME-BJ-2725	SSP1933	OP-BJ-15317
SSP1845	FD-BJ-12509	SSP1893	ME-BJ-8111	SSP1934	BM-TC-4317
SSP1846	FD-BJ-0814	SSP1894	ME-BJ-8111	SSP1935	PE-BJ-13251
SSP1847	FD-BJ-8945	SSP1895	MD-BJ-4869	SSP1936	PE-BJ-3323
SSP1849	FD-BJ-0814	SSP1896	MA-336A	SSP1937	PE-BJ-15315
SSP1850	FD-BJ-0474	SSP1897	MD-BJ-13931	SSP1938	CI-BJ-0523
SSP1851	FD-BJ-0474	SSP1898	MD-BJ-2291	SSP1939	PE-BJ-0837
SSP1852	FD-BJ-7296	SSP1899	MI-BJ-4865	SSP1940	PE-BJ-0837
SSP1853	HY-BJ-10813	SSP1900	MI-BJ-0350	SSP1941	PE-BJ-14684
SSP1854	BJ-1630-BA	SSP1901	MI-BJ-0351	SSP1942	PE-BJ-12663
SSP1855	HY-BJ-10432	SSP1902	MI-BJ-7385	SSP1943	RE-BJ-15242
SSP1856	HY-BJ-13369	SSP1903	CI-BJ-10658	SSP1944	RE-BJ-4264
SSP1857	HY-BJ-4749	SSP1904	MI-BJ-104249	SSP1946	RE-BJ-7906
SSP1858	KI-BJ-7094	SSP1905	MI-BJ-104248	SSP1947	RE-BJ-1040
SSP1859	HY-BJ-13247	SSP1906	MI-BJ-104247	SSP1948	RE-BJ-2098
SSP1860	HY-BJ-2629	SSP1907	MI-BJ-7232	SSP1949	RE-BJ-7905
SSP1861	AM-GK-3161T	SSP1908	MI-BJ-7231	SSP1950	OP-BJ-8965
SSP1862	AMGK80604	SSP1909	BM-BJ-1882	SSP1951	OP-BJ-12502
SSP1864	AMGK3185	SSP1910	BJ-1880-BA	SSP1952	RE-BJ-2832
SSP1865	AMGK500063	SSP1911	BJ-1881-BA	SSP1953	RE-BJ-2094
SSP1866	MD-BJ-3935	SSP1912	BM-BJ-10485	SSP1954	RE-BJ-2302
SSP1869	KI-BJ-4757	SSP1913	BM-BJ-10649	SSP1955	RE-BJ-7762
SSP1870	HY-BJ-3977	SSP1914	BM-BJ-5604	SSP1956	RE-BJ-8336
SSP1872	KI-BJ-13409	SSP1915	BM-BJ-13445	SSP1957	RE-BJ-8100
SSP1873	KI-BJ-12659	SSP1916	NI-BJ-2783	SSP1958	RE-BJ-7212
SSP1874	ME-BJ-6331	SSP1917	NI-BJ-0311	SSP1961	SK-BJ-0414
SSP1876	ME-BJ-10684	SSP1918	NI-BJ-1256	SSP1962	FI-ES-4070
SSP1877	ME-BJ-1531	SSP1919	NI-WP-2789P	SSP1963	VO-BJ-7926
SSP1878	ME-BJ-2075	SSP1920	NI-BJ-13545	SSP1964	VO-BJ-7927
SSP1879	ME-BJ-0366	SSP1921	NI-BJ-8859	SSP1966	TO-BJ-4992



MAGNETI MARELLI	MOOG	MAGNETI MARELLI	MOOG	MAGNETI MARELLI	MOOG
SSP1967	TO-BJ-4991	SSP2013	AU-LS-8241	SSP2057	BM-LS-3675
SSP1968	TO-BJ-4108	SSP2014	AU-LS-3718	SSP2058	BM-LS-3690
SSP1969	TO-BJ-8834	SSP2015	AU-LS-3717	SSP2059	BM-LS-4430
SSP1970	TO-BJ-8833	SSP2016	VO-LS-2271	SSP2060	BM-LS-4429
SSP1971	TO-BJ-2274	SSP2017	VO-LS-2271	SSP2061	BM-LS-2434
SSP1972	TO-BJ-0538	SSP2018	AU-ES-3890	SSP2062	BM-LS-2435
SSP1973	TO-BJ-8972	SSP2019	AU-LS-5421	SSP2063	BM-LS-8774
SSP1974	TO-BJ-5679	SSP2020	AU-LS-4934	SSP2064	BM-LS-3967
SSP1975	TO-BJ-3011	SSP2021	AU-LS-5475	SSP2065	BM-LS-10438
SSP1976	VO-BJ-1859	SSP2022	AU-LS-10678	SSP2066	BM-DS-4364
SSP1977	VO-BJ-1860	SSP2023	AU-LS-4193	SSP2067	BM-DS-4365
SSP1978	VO-BJ-5012	SSP2024	AU-LS-8044	SSP2068	BM-LS-2116
SSP1979	VO-BJ-5011	SSP2025	AU-LS-8351	SSP2069	BM-LS-2115
SSP1980	VO-BJ-5012	SSP2029	AL-LS-5096	SSP2070	BM-LS-2117
SSP1981	VO-BJ-5011	SSP2030	AL-LS-5095	SSP2071	BM-LS-3860
SSP1982	VO-BJ-1990	SSP2031	AL-LS-0052	SSP2072	BM-LS-3859
SSP1983	VO-BJ-7050	SSP2032	BM-LS-14876	SSP2073	BM-LS-3558
SSP1984	VO-BJ-0319	SSP2033	BM-LS-3727	SSP2074	BM-LS-7313
SSP1985	VO-BJ-8248	SSP2034	BM-LS-3725	SSP2075	BM-LS-7344
SSP1986	VO-BJ-8249	SSP2035	BM-LS-3743	SSP2076	BM-LS-7343
SSP1987	MI-BJ-10371	SSP2036	BM-LS-14586	SSP2077	BM-LS-7315
SSP1988	VV-BJ-0893	SSP2037	BM-LS-14585	SSP2078	BM-LS-7314
SSP1989	VV-BJ-4399	SSP2038	BM-LS-10982	SSP2079	BM-LS-13956
SSP1990	VV-BJ-13671	SSP2039	BM-LS-10981	SSP2080	BM-LS-13424
SSP1991	VV-BJ-13891	SSP2040	BM-LS-10920	SSP2081	BM-LS-13423
SSP1992	VV-BJ-13892	SSP2041	BM-LS-10919	SSP2082	BM-LS-8846
SSP1996	PE-RK-13758	SSP2042	BM-LS-0420	SSP2083	BM-LS-8806
SSP1998	VO-BJ-8248	SSP2043	BM-DS-4359	SSP2084	BM-LS-8845
SSP1999	VO-BJ-8249	SSP2044	BM-DS-4359	SSP2085	BM-TC-10460
SSP2000	AU-LS-8296	SSP2045	BM-DS-4358	SSP2086	BM-LS-8768
SSP2001	AU-LS-8295	SSP2046	BM-DS-4358	SSP2087	BM-LS-8769
SSP2002	VO-LS-2406	SSP2047	BM-LS-0485	SSP2093	DE-LS-5135
SSP2003	VO-LS-2406	SSP2048	BM-LS-0485	SSP2094	DE-LS-5136
SSP2004	VO-LS-0456	SSP2049	BM-LS-0485	SSP2095	DE-LS-10435
SSP2005	VO-LS-0157	SSP2050	BM-LS-0433	SSP2097	AMGK5342
SSP2006	VO-LS-2422	SSP2051	BM-LS-0434	SSP2107	DE-LS-13820
SSP2007	VO-LS-0356	SSP2052	BM-LS-0434	SSP2108	DE-LS-3896
SSP2008	VO-LS-0357	SSP2053	BM-LS-4196	SSP2109	DE-LS-3897
SSP2009	VO-LS-0157	SSP2054	BM-LS-4195	SSP2110	DE-LS-3971
SSP2010	VO-LS-8240	SSP2055	BM-LS-13493	SSP2123	OP-LS-7224
SSP2012	AU-LS-8242	SSP2056	BM-LS-3676	SSP2124	OP-LS-7224

MAGNETI MARELLI	MOOG	MAGNETI MARELLI	MOOG	MAGNETI MARELLI	MOOG
SSP2125	OP-LS-4706	SSP2206	FD-LS-10512	SSP2252	HY-LS-2625
SSP2126	OP-LS-4707	SSP2209	FD-LS-5736	SSP2253	HY-LS-4688
SSP2130	DE-LS-10623	SSP2211	FD-LS-5613	SSP2254	HY-LS-4689
SSP2137	PE-LS-5046	SSP2212	FD-LS-2051	SSP2255	HY-LS-4943
SSP2138	PE-LS-0595	SSP2213	FD-LS-2049	SSP2257	HY-LS-4942
SSP2139	PE-DS-5041	SSP2214	FD-LS-2049	SSP2259	HY-LS-4944
SSP2140	PE-DS-5041	SSP2215	FD-LS-7924	SSP2260	HY-LS-14083
SSP2141	CI-DS-3348	SSP2216	FD-LS-13618	SSP2261	HY-LS-14784
SSP2142	PE-LS-1626	SSP2217	FD-LS-4114	SSP2262	HY-LS-14783
SSP2143	CI-LS-14683	SSP2219	FD-LS-0469	SSP2263	AMGK3196
SSP2144	CI-LS-8417	SSP2220	FD-LS-0469	SSP2264	AMGK3201
SSP2145	CI-LS-14683	SSP2221	FD-LS-3274	SSP2265	CH-LS-13707
SSP2147	AMGK7348	SSP2222	FD-LS-0808	SSP2266	AMGK3197
SSP2148	CH-LS-10579	SSP2223	FD-LS-0808	SSP2267	CH-LS-13909
SSP2152	AMGK7342	SSP2224	FD-LS-3286	SSP2268	CH-LS-13684
SSP2153	DE-LS-2299	SSP2225	FD-LS-5699	SSP2269	AMGK7305
SSP2154	RE-LS-7304	SSP2226	HY-LS-10809	SSP2270	KI-LS-13256
SSP2155	CH-LS-13872	SSP2227	HY-LS-10519	SSP2271	MD-LS-3981
SSP2158	CH-LS-13882	SSP2228	BJ-1607-BA	SSP2272	KI-LS-10111
SSP2159	CH-LS-13881	SSP2229	HY-LS-1833	SSP2273	KI-LS-10112
SSP2160	CH-LS-14095	SSP2230	HY-LS-3999	SSP2274	MD-LS-3942
SSP2162	FI-LS-3830	SSP2231	HY-LS-8908	SSP2277	MD-LS-3895
SSP2163	FI-LS-14979	SSP2232	HY-LS-8907	SSP2278	KI-LS-4423
SSP2165	FI-LS-0048	SSP2233	HY-LS-8912	SSP2279	KI-LS-4422
SSP2167	CI-LS-7297	SSP2234	HY-LS-8911	SSP2280	KI-LS-4695
SSP2168	FI-LS-2371	SSP2235	HY-LS-13297	SSP2281	KI-LS-4694
SSP2174	FD-LS-14891	SSP2236	HY-LS-3940	SSP2282	KI-LS-4884
SSP2175	FD-LS-8093	SSP2237	HY-LS-3941	SSP2283	KI-LS-4883
SSP2176	FD-LS-2259	SSP2238	HY-LS-7082	SSP2284	HY-LS-14801
SSP2178	FD-LS-0090	SSP2239	HY-LS-7081	SSP2285	HY-LS-13297
SSP2183	FD-LS-15239	SSP2240	HY-LS-7936	SSP2286	KI-LS-10614
SSP2184	FD-LS-14945	SSP2241	HY-LS-7937	SSP2287	KI-LS-10613
SSP2186	FD-LS-0122	SSP2242	KI-LS-7090	SSP2289	ME-LS-0725
SSP2187	FD-LS-0122	SSP2244	KI-LS-7099	SSP2290	ME-LS-0726
SSP2188	FD-LS-0950	SSP2245	HY-LS-13305	SSP2291	ME-LS-7295
SSP2189	FD-LS-0950	SSP2246	HY-LS-13468	SSP2292	ME-LS-10472
SSP2190	FD-LS-3667	SSP2247	HY-LS-13467	SSP2293	ME-LS-10471
SSP2192	FD-LS-3662	SSP2248	HY-LS-13752	SSP2294	ME-LS-13912
SSP2193	FD-LS-5111	SSP2249	HY-LS-13755	SSP2295	ME-LS-13911
SSP2195	FDLS10901	SSP2250	HY-LS-14946	SSP2296	ME-LS-10530
SSP2196	FD-LS-10437	SSP2251	HY-LS-2626	SSP2297	ME-LS-10529



MAGNETI MARELLI	MOOG	MAGNETI MARELLI	MOOG	MAGNETI MARELLI	MOOG
SSP2298	ME-LS-13437	SSP2347	ME-LS-4891	SSP2397	MD-LS-13897
SSP2299	ME-LS-15352	SSP2348	ME-LS-4890	SSP2398	KI-LS-2676
SSP2300	ME-LS-15130	SSP2349	ME-LS-9010	SSP2399	KI-LS-2674
SSP2301	ME-LS-15129	SSP2351	ME-LS-5629	SSP2400	MD-LS-4396
SSP2302	ME-LS-15128	SSP2352	ME-LS-5628	SSP2401	MD-LS-4026
SSP2303	LS-1654-BA	SSP2353	ME-LS-1759	SSP2402	MD-LS-4395
SSP2304	ME-AX-2714	SSP2355	ME-LS-15340	SSP2403	MD-LS-9006
SSP2305	ME-LS-0489	SSP2356	ME-LS-15339	SSP2404	MD-LS-9090
SSP2306	ME-LS-0489	SSP2357	ME-LS-15114	SSP2405	MD-LS-9089
SSP2307	ME-LS-2060	SSP2358	ME-LS-15113	SSP2406	MD-LS-13870
SSP2308	ME-LS-8946	SSP2359	ME-LS-14646	SSP2411	MI-LS-8960
SSP2309	ME-LS-2062	SSP2360	ME-LS-14645	SSP2412	MI-LS-8959
SSP2310	ME-LS-5679	SSP2361	ME-LS-7251	SSP2413	MI-LS-7403
SSP2312	ME-LS-5678	SSP2362	ME-LS-7253	SSP2414	MI-LS-2768
SSP2313	ME-LS-5680	SSP2363	ME-LS-7252	SSP2415	MI-LS-2765
SSP2314	ME-LS-5681	SSP2364	ME-LS-4698	SSP2416	MI-LS-2385
SSP2315	ME-LS-5680	SSP2365	ME-LS-4699	SSP2417	MI-LS-15420
SSP2316	ME-LS-5683	SSP2366	ME-LS-5595	SSP2418	MI-LS-7309
SSP2317	ME-LS-5682	SSP2370	ME-LS-3316	SSP2419	MI-LS-7383
SSP2318	ME-LS-13438	SSP2371	ME-LS-4180	SSP2420	PE-LS-7425
SSP2319	ME-LS-13437	SSP2372	ME-LS-4179	SSP2421	PE-LS-7424
SSP2325	ME-LS-13976	SSP2373	ME-LS-2727	SSP2422	PE-LS-7423
SSP2326	ME-LS-13975	SSP2374	ME-LS-2726	SSP2423	MI-LS-4702
SSP2327	ME-LS-0435	SSP2375	ME-LS-4701	SSP2424	MI-LS-4703
SSP2328	ME-LS-0436	SSP2376	ME-LS-4700	SSP2425	MI-LS-5077
SSP2329	ME-LS-2248	SSP2377	ME-LS-5171	SSP2426	MI-LS-5076
SSP2330	ME-LS-2248	SSP2378	ME-LS-5170	SSP2427	MI-LS-9094
SSP2331	ME-LS-2254	SSP2379	ME-LS-13696	SSP2428	MI-LS-9093
SSP2332	ME-LS-2252	SSP2380	ME-LS-13695	SSP2431	VV-LS-0014
SSP2333	ME-LS-15398	SSP2381	ME-LS-14772	SSP2432	BM-LS-1890
SSP2334	ME-LS-15397	SSP2382	ME-LS-14771	SSP2433	BM-LS-1886
SSP2335	ME-LS-12538	SSP2387	ME-LS-15552	SSP2434	BM-LS-1887
SSP2336	ME-LS-5144	SSP2388	ME-LS-15551	SSP2436	BM-LS-5609
SSP2337	ME-LS-3819	SSP2389	MD-LS-10096	SSP2437	BM-LS-1887
SSP2338	ME-LS-3542	SSP2390	MD-LS-1127	SSP2438	BM-LS-13598
SSP2339	ME-LS-1978	SSP2391	MD-LS-1117	SSP2439	BM-LS-13597
SSP2340	ME-LS-1977	SSP2392	MD-LS-14985	SSP2440	BM-LS-13450
SSP2341	ME-LS-1979	SSP2393	MD-LS-10660	SSP2441	BM-LS-13449
SSP2342	ME-LS-8893	SSP2394	MD-LS-15086	SSP2442	BM-LS-14876
SSP2345	ME-LS-5618	SSP2395	MD-LS-15085	SSP2443	BM-LS-14888
SSP2346	VO-LS-13833	SSP2396	MD-LS-14572	SSP2444	NI-LS-0991

MAGNETI MARELLI	MOOG	MAGNETI MARELLI	MOOG	MAGNETI MARELLI	MOOG
SSP2445	NI-DS-1253	SSP2494	OP-LS-13625	SSP2539	SZ-LS-5081
SSP2446	LS-1168-BA	SSP2495	PE-LS-1573	SSP2540	AMGK90313
SSP2447	NI-LS-2798	SSP2496	PE-LS-1573	SSP2541	AM-GK-90313
SSP2448	NI-LS-2779	SSP2497	PE-LS-3989	SSP2542	TO-LS-4997
SSP2449	NI-DS-0766	SSP2498	PE-LS-3990	SSP2543	TO-LS-14603
SSP2450	NI-LS-8457	SSP2499	PE-LS-0592	SSP2544	TO-LS-3984
SSP2451	RE-LS-2100	SSP2500	PE-LS-3817	SSP2545	TO-LS-8966
SSP2452	NI-LS-12697	SSP2501	CI-LS-7236	SSP2546	TO-LS-10757
SSP2453	AMGK80256	SSP2503	PE-LS-3326	SSP2547	TO-LS-10549
SSP2454	AMGK80255	SSP2504	PE-LS-3325	SSP2548	CI-LS-4959
SSP2459	AMGK90659	SSP2505	PE-LS-3324	SSP2549	TO-LS-5090
SSP2460	FD-LS-4064	SSP2506	PE-DS-6970	SSP2550	TO-LS-5141
SSP2461	NI-LS-4887	SSP2507	PE-DS-6905	SSP2551	TO-LS-4167
SSP2462	AMGK80470	SSP2508	PE-DS-6904	SSP2552	TO-LS-2993
SSP2463	NI-LS-10160	SSP2509	PE-LS-3817	SSP2553	TO-LS-4168
SSP2464	NI-LS-8422	SSP2510	PE-LS-3817	SSP2554	TO-LS-6581
SSP2465	NI-LS-8421	SSP2511	CI-AX-0863	SSP2555	TO-LS-2980
SSP2466	NI-LS-2778	SSP2512	PE-LS-12664	SSP2556	TO-LS-4128
SSP2467	NI-LS-2307	SSP2513	RE-LS-1059	SSP2557	TO-LS-4120
SSP2468	NI-LS-2308	SSP2514	RE-LS-1058	SSP2558	TO-LS-8888
SSP2469	NI-LS-10692	SSP2515	OP-LS-10475	SSP2559	TO-LS-2976
SSP2470	NI-LS-7766	SSP2516	OP-LS-10475	SSP2560	TO-LS-10470
SSP2471	NI-LS-7767	SSP2517	OP-LS-12602	SSP2561	TO-LS-6580
SSP2472	NI-LS-7228	SSP2518	OP-LS-10476	SSP2562	TO-LS-4983
SSP2473	NI-LS-7227	SSP2519	RE-LS-2088	SSP2563	TO-LS-14562
SSP2476	OP-LS-13414	SSP2520	RE-LS-7304	SSP2564	TO-LS-14604
SSP2477	OP-LS-5582	SSP2521	RE-LS-7407	SSP2565	TO-LS-14605
SSP2478	OP-LS-5582	SSP2522	RE-LS-2095	SSP2566	VO-LS-3053
SSP2479	OP-LS-13686	SSP2523	RE-LS-2095	SSP2567	VO-LS-4398
SSP2480	OP-LS-13685	SSP2524	RE-LS-4439	SSP2568	VO-LS-4397
SSP2481	OP-LS-15394	SSP2525	RE-LS-7999	SSP2569	VO-LS-13724
SSP2482	OP-LS-5739	SSP2526	RE-LS-7999	SSP2570	VO-LS-15462
SSP2483	OP-LS-2821	SSP2527	RE-LS-7999	SSP2571	VO-LS-4916
SSP2484	OP-LS-2080	SSP2528	RE-LS-7996	SSP2572	VO-LS-0475
SSP2485	OP-LS-3815	SSP2530	RE-LS-1072	SSP2575	VO-LS-7327
SSP2487	OP-LS-8350	SSP2531	RE-LS-3072	SSP2576	VO-LS-1870
SSP2489	OP-LS-7446	SSP2532	RE-LS-15514	SSP2577	VO-LS-0418
SSP2490	OP-LS-15394	SSP2534	VO-LS-0494	SSP2578	VO-LS-3980
SSP2491	OP-LS-15334	SSP2535	VO-LS-0494	SSP2579	VO-LS-13744
SSP2492	OP-LS-15333	SSP2537	VO-LS-13963	SSP2580	VO-LS-2311
SSP2493	OP-LS-13626	SSP2538	ME-LS-2078	SSP2581	VO-LS-2311



MAGNETI MARELLI	MOOG	MAGNETI MARELLI	NK	MAGNETI MARELLI	NK
SSP2582	VO-RK-1210	ARM001	5012316	ARM111	5012352
SSP2583	VO-LS-0318	ARM002	5012315	ARM112	5012351
SSP2584	VO-LS-3353	ARM003	5011004	ARM113	5012372
SSP2585	SE-LS-2850	ARM004	5011003	ARM114	5012373
SSP2586	VO-LS-0494	ARM007	5011002	ARM117	5013628
SSP2587	VO-LS-0463	ARM008	5011001	ARM118	5013627
SSP2588	VO-LS-4931	ARM017	5012356	ARM119	5011006
SSP2589	VV-LS-1432	ARM018	5012355	ARM120	5011005
SSP2590	VV-LS-0014	ARM019	5012346	ARM125	5011008
SSP2591	VV-LS-6592	ARM020	5012345	ARM126	5011007
SSP2592	VV-LS-7324	ARM023	5011906	ARM127	5011010
SSP2593	VV-LS-1096	ARM024	5011905	ARM128	5011009
SSP2594	VV-LS-1119	ARM025	5011910	ARM133	5012336
SSP2595	VV-LS-1119	ARM026	5011909	ARM134	5012335
SSP2596	FD-LS-10901	ARM026	5011935	ARM147	5012338
		ARM027	5011936	ARM148	5012337
		ARM027	5011938	ARM149	5042314
		ARM028	5011911	ARM151	5019302
		ARM028	5011937	ARM152	5019301
		ARM035	5011940	ARM153	5012374
		ARM036	5011939	ARM154	5012375
		ARM041	5012320	ARM155	5012318
		ARM042	5012319	ARM156	5012317
		ARM058	5012365	SSP1181	5001005
		ARM059	5012366	SSP1182	5001006
		ARM060	5011013	SSP1187	5042303
		ARM061	5011014	SSP1188	5042321
		ARM062	5011012	SSP1191	5042315
		ARM063	5011011	SSP1193	5042319
		ARM071	5012370	SSP1194	5042320
		ARM072	5012369	SSP1196	5041914
		ARM075	5012368	SSP1197	5041915
		ARM076	5012367	SSP1198	5041921
		ARM089	5012364	SSP1199	5041922
		ARM090	5012363	SSP1201	5041923
		ARM091	5011943	SSP1204	5042306
		ARM092	5011944	SSP1205	5044013
		ARM093	5011941	SSP1206	5044014
		ARM094	5011942	SSP1211	5101003
		ARM095	5012354	SSP1213	5103611
		ARM096	5012353	SSP1214	5102321

MAGNETI MARELLI	NK	MAGNETI MARELLI	NK	MAGNETI MARELLI	NK
SSP1216	5101002	SSP1328	5111912	SSP1415	5032333
SSP1217	5102320	SSP1331	5113720	SSP1416	5032344
SSP1218	5102319	SSP1341	5111911	SSP1417	5032359
SSP1222	5101001	SSP1344	5031017	SSP1418	5032360
SSP1228	5101004	SSP1346	5031006	SSP1419	5032376
SSP1232	5102310	SSP1347	5031014	SSP1421	5032375
SSP1239	5101006	SSP1348	5031013	SSP1422	5032382
SSP1249	5101908	SSP1351	5039302	SSP1423	5032383
SSP1253	5101005	SSP1358	5032342	SSP1424	5032353
SSP1254	5101909	SSP1361	5032347	SSP1425	5032352
SSP1258	5102311	SSP1362	5032343	SSP1426	5032364
SSP1261	5101930	SSP1363	5032345	SSP1427	5032386
SSP1267	5101008	SSP1364	5032346	SSP1428	5032385
SSP1269	5102301	SSP1366	5032363	SSP1429	5031916
SSP1271	5102302	SSP1367	5032374	SSP1431	5031918
SSP1275	5102309	SSP1371	5032362	SSP1432	5031937
SSP1276	5102308	SSP1374	5032361	SSP1433	5031921
SSP1277	5102307	SSP1375	5032384	SSP1434	5031920
SSP1278	5102306	SSP1376	5032365	SSP1435	5032381
SSP1282	5101007	SSP1381	5031917	SSP1436	5031940
SSP1283	5102303	SSP1382	5031942	SSP1437	5032303
SSP1287	5111010	SSP1383	5031919	SSP1438	5032373
SSP1288	5111009	SSP1384	5031936	SSP1439	5032379
SSP1289	5111012	SSP1385	5031943	SSP1441	5034003
SSP1291	5111011	SSP1386	5032380	SSP1448	5033668
SSP1292	5111002	SSP1388	5032377	SSP1449	5033667
SSP1293	5111003	SSP1389	5032378	SSP1451	5031935
SSP1294	5111004	SSP1392	5032374		
SSP1295	5111006	SSP1393	5033669		
SSP1296	5111005	SSP1396	5031016		
SSP1301	5119301	SSP1397	5031015		
SSP1305	5119302	SSP1401	5031012		
SSP1306	5119303	SSP1402	5031011		
SSP1312	5112313	SSP1405	5039303		
SSP1314	5112301	SSP1406	5039304		
SSP1316	5112314	SSP1407	5039305		
SSP1317	5111913	SSP1409	5032308		
SSP1321	5112306	SSP1411	5032318		
SSP1323	5112310	SSP1412	5032370		
SSP1326	5112302	SSP1413	5032369		
SSP1327	5113709	SSP1414	5032334		



MAGNETI MARELLI	QUINTON HAZELL	MAGNETI MARELLI	QUINTON HAZELL	MAGNETI MARELLI	QUINTON HAZELL
ARM001	QSA7002S	ARM112	QSA1994S	SSP1202	QSJ3453S
ARM002	QSA7003S	ARM113	QSA2225S	SSP1204	QSJ965S
ARM003	QSA9905S	ARM114	QSA2224S	SSP1211	EMS3020
ARM004	QSA9904S	ARM115	QSA2542S	SSP1217	EMS8034
ARM007	EMS3001	ARM116	QSA2541S	SSP1218	EMS8035
ARM008	EMS3000	ARM117	QSA2001S	SSP1221	EMS8217
ARM019	QSA1925S	ARM118	QSA2000S	SSP1227	EMS8208
ARM020	QSA1924S	ARM119	QSA1788S	SSP1228	EMS8039
ARM023	QSA9114S	ARM120	QSA1785S	SSP1234	EMS8130
ARM024	QSA9113S	ARM121	QSJ3383S	SSP1239	EMS8084
ARM025	QSA9247S	ARM122	QSJ3382S	SSP1244	EMS8304
ARM026	QSA2107S	ARM125	QSA9909S	SSP1245	EMS8303
ARM026	QSA9246S	ARM126	QSA9908S	SSP1253	EMS8082
ARM027	QSA2108S	ARM127	EMS8129	SSP1255	EMS8348
ARM027	QSA2116S	ARM128	QSA1784S	SSP1256	EMS8349
ARM027	QSA9249S	ARM133	QSA1775S	SSP1258	EMS8245
ARM028	QSA2115S	ARM134	QSA1768S	SSP1259	EMS8443
ARM028	QSA9248S	ARM135	QSA2520S	SSP1262	EMS8241
ARM035	QSA2041S	ARM136	QSA2519S	SSP1264	EMS8472
ARM036	QSA2040S	ARM139	QSA2005S	SSP1265	EMS8473
ARM041	QSA914S	ARM140	QSA2004S	SSP1267	EMS8081
ARM042	QSA915S	ARM141	QSA2261S	SSP1273	EMS8499
ARM058	QSA2326S	ARM142	QSA2260S	SSP1274	EMS8498
ARM059	QSA2327S	ARM147	QSA1776S	SSP1277	EMS8036
ARM060	QSA2455S	ARM148	QSA1769S	SSP1278	EMS8037
ARM061	QSA2456S	ARM149	QSJ839AS	SSP1282	EMS8083
ARM062	QSA2384S	ARM153	QSA2518S	SSP1283	EMS8052
ARM063	QSA2385S	ARM154	QSA2517S	SSP1287	QLS3575S
ARM071	QSA2401S	ARM155	QSA1083S	SSP1288	QLS3574S
ARM072	QSA2400S	SSP1182	QDL5291S	SSP1289	QLS3577S
ARM073	QSA2442S	SSP1184	QSJ2115S	SSP1291	QLS3576S
ARM074	QSA2441S	SSP1187	QSJ839S	SSP1292	QLS1752S
ARM075	QSA2110S	SSP1188	QSJ3393S	SSP1293	QLS1757S
ARM076	QSA2109S	SSP1189	QSJ9928S	SSP1294	QLS1747S
ARM089	QSA2112S	SSP1193	QSJ3333S	SSP1295	QLS3260S
ARM090	QSA2111S	SSP1194	QSJ3281S	SSP1296	QLS3261S
ARM091	QSA2469S	SSP1196	QSJ1495S	SSP1298	QLS3788S
ARM092	QSA2467S	SSP1197	QSJ1496S	SSP1299	QLS3787S
ARM095	QSA1923S	SSP1198	QSJ3324S	SSP1301	QLS3598S
ARM096	QSA1922S	SSP1199	QSJ3325S	SSP1305	QLS3597S
ARM111	QSA1995S	SSP1201	QSJ3416S	SSP1306	QLS3596S

MAGNETI MARELLI	QUINTON HAZELL	MAGNETI MARELLI	QUINTON HAZELL	MAGNETI MARELLI	QUINTON HAZELL
SSP1312	QLS3373S	SSP1387	QR3713S		
SSP1314	QLS1970S	SSP1389	QR3401S		
SSP1316	QLS3527S	SSP1393	QR3298S		
SSP1317	QLS3615S	SSP1396	QR3649S		
SSP1321	QLS3325S	SSP1397	QR3648S		
SSP1323	QLS3277S	SSP1398	QR2379S		
SSP1324	QLS3768S	SSP1399	QR2380S		
SSP1326	QLS1885S	SSP1401	QR9902S		
SSP1327	QLS1886S	SSP1402	QR9901S		
SSP1328	QLS3586S	SSP1403	QR3784S		
SSP1329	QLS3739S	SSP1404	QR3875S		
SSP1331	QLS3651S	SSP1408	QR3666S		
SSP1332	QLS3754S	SSP1411	QR1836S		
SSP1333	QLS3753S	SSP1412	QR3403S		
SSP1341	QLS3334S	SSP1413	QR3402S		
SSP1344	QR3589S	SSP1414	QR2379S		
SSP1345	QR2844S	SSP1415	QR2380S		
SSP1346	QR2844S	SSP1416	QR2860S		
SSP1347	QR9903S	SSP1417	QR9925S		
SSP1348	QR9907S	SSP1418	QR9925S		
SSP1351	QR3744S	SSP1419	QR3557S		
SSP1352	QR3647S	SSP1421	QR3556S		
SSP1356	QR3404S	SSP1422	QR3661S		
SSP1358	QR9963S	SSP1423	QR3660S		
SSP1361	QR2465S	SSP1424	QR3353S		
SSP1362	QR2464S	SSP1425	QR3352S		
SSP1363	QR2861S	SSP1426	QR9978S		
SSP1364	QR2862S	SSP1427	QR3860S		
SSP1365	QR3036S	SSP1428	QR3859S		
SSP1366	QR9975S	SSP1429	QR2856S		
SSP1367	QR3550S	SSP1431	QR2858S		
SSP1371	QR3596S	SSP1432	QR3350S		
SSP1374	QR3304S	SSP1433	QR3628S		
SSP1375	QR3354S	SSP1434	QR3627S		
SSP1376	QR9979S	SSP1436	QR3712S		
SSP1378	QR3880S	SSP1437	QR9962S		
SSP1379	QR4200S	SSP1438	QR3599S		
SSP1381	QR2857S	SSP1439	QR3400S		
SSP1382	QR2859S	SSP1448	QR3297S		
SSP1384	QR3351S	SSP1449	QR3296S		
SSP1385	QR3629S	SSP1451	QR3409S		



MAGNETI MARELLI	RUVILLE	MAGNETI MARELLI	RUVILLE	MAGNETI MARELLI	RUVILLE
ARM001	935802	ARM118	935322	SSP1319	917610
ARM002	935801	ARM119	936028	SSP1322	915877
ARM003	936006	ARM120	936027	SSP1326	915900
ARM007	935840	ARM127	936022	SSP1331	916639
ARM008	935839	ARM128	936021	SSP1344	916072
ARM017	935857	ARM133	935821	SSP1345	915814
ARM018	935856	ARM134	935820	SSP1346	916009
ARM023	935913	ARM135	935889	SSP1347	916007
ARM024	935912	ARM136	935888	SSP1348	916048
ARM025	935933	ARM139	938603	SSP1351	918624
ARM026	935932	ARM140	938602	SSP1355	915862
ARM027	935933	ARM141	938607	SSP1356	915856
ARM027	935935	ARM142	938606	SSP1358	915812
ARM028	935934	ARM147	935823	SSP1361	915823
ARM035	937611	ARM148	935822	SSP1363	915821
ARM036	937610	ARM149	935800	SSP1365	915811
ARM041	935815	ARM153	935885	SSP1366	915834
ARM042	935814	ARM154	935886	SSP1367	916009
ARM059	935877	ARM155	935813	SSP1371	915835
ARM060	936038	ARM156	935812	SSP1374	915845
ARM061	936039	SSP1181	916017	SSP1375	915881
ARM062	936036	SSP1182	916018	SSP1376	915850
ARM063	936037	SSP1184	918617	SSP1379	915806
ARM071	935883	SSP1187	915819	SSP1381	915911
ARM072	935882	SSP1191	915843	SSP1382	915927
ARM073	936629	SSP1193	915848	SSP1384	917623
ARM074	936628	SSP1194	915847	SSP1388	917103
ARM075	935861	SSP1196	915928	SSP1389	915858
ARM076	935862	SSP1197	915944	SSP1393	915390
ARM089	935859	SSP1204	915832	SSP1398	915802
ARM090	935860	SSP1205	918615	SSP1399	915801
ARM091	935881	SSP1206	918614	SSP1401	916006
ARM092	935880	SSP1248	987614	SSP1402	916005
ARM093	935881	SSP1249	987612	SSP1405	918616
ARM094	935880	SSP1254	987613	SSP1406	918625
ARM095	935831	SSP1288	916070	SSP1407	918619
ARM096	935830	SSP1292	916014	SSP1409	915824
ARM111	935835	SSP1301	918626	SSP1411	915818
ARM112	935834	SSP1302	918627	SSP1412	915855
ARM113	935865	SSP1312	915857	SSP1413	915854
ARM117	935323	SSP1313	915851	SSP1416	915820

MAGNETI MARELLI	RUVILLE	MAGNETI MARELLI	SWAG	MAGNETI MARELLI	SWAG
SSP1417	915844	ARM001	70730058	SSP1198	70922267
SSP1426	915849	ARM002	70730046	SSP1199	70922269
SSP1429	915910	ARM004	74730007	SSP1201	62929385
SSP1431	915926	ARM007	74730003	SSP1213	40600017
SSP1432	915956	ARM008	74730001	SSP1215	70919473
SSP1436	916637	ARM017	70919959	SSP1216	70919457
SSP1437	915809	ARM019	70730068	SSP1258	62921611
SSP1438	917100	ARM020	70730069	SSP1275	70919475
SSP1441	918600	ARM023	51197	SSP1276	70919476
SSP1448	915389	ARM024	51185	SSP1288	74927422
SSP1449	915388	ARM026	70730042	SSP1289	74929400
		ARM027	70730053	SSP1291	74929399
		ARM027	70730056	SSP1292	74760001
		ARM028	935934	SSP1293	74918216
		ARM035	62926646	SSP1294	74921204
		ARM036	62926645	SSP1295	74921205
		ARM041	70929506	SSP1296	74921206
		ARM042	70929505	SSP1297	70927414
		ARM058	70929144	SSP1298	74936672
		ARM059	70929145	SSP1299	74936671
		ARM060	74934287	SSP1305	14941033
		ARM061	74934286	SSP1306	14941034
		ARM073	62937689	SSP1309	70934300
		ARM074	62937690	SSP1313	70919469
		ARM089	70932444	SSP1314	70610001
		ARM090	70932443	SSP1315	70790003
		ARM095	70730067	SSP1316	70927414
		ARM096	70730066	SSP1317	62932194
		ARM117	40923002	SSP1321	70928606
		ARM118	40923001	SSP1323	70919469
		ARM119	74923163	SSP1325	70933811
		ARM120	74923161	SSP1326	70610002
		ARM125	74921260	SSP1327	70610009
		ARM126	74921258	SSP1328	62935889
		ARM150	70730063	SSP1329	62936883
		SSP1181	74923145	SSP1331	62928601
		SSP1182	74923143	SSP1339	40922379
		SSP1187	70780006	SSP1341	62919403
		SSP1188	70929145	SSP1343	84928638
		SSP1196	70780007	SSP1344	74929419
		SSP1197	70780008	SSP1353	70740006



MAGNETI MARELLI	SWAG	MAGNETI MARELLI	SWAG	MAGNETI MARELLI	TRW
SSP1361	70740006			ARM161	JTC118
SSP1362	70740011			ARM162	JTC117
SSP1363	70720005			ARM163	JTC1043
SSP1364	70720007			ARM164	JTC1042
SSP1376	70919965			ARM165	JTC1297
SSP1381	70740001			ARM166	JTC1041
SSP1382	70720004			ARM167	JTC1700
SSP1383	70720004			ARM168	JTC1699
SSP1385	62935840			ARM170	JTC347
SSP1387	62936669			ARM171	JTC1465
SSP1393	40926432			ARM172	JTC345
SSP1396	74929420			ARM173	JTC1464
SSP1397	74929419			ARM175	JTC119
SSP1399	70710036			ARM176	JTC421
SSP1401	74710003			ARM177	JTC421
SSP1402	74710004			ARM178	JTC350
SSP1405	14941092			ARM179	JTC348
SSP1408	14941104			ARM180	JTC343
SSP1409	70710030			ARM181	JBU621
SSP1411	70710005			ARM182	JTC342
SSP1414	70710037			ARM183	JTC342
SSP1415	70710036			ARM184	JTC996
SSP1416	70710029			ARM185	JTS284
SSP1417	70710032			ARM186	JTC937
SSP1418	70710032			ARM189	JTC1401
SSP1419	70928619			ARM192	JTC2105
SSP1421	70928618			ARM193	JTC2106
SSP1422	70932768			ARM194	JTC2312
SSP1423	70932767			ARM195	JTC2313
SSP1424	70710034			ARM196	JTC1180
SSP1425	70710035			ARM197	JTC1179
SSP1426	70919963			ARM198	JTC1182
SSP1429	70710001			ARM199	JTC1181
SSP1431	70710028			ARM204	JTC1658
SSP1433	62932192			ARM205	JBU1362
SSP1434	62932193			ARM206	JBU1362
SSP1436	62937860			ARM207	JTC1139
SSP1437	70710031			ARM208	JTC1138
SSP1448	40926153			ARM209	JTC1137
SSP1449	40926152			ARM210	JTC1136
SSP1451	70928351			ARM211	JTC1091



MAGNETI MARELLI	TRW	MAGNETI MARELLI	TRW	MAGNETI MARELLI	TRW
ARM212	JTC1090	ARM281	JTC1070	ARM331	JTC1455
ARM213	JBU629	ARM282	JTC1069	ARM332	JTC1456
ARM216	JTC1314	ARM283	JTC1069	ARM333	JTC1453
ARM217	JTC1313	ARM284	JTC1365	ARM334	JTC1454
ARM218	JTC1146	ARM285	JTC1366	ARM335	JTC1208
ARM229	JTC1287	ARM286	JTC1067	ARM336	JTC1207
ARM230	JTC1286	ARM287	JTC1068	ARM346	JTC1666
ARM231	JTC1289	ARM288	JTC1010	ARM347	JTC1667
ARM233	JTC2105	ARM289	JTC1011	ARM353	JTC06822
ARM234	JTC2106	ARM290	JTC1121	ARM354	JTC00064
ARM240	JTC2314	ARM291	JTC1122	ARM355	JTC00065
ARM241	JTC2315	ARM292	JTC1066	ARM367	JTC1476
ARM242	JTC1142	ARM294	JTC1122	ARM368	JTC1477
ARM243	JTC1040	ARM295	JTC1074	ARM369	JTC1493
ARM244	JTC1039	ARM296	JTC1073	ARM371	JTC1487
ARM245	JTC1036	ARM297	JTC1144	ARM372	JTC1488
ARM249	JTC1031	ARM298	JTC1143	ARM380	JTC7606
ARM250	JTC1030	ARM299	JTC127	ARM381	JTC7605
ARM251	JTC1029	ARM300	JTC126	ARM384	JTC7781
ARM252	JTC1028	ARM301	JTC963	ARM385	JTC7780
ARM253	JTC1209	ARM302	JTC129	ARM400	JTC2428
ARM254	JTC1211	ARM303	JTC128	ARM401	JTC2429
ARM255	JTC1210	ARM304	JTC1027	ARM410	JTC261
ARM258	JBU1262	ARM305	JTC1026	ARM414	JTC1202
ARM259	JBU1262	ARM306	JTC1004	ARM415	JTC959
ARM260	JTC1624	ARM307	JTC1005	ARM416	JTC190
ARM261	JTC1623	ARM308	JTC1018	ARM417	JTC270
ARM266	JTC1877	ARM309	JTC1019	ARM420	JTC956
ARM267	JTC1878	ARM314	JTC1071	ARM421	JTC955
ARM268	JTC924	ARM315	JTC1153	ARM422	JTC2552
ARM269	JTC925	ARM316	JTC1154	ARM423	JTC2551
ARM270	JTC131	ARM317	JTC1151	ARM424	JTC958
ARM271	JTC130	ARM318	JTC1152	ARM425	JTC414
ARM272	JTC965	ARM319	JTC1393	ARM444	JTC1276
ARM273	JTC964	ARM320	JTC1392	ARM445	JTC1275
ARM274	JTC962	ARM321	JTC1072	ARM446	JTC1241
ARM276	JTC962	ARM322	JTC1022	ARM447	JTC1240
ARM277	JTC961	ARM323	JTC1127	ARM448	JTC2275
ARM278	JTC961	ARM324	JTC1126	ARM449	JTC2274
ARM279	JTC961	ARM325	JTC1129	ARM472	JTC374
ARM280	JTC1070	ARM326	JTC1128	ARM473	JTC2295



MAGNETI MARELLI	TRW	MAGNETI MARELLI	TRW	MAGNETI MARELLI	TRW
ARM474	JTC2296	ARM540	JBU660	ARM630	JTC2141
ARM475	JBU796	ARM541	JTC1245	ARM633	JTC1712
ARM476	JBU796	ARM543	JTC1478	ARM634	JTC1713
ARM477	JTC1899	ARM544	JTC1479	ARM635	JTC1320
ARM478	JTC1945	ARM545	JTC2284	ARM636	JTC1408
ARM485	JTC279	ARM549	JTC2286	ARM637	JTC1409
ARM486	JTC278	ARM550	JTC2285	ARM644	JTC07119
ARM489	JTC380	ARM557	JTC1714	ARM645	JTC07118
ARM490	JTC379	ARM559	JB1092	ARM652	JTC995
ARM491	JTC1012	ARM560	JB1096	ARM653	JTC994
ARM492	JTC1013	ARM561	JTC1290	ARM654	JTC982
ARM493	JTC1014	ARM574	JTC1334	ARM655	JTC983
ARM494	JTC1015	ARM575	JTC1333	ARM658	JTC2197
ARM497	JB1767	ARM576	JTC1391	ARM659	JTC2196
ARM498	JB1767	ARM577	JTC1390	ARM660	JTC2201
ARM499	JB1766	ARM580	JTC1332	ARM661	JTC2200
ARM501	TRW10720	ARM581	JTC1331	ARM666	JTC923
ARM503	JTC7565	ARM585	JTC01612	ARM667	JTS116
ARM504	JTC7566	ARM587	JTC967	ARM668	JTS116
ARM505	JTC1535	ARM588	JTC966	ARM669	JTS116
ARM509	JTC7567	ARM589	JTC2235	ARM670	JTS116
ARM510	JTC7568	ARM590	JTC2234	ARM671	JTC922
ARM511	JTC2097	ARM591	JTC2289	ARM672	JTS363
ARM512	JTC2096	ARM596	JB1779	ARM674	JTC217
ARM513	JB1711	ARM597	JB1779	ARM675	JTC216
ARM514	JB1711	ARM599	JTC07321	ARM676	JTC1403
ARM519	JTC1242	ARM600	JTC07320	ARM677	JTC1402
ARM520	JTC1243	ARM603	JTC2291	ARM678	JTC969
ARM525	JTC182	ARM605	JTC04682	ARM679	JTC968
ARM526	JTC184	ARM606	JTC04681	ARM680	JTC1890
ARM527	JTC166	ARM607	JTC1394	ARM684	JTC1119
ARM528	JTC168	ARM608	JTC1395	ARM685	JTC1120
ARM530	JTC2126	ARM609	JTC07639	ARM697	JTC1330
ARM531	JTC2125	ARM610	JTC07637	ARM698	JTC1329
ARM533	JTC1537	ARM611	JTC06573	ARM701	JTC2220
ARM534	JTC1552	ARM612	JTC00361	ARM702	JTC2221
ARM535	JRK0053	ARM619	JTC1549	ARM703	JB1804
ARM536	JBU635	ARM620	JTC1551	ARM704	JB1804
ARM537	JTC2231	ARM621	JTC02768	ARM705	JTC970
ARM538	JTC898	ARM622	JTC02769	ARM706	JTC971
ARM539	JTC899	ARM629	JBU182	ARM707	JTC969



MAGNETI MARELLI	TRW	MAGNETI MARELLI	TRW	MAGNETI MARELLI	TRW
ARM708	JTC968	ARM772	JTC1351	ARM864	JTC2278
ARM709	JTC1451	ARM773	JTC1356	ARM865	JB11095
ARM710	JTC1452	ARM776	JTC1350	ARM866	JB11095
ARM723	JTC1367	ARM778	JTC1352	ARM869	JB1149
ARM724	JTC1368	ARM779	JTC1353	ARM870	JB1149
ARM725	JTC1384	ARM782	JTC1357	ARM871	JB1151
ARM726	JTC1385	ARM793	JTC7562	ARM872	JB1151
ARM729	JTC1889	ARM794	JTC7563	ARM873	JTC973
ARM730	JTC1879	ARM804	JTC7565	ARM874	JTC972
ARM731	JTC1880	ARM805	JTC7566	ARM875	JTC1269
ARM733	JTC2465	ARM806	JTC7564	ARM876	JTC1270
ARM734	JTC2466	ARM817	JTC579	ARM877	JTC1268
ARM737	JTC2178	ARM821	JTC2227	ARM880	JB1808
ARM738	JTC1161	ARM822	JTC2228	ARM881	JB1808
ARM739	JTC1162	ARM825	JTC2266	ARM885	JTC193
ARM740	JTC998	ARM826	JTC2269	ARM886	JTC194
ARM741	JTC1102	ARM828	JTC7739	ARM887	JTC1272
ARM742	JTC1103	ARM829	JTC1319	ARM888	JTC1271
ARM743	JTC1105	ARM830	JTC1318	ARM889	JTC2252
ARM744	JTC1104	ARM835	JTC565	ARM890	JTC1476
ARM745	JTC1118	ARM836	JBU764	ARM891	JTC1477
ARM746	JTC1117	ARM837	JTC596	ARM894	JTC7781
ARM747	JTC1158	ARM838	JTC600	ARM895	JTC7780
ARM748	JTC1157	ARM839	JTC1007	ARM898	JTC272
ARM749	JTC1101	ARM840	JTC1008	ARM899	JTC271
ARM750	JTC1100	ARM843	JTC1260	ARM900	JTC1226
ARM751	JTC1457	ARM844	JTC1261	ARM901	JTC1227
ARM752	JTC1457	ARM845	JTC1467	ARM902	JB1710
ARM753	JTC2288	ARM846	JTC1466	ARM903	JB1710
ARM754	JTC2287	ARM847	JTC225	ARM904	JTC312
ARM755	JTC1463	ARM848	JTC226	ARM905	JTC310
ARM756	JTC1462	ARM849	JBU495	ARM906	JTC950
ARM757	JTC1461	ARM851	JTC06597	ARM907	JTC312
ARM758	JTC1460	ARM852	JTC06596	ARM908	JTC949
ARM759	JTC1459	ARM853	JTC7612	ARM909	JTC310
ARM760	JTC1359	ARM854	JTC7611	ARM910	JTC1177
ARM761	JTC1360	ARM857	JTC415	ARM911	JTC1178
ARM766	JTC1215	ARM858	JTC416	ARM912	JTC1235
ARM767	JTC1214	ARM861	JTC7573	ARM913	JTC1234
ARM770	JTC1357	ARM862	JTC7574	ARM914	JBU775
ARM771	JTC1358	ARM863	JTC2279	ARM915	JBU775



MAGNETI MARELLI	TRW	MAGNETI MARELLI	TRW	MAGNETI MARELLI	TRW
ARM916	JTC2281	ARM982	JTC1399	ARM1071	JTC942
ARM917	JTC2280	ARM983	JTC1400	ARM1075	JTC944
ARM919	JTC1885	ARM984	JTC940	ARM1076	JTC2093
ARM920	JTC1238	ARM985	JTC940	ARM1078	JTC1003
ARM921	JTC1239	ARM986	JTC2093	ARM1079	JTC1002
ARM924	JTC1054	ARM987	JTC2092	ARM1080	JTC7546
ARM925	JTC1055	ARM989	JTC1251	ARM1081	JTC7545
ARM926	JTC975	ARM990	JTC1250	ARM1082	JTC2300
ARM927	JTC974	ARM991	JTC2213	ARM1083	JTC2248
ARM928	JBU630	ARM992	JTC2212	SSP0001	JTY130
ARM929	JBU630	ARM993	JTC7599	SSP0002	JCY110
ARM940	JTC1163	ARM994	JTC7600	SSP0003	JAR928
ARM941	JTC1164	ARM995	JTC2246	SSP0004	JAR924
ARM942	JTC1093	ARM996	JTC2247	SSP0005	JAR231
ARM943	JTC1092	ARM997	JTC2232	SSP0006	JAR1062
ARM944	JTC2210	ARM998	JTC2233	SSP0007	JAR993
ARM945	JTC2167	ARM1008	JTC01877	SSP0008	JAR988
ARM946	JGM6156SL	ARM1009	JTC01879	SSP0009	JAR1002
ARM947	JTC2276	ARM1012	JTC01876	SSP0011	JAR1306
ARM948	JTC1222	ARM1013	JTC01878	SSP0015	JAR965
ARM949	JTC1223	ARM1014	JB710	SSP0016	JAR1007
ARM950	JTC1222	ARM1015	JB710	SSP0017	JRA591
ARM951	JTC1223	ARM1016	JTC990	SSP0019	JAR982
ARM952	JB7819	ARM1017	JTC991	SSP0020	JRA330
ARM953	JB7819	ARM1018	JTC1110	SSP0021	JAR918
ARM954	JTC1016	ARM1019	JTC1225	SSP0022	JRA592
ARM955	JTC1017	ARM1022	JTC2516	SSP0023	JAR919
ARM956	JTC1436	ARM1031	JTC1912	SSP0027	JAR1268
ARM957	JTC1435	ARM1032	JTC1948	SSP0028	JAR1296
ARM958	JTC2222	ARM1033	JTC1059	SSP0030	JAR1161
ARM959	JTC2219	ARM1035	JTC1058	SSP0035	JAR1292
ARM962	JTC405	ARM1036	JTC1060	SSP0036	JAR1294
ARM963	JTC404	ARM1042	JTC05683	SSP0041	JAR1076
ARM966	JB7814	ARM1043	JTC05972	SSP0046	JAR1133
ARM967	JB7813	ARM1046	JB752	SSP0047	JAR237
ARM968	JBU134	ARM1047	JB751	SSP0049	JAR495
ARM969	JBU134	ARM1048	JTC1251	SSP0050	JAR511
ARM974	JTC329	ARM1049	JTC1250	SSP0051	JAR1318
ARM975	JTC328	ARM1050	JTC1248	SSP0052	JAR1088
ARM978	JTC2183	ARM1051	JTC1249	SSP0055	JAR648
ARM979	JTC2184	ARM1070	JTC943	SSP0056	JAR226

MAGNETI MARELLI	TRW	MAGNETI MARELLI	TRW	MAGNETI MARELLI	TRW
SSP0057	JAR646	SSP0121	JAR1313	SSP0178	JAR1157
SSP0058	JAR1240	SSP0122	JAR1313	SSP0179	JAR1173
SSP0059	JAR647	SSP0123	JAR7551	SSP0180	JAR7531
SSP0060	JAR1253	SSP0124	JAR00707	SSP0181	JAR1261
SSP0065	JAR1031	SSP0125	JAR218	SSP0183	JAR7646
SSP0066	JAR1079	SSP0126	JAR1259	SSP0184	JAR1298
SSP0071	JAR111	SSP0130	JAR137	SSP0185	JAR125
SSP0072	JAR114	SSP0131	JAR1080	SSP0186	JAR124
SSP0073	JAR197	SSP0132	JAR569	SSP0187	JAR1072
SSP0074	JAR586	SSP0133	JAR106	SSP0188	JAR991
SSP0075	JAR1023	SSP0136	JAR987	SSP0189	JAR1017
SSP0076	JAR978	SSP0137	JAR986	SSP0190	JAR1008
SSP0077	JAR115	SSP0138	JAR107	SSP0191	JAR1048
SSP0083	JAR116	SSP0139	JAR973	SSP0192	JAR1057
SSP0084	JAR1022	SSP0140	JAR1065	SSP0193	JAR1058
SSP0085	JAR1303	SSP0143	JAR935	SSP0194	JAR689
SSP0086	JAR1024	SSP0144	JAR1078	SSP0195	JAR957
SSP0087	JAR1134	SSP0145	JAR649	SSP0196	JAR1006
SSP0088	JAR1182	SSP0146	JAR1056	SSP0197	JAR972
SSP0090	JAR1123	SSP0147	JAR1050	SSP0198	JAR958
SSP0092	JAR1090	SSP0149	JAR1074	SSP0199	JAR1290
SSP0094	JAR942	SSP0150	JAR7544	SSP0200	JAR1291
SSP0095	JAR943	SSP0152	JAR255	SSP0202	JAR1027
SSP0096	JAR566	SSP0153	JAR7545	SSP0205	JRM505
SSP0097	JAR117	SSP0154	JAR1310	SSP0206	JAR495
SSP0098	JAR7640	SSP0155	JAR00766	SSP0207	JAR173
SSP0099	JAR1328	SSP0158	JAR1125	SSP0208	JAR1075
SSP0103	JAR1278	SSP0159	JAR1286	SSP0209	JAR1257
SSP0104	JAR1284	SSP0160	JAR00082	SSP0210	JAR1258
SSP0105	JAR1329	SSP0161	JAR7563	SSP0211	JAR669
SSP0106	JAR1279	SSP0163	JAR724	SSP0212	JAR650
SSP0107	JAR00773	SSP0164	JAR7591	SSP0213	JAR1012
SSP0108	JAR1285	SSP0165	JAR551	SSP0214	JAR1089
SSP0111	JAR1311	SSP0166	JAR1322	SSP0216	JAR989
SSP0112	JAR208	SSP0167	JAR946	SSP0219	JAR929
SSP0113	JAR715	SSP0168	JAR1336	SSP0220	JAR936
SSP0115	JAR7597	SSP0170	JAR337	SSP0222	JAR971
SSP0116	JAR7596	SSP0171	JAR146	SSP0223	JAR662
SSP0117	JAR272	SSP0175	JAR00676	SSP0224	JAR662
SSP0118	JAR273	SSP0176	JAR1110	SSP0225	JAR990
SSP0120	JAR7519	SSP0177	JAR393	SSP0226	JAR1025



MAGNETI MARELLI	TRW	MAGNETI MARELLI	TRW	MAGNETI MARELLI	TRW
SSP0227	JAR179	SSP0285	JTE350	SSP0369	JTE162
SSP0228	JAR938	SSP0286	JTE349	SSP0370	JTE1209
SSP0229	JAR1301	SSP0287	JTE143	SSP0371	JTE1208
SSP0231	JAR949	SSP0288	JTE1145	SSP0372	JTE763
SSP0232	JAR964	SSP0289	JTE1144	SSP0373	JTE762
SSP0233	JAR207	SSP0290	JTE509	SSP0374	JTE1220
SSP0234	JAR951	SSP0291	JTE508	SSP0375	JTE1221
SSP0235	JAR980	SSP0292	JTE1023	SSP0376	JTE765
SSP0236	JAR950	SSP0299	JTE1095	SSP0377	JTE764
SSP0238	JAR984	SSP0304	JTE1051	SSP0378	JTE2134
SSP0239	JAR1014	SSP0305	JTE1050	SSP0379	JTE2137
SSP0242	JAR1020	SSP0306	JTE1163	SSP0386	JTE1135
SSP0244	JAR1225	SSP0307	JTE1164	SSP0387	JTE1136
SSP0248	JRA504	SSP0308	JTE01196	SSP0388	JTE1195
SSP0249	JAR1309	SSP0309	JTE01195	SSP0389	JTE1194
SSP0250	JAR7555	SSP0310	JAR982	SSP0399	JTE01183
SSP0251	JAR7554	SSP0311	JAR982	SSP0407	JTE113
SSP0252	JAR411	SSP0312	JTE148	SSP0408	JTE117
SSP0253	JAR7539	SSP0313	JTE147	SSP0409	JTE1127
SSP0254	JAR00862	SSP0314	JTE767	SSP0410	JTE1126
SSP0255	JAR7527	SSP0315	JTE766	SSP0411	JTE1008
SSP0256	JAR7572	SSP0316	JTE1063	SSP0412	JTE1007
SSP0257	JAR381	SSP0317	JTE146	SSP0413	JTE191
SSP0258	JAR1266	SSP0318	JTE145	SSP0417	JTE1391
SSP0259	JAR7547	SSP0321	JTE1006	SSP0419	JTE194
SSP0260	JAR1264	SSP0322	JTE1077	SSP0420	JTE195
SSP0262	JAR7528	SSP0323	JTE1064	SSP0421	JTE1106
SSP0265	JAR7620	SSP0324	JTE01220	SSP0422	JTE1107
SSP0266	JAR7658	SSP0325	JTE00739	SSP0423	JTE1213
SSP0267	JAR994	SSP0326	JTE00738	SSP0424	JTE1214
SSP0269	JAR939	SSP0328	JTE925	SSP0428	JTE1132
SSP0271	JAR981	SSP0329	JTE925	SSP0429	JTE1131
SSP0272	JRA364	SSP0335	JTE7615	SSP0434	JTE1044
SSP0273	JAR507	SSP0336	JTE7614	SSP0435	JTE1035
SSP0274	JAR506	SSP0340	JTE01181	SSP0437	JTE768
SSP0276	JAR1033	SSP0342	JTE7591	SSP0438	JTE1161
SSP0277	JAR7503	SSP0343	JTE7590	SSP0439	JTE1160
SSP0279	JAR953	SSP0349	JTE546	SSP0440	JTE434
SSP0282	JTE144	SSP0354	JTE1183	SSP0441	JTE431
SSP0283	JTE1206	SSP0360	JTE7767	SSP0442	JTE260
SSP0284	JTE1205	SSP0368	JTE163	SSP0443	JTE229

MAGNETI MARELLI	TRW	MAGNETI MARELLI	TRW	MAGNETI MARELLI	TRW
SSP0445	JTE7755	SSP0518	JTE769	SSP0578	JTE808
SSP0448	JTE7601	SSP0523	JTE1013	SSP0579	JTE7612
SSP0449	JTE7600	SSP0524	JTE1014	SSP0581	JTE266
SSP0450	JTE2156	SSP0525	JTE1192	SSP0582	JTE7636
SSP0451	JTE2157	SSP0526	JTE1191	SSP0584	JTE572
SSP0452	JTE2149	SSP0527	JTE1224	SSP0585	JTE268
SSP0453	JTE2150	SSP0528	JTE1225	SSP0586	JTE1211
SSP0456	JTE01161	SSP0529	JTE1027	SSP0587	JTE1210
SSP0461	JTE7606	SSP0530	JTE1005	SSP0588	JTE443
SSP0462	JTE00026	SSP0531	JTE1004	SSP0589	JTE442
SSP0463	JTE00027	SSP0535	JTE1180	SSP0590	JTE414
SSP0468	JTE1158	SSP0536	JTE1179	SSP0591	JTE413
SSP0469	JTE1159	SSP0537	JTE7583	SSP0594	JTE211
SSP0472	JTE7592	SSP0538	JTE7584	SSP0595	JTE721
SSP0473	JTE2147	SSP0541	JTE340	SSP0596	JTE1041
SSP0474	JTE2148	SSP0542	JTE579	SSP0597	JTE1067
SSP0480	JTE244	SSP0543	JTE7585	SSP0600	JTE213
SSP0481	JTE249	SSP0544	JTE7586	SSP0601	JTE771
SSP0482	JTE248	SSP0545	JTE409	SSP0602	JTE1029
SSP0483	JTE1171	SSP0546	JTE412	SSP0603	JTE1028
SSP0484	JTE1170	SSP0547	JTE01285	SSP0604	JTE1223
SSP0485	JTE1169	SSP0549	JTE730	SSP0612	JTE161
SSP0486	JTE1168	SSP0550	JTE517	SSP0613	JTE1199
SSP0487	JTE1040	SSP0551	JTE515	SSP0614	JTE1198
SSP0488	JTE1039	SSP0552	JTE260	SSP0617	JTE1188
SSP0493	JTE407	SSP0553	JTE260	SSP0618	JTE1187
SSP0494	JTE408	SSP0554	JTE7567	SSP0619	JTE1153
SSP0495	JTE247	SSP0555	JTE7566	SSP0620	JTE1152
SSP0496	JTE246	SSP0556	JTE00257	SSP0621	JTE1153
SSP0497	JTE1197	SSP0557	JTE00258	SSP0623	JTE01295
SSP0498	JTE1196	SSP0558	JTE420	SSP0624	JTE01294
SSP0501	JTE01210	SSP0559	JTE260	SSP0625	JTE2056
SSP0502	JTE01209	SSP0560	JTE1100	SSP0626	JTE2057
SSP0505	JTE168	SSP0561	JTE1099	SSP0629	JTE1066
SSP0509	JTE1085	SSP0562	JTE1092	SSP0630	JTE1065
SSP0510	JTE1084	SSP0563	JTE1096	SSP0633	JRA555
SSP0511	JTE1079	SSP0570	JTE263	SSP0634	JRA556
SSP0512	JTE1078	SSP0571	JTE1111	SSP0635	JTE439
SSP0515	JTE169	SSP0572	JTE1112	SSP0636	JTE438
SSP0516	JTE1062	SSP0576	JTE7792	SSP0637	JTE686
SSP0517	JTE770	SSP0577	JTE7791	SSP0638	JTE587



MAGNETI MARELLI	TRW	MAGNETI MARELLI	TRW	MAGNETI MARELLI	TRW
SSP0639	JTE1061	SSP0688	JTE2079	SSP1816	JB127
SSP0640	JTE1060	SSP0695	JTE7788	SSP1817	JB129
SSP0641	JTE994	SSP0696	JTE1091	SSP1819	JB138
SSP0642	JTE986	SSP0697	JTE1090	SSP1828	JB1375
SSP0643	JRA576	SSP0698	JTE780	SSP1831	JB145
SSP0644	JRA575	SSP0699	JTE779	SSP1832	JB17640
SSP0645	JTE282	SSP0700	JTE1053	SSP1833	JB1336
SSP0646	JRA538	SSP0701	JTE1052	SSP1834	JB1740
SSP0647	JTE700	SSP0702	JTE01217	SSP1835	JB1656
SSP0648	JTE701	SSP0703	JTE01216	SSP1836	JB1740
SSP0649	JTE1012	SSP0704	JTE1076	SSP1837	JB1722
SSP0650	JTE1011	SSP0705	JTE1075	SSP1846	JB1730
SSP0651	JRA571	SSP0706	JTE366	SSP1849	JB1730
SSP0652	JRA570	SSP0707	JTE365	SSP1850	JB1728
SSP0655	JTE284	SSP0708	JTE260	SSP1851	JB1728
SSP0656	JTE283	SSP0709	JTE1003	SSP1852	JB1779
SSP0657	JTE1155	SSP0710	JTE1002	SSP1853	JB1335
SSP0658	JTE1154	SSP0711	JTE1001	SSP1854	JB174
SSP0661	JTE2162	SSP0712	JTE1000	SSP1855	JB17631
SSP0662	JTE2163	SSP0713	JTE1072	SSP1857	JB1066
SSP0663	JTF201	SSP0714	JTE1071	SSP1858	JB1075
SSP0664	JTF199	SSP0715	JTE1161	SSP1859	JB1363
SSP0665	JTE695	SSP0716	JTE1160	SSP1860	JB17553
SSP0666	JTE683	SSP1773	JB117	SSP1861	JB1833
SSP0667	JTE7598	SSP1774	JB118	SSP1862	JB11006
SSP0668	JTE7599	SSP1775	JB1665	SSP1865	JB1894
SSP0671	JTE7579	SSP1776	JB1064	SSP1866	JB17554
SSP0672	JTE7570	SSP1777	JB113	SSP1869	JB17546
SSP0673	JTE7569	SSP1778	JB1377	SSP1870	JB17552
SSP0674	JTE2084	SSP1779	JB113	SSP1873	JB11099
SSP0675	JTE2085	SSP1780	JB1789	SSP1874	JB1308
SSP0676	JTE319	SSP1781	JB1797	SSP1876	JB1070
SSP0677	JTE7535	SSP1782	JB1796	SSP1877	JB1167
SSP0678	JTE7534	SSP1786	JB1713	SSP1878	JB1786
SSP0679	JTE7630	SSP1787	JB1768	SSP1879	JB1759
SSP0680	JTE7631	SSP1788	JB1827	SSP1882	JB1756
SSP0681	JTE2144	SSP1798	JB17561	SSP1883	JB1770
SSP0683	JTE7552	SSP1799	JB17008	SSP1884	JB1368
SSP0684	JTE7553	SSP1801	JB17544	SSP1885	JB1788
SSP0685	JTE2078	SSP1814	JB1282	SSP1886	JB1804
SSP0686	JTE2079	SSP1815	JB1127	SSP1887	JB1764

MAGNETI MARELLI	TRW	MAGNETI MARELLI	TRW	MAGNETI MARELLI	TRW
SSP1888	JBj765	SSP1937	JBj1097	SSP1989	JBj754
SSP1889	JBj803	SSP1938	JBj707	SSP1996	JBj826
SSP1890	JBj802	SSP1939	JBj791	SSP1998	JBj244
SSP1891	JBj697	SSP1940	JBj791	SSP1999	JBj243
SSP1892	JBj769	SSP1944	JBj197	SSP2000	JTS106
SSP1893	JBj783	SSP1946	JBj760	SSP2001	JTS105
SSP1894	JBj783	SSP1947	JBj1053	SSP2002	JTS394
SSP1895	JBj822	SSP1948	JBj725	SSP2003	JTS394
SSP1896	JBj864	SSP1949	JBj778	SSP2004	JTS395
SSP1899	JBj680	SSP1950	JBj817	SSP2005	JTS361
SSP1900	JBj339	SSP1951	JBj1049	SSP2006	JTS458
SSP1901	JBj360	SSP1952	JBj721	SSP2007	JTS362
SSP1902	JBj174	SSP1953	JBj819	SSP2008	JTS361
SSP1904	JBj687	SSP1954	JBj719	SSP2009	JTS280
SSP1905	JBj175	SSP1955	JBj1083	SSP2010	JTS122
SSP1906	JBj176	SSP1956	JBj810	SSP2012	JTS524
SSP1907	JBj7548	SSP1958	JBj818	SSP2013	JTS523
SSP1908	JBj7547	SSP1961	JBj703	SSP2014	JTS421
SSP1909	JBj1074	SSP1962	JBj702	SSP2015	JTS422
SSP1910	JBj747	SSP1963	JBj815	SSP2016	JTS388
SSP1911	JBj746	SSP1964	JBj816	SSP2017	JTS388
SSP1913	JBj1054	SSP1968	JBj7524	SSP2018	JTS398
SSP1914	JBj1055	SSP1970	JBj7538	SSP2019	JTS607
SSP1916	JBj182	SSP1971	JBj710	SSP2020	JTS606
SSP1917	JBj181	SSP1972	JBj353	SSP2022	JTS985
SSP1918	JBj177	SSP1973	JBj1079	SSP2023	JTS506
SSP1919	JBj723	SSP1974	JBj1072	SSP2028	JTS393
SSP1921	JBj526	SSP1975	JBj553	SSP2029	JTS552
SSP1922	JBj742	SSP1976	JBj752	SSP2030	JTS477
SSP1923	JBj743	SSP1977	JBj751	SSP2031	JTS104
SSP1924	JBj739	SSP1978	JBj795	SSP2033	JTS614
SSP1926	JBj1095	SSP1979	JBj794	SSP2034	JTS613
SSP1927	JBj149	SSP1980	JBj795	SSP2035	JTS510
SSP1928	JBj151	SSP1981	JBj794	SSP2038	JTS01914
SSP1929	JBj705	SSP1982	JBj749	SSP2039	JTS01869
SSP1930	JBj781	SSP1983	JBj750	SSP2040	JTS01218
SSP1931	JBj782	SSP1984	JBj142	SSP2041	JTS01217
SSP1932	JBj100	SSP1985	JBj244	SSP2042	JTS426
SSP1934	JBj125	SSP1986	JBj243	SSP2043	JTS111
SSP1935	JBj826	SSP1987	JBj174	SSP2044	JTS111
SSP1936	JBj748	SSP1988	JBj720	SSP2045	JTS112



MAGNETI MARELLI	TRW	MAGNETI MARELLI	TRW	MAGNETI MARELLI	TRW
SSP2046	JTS112	SSP2108	JTS7579	SSP2186	JTS581
SSP2047	JTS113	SSP2109	JTS7578	SSP2187	JTS581
SSP2048	JTS113	SSP2110	JTS7580	SSP2188	JTS405
SSP2049	JTS113	SSP2111	JTS664	SSP2189	JTS130
SSP2050	JTS404	SSP2123	JTS602	SSP2190	JTS490
SSP2051	JTS393	SSP2124	JTS602	SSP2192	JTS7572
SSP2052	JTS393	SSP2125	JTS579	SSP2193	JTS536
SSP2053	JTS117	SSP2126	JTS578	SSP2198	JTS909
SSP2054	JTS120	SSP2129	JTS1515	SSP2200	JTS1285
SSP2056	JTS481	SSP2130	JTS929	SSP2203	JTS715
SSP2057	JTS480	SSP2133	JTS1388	SSP2211	JTS583
SSP2058	JTS513	SSP2134	JTS738	SSP2212	JTS582
SSP2059	JTS647	SSP2135	JTS650	SSP2213	JTS515
SSP2060	JTS646	SSP2136	JTS1352	SSP2214	JTS515
SSP2061	JTS420	SSP2137	JTS125	SSP2215	JTS584
SSP2062	JTS419	SSP2138	JTS482	SSP2217	JTS130
SSP2063	JTS479	SSP2139	JTS137	SSP2219	JTS457
SSP2064	JTS511	SSP2140	JTS137	SSP2220	JTS457
SSP2066	JTS109	SSP2141	JTS129	SSP2221	JTS500
SSP2067	JTS353	SSP2142	JTS452	SSP2222	JTS406
SSP2068	JTS464	SSP2144	JTS283	SSP2223	JTS406
SSP2069	JTS437	SSP2145	JTS283	SSP2224	JTS406
SSP2070	JTS451	SSP2147	JTS673	SSP2225	JTS536
SSP2071	JTS509	SSP2148	JTS742	SSP2228	JTS7518
SSP2072	JTS508	SSP2153	JTS7618	SSP2229	JTS7519
SSP2073	JTS486	SSP2154	JTS1191	SSP2231	JTS7734
SSP2074	JTS512	SSP2162	JTS459	SSP2232	JTS7735
SSP2075	JTS1135	SSP2165	JTS352	SSP2235	JTS1096
SSP2076	JTS1136	SSP2166	JTS547	SSP2236	JTS7594
SSP2077	JTS1175	SSP2167	JTS566	SSP2237	JTS7593
SSP2078	JTS1176	SSP2168	JTS401	SSP2238	JTS7716
SSP2080	JTS987	SSP2171	JTS1145	SSP2239	JTS7715
SSP2081	JTS986	SSP2172	JTS799	SSP2240	JTS970
SSP2083	JTS00304	SSP2173	JTS554	SSP2241	JTS967
SSP2085	JTS01211	SSP2174	JTS00318	SSP2242	JTS1195
SSP2086	JTS1186	SSP2175	JTS7611	SSP2244	JTS1199
SSP2087	JTS1187	SSP2176	JTS428	SSP2245	JTS984
SSP2097	JTS1395	SSP2178	JTS405	SSP2248	JTS01873
SSP2102	JTC1103	SSP2180	JTS1293	SSP2251	JTS7595
SSP2104	JTS690	SSP2181	JTS1143	SSP2252	JTS7596
SSP2105	JTS686	SSP2182	JTS1142	SSP2253	JTS7597

MAGNETI MARELLI	TRW	MAGNETI MARELLI	TRW	MAGNETI MARELLI	TRW
SSP2254	JTS7598	SSP2340	JTS497	SSP2421	JTS7687
SSP2255	JTS560	SSP2341	JTS499	SSP2422	JTS1016
SSP2257	JTS561	SSP2347	JTS503	SSP2425	JTS7588
SSP2259	JTS562	SSP2348	JTS502	SSP2426	JTS7587
SSP2265	JTS717	SSP2349	JTS424	SSP2429	JTS7588
SSP2268	JTS738	SSP2351	JTS637	SSP2431	JTS496
SSP2270	JTS576	SSP2352	JTS636	SSP2432	JTS414
SSP2271	JTS577	SSP2353	JTS407	SSP2433	JTS413
SSP2272	JTS568	SSP2361	JTS981	SSP2434	JTS415
SSP2273	JTS567	SSP2364	JTS619	SSP2436	JTS625
SSP2274	JTS7601	SSP2365	JTS617	SSP2437	JTS415
SSP2277	JTS957	SSP2366	JTS605	SSP2444	JTS199
SSP2278	JTS574	SSP2367	JTS612	SSP2445	JTS211
SSP2279	JTS575	SSP2368	JTS611	SSP2446	JTS202
SSP2280	JTS7617	SSP2369	JTS454	SSP2447	JTS1097
SSP2281	JTS7616	SSP2370	JTS425	SSP2448	JTS1098
SSP2282	JTS7523	SSP2371	JTS621	SSP2449	JTS118
SSP2283	JTS7524	SSP2372	JTS622	SSP2450	JTS433
SSP2285	JTS1096	SSP2373	JTS627	SSP2451	JTS433
SSP2288	JTS884	SSP2374	JTS628	SSP2452	JTS928
SSP2289	JTS440	SSP2375	JTS545	SSP2453	JTS7634
SSP2290	JTS439	SSP2376	JTS544	SSP2454	JTS7633
SSP2303	JTS287	SSP2389	JTS951	SSP2457	JTS00334
SSP2304	JTS309	SSP2390	JTS193	SSP2458	JTS00333
SSP2305	JTS381	SSP2391	JTS193	SSP2460	JTS236
SSP2306	JTS381	SSP2392	JTS7571	SSP2461	JTS7689
SSP2307	JTS618	SSP2393	JTS7753	SSP2462	JTS7690
SSP2308	JTS618	SSP2398	JTS219	SSP2464	JTS1154
SSP2309	JTS620	SSP2400	JTS7573	SSP2465	JTS1153
SSP2316	JTS1216	SSP2401	JTS7574	SSP2466	JTS157
SSP2317	JTS1217	SSP2402	JTS1146	SSP2467	JTS01029
SSP2327	JTS448	SSP2403	JTS00374	SSP2468	JTS01027
SSP2328	JTS447	SSP2411	JTS7662	SSP2469	JTS7764
SSP2329	JTS446	SSP2412	JTS7663	SSP2470	JTS7746
SSP2330	JTS446	SSP2413	JTS239	SSP2471	JTS7745
SSP2331	JTS449	SSP2414	JTS531	SSP2472	JTS1052
SSP2332	JTS450	SSP2415	JTS228	SSP2473	JTS1053
SSP2336	JTS461	SSP2416	JTS227	SSP2474	JTS1148
SSP2337	JTS487	SSP2418	JTS867	SSP2477	JTS114
SSP2338	JTS488	SSP2419	JTS7638	SSP2478	JTS114
SSP2339	JTS498	SSP2420	JTS7686	SSP2479	JTS773



MAGNETI MARELLI	TRW	MAGNETI MARELLI	TRW	MAGNETI MARELLI	TRW
SSP2480	JTS770	SSP2539	JTS00342	SSP2593	JTS438
SSP2481	JTS370	SSP2540	JTS186	SSP2594	JTS416
SSP2483	JTS546	SSP2541	JTS7537	SSP2595	JTS416
SSP2484	JTS462	SSP2542	JTS7698		
SSP2485	JTS815	SSP2543	JTS7565		
SSP2487	JTS7743	SSP2544	JTS7564		
SSP2489	JTS645	SSP2545	JTS847		
SSP2490	JTS644	SSP2546	JTS7565		
SSP2495	JTS283	SSP2547	JTS7564		
SSP2496	JTS283	SSP2548	JTS866		
SSP2497	JTS556	SSP2549	JTS7710		
SSP2498	JTS557	SSP2550	JTS182		
SSP2499	JTS1012	SSP2551	JTS7554		
SSP2500	JTS642	SSP2552	JTS7552		
SSP2501	JTS642	SSP2553	JTS7553		
SSP2503	JTS467	SSP2554	JTS148		
SSP2504	JTS468	SSP2555	JTS7536		
SSP2505	JTS469	SSP2556	JTS7537		
SSP2506	JTS136	SSP2559	JTS924		
SSP2507	JTS290	SSP2561	JTS1144		
SSP2508	JTS289	SSP2566	JTS543		
SSP2509	JTS408	SSP2567	JTS522		
SSP2510	JTS603	SSP2568	JTS521		
SSP2511	JAR647	SSP2571	JTS387		
SSP2513	JTS455	SSP2572	JTS387		
SSP2514	JTS456	SSP2575	JTS396		
SSP2515	JTS930	SSP2576	JTS483		
SSP2518	JTS931	SSP2577	JTS484		
SSP2519	JTS463	SSP2578	JTS514		
SSP2520	JTS550	SSP2579	JTS123		
SSP2521	JTS530	SSP2580	JTS435		
SSP2522	JTS432	SSP2581	JTS435		
SSP2523	JTS432	SSP2582	JTS364		
SSP2525	JTS144	SSP2583	JTS364		
SSP2528	JTS466	SSP2584	JTS397		
SSP2530	JTS410	SSP2585	JTS397		
SSP2531	JTS409	SSP2586	JTS393		
SSP2534	JTS393	SSP2587	JTS397		
SSP2535	JTS393	SSP2588	JTS485		
SSP2537	JTS483	SSP2589	JTS350		
SSP2538	JTS1183	SSP2590	JTS496		

Tavole di comparazione
Cross reference guide
Gegenüberstellung Cross-Referenzen
Table de correspondance
Tabla de equivalencias
Tabelas de equivalências
Πίνακας αντιστοιχιών
Tabela porównawcza
Кросс-таблица
Çapraz referans tablosu



DELPHI	MAGNETI MARELLI	DELPHI	MAGNETI MARELLI	DELPHI	MAGNETI MARELLI
TA1031	SSP1409	TA1638	SSP0707	TA1750	SSP0496
TA1069	SSP0282	TA1639	SSP0706	TA1751	SSP0495
TA1081	SSP0698	TA1643	SSP0480	TA1752	SSP0130
TA1135	SSP0594	TA1644	SSP0004	TA1764	SSP0138
TA1154	SSP0369	TA1645	SSP0311	TA1765	SSP0133
TA1155	SSP0368	TA1646	SSP0310	TA1767	SSP1355
TA1193	SSP0551	TA1647	SSP0019	TA1770	SSP1425
TA1225	SSP0676	TA1648	SSP0318	TA1771	SSP1424
TA1237	SSP0699	TA1649	SSP0317	TA1772	SSP0437
TA1249	SSP1414	TA1658	SSP0482	TA1773	SSP0561
TA1250	SSP1415	TA1659	SSP0481	TA1774	SSP0560
TA1254	SSP0585	TA1660	SSP0125	TA1775	SSP0167
TA1374	SSP1379	TA1665	SSP0286	TA1776	SSP0212
TA1375	SSP1361	TA1666	SSP0285	TA1777	SSP0216
TA1384	SSP0049	TA1667	SSP0284	TA1778	SSP0664
TA1384	SSP0206	TA1668	SSP0283	TA1780	SSP0291
TA1436	SSP0655	TA1668	SSP0663	TA1781	SSP0290
TA1439	SSP0656	TA1671	SSP1431	TA1785	SSP1382
TA1462	SSP0071	TA1673	SSP0272	TA1787	SSP1402
TA1470	SSP0056	TA1674	SSP0420	TA1788	SSP1401
TA1489	SSP0570	TA1675	SSP0419	TA1789	SSP0650
TA1503	SSP0050	TA1676	SSP0600	TA1790	SSP0649
TA1506	SSP1416	TA1676	SSP0601	TA1795	SSP0662
TA1507	SSP1364	TA1677	SSP0195	TA1796	SSP0661
TA1510	SSP1363	TA1679	SSP0207	TA1800	SSP0165
TA1516	SSP0442	TA1680	SSP0595	TA1803	SSP0634
TA1535	SSP0550	TA1681	SSP0630	TA1804	SSP0633
TA1535	SSP0552	TA1682	SSP0629	TA1805	SSP0220
TA1536	SSP0559	TA1683	SSP0515	TA1808	SSP0434
TA1536	SSP0708	TA1686	SSP0315	TA1809	SSP0095
TA1551	SSP0186	TA1687	SSP0314	TA1810	SSP0094
TA1552	SSP0185	TA1688	SSP0648	TA1813	SSP0097
TA1583	SSP0287	TA1689	SSP0647	TA1814	SSP0642
TA1597	SSP1362	TA1692	SSP1417	TA1815	SSP0641
TA1607	SSP1429	TA1696	SSP0673	TA1816	SSP0223
TA1608	SSP1381	TA1697	SSP0672	TA1817	SSP0435
TA1611	SSP0072	TA1698	SSP0255	TA1818	SSP1366
TA1614	SSP0413	TA1702	SSP0689	TA1821	SSP0710
TA1615	SSP0077	TA1734	SSP0171	TA1822	SSP0709
TA1625	SSP0646	TA1742	SSP0505	TA1823	SSP0277
TA1626	SSP0645	TA1747	SSP0257	TA1824	SSP0377



DELPHI	MAGNETI MARELLI	DELPHI	MAGNETI MARELLI	DELPHI	MAGNETI MARELLI
TA1825	SSP0376	TA1951	SSP0602	TA2026	SSP0412
TA1826	SSP0059	TA1959	SSP0531	TA2027	SSP0411
TA1827	SSP0373	TA1960	SSP0530	TA2029	SSP0188
TA1828	SSP0372	TA1961	SSP0529	TA2030	SSP0518
TA1829	SSP0057	TA1964	SSP0022	TA2031	SSP0517
TA1851	SSP1399	TA1965	SSP0461	TA2032	SSP0145
TA1852	SSP1398	TA1969	SSP1356	TA2033	SSP1441
TA1855	SSP1348	TA1970	SSP0544	TA2035	SSP0321
TA1874	SSP0231	TA1971	SSP0543	TA2036	SSP0023
TA1875	SSP0313	TA1972	SSP0153	TA2037	SSP0020
TA1876	SSP0312	TA1973	SSP0678	TA2041	SSP1449
TA1883	SSP0274	TA1974	SSP0677	TA2042	SSP1448
TA1892	SSP1347	TA1975	SSP0259	TA2043	SSP1393
TA1894	SSP0232	TA1976	SSP0538	TA2044	SSP0705
TA1896	SSP1375	TA1977	SSP0537	TA2045	SSP0704
TA1897	SSP0076	TA1978	SSP0150	TA2046	SSP0271
TA1898	SSP0055	TA1980	SSP0007	TA2049	SSP0084
TA1899	SSP0582	TA1983	SSP0498	TA2050	SSP0469
TA1901	SSP0572	TA1984	SSP0497	TA2051	SSP0468
TA1902	SSP0571	TA1986	SSP1389	TA2052	SSP0116
TA1903	SSP0596	TA1987	SSP1435	TA2053	SSP0115
TA1904	SSP0190	TA1988	SSP1386	TA2056	SSP0131
TA1905	SSP0269	TA1989	SSP0422	TA2057	SSP0180
TA1906	SSP0316	TA1990	SSP0421	TA2060	SSP0305
TA1907	SSP0021	TA1991	SSP0083	TA2061	SSP0304
TA1914	SSP0701	TA1992	SSP0191	TA2062	SSP0015
TA1915	SSP0700	TA1993	SSP0597	TA2063	SSP0323
TA1931	SSP1451	TA1998	SSP0225	TA2064	SSP0226
TA1933	SSP0684	TA2000	SSP0005	TA2065	SSP0336
TA1934	SSP0683	TA2001	SSP0003	TA2066	SSP0335
TA1936	SSP0262	TA2002	SSP1365	TA2067	SSP0029
TA1941	SSP0640	TA2005	SSP0443	TA2068	SSP0343
TA1942	SSP0639	TA2013	SSP0228	TA2069	SSP0342
TA1943	SSP0222	TA2013	SSP0238	TA2070	SSP0034
TA1944	SSP0524	TA2014	SSP0227	TA2071	SSP0348
TA1945	SSP0523	TA2015	SSP0233	TA2072	SSP0349
TA1946	SSP0143	TA2015	SSP0234	TA2073	SSP0038
TA1947	SSP0620	TA2017	SSP0235	TA2078	SSP0666
TA1948	SSP0619	TA2018	SSP0229	TA2081	SSP0714
TA1949	SSP0210	TA2018	SSP0236	TA2082	SSP0713
TA1950	SSP0603	TA2020	SSP0273	TA2085	SSP0472

DELPHI	MAGNETI MARELLI	DELPHI	MAGNETI MARELLI	DELPHI	MAGNETI MARELLI
TA2087	SSP0578	TA2376	SSP0299	TA2470	SSP0296
TA2089	SSP0219	TA2377	SSP0009	TA2471	SSP0295
TA2090	SSP0512	TA2383	SSP0292	TA2472	SSP0146
TA2091	SSP0511	TA2384	SSP0614	TA2474	SSP1434
TA2092	SSP0137	TA2385	SSP0613	TA2475	SSP1433
TA2093	SSP0086	TA2386	SSP0555	TA2479	SSP0354
TA2100	SSP0279	TA2387	SSP0554	TA2480	SSP0453
TA2101	SSP0111	TA2388	SSP0161	TA2481	SSP0452
TA2102	SSP0120	TA2389	SSP0449	TA2482	SSP0658
TA2104	SSP0123	TA2390	SSP0448	TA2483	SSP0657
TA2105	SSP0510	TA2391	SSP0267	TA2484	SSP0665
TA2106	SSP0509	TA2393	SSP0681	TA2485	SSP0006
TA2107	SSP0136	TA2395	SSP0008	TA2486	SSP0183
TA2109	SSP0016	TA2396	SSP0208	TA2487	SSP1385
TA2119	SSP0712	TA2397	SSP0252	TA2488	SSP1352
TA2120	SSP0711	TA2399	SSP0260	TA2489	SSP0622
TA2121	SSP0278	TA2400	SSP0669	TA2490	SSP0621
TA2126	SSP0584	TA2401	SSP0250	TA2491	SSP0532
TA2154	SSP0697	TA2402	SSP0549	TA2492	SSP0106
TA2155	SSP0696	TA2411	SSP0692	TA2494	SSP0371
TA2192	SSP0466	TA2412	SSP0691	TA2495	SSP0370
TA2329	SSP0387	TA2413	SSP1367	TA2496	SSP0202
TA2330	SSP0386	TA2413	SSP1392	TA2497	SSP1344
TA2331	SSP0065	TA2431	SSP0189	TA2498	SSP0410
TA2336	SSP0618	TA2442	SSP0328	TA2499	SSP0409
TA2337	SSP0617	TA2442	SSP0329	TA2500	SSP0652
TA2338	SSP1421	TA2447	SSP0439	TA2501	SSP0651
TA2339	SSP1419	TA2448	SSP0438	TA2502	SSP0239
TA2340	SSP1397	TA2449	SSP1438	TA2503	SSP0244
TA2341	SSP1396	TA2450	SSP0587	TA2504	SSP0075
TA2345	SSP0148	TA2451	SSP0586	TA2508	SSP0289
TA2347	SSP0163	TA2453	SSP0197	TA2509	SSP0288
TA2352	SSP0251	TA2457	SSP0249	TA2510	SSP0209
TA2355	SSP0198	TA2460	SSP0098	TA2511	SSP0196
TA2362	SSP0563	TA2461	SSP0516	TA2521	SSP0052
TA2363	SSP0562	TA2462	SSP0139	TA2522	SSP0242
TA2368	SSP0668	TA2463	SSP0213	TA2567	SSP0591
TA2369	SSP0667	TA2465	SSP0626	TA2568	SSP0590
TA2371	SSP0103	TA2466	SSP0625	TA2570	SSP0580
TA2372	SSP0248	TA2468	SSP0686	TA2571	SSP0579
TA2374	SSP0166	TA2469	SSP0685	TA2572	SSP0486



DELPHI	MAGNETI MARELLI	DELPHI	MAGNETI MARELLI	DELPHI	MAGNETI MARELLI
TA2573	SSP0485	TA2665	SSP0028	TA2786	SSP0504
TA2577	SSP0140	TA2669	SSP0389	TA2787	SSP0503
TA2578	SSP0214	TA2670	SSP0388	TA2806	SSP0211
TA2579	SSP0179	TA2671	SSP1428	TA2807	SSP0307
TA2583	SSP0126	TA2672	SSP1427	TA2808	SSP0306
TA2585	SSP0638	TA2673	SSP0536	TA2835	SSP0575
TA2586	SSP0637	TA2674	SSP0535	TA2837	SSP0527
TA2587	SSP0276	TA2675	SSP0149	TA2839	SSP0253
TA2590	SSP0456	TA2676	SSP0589	TA2848	SSP0399
TA2591	SSP0108	TA2677	SSP0588	TA2849	SSP0624
TA2592	SSP0604	TA2679	SSP0463	TA2850	SSP0623
TA2593	SSP0675	TA2680	SSP0462	TA2851	SSP0158
TA2594	SSP0674	TA2681	SSP0636	TA2854	SSP0045
TA2595	SSP0168	TA2682	SSP0635	TA2856	SSP0263
TA2616	SSP1373	TA2683	SSP0379	TA2858	SSP0132
TA2617	SSP0112	TA2684	SSP0378	TA2862	SSP0270
TA2620	SSP0160	TA2687	SSP0187	TA2863	SSP0099
TA2621	SSP0058	TA2688	SSP1378	TA2865	SSP0447
TA2624	SSP1408	TA2695	SSP0192	TA2866	SSP0446
TA2625	SSP0256	TA2696	SSP0193	TA2867	SSP0671
TA2626	SSP0680	TA2697	SSP0144	TA2873	SSP0010
TA2627	SSP0679	TA2698	SSP0199	TA2876	SSP0360
TA2628	SSP0066	TA2699	SSP0200	TA2877	SSP0574
TA2629	SSP0170	TA2704	SSP0340	TA2878	SSP0573
TA2630	SSP0104	TA2705	SSP0205	TA2884	SSP0502
TA2631	SSP0488	TA2706	SSP0121	TA2885	SSP0501
TA2632	SSP0487	TA2707	SSP0326	TA2887	SSP0217
TA2633	SSP0565	TA2708	SSP0325	TA2889	SSP0054
TA2634	SSP0564	TA2709	SSP0429	TA2890	SSP0241
TA2639	SSP0553	TA2710	SSP0428	TA2894	SSP0240
TA2642	SSP0644	TA2712	SSP0127	TA2899	SSP0135
TA2643	SSP0643	TA2713	SSP0172	TA2900	SSP0194
TA2645	SSP0558	TA2714	SSP0033	TA2901	SSP0441
TA2647	SSP0526	TA2715	SSP1452	TA2902	SSP0440
TA2647	SSP0528	TA2717	SSP0184	TA2903	SSP0268
TA2648	SSP0525	TA2746	SSP0041	TA2909	SSP0474
TA2649	SSP0451	TA2752	SSP0060	TA2910	SSP0473
TA2650	SSP0450	TA2760	SSP0201	TA2913	SSP0654
TA2660	SSP0258	TA2761	SSP0175	TA2914	SSP0653
TA2662	SSP0375	TA2779	SSP0221	TA2915	SSP0294
TA2663	SSP0374	TA2780	SSP0026	TA2916	SSP0293

DELPHI	MAGNETI MARELLI	DELPHI	MAGNETI MARELLI	DELPHI	MAGNETI MARELLI
TA2917	SSP0455	TA3195	SSP0109	TA5001	SSP0690
TA2918	SSP0454	TA3198	SSP0113	TA5005	SSP0079
TA2921	SSP0341	TA3201	SSP0324	TA5012	SSP0407
TA2934	SSP0628	TA3202	SSP0025	TA5013	SSP0408
TA2935	SSP0627	TA3204	SSP0101	TA5262	SSP0046
TA2936	SSP0215	TA3214	SSP0494	TA5439	SSP0394
TA2997	SSP0424	TA3215	SSP0493	TA5440	SSP0395
TA2998	SSP0423	TA3216	SSP0129	TA5445	SSP0470
TA3019	SSP0490	TA3217	SSP0013	TA5446	SSP0471
TA3020	SSP0489	TA3220	SSP0309	TA977	SSP0612
TA3021	SSP0598	TA3221	SSP0308	TC1003	SSP1929
TA3022	SSP0154	TA3222	SSP0508	TC1004	ARM874
TA3023	SSP0401	TA3226	SSP0534	TC1005	ARM873
TA3024	SSP0400	TA3227	SSP0533	TC1006	SSP1971
TA3025	SSP0546	TA3228	SSP0477	TC1007	ARM1015
TA3026	SSP0545	TA3228	SSP0479	TC1008	ARM1014
TA3030	SSP0164	TA3229	SSP0476	TC1010	SSP1189
TA3047	SSP0147	TA3230	SSP0017	TC1011	ARM134
TA3063	SSP0152	TA3231	SSP0702	TC1012	ARM133
TA3074	SSP0542	TA3232	SSP0703	TC1013	ARM148
TA3075	SSP0541	TA3237	SSP0540	TC1013	ARM490
TA3162	SSP0599	TA3238	SSP0539	TC1014	ARM147
TA3163	SSP0105	TA3239	SSP0593	TC1014	ARM489
TA3164	SSP0159	TA3240	SSP0592	TC1016	SSP1850
TA3170	SSP0018	TA3241	SSP0616	TC1016	SSP1851
TA3172	SSP0281	TA3242	SSP0615	TC1017	ARM588
TA3173	SSP0567	TA3243	SSP0660	TC1018	ARM587
TA3174	SSP0566	TA3244	SSP0659	TC1019	SSP2432
TA3175	SSP0327	TA3246	SSP0053	TC1020	SSP2433
TA3176	SSP0301	TA3249	SSP0606	TC1021	SSP2434
TA3177	SSP0300	TA3250	SSP0605	TC1021	SSP2437
TA3178	SSP0569	TA3255	SSP0107	TC1022	SSP1939
TA3179	SSP0568	TA3258	SSP0151	TC1022	SSP1940
TA3182	SSP0465	TA3262	SSP0204	TC1023	SSP2509
TA3183	SSP0464	TA3263	SSP0203	TC1034	ARM519
TA3184	SSP0280	TA3265	SSP0404	TC1035	ARM526
TA3186	SSP0096	TA3271	SSP0162	TC1036	ARM525
TA3187	SSP0632	TA3290	SSP0718	TC1037	ARM528
TA3188	SSP0631	TA3291	SSP0717	TC1038	ARM527
TA3191	SSP0694	TA3300	SSP0416	TC1040	SSP2002
TA3192	SSP0693	TA3301	SSP0415	TC1040	SSP2003



DELPHI	MAGNETI MARELLI	DELPHI	MAGNETI MARELLI	DELPHI	MAGNETI MARELLI
TC1041	SSP2004	TC1150	SSP1846	TC1203	SSP2277
TC1042	SSP1775	TC1150	SSP1849	TC1206	SSP2012
TC1053	ARM653	TC1154	SSP2222	TC1207	SSP2013
TC1054	ARM652	TC1154	SSP2223	TC1226	ARM307
TC1055	SSP2304	TC1155	SSP1909	TC1227	ARM306
TC1056	SSP2186	TC1156	ARM927	TC1247	ARM421
TC1056	SSP2187	TC1157	ARM926	TC1248	ARM420
TC1057	ARM096	TC1158	SSP1833	TC1251	ARM415
TC1058	ARM095	TC1159	ARM514	TC1252	ARM414
TC1059	SSP1327	TC1160	ARM513	TC1262	ARM536
TC1062	ARM004	TC1161	SSP2522	TC1263	ARM955
TC1063	ARM003	TC1161	SSP2523	TC1264	ARM954
TC1064	ARM120	TC1162	SSP1954	TC1265	ARM425
TC1065	ARM119	TC1163	SSP2213	TC1266	ARM424
TC1066	SSP1292	TC1163	SSP2214	TC1269	ARM127
TC1067	SSP1293	TC1164	SSP2212	TC1270	ARM128
TC1068	ARM126	TC1165	ARM581	TC1272	SSP2050
TC1069	ARM125	TC1166	ARM580	TC1277	SSP1911
TC1084	SSP1962	TC1167	SSP2330	TC1278	SSP1910
TC1085	SSP1961	TC1168	SSP2328	TC1279	ARM708
TC1086	SSP2534	TC1169	SSP2327	TC1280	ARM707
TC1086	SSP2535	TC1170	SSP2224	TC1281	ARM705
TC1086	SSP2586	TC1171	SSP2219	TC1282	ARM706
TC1088	ARM992	TC1171	SSP2220	TC1283	SSP1198
TC1089	ARM991	TC1172	SSP2221	TC1284	ARM026
TC1104	SSP2391	TC1173	SSP2594	TC1284	ARM492
TC1105	SSP2390	TC1173	SSP2595	TC1285	ARM027
TC1112	SSP2508	TC1174	SSP1296	TC1285	ARM491
TC1113	SSP2507	TC1175	SSP1295	TC1286	SSP1199
TC1125	SSP1315	TC1176	SSP1819	TC1287	ARM028
TC1125	SSP2165	TC1177	ARM177	TC1287	ARM494
TC1128	SSP2340	TC1178	ARM175	TC1288	ARM027
TC1129	SSP2339	TC1179	ARM181	TC1288	ARM493
TC1130	SSP1947	TC1183	SSP2414	TC1290	SSP2015
TC1131	SSP2514	TC1184	SSP1968	TC1291	SSP2014
TC1132	SSP2513	TC1191	SSP1326	TC1292	ARM575
TC1133	SSP1323	TC1192	SSP1988	TC1293	ARM574
TC1134	ARM018	TC1193	SSP2110	TC1295	SSP2018
TC1135	ARM017	TC1195	SSP1294	TC1296	SSP2466
TC1141	ARM162	TC1196	SSP2093	TC1297	ARM862
TC1142	ARM161	TC1196	SSP2094	TC1298	ARM861

DELPHI	MAGNETI MARELLI	DELPHI	MAGNETI MARELLI	DELPHI	MAGNETI MARELLI
TC1305	SSP2451	TC1361	SSP2415	TC1414	SSP2557
TC1306	SSP1919	TC1362	SSP2519	TC1415	SSP2556
TC1307	ARM846	TC1363	SSP1953	TC1416	SSP2552
TC1307	ARM941	TC1364	ARM953	TC1417	SSP2392
TC1308	ARM845	TC1365	ARM952	TC1418	SSP2190
TC1308	ARM940	TC1366	SSP1952	TC1419	SSP2192
TC1311	SSP1931	TC1367	ARM949	TC1429	SSP2307
TC1312	SSP1930	TC1367	ARM951	TC1430	SSP1878
TC1313	ARM876	TC1368	ARM948	TC1431	ARM076
TC1314	ARM875	TC1368	ARM950	TC1432	ARM075
TC1315	SSP2537	TC1369	SSP1887	TC1433	SSP1837
TC1315	SSP2576	TC1370	SSP1936	TC1445	ARM1030
TC1316	SSP1977	TC1371	SSP1935	TC1446	ARM1029
TC1317	SSP1976	TC1372	SSP2505	TC1447	ARM842
TC1318	SSP2062	TC1373	SSP2504	TC1448	ARM841
TC1319	SSP2061	TC1374	SSP2503	TC1449	ARM794
TC1320	ARM286	TC1375	SSP2483	TC1450	ARM793
TC1321	ARM287	TC1376	ARM888	TC1454	SSP2575
TC1322	ARM288	TC1377	ARM887	TC1455	SSP2555
TC1323	ARM289	TC1382	SSP1891	TC1464	SSP2584
TC1324	SSP2063	TC1383	ARM747	TC1465	ARM677
TC1325	SSP2577	TC1384	ARM748	TC1466	ARM676
TC1329	ARM985	TC1385	ARM745	TC1467	ARM957
TC1330	ARM984	TC1386	ARM746	TC1468	ARM956
TC1331	ARM943	TC1387	SSP2370	TC1469	SSP1341
TC1332	ARM942	TC1388	SSP2057	TC1470	ARM036
TC1334	ARM1049	TC1389	SSP2056	TC1471	ARM035
TC1335	ARM1048	TC1390	ARM295	TC1472	ARM314
TC1341	SSP2006	TC1391	ARM296	TC1473	SSP2034
TC1342	ARM292	TC1392	ARM298	TC1474	SSP2033
TC1345	ARM321	TC1393	ARM297	TC1475	SSP2035
TC1346	ARM320	TC1394	SSP2058	TC1476	ARM250
TC1347	ARM319	TC1406	SSP1312	TC1477	ARM249
TC1348	ARM020	TC1406	SSP2162	TC1478	SSP2072
TC1349	ARM019	TC1407	ARM090	TC1479	SSP2071
TC1352	SSP2531	TC1408	ARM089	TC1480	SSP1787
TC1353	SSP2530	TC1409	SSP2401	TC1481	ARM323
TC1354	SSP2448	TC1410	SSP2400	TC1482	ARM324
TC1355	SSP2447	TC1411	ARM806	TC1483	ARM326
TC1356	SSP2559	TC1412	SSP2402	TC1484	ARM325
TC1360	SSP2416	TC1413	SSP1972	TC1485	SSP2073



DELPHI	MAGNETI MARELLI	DELPHI	MAGNETI MARELLI	DELPHI	MAGNETI MARELLI
TC1488	ARM1069	TC1554	SSP2553	TC1756	ARM804
TC1489	ARM1068	TC1555	SSP2064	TC1764	SSP2562
TC1490	ARM752	TC1556	SSP2550	TC1766	SSP2309
TC1491	ARM751	TC1557	SSP2189	TC1768	SSP2548
TC1492	ARM750	TC1559	SSP1860	TC1773	SSP2281
TC1493	ARM749	TC1562	SSP2279	TC1774	SSP2280
TC1494	ARM742	TC1563	SSP2278	TC1775	SSP2426
TC1495	ARM741	TC1564	SSP1882	TC1776	SSP2425
TC1496	ARM743	TC1565	SSP2336	TC1777	SSP1289
TC1497	ARM744	TC1566	SSP1883	TC1778	SSP1291
TC1498	SSP2372	TC1569	SSP2239	TC1781	SSP2019
TC1499	SSP2371	TC1570	SSP2238	TC1782	SSP2021
TC1501	SSP1798	TC1571	SSP2270	TC1783	SSP2566
TC1502	SSP2153	TC1572	SSP2271	TC1790	SSP2023
TC1503	ARM372	TC1573	SSP2485	TC1791	SSP2389
TC1504	ARM371	TC1589	SSP2423	TC1792	SSP1975
TC1505	SSP1801	TC1590	SSP2424	TC1796	SSP2524
TC1506	SSP2109	TC1593	SSP1181	TC1798	SSP2568
TC1507	SSP2108	TC1594	SSP1182	TC1799	SSP2567
TC1509	ARM381	TC1599	SSP2591	TC1800	SSP2054
TC1510	ARM380	TC1727	ARM278	TC1801	SSP2053
TC1511	SSP1804	TC1728	ARM275	TC1802	SSP2498
TC1517	SSP2540	TC1729	ARM447	TC1803	SSP2497
TC1518	SSP2541	TC1730	ARM446	TC1804	SSP2060
TC1519	SSP1989	TC1731	SSP1979	TC1805	SSP2059
TC1529	SSP2252	TC1731	SSP1981	TC1806	SSP1316
TC1530	SSP2251	TC1732	SSP1978	TC1807	SSP1188
TC1531	SSP2254	TC1732	SSP1980	TC1808	ARM909
TC1532	SSP2253	TC1733	SSP1869	TC1809	ARM907
TC1533	SSP2247	TC1742	SSP2209	TC1810	ARM881
TC1533	SSP2283	TC1745	ARM122	TC1811	ARM880
TC1534	SSP2246	TC1746	ARM121	TC1812	ARM210
TC1534	SSP2282	TC1747	ARM632	TC1813	ARM209
TC1542	ARM1083	TC1748	ARM631	TC1814	SSP1288
TC1543	ARM1082	TC1749	ARM252	TC1815	SSP1287
TC1544	ARM1081	TC1750	ARM251	TC1815	SSP2029
TC1545	ARM1080	TC1751	ARM738	TC1816	SSP2237
TC1549	SSP2306	TC1752	ARM739	TC1821	ARM510
TC1550	SSP2338	TC1753	ARM740	TC1822	ARM509
TC1551	SSP2337	TC1754	ARM737	TC1825	SSP2547
TC1553	SSP2551	TC1755	ARM805	TC1826	SSP2546

DELPHI	MAGNETI MARELLI	DELPHI	MAGNETI MARELLI	DELPHI	MAGNETI MARELLI
TC1827	ARM208	TC1934	ARM153	TC1994	SSP1974
TC1828	ARM207	TC1935	ARM498	TC1995	SSP1893
TC1829	ARM058	TC1936	ARM497	TC1995	SSP1894
TC1830	ARM059	TC1938	ARM499	TC1997	SSP1328
TC1831	SSP2467	TC1939	SSP2549	TC1998	ARM657
TC1832	SSP2468	TC1942	ARM094	TC1999	ARM656
TC1839	SSP2542	TC1943	ARM093	TC2000	ARM535
TC1869	ARM202	TC1944	ARM589	TC2001	SSP1854
TC1870	ARM201	TC1945	ARM254	TC2002	SSP2228
TC1876	SSP2236	TC1946	ARM245	TC2003	SSP2229
TC1877	SSP2020	TC1947	ARM757	TC2006	SSP1193
TC1878	ARM213	TC1948	ARM756	TC2007	SSP1194
TC1879	ARM212	TC1949	ARM759	TC2008	SSP1948
TC1880	ARM211	TC1950	ARM758	TC2011	ARM112
TC1895	SSP1795	TC1953	SSP2450	TC2012	ARM111
TC1896	SSP1794	TC1954	ARM590	TC2021	SSP1321
TC1897	ARM913	TC1955	ARM591	TC2022	SSP2188
TC1898	ARM912	TC1956	ARM217	TC2026	SSP2571
TC1901	SSP2582	TC1957	ARM216	TC2027	SSP2587
TC1907	SSP1852	TC1958	SSP2376	TC2028	SSP1945
TC1909	SSP1319	TC1959	SSP2375	TC2030	SSP2010
TC1910	SSP1857	TC1961	SSP2345	TC2032	ARM669
TC1911	ARM903	TC1962	SSP2578	TC2033	ARM667
TC1912	ARM902	TC1964	ARM877	TC2033	ARM668
TC1913	ARM389	TC1968	ARM244	TC2034	ARM671
TC1914	ARM388	TC1969	ARM243	TC2035	ARM672
TC1917	ARM255	TC1971	SSP1836	TC2035	ARM673
TC1918	ARM253	TC1972	ARM637	TC2041	ARM305
TC1919	SSP2193	TC1973	ARM636	TC2042	ARM304
TC1920	SSP2561	TC1974	ARM152	TC2043	ARM655
TC1921	ARM092	TC1975	ARM151	TC2044	ARM654
TC1922	ARM091	TC1978	SSP2489	TC2045	SSP2589
TC1923	SSP2348	TC1979	SSP2487	TC2047	SSP2176
TC1924	SSP2347	TC1981	SSP2244	TC2050	SSP2230
TC1925	SSP2378	TC1985	ARM1085	TC2051	SSP2572
TC1926	SSP2377	TC1986	ARM1084	TC2052	SSP2042
TC1927	ARM994	TC1987	SSP2126	TC2053	SSP2290
TC1928	ARM993	TC1988	SSP2125	TC2054	SSP2289
TC1931	ARM983	TC1989	SSP1926	TC2055	SSP2353
TC1932	ARM982	TC1990	SSP1858	TC2056	SSP2350
TC1933	ARM154	TC1991	SSP1184	TC2057	SSP2352



DELPHI	MAGNETI MARELLI	DELPHI	MAGNETI MARELLI	DELPHI	MAGNETI MARELLI
TC2058	SSP2351	TC2126	ARM697	TC2168	SSP2501
TC2059	SSP2459	TC2127	SSP2341	TC2168	SSP2511
TC2060	SSP2460	TC2128	ARM696	TC2169	SSP2520
TC2061	SSP1205	TC2128	ARM702	TC2170	SSP1201
TC2062	SSP1206	TC2129	ARM701	TC2171	ARM608
TC2063	SSP2211	TC2130	SSP2343	TC2172	ARM607
TC2064	SSP1786	TC2131	SSP2344	TC2173	ARM140
TC2065	ARM318	TC2132	SSP2349	TC2174	ARM139
TC2066	ARM317	TC2133	SSP1888	TC2175	ARM929
TC2067	SSP2049	TC2134	SSP2363	TC2176	ARM928
TC2068	SSP2069	TC2135	ARM722	TC2184	ARM512
TC2069	SSP2068	TC2136	ARM721	TC2185	ARM511
TC2070	SSP2070	TC2137	ARM724	TC2186	SSP1983
TC2073	ARM316	TC2138	ARM723	TC2189	ARM1036
TC2074	ARM315	TC2139	ARM915	TC2190	ARM1035
TC2075	ARM118	TC2140	ARM914	TC2191	SSP1782
TC2076	ARM117	TC2141	ARM1051	TC2192	SSP1781
TC2085	SSP1339	TC2142	ARM1050	TC2197	SSP2462
TC2088	SSP2580	TC2143	ARM889	TC2198	SSP2461
TC2088	SSP2581	TC2144	SSP2362	TC2218	ARM142
TC2089	SSP1982	TC2146	SSP2074	TC2219	ARM141
TC2093	ARM1079	TC2147	SSP1922	TC2220	SSP2364
TC2094	ARM1078	TC2148	SSP1306	TC2221	SSP2539
TC2096	SSP2593	TC2149	SSP1305	TC2222	SSP1317
TC2097	SSP2374	TC2150	SSP2317	TC2223	SSP2538
TC2098	SSP2373	TC2151	SSP2316	TC2224	SSP2369
TC2100	SSP2016	TC2152	SSP2242	TC2226	ARM755
TC2102	SSP1314	TC2153	SSP1808	TC2227	ARM332
TC2105	ARM114	TC2154	SSP2436	TC2228	ARM331
TC2106	ARM113	TC2155	SSP2076	TC2229	ARM334
TC2108	ARM541	TC2156	SSP2075	TC2230	ARM333
TC2109	ARM540	TC2157	SSP1908	TC2231	SSP2225
TC2117	SSP1866	TC2158	ARM597	TC2232	ARM322
TC2118	SSP2274	TC2159	ARM596	TC2233	SSP1914
TC2119	SSP2303	TC2160	ARM584	TC2234	SSP1913
TC2120	ARM685	TC2161	ARM1046	TC2244	ARM074
TC2121	ARM684	TC2161	ARM1047	TC2245	ARM073
TC2122	SSP2329	TC2164	SSP1832	TC2246	ARM309
TC2123	SSP2332	TC2165	SSP2473	TC2247	ARM308
TC2124	SSP2331	TC2166	SSP2472	TC2248	ARM761
TC2125	ARM698	TC2168	SSP2500	TC2249	ARM760

DELPHI	MAGNETI MARELLI	DELPHI	MAGNETI MARELLI	DELPHI	MAGNETI MARELLI
TC2252	ARM544	TC2311	SSP2024	TC2373	SSP2154
TC2253	ARM543	TC2312	SSP2025	TC2376	SSP1946
TC2254	SSP1892	TC2313	SSP2144	TC2377	SSP1949
TC2255	SSP1907	TC2313	SSP2145	TC2378	SSP1870
TC2256	ARM189	TC2319	SSP2215	TC2379	SSP1889
TC2257	SSP2078	TC2320	SSP1780	TC2380	SSP1890
TC2258	SSP2077	TC2321	SSP1964	TC2385	SSP2488
TC2259	SSP2365	TC2322	SSP1963	TC2386	SSP2083
TC2260	SSP1895	TC2323	SSP2463	TC2388	SSP2398
TC2262	ARM850	TC2326	ARM967	TC2389	SSP2399
TC2263	ARM849	TC2327	ARM966	TC2396	SSP2515
TC2268	SSP2312	TC2328	ARM336	TC2399	ARM269
TC2268	SSP2313	TC2329	ARM335	TC2400	ARM268
TC2269	SSP2310	TC233	SSP1944	TC2404	SSP2469
TC2270	SSP2525	TC2332	ARM537	TC2405	SSP1924
TC2270	SSP2526	TC2333	ARM763	TC2407	SSP1823
TC2270	SSP2527	TC2334	ARM762	TC2409	SSP2082
TC2278	SSP2123	TC2335	ARM199	TC2410	SSP2065
TC2278	SSP2124	TC2336	ARM198	TC2414	SSP2518
TC2279	SSP2490	TC2337	ARM767	TC2415	SSP2517
TC2282	ARM998	TC2338	ARM766	TC2416	SSP1958
TC2283	ARM997	TC2342	SSP1956	TC242	SSP1927
TC2284	SSP2241	TC2343	SSP1955	TC2424	SSP1886
TC2285	SSP2240	TC2344	ARM822	TC2426	SSP1820
TC2286	SSP2465	TC2345	ARM821	TC2429	ARM895
TC2287	SSP2464	TC2346	ARM391	TC2430	ARM894
TC2288	SSP2422	TC2347	ARM390	TC2431	SSP1925
TC2289	SSP2421	TC2349	SSP1903	TC2432	SSP1325
TC2290	SSP1309	TC2351	ARM476	TC2435	SSP1957
TC2291	SSP2257	TC2352	ARM475	TC2437	SSP1969
TC2292	SSP2255	TC2353	ARM945	TC2444	ARM449
TC2293	ARM754	TC2354	ARM944	TC2445	ARM448
TC2294	ARM753	TC2357	ARM710	TC2446	ARM828
TC2295	SSP2592	TC2358	ARM709	TC2447	ARM827
TC2297	SSP2420	TC2359	ARM124	TC2448	ARM704
TC2301	ARM401	TC2360	ARM123	TC2449	ARM703
TC2302	ARM400	TC2361	SSP1202	TC2450	ARM197
TC2303	SSP2259	TC2362	SSP1203	TC2451	ARM196
TC2307	SSP2272	TC2368	SSP2454	TC2452	ARM193
TC2308	SSP2273	TC2369	SSP2453	TC2453	ARM192
TC2310	SSP2455	TC2370	SSP1950	TC2454	ARM195



DELPHI	MAGNETI MARELLI	DELPHI	MAGNETI MARELLI	DELPHI	MAGNETI MARELLI
TC2455	ARM194	TC2555	ARM774	TC2652	SSP2294
TC2461	ARM959	TC2562	SSP2175	TC2655	SSP2441
TC2462	ARM958	TC2563	ARM714	TC2656	SSP2440
TC2463	ARM1019	TC2564	ARM713	TC2657	SSP2476
TC2464	ARM1018	TC2565	ARM712	TC2658	SSP2130
TC2465	ARM620	TC2566	ARM711	TC2659	ARM987
TC2466	ARM619	TC2567	ARM560	TC2660	ARM986
TC2467	ARM866	TC2568	ARM559	TC2664	SSP1856
TC2468	ARM865	TC2587	ARM891	TC2665	SSP2227
TC2469	ARM606	TC2588	ARM890	TC2667	SSP2569
TC2470	ARM605	TC2589	ARM241	TC2671	SSP1951
TC2471	ARM947	TC2590	ARM240	TC2672	SSP1920
TC2472	ARM946	TC2593	SSP2147	TC2673	SSP1942
TC2482	ARM990	TC2596	ARM282	TC2674	ARM550
TC2483	ARM989	TC2597	ARM280	TC2675	ARM549
TC2487	ARM635	TC2598	ARM1001	TC2677	SSP2512
TC2492	ARM423	TC2599	ARM999	TC2681	SSP2107
TC2493	ARM422	TC2601	SSP2206	TC2682	ARM852
TC2494	ARM612	TC2603	ARM911	TC2683	ARM851
TC2495	ARM611	TC2604	ARM910	TC2684	SSP1783
TC2496	ARM864	TC2605	ARM818	TC2686	SSP1853
TC2497	ARM863	TC2606	SSP1970	TC2688	SSP2195
TC2512	SSP2293	TC2609	SSP2361	TC2695	ARM364
TC2513	SSP2292	TC2610	SSP2087	TC2696	ARM363
TC2515	SSP2037	TC2611	SSP2086	TC2699	SSP2560
TC2516	SSP2036	TC2613	SSP2471	TC2700	SSP2226
TC2517	SSP2418	TC2614	SSP2470	TC2704	SSP2245
TC2518	SSP1987	TC2616	SSP2419	TC2705	ARM409
TC2519	ARM965	TC2619	ARM594	TC2706	ARM408
TC2520	ARM964	TC2623	SSP1788	TC2707	SSP2558
TC2527	ARM826	TC2626	SSP2521	TC2708	ARM206
TC2528	ARM825	TC2628	SSP2554	TC2709	ARM205
TC2529	ARM1033	TC2632	SSP2439	TC2710	ARM548
TC2535	SSP2084	TC2633	SSP2438	TC2711	ARM545
TC2536	SSP2041	TC2635	ARM136	TC2720	ARM397
TC2537	SSP2040	TC2636	ARM135	TC2721	ARM396
TC2538	SSP2585	TC2641	SSP2055	TC2722	ARM547
TC254	SSP1187	TC2642	SSP2545	TC2723	ARM546
TC2550	ARM979	TC2645	SSP2039	TC2728	ARM1053
TC2551	ARM978	TC2646	SSP2038	TC2729	ARM1052
TC2554	ARM775	TC2651	SSP2295	TC2732	ARM1061

DELPHI	MAGNETI MARELLI	DELPHI	MAGNETI MARELLI	DELPHI	MAGNETI MARELLI
TC2733	ARM1060	TC2950	ARM733	TC3087	ARM214
TC2739	ARM728	TC2951	ARM342	TC3088	ARM215
TC2740	ARM727	TC2952	ARM341	TC3089	ARM236
TC2816	ARM218	TC2970	ARM1063	TC3090	ARM235
TC2817	ARM1010	TC2971	ARM1062	TC3195	ARM186
TC2818	ARM1011	TC2972	ARM230	TC3199	ARM641
TC2821	ARM352	TC2973	ARM229	TC3200	ARM640
TC2822	ARM351	TC2974	ARM232	TC3211	ARM1077
TC2823	ARM353	TC2975	ARM231	TC3212	ARM1076
TC2824	SSP2085	TC2976	ARM349	TC3217	ARM717
TC2825	ARM1065	TC2977	ARM348	TC3221	ARM239
TC2826	ARM1064	TC2978	ARM661	TC3228	SSP2475
TC2833	ARM355	TC2979	ARM660	TC3229	SSP2474
TC2834	ARM354	TC2980	ARM360	TC3230	ARM257
TC2835	SSP1800	TC2981	SSP2510	TC3231	ARM256
TC2836	ARM379	TC2985	ARM931	TC3232	ARM344
TC2837	ARM378	TC2986	ARM930	TC3233	ARM343
TC2843	ARM716	TC3009	ARM238	TC3234	ARM358
TC2844	ARM715	TC3010	ARM237	TC3239	ARM1087
TC2850	SSP1859	TC3011	ARM330	TC3240	ARM1086
TC2851	SSP1847	TC3012	ARM329	TC3241	ARM615
TC2854	ARM478	TC3014	ARM362	TC3242	ARM614
TC2855	ARM477	TC3015	ARM361	TC3243	ARM736
TC2856	ARM610	TC3016	ARM600	TC3244	ARM735
TC2857	ARM609	TC3017	ARM599	TC3253	ARM971
TC2860	SSP1809	TC3020	ARM1043	TC3254	ARM970
TC2861	ARM247	TC3021	ARM1042	TC3255	ARM474
TC2862	ARM246	TC3022	ARM1045	TC3256	ARM473
TC2863	ARM1059	TC3023	ARM1044	TC3257	ARM595
TC2864	ARM1058	TC3024	ARM583	TC3258	ARM338
TC2865	ARM604	TC3025	ARM582	TC3259	ARM340
TC2866	ARM603	TC3028	ARM585	TC3260	ARM339
TC2867	ARM328	TC3053	ARM690	TC3261	ARM1032
TC2868	ARM327	TC3054	ARM689	TC3262	ARM1031
TC2869	ARM347	TC3080	ARM771	TC3263	ARM858
TC2870	ARM346	TC3081	ARM770	TC3264	ARM857
TC2875	ARM860	TC3082	ARM429	TC3265	ARM169
TC2876	ARM859	TC3083	ARM428	TC3268	ARM731
TC290	SSP1204	TC3084	ARM659	TC3269	ARM730
TC2944	ARM988	TC3085	ARM658	TC3270	ARM977
TC2949	ARM734	TC3086	ARM242	TC3271	ARM976



DELPHI	MAGNETI MARELLI	DELPHI	MAGNETI MARELLI	DELPHI	MAGNETI MARELLI
TC3272	ARM819	TC3397	SSP2335	TC3575	ARM312
TC3275	ARM586	TC3404	SSP1873	TC3590	ARM1041
TC3279	ARM1025	TC3405	ARM1039	TC3591	ARM1040
TC3280	ARM1024	TC3406	ARM1091	TC3594	ARM1034
TC3281	ARM732	TC3407	ARM1090	TC3597	ARM200
TC3282	ARM1055	TC3408	SSP2326	TC3598	SSP2027
TC3283	ARM1054	TC3409	SSP2325	TC3599	ARM224
TC3292	ARM622	TC3410	SSP2579	TC3600	ARM223
TC3293	ARM621	TC3411	SSP2397	TC3601	ARM226
TC3299	SSP2342	TC3412	SSP2396	TC3602	ARM225
TC330	ARM149	TC3413	SSP2492	TC3603	ARM188
TC3301	SSP2412	TC3414	SSP2491	TC3604	ARM187
TC3302	SSP2411	TC3417	ARM639	TC3605	ARM345
TC3303	SSP2428	TC3418	ARM638	TC3609	ARM259
TC3304	SSP2427	TC3421	ARM996	TC3610	ARM258
TC3337	ARM191	TC3422	ARM995	TC3611	ARM264
TC3338	ARM190	TC3423	ARM681	TC3612	ARM265
TC3348	SSP2368	TC3424	SSP2184	TC3615	ARM267
TC3349	SSP2367	TC3425	ARM1057	TC3616	ARM266
TC3350	SSP2405	TC3426	ARM919	TC3617	SSP2032
TC3351	SSP2404	TC3427	SSP2235	TC3618	ARM482
TC3352	SSP2248	TC3428	ARM1028	TC3619	ARM481
TC3353	SSP2287	TC3429	ARM1027	TC3621	ARM824
TC3354	SSP2286	TC3430	SSP1818	TC3622	ARM823
TC3356	SSP2260	TC3430	SSP1941	TC3625	ARM645
TC3357	SSP1973	TC3431	SSP2395	TC3626	ARM644
TC3361	SSP2403	TC3432	SSP2394	TC3628	ARM810
TC3364	SSP2528	TC3433	ARM531	TC3629	ARM803
TC3366	SSP1855	TC3434	ARM530	TC3630	ARM802
TC3369	SSP2291	TC3439	ARM561	TC3635	ARM263
TC3374	SSP2081	TC3446	SSP2533	TC3636	ARM262
TC3375	SSP2080	TC3448	ARM694	TC3646	ARM443
TC3376	ARM356	TC3449	ARM693	TC3647	ARM442
TC3377	ARM357	TC3450	ARM933	TC3650	SSP1915
TC3381	SSP2079	TC3451	ARM932	TC3654	SSP2308
TC3383	SSP2196	TC3460	SSP2302	TC3655	SSP1897
TC3384	SSP2297	TC3480	ARM532	TC3656	SSP1826
TC3385	SSP2296	TC3488	ARM337	TC3657	ARM542
TC3392	ARM809	TC3489	ARM577	TC3658	ARM204
TC3393	ARM808	TC3490	ARM576	TC3659	ARM203
TC3396	SSP1876	TC3574	ARM313	TC368	SSP1934

DELPHI	MAGNETI MARELLI	DELPHI	MAGNETI MARELLI	DELPHI	MAGNETI MARELLI
TC3703	ARM683	TC529	SSP2217	TC5631	ARM164
TC3704	ARM682	TC530	SSP1918	TC568	ARM001
TC3705	ARM466	TC5509	SSP2132	TC569	ARM002
TC3706	ARM465	TC5512	SSP2409	TC595	SSP1899
TC3707	ARM923	TC5513	SSP2408	TC595	SSP1900
TC3708	ARM922	TC5518	SSP2151	TC596	SSP1901
TC3717	SSP1898	TC5519	SSP2150	TC610	ARM898
TC3732	ARM601	TC5533	SSP2479	TC611	ARM899
TC3735	SSP2163	TC5534	SSP2480	TC614	SSP2142
TC3738	ARM893	TC554	SSP2137	TC618	SSP2506
TC3739	ARM892	TC5542	ARM795	TC663	SSP1831
TC3740	ARM452	TC5543	ARM796	TC675	SSP2139
TC3741	ARM453	TC5546	ARM459	TC675	SSP2140
TC3779	ARM820	TC5547	SSP2100	TC686	SSP2477
TC3820	ARM617	TC5548	SSP2099	TC686	SSP2478
TC3821	ARM616	TC5549	SSP1923	TC687	SSP1932
TC3822	SSP2275	TC5570	ARM1026	TC694	ARM008
TC3828	ARM649	TC558	SSP2141	TC694	ARM488
TC3829	ARM648	TC5586	SSP2133	TC695	ARM007
TC389	ARM666	TC5588	SSP2266	TC695	ARM487
TC420	SSP1815	TC5589	SSP2203	TC699	ARM417
TC420	SSP1816	TC5590	SSP2171	TC700	ARM416
TC427	ARM041	TC5591	SSP2149	TC704	ARM410
TC428	ARM042	TC5592	SSP2116	TC705	ARM413
TC429	ARM155	TC5593	SSP2117	TC706	ARM412
TC430	ARM156	TC5595	SSP2120	TC720	SSP2178
TC435	SSP1916	TC5596	SSP2204	TC733	ARM848
TC482	SSP2449	TC5597	SSP2205	TC734	ARM847
TC483	SSP2445	TC560	SSP2138	TC750	ARM886
TC485	SSP1817	TC5603	ARM402	TC751	ARM885
TC5012	SSP2179	TC5604	SSP2121	TC753	SSP1986
TC5013	SSP2180	TC5605	ARM508	TC753	SSP1999
TC5016	SSP2393	TC5606	ARM384	TC754	SSP1985
TC5019	ARM370	TC5610	ARM385	TC754	SSP1998
TC502	SSP1773	TC5612	ARM807	TC755	ARM1075
TC5021	ARM369	TC5616	SSP2161	TC756	ARM1074
TC5025	ARM504	TC5617	SSP2156	TC757	SSP1984
TC5028	ARM502	TC5618	SSP2157	TC768	ARM180
TC503	SSP1774	TC562	ARM485	TC769	ARM179
TC5032	ARM260	TC563	ARM486	TC770	ARM178
TC5033	ARM261	TC5630	ARM163	TC771	SSP2005



DELPHI	MAGNETI MARELLI	DELPHI	MAGNETI MARELLI	DELPHI	MAGNETI MARELLI
TC771	SSP2009	TC862	ARM1070	TC968	ARM300
TC772	ARM176	TC863	ARM184	TC969	ARM299
TC773	ARM174	TC870	ARM539	TC970	ARM303
TC778	ARM520	TC871	ARM538	TC971	ARM302
TC780	ARM026	TC874	ARM905	TC972	SSP2066
TC781	ARM025	TC875	ARM904	TC973	SSP2067
TC782	ARM028	TC878	SSP2583	TC974	SSP2043
TC783	ARM027	TC879	SSP2481	TC974	SSP2044
TC786	ARM183	TC880	SSP2495	TC975	SSP2045
TC787	ARM182	TC880	SSP2496	TC975	SSP2046
TC792	ARM870	TC881	ARM277	TC976	SSP2047
TC794	ARM872	TC881	ARM279	TC976	SSP2048
TC795	ARM871	TC881	ARM283	TC977	ARM301
TC796	SSP1928	TC882	ARM274	TC982	ARM840
TC797	ARM838	TC882	ARM276	TC983	ARM839
TC798	ARM837	TC883	ARM963	TC988	ARM975
TC801	ARM172	TC884	ARM962	TC989	ARM974
TC801	ARM173	TC888	SSP1884	TC992	SSP2001
TC802	ARM170	TC915	SSP2499	TC993	SSP2000
TC802	ARM171	TC916	SSP2444	TC999	ARM472
TC814	ARM271	TC928	SSP2431	TD237W	SSP1269
TC815	ARM270	TC928	SSP2590	TD238W	SSP1271
TC824	SSP1778	TC929	SSP2008	TD296W	SSP1232
TC824	SSP1779	TC930	SSP2007	TD297W	SSP1258
TC825	SSP1776	TC931	SSP1879	TD312W	SSP1213
TC825	SSP1777	TC932	SSP2051	TD353W	SSP1248
TC828	SSP1196	TC932	SSP2052	TD354W	SSP1249
TC829	SSP1197	TC937	SSP2446	TD355W	SSP1254
TC830	SSP1917	TC951	ARM185	TD356W	SSP1276
TC831	SSP1904	TC952	SSP1938	TD357W	SSP1275
TC832	SSP1905	TC953	ARM925	TD358W	SSP1214
TC833	SSP1906	TC955	ARM908	TD359W	SSP1215
TC835	SSP1874	TC956	ARM906	TD365W	SSP1229
TC837	SSP1835	TC957	ARM273	TD366W	SSP1231
TC853	ARM836	TC957	ARM291	TD378W	SSP1211
TC854	ARM835	TC958	ARM272	TD381W	SSP1222
TC857	ARM901	TC958	ARM290	TD382W	SSP1216
TC858	ARM900	TC962	SSP2305	TD411W	SSP1253
TC859	ARM024	TC963	SSP1877	TD412W	SSP1239
TC860	ARM023	TC964	ARM675	TD413W	SSP1282
TC861	ARM1071	TC965	ARM674	TD414W	SSP1267

DELPHI	MAGNETI MARELLI	FEBI	MAGNETI MARELLI	FEBI	MAGNETI MARELLI
TD415W	SSP1228	11977	ARM156	29399	SSP1289
TD421W	SSP1281	11978	ARM155	29400	SSP1291
TD422W	SSP1279	12023	SSP1197	29419	SSP1397
TD423W	SSP1278	12024	SSP1196	29420	SSP1396
TD424W	SSP1277	12044	ARM024	31297	ARM092
TD432W	SSP1283	12045	ARM023	31298	ARM091
TD433W	SSP1218	12383	ARM028	32192	SSP1433
TD434W	SSP1217	12384	ARM027	32193	SSP1434
TD507W	SSP1227	12385	ARM026	32194	SSP1317
TD571W	SSP1234	12386	ARM027	32443	ARM090
TD572W	SSP1235	12537	ARM134	32444	ARM089
TD573W	SSP1233	12539	ARM148	34300	SSP1309
TD643W	SSP1242	12540	ARM147	36671	SSP1299
TD644W	SSP1241	12558	ARM007	36672	SSP1298
TD645W	SSP1255	12559	ARM008		
TD646W	SSP1256	12768	SSP1315		
TD706W	SSP1247	14605	SSP1204		
TD707W	SSP1246	18216	SSP1293		
TD833W	SSP1226	18268	SSP1292		
TL411	SSP0051	19403	SSP1341		
TL451	SSP0001	19469	SSP1313		
TL540	SSP0002	19469	SSP1323		
U-D2954	ARM060	21204	SSP1294		
U-D2955	ARM061	21205	SSP1295		
U-D3703	SSP1225	21206	SSP1296		
U-D3753	ARM072	21258	ARM126		
U-D3754	ARM071	21260	ARM125		
U-D4116	SSP1263	22267	SSP1198		
U-D4117	SSP1262	22269	SSP1199		
		22379	SSP1339		
		26645	ARM036		
		26646	ARM035		
		27414	SSP1297		
		28351	SSP1451		
		28359	SSP1392		
		28618	SSP1421		
		28619	SSP1419		
		28638	SSP1343		
		29144	ARM058		
		29145	ARM059		
		29385	SSP1201		



FIRSTLINE	MAGNETI MARELLI	FIRSTLINE	MAGNETI MARELLI	FIRSTLINE	MAGNETI MARELLI
FBJ5076	ARM149	FCA6125	ARM018	FDL6458	SSP1315
FBJ5077	SSP1187	FCA6126	ARM017	FDL6537	SSP1326
FBJ5351	SSP1196	FCA6127	ARM112	FDL6551	SSP1294
FBJ5375	SSP1197	FCA6128	ARM111	FDL6559	SSP1313
FBJ5418	SSP1194	FCA6205	ARM152	FDL6559	SSP1323
FBJ5436	SSP1198	FCA6206	ARM151	FDL6560	SSP1321
FBJ5437	SSP1199	FCA6210	ARM142	FDL6615	SSP1181
FBJ5482	SSP1205	FCA6211	ARM141	FDL6616	SSP1182
FBJ5483	SSP1206	FCA6216	ARM036	FDL6617	ARM122
FBJ5526	SSP1188	FCA6217	ARM035	FDL6618	ARM121
FBJ5542	SSP1201	FCA6219	ARM027	FDL6619	SSP1296
FBJ5551	SSP1185	FCA6220	ARM028	FDL6620	SSP1295
FBJ5591	SSP1202	FCA6221	ARM027	FDL6625	SSP1341
FBJ5592	SSP1203	FCA6234	ARM090	FDL6630	SSP1312
FCA5589	ARM156	FCA6235	ARM089	FDL6722	SSP1339
FCA5591	ARM155	FCA6238	ARM076	FDL6839	SSP1289
FCA5611	ARM042	FCA6239	ARM075	FDL6840	SSP1287
FCA5612	ARM041	FCA6338	ARM118	FDL6840	SSP1291
FCA5660	ARM002	FCA6339	ARM117	FDL6844	SSP1316
FCA5661	ARM001	FCA6559	ARM058	FDL6953	SSP1288
FCA5838	ARM150	FCA6560	ARM059	FDL7097	SSP1306
FCA5864	ARM024	FCA6617	ARM092	FDL7098	SSP1305
FCA5865	ARM023	FCA6618	ARM091	FDL7116	SSP1331
FCA5958	ARM026	FCA6619	ARM094	FDL7119	SSP1301
FCA5959	ARM025	FCA6620	ARM093	FDL7172	SSP1329
FCA5960	ARM028	FCA6643	ARM060	FDL7186	SSP1302
FCA5961	ARM027	FCA6644	ARM061	FDL7195	SSP1304
FCA5986	ARM120	FCA6645	ARM114	FDL7211	SSP1325
FCA5987	ARM119	FCA6646	ARM113	FDL7220	SSP1324
FCA5988	ARM004	FCA6706	ARM072	FDL7229	SSP1334
FCA5989	ARM003	FCA6707	ARM071	FDL7230	SSP1317
FCA6078	ARM020	FCA6728	ARM074	FSK6005	SSP1213
FCA6079	ARM019	FCA6729	ARM073	FSK6097	SSP1238
FCA6097	ARM096	FCA6744	ARM153	FSK6126	SSP1248
FCA6098	ARM095	FCA6751	ARM062	FSK6127	SSP1249
FCA6107	ARM128	FCA6752	ARM063	FSK6128	SSP1254
FCA6108	ARM127	FCA6824	ARM136	FSK6131	SSP1232
FCA6109	ARM126	FCA6825	ARM135	FSK6132	SSP1258
FCA6110	ARM125	FDL6339	SSP1314	FSK6133	SSP1269
FCA6123	ARM140	FDL6454	SSP1292	FSK6135	SSP1276
FCA6124	ARM139	FDL6455	SSP1293	FSK6136	SSP1275

FIRSTLINE	MAGNETI MARELLI	FIRSTLINE	MAGNETI MARELLI	FIRSTLINE	MAGNETI MARELLI
FSK6137	SSP1214	FTR4807	SSP1417	FTR5524	SSP1387
FSK6138	SSP1215	FTR4858	SSP1402	FTR5529	SSP1408
FSK6139	SSP1211	FTR4859	SSP1401		
FSK6140	SSP1222	FTR4860	SSP1347		
FSK6141	SSP1216	FTR4945	SSP1345		
FSK6330	SSP1229	FTR4947	SSP1348		
FSK6330	SSP1243	FTR4957	SSP1405		
FSK6331	SSP1231	FTR4958	SSP1366		
FSK6332	SSP1283	FTR4959	SSP1426		
FSK6333	SSP1218	FTR4960	SSP1376		
FSK6334	SSP1217	FTR5039	SSP1407		
FSK6421	SSP1228	FTR5041	SSP1432		
FSK6422	SSP1282	FTR5042	SSP1384		
FSK6423	SSP1267	FTR5043	SSP1451		
FSK6424	SSP1253	FTR5051	SSP1418		
FSK6425	SSP1239	FTR5052	SSP1425		
FSK6857	SSP1262	FTR5053	SSP1424		
FSK6871	SSP1252	FTR5054	SSP1375		
FSK6872	SSP1251	FTR5055	SSP1413		
FSK6905	SSP1259	FTR5056	SSP1412		
FSK6906	SSP1261	FTR5057	SSP1356		
FTR4128	SSP1411	FTR5058	SSP1439		
FTR4129	SSP1437	FTR5059	SSP1389		
FTR4153	SSP1409	FTR5139	SSP1449		
FTR4154	SSP1361	FTR5140	SSP1448		
FTR4209	SSP1414	FTR5141	SSP1393		
FTR4210	SSP1415	FTR5262	SSP1438		
FTR4223	SSP1379	FTR5355	SSP1395		
FTR4253	SSP1362	FTR5356	SSP1394		
FTR4418	SSP1358	FTR5360	SSP1421		
FTR4467	SSP1399	FTR5361	SSP1419		
FTR4468	SSP1398	FTR5366	SSP1397		
FTR4478	SSP1416	FTR5367	SSP1344		
FTR4718	SSP1346	FTR5367	SSP1396		
FTR4718	SSP1367	FTR5405	SSP1392		
FTR4727	SSP1429	FTR5413	SSP1434		
FTR4728	SSP1431	FTR5414	SSP1433		
FTR4729	SSP1381	FTR5440	SSP1388		
FTR4730	SSP1382	FTR5467	SSP1351		
FTR4735	SSP1364	FTR5491	SSP1352		
FTR4799	SSP1355	FTR5523	SSP1436		



MOOG	MAGNETI MARELLI	MOOG	MAGNETI MARELLI	MOOG	MAGNETI MARELLI
AL-AX-1223	SSP1347	AL-WP-10779	ARM247	AU-AX-12545	SSP0010
AL-AX-1681	SSP1346	AL-WP-10780	ARM246	AU-AX-4428	SSP0009
AL-AX-1699	SSP1345	AL-WP-1436	ARM125	AU-AX-4712	SSP0008
AL-AX-5416	SSP1344	AL-WP-1437	ARM126	AU-AX-5193	SSP0006
AL-ES-10781	SSP1403	AL-WP-7526P	ARM007	AU-BJ-13260	SSP1783
AL-ES-10782	SSP1404	AL-WP-7527P	ARM008	AU-BJ-13655	SSP1784
AL-ES-5417	SSP1397	AMGES2347RL	SSP0551	AU-BJ-5194	SSP1782
AL-ES-5418	SSP1396	AMGES3096L	SSP1441	AU-BJ-5195	SSP1781
AL-LS-0052	SSP1292	AMGES3173RLNC	SSP1407	AU-BJ-7169	SSP1773
AL-LS-0052	SSP2031	AMGES3401RLNC	SSP1405	AU-BJ-7173	SSP1774
AL-LS-10443	SSP1299	AMGES3472	SSP0466	AU-BJ-7440	SSP1780
AL-LS-10444	SSP1298	AMGES3475	SSP0467	AU-DS-8294	ARM185
AL-LS-3296	SSP1296	AMGES3529	SSP0385	AUES10907	SSP0294
AL-LS-3297	SSP1295	AMGES800412	SSP0390	AU-ES-10908	SSP0293
AL-LS-5093	SSP1291	AMGES800413	SSP0391	AU-ES-13647	SSP0301
AL-LS-5094	SSP1289	AMGES80360	SSP0383	AU-ES-13648	SSP0300
AL-LS-5095	SSP1288	AMGES80361	SSP0384	AU-ES-3721	SSP0283
AL-LS-5095	SSP2030	AMGK200254	ARM629	AU-ES-3723	SSP0284
AL-LS-5096	SSP1287	AM-GK-3161T	SSP1861	AU-ES-3839	SSP0292
AL-LS-5096	SSP2029	AMGK3185	SSP1864	AU-ES-3890	SSP2018
AL-SB-0503	SSP1221	AMGK3196	SSP2263	AU-ES-3916	SSP0282
AL-SB-10834	SSP1272	AMGK3197	SSP2266	AU-ES-4918	SSP0299
AL-SB-1720	SSP1228	AMGK3201	SSP2264	AU-ES-5191	SSP0296
AL-SB-2396	SSP1233	AMGK500063	SSP1865	AU-ES-5192	SSP0295
AL-SB-2397	SSP1235	AMGK5342	SSP2097	AU-ES-7377	SSP0289
AL-SB-2398	SSP1234	AMGK7258	SSP1301	AU-ES-7378	SSP0288
AL-SB-3170	SSP1211	AMGK7301	SSP1302	AU-LS-10678	SSP2022
AL-SB-5101	SSP1226	AMGK7305	SSP2269	AU-LS-3717	SSP2015
AL-SB-5104	SSP1274	AMGK7342	SSP2152	AU-LS-3718	SSP2014
AL-SB-5105	SSP1273	AMGK7348	SSP2147	AU-LS-4193	SSP2023
AL-TC-3623	SSP1182	AM-GK-7425	ARM444	AU-LS-4934	SSP2020
AL-TC-3624	SSP1181	AM-GK-7427	ARM445	AU-LS-5421	SSP2019
AL-TC-5097	ARM060	AMGK7470	SSP1304	AU-LS-5475	SSP2021
AL-TC-5098	ARM061	AMGK80255	SSP2454	AU-LS-8044	SSP2024
AL-TC-5099	ARM062	AMGK80256	SSP2453	AU-LS-8241	SSP2013
AL-TC-5100	ARM063	AMGK80470	SSP2462	AU-LS-8242	SSP2012
AL-TC-7983	ARM122	AMGK80604	SSP1862	AU-LS-8295	SSP2001
AL-TC-7984	ARM121	AMGK90313	SSP2540	AU-LS-8296	SSP2000
AL-TC-8079	ARM004	AM-GK-90313	SSP2541	AU-LS-8351	SSP2025
AL-TC-8080	ARM003	AMGK90659	SSP2459	AU-TC-0674P	ARM172
AL-TC-8868P	ARM487	AMGRK620066	ARM630	AU-TC-0678P	ARM170

MOOG	MAGNETI MARELLI	MOOG	MAGNETI MARELLI	MOOG	MAGNETI MARELLI
AU-TC-10622	ARM237	AU-TC-7374	ARM190	BM-BJ-10649	SSP1913
AU-TC-10799	ARM204	AU-TC-7437	ARM193	BM-BJ-12620	SSP1790
AU-TC-10800	ARM203	AU-TC-7437	ARM234	BM-BJ-13445	SSP1915
AU-TC-10835	ARM164	AU-TC-7438	ARM192	BM-BJ-13837	SSP1789
AU-TC-10836	ARM163	AU-TC-7438	ARM233	BM-BJ-15388	SSP1791
AU-TC-12623	ARM206	AU-TC-7881	ARM230	BM-BJ-15455	SSP1785
AU-TC-12624	ARM205	AU-TC-7882	ARM229	BM-BJ-1882	SSP1909
AU-TC-13649	ARM220	AU-TC-7888	ARM1034	BM-BJ-3861	SSP1787
AU-TC-13650	ARM219	AU-TC-7917	ARM186	BM-BJ-5604	SSP1914
AU-TC-13651	ARM221	AU-TC-8081	ARM195	BM-BJ-8826	SSP1788
AU-TC-13652	ARM222	AU-TC-8082	ARM194	BM-DS-4349	SSP0001
AU-TC-13653	ARM224	AU-TC-8239	ARM184	BM-DS-4358	SSP2045
AU-TC-13654	ARM223	AU-TC-8355	ARM241	BM-DS-4358	SSP2046
AU-TC-13665	ARM228	AU-TC-8356	ARM240	BM-DS-4359	SSP2043
AU-TC-13666	ARM227	AU-TC-8869	ARM202	BM-DS-4359	SSP2044
AU-TC-13692	ARM166	AU-TC-8870	ARM201	BM-DS-4364	SSP2066
AU-TC-13693	ARM165	AU-TC-8985	ARM238	BM-DS-4365	SSP2067
AU-TC-14553	ARM226	AU-WP-0154P	ARM162	BM-ES-0490	SSP0314
AU-TC-14554	ARM225	AU-WP-0155P	ARM161	BM-ES-0491	SSP0315
AU-TC-14871	ARM239	AX-0493-F-B	SSP0020	BM-ES-10441	SSP0326
AU-TC-15257	ARM232	AX-1867-BA	SSP0269	BM-ES-10442	SSP0325
AU-TC-15258	ARM231	BJ-1607-BA	SSP2228	BM-ES-10979	SSP0309
AU-TC-4696	ARM217	BJ-1630-BA	SSP1854	BM-ES-10980	SSP0308
AU-TC-4697	ARM216	BJ-1880-BA	SSP1910	BM-ES-13420	SSP0324
AU-TC-4937	ARM213	BJ-1881-BA	SSP1911	BM-ES-13442	SSP0568
AU-TC-4945	ARM212	BM-AX-10978	SSP0018	BM-ES-14879	SSP0303
AU-TC-4946	ARM211	BM-AX-13425	SSP0025	BM-ES-14880	SSP0302
AU-TC-5062	ARM245	BM-AX-14877	SSP0014	BM-ES-14893	SSP0320
AU-TC-5063	ARM244	BM-AX-14892	SSP0024	BM-ES-14894	SSP0319
AU-TC-5064	ARM243	BM-AX-1843	SSP0019	BM-ES-14905	SSP0567
AU-TC-5065	ARM242	BM-AX-1877	SSP0167	BM-ES-14905	SSP0569
AU-TC-5479	ARM218	BM-AX-2436	SSP0021	BM-ES-14906	SSP0566
AU-TC-6997	ARM173	BM-AX-3683	SSP0022	BM-ES-1871	SSP0560
AU-TC-6998	ARM171	BM-AX-3730	SSP0015	BM-ES-1874	SSP0561
AU-TC-7352	ARM197	BM-AX-3731	SSP0016	BM-ES-2113	SSP0321
AU-TC-7353	ARM196	BM-AX-3854	SSP0023	BM-ES-2439	SSP0316
AU-TC-7355	ARM199	BM-AX-5603	SSP0168	BM-ES-3728	SSP0305
AU-TC-7356	ARM198	BM-AX-8789	SSP0026	BM-ES-3729	SSP0304
AU-TC-7369	ARM236	BM-AX-8885	SSP0017	BM-ES-3857	SSP0323
AU-TC-7372	ARM235	BM-BJ-0899	SSP1786	BM-ES-4270	SSP0311
AU-TC-7373	ARM191	BM-BJ-10485	SSP1912	BM-ES-4279	SSP0310



MOOG	MAGNETI MARELLI	MOOG	MAGNETI MARELLI	MOOG	MAGNETI MARELLI
BM-ES-4350	SSP0318	BM-LS-2115	SSP2069	BM-TC-0924	ARM307
BM-ES-4351	SSP0317	BM-LS-2116	SSP2068	BM-TC-0928	ARM314
BM-ES-4374	SSP0312	BM-LS-2117	SSP2070	BM-TC-10460	SSP2085
BM-ES-4375	SSP0313	BM-LS-2434	SSP2061	BM-TC-10464	ARM353
BM-ES-4876	SSP0322	BM-LS-2435	SSP2062	BM-TC-10487	ARM330
BM-ES-5601	SSP0565	BM-LS-3558	SSP2073	BM-TC-10488	ARM329
BM-ES-5602	SSP0564	BM-LS-3675	SSP2057	BM-TC-10489	ARM328
BM-ES-6593	SSP0327	BM-LS-3676	SSP2056	BM-TC-10490	ARM327
BM-ES-6983	SSP0563	BM-LS-3690	SSP2058	BM-TC-10491	ARM359
BM-ES-6986	SSP0562	BM-LS-3725	SSP2034	BM-TC-10913	ARM352
BM-ES-8883	SSP0307	BM-LS-3727	SSP2033	BM-TC-10914	ARM351
BM-ES-8884	SSP0306	BM-LS-3743	SSP2035	BM-TC-10917	ARM347
BM-LS-0420	SSP2042	BM-LS-3859	SSP2072	BM-TC-10918	ARM346
BM-LS-0433	SSP2050	BM-LS-3860	SSP2071	BM-TC-10921	ARM261
BM-LS-0434	SSP2051	BM-LS-3967	SSP2064	BM-TC-10922	ARM260
BM-LS-0434	SSP2052	BM-LS-4195	SSP2054	BM-TC-10923	ARM259
BM-LS-0485	SSP2047	BM-LS-4196	SSP2053	BM-TC-10924	ARM258
BM-LS-0485	SSP2048	BM-LS-4429	SSP2060	BM-TC-10985	ARM263
BM-LS-0485	SSP2049	BM-LS-4430	SSP2059	BM-TC-10986	ARM262
BM-LS-10438	SSP2065	BM-LS-5609	SSP2436	BM-TC-10987	ARM267
BM-LS-10919	SSP2041	BM-LS-7313	SSP2074	BM-TC-10988	ARM266
BM-LS-10920	SSP2040	BM-LS-7314	SSP2078	BM-TC-10989	ARM265
BM-LS-10981	SSP2039	BM-LS-7315	SSP2077	BM-TC-10990	ARM264
BM-LS-10982	SSP2038	BM-LS-7343	SSP2076	BM-TC-12649	ARM349
BM-LS-13423	SSP2081	BM-LS-7344	SSP2075	BM-TC-12650	ARM348
BM-LS-13424	SSP2080	BM-LS-8768	SSP2086	BM-TC-13339	ARM342
BM-LS-13449	SSP2441	BM-LS-8769	SSP2087	BM-TC-13340	ARM341
BM-LS-13450	SSP2440	BM-LS-8774	SSP2063	BM-TC-13421	ARM344
BM-LS-13493	SSP2055	BM-LS-8806	SSP2083	BM-TC-13422	ARM343
BM-LS-13597	SSP2439	BM-LS-8845	SSP2084	BM-TC-13427	ARM350
BM-LS-13598	SSP2438	BM-LS-8846	SSP2082	BM-TC-13539	ARM355
BM-LS-13956	SSP2079	BM-TC-0448	ARM272	BM-TC-13540	ARM354
BM-LS-14585	SSP2037	BM-TC-0449	ARM273	BM-TC-13687	ARM360
BM-LS-14586	SSP2036	BM-TC-0476	ARM268	BM-TC-13807	ARM357
BM-LS-14876	SSP2032	BM-TC-0477	ARM269	BM-TC-13808	ARM356
BM-LS-14876	SSP2442	BM-TC-0486	ARM301	BM-TC-14531	ARM257
BM-LS-14888	SSP2443	BM-TC-0897	ARM317	BM-TC-14532	ARM256
BM-LS-1886	SSP2433	BM-TC-0898	ARM318	BM-TC-14635	ARM338
BM-LS-1887	SSP2434	BM-TC-0918	ARM315	BM-TC-14660	ARM358
BM-LS-1887	SSP2437	BM-TC-0920	ARM316	BM-TC-14899	ARM313
BM-LS-1890	SSP2432	BM-TC-0923	ARM306	BM-TC-14900	ARM312

MOOG	MAGNETI MARELLI	MOOG	MAGNETI MARELLI	MOOG	MAGNETI MARELLI
BM-TC-14987	ARM362	BM-TC-5632	ARM287	CH-TC-10826	ARM442
BM-TC-14988	ARM361	BM-TC-7389	ARM334	CH-TC-13389	ARM625
BM-TC-14992	ARM345	BM-TC-7390	ARM333	CH-TC-13390	ARM626
BM-TC-16819	ARM326	BMTC7398	ARM332	CH-TC-13748	ARM459
BM-TC-16820	ARM325	BM-TC-7399	ARM331	CH-TC-14089	ARM464
BM-TC-1752	ARM305	BM-TC-8843	ARM336	CH-TC-14090	ARM463
BM-TC-2118	ARM321	BM-TC-8844	ARM335	CH-TC-14940	ARM460
BM-TC-2122	ARM320	BM-W-4738	ARM278	CH-WP-14085	ARM462
BM-TC-2125	ARM319	BM-W-4739	ARM275	CH-WP-14086	ARM461
BM-TC-3152	ARM304	BM-WP-0421	ARM274	CH-WP-2449	ARM142
BM-TC-3684	ARM298	BM-WP-0422	ARM277	CH-WP-2450	ARM141
BM-TC-3685	ARM297	BM-WP-2430	ARM309	CH-WP-2458	ARM152
BM-TC-3686	ARM296	BM-WP-2431	ARM308	CH-WP-2459	ARM151
BM-TC-3687	ARM295	BM-WP-2437	ARM288	CI-AX-0863	SSP0059
BM-TC-3691	ARM292	BM-WP-2438	ARM289	CI-AX-0863	SSP2511
BM-TC-3692	ARM294	BM-WP-4738	ARM279	CI-AX-13643	SSP0054
BM-TC-3693	ARM293	BM-WP-4739	ARM276	CI-AX-14830	SSP0053
BM-TC-3732	ARM252	CH-AX-10100	SSP1352	CI-AX-1707	SSP0055
BM-TC-3733	ARM251	CH-AX-13885	SSP0067	CI-AX-2467	SSP1384
BM-TC-3738	ARM250	CH-BJ-10677	SSP1821	CI-AX-3361	SSP0050
BM-TC-3739	ARM249	CH-BJ-14087	SSP1824	CI-AX-3991	SSP0213
BM-TC-3740	ARM253	CH-ES-10748	SSP0382	CI-AX-5060	SSP0205
BM-TC-3741	ARM254	CH-ES-10822	SSP1408	CI-AX-5169	SSP1387
BM-TC-3742	ARM255	CH-ES-13883	SSP0393	CI-AX-5690	SSP0052
BM-TC-3855	ARM324	CH-ES-13884	SSP0392	CI-AX-8762	SSP0060
BM-TC-3856	ARM323	CH-LS-10132	SSP1305	CI-AX-8851	SSP0058
BM-TC-3864	ARM291	CH-LS-10133	SSP1306	CI-BJ-0523	SSP1938
BM-TC-3865	ARM290	CH-LS-10521	SSP1334	CI-BJ-0868	SSP1819
BM-TC-3936	ARM322	CH-LS-10579	SSP2148	CI-BJ-10658	SSP1903
BM-TC-4317	SSP1934	CH-LS-13684	SSP2268	CI-BJ-13988	SSP1818
BM-TC-4356	ARM270	CH-LS-13707	SSP2265	CI-BJ-3355	SSP1815
BM-TC-4357	ARM271	CH-LS-13872	SSP2155	CI-BJ-3355	SSP1816
BM-TC-4360	ARM302	CH-LS-13881	SSP2159	CI-BJ-8795	SSP1820
BM-TC-4361	ARM303	CH-LS-13882	SSP2158	CI-DS-3348	SSP2141
BM-TC-4362	ARM300	CH-LS-13909	SSP2267	CI-ES-0864	SSP0372
BM-TC-4363	ARM299	CH-LS-14095	SSP2160	CI-ES-0865	SSP0373
BM-TC-5164	ARM282	CH-SB-2448	SSP1264	CI-ES-0930	SSP0376
BM-TC-5164	ARM283	CH-SB-2452	SSP1266	CI-ES-0931	SSP0377
BM-TC-5165	ARM280	CH-TC-10134	ARM465	CI-ES-13989	SSP0628
BM-TC-5165	ARM281	CH-TC-10135	ARM466	CI-ES-13990	SSP0627
BM-TC-5631	ARM286	CH-TC-10825	ARM443	CI-ES-14931	SSP0616



MOOG	MAGNETI MARELLI	MOOG	MAGNETI MARELLI	MOOG	MAGNETI MARELLI
CI-ES-14932	SSP0615	CI-TC-15563	ARM819	DE-BJ-5422	SSP1795
CI-ES-3964	SSP0613	CI-TC-2055	ARM424	DE-BJ-8901	SSP1794
CI-ES-3965	SSP0614	CI-TC-2056	ARM425	DE-ES-10621	SSP0360
CI-ES-5119	SSP1434	CI-TC-5121	ARM092	DE-ES-13690	SSP0340
CI-ES-5120	SSP1433	CI-TC-5122	ARM091	DE-ES-13821	SSP0341
CI-ES-7237	SSP0371	CI-TC-5123	ARM094	DE-ES-15607	SSP0330
CI-ES-7238	SSP0370	CI-TC-5124	ARM093	DE-ES-2471	SSP0349
CI-ES-7316	SSP1436	CI-TC-5166	ARM927	DE-ES-2472	SSP0348
CI-ES-8328	SSP0374	CI-TC-5167	ARM926	DE-ES-2475	SSP0336
CI-ES-8329	SSP0375	CI-TC-7298	ARM074	DE-ES-3894	SSP0335
CI-ES-8465	SSP0379	CI-TC-7299	ARM073	DE-ES-3968	SSP0343
CI-ES-8466	SSP0378	CI-WP-0159	ARM410	DE-ES-3969	SSP0342
CI-ES-8975	SSP1423	CI-WP-0381	ARM411	DE-ES-7242	SSP0328
CI-ES-8976	SSP1422	CI-WP-0600P	ARM924	DE-ES-7242	SSP0329
CI-LS-14683	SSP2143	CI-WP-0713	ARM415	DE-LS-10435	SSP2095
CI-LS-14683	SSP2145	CI-WP-0714	ARM414	DE-LS-10623	SSP2130
CI-LS-1727	SSP0051	CI-WP-12503	ARM421	DE-LS-13820	SSP2107
CI-LS-2468	SSP1341	CI-WP-12504	ARM420	DE-LS-2299	SSP2153
CI-LS-3267	SSP1327	CI-WP-13401	ARM413	DE-LS-3896	SSP2108
CI-LS-4959	SSP2548	CI-WP-13402	ARM412	DE-LS-3897	SSP2109
CI-LS-7236	SSP2501	CI-WP-13639	ARM409	DE-LS-3971	SSP2110
CI-LS-7297	SSP1317	CI-WP-13640	ARM408	DE-LS-5135	SSP2093
CI-LS-7297	SSP2167	CI-WP-13991	ARM931	DE-LS-5136	SSP2094
CI-LS-7321	SSP1328	CI-WP-13992	ARM930	DE-TC-0125	ARM877
CI-LS-7322	SSP1329	CI-WP-2464	ARM036	DE-WP-10653	ARM397
CI-LS-8417	SSP2144	CI-WP-2465	ARM035	DE-WP-10654	ARM396
CI-RK-3079	SSP1219	CI-WP-3876	ARM494	DE-WP-10823	ARM365
CI-SB-5633	SSP1249	CI-WP-3877	ARM493	DE-WP-10824	ARM366
CI-SB-7317	SSP1223	CI-WP-8760	ARM422	DE-WP-13243	ARM383
CI-TC-0160	ARM417	CI-WP-8761	ARM423	DE-WP-13244	ARM382
CI-TC-0161	ARM416	DE-AX-10492	SSP0045	DE-WP-13823	ARM379
CI-TC-12665	ARM429	DE-AX-13822	SSP0033	DE-WP-13824	ARM378
CI-TC-12666	ARM428	DE-AX-1821	SSP0034	DE-WP-2477	ARM372
CI-TC-13349	ARM433	DE-AX-2470	SSP0038	DE-WP-2478	ARM371
CI-TC-13350	ARM432	DE-AX-2474	SSP0029	DE-WP-4419	ARM381
CI-TC-14827	ARM419	DE-AX-8886	SSP0027	DE-WP-4420	ARM380
CI-TC-14828	ARM418	DE-BJ-10655	SSP1809	DE-WP-5637	ARM389
CI-TC-14933	ARM933	DE-BJ-13825	SSP1800	DE-WP-5638	ARM388
CI-TC-14934	ARM932	DE-BJ-2469	SSP1798	DI-ES-2243	SSP0676
CI-TC-15533	ARM427	DE-BJ-2473	SSP1804	E-AX-0862	SSP0216
CI-TC-15534	ARM426	DE-BJ-3970	SSP1801	E-AX-1570	SSP0207

MOOG	MAGNETI MARELLI	MOOG	MAGNETI MARELLI	MOOG	MAGNETI MARELLI
E-ES-1668	SSP0630	FD-ES-2050	SSP0435	FD-LS-5111	SSP2193
ES-1528-F-B	SSP0495	FD-ES-2261	SSP0412	FD-LS-5444	ARM590
ES-1529-F-B	SSP0496	FD-ES-2262	SSP0411	FD-LS-5445	ARM591
ES-1656-BA	SSP0629	FD-ES-3665	SSP0422	FD-LS-5446	ARM589
ES3044RL	SSP0550	FD-ES-3891	SSP0421	FD-LS-5613	SSP2211
ES800349	SSP0473	FD-ES-4125	SSP0413	FD-LS-5699	SSP2225
ES800350	SSP0474	FD-ES-5108	SSP0439	FD-LS-5736	SSP2209
FD-AX-0270	SSP0077	FD-ES-5109	SSP0438	FD-LS-7924	SSP2215
FD-AX-0470	SSP0097	FD-ES-7386	SSP0410	FD-LS-8093	SSP2175
FD-AX-12605	SSP0085	FD-ES-7387	SSP0409	FD-TC-0951	ARM535
FD-AX-13617	SSP0096	FD-ES-8337	SSP0429	FD-TC-0952	ARM536
FD-AX-1537	SSP0083	FD-ES-8338	SSP0428	FD-TC-10175	ARM558
FD-AX-2258	SSP0076	FD-ES-8999	SSP0424	FD-TC-12515	ARM595
FD-AX-2526	SSP0095	FD-ES-9000	SSP0423	FD-TC-12698	ARM585
FD-AX-2527	SSP0094	FD-LS-0090	SSP2178	FD-TC-13347	ARM542
FD-AX-3957	SSP0084	FD-LS-0122	SSP2186	FD-TC-13515	ARM561
FD-AX-4153	SSP0072	FD-LS-0122	SSP2187	FD-TC-13605	ARM547
FD-AX-4851	SSP0086	FD-LS-0469	SSP2219	FD-TC-13606	ARM546
FD-AX-5110	SSP0098	FD-LS-0469	SSP2220	FD-TC-13762	ARM545
FD-AX-7388	SSP0075	FD-LS-0808	SSP2222	FD-TC-14098	ARM557
FD-AX-8855	SSP0092	FD-LS-0808	SSP2223	FD-TC-15226	ARM548
FD-BJ-0425	SSP1835	FD-LS-0950	SSP2188	FD-TC-15323	ARM532
FD-BJ-0474	SSP1850	FD-LS-0950	SSP2189	FD-TC-15331	ARM598
FD-BJ-0474	SSP1851	FD-LS-10437	SSP2196	FD-TC-15369	ARM586
FD-BJ-0814	SSP1846	FD-LS-10512	SSP2206	FD-TC-5741	ARM584
FD-BJ-0814	SSP1849	FDLS10901	SSP2195	FD-TC-5742	ARM594
FD-BJ-12509	SSP1845	FD-LS-10901	SSP2596	FD-TC-7260P	ARM537
FD-BJ-12510	SSP1844	FD-LS-13618	SSP2216	FD-TC-8849	ARM531
FD-BJ-2260	SSP1833	FD-LS-14891	SSP2174	FD-TC-8850	ARM530
FD-BJ-4134	SSP1831	FD-LS-14945	SSP2184	FD-WP-0162	ARM528
FD-BJ-7296	SSP1852	FD-LS-15239	SSP2183	FD-WP-0163	ARM527
FD-BJ-8090	SSP1832	FD-LS-2049	SSP2213	FD-WP-0403	ARM538
FD-BJ-8340	SSP1841	FD-LS-2049	SSP2214	FD-WP-0404	ARM539
FD-BJ-8341	SSP1842	FD-LS-2051	SSP2212	FD-WP-0495	ARM517
FD-BJ-8945	SSP1847	FD-LS-2259	SSP2176	FD-WP-0496	ARM518
FD-ES-0841	SSP0437	FD-LS-3274	SSP2221	FD-WP-0715	ARM588
FD-ES-0957	SSP0434	FD-LS-3286	SSP2224	FD-WP-0716	ARM587
FD-ES-14911	SSP0416	FD-LS-3662	SSP2192	FD-WP-0721	ARM525
FD-ES-14912	SSP0415	FD-LS-3667	SSP2190	FD-WP-0722	ARM526
FD-ES-1535	SSP0419	FD-LS-4064	SSP2460	FD-WP-0738	ARM513
FD-ES-1536	SSP0420	FD-LS-4114	SSP2217	FD-WP-0739	ARM514



MOOG	MAGNETI MARELLI	MOOG	MAGNETI MARELLI	MOOG	MAGNETI MARELLI
FD-WP-0843	ARM519	FI-BJ-0049	SSP1189	FI-LS-5159	SSP1343
FD-WP-0844	ARM520	FI-BJ-0513	SSP1199	FI-LS-8086	SSP1325
FD-WP-12507	ARM550	FI-BJ-0936	SSP1193	FI-LS-8783	SSP1322
FD-WP-12508	ARM549	FI-BJ-15342	SSP1827	FI-LS-8794	SSP1309
FD-WP-13615	ARM552	FI-BJ-15404	SSP1826	FI-SB-2207	SSP1214
FD-WP-13616	ARM551	FI-BJ-4072	SSP1204	FI-SB-2520	SSP1281
FD-WP-15249	ARM577	FI-BJ-4174	SSP1194	FI-SB-2521	SSP1279
FD-WP-15250	ARM576	FI-BJ-4958	SSP1201	FI-SB-5203	SSP1252
FD-WP-15311	ARM563	FI-BJ-7510	SSP1187	FI-SB-5204	SSP1251
FD-WP-15312	ARM562	FI-BJ-7530	SSP1196	FI-SB-5697	SSP1245
FD-WP-15738	ARM582	FI-BJ-7531	SSP1197	FI-SB-5698	SSP1212
FD-WP-15751	ARM583	FI-ES-0241	SSP1425	FI-SB-8357	SSP1195
FD-WP-2047	ARM580	FI-ES-0242	SSP1424	FI-TC-14075	ARM478
FD-WP-2048	ARM581	FI-ES-0937	SSP1426	FI-TC-14076	ARM477
FD-WP-2524	ARM574	FI-ES-12625	SSP0399	FI-TC-15437	ARM407
FD-WP-2525	ARM575	FI-ES-14639	SSP0401	FI-TC-15438	ARM406
FD-WP-4139	ARM523	FI-ES-14640	SSP0400	FI-TC-1963	ARM089
FD-WP-4140	ARM524	FI-ES-15163	SSP0403	FI-TC-1964	ARM090
FD-WP-5112	ARM597	FI-ES-15164	SSP0402	FI-TC-4666	ARM472
FD-WP-5113	ARM596	FI-ES-3525	SSP1418	FI-TC-4673	ARM149
FD-WP-7997	ARM512	FI-ES-4070	SSP1962	FI-TC-4674	ARM150
FD-WP-7998	ARM511	FI-ES-4079	SSP1409	FI-TC-7412	ARM072
FD-WP-8949	ARM560	FI-ES-4082	SSP1437	FI-TC-7412	ARM476
FD-WP-8950	ARM559	FI-ES-4085	SSP1411	FI-TC-7413	ARM071
FI-AX-0086	SSP1364	FI-ES-4675	SSP1415	FI-TC-7413	ARM475
FI-AX-10827	SSP1378	FI-ES-4676	SSP1414	FI-TC-7522	ARM001
FI-AX-10883	SSP1394	FI-ES-4684	SSP1416	FI-TC-7523	ARM002
FI-AX-10934	SSP0063	FI-ES-4970	SSP1438	FI-TC-8874	ARM017
FI-AX-1751	SSP1371	FI-ES-5155	SSP1452	FI-WP-0108	ARM025
FI-AX-1839	SSP1366	FI-LS-0048	SSP1315	FI-WP-0109	ARM026
FI-AX-2503	SSP1376	FI-LS-0048	SSP2165	FI-WP-0110	ARM027
FI-AX-2504	SSP1417	FI-LS-0441	SSP1314	FI-WP-0111	ARM028
FI-AX-2518	SSP1372	FI-LS-10828	SSP1324	FI-WP-0118	ARM491
FI-AX-3826	SSP1356	FI-LS-14979	SSP2163	FI-WP-0239	ARM148
FI-AX-3853	SSP1355	FI-LS-2111	SSP1321	FI-WP-0239	ARM490
FI-AX-4080	SSP0071	FI-LS-2371	SSP1313	FI-WP-0240	ARM147
FI-AX-4198	SSP1373	FI-LS-2371	SSP1323	FI-WP-0240	ARM489
FI-AX-5092	SSP1389	FI-LS-2371	SSP2168	FI-WP-0939	ARM018
FI-AX-5156	SSP1395	FI-LS-3830	SSP1312	FI-WP-13611	ARM474
FI-AX-7508	SSP1358	FI-LS-3830	SSP2162	FI-WP-13612	ARM473
FI-AX-7528	SSP1382	FI-LS-4548	SSP1297	FI-WP-1462	ARM019

MOOG	MAGNETI MARELLI	MOOG	MAGNETI MARELLI	MOOG	MAGNETI MARELLI
FI-WP-1463	ARM020	HY-BJ-10813	SSP1853	HY-LS-2625	SSP2252
FI-WP-15343	ARM482	HY-BJ-13247	SSP1859	HY-LS-2626	SSP2251
FI-WP-15344	ARM481	HY-BJ-13369	SSP1856	HY-LS-3940	SSP2236
FI-WP-15401	ARM484	HY-BJ-2629	SSP1860	HY-LS-3941	SSP2237
FI-WP-15402	ARM483	HY-BJ-3977	SSP1870	HY-LS-3999	SSP2230
FI-WP-2109	ARM136	HY-BJ-4749	SSP1857	HY-LS-4688	SSP2253
FI-WP-2110	ARM135	HY-ES-0172	SSP0443	HY-LS-4689	SSP2254
FI-WP-3840	ARM492	HY-ES-10811	SSP0441	HY-LS-4942	SSP2257
FI-WP-3958	ARM059	HY-ES-10812	SSP0440	HY-LS-4943	SSP2255
FI-WP-3959	ARM058	HY-ES-13303	SSP0455	HY-LS-4944	SSP2259
FI-WP-4172	ARM112	HY-ES-13304	SSP0454	HY-LS-7081	SSP2239
FI-WP-4173	ARM111	HY-ES-14565	SSP0465	HY-LS-7082	SSP2238
FI-WP-4966	ARM498	HY-ES-14566	SSP0464	HY-LS-7936	SSP2240
FI-WP-4967	ARM497	HY-ES-14981	SSP0460	HY-LS-7937	SSP2241
FI-WP-4969	ARM499	HY-ES-14982	SSP0459	HY-LS-8907	SSP2232
FI-WP-5157	ARM996	HY-ES-1657	SSP0559	HY-LS-8908	SSP2231
FI-WP-5158	ARM995	HY-ES-1906	SSP0461	HY-LS-8911	SSP2234
FI-WP-5201	ARM114	HY-ES-3886	SSP0448	HY-LS-8912	SSP2233
FI-WP-5202	ARM113	HY-ES-3887	SSP0449	HY-TC-13757	ARM618
FI-WP-5692	ARM154	HY-ES-4938	SSP0463	HY-TC-14682	ARM613
FI-WP-5693	ARM153	HY-ES-4939	SSP0462	HY-TC-14737	ARM602
FI-WP-7501	ARM155	HY-ES-7092	SSP0453	HY-TC-14820	ARM601
FI-WP-7502	ARM156	HY-ES-7093	SSP0452	HY-WP-10433	ARM606
FI-WP-7503P	ARM041	HY-ES-8855	SSP0456	HY-WP-10434	ARM605
FI-WP-7504P	ARM042	HY-ES-8899	SSP0445	HY-WP-10567	ARM612
FI-WP-7524	ARM485	HY-ES-8900	SSP0444	HY-WP-10568	ARM611
FI-WP-7525	ARM486	HY-LS-10519	SSP2227	HY-WP-13301	ARM600
FI-WP-8475	ARM116	HY-LS-10809	SSP2226	HY-WP-13302	ARM599
FI-WP-8476	ARM115	HY-LS-13297	SSP2235	HY-WP-13637	ARM610
HY-AX-10810	SSP0099	HY-LS-13297	SSP2285	HY-WP-13638	ARM609
HY-AX-13298	SSP0107	HY-LS-13305	SSP2245	HY-WP-14701	ARM624
HY-AX-13756	SSP0109	HY-LS-13467	SSP2247	HY-WP-14702	ARM623
HY-AX-14084	SSP0113	HY-LS-13468	SSP2246	HY-WP-15253	ARM647
HY-AX-14980	SSP0110	HY-LS-13752	SSP2248	HY-WP-15254	ARM646
HY-AX-1818	SSP0111	HY-LS-13755	SSP2249	HY-WP-2612	ARM620
HY-AX-2432	SSP0112	HY-LS-14083	SSP2260	HY-WP-2614	ARM619
HY-AX-3892	SSP0103	HY-LS-14783	SSP2262	HY-WP-4940	ARM622
HY-AX-8358	SSP0108	HY-LS-14784	SSP2261	HY-WP-4941	ARM621
HY-AX-8894	SSP0104	HY-LS-14801	SSP2284	HY-WP-7083	ARM604
HY-AX-8898	SSP0102	HY-LS-14946	SSP2250	HY-WP-7084	ARM603
HY-BJ-10432	SSP1855	HY-LS-1833	SSP2229	IV-BJ-12615	SSP1828



MOOG	MAGNETI MARELLI	MOOG	MAGNETI MARELLI	MOOG	MAGNETI MARELLI
KI-AX-10615	SSP0105	KI-WP-13771	ARM645	MD-ES-15088	SSP0539
KI-AX-10697	SSP0117	KI-WP-13772	ARM644	MD-ES-2361	SSP0544
KI-AX-10698	SSP0118	KI-WP-13849	ARM639	MD-ES-2362	SSP0543
KI-AX-13861	SSP0124	KI-WP-13850	ARM638	MD-ES-3926	SSP0468
KI-AX-13985	SSP0101	KI-WP-5146	ARM637	MD-ES-3934	SSP0469
KI-AX-2331	SSP0120	KI-WP-5147	ARM636	MD-ES-4717	SSP0538
KI-AX-4009	SSP0116	KI-WP-7095	ARM608	MD-ES-4718	SSP0537
KI-AX-4199	SSP0123	KI-WP-7096	ARM607	MD-LS-10096	SSP2389
KI-AX-4432	SSP0115	KI-WP-8423	ARM641	MD-LS-10660	SSP2393
KI-AX-7089	SSP0106	KI-WP-8424	ARM640	MD-LS-1117	SSP2391
KI-BJ-12659	SSP1873	LN-AX-4758	SSP1386	MD-LS-1127	SSP2390
KI-BJ-13409	SSP1872	LN-ES-4771	SSP1435	MD-LS-13870	SSP2406
KI-BJ-4757	SSP1869	LN-LS-2678	SSP1319	MD-LS-13897	SSP2397
KI-BJ-7094	SSP1858	LN-TC-4800	ARM076	MD-LS-14572	SSP2396
KI-ES-13371	SSP0477	LN-TC-4835	ARM075	MD-LS-14985	SSP2392
KI-ES-13372	SSP0476	LN-WP-0272	ARM488	MD-LS-15085	SSP2395
KI-ES-13939	SSP0447	LN-WP-13619	ARM471	MD-LS-15086	SSP2394
KI-ES-13940	SSP0446	LN-WP-13620	ARM470	MD-LS-3895	SSP2277
KI-ES-4200	SSP0472	LS-1168-BA	SSP2446	MD-LS-3942	SSP2274
KI-ES-8766	SSP0450	LS-1654-BA	SSP2303	MD-LS-3981	SSP2271
KI-ES-8767	SSP0451	M-852	SSP1891	MD-LS-4026	SSP2401
KI-LS-10111	SSP2272	MA-336A	SSP1896	MD-LS-4395	SSP2402
KI-LS-10112	SSP2273	MD-AX-0010	SSP0153	MD-LS-4396	SSP2400
KI-LS-10613	SSP2287	MD-AX-10524	SSP0152	MD-LS-9006	SSP2403
KI-LS-10614	SSP2286	MD-AX-13906	SSP0155	MD-LS-9089	SSP2405
KI-LS-13256	SSP2270	MD-AX-14929	SSP0149	MD-LS-9090	SSP2404
KI-LS-2674	SSP2399	MD-AX-15089	SSP0151	MD-TC-14078	ARM807
KI-LS-2676	SSP2398	MD-AX-3888	SSP0150	MD-TC15090	ARM797
KI-LS-4422	SSP2279	MD-AX-8887	SSP0154	MD-TC-15235	ARM803
KI-LS-4423	SSP2278	MD-BJ-13931	SSP1897	MD-TC-15236	ARM802
KI-LS-4694	SSP2281	MD-BJ-2291	SSP1898	MD-TC-15332	ARM502
KI-LS-4695	SSP2280	MD-BJ-3935	SSP1866	MD-TC-15639	ARM799
KI-LS-4883	SSP2283	MD-BJ-4869	SSP1895	MD-TC-15640	ARM798
KI-LS-4884	SSP2282	MD-ES-10525	SSP0546	MD-TC-15730	ARM529
KI-LS-7090	SSP2242	MD-ES-10526	SSP0545	MD-WP12573	ARM808
KI-LS-7099	SSP2244	MD-ES-10527	SSP0542	MD-WP-12573	ARM809
KI-TC-12683	ARM649	MD-ES-10528	SSP0541	MD-WP-12579	ARM811
KI-TC-12684	ARM648	MD-ES-10685	SSP0536	MD-WP-12580	ARM810
KI-TC-15263	ARM651	MD-ES-10686	SSP0535	MD-WP-13901	ARM813
KI-TC-15264	ARM650	MD-ES-13871	SSP0547	MD-WP-13902	ARM812
KI-TC-4418	ARM635	MD-ES-15087	SSP0540	MD-WP-15091	ARM801

MOOG	MAGNETI MARELLI	MOOG	MAGNETI MARELLI	MOOG	MAGNETI MARELLI
MD-WP-15092	ARM800	ME-BJ-1531	SSP1877	ME-ES-4393	SSP0512
MD-WP-15755	ARM796	ME-BJ-15457	SSP1885	ME-ES-4394	SSP0511
MD-WP-15756	ARM795	ME-BJ-2075	SSP1878	ME-ES-4953	SSP0516
MD-WP-2356	ARM510	ME-BJ-2725	SSP1892	ME-ES-5172	SSP0532
MD-WP-2357	ARM509	ME-BJ-2749	SSP1883	ME-ES-5593	SSP0528
MD-WP-2358	ARM805	ME-BJ-4392	SSP1882	ME-ES-5594	SSP0527
MD-WP-2359	ARM804	ME-BJ-4952	SSP1886	ME-ES-5599	SSP0526
MD-WP-2360	ARM806	ME-BJ-5597	SSP1889	ME-ES-5600	SSP0525
MD-WP-3962	ARM631	ME-BJ-5598	SSP1890	ME-ES-5648	SSP0486
MD-WP-3963	ARM632	ME-BJ-6331	SSP1874	ME-ES-5648	SSP0518
MD-WP-4426	ARM794	ME-BJ-6345	SSP1884	ME-ES-5649	SSP0485
MD-WP-4427	ARM793	ME-BJ-8111	SSP1893	ME-ES-5649	SSP0517
ME-AX-0979	SSP0143	ME-BJ-8111	SSP1894	ME-ES-6330	SSP0480
ME-AX-10146	SSP0127	ME-DS-0793	ARM667	ME-ES-6339	SSP0482
ME-AX-13322	SSP0132	ME-DS-12601	SSP0002	ME-ES-6340	SSP0481
ME-AX-13694	SSP0148	ME-DS-6300	ARM666	ME-ES-6342	SSP0505
ME-AX-13792	SSP0129	ME-ES-0977	SSP0523	ME-ES-6344	SSP0515
ME-AX-13817	SSP0135	ME-ES-0978	SSP0524	ME-ES-7770	SSP0483
ME-AX-14590	SSP0142	ME-ES-10147	SSP0490	ME-ES-7771	SSP0484
ME-AX-15185	SSP0134	ME-ES-10148	SSP0489	ME-ES-9091	SSP0494
ME-AX-1530	SSP0130	ME-ES-10705	SSP0504	ME-ES-9092	SSP0493
ME-AX-15301	SSP0141	ME-ES-10706	SSP0503	ME-LS-0435	SSP2327
ME-AX-15337	SSP0128	ME-ES-13435	SSP0502	ME-LS-0436	SSP2328
ME-AX-2073	SSP0131	ME-ES-13436	SSP0501	ME-LS-0489	SSP2305
ME-AX-2266	SSP0145	ME-ES-13913	SSP0514	ME-LS-0489	SSP2306
ME-AX-2714	SSP2304	ME-ES-13914	SSP0513	ME-LS-0725	SSP2289
ME-AX-2754	SSP0136	ME-ES-13977	SSP0508	ME-LS-0726	SSP2290
ME-AX-4190	SSP0137	ME-ES-15111	SSP0522	ME-LS-10471	SSP2293
ME-AX-5173	SSP0146	ME-ES-15112	SSP0521	ME-LS-10472	SSP2292
ME-AX-5596	SSP0144	ME-ES-15171	SSP0520	ME-LS-10529	SSP2297
ME-AX-5674	SSP0140	ME-ES-15172	SSP0519	ME-LS-10530	SSP2296
ME-AX-6338	SSP0125	ME-ES-15183	SSP0507	ME-LS-12538	SSP2335
ME-AX-6341	SSP0133	ME-ES-15184	SSP0506	ME-LS-13437	SSP2298
ME-AX-6343	SSP0138	ME-ES-2072	SSP0498	ME-LS-13437	SSP2319
ME-AX-7294	SSP0126	ME-ES-2074	SSP0497	ME-LS-13438	SSP2318
ME-AX-7769	SSP0147	ME-ES-2079	SSP0558	ME-LS-13695	SSP2380
ME-BJ-0366	SSP1879	ME-ES-2728	SSP0531	ME-LS-13696	SSP2379
ME-BJ-0980	SSP1887	ME-ES-2729	SSP0530	ME-LS-13911	SSP2295
ME-BJ-0981	SSP1888	ME-ES-2750	SSP0510	ME-LS-13912	SSP2294
ME-BJ-10684	SSP1876	ME-ES-2751	SSP0509	ME-LS-13975	SSP2326
ME-BJ-13818	SSP1881	ME-ES-4181	SSP0529	ME-LS-13976	SSP2325



MOOG	MAGNETI MARELLI	MOOG	MAGNETI MARELLI	MOOG	MAGNETI MARELLI
ME-LS-14645	SSP2360	ME-LS-5170	SSP2378	ME-TC-13773	ARM663
ME-LS-14646	SSP2359	ME-LS-5171	SSP2377	ME-TC-13797	ARM680
ME-LS-14771	SSP2382	ME-LS-5595	SSP2366	ME-TC-13803	ARM781
ME-LS-14772	SSP2381	ME-LS-5618	SSP2345	ME-TC-13804	ARM780
ME-LS-15113	SSP2358	ME-LS-5628	SSP2352	ME-TC-13805	ARM681
ME-LS-15114	SSP2357	ME-LS-5629	SSP2351	ME-TC-13809	ARM769
ME-LS-15128	SSP2302	ME-LS-5678	SSP2312	ME-TC-13810	ARM768
ME-LS-15129	SSP2301	ME-LS-5679	SSP2310	ME-TC-13979	ARM690
ME-LS-15130	SSP2300	ME-LS-5680	SSP2313	ME-TC-13980	ARM689
ME-LS-15339	SSP2356	ME-LS-5680	SSP2315	ME-TC-13981	ARM692
ME-LS-15340	SSP2355	ME-LS-5681	SSP2314	ME-TC-13982	ARM691
ME-LS-15352	SSP2299	ME-LS-5682	SSP2317	ME-TC-14535	ARM736
ME-LS-15397	SSP2334	ME-LS-5683	SSP2316	ME-TC-14536	ARM735
ME-LS-15398	SSP2333	ME-LS-7251	SSP2361	ME-TC-14537	ARM731
ME-LS-15551	SSP2388	ME-LS-7252	SSP2363	ME-TC-14917	ARM785
ME-LS-15552	SSP2387	ME-LS-7253	SSP2362	ME-TC-14918	ARM784
ME-LS-1759	SSP2353	ME-LS-7295	SSP2291	ME-TC-14937	ARM694
ME-LS-1977	SSP2340	ME-LS-8893	SSP2342	ME-TC-14938	ARM693
ME-LS-1978	SSP2339	ME-LS-8946	SSP2308	ME-TC-14939	ARM688
ME-LS-1979	SSP2341	ME-LS-9010	SSP2349	ME-TC-15115	ARM787
ME-LS-2060	SSP2307	ME-TC-0129	ARM655	ME-TC-15116	ARM786
ME-LS-2062	SSP2309	ME-TC-0130	ARM654	ME-TC-15349	ARM679
ME-LS-2078	SSP2538	ME-TC-0728	ARM671	ME-TC-15350	ARM678
ME-LS-2248	SSP2329	ME-TC-0731	ARM672	ME-TC-1959	ARM708
ME-LS-2248	SSP2330	ME-TC-0732	ARM668	ME-TC-1960	ARM707
ME-LS-2252	SSP2332	ME-TC-0732	ARM669	ME-TC-1961	ARM752
ME-LS-2254	SSP2331	ME-TC-0987	ARM705	ME-TC-1962	ARM751
ME-LS-2726	SSP2374	ME-TC-0988	ARM706	ME-TC-1968	ARM747
ME-LS-2727	SSP2373	ME-TC-10473	ARM659	ME-TC-1969	ARM748
ME-LS-3316	SSP2370	ME-TC-10474	ARM658	ME-TC-1970	ARM745
ME-LS-3542	SSP2338	ME-TC-10643	ARM732	ME-TC-1971	ARM746
ME-LS-3819	SSP2337	ME-TC-10644	ARM730	ME-TC-1972	ARM759
ME-LS-4179	SSP2372	ME-TC-10647	ARM729	ME-TC-1973	ARM758
ME-LS-4180	SSP2371	ME-TC-10805	ARM661	ME-TC-1974	ARM757
ME-LS-4698	SSP2364	ME-TC-10806	ARM660	ME-TC-1975	ARM756
ME-LS-4699	SSP2365	ME-TC-13335	ARM683	ME-TC-1976	ARM755
ME-LS-4700	SSP2376	ME-TC-13336	ARM682	ME-TC-3699	ARM754
ME-LS-4701	SSP2375	ME-TC-13439	ARM771	ME-TC-3704	ARM753
ME-LS-4890	SSP2348	ME-TC-13440	ARM770	ME-TC-3870	ARM742
ME-LS-4891	SSP2347	ME-TC-13725	ARM665	ME-TC-3871	ARM741
ME-LS-5144	SSP2336	ME-TC-13726	ARM664	ME-TC-3872	ARM750

MOOG	MAGNETI MARELLI	MOOG	MAGNETI MARELLI	MOOG	MAGNETI MARELLI
ME-TC-3873	ARM749	ME-WP-14046	ARM695	MI-ES-4886	SSP0554
ME-TC-3874	ARM743	ME-WP-15187	ARM687	MI-ES-8437	SSP0557
ME-TC-3875	ARM744	ME-WP-15188	ARM686	MI-ES-8438	SSP0556
ME-TC-3994	ARM724	ME-WP-1532	ARM674	MI-ES-8961	SSP0549
ME-TC-3995	ARM723	ME-WP-1533	ARM675	MI-LS-15420	SSP2417
ME-TC-4182	ARM738	ME-WP-2076	ARM677	MI-LS-2385	SSP2416
ME-TC-4183	ARM739	ME-WP-2077	ARM676	MI-LS-2765	SSP2415
ME-TC-4184	ARM740	ME-WP-2250	ARM685	MI-LS-2768	SSP2414
ME-TC-4185	ARM737	ME-WP-2251	ARM684	MI-LS-4702	SSP2423
ME-TC-5174	ARM767	ME-WP-2332	ARM702	MI-LS-4703	SSP2424
ME-TC-5175	ARM766	ME-WP-2333	ARM701	MI-LS-5076	SSP2426
ME-TC-5177	ARM763	ME-WP-2715	ARM722	MI-LS-5077	SSP2425
ME-TC-5178	ARM762	ME-WP-2716	ARM721	MI-LS-7309	SSP2418
ME-TC-5180	ARM761	ME-WP-2747	ARM700	MI-LS-7383	SSP2419
ME-TC-5181	ARM760	ME-WP-2748	ARM699	MI-LS-7403	SSP2413
ME-TC-5183	ARM779	ME-WP-4390	ARM698	MI-LS-8959	SSP2412
ME-TC-5184	ARM778	ME-WP-4391	ARM697	MI-LS-8960	SSP2411
ME-TC-5185	ARM777	ME-WP-4950	ARM704	MI-LS-9093	SSP2428
ME-TC-5186	ARM776	ME-WP-4951	ARM703	MI-LS-9094	SSP2427
ME-TC-5187	ARM773	ME-WP-5151	ARM826	MI-TC-10631	ARM818
ME-TC-5188	ARM772	ME-WP-5152	ARM825	MI-TC-13782	ARM820
ME-TC-5189	ARM775	MI-AX-12636	SSP0160	MI-TC-7310	ARM817
ME-TC-5190	ARM774	MI-AX-2771	SSP0166	MI-TC-7311	ARM816
ME-TC-5675	ARM710	MI-AX-4444	SSP0161	MI-WP-2772	ARM828
ME-TC-5676	ARM709	MI-AX-4854	SSP0163	MI-WP-2775	ARM827
ME-TC-7763	ARM726	MI-AX-7305	SSP0158	MI-WP-8432	ARM823
ME-TC-7764	ARM725	MI-AX-8352	SSP0164	MI-WP-8433	ARM824
ME-TC-8796	ARM733	MI-AX-8439	SSP0162	NI-AX-1268	SSP0171
ME-TC-8797	ARM734	MI-BJ-0350	SSP1900	NI-AX-13359	SSP0175
METC8798	ARM727	MI-BJ-0351	SSP1901	NI-AX-13635	SSP0182
METC8799	ARM728	MI-BJ-10371	SSP1987	NI-AX-1701	SSP0170
ME-TC-8814	ARM717	MI-BJ-104247	SSP1906	NI-AX-1829	SSP0173
ME-TC-8815	ARM716	MI-BJ-104248	SSP1905	NI-AX-2219	SSP0225
ME-TC-8816	ARM715	MI-BJ-104249	SSP1904	NI-AX-2782	SSP0180
ME-TC-8818	ARM711	MI-BJ-4865	SSP1899	NI-AX-2797	SSP0172
ME-TC-8819	ARM712	MI-BJ-7231	SSP1908	NI-AX-4852	SSP0176
ME-TC-8822	ARM713	MI-BJ-7232	SSP1907	NI-AX-4923	SSP0179
ME-TC-8823	ARM714	MI-BJ-7385	SSP1902	NI-AX-7337	SSP0183
ME-WP-0684	ARM652	MI-ES-2937	SSP0552	NI-AX-8979	SSP0178
ME-WP-0685	ARM653	MI-ES-2937	SSP0708	NI-BJ-0311	SSP1917
ME-WP-14045	ARM696	MI-ES-4885	SSP0555	NI-BJ-10627	SSP1925



MOOG	MAGNETI MARELLI	MOOG	MAGNETI MARELLI	MOOG	MAGNETI MARELLI
NI-BJ-1256	SSP1918	NI-LS-7766	SSP2470	NI-WP-8858	ARM855
NI-BJ-13545	SSP1920	NI-LS-7767	SSP2471	OP-AX-0432	SSP0188
NI-BJ-2783	SSP1916	NI-LS-8421	SSP2465	OP-AX-10118	SSP0221
NI-BJ-4841	SSP1924	NI-LS-8422	SSP2464	OP-AX-10486	SSP0028
NI-BJ-4926	SSP1922	NI-LS-8457	SSP2450	OP-AX-1245	SSP0195
NI-BJ-4927	SSP1923	NI-TC-0566	ARM837	OP-AX-13452	SSP0201
NI-BJ-4954	SSP1926	NI-TC-0567	ARM838	OP-AX-13623	SSP0204
NI-BJ-8859	SSP1921	NI-TC-5205	ARM844	OP-AX-14543	SSP0194
NI-DS-0766	SSP2449	NI-TC-5206	ARM843	OP-AX-14765	SSP0035
NI-DS-1253	SSP2445	NI-WP-0326	ARM847	OP-AX-14766	SSP0036
NI-ES-0310	SSP0581	NI-WP-0327	ARM848	OP-AX-1893	SSP0189
NI-ES-0310	SSP0585	NI-WP-0989	ARM839	OP-AX-1894	SSP0190
NI-ES-10625	SSP0589	NI-WP-0990	ARM840	OP-AX-2194	SSP0191
NI-ES-10626	SSP0588	NI-WP-10629	ARM864	OP-AX-4160	SSP1392
NI-ES-1258	SSP0570	NI-WP-10630	ARM863	OP-AX-4162	SSP0197
NI-ES-12593	SSP0574	NI-WP-13361	ARM852	OP-AX-5162	SSP0196
NI-ES-12594	SSP0573	NI-WP-13362	ARM851	OP-AX-5576	SSP0186
NI-ES-14029	SSP0577	NI-WP-15273	ARM868	OP-AX-5577	SSP0185
NI-ES-14030	SSP0576	NI-WP-15274	ARM867	OP-AX-5689	SSP1393
NI-ES-2777	SSP0582	NI-WP-2224	ARM957	OP-AX-5691	SSP0187
NI-ES-2780	SSP0584	NI-WP-2226	ARM956	OP-AX-7221	SSP0041
NI-ES-2790	SSP0572	NI-WP-2244	ARM836	OP-AX-7452	SSP0184
NI-ES-2791	SSP0571	NI-WP-2245	ARM835	OP-AX-7768	SSP0202
NI-ES-2801	SSP0578	NI-WP-2781	ARM862	OP-AX-8746	SSP0192
NI-ES-4924	SSP0580	NI-WP-2788	ARM846	OP-AX-8747	SSP0193
NI-ES-4925	SSP0579	NI-WP-2789	ARM845	OP-AX-8847	SSP0200
NI-ES-4957	SSP0575	NI-WP-2789P	SSP1919	OP-AX-8848	SSP0199
NI-ES-5642	SSP0587	NI-WP-2795	ARM842	OP-BJ-0312	SSP1928
NI-ES-5643	SSP0586	NI-WP-2796	ARM841	OP-BJ-0812	SSP1929
NI-LS-0991	SSP2444	NI-WP-3229	ARM861	OP-BJ-12502	SSP1951
NI-LS-10160	SSP2463	NI-WP-4955	ARM854	OP-BJ-15317	SSP1933
NI-LS-10692	SSP2469	NI-WP-4956	ARM853	OP-BJ-1895	SSP1930
NI-LS-12697	SSP2452	NI-WP-6589	ARM850	OP-BJ-1899	SSP1931
NI-LS-2307	SSP2467	NI-WP-6590	ARM849	OP-BJ-4745	SSP1808
NI-LS-2308	SSP2468	NI-WP-7229	ARM866	OP-BJ-5393	SSP1927
NI-LS-2778	SSP2466	NI-WP-7230	ARM865	OP-BJ-5583	SSP1932
NI-LS-2779	SSP2448	NI-WP-8450	ARM859	OP-BJ-8965	SSP1950
NI-LS-2798	SSP2447	NI-WP-8451	ARM860	OP-ES-0480	SSP0595
NI-LS-4887	SSP2461	NI-WP-8452	ARM857	OP-ES-0514	SSP0600
NI-LS-7227	SSP2473	NI-WP-8453	ARM858	OP-ES-0514	SSP0601
NI-LS-7228	SSP2472	NI-WP-8857	ARM856	OP-ES-10119	SSP0636

MOOG	MAGNETI MARELLI	MOOG	MAGNETI MARELLI	MOOG	MAGNETI MARELLI
OP-ES-10120	SSP0635	OP-TC-0085	ARM870	PE-AX-5749	SSP0049
OP-ES-13627	SSP0608	OP-TC-0488	ARM871	PE-AX-5749	SSP0206
OP-ES-13628	SSP0607	OP-TC-0489	ARM872	PE-AX-6901	SSP0056
OP-ES-13924	SSP0598	OP-TC-10115	ARM368	PE-AX-7067	SSP0214
OP-ES-15335	SSP0606	OP-TC-10115	ARM891	PE-AX-7969	SSP0209
OP-ES-15336	SSP0605	OP-TC-10116	ARM367	PE-BJ-0837	SSP1939
OP-ES-1892	SSP0596	OP-TC-10116	ARM890	PE-BJ-0837	SSP1940
OP-ES-2081	SSP1449	OP-TC-13245	ARM879	PE-BJ-12663	SSP1942
OP-ES-2082	SSP1448	OP-TC-13246	ARM878	PE-BJ-13251	SSP1935
OP-ES-2818	SSP0603	OP-TC-13453	ARM893	PE-BJ-14684	SSP1941
OP-ES-2819	SSP0602	OP-TC-13454	ARM892	PE-BJ-15315	SSP1937
OP-ES-4746	SSP0354	OP-TC-1955	ARM118	PE-BJ-3323	SSP1936
OP-ES-5569	SSP0594	OP-TC-1956	ARM117	PE-BJ-3356	SSP1817
OP-ES-7415	SSP0604	OP-TC-4081	ARM889	PE-DS-5041	SSP2139
OP-LS-10475	SSP2515	OP-TC-8347	ARM895	PE-DS-5041	SSP2140
OP-LS-10475	SSP2516	OP-TC-8348	ARM894	PE-DS-6904	SSP2508
OP-LS-10476	SSP2518	OP-TC-8749	ARM945	PE-DS-6905	SSP2507
OP-LS-12602	SSP2517	OP-TC-8750	ARM944	PE-DS-6970	SSP2506
OP-LS-13414	SSP2476	OP-WP-0210P	ARM886	PE-ES-12631	SSP0624
OP-LS-13625	SSP2494	OP-WP-0211P	ARM885	PE-ES-12632	SSP0623
OP-LS-13626	SSP2493	OP-WP-0995	ARM873	PE-ES-12661	SSP0632
OP-LS-13685	SSP2480	OP-WP-0996	ARM874	PE-ES-12662	SSP0631
OP-LS-13686	SSP2479	OP-WP-14709	ARM884	PE-ES-3330	SSP0619
OP-LS-15333	SSP2492	OP-WP-14710	ARM883	PE-ES-3331	SSP0620
OP-LS-15334	SSP2491	OP-WP-1902	ARM875	PE-ES-4163	SSP0618
OP-LS-15394	SSP2481	OP-WP-1903	ARM876	PE-ES-4164	SSP0617
OP-LS-15394	SSP2490	OP-WP-2822P	ARM888	PE-ES-5703	SSP0612
OP-LS-2080	SSP1339	OP-WP-2823P	ARM887	PE-ES-5723	SSP0369
OP-LS-2080	SSP2484	OP-WP-3960	ARM880	PE-ES-5724	SSP0368
OP-LS-2821	SSP2483	OP-WP-3961	ARM881	PE-ES-7065	SSP0626
OP-LS-3815	SSP2485	OP-WP-7222	ARM391	PE-ES-7066	SSP0625
OP-LS-4706	SSP2125	OP-WP-7223	ARM390	PE-ES-7414	SSP0553
OP-LS-4707	SSP2126	P-636	ARM925	PE-ES-8473	SSP0622
OP-LS-5582	SSP2477	PE-AX-0860	SSP0212	PE-ES-8474	SSP0621
OP-LS-5582	SSP2478	PE-AX-12630	SSP0211	PE-LS-0592	SSP2499
OP-LS-5739	SSP2482	PEAX12660	SSP0217	PE-LS-0595	SSP2138
OP-LS-7224	SSP2123	PE-AX-13279	SSP0159	PE-LS-1048	SSP1326
OP-LS-7224	SSP2124	PE-AX-13634	SSP0208	PE-LS-12664	SSP2512
OP-LS-7446	SSP2489	PE-AX-14704	SSP0215	PE-LS-1573	SSP2495
OP-LS-8350	SSP2487	PE-AX-2059	SSP0057	PE-LS-1573	SSP2496
OP-TC-0084	ARM869	PE-AX-3327	SSP0210	PE-LS-1626	SSP2142



MOOG	MAGNETI MARELLI	MOOG	MAGNETI MARELLI	MOOG	MAGNETI MARELLI
PE-LS-3324	SSP2505	PE-WP-13660	ARM922	RE-BJ-7432	ARM656
PE-LS-3325	SSP2504	PE-WP-4027	ARM903	RE-BJ-7762	SSP1955
PE-LS-3326	SSP2503	PE-WP-4028	ARM902	RE-BJ-7905	SSP1949
PE-LS-3817	SSP2500	PE-WP-4741	ARM913	RE-BJ-7906	SSP1946
PE-LS-3817	SSP2509	PE-WP-4742	ARM912	RE-BJ-8100	SSP1957
PE-LS-3817	SSP2510	PE-WP-6979	ARM898	RE-BJ-8336	SSP1956
PE-LS-3989	SSP2497	PE-WP-6980	ARM899	RE-ES-0672	SSP0650
PE-LS-3990	SSP2498	PE-WP-7427	ARM822	RE-ES-0673	SSP0649
PE-LS-5046	SSP2137	PE-WP-7428	ARM821	RE-ES-0809	SSP0634
PE-LS-7423	SSP2422	RE-AX-0589	SSP0236	RE-ES-0810	SSP0633
PE-LS-7424	SSP2421	RE-AX-0854	SSP0231	RE-ES-0852	SSP0641
PE-LS-7425	SSP2420	RE-AX-0855	SSP0232	RE-ES-0853	SSP0642
PE-RK-13758	SSP1996	RE-AX-1060	SSP0223	REES13645	SSP0654
PE-SB-1312	SSP1248	RE-AX-10820	SSP0229	REES13646	SSP0653
PE-SB-1313	SSP1254	RE-AX-13416	SSP0240	RE-ES-15265	SSP0591
PE-SB-4963	SSP1255	RE-AX-13417	SSP0241	RE-ES-15265	SSP0638
PE-TC-1033	ARM908	RE-AX-1564	SSP0227	RE-ES-15266	SSP0590
PE-TC-1034	ARM906	RE-AX-1616	SSP0234	RE-ES-15266	SSP0637
PE-TC-10715	ARM431	RE-AX-2087	SSP0233	RE-ES-15489	SSP0660
PE-TC-10716	ARM430	RE-AX-2091	SSP0222	RE-ES-15490	SSP0659
PE-TC-13455	ARM937	RE-AX-2097	SSP0220	RE-ES-15543	SSP0593
PE-TC-13456	ARM936	RE-AX-2103	SSP0219	RE-ES-15544	SSP0592
PE-TC-14719	ARM917	RE-AX-2831	SSP0226	RE-ES-1562	SSP0647
PE-TC-14720	ARM916	RE-AX-3760	SSP0065	RE-ES-1563	SSP0648
PE-TC-1571	ARM904	RE-AX-3851	SSP0235	RE-ES-2092	SSP0640
PE-TC-1572P	ARM905	RE-AX-4014	SSP0228	RE-ES-2093	SSP0639
PE-TC-3538	ARM909	RE-AX-4014	SSP0238	RE-ES-3755	SSP0387
PE-TC-3539	ARM907	RE-AX-5087	SSP0242	RE-ES-3756	SSP0386
PE-TC-3882	ARM911	RE-AX-7300	SSP0239	RE-ES-7026	SSP0656
PE-TC-3883	ARM910	RE-AX-7303	SSP0244	RE-ES-7027	SSP0655
PE-TC-5754	ARM915	RE-AX-8765	SSP0066	RE-ES-7053	SSP0646
PE-TC-5754	ARM921	RE-BJ-1040	SSP1947	RE-ES-7054	SSP0645
PE-TC-5755	ARM914	RE-BJ-10478	SSP1823	RE-ES-7301	SSP0658
PE-TC-5755	ARM920	RE-BJ-15242	SSP1943	RE-ES-7302	SSP0657
PE-TC-7381	ARM928	RE-BJ-2094	SSP1953	RE-ES-7306	SSP0652
PE-TC-7382	ARM929	RE-BJ-2098	SSP1948	RE-ES-7307	SSP0651
PE-TC-8470	ARM919	RE-BJ-2302	SSP1954	RE-ES-7856	SSP0643
PE-TC-8471	ARM918	RE-BJ-2832	SSP1952	RE-ES-7861	SSP0644
PE-WP-0626	ARM901	RE-BJ-4264	SSP1944	RE-ES-8763	SSP0389
PE-WP-0627	ARM900	RE-BJ-7212	SSP1958	RE-ES-8764	SSP0388
PE-WP-13659	ARM923	RE-BJ-7431	ARM657	RE-LS-1058	SSP2514

MOOG	MAGNETI MARELLI	MOOG	MAGNETI MARELLI	MOOG	MAGNETI MARELLI
RE-LS-1059	SSP2513	RE-WP-15330	ARM960	TO-AX-15168	SSP0266
RE-LS-1072	SSP2530	RE-WP-15517	ARM981	TO-AX-1640	SSP0257
RE-LS-15514	SSP2532	RE-WP-15518	ARM980	TO-AX-1740	SSP0255
RE-LS-2088	SSP2519	RE-WP-15643	ARM949	TO-AX-2975	SSP0262
RE-LS-2095	SSP2522	RE-WP-15644	ARM948	TO-AX-2994	SSP0259
RE-LS-2095	SSP2523	RE-WP-2089	ARM951	TO-AX-3014	SSP0252
RE-LS-2100	SSP2451	RE-WP-2090	ARM950	TO-AX-3983	SSP0251
RE-LS-3072	SSP2531	RE-WP-2101	ARM941	TO-AX-4988	SSP0250
RE-LS-4439	SSP2524	RE-WP-2102	ARM940	TO-AX-7449	SSP0256
RE-LS-7304	SSP2154	RE-WP-2300	ARM954	TO-AX-8836	SSP0253
RE-LS-7304	SSP2520	RE-WP-2301	ARM955	TO-BJ-0538	SSP1972
RE-LS-7407	SSP2521	RE-WP-3489	ARM953	TO-BJ-2274	SSP1971
RE-LS-7996	SSP2528	RE-WP-3490	ARM952	TO-BJ-3011	SSP1975
RE-LS-7999	SSP2525	RE-WP-3744	ARM447	TO-BJ-4108	SSP1968
RE-LS-7999	SSP2526	RE-WP-3745	ARM446	TO-BJ-4991	SSP1967
RE-LS-7999	SSP2527	RE-WP-7760	ARM958	TO-BJ-4992	SSP1966
RE-TC-10092	ARM946	RE-WP-7761	ARM959	TO-BJ-5679	SSP1974
RE-TC-10093	ARM947	RE-WP-7903	ARM967	TO-BJ-8833	SSP1970
RE-TC-10479	ARM449	RE-WP-7904	ARM966	TO-BJ-8834	SSP1969
RE-TC-10480	ARM448	RE-WP-8101	ARM977	TO-BJ-8972	SSP1973
RE-TC-14593	ARM451	RE-WP-8102	ARM976	TO-ES-0740	SSP0672
RE-TC-14594	ARM450	RE-WP-8330	ARM978	TO-ES-0741	SSP0673
RE-TC-14595	ARM452	RE-WP-8331	ARM979	TO-ES-10849	SSP0694
RE-TC-14596	ARM453	SA-AX-7754	SSP0198	TO-ES-10850	SSP0693
RE-WP-0228	ARM975	SE-LS-2850	SSP2585	TO-ES-13238	SSP0674
RE-WP-0229	ARM974	SK-BJ-0414	SSP1961	TO-ES-13239	SSP0675
RE-WP-0337	ARM965	SK-ES-0411	SSP0662	TO-ES-15173	SSP0695
RE-WP-0338	ARM962	SK-ES-0412	SSP0661	TO-ES-2977	SSP0684
RE-WP-0339	ARM963	SZ-AX-5082	SSP0249	TO-ES-2978	SSP0683
RE-WP-1052	ARM943	SZ-ES-2292	SSP0597	TO-ES-2990	SSP0677
RE-WP-1053	ARM942	SZ-ES-8478	SSP0665	TO-ES-2991	SSP0678
RE-WP-13607	ARM973	SZ-LS-5081	SSP2539	TO-ES-3306	SSP0666
RE-WP-13608	ARM972	SZ-TC-1188	ARM991	TO-ES-4889	SSP0681
RE-WP-13709	ARM971	SZ-TC-1238	ARM992	TO-ES-4977	SSP0689
RE-WP-13710	ARM970	SZ-WP-5083	ARM994	TO-ES-4978	SSP0690
RE-WP-14757	ARM969	SZ-WP-5084	ARM993	TO-ES-4984	SSP0692
RE-WP-14758	ARM964	TO-AX-4972	SSP0260	TO-ES-4985	SSP0691
RE-WP-14758	ARM968	TO-AX-10446	SSP0258	TO-ES-4989	SSP0668
RE-WP-15243	ARM939	TO-AX-10772	SSP0263	TO-ES-4990	SSP0667
RE-WP-15244	ARM938	TO-AX-10851	SSP0265	TO-ES-4996	SSP0669
RE-WP-15329	ARM961	TO-AX-14616	SSP0264	TO-ES-5772	SSP0686



MOOG	MAGNETI MARELLI	MOOG	MAGNETI MARELLI	MOOG	MAGNETI MARELLI
TO-ES-5773	SSP0685	TO-WP-2235	ARM1029	VO-BJ-8249	SSP1986
TO-ES-6582	SSP0680	TO-WP-2992	ARM1023	VO-BJ-8249	SSP1999
TO-ES-6583	SSP0679	TO-WP-4378	ARM1022	VO-BJ-8287	SSP1778
TO-ES-8835	SSP0671	TO-WP-4383	ARM1001	VO-BJ-8287	SSP1779
TO-ES-8980	SSP0670	TO-WP-4384	ARM999	VO-BJ-8288	SSP1776
TO-LS-10470	SSP2560	TO-WP-4385	ARM1003	VO-BJ-8288	SSP1777
TO-LS-10549	SSP2547	TO-WP-4386	ARM1002	VO-DS-15435	SSP0139
TO-LS-10757	SSP2546	TO-WP-6584	ARM1025	VO-ES-13341	SSP0703
TO-LS-14562	SSP2563	TO-WP-6585	ARM1024	VO-ES-13342	SSP0702
TO-LS-14603	SSP2543	TO-WP-7450	ARM1018	VO-ES-1506	SSP0663
TO-LS-14604	SSP2564	TO-WP-7451	ARM1019	VO-ES-1507	SSP0664
TO-LS-14605	SSP2565	TO-WP-8425	ARM998	VO-ES-1868	SSP0701
TO-LS-2976	SSP2559	TO-WP-8426	ARM997	VO-ES-1869	SSP0700
TO-LS-2980	SSP2555	VO-AX-0358	SSP0272	VO-ES-2314	SSP0705
TO-LS-2993	SSP2552	VO-AX-12501	SSP0270	VO-ES-2315	SSP0704
TO-LS-3984	SSP2544	VO-AX-12550	SSP0248	VO-ES-2404	SSP0290
TO-LS-4120	SSP2557	VO-AX-13381	SSP0268	VO-ES-2405	SSP0291
TO-LS-4128	SSP2556	VO-AX-13741	SSP0003	VO-ES-3058	SSP0697
TO-LS-4167	SSP2551	VO-AX-14746	SSP0013	VO-ES-3059	SSP0696
TO-LS-4168	SSP2553	VO-AX-1812	SSP0274	VO-ES-7106	SSP0698
TO-LS-4983	SSP2562	VO-AX-2313	SSP0271	VO-ES-7139	SSP0699
TO-LS-4997	SSP2542	VO-AX-2408	SSP0276	VO-ES-8227	SSP0287
TO-LS-5090	SSP2549	VO-AX-2409	SSP0007	VO-ES-8258	SSP0706
TO-LS-5141	SSP2550	VO-AX-3054	SSP0267	VO-ES-8259	SSP0707
TO-LS-6580	SSP2561	VO-AX-8275	SSP0273	VO-ES-8283	SSP0286
TO-LS-6581	SSP2554	VO-AX-8286	SSP0005	VO-ES-8285	SSP0285
TO-LS-8888	SSP2558	VO-AX-8291	SSP0004	VO-LS-0157	SSP2005
TO-LS-8966	SSP2545	VO-BJ-0319	SSP1984	VO-LS-0157	SSP2009
TO-WP-0804	ARM1014	VO-BJ-1859	SSP1976	VO-LS-0318	SSP2583
TO-WP-0807	ARM1015	VO-BJ-1860	SSP1977	VO-LS-0356	SSP2007
TO-WP-1074	ARM1005	VO-BJ-1990	SSP1982	VO-LS-0357	SSP2008
TO-WP-1075	ARM1004	VO-BJ-2410	SSP1775	VO-LS-0418	SSP2577
TO-WP-10769	ARM1032	VO-BJ-5011	SSP1979	VO-LS-0456	SSP2004
TO-WP-10770	ARM1031	VO-BJ-5011	SSP1981	VO-LS-0463	SSP2587
TO-WP-13253	ARM1011	VO-BJ-5012	SSP1978	VO-LS-0475	SSP2572
TO-WP-13254	ARM1010	VO-BJ-5012	SSP1980	VO-LS-0494	SSP2534
TO-WP-13267	ARM1013	VO-BJ-7050	SSP1983	VO-LS-0494	SSP2535
TO-WP-13268	ARM1012	VO-BJ-7926	SSP1963	VO-LS-0494	SSP2586
TO-WP-15319	ARM1028	VO-BJ-7927	SSP1964	VO-LS-0584	ARM983
TO-WP-15320	ARM1027	VO-BJ-8248	SSP1985	VO-LS-13724	SSP2569
TO-WP-2234	ARM1030	VO-BJ-8248	SSP1998	VO-LS-13744	SSP2579

MOOG	MAGNETI MARELLI	MOOG	MAGNETI MARELLI	MOOG	MAGNETI MARELLI
VO-LS-13833	SSP2346	VO-TC-4932	ARM210	VO-WP-1989	ARM984
VO-LS-13963	SSP2537	VO-TC-4933	ARM209	VO-WP-3060	ARM1036
VO-LS-15462	SSP2570	VO-TC-4935	ARM208	VO-WP-3061	ARM1035
VO-LS-1870	SSP2576	VO-TC-4936	ARM207	VO-WP-5008	ARM1047
VO-LS-2205	ARM982	VO-TC-8228	ARM180	VO-WP-5009	ARM1046
VO-LS-2271	SSP2016	VO-TC-8229	ARM179	VO-WP-8837	ARM987
VO-LS-2271	SSP2017	VO-TC-8230	ARM178	VO-WP-8838	ARM986
VO-LS-2311	SSP2580	VO-TC-8235	ARM176	VO-WP-8853	ARM1077
VO-LS-2311	SSP2581	VO-TC-8236	ARM174	VO-WP-8854	ARM1076
VO-LS-2406	SSP2002	VO-TC-8737	ARM1039	VV-AX-0027	SSP0165
VO-LS-2406	SSP2003	VO-WP-0235P	ARM1074	VV-AX-0398	SSP0279
VO-LS-2422	SSP2006	VO-WP-0236P	ARM1075	VV-AX-3147	SSP0278
VO-LS-3053	SSP2566	VO-WP-0450	ARM1070	VV-AX-7868	SSP0277
VO-LS-3353	SSP2584	VO-WP-0451	ARM1071	VV-AX-8831	SSP0280
VO-LS-3980	SSP2578	VO-WP-10817	ARM1061	VV-AX-8832	SSP0281
VO-LS-4397	SSP2568	VO-WP-10818	ARM1060	VV-BJ-0893	SSP1988
VO-LS-4398	SSP2567	VO-WP-1116	ARM985	VV-BJ-13671	SSP1990
VO-LS-4916	SSP2571	VO-WP-13307	ARM1063	VV-BJ-13891	SSP1991
VO-LS-4931	SSP2588	VO-WP-13308	ARM1062	VV-BJ-13892	SSP1992
VO-LS-7327	SSP2575	VO-WP-13343	ARM1065	VV-BJ-3653	SSP1837
VO-LS-8240	SSP2010	VO-WP-13344	ARM1064	VV-BJ-4399	SSP1989
VO-RK-1210	SSP2582	VO-WP-13471	ARM1053	VV-BJ-4873	SSP1836
VO-TC-0586	ARM189	VO-WP-13472	ARM1052	VV-BJ-8740	ARM1088
VO-TC-0892	ARM181	VO-WP-13657	ARM1041	VV-ES-0020	SSP0442
VO-TC-10775	ARM1055	VO-WP-13658	ARM1040	VV-ES-1090	SSP0710
VO-TC-10776	ARM1054	VO-WP-13727	ARM1044	VV-ES-1091	SSP0709
VO-TC-10911	ARM169	VO-WP-13728	ARM1045	VV-ES-13895	SSP0718
VO-TC-13241	ARM215	VO-WP-13729	ARM1043	VV-ES-13896	SSP0717
VO-TC-13242	ARM214	VO-WP-13730	ARM1042	VV-ES-2858	SSP0712
VO-TC-13465	ARM1033	VO-WP-13841	ARM1059	VV-ES-3146	SSP0711
VO-TC-13775	ARM1069	VO-WP-13841	ARM168	VV-ES-4019	SSP0713
VO-TC-13776	ARM1068	VO-WP-13842	ARM1058	VV-ES-4021	SSP0714
VO-TC-13961	ARM188	VO-WP-13842	ARM167	VV-LS-0014	SSP2431
VO-TC-13962	ARM187	VO-WP-14779	ARM990	VV-LS-0014	SSP2590
VO-TC-14576	ARM1056	VO-WP-14780	ARM989	VV-LS-1096	SSP2593
VO-TC-14579	ARM1038	VO-WP-1552	ARM182	VV-LS-1119	SSP2594
VO-TC-14580	ARM1037	VO-WP-1553	ARM183	VV-LS-1119	SSP2595
VO-TC-14990	ARM200	VO-WP-1861	ARM1048	VV-LS-1432	SSP2589
VO-TC-15229	ARM988	VO-WP-1862	ARM1049	VV-LS-6592	SSP2591
VO-TC-4000	ARM177	VO-WP-1864	ARM1050	VV-LS-7324	SSP2592
VO-TC-4001	ARM175	VO-WP-1865	ARM1051	VV-TC-13889	ARM1091



MOOG	MAGNETI MARELLI	NK	MAGNETI MARELLI	NK	MAGNETI MARELLI
VV-TC-13890	ARM1090	5001005	SSP1181	5012345	ARM020
VV-TC-4400	ARM1085	5001006	SSP1182	5012346	ARM019
VV-TC-4401	ARM1084	5011001	ARM008	5012351	ARM112
VV-WP-0360	ARM1083	5011002	ARM007	5012352	ARM111
VV-WP-0379	ARM1082	5011003	ARM004	5012353	ARM096
VV-WP-13669	ARM1087	5011004	ARM003	5012354	ARM095
VV-WP-13670	ARM1086	5011005	ARM120	5012355	ARM018
VV-WP-3638	ARM1079	5011006	ARM119	5012356	ARM017
VV-WP-3639	ARM1078	5011007	ARM126	5012363	ARM090
VV-WP-3640	ARM541	5011008	ARM125	5012364	ARM089
VV-WP-3645	ARM540	5011009	ARM128	5012365	ARM058
VV-WP-3950	ARM1081	5011010	ARM127	5012366	ARM059
VV-WP-3951	ARM1080	5011011	ARM063	5012367	ARM076
VV-WP-4871	ARM544	5011012	ARM062	5012368	ARM075
VV-WP-4872	ARM543	5011013	ARM060	5012369	ARM072
		5011014	ARM061	5012370	ARM071
		5011905	ARM024	5012372	ARM113
		5011906	ARM023	5012373	ARM114
		5011909	ARM026	5012374	ARM153
		5011910	ARM025	5012375	ARM154
		5011911	ARM028	5013627	ARM118
		5011935	ARM026	5013628	ARM117
		5011936	ARM027	5019301	ARM152
		5011937	ARM028	5019302	ARM151
		5011938	ARM027	5031006	SSP1346
		5011939	ARM036	5031011	SSP1402
		5011940	ARM035	5031012	SSP1401
		5011941	ARM093	5031013	SSP1348
		5011942	ARM094	5031014	SSP1347
		5011943	ARM091	5031015	SSP1397
		5011944	ARM092	5031016	SSP1396
		5012315	ARM002	5031017	SSP1344
		5012316	ARM001	5031916	SSP1429
		5012317	ARM156	5031917	SSP1381
		5012318	ARM155	5031918	SSP1431
		5012319	ARM042	5031919	SSP1383
		5012320	ARM041	5031920	SSP1434
		5012335	ARM134	5031921	SSP1433
		5012336	ARM133	5031935	SSP1451
		5012337	ARM148	5031936	SSP1384
		5012338	ARM147	5031937	SSP1432

NK	MAGNETI MARELLI	NK	MAGNETI MARELLI	NK	MAGNETI MARELLI
5031940	SSP1436	5033668	SSP1448	5102319	SSP1218
5031942	SSP1382	5033669	SSP1393	5102320	SSP1217
5031943	SSP1385	5034003	SSP1441	5102321	SSP1214
5032303	SSP1437	5039302	SSP1351	5103611	SSP1213
5032308	SSP1409	5039303	SSP1405	5111002	SSP1292
5032318	SSP1411	5039304	SSP1406	5111003	SSP1293
5032333	SSP1415	5039305	SSP1407	5111004	SSP1294
5032334	SSP1414	5041914	SSP1196	5111005	SSP1296
5032342	SSP1358	5041915	SSP1197	5111006	SSP1295
5032343	SSP1362	5041921	SSP1198	5111009	SSP1288
5032344	SSP1416	5041922	SSP1199	5111010	SSP1287
5032345	SSP1363	5041923	SSP1201	5111011	SSP1291
5032346	SSP1364	5042303	SSP1187	5111012	SSP1289
5032347	SSP1361	5042306	SSP1204	5111911	SSP1341
5032352	SSP1425	5042314	ARM149	5111912	SSP1328
5032353	SSP1424	5042315	SSP1191	5111913	SSP1317
5032359	SSP1417	5042319	SSP1193	5112301	SSP1314
5032360	SSP1418	5042320	SSP1194	5112302	SSP1326
5032361	SSP1374	5042321	SSP1188	5112306	SSP1321
5032362	SSP1371	5044013	SSP1205	5112310	SSP1323
5032363	SSP1366	5044014	SSP1206	5112313	SSP1312
5032364	SSP1426	5101001	SSP1222	5112314	SSP1316
5032365	SSP1376	5101002	SSP1216	5113709	SSP1327
5032369	SSP1413	5101003	SSP1211	5113720	SSP1331
5032370	SSP1412	5101004	SSP1228	5119301	SSP1301
5032373	SSP1438	5101005	SSP1253	5119302	SSP1305
5032374	SSP1367	5101006	SSP1239	5119303	SSP1306
5032374	SSP1392	5101007	SSP1282		
5032375	SSP1421	5101008	SSP1267		
5032376	SSP1419	5101908	SSP1249		
5032377	SSP1388	5101909	SSP1254		
5032378	SSP1389	5101930	SSP1261		
5032379	SSP1439	5102301	SSP1269		
5032380	SSP1386	5102302	SSP1271		
5032381	SSP1435	5102303	SSP1283		
5032382	SSP1422	5102306	SSP1278		
5032383	SSP1423	5102307	SSP1277		
5032384	SSP1375	5102308	SSP1276		
5032385	SSP1428	5102309	SSP1275		
5032386	SSP1427	5102310	SSP1232		
5033667	SSP1449	5102311	SSP1258		



QUINTON HAZELL	MAGNETI MARELLI	QUINTON HAZELL	MAGNETI MARELLI	QUINTON HAZELL	MAGNETI MARELLI
EMS3000	ARM008	QLS3527S	SSP1316	QR3353S	SSP1424
EMS3001	ARM007	QLS3574S	SSP1288	QR3354S	SSP1375
EMS3020	SSP1211	QLS3575S	SSP1287	QR3400S	SSP1439
EMS8034	SSP1217	QLS3576S	SSP1291	QR3401S	SSP1389
EMS8035	SSP1218	QLS3577S	SSP1289	QR3402S	SSP1413
EMS8036	SSP1277	QLS3586S	SSP1328	QR3403S	SSP1412
EMS8037	SSP1278	QLS3596S	SSP1306	QR3404S	SSP1356
EMS8039	SSP1228	QLS3597S	SSP1305	QR3409S	SSP1451
EMS8052	SSP1283	QLS3598S	SSP1301	QR3550S	SSP1367
EMS8081	SSP1267	QLS3615S	SSP1317	QR3556S	SSP1421
EMS8082	SSP1253	QLS3651S	SSP1331	QR3557S	SSP1419
EMS8083	SSP1282	QLS3739S	SSP1329	QR3589S	SSP1344
EMS8084	SSP1239	QLS3753S	SSP1333	QR3596S	SSP1371
EMS8129	ARM127	QLS3754S	SSP1332	QR3599S	SSP1438
EMS8130	SSP1234	QLS3768S	SSP1324	QR3627S	SSP1434
EMS8208	SSP1227	QLS3787S	SSP1299	QR3628S	SSP1433
EMS8217	SSP1221	QLS3788S	SSP1298	QR3629S	SSP1385
EMS8241	SSP1262	QR1836S	SSP1411	QR3647S	SSP1352
EMS8245	SSP1258	QR2379S	SSP1398	QR3648S	SSP1397
EMS8303	SSP1245	QR2379S	SSP1414	QR3649S	SSP1396
EMS8304	SSP1244	QR2380S	SSP1399	QR3660S	SSP1423
EMS8348	SSP1255	QR2380S	SSP1415	QR3661S	SSP1422
EMS8349	SSP1256	QR2464S	SSP1362	QR3666S	SSP1408
EMS8443	SSP1259	QR2465S	SSP1361	QR3712S	SSP1436
EMS8472	SSP1264	QR2844S	SSP1345	QR3713S	SSP1387
EMS8473	SSP1265	QR2844S	SSP1346	QR3744S	SSP1351
EMS8498	SSP1274	QR2856S	SSP1429	QR3784S	SSP1403
EMS8499	SSP1273	QR2857S	SSP1381	QR3859S	SSP1428
QDL5291S	SSP1182	QR2858S	SSP1431	QR3860S	SSP1427
QLS1747S	SSP1294	QR2859S	SSP1382	QR3875S	SSP1404
QLS1752S	SSP1292	QR2860S	SSP1416	QR3880S	SSP1378
QLS1757S	SSP1293	QR2861S	SSP1363	QR4200S	SSP1379
QLS1885S	SSP1326	QR2862S	SSP1364	QR9901S	SSP1402
QLS1886S	SSP1327	QR3036S	SSP1365	QR9902S	SSP1401
QLS1970S	SSP1314	QR3296S	SSP1449	QR9903S	SSP1347
QLS3260S	SSP1295	QR3297S	SSP1448	QR9907S	SSP1348
QLS3261S	SSP1296	QR3298S	SSP1393	QR9925S	SSP1417
QLS3277S	SSP1323	QR3304S	SSP1374	QR9925S	SSP1418
QLS3325S	SSP1321	QR3350S	SSP1432	QR9962S	SSP1437
QLS3334S	SSP1341	QR3351S	SSP1384	QR9963S	SSP1358
QLS3373S	SSP1312	QR3352S	SSP1425	QR9975S	SSP1366



RUVILLE	MAGNETI MARELLI	RUVILLE	MAGNETI MARELLI	RUVILLE	MAGNETI MARELLI
915388	SSP1449	915944	SSP1197	935823	ARM147
915389	SSP1448	915956	SSP1432	935830	ARM096
915390	SSP1393	916005	SSP1402	935831	ARM095
915801	SSP1399	916006	SSP1401	935834	ARM112
915802	SSP1398	916007	SSP1347	935835	ARM111
915806	SSP1379	916009	SSP1346	935839	ARM008
915809	SSP1437	916009	SSP1367	935840	ARM007
915811	SSP1365	916014	SSP1292	935856	ARM018
915812	SSP1358	916017	SSP1181	935857	ARM017
915814	SSP1345	916018	SSP1182	935859	ARM089
915818	SSP1411	916048	SSP1348	935860	ARM090
915819	SSP1187	916070	SSP1288	935861	ARM075
915820	SSP1416	916072	SSP1344	935862	ARM076
915821	SSP1363	916637	SSP1436	935865	ARM113
915823	SSP1361	916639	SSP1331	935877	ARM059
915824	SSP1409	917100	SSP1438	935880	ARM092
915832	SSP1204	917103	SSP1388	935880	ARM094
915834	SSP1366	917610	SSP1319	935881	ARM091
915835	SSP1371	917623	SSP1384	935881	ARM093
915843	SSP1191	918600	SSP1441	935882	ARM072
915844	SSP1417	918614	SSP1206	935883	ARM071
915845	SSP1374	918615	SSP1205	935885	ARM153
915847	SSP1194	918616	SSP1405	935886	ARM154
915848	SSP1193	918617	SSP1184	935888	ARM136
915849	SSP1426	918619	SSP1407	935889	ARM135
915850	SSP1376	918624	SSP1351	935912	ARM024
915851	SSP1313	918625	SSP1406	935913	ARM023
915854	SSP1413	918626	SSP1301	935932	ARM026
915855	SSP1412	918627	SSP1302	935933	ARM025
915856	SSP1356	935322	ARM118	935933	ARM027
915857	SSP1312	935323	ARM117	935934	ARM028
915858	SSP1389	935800	ARM149	935935	ARM027
915862	SSP1355	935801	ARM002	936006	ARM003
915877	SSP1322	935802	ARM001	936021	ARM128
915881	SSP1375	935812	ARM156	936022	ARM127
915900	SSP1326	935813	ARM155	936027	ARM120
915910	SSP1429	935814	ARM042	936028	ARM119
915911	SSP1381	935815	ARM041	936036	ARM062
915926	SSP1431	935820	ARM134	936037	ARM063
915927	SSP1382	935821	ARM133	936038	ARM060
915928	SSP1196	935822	ARM148	936039	ARM061

RUVILLE	MAGNETI MARELLI	SWAG	MAGNETI MARELLI	SWAG	MAGNETI MARELLI
936628	ARM074	51185	ARM024	70710034	SSP1424
936629	ARM073	51197	ARM023	70710035	SSP1425
937610	ARM036	935934	ARM028	70710036	SSP1399
937611	ARM035	14941033	SSP1305	70710036	SSP1415
938602	ARM140	14941034	SSP1306	70710037	SSP1414
938603	ARM139	14941092	SSP1405	70720004	SSP1382
938606	ARM142	14941104	SSP1408	70720004	SSP1383
938607	ARM141	40600017	SSP1213	70720005	SSP1363
987612	SSP1249	40922379	SSP1339	70720007	SSP1364
987613	SSP1254	40923001	ARM118	70730042	ARM026
987614	SSP1248	40923002	ARM117	70730046	ARM002
		40926152	SSP1449	70730053	ARM027
		40926153	SSP1448	70730056	ARM027
		40926432	SSP1393	70730058	ARM001
		62919403	SSP1341	70730063	ARM150
		62921611	SSP1258	70730066	ARM096
		62926645	ARM036	70730067	ARM095
		62926646	ARM035	70730068	ARM019
		62928601	SSP1331	70730069	ARM020
		62929385	SSP1201	70740001	SSP1381
		62932192	SSP1433	70740006	SSP1353
		62932193	SSP1434	70740006	SSP1361
		62932194	SSP1317	70740011	SSP1362
		62935840	SSP1385	70780006	SSP1187
		62935889	SSP1328	70780007	SSP1196
		62936669	SSP1387	70780008	SSP1197
		62936883	SSP1329	70790003	SSP1315
		62937689	ARM073	70919457	SSP1216
		62937690	ARM074	70919469	SSP1313
		62937860	SSP1436	70919469	SSP1323
		70610001	SSP1314	70919473	SSP1215
		70610002	SSP1326	70919475	SSP1275
		70610009	SSP1327	70919476	SSP1276
		70710001	SSP1429	70919959	ARM017
		70710005	SSP1411	70919963	SSP1426
		70710028	SSP1431	70919965	SSP1376
		70710029	SSP1416	70922267	SSP1198
		70710030	SSP1409	70922269	SSP1199
		70710031	SSP1437	70927414	SSP1297
		70710032	SSP1417	70927414	SSP1316
		70710032	SSP1418	70928351	SSP1451



SWAG	MAGNETI MARELLI	SWAG	MAGNETI MARELLI	TRW	MAGNETI MARELLI
70928606	SSP1321			JAR00082	SSP0160
70928618	SSP1421			JAR00676	SSP0175
70928619	SSP1419			JAR00707	SSP0124
70929144	ARM058			JAR00766	SSP0155
70929145	ARM059			JAR00773	SSP0107
70929145	SSP1188			JAR00862	SSP0254
70929505	ARM042			JAR1002	SSP0009
70929506	ARM041			JAR1006	SSP0196
70932443	ARM090			JAR1007	SSP0016
70932444	ARM089			JAR1008	SSP0190
70932767	SSP1423			JAR1012	SSP0213
70932768	SSP1422			JAR1014	SSP0239
70933811	SSP1325			JAR1017	SSP0189
70934300	SSP1309			JAR1020	SSP0242
74710003	SSP1401			JAR1022	SSP0084
74710004	SSP1402			JAR1023	SSP0075
74730001	ARM008			JAR1024	SSP0086
74730003	ARM007			JAR1025	SSP0226
74730007	ARM004			JAR1027	SSP0202
74760001	SSP1292			JAR1031	SSP0065
74918216	SSP1293			JAR1033	SSP0276
74921204	SSP1294			JAR1048	SSP0191
74921205	SSP1295			JAR1050	SSP0147
74921206	SSP1296			JAR1056	SSP0146
74921258	ARM126			JAR1057	SSP0192
74921260	ARM125			JAR1058	SSP0193
74923143	SSP1182			JAR106	SSP0133
74923145	SSP1181			JAR1062	SSP0006
74923161	ARM120			JAR1065	SSP0140
74923163	ARM119			JAR107	SSP0138
74927422	SSP1288			JAR1072	SSP0187
74929399	SSP1291			JAR1074	SSP0149
74929400	SSP1289			JAR1075	SSP0208
74929419	SSP1344			JAR1076	SSP0041
74929419	SSP1397			JAR1078	SSP0144
74929420	SSP1396			JAR1079	SSP0066
74934286	ARM061			JAR1080	SSP0131
74934287	ARM060			JAR1088	SSP0052
74936671	SSP1299			JAR1089	SSP0214
74936672	SSP1298			JAR1090	SSP0092
84928638	SSP1343			JAR111	SSP0071

TRW	MAGNETI MARELLI	TRW	MAGNETI MARELLI	TRW	MAGNETI MARELLI
JAR1110	SSP0176	JAR1311	SSP0111	JAR662	SSP0223
JAR1123	SSP0090	JAR1313	SSP0121	JAR662	SSP0224
JAR1125	SSP0158	JAR1313	SSP0122	JAR669	SSP0211
JAR1133	SSP0046	JAR1318	SSP0051	JAR689	SSP0194
JAR1134	SSP0087	JAR1322	SSP0166	JAR715	SSP0113
JAR114	SSP0072	JAR1328	SSP0099	JAR724	SSP0163
JAR115	SSP0077	JAR1329	SSP0105	JAR7503	SSP0277
JAR1157	SSP0178	JAR1336	SSP0168	JAR7519	SSP0120
JAR116	SSP0083	JAR137	SSP0130	JAR7527	SSP0255
JAR1161	SSP0030	JAR146	SSP0171	JAR7528	SSP0262
JAR117	SSP0097	JAR173	SSP0207	JAR7531	SSP0180
JAR1173	SSP0179	JAR179	SSP0227	JAR7539	SSP0253
JAR1182	SSP0088	JAR197	SSP0073	JAR7544	SSP0150
JAR1225	SSP0244	JAR207	SSP0233	JAR7545	SSP0153
JAR124	SSP0186	JAR208	SSP0112	JAR7547	SSP0259
JAR1240	SSP0058	JAR218	SSP0125	JAR7551	SSP0123
JAR125	SSP0185	JAR226	SSP0056	JAR7554	SSP0251
JAR1253	SSP0060	JAR231	SSP0005	JAR7555	SSP0250
JAR1257	SSP0209	JAR237	SSP0047	JAR7563	SSP0161
JAR1258	SSP0210	JAR255	SSP0152	JAR7572	SSP0256
JAR1259	SSP0126	JAR272	SSP0117	JAR7591	SSP0164
JAR1261	SSP0181	JAR273	SSP0118	JAR7596	SSP0116
JAR1264	SSP0260	JAR337	SSP0170	JAR7597	SSP0115
JAR1266	SSP0258	JAR381	SSP0257	JAR7620	SSP0265
JAR1268	SSP0027	JAR393	SSP0177	JAR7640	SSP0098
JAR1278	SSP0103	JAR411	SSP0252	JAR7646	SSP0183
JAR1279	SSP0106	JAR495	SSP0049	JAR7658	SSP0266
JAR1284	SSP0104	JAR495	SSP0206	JAR918	SSP0021
JAR1285	SSP0108	JAR506	SSP0274	JAR919	SSP0023
JAR1286	SSP0159	JAR507	SSP0273	JAR924	SSP0004
JAR1290	SSP0199	JAR511	SSP0050	JAR928	SSP0003
JAR1291	SSP0200	JAR551	SSP0165	JAR929	SSP0219
JAR1292	SSP0035	JAR566	SSP0096	JAR935	SSP0143
JAR1294	SSP0036	JAR569	SSP0132	JAR936	SSP0220
JAR1296	SSP0028	JAR586	SSP0074	JAR938	SSP0228
JAR1298	SSP0184	JAR646	SSP0057	JAR939	SSP0269
JAR1301	SSP0229	JAR647	SSP0059	JAR942	SSP0094
JAR1303	SSP0085	JAR647	SSP2511	JAR943	SSP0095
JAR1306	SSP0011	JAR648	SSP0055	JAR946	SSP0167
JAR1309	SSP0249	JAR649	SSP0145	JAR949	SSP0231
JAR1310	SSP0154	JAR650	SSP0212	JAR950	SSP0236



TRW	MAGNETI MARELLI	TRW	MAGNETI MARELLI	TRW	MAGNETI MARELLI
JAR951	SSP0234	JB11095	SSP1926	JB1363	SSP1859
JAR953	SSP0279	JB11096	ARM560	JB1368	SSP1884
JAR957	SSP0195	JB11097	SSP1937	JB1375	SSP1828
JAR958	SSP0198	JB11099	SSP1873	JB1377	SSP1778
JAR964	SSP0232	JB1113	SSP1777	JB1526	SSP1921
JAR965	SSP0015	JB1113	SSP1779	JB1553	SSP1975
JAR971	SSP0222	JB1117	SSP1773	JB1656	SSP1835
JAR972	SSP0197	JB1118	SSP1774	JB1665	SSP1775
JAR973	SSP0139	JB1125	SSP1934	JB1680	SSP1899
JAR978	SSP0076	JB1127	SSP1815	JB1687	SSP1904
JAR980	SSP0235	JB1127	SSP1816	JB1697	SSP1891
JAR981	SSP0271	JB1129	SSP1817	JB17008	SSP1799
JAR982	SSP0019	JB1142	SSP1984	JB1702	SSP1962
JAR982	SSP0310	JB1145	SSP1831	JB1703	SSP1961
JAR982	SSP0311	JB1149	ARM869	JB1705	SSP1929
JAR984	SSP0238	JB1149	ARM870	JB1707	SSP1938
JAR986	SSP0137	JB1149	SSP1927	JB1710	ARM1014
JAR987	SSP0136	JB1151	ARM871	JB1710	ARM1015
JAR988	SSP0008	JB1151	ARM872	JB1710	ARM902
JAR989	SSP0216	JB1151	SSP1928	JB1710	ARM903
JAR990	SSP0225	JB1167	SSP1877	JB1710	SSP1971
JAR991	SSP0188	JB1174	SSP1854	JB1711	ARM513
JAR993	SSP0007	JB1174	SSP1902	JB1711	ARM514
JAR994	SSP0267	JB1174	SSP1987	JB1713	SSP1786
JB1100	SSP1932	JB1175	SSP1905	JB1719	SSP1954
JB11006	SSP1862	JB1176	SSP1906	JB1720	SSP1988
JB11049	SSP1951	JB1177	SSP1918	JB1721	SSP1952
JB11053	SSP1947	JB1181	SSP1917	JB1722	SSP1837
JB11054	SSP1913	JB1182	SSP1916	JB1723	SSP1919
JB11055	SSP1914	JB1197	SSP1944	JB1725	SSP1948
JB11064	SSP1776	JB1243	SSP1986	JB1728	SSP1850
JB11066	SSP1857	JB1243	SSP1999	JB1728	SSP1851
JB11070	SSP1876	JB1244	SSP1985	JB1730	SSP1846
JB11072	SSP1974	JB1244	SSP1998	JB1730	SSP1849
JB11074	SSP1909	JB1282	SSP1814	JB1738	SSP1819
JB11075	SSP1858	JB1308	SSP1874	JB1739	SSP1924
JB11079	SSP1973	JB1335	SSP1853	JB1740	SSP1834
JB11083	SSP1955	JB1336	SSP1833	JB1740	SSP1836
JB11092	ARM559	JB1339	SSP1900	JB1742	SSP1922
JB11095	ARM865	JB1353	SSP1972	JB1743	SSP1923
JB11095	ARM866	JB1360	SSP1901	JB1746	SSP1911

TRW	MAGNETI MARELLI	TRW	MAGNETI MARELLI	TRW	MAGNETI MARELLI
JB747	SSP1910	JB788	SSP1885	JBU495	ARM849
JB748	SSP1936	JB789	SSP1780	JBU621	ARM181
JB749	SSP1982	JB791	SSP1939	JBU629	ARM213
JB750	SSP1983	JB791	SSP1940	JBU630	ARM928
JB751	ARM1047	JB794	SSP1979	JBU630	ARM929
JB751	SSP1977	JB794	SSP1981	JBU635	ARM536
JB752	ARM1046	JB795	SSP1978	JBU660	ARM540
JB752	SSP1976	JB795	SSP1980	JBU764	ARM836
JB7524	SSP1968	JB796	SSP1782	JBU775	ARM914
JB7538	SSP1970	JB797	SSP1781	JBU775	ARM915
JB754	SSP1989	JB802	SSP1890	JBU796	ARM475
JB7544	SSP1801	JB803	SSP1889	JBU796	ARM476
JB7546	SSP1869	JB804	ARM703	JCY110	SSP0002
JB7547	SSP1908	JB804	ARM704	JGM6156SL	ARM946
JB7548	SSP1907	JB804	SSP1886	JRA330	SSP0020
JB7552	SSP1870	JB808	ARM880	JRA364	SSP0272
JB7553	SSP1860	JB808	ARM881	JRA504	SSP0248
JB7554	SSP1866	JB810	SSP1956	JRA538	SSP0646
JB756	SSP1882	JB813	ARM967	JRA555	SSP0633
JB7561	SSP1798	JB814	ARM966	JRA556	SSP0634
JB759	SSP1879	JB815	SSP1963	JRA570	SSP0652
JB760	SSP1946	JB816	SSP1964	JRA571	SSP0651
JB7631	SSP1855	JB817	SSP1950	JRA575	SSP0644
JB764	SSP1887	JB818	SSP1958	JRA576	SSP0643
JB7640	SSP1832	JB819	ARM952	JRA591	SSP0017
JB765	SSP1888	JB819	ARM953	JRA592	SSP0022
JB766	ARM499	JB819	SSP1953	JRK0053	ARM535
JB767	ARM497	JB822	SSP1895	JRM505	SSP0205
JB767	ARM498	JB826	SSP1935	JTC00064	ARM354
JB768	SSP1787	JB826	SSP1996	JTC00065	ARM355
JB769	SSP1892	JB827	SSP1788	JTC00361	ARM612
JB770	SSP1883	JB833	SSP1861	JTC01612	ARM585
JB778	SSP1949	JB864	SSP1896	JTC01876	ARM1012
JB779	ARM596	JB894	SSP1865	JTC01877	ARM1008
JB779	ARM597	JBU1262	ARM258	JTC01878	ARM1013
JB779	SSP1852	JBU1262	ARM259	JTC01879	ARM1009
JB781	SSP1930	JBU134	ARM968	JTC02768	ARM621
JB782	SSP1931	JBU134	ARM969	JTC02769	ARM622
JB783	SSP1893	JBU1362	ARM205	JTC04681	ARM606
JB783	SSP1894	JBU1362	ARM206	JTC04682	ARM605
JB786	SSP1878	JBU182	ARM629	JTC05683	ARM1042



TRW	MAGNETI MARELLI	TRW	MAGNETI MARELLI	TRW	MAGNETI MARELLI
JTC05972	ARM1043	JTC1055	ARM925	JTC1139	ARM207
JTC06573	ARM611	JTC1058	ARM1035	JTC1142	ARM242
JTC06596	ARM852	JTC1059	ARM1033	JTC1143	ARM298
JTC06597	ARM851	JTC1060	ARM1036	JTC1144	ARM297
JTC06822	ARM353	JTC1066	ARM292	JTC1146	ARM218
JTC07118	ARM645	JTC1067	ARM286	JTC1151	ARM317
JTC07119	ARM644	JTC1068	ARM287	JTC1152	ARM318
JTC07320	ARM600	JTC1069	ARM282	JTC1153	ARM315
JTC07321	ARM599	JTC1069	ARM283	JTC1154	ARM316
JTC07637	ARM610	JTC1070	ARM280	JTC1157	ARM748
JTC07639	ARM609	JTC1070	ARM281	JTC1158	ARM747
JTC1002	ARM1079	JTC1071	ARM314	JTC1161	ARM738
JTC1003	ARM1078	JTC1072	ARM321	JTC1162	ARM739
JTC1004	ARM306	JTC1073	ARM296	JTC1163	ARM940
JTC1005	ARM307	JTC1074	ARM295	JTC1164	ARM941
JTC1007	ARM839	JTC1090	ARM212	JTC117	ARM162
JTC1008	ARM840	JTC1091	ARM211	JTC1177	ARM910
JTC1010	ARM288	JTC1092	ARM943	JTC1178	ARM911
JTC1011	ARM289	JTC1093	ARM942	JTC1179	ARM197
JTC1012	ARM491	JTC1100	ARM750	JTC118	ARM161
JTC1013	ARM492	JTC1101	ARM749	JTC1180	ARM196
JTC1014	ARM493	JTC1102	ARM741	JTC1181	ARM199
JTC1015	ARM494	JTC1103	ARM742	JTC1182	ARM198
JTC1016	ARM954	JTC1103	SSP2102	JTC119	ARM175
JTC1017	ARM955	JTC1104	ARM744	JTC1202	ARM414
JTC1018	ARM308	JTC1105	ARM743	JTC1207	ARM336
JTC1019	ARM309	JTC1110	ARM1018	JTC1208	ARM335
JTC1022	ARM322	JTC1117	ARM746	JTC1209	ARM253
JTC1026	ARM305	JTC1118	ARM745	JTC1210	ARM255
JTC1027	ARM304	JTC1119	ARM684	JTC1211	ARM254
JTC1028	ARM252	JTC1120	ARM685	JTC1214	ARM767
JTC1029	ARM251	JTC1121	ARM290	JTC1215	ARM766
JTC1030	ARM250	JTC1122	ARM291	JTC1222	ARM948
JTC1031	ARM249	JTC1122	ARM294	JTC1222	ARM950
JTC1036	ARM245	JTC1126	ARM324	JTC1223	ARM949
JTC1039	ARM244	JTC1127	ARM323	JTC1223	ARM951
JTC1040	ARM243	JTC1128	ARM326	JTC1225	ARM1019
JTC1041	ARM166	JTC1129	ARM325	JTC1226	ARM900
JTC1042	ARM164	JTC1136	ARM210	JTC1227	ARM901
JTC1043	ARM163	JTC1137	ARM209	JTC1234	ARM913
JTC1054	ARM924	JTC1138	ARM208	JTC1235	ARM912

TRW	MAGNETI MARELLI	TRW	MAGNETI MARELLI	TRW	MAGNETI MARELLI
JTC1238	ARM920	JTC1332	ARM580	JTC1457	ARM752
JTC1239	ARM921	JTC1333	ARM575	JTC1459	ARM759
JTC1240	ARM447	JTC1334	ARM574	JTC1460	ARM758
JTC1241	ARM446	JTC1350	ARM776	JTC1461	ARM757
JTC1242	ARM519	JTC1351	ARM772	JTC1462	ARM756
JTC1243	ARM520	JTC1352	ARM778	JTC1463	ARM755
JTC1245	ARM541	JTC1353	ARM779	JTC1464	ARM173
JTC1248	ARM1050	JTC1356	ARM773	JTC1465	ARM171
JTC1249	ARM1051	JTC1357	ARM770	JTC1466	ARM846
JTC1250	ARM1049	JTC1357	ARM782	JTC1467	ARM845
JTC1250	ARM990	JTC1358	ARM771	JTC1476	ARM367
JTC1251	ARM1048	JTC1359	ARM760	JTC1476	ARM890
JTC1251	ARM989	JTC1360	ARM761	JTC1477	ARM368
JTC126	ARM300	JTC1365	ARM284	JTC1477	ARM891
JTC1260	ARM843	JTC1366	ARM285	JTC1478	ARM543
JTC1261	ARM844	JTC1367	ARM723	JTC1479	ARM544
JTC1268	ARM877	JTC1368	ARM724	JTC1487	ARM371
JTC1269	ARM875	JTC1384	ARM725	JTC1488	ARM372
JTC127	ARM299	JTC1385	ARM726	JTC1493	ARM369
JTC1270	ARM876	JTC1390	ARM577	JTC1535	ARM505
JTC1271	ARM888	JTC1391	ARM576	JTC1537	ARM533
JTC1272	ARM887	JTC1392	ARM320	JTC1549	ARM619
JTC1275	ARM445	JTC1393	ARM319	JTC1551	ARM620
JTC1276	ARM444	JTC1394	ARM607	JTC1552	ARM534
JTC128	ARM303	JTC1395	ARM608	JTC1623	ARM261
JTC1286	ARM230	JTC1399	ARM982	JTC1624	ARM260
JTC1287	ARM229	JTC1400	ARM983	JTC1658	ARM204
JTC1289	ARM231	JTC1401	ARM189	JTC166	ARM527
JTC129	ARM302	JTC1402	ARM677	JTC1666	ARM346
JTC1290	ARM561	JTC1403	ARM676	JTC1667	ARM347
JTC1297	ARM165	JTC1408	ARM636	JTC168	ARM528
JTC130	ARM271	JTC1409	ARM637	JTC1699	ARM168
JTC131	ARM270	JTC1435	ARM957	JTC1700	ARM167
JTC1313	ARM217	JTC1436	ARM956	JTC1712	ARM633
JTC1314	ARM216	JTC1451	ARM709	JTC1713	ARM634
JTC1318	ARM830	JTC1452	ARM710	JTC1714	ARM557
JTC1319	ARM829	JTC1453	ARM333	JTC182	ARM525
JTC1320	ARM635	JTC1454	ARM334	JTC184	ARM526
JTC1329	ARM698	JTC1455	ARM331	JTC1877	ARM266
JTC1330	ARM697	JTC1456	ARM332	JTC1878	ARM267
JTC1331	ARM581	JTC1457	ARM751	JTC1879	ARM730



TRW	MAGNETI MARELLI	TRW	MAGNETI MARELLI	TRW	MAGNETI MARELLI
JTC1880	ARM731	JTC2228	ARM822	JTC2552	ARM422
JTC1885	ARM919	JTC2231	ARM537	JTC261	ARM410
JTC1889	ARM729	JTC2232	ARM997	JTC270	ARM417
JTC1890	ARM680	JTC2233	ARM998	JTC271	ARM899
JTC1899	ARM477	JTC2234	ARM590	JTC272	ARM898
JTC190	ARM416	JTC2235	ARM589	JTC278	ARM486
JTC1912	ARM1031	JTC2246	ARM995	JTC279	ARM485
JTC193	ARM885	JTC2247	ARM996	JTC310	ARM905
JTC194	ARM886	JTC2248	ARM1083	JTC310	ARM909
JTC1945	ARM478	JTC225	ARM847	JTC312	ARM904
JTC1948	ARM1032	JTC2252	ARM889	JTC312	ARM907
JTC2092	ARM987	JTC226	ARM848	JTC328	ARM975
JTC2093	ARM1076	JTC2266	ARM825	JTC329	ARM974
JTC2093	ARM986	JTC2269	ARM826	JTC342	ARM182
JTC2096	ARM512	JTC2274	ARM449	JTC342	ARM183
JTC2097	ARM511	JTC2275	ARM448	JTC343	ARM180
JTC2105	ARM192	JTC2276	ARM947	JTC345	ARM172
JTC2105	ARM233	JTC2278	ARM864	JTC347	ARM170
JTC2106	ARM193	JTC2279	ARM863	JTC348	ARM179
JTC2106	ARM234	JTC2280	ARM917	JTC350	ARM178
JTC2125	ARM531	JTC2281	ARM916	JTC374	ARM472
JTC2126	ARM530	JTC2284	ARM545	JTC379	ARM490
JTC2141	ARM630	JTC2285	ARM550	JTC380	ARM489
JTC216	ARM675	JTC2286	ARM549	JTC404	ARM963
JTC2167	ARM945	JTC2287	ARM754	JTC405	ARM962
JTC217	ARM674	JTC2288	ARM753	JTC414	ARM425
JTC2178	ARM737	JTC2289	ARM591	JTC415	ARM857
JTC2183	ARM978	JTC2291	ARM603	JTC416	ARM858
JTC2184	ARM979	JTC2295	ARM473	JTC421	ARM176
JTC2196	ARM659	JTC2296	ARM474	JTC421	ARM177
JTC2197	ARM658	JTC2300	ARM1082	JTC565	ARM835
JTC2200	ARM661	JTC2312	ARM194	JTC579	ARM817
JTC2201	ARM660	JTC2313	ARM195	JTC596	ARM837
JTC2210	ARM944	JTC2314	ARM240	JTC600	ARM838
JTC2212	ARM992	JTC2315	ARM241	JTC7545	ARM1081
JTC2213	ARM991	JTC2428	ARM400	JTC7546	ARM1080
JTC2219	ARM959	JTC2429	ARM401	JTC7562	ARM793
JTC2220	ARM701	JTC2465	ARM733	JTC7563	ARM794
JTC2221	ARM702	JTC2466	ARM734	JTC7564	ARM806
JTC2222	ARM958	JTC2516	ARM1022	JTC7565	ARM503
JTC2227	ARM821	JTC2551	ARM423	JTC7565	ARM804

TRW	MAGNETI MARELLI	TRW	MAGNETI MARELLI	TRW	MAGNETI MARELLI
JTC7566	ARM504	JTC964	ARM273	JTE1000	SSP0712
JTC7566	ARM805	JTC965	ARM272	JTE1001	SSP0711
JTC7567	ARM509	JTC966	ARM588	JTE1002	SSP0710
JTC7568	ARM510	JTC967	ARM587	JTE1003	SSP0709
JTC7573	ARM861	JTC968	ARM679	JTE1004	SSP0531
JTC7574	ARM862	JTC968	ARM708	JTE1005	SSP0530
JTC7599	ARM993	JTC969	ARM678	JTE1006	SSP0321
JTC7600	ARM994	JTC969	ARM707	JTE1007	SSP0412
JTC7605	ARM381	JTC970	ARM705	JTE1008	SSP0411
JTC7606	ARM380	JTC971	ARM706	JTE1011	SSP0650
JTC7611	ARM854	JTC972	ARM874	JTE1012	SSP0649
JTC7612	ARM853	JTC973	ARM873	JTE1013	SSP0523
JTC7739	ARM828	JTC974	ARM927	JTE1014	SSP0524
JTC7780	ARM385	JTC975	ARM926	JTE1023	SSP0292
JTC7780	ARM895	JTC982	ARM654	JTE1027	SSP0529
JTC7781	ARM384	JTC983	ARM655	JTE1028	SSP0603
JTC7781	ARM894	JTC990	ARM1016	JTE1029	SSP0602
JTC898	ARM538	JTC991	ARM1017	JTE1035	SSP0435
JTC899	ARM539	JTC994	ARM653	JTE1039	SSP0488
JTC922	ARM671	JTC995	ARM652	JTE1040	SSP0487
JTC923	ARM666	JTC996	ARM184	JTE1041	SSP0596
JTC924	ARM268	JTC998	ARM740	JTE1044	SSP0434
JTC925	ARM269	JTE00026	SSP0462	JTE1050	SSP0305
JTC937	ARM186	JTE00027	SSP0463	JTE1051	SSP0304
JTC940	ARM984	JTE00257	SSP0556	JTE1052	SSP0701
JTC940	ARM985	JTE00258	SSP0557	JTE1053	SSP0700
JTC942	ARM1071	JTE00738	SSP0326	JTE1060	SSP0640
JTC943	ARM1070	JTE00739	SSP0325	JTE1061	SSP0639
JTC944	ARM1075	JTE01161	SSP0456	JTE1062	SSP0516
JTC949	ARM908	JTE01181	SSP0340	JTE1063	SSP0316
JTC950	ARM906	JTE01183	SSP0399	JTE1064	SSP0323
JTC955	ARM421	JTE01195	SSP0309	JTE1065	SSP0630
JTC956	ARM420	JTE01196	SSP0308	JTE1066	SSP0629
JTC958	ARM424	JTE01209	SSP0502	JTE1067	SSP0597
JTC959	ARM415	JTE01210	SSP0501	JTE1071	SSP0714
JTC961	ARM277	JTE01216	SSP0703	JTE1072	SSP0713
JTC961	ARM278	JTE01217	SSP0702	JTE1075	SSP0705
JTC961	ARM279	JTE01220	SSP0324	JTE1076	SSP0704
JTC962	ARM274	JTE01285	SSP0547	JTE1077	SSP0322
JTC962	ARM276	JTE01294	SSP0624	JTE1078	SSP0512
JTC963	ARM301	JTE01295	SSP0623	JTE1079	SSP0511



TRW	MAGNETI MARELLI	TRW	MAGNETI MARELLI	TRW	MAGNETI MARELLI
JTE1084	SSP0510	JTE1180	SSP0535	JTE2057	SSP0626
JTE1085	SSP0509	JTE1183	SSP0354	JTE2078	SSP0685
JTE1090	SSP0697	JTE1187	SSP0618	JTE2079	SSP0686
JTE1091	SSP0696	JTE1188	SSP0617	JTE2079	SSP0688
JTE1092	SSP0562	JTE1191	SSP0526	JTE2084	SSP0674
JTE1095	SSP0299	JTE1192	SSP0525	JTE2085	SSP0675
JTE1096	SSP0563	JTE1194	SSP0389	JTE211	SSP0594
JTE1099	SSP0561	JTE1195	SSP0388	JTE213	SSP0600
JTE1100	SSP0560	JTE1196	SSP0498	JTE2134	SSP0378
JTE1106	SSP0421	JTE1197	SSP0497	JTE2137	SSP0379
JTE1107	SSP0422	JTE1198	SSP0614	JTE2144	SSP0681
JTE1111	SSP0571	JTE1199	SSP0613	JTE2147	SSP0473
JTE1112	SSP0572	JTE1205	SSP0284	JTE2148	SSP0474
JTE1126	SSP0410	JTE1206	SSP0283	JTE2149	SSP0452
JTE1127	SSP0409	JTE1208	SSP0371	JTE2150	SSP0453
JTE113	SSP0407	JTE1209	SSP0370	JTE2156	SSP0450
JTE1131	SSP0429	JTE1210	SSP0587	JTE2157	SSP0451
JTE1132	SSP0428	JTE1211	SSP0586	JTE2162	SSP0661
JTE1135	SSP0386	JTE1213	SSP0423	JTE2163	SSP0662
JTE1136	SSP0387	JTE1214	SSP0424	JTE229	SSP0443
JTE1144	SSP0289	JTE1220	SSP0374	JTE244	SSP0480
JTE1145	SSP0288	JTE1221	SSP0375	JTE246	SSP0496
JTE1152	SSP0620	JTE1223	SSP0604	JTE247	SSP0495
JTE1153	SSP0619	JTE1224	SSP0527	JTE248	SSP0482
JTE1153	SSP0621	JTE1225	SSP0528	JTE249	SSP0481
JTE1154	SSP0658	JTE1391	SSP0417	JTE260	SSP0442
JTE1155	SSP0657	JTE143	SSP0287	JTE260	SSP0552
JTE1158	SSP0468	JTE144	SSP0282	JTE260	SSP0553
JTE1159	SSP0469	JTE145	SSP0318	JTE260	SSP0559
JTE1160	SSP0439	JTE146	SSP0317	JTE260	SSP0708
JTE1160	SSP0716	JTE147	SSP0313	JTE263	SSP0570
JTE1161	SSP0438	JTE148	SSP0312	JTE266	SSP0581
JTE1161	SSP0715	JTE161	SSP0612	JTE268	SSP0585
JTE1163	SSP0306	JTE162	SSP0369	JTE282	SSP0645
JTE1164	SSP0307	JTE163	SSP0368	JTE283	SSP0656
JTE1168	SSP0486	JTE168	SSP0505	JTE284	SSP0655
JTE1169	SSP0485	JTE169	SSP0515	JTE319	SSP0676
JTE117	SSP0408	JTE191	SSP0413	JTE340	SSP0541
JTE1170	SSP0484	JTE194	SSP0419	JTE349	SSP0286
JTE1171	SSP0483	JTE195	SSP0420	JTE350	SSP0285
JTE1179	SSP0536	JTE2056	SSP0625	JTE365	SSP0707

TRW	MAGNETI MARELLI	TRW	MAGNETI MARELLI	TRW	MAGNETI MARELLI
JTE366	SSP0706	JTE7586	SSP0544	JTS00333	SSP2458
JTE407	SSP0493	JTE7590	SSP0343	JTS00334	SSP2457
JTE408	SSP0494	JTE7591	SSP0342	JTS00342	SSP2539
JTE409	SSP0545	JTE7592	SSP0472	JTS00374	SSP2403
JTE412	SSP0546	JTE7598	SSP0667	JTS01027	SSP2468
JTE413	SSP0591	JTE7599	SSP0668	JTS01029	SSP2467
JTE414	SSP0590	JTE7600	SSP0449	JTS01211	SSP2085
JTE420	SSP0558	JTE7601	SSP0448	JTS01217	SSP2041
JTE431	SSP0441	JTE7606	SSP0461	JTS01218	SSP2040
JTE434	SSP0440	JTE7612	SSP0579	JTS01869	SSP2039
JTE438	SSP0636	JTE7614	SSP0336	JTS01873	SSP2248
JTE439	SSP0635	JTE7615	SSP0335	JTS01914	SSP2038
JTE442	SSP0589	JTE762	SSP0373	JTS1012	SSP2499
JTE443	SSP0588	JTE763	SSP0372	JTS1016	SSP2422
JTE508	SSP0291	JTE7630	SSP0679	JTS104	SSP2031
JTE509	SSP0290	JTE7631	SSP0680	JTS105	SSP2001
JTE515	SSP0551	JTE7636	SSP0582	JTS1052	SSP2472
JTE517	SSP0550	JTE764	SSP0377	JTS1053	SSP2473
JTE546	SSP0349	JTE765	SSP0376	JTS106	SSP2000
JTE572	SSP0584	JTE766	SSP0315	JTS109	SSP2066
JTE579	SSP0542	JTE767	SSP0314	JTS1096	SSP2235
JTE587	SSP0638	JTE768	SSP0437	JTS1096	SSP2285
JTE683	SSP0666	JTE769	SSP0518	JTS1097	SSP2447
JTE686	SSP0637	JTE770	SSP0517	JTS1098	SSP2448
JTE695	SSP0665	JTE771	SSP0601	JTS111	SSP2043
JTE700	SSP0647	JTE7755	SSP0445	JTS111	SSP2044
JTE701	SSP0648	JTE7767	SSP0360	JTS112	SSP2045
JTE721	SSP0595	JTE7788	SSP0695	JTS112	SSP2046
JTE730	SSP0549	JTE779	SSP0699	JTS113	SSP2047
JTE7534	SSP0678	JTE7791	SSP0577	JTS113	SSP2048
JTE7535	SSP0677	JTE7792	SSP0576	JTS113	SSP2049
JTE7552	SSP0683	JTE780	SSP0698	JTS1135	SSP2075
JTE7553	SSP0684	JTE808	SSP0578	JTS1136	SSP2076
JTE7566	SSP0555	JTE925	SSP0328	JTS114	SSP2477
JTE7567	SSP0554	JTE925	SSP0329	JTS114	SSP2478
JTE7569	SSP0673	JTE986	SSP0642	JTS1142	SSP2182
JTE7570	SSP0672	JTE994	SSP0641	JTS1143	SSP2181
JTE7579	SSP0671	JTF199	SSP0664	JTS1144	SSP2561
JTE7583	SSP0537	JTF201	SSP0663	JTS1145	SSP2171
JTE7584	SSP0538	JTS00304	SSP2083	JTS1146	SSP2402
JTE7585	SSP0543	JTS00318	SSP2174	JTS1148	SSP2474



TRW	MAGNETI MARELLI	TRW	MAGNETI MARELLI	TRW	MAGNETI MARELLI
JTS1153	SSP2465	JTS199	SSP2444	JTS394	SSP2003
JTS1154	SSP2464	JTS202	SSP2446	JTS395	SSP2004
JTS116	ARM667	JTS211	SSP2445	JTS396	SSP2575
JTS116	ARM668	JTS219	SSP2398	JTS397	SSP2584
JTS116	ARM669	JTS227	SSP2416	JTS397	SSP2585
JTS116	ARM670	JTS228	SSP2415	JTS397	SSP2587
JTS117	SSP2053	JTS236	SSP2460	JTS398	SSP2018
JTS1175	SSP2077	JTS239	SSP2413	JTS401	SSP2168
JTS1176	SSP2078	JTS280	SSP2009	JTS404	SSP2050
JTS118	SSP2449	JTS283	SSP2144	JTS405	SSP2178
JTS1183	SSP2538	JTS283	SSP2145	JTS405	SSP2188
JTS1186	SSP2086	JTS283	SSP2495	JTS406	SSP2222
JTS1187	SSP2087	JTS283	SSP2496	JTS406	SSP2223
JTS1191	SSP2154	JTS284	ARM185	JTS406	SSP2224
JTS1195	SSP2242	JTS287	SSP2303	JTS407	SSP2353
JTS1199	SSP2244	JTS289	SSP2508	JTS408	SSP2509
JTS120	SSP2054	JTS290	SSP2507	JTS409	SSP2531
JTS1216	SSP2316	JTS309	SSP2304	JTS410	SSP2530
JTS1217	SSP2317	JTS350	SSP2589	JTS413	SSP2433
JTS122	SSP2010	JTS352	SSP2165	JTS414	SSP2432
JTS123	SSP2579	JTS353	SSP2067	JTS415	SSP2434
JTS125	SSP2137	JTS361	SSP2005	JTS415	SSP2437
JTS1285	SSP2200	JTS361	SSP2008	JTS416	SSP2594
JTS129	SSP2141	JTS362	SSP2007	JTS416	SSP2595
JTS1293	SSP2180	JTS363	ARM672	JTS419	SSP2062
JTS130	SSP2189	JTS364	SSP2582	JTS420	SSP2061
JTS130	SSP2217	JTS364	SSP2583	JTS421	SSP2014
JTS1352	SSP2136	JTS370	SSP2481	JTS422	SSP2015
JTS136	SSP2506	JTS381	SSP2305	JTS424	SSP2349
JTS137	SSP2139	JTS381	SSP2306	JTS425	SSP2370
JTS137	SSP2140	JTS387	SSP2571	JTS426	SSP2042
JTS1388	SSP2133	JTS387	SSP2572	JTS428	SSP2176
JTS1395	SSP2097	JTS388	SSP2016	JTS432	SSP2522
JTS144	SSP2525	JTS388	SSP2017	JTS432	SSP2523
JTS148	SSP2554	JTS393	SSP2028	JTS433	SSP2450
JTS1515	SSP2129	JTS393	SSP2051	JTS433	SSP2451
JTS157	SSP2466	JTS393	SSP2052	JTS435	SSP2580
JTS182	SSP2550	JTS393	SSP2534	JTS435	SSP2581
JTS186	SSP2540	JTS393	SSP2535	JTS437	SSP2069
JTS193	SSP2390	JTS393	SSP2586	JTS438	SSP2593
JTS193	SSP2391	JTS394	SSP2002	JTS439	SSP2290

TRW	MAGNETI MARELLI	TRW	MAGNETI MARELLI	TRW	MAGNETI MARELLI
JTS440	SSP2289	JTS499	SSP2341	JTS577	SSP2271
JTS446	SSP2329	JTS500	SSP2221	JTS578	SSP2126
JTS446	SSP2330	JTS502	SSP2348	JTS579	SSP2125
JTS447	SSP2328	JTS503	SSP2347	JTS581	SSP2186
JTS448	SSP2327	JTS506	SSP2023	JTS581	SSP2187
JTS449	SSP2331	JTS508	SSP2072	JTS582	SSP2212
JTS450	SSP2332	JTS509	SSP2071	JTS583	SSP2211
JTS451	SSP2070	JTS510	SSP2035	JTS584	SSP2215
JTS452	SSP2142	JTS511	SSP2064	JTS602	SSP2123
JTS454	SSP2369	JTS512	SSP2074	JTS602	SSP2124
JTS455	SSP2513	JTS513	SSP2058	JTS603	SSP2510
JTS456	SSP2514	JTS514	SSP2578	JTS605	SSP2366
JTS457	SSP2219	JTS515	SSP2213	JTS606	SSP2020
JTS457	SSP2220	JTS515	SSP2214	JTS607	SSP2019
JTS458	SSP2006	JTS521	SSP2568	JTS611	SSP2368
JTS459	SSP2162	JTS522	SSP2567	JTS612	SSP2367
JTS461	SSP2336	JTS523	SSP2013	JTS613	SSP2034
JTS462	SSP2484	JTS524	SSP2012	JTS614	SSP2033
JTS463	SSP2519	JTS530	SSP2521	JTS617	SSP2365
JTS464	SSP2068	JTS531	SSP2414	JTS618	SSP2307
JTS466	SSP2528	JTS536	SSP2193	JTS618	SSP2308
JTS467	SSP2503	JTS536	SSP2225	JTS619	SSP2364
JTS468	SSP2504	JTS543	SSP2566	JTS620	SSP2309
JTS469	SSP2505	JTS544	SSP2376	JTS621	SSP2371
JTS477	SSP2030	JTS545	SSP2375	JTS622	SSP2372
JTS479	SSP2063	JTS546	SSP2483	JTS625	SSP2436
JTS480	SSP2057	JTS547	SSP2166	JTS627	SSP2373
JTS481	SSP2056	JTS550	SSP2520	JTS628	SSP2374
JTS482	SSP2138	JTS552	SSP2029	JTS636	SSP2352
JTS483	SSP2537	JTS554	SSP2173	JTS637	SSP2351
JTS483	SSP2576	JTS556	SSP2497	JTS642	SSP2500
JTS484	SSP2577	JTS557	SSP2498	JTS642	SSP2501
JTS485	SSP2588	JTS560	SSP2255	JTS644	SSP2490
JTS486	SSP2073	JTS561	SSP2257	JTS645	SSP2489
JTS487	SSP2337	JTS562	SSP2259	JTS646	SSP2060
JTS488	SSP2338	JTS566	SSP2167	JTS647	SSP2059
JTS490	SSP2190	JTS567	SSP2273	JTS650	SSP2135
JTS496	SSP2431	JTS568	SSP2272	JTS664	SSP2111
JTS496	SSP2590	JTS574	SSP2278	JTS673	SSP2147
JTS497	SSP2340	JTS575	SSP2279	JTS686	SSP2105
JTS498	SSP2339	JTS576	SSP2270	JTS690	SSP2104



TRW	MAGNETI MARELLI	TRW	MAGNETI MARELLI	TRW	MAGNETI MARELLI
JTS715	SSP2203	JTS7634	SSP2453	JTS987	SSP2080
JTS717	SSP2265	JTS7638	SSP2419	JTY130	SSP0001
JTS738	SSP2134	JTS7662	SSP2411	TRW10720	ARM501
JTS738	SSP2268	JTS7663	SSP2412		
JTS742	SSP2148	JTS7686	SSP2420		
JTS7518	SSP2228	JTS7687	SSP2421		
JTS7519	SSP2229	JTS7689	SSP2461		
JTS7523	SSP2282	JTS7690	SSP2462		
JTS7524	SSP2283	JTS7698	SSP2542		
JTS7536	SSP2555	JTS770	SSP2480		
JTS7537	SSP2541	JTS7710	SSP2549		
JTS7537	SSP2556	JTS7715	SSP2239		
JTS7552	SSP2552	JTS7716	SSP2238		
JTS7553	SSP2553	JTS773	SSP2479		
JTS7554	SSP2551	JTS7734	SSP2231		
JTS7564	SSP2544	JTS7735	SSP2232		
JTS7564	SSP2547	JTS7743	SSP2487		
JTS7565	SSP2543	JTS7745	SSP2471		
JTS7565	SSP2546	JTS7746	SSP2470		
JTS7571	SSP2392	JTS7753	SSP2393		
JTS7572	SSP2192	JTS7764	SSP2469		
JTS7573	SSP2400	JTS799	SSP2172		
JTS7574	SSP2401	JTS815	SSP2485		
JTS7578	SSP2109	JTS847	SSP2545		
JTS7579	SSP2108	JTS866	SSP2548		
JTS7580	SSP2110	JTS867	SSP2418		
JTS7587	SSP2426	JTS884	SSP2288		
JTS7588	SSP2425	JTS909	SSP2198		
JTS7588	SSP2429	JTS924	SSP2559		
JTS7593	SSP2237	JTS928	SSP2452		
JTS7594	SSP2236	JTS929	SSP2130		
JTS7595	SSP2251	JTS930	SSP2515		
JTS7596	SSP2252	JTS931	SSP2518		
JTS7597	SSP2253	JTS951	SSP2389		
JTS7598	SSP2254	JTS957	SSP2277		
JTS7601	SSP2274	JTS967	SSP2241		
JTS7611	SSP2175	JTS970	SSP2240		
JTS7616	SSP2281	JTS981	SSP2361		
JTS7617	SSP2280	JTS984	SSP2245		
JTS7618	SSP2153	JTS985	SSP2022		
JTS7633	SSP2454	JTS986	SSP2081		



***Dizionario
Dictionary
Wörterbuch
Dictionnaire
Diccionario
Dicionário
Λεξικό
Słownnik
Словарь
Sözlük***



ENGLISH	ITALIAN
STEERING AND SUSPENSION PARTS	STERZO E SOSPENSIONE
Axial joint	Tirante Sterzo
Track control arm	Braccio oscillante
Ball joint	Giunto a sfera
Stabilizer link	Articolazione
Stabilizer link bush	Boccola dell'articolazione
Bush / Silent block	Boccola
Centre tie rod assembly	Complessivo tirante centrale
Tie rod assembly	Complessivo tirante
Tie rod end	Testina tirante
Cross rod	Complessivo tirante centrale
LH	LH
RH	RH
Upper	Superiore
Lower	Inferiore

ENGLISH	POLISH
STEERING AND SUSPENSION PARTS	ELEMENTY UKŁADU KIEROWNICZEGO I ZAWIESZENIA
Axial joint	Drażek kierowniczy
Track control arm	Wahacz zawieszenia
Ball joint	Sworzeń wahacza
Stabilizer link	Łącznik stabilizatora
Stabilizer link bush	Tuleja stabilizatora
Bush / Silent block	Tuleja wahacza / Silentblok
Centre tie rod assembly	Drażek kierowniczy środkowy
Tie rod assembly	Drażek kierowniczy kompletny
Tie rod end	Końcówka drążka kierowniczego
Cross rod	Drażek poprzeczny
LH	Strona lewa
RH	Strona prawa
Upper	Górny
Lower	Dolny



ENGLISH	GERMAN
STEERING AND SUSPENSION PARTS	LENKUNGS- UND AUFHÄNGUNGSTEILE
Axial joint	Axialgelenk
Track control arm	Schwingarm
Ball joint	Kugelgelenk
Stabilizer link	Stabilisator
Stabilizer link bush	Buchse Stabilisator
Bush / Silent block	Buchse / Sielentblock
Centre tie rod assembly	Spurstange
Tie rod assembly	Spurstange / Zugstange
Tie rod end	Spurstangenkopf
Cross rod	Querstange
LH	linke Seite
RH	rechte Seite
Upper	oben
Lower	unten

ENGLISH	FRENCH
STEERING AND SUSPENSION PARTS	PIECES DE DIRECTION ET DE SUSPENSION
Axial joint	Rotule de direction
Track control arm	Bras de suspension
Ball joint	Rotule
Stabilizer link	Barre stabilisatrice
Stabilizer link bush	Douille de barre stabilisatrice
Bush / Silent block	Douille / Silentbloc
Centre tie rod assembly	Biellette de direction centrale
Tie rod assembly	Biellette de direction
Tie rod end	Rotule de direction
Cross rod	Barre de direction
LH	Conduite à gauche
RH	Conduite à droite
Upper	Supérieur
Lower	Inférieur



ENGLISH	SPANISH
STEERING AND SUSPENSION PARTS	DIRECCION & SUSPENSION
Axial joint	Rotula de barra axial
Track control arm	Brazo de Sospension
Ball joint	Rotula
Stabilizer link	Barra estabilizadora
Stabilizer link bush	Fuelle guardapolvo de barra estabilizadora
Bush / Silent block	Fuelle guardapolvo
Centre tie rod assembly	Conjunto de barra de acompliamiento central
Tie rod assembly	Conjunto de barra de acompliamiento
Tie rod end	Rotula de direccion
Cross rod	Conjunto de barra de acompliamiento central
LH	LH
RH	RH
Upper	Superior
Lower	Inferior

ENGLISH	PORTUGUESE
STEERING AND SUSPENSION PARTS	DIRECCAO & SUSPENSAO
Axial joint	Barra axial
Track control arm	Braco de suspensao
Ball joint	Rotula
Stabilizer link	Articulacao do estabilizador
Stabilizer link bush	Casquilho do articulacao
Bush / Silent block	Casquilho
Centre tie rod assembly	Conjunto central da barra transversal
Tie rod assembly	Conjunto da barra transversal
Tie rod end	Terminal de direccao
Cross rod	Conjunto central da barra transversal
LH	LH
RH	RH
Upper	Em cima
Lower	Em baixo



ENGLISH	RUSSIAN
STEERING AND SUSPENSION PARTS	ДЕТАЛИ ПОДВЕСКИ И РУЛЕВОГО УПРАВЛЕНИЯ
Axial joint	Осевой шарнир
Track control arm	Рычаг подвески
Ball joint	Шаровый шарнир
Stabilizer link	Шарнир стабилизатора
Stabilizer link bush	Втулка стабилизатора
Bush / Silent block	Втулка/Сайлентблок
Centre tie rod assembly	Центральный наконечник рулевой тяги
Tie rod assembly	Рулевая тяга в сборе
Tie rod end	Наконечник рулевой тяги
Cross rod	Поперечная рулевая тяга
LH	Левая сторона
RH	Правая сторона
Upper	Верхний
Lower	Нижний

ENGLISH	TURKISH
STEERING AND SUSPENSION PARTS	DİREKSİYON VE SÜSPANSİYON PARÇALARI
Axial joint	Rot mili
Track control arm	Salincak
Ball joint	Rotil
Stabilizer link	Z-Rot
Stabilizer link bush	Z-Rot burcu
Bush / Silent block	Burç
Centre tie rod assembly	Orta rot takimi
Tie rod assembly	Rot takimi
Tie rod end	Rotabaşı
Cross rod	Denge kolu
LH	Sol
RH	Sağ
Upper	Üst
Lower	Alt



ENGLISH	GREEK
STEERING AND SUSPENSION PARTS	ΤΙΜΟΝΙ ΚΑΙ ΕΞΑΡΤΗΜΑΤΑ ΑΝΑΡΤΗΣΗΣ
Axial joint	Ημίμπαρο
Track control arm	Κρεμαστό ψαλίδι
Ball joint	Σύνδεσμος με μπίλια
Stabilizer link	Μπράτσο αντιστρεπτικής δοκού
Stabilizer link bush	Σινεμπλόκ μπράτσου αντιστρεπτικής δοκού
Bush / Silent block	Σινεμπλόκ
Centre tie rod assembly	Σύνολο κεντρικού μπράτσου
Tie rod assembly	Σύνολο μπράτσου
Tie rod end	Ακρόμπαρο
Cross rod	Σύνολο κεντρικού μπράτσου
LH	Αριστερό
RH	Δεξιό
Upper	Επάνω
Lower	Κάτω

ITALY

Viale Aldo Borletti, 61/63
20011 Corbetta (Milano)
Tel. +39 02 928 15 111 • Fax +39 02 972 27 234

Export

Viale Aldo Borletti, 61/63
20011 Corbetta (Milano) Italy
Tel +39 02 972 28 881 • Fax +39 02 972 27 755

SPAIN

Poligono Industrial G-2 Collsabadell
Ronda de Collsabadell, 1-3
08450, Llinars del Vallès (Barcelona)
Tel. +34 93 841 35 30

FRANCE

Z.A. Trappes Elancourt
5-7 rue Albert Einstein - 78190 Trappes
tel +33 (0)1 3016 6960 • Fax +33 (0)1 3016 6961

GERMANY

Salzstrasse 185/1
74076 Heilbronn
Tel. +49 7131 2910 • Fax +49 7131 165236

POLAND & RUSSIA

Plac pod Lipami 5
40-476 Katowice
Tel. +48 32 603 61 07 • Fax +48 32 603 61 08

BRAZIL

Av. Manoel da Nóbrega, 196
Conj. 14 - Bairro Capuava - Mauá - São Paulo
CEP 09380.120
Tel. +55 0800 0194 054 (Cofap Products) • +55 0800 191 638 (Magneti Marelli Products)

ARGENTINA

Hipólito Yrigoyen 571, 8 Floor,
B1638AIE, Vicente López - Buenos Aires
Tel. +54 11 4589 0850 • Fax +54 11 4589 0850

CHINA

685 Ju Jin Rd, Shanghai Free Trade Pilot Zone,
P.R.C. 201208
Tel. +86 21 205 06 000 • Fax +86 21 586 96 978

TURKEY

Büyükdere Cad. Tofaş Han No.145
Zincirlikuyu, 34394 Istanbul
Ph: +90 212 217 02 97 • Fax: +90 212 217 02 95



Magneti Marelli After Market Parts and Services S.p.A.
Viale Aldo Borletti, 61/63 - 20011 Corbetta (Milano) Italia
Tel. +39 02 928 15 111 • Fax +39 02 972 27 234
www.magnetimarelli-checkstar.com